



Cat. No. 43-1088A/1090A  
**OWNER'S MANUAL**

Please read before using this equipment.

# 900-MHz Cordless Telephone

**with Headset Jack**

ET-918 White(43-1088A)  
ET-920 Black (43-1090A)



**RadioShack®**

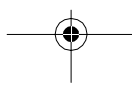



## FEATURES

---

Your RadioShack ET-918/920 900-MHz Cordless Telephone with Headset Jack uses the 900 MHz band which means less interference, clearer sound, and greater range than 46/49 MHz cordless telephones.

And, its headset jack means you can connect an optional headset for hands-free convenience while you use the phone.

The phone's other features include:

**900 MHz Operation** — provides longer range and less interference than many other cordless phones.

**40 Channels** — automatically selects a clear channel when you make or answer a call. You can also manually change channels during a call.

**Super CCT Noise-Reduction Circuitry** — provides clear telephone conversations, giving you sound clarity comparable to that of a corded phone.

**Security Access-Protection Code** — automatically prevents other cordless phone users from using your phone line while the handset is off the base.

**COM-LOK<sup>®</sup>** — ensures that other cordless phone users cannot use your phone line when the handset is on the base.

**Redial** — lets you quickly redial the last number dialed.

**10-Number Memory Dialing** — lets you store up to 10 numbers in memory for easy dialing.

**Page** — lets you send a paging signal from the base to the handset to page someone or locate the handset if you misplace it.

**Flash** — sends an electronic switch-hook signal for use with special phone services, such as Call Waiting.

**Volume Control** — lets you adjust the volume you hear through the handset.

**Programmable Ringer** — lets you select from four ringer tone/volume settings.

**Tone/Pulse Dialing** — lets you use your phone with tone or pulse service.

**Quick Talk** — lets you make or answer a call by just lifting the handset from the base.

**Hearing-Aid Compatibility** — lets you use your phone with hearing aids that have a T (telephone) switch.

This telephone has been tested and found to comply with all applicable UL and FCC standards.

© 1997, 1998 Tandy Corporation.  
All Rights Reserved.

COM-LOK and RadioShack are registered trademarks used by Tandy Corporation.





**Important Note:** Cordless phones such as this one require AC power to operate. When the AC power is off, you cannot dial out or receive incoming calls using your phone. To be safe, you should also have a phone that does not need AC power to operate (not a cordless phone) so you can still make and receive calls if there is an AC power failure.

We recommend you record your phone's serial number here. The number is on the bottom of the base.

Serial Number \_\_\_\_\_

**Warning:** To reduce the risk of fire or shock hazard, do not expose this product to rain or moisture.

	<b>CAUTION</b> RISK OF ELECTRIC SHOCK. DO NOT OPEN.	
<b>CAUTION:</b> TO REDUCE THE RISK OF ELECTRIC SHOCK, DO NOT REMOVE COVER OR BACK. NO USER-SERVICEABLE PARTS INSIDE. REFER SERVICING TO QUALIFIED PERSONNEL.		



This symbol is intended to alert you to the presence of uninsulated dangerous voltage within the product's enclosure that might be of sufficient magnitude to constitute a risk of electric shock. Do not open the product's case.



This symbol is intended to inform you that important operating and maintenance instructions are included in the literature accompanying this product.

## READ THIS BEFORE INSTALLATION

Each device that you connect to the phone line draws power from the phone line. We refer to this power draw as the device's *ringer equivalence number*, or *REN*. The REN is on the bottom of the base.

If you are using more than one phone or other device on the line, add up all the RENs. If the total is more than five, your phones might not ring. In rural areas, a total REN of three might impair ringer operation. If ringer operation is impaired, remove a device from the line.

## FCC STATEMENT

This telephone complies with Part 68 of *FCC Rules*. You must, upon request, provide the FCC Registration Number and the REN to your phone company. These numbers are on the bottom of the base.

**Note:** You must not connect your phone to any of the following:

- coin-operated systems
- party-line systems
- most electronic key phone systems



# CONTENTS

<b>Installation .....</b>	<b>5</b>
Selecting a Location .....	5
Placing the Base on a Desk Top .....	5
Mounting the Base on a Wall Plate .....	6
Mounting the Base Directly on the Wall .....	7
Connecting and Charging the Battery Pack .....	9
Setting the Dialing Mode .....	11
Setting the Ringer Tone/Volume .....	11
<b>Operation .....</b>	<b>12</b>
Making and Receiving Calls .....	12
Selecting the Channel .....	12
Setting the Handset Volume .....	12
Using REDIAL .....	12
Using FLASH .....	13
Using Tone Services on a Pulse Line .....	13
Paging .....	14
Memory Dialing .....	14
Storing a Number in Memory .....	14
Entering a Pause .....	15
Dialing a Memory Number .....	15
Chain-Dialing Service Numbers .....	16
Testing Stored Emergency Numbers .....	16
Using a Headset .....	16
<b>Troubleshooting .....</b>	<b>17</b>
<b>Care and Maintenance .....</b>	<b>19</b>
Replacing the Battery Pack .....	20
The FCC Wants You to Know .....	21
Lightning .....	21

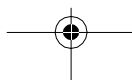

## INSTALLATION

### SELECTING A LOCATION

You can place the phone's base on a desk top or table, or mount it on a wall. Select a location that is:

- near an AC outlet
- near a telephone line jack
- out of the way of normal activities
- away from electrical machinery, electrical appliances, metal walls or filing cabinets, wireless inter-coms, alarms, and room monitors
- away from other cordless phones

The base's location affects the hand-set's range. If you have a choice of several locations, try each to see which provides the best performance.

**Caution:** The supplied RadioShack AC adapter was designed specifically for your ET-918/920. Use only the supplied adapter.

#### Notes:

- Your telephone connects directly to a modular telephone line jack. If your phone line jack is not a modular jack, you can update the wiring yourself, using jacks and adapters available at your local RadioShack store. Or, you can let the phone company update the wiring for you.

- The USOC number of the jack to be installed is RJ11C (RJ11W if you want to mount it on a wall plate).

### Placing the Base on a Desk Top

Follow these steps when you place the base on a desk, shelf, or table.

1. Plug one end of the supplied long modular cord into the **TEL LINE** jack on the back of the base.

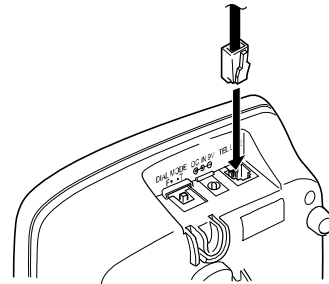

2. Plug the modular cord's other end into a modular phone line jack.

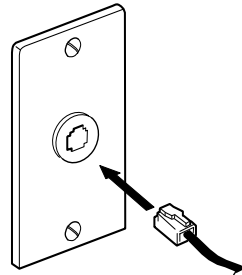

3. Insert the supplied AC adapter's barrel plug into the **DC IN 9V** jack on the back of the base.

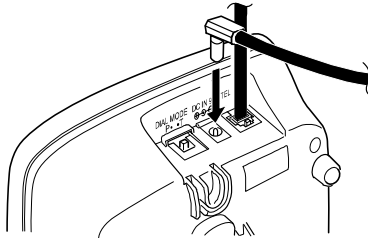

4. Route the adapter's cord through the strain relief slot on the base (as shown).

Strain Relief Slot

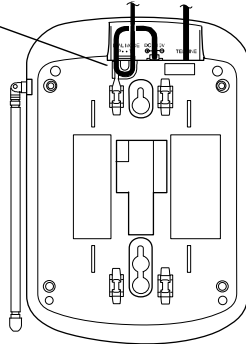

5. Plug the adapter into a standard AC outlet. The **POWER** indicator on the base lights.
6. Lift the base's antenna to a vertical position.

## Mounting the Base on a Wall Plate

1. Plug one end of the supplied short modular cord into the **TEL LINE** jack on the back of the base.

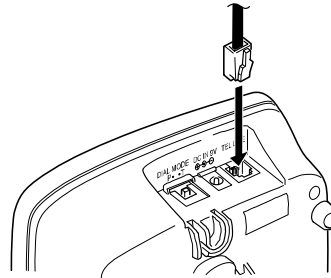

2. Route the modular cord through the right slot on the bottom of the base.

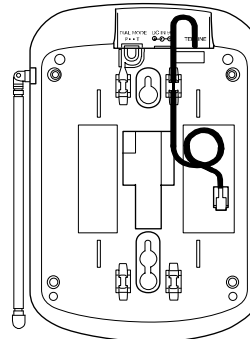

3. Insert the supplied AC adapter's barrel plug into the **DC IN 9V** jack on the back of the base.

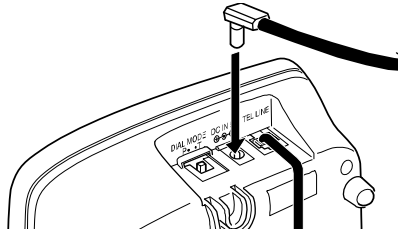

4. Route the adapter's cord through the left side of the strain relief slot on top of the base and through the left slots at the bottom of the base.

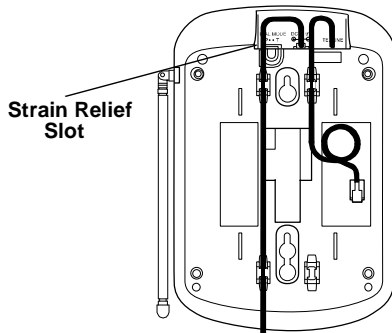

5. Plug the short modular cord into the wall plate jack, press the excess cord into the slot in the center of the base, then align the base's keyhole slots with the wall plate studs and slide the base downward to secure it.

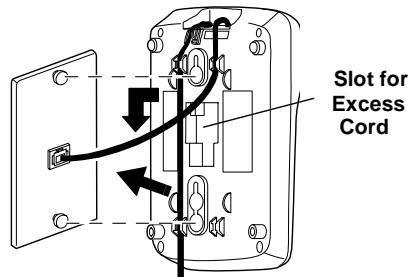

6. Press and lift out the handset holder, turn it over and rotate it 180°, then snap it back into place so it holds the handset.

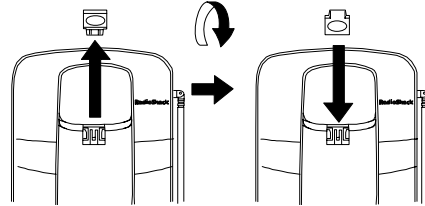

7. Plug the adapter into a standard AC outlet. The **POWER** indicator on the base lights.

8. Lift the base's antenna to a vertical position.

### Mounting the Base Directly on the Wall

For this mounting method, you need two flat-head wood screws (not supplied) with heads that fit into the key-hole slots on the bottom of the base.

1. Drill two holes  $3\frac{15}{16}$  inches apart. Then thread a screw into each hole, letting the heads extend about  $\frac{3}{16}$  inch from the wall.

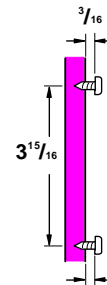

2. Plug one end of the supplied long modular cord into the **TEL LINE** jack on the back of the base.

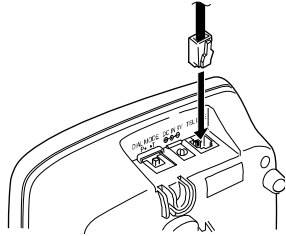

3. Route the modular cord through the right slots on the bottom of the base.

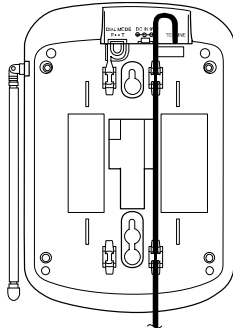

4. Insert the supplied AC adapter's barrel plug into the **DC IN 9V** jack on the back of the base.

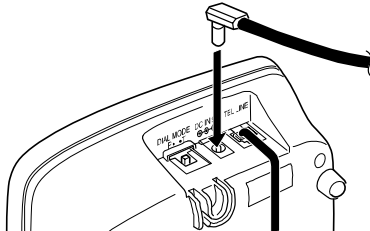

5. Route the adapter's cord through the left side of the strain relief slot on top of the base and through the left slots on the bottom of the base.

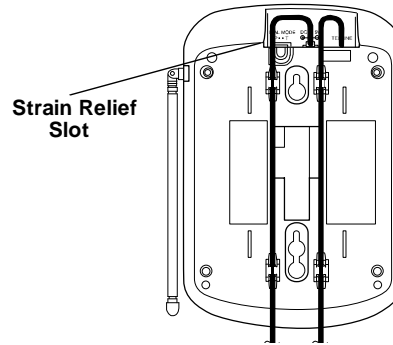

6. Align the keyhole slots with the mounting screws and slide the base downward to secure it.

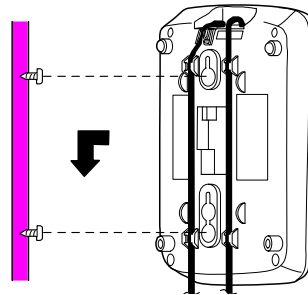

7. Plug the modular cord into a modular phone line jack.

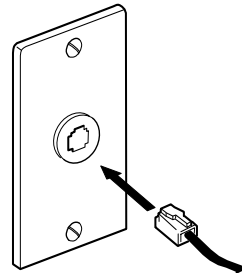



8. Press and lift out the handset holder, rotate it 180°, then snap it back into place so it holds the handset.

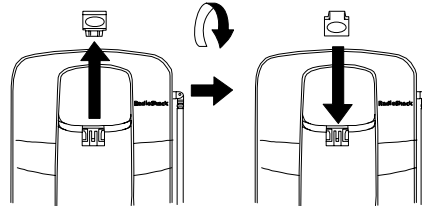

9. Plug the adapter into a standard AC outlet. The POWER indicator on the base lights.
10. Lift the base's antenna to a vertical position.

## CONNECTING AND CHARGING THE BATTERY PACK

The phone comes with a rechargeable nickel-cadmium battery pack in the handset. Before using your phone, you must connect the battery pack and then charge it for about 14 hours.

1. Remove the screw on the battery compartment cover, then press down and slide the cover in the direction of the arrow to remove it.

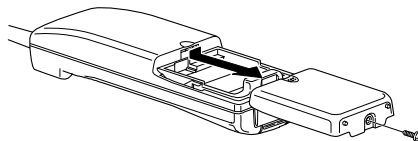

2. Plug the battery pack's plastic connector into the socket in the compartment. The connector fits only one way.

**Note:** For easier battery pack connection, lift it out of the compartment, insert its connector into the socket and replace the battery pack inside the compartment.

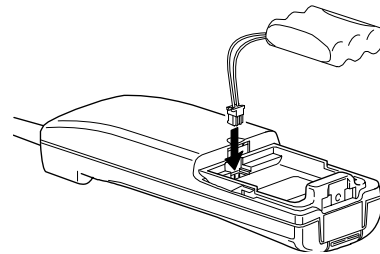

3. Replace the cover, then reinsert and tighten the screw.

To charge the battery pack, simply place the handset on the base. The CHARGE indicator on the base lights.

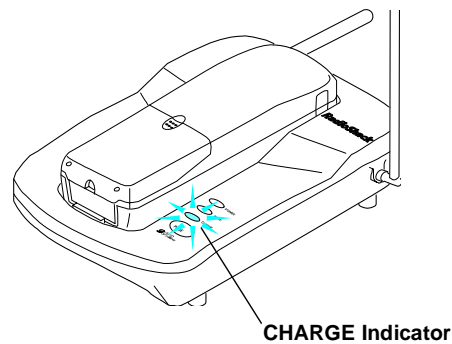

Recharge the battery pack when the handset beeps and the TALK/BATT LOW indicator flashes.

**Notes:**

- If the CHARGE indicator does not light when you place the handset on the base, be sure the battery pack and AC adapter are correctly and securely connected.

Also, check the charging contacts on the handset and the base. If the contacts are dirty or tarnished, clean them with a pencil eraser.

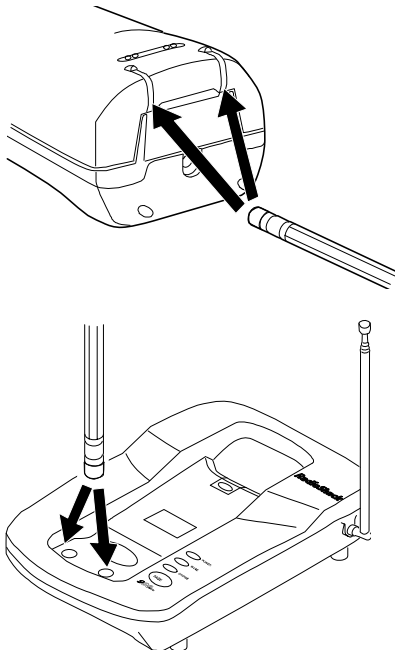

- When you first use the phone after charging or recharging the battery pack, the phone might not work and you might hear an error tone. If this happens, return the handset to the base for a few seconds.
- About once a month, fully discharge the battery pack by keep-

ing the handset off the base until the TALK/BATT LOW indicator flashes. Otherwise, the battery pack loses its ability to fully recharge.

- If the TALK/BATT LOW indicator does not light and the phone does not work, recharge the battery pack. (The battery power might be too low to light the indicator.)
- If the battery pack becomes weak during a call, you hear a beep every 30 seconds and the TALK/BATT LOW indicator flashes every 3 seconds. Recharge the battery pack.
- If the battery pack is completely discharged, the handset loses the security access-protection code. To reset the code, place the handset on the base and charge the battery pack.
- The supplied battery pack should last for about a year. When the battery pack loses its ability to fully recharge, order a replacement battery pack from your local RadioShack store (see "Replacing the Battery Pack" on Page 20).

## SETTING THE DIALING MODE

Set **DIAL MODE** on the back of the base for the type of service you have. If you are not sure which type you have, do this test.

1. Set **DIAL MODE** to **T**.

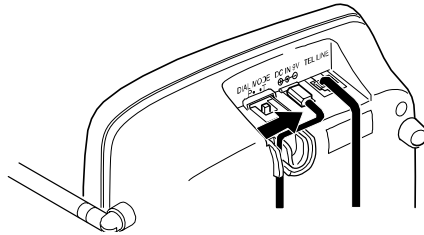

2. Lift the handset and listen for a dial tone.
3. Press any number other than **0**.

**Note:** If your phone system requires that you dial an access code (**9**, for example) before you dial an outside number, do not press the access code either.

If the dial tone stops, you have touch-tone service. Leave **DIAL MODE** set to **T**.

If the dial tone continues, you have pulse service. Set **DIAL MODE** to **P**.

## SETTING THE RINGER TONE/VOLUME

You can select one of four different ringer tone/volume settings while the phone is not in use.

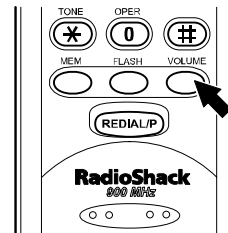

Press **VOLUME** to hear the current ringer setting.

Repeatedly press **VOLUME** until you hear the desired ringer setting. Each time you press **VOLUME**, the ringer changes in this order:

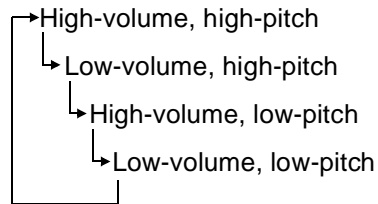

# OPERATION

## MAKING AND RECEIVING CALLS

To make or answer a call, lift the handset. Or, if the handset is not in place on the base, press **TALK**. The TALK/BATT LOW indicator on the handset and the IN USE indicator on the base light.



To end a call, place the handset on the base or press **TALK** so the TALK/BATT LOW indicator turns off.

**Note:** If you press **TALK** to hang up the phone and the phone does not disconnect, press **TALK** again while holding the handset closer to the base or place the handset on the base.

## SELECTING THE CHANNEL

The phone scans 40 channels (frequency pairs used between the base and the handset) and automatically selects a clear channel each time you make or receive a call.

If you hear other conversations or excessive noise during a call, press **CH** to select a different channel. The TALK/BATT

**BATT LOW** indicator blinks, and the handset beeps, followed by a brief pause as your phone searches for a clear channel.

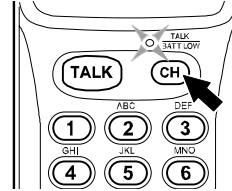

**Note:** If the handset is too far from the base, the channel might not change. Move closer to the base and try again.

## SETTING THE HANDSET VOLUME

To change the volume you hear through the handset, press **VOLUME** during a call. The handset volume has two settings, high or low.

## USING REDIAL

You can quickly dial the last number dialed. When you hear a dial tone, simply press **REDIAL/P**.

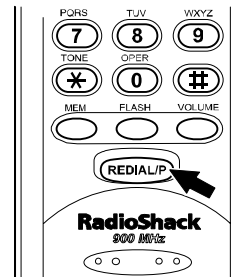

**Notes:**

- The redial memory holds up to 32 digits, so you can redial long-distance as well as local numbers.
- The redial memory also holds pause entries. See “Entering a Pause” on Page 15.
- The redial memory does not store a flash entry or any digits you press after **FLASH** (see “Using Flash”).

**USING FLASH**

**FLASH** performs the electronic equivalent of a switchhook operation for special services, such as Call Waiting.

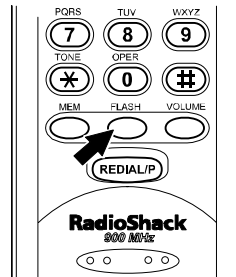

For example, if you have Call Waiting, press **FLASH** to answer an incoming call without disconnecting the current call. Press **FLASH** again to return to the first call.

**Note:** If you do not have any special phone services, pressing **FLASH** might disconnect the current call.

**USING TONE SERVICES ON A PULSE LINE**

Some special services, such as bank-by-phone, require tone signals. If you have pulse service, you can still use these special tone services by following these steps.

1. Be sure **DIAL MODE** is set to **P**.
2. Dial the service's main number.
3. When the service answers, press **TONE/\***. Any additional numbers you dial are sent as tone signals.

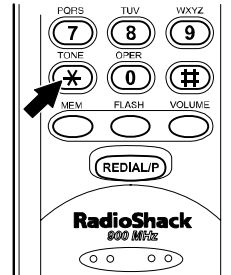

4. After you complete the call, return the handset to the base or press **TALK**. The phone automatically resets to the pulse mode.

## PAGING

To page the person who has the handset or to locate the handset when the phone is not in use, hold down **PAGE** on the base for at least 2 seconds. The handset beeps for 1 minute. To stop it from beeping sooner, press **TALK** on the handset twice.

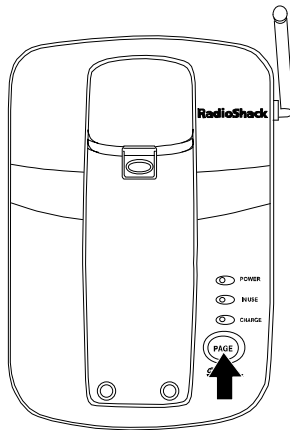

### Notes:

- The phone goes off-hook (you hear the dial tone) the first time you press **TALK** to stop the handset from beeping. If you do not press **TALK** again, the phone remains off-hook.
- If you press **PAGE** for less than 2 seconds, the handset beeps for only 2 seconds.

## MEMORY DIALING

You can store up to 10 numbers in memory, then dial a stored number by pressing a one-digit memory location number.

Each number you store can be up to 16 digits long.

### Storing a Number in Memory

**Note:** An error tone sounds and the phone exits the programming mode if you wait more than 20 seconds between each key press.

1. Lift the handset. If the TALK/BATT LOW indicator lights, press **TALK** to turn it off.
2. Press **MEM**. The TALK/BATT LOW indicator blinks.

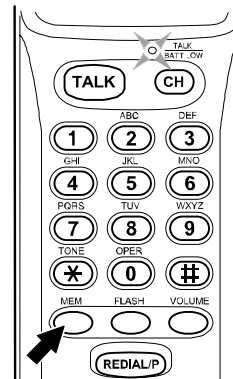

3. Enter the number and any **TONE/ \* mode changes** or **REDIAL/P** entries (see "Entering a Pause" on Page 15).

**Notes:**

- Each **TONE/\*** or **REDIAL/P** entry uses one digit of memory.
  - If you try to enter more than 16 digits, the phone beeps 5 times and exits the programming mode. Start over at Step 2 and enter no more than 16 digits in Step 3.
4. Press **MEM** again, then enter the memory location number (**0-9**) where you want to store the number. A tone sounds to indicate that the number is stored.
  5. For each stored number, write the person's or company's name next to the appropriate location number on the supplied **MEMORY** directory sticker. (Use a pencil in case you need to change the number later.)
  6. Attach the sticker to the phone.

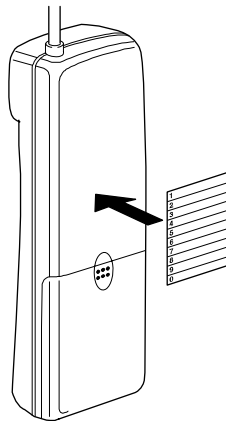

To replace a stored number, simply store a new number in its place.

Or, lift the handset, press **TALK** if the **TALK/BATT LOW** indicator lights, and press **MEM** twice. Then press the memory location number (**0-9**) you want to clear. A tone sounds.

**Entering a Pause**

In some telephone systems, you must dial an access code (**9**, for example) and wait for a second dial tone before you can dial an outside number. You can store the access code with the phone number. However, you must also store a pause after the access code to allow the outside line time to connect. To do so, press **REDIAL/P**. Each press enters a 2-second pause. For a longer pause, press **REDIAL/P** additional times.

**Dialing a Memory Number**

To dial a number stored in memory, lift the handset or press **TALK**. The **TALK/BATT LOW** indicator lights.

When you hear a dial tone, simply press **MEM** and enter the memory location number for the number you want to dial.

**Note:** If you select an empty memory location, the phone beeps 5 times. Try again.

## Chain-Dialing Service Numbers

For quick recall of numbers for special services (such as alternate long distance or bank by phone), store each group of numbers in its own memory location.

To use the stored special service information, dial the service's main number first. Then, at the appropriate place in the call, press **MEM** and the number for the location where the additional information is stored.

## Testing Stored Emergency Numbers

If you store an emergency service's number (police department, fire department, ambulance) and you choose to test the stored number, make the test call during the late evening or early morning hours to avoid peak demand periods. Also, remain on the line to explain the reason for your call.

## USING A HEADSET

You can make or answer calls with hands-free convenience using an optional headset that has a  $\frac{3}{32}$ -inch plug. We recommend RadioShack Cat. No. 43-194, which is specially designed for use with the ET-918/920.

To connect the headset, pull open the rubber cover marked  on the side of the handset, then insert the headset's  $\frac{3}{32}$ -inch plug into the jack.

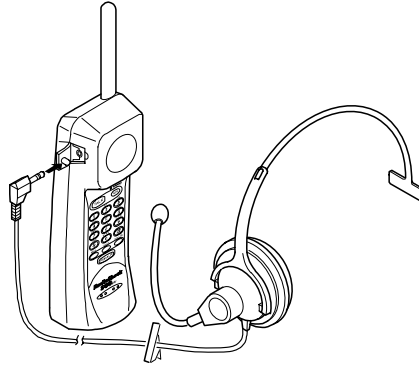

### Notes:

- Connecting a headset disconnects the handset's earpiece and microphone.
- **VOLUME** on the handset (see "Setting the Handset Volume" on Page 12) also controls the connected headset's volume.
- If you place the handset on the base to recharge it while the headset is connected, be sure the handset seats properly.

With a headset connected, you make or answer calls as usual using the keys on the handset.

When you finish using the headset, disconnect it from the handset and close the rubber cover to protect the jack.



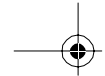

## **TROUBLESHOOTING**



We do not expect you to have any problems with your phone, but if you do, the following suggestions might help.

<b>Problem</b>	<b>Suggestion</b>
Low volume or unusual sounds.	Someone has picked up another phone on the same line. Hang up the other phone.
	If you are using the headset, ensure the headset plug is properly connected to the jack.
Severe noise interference.	Press <b>CH</b> to change the channel.
	Keep the handset away from computers, remote control toys, wireless microphones, alarm systems, intercoms, room monitors, fluorescent lights, and electrical appliances.
	Move to another location or turn off the source of interference.
The phone cannot be operated at a useful distance from the base because the signal becomes weak or noisy (handset's range has decreased).	Hang up and redial the number.
	Lift the base's antenna to a fully vertical position.
	Be sure neither the handset or base antenna is touching a metal surface.
	Return the handset to the base to recharge the battery pack.
The phone does not work or works poorly.	Be sure the base's phone line cord and AC adapter are correctly and securely connected, and the battery is charged.
The handset battery does not charge.	Check the charging contacts on the handset and base. If they are dirty, clean them with a pencil eraser.
	Be sure the battery is properly connected.
	Be sure the handset is properly seated on the base.

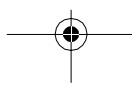
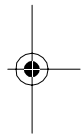
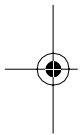

Problem	Suggestion
Handset does not ring or receive a page.	Lift the base's antenna to a fully vertical position.
	Move the handset closer to the base.
	Move the base away from other electrical devices.
	Return the handset to the base to recharge the battery pack.
The handset stops working or works poorly during a call.	Move the handset closer to the base.
	Lift the base's antenna to a fully vertical position.
	If the base lost power while the handset was off of it, the security access-protection code might have changed. With the handset removed from the base, restore power to the base, then place the handset back on the base. The CHARGE indicator lights, indicating that the code is set again.
	Be sure the handset's battery pack is charged. (If the battery pack power is too low, it does not have enough power to light the TALK/BATT LOW indicator.)

If you still have problems, disconnect the phone. If other phones on the same line work properly, the fault is in this phone or its installation. If you cannot find the problem, take your phone to your local RadioShack store for assistance.

## CARE AND MAINTENANCE

---

Your ET-918/920 900-MHz Cordless Telephone with Headset Jack is an example of superior design and craftsmanship. The following suggestions will help you care for your cordless telephone so you can enjoy it for years.



Keep the phone dry. If it gets wet, wipe it dry immediately. Liquids might contain minerals that can corrode the electronic circuits.



Handle the phone gently and carefully. Dropping it can damage circuit boards and cases and can cause the phone to work improperly.



Use and store the phone only in normal temperature environments. Temperature extremes can shorten the life of electronic devices and distort or melt plastic parts.



Keep the phone away from dust and dirt, which can cause premature wear of parts.



Wipe the phone with a damp cloth occasionally to keep it looking new. Do not use harsh chemicals, cleaning solvents, or strong detergents to clean the phone.

Modifying or tampering with the phone's internal components can cause a malfunction and might invalidate your phone's warranty and void your FCC authorization to operate it. If your phone is not performing as it should, take it to your local RadioShack store for assistance. If the trouble is affecting the phone lines, the phone company might ask you to disconnect your phone until you have resolved the problem.

## REPLACING THE BATTERY PACK

If you follow the instructions in "Connecting and Charging the Battery Pack" on Page 9, the battery pack should last about one year. If the battery does not hold a charge (when the phone is not in use) for more than 2 hours after an overnight charge, replace the battery with a new 3.6 volt, 600 milliamp battery with a connector that fits the socket in the battery compartment. You can order a replacement battery pack through your local RadioShack store.

Install the new battery pack as described below, then charge the battery for about 14 hours (see "Connecting and Charging the Battery Pack" on Page 9).

**Note:** To avoid losing phone numbers stored in memory, try to install and begin charging the new battery within 3 minutes.

1. Loosen the screw on the battery compartment cover on the bottom of the handset, and slide off the cover in the direction of the arrow.

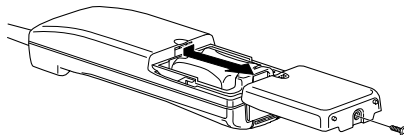

2. Lift the battery out of the compartment, then gently pull on the battery connector to disconnect it.

3. Insert the new battery pack's plastic connector into the socket in the compartment and place the battery pack into the compartment.
4. Replace the cover and tighten the screw.

### Cautions:

- You must use a replacement battery of the same size and type.
- Do not dispose of the battery in a fire because it might explode.
- Do not open or mutilate the battery.
- Be careful not to short the battery by touching the connector's pins with conducting materials, such as rings, bracelets, and keys. The battery or conductor might overheat and burn.

If you have trouble replacing the battery, take the phone to your local RadioShack store for assistance.

**Important:** This product contains a rechargeable nickel-cadmium battery. At the end of the battery's useful life, it must be recycled or disposed of properly. Contact your local, county, or state hazardous waste management authorities for information on recycling or disposal programs in your area. Some options that might be available are: municipal curb-side collection, drop-off boxes at retailers such as your local RadioShack store, recycling collection centers, and mail-back programs.



---

## THE FCC WANTS YOU TO KNOW

In the unlikely event that your phone causes problems on the phone line, the phone company can temporarily discontinue your service. If this happens, the phone company attempts to notify you in advance. If advance notice is not practical, the phone company notifies you as soon as possible and advises you of your right to file a complaint with the FCC.

Also, the phone company can make changes to its lines, equipment, operations, or procedures that could affect the operation of this telephone. The telephone company notifies you of these changes in advance, so you can take the necessary steps to prevent interruption of your telephone service.

Your phone might cause TV or radio interference even when it is operating properly. To determine whether your phone is causing the interference, turn off your phone. If the interference goes away, your phone is causing it. Try to eliminate the interference by:

- Moving your phone away from the receiver
- Connecting your phone to an AC outlet that is on a different electrical circuit from the receiver
- Contacting your local RadioShack store for help

If you cannot eliminate the interference, the FCC requires that you stop using your phone.

Some cordless telephones operate on frequencies that might cause interference to nearby TVs and VCRs. To minimize or prevent such interference, the base of the cordless telephone should not be placed near or on top of a TV or VCR.

## LIGHTNING

Your telephone has built-in lightning protection to reduce the risk of damage from surges in telephone line and power line current. This lightning protection meets or exceeds FCC requirements. However, lightning striking the telephone or power lines can damage your telephone.

Lightning damage is not common. Nevertheless, if you live in an area that has severe electrical storms, we suggest that you unplug your phone during storms to reduce the possibility of damage.

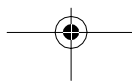



# NOTES

---

---

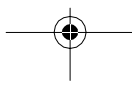

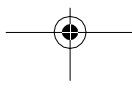
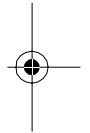

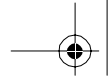

### Limited One-Year Warranty

This product is warranted by RadioShack against manufacturing defects in material and workmanship under normal use for one (1) year from the date of purchase from RadioShack company-owned stores and authorized RadioShack franchisees and dealers. EXCEPT AS PROVIDED HEREIN, RadioShack MAKES NO EXPRESS WARRANTIES AND ANY IMPLIED WARRANTIES, INCLUDING THOSE OF MERCHANTABILITY AND FITNESS FOR A PARTICULAR PURPOSE, ARE LIMITED IN DURATION TO THE DURATION OF THE WRITTEN LIMITED WARRANTIES CONTAINED HEREIN. EXCEPT AS PROVIDED HEREIN, RadioShack SHALL HAVE NO LIABILITY OR RESPONSIBILITY TO CUSTOMER OR ANY OTHER PERSON OR ENTITY WITH RESPECT TO ANY LIABILITY, LOSS OR DAMAGE CAUSED DIRECTLY OR INDIRECTLY BY USE OR PERFORMANCE OF THE PRODUCT OR ARISING OUT OF ANY BREACH OF THIS WARRANTY, INCLUDING, BUT NOT LIMITED TO, ANY DAMAGES RESULTING FROM INCONVENIENCE, LOSS OF TIME, DATA, PROPERTY, REVENUE, OR PROFIT OR ANY INDIRECT, SPECIAL, INCIDENTAL, OR CONSEQUENTIAL DAMAGES, EVEN IF RadioShack HAS BEEN ADVISED OF THE POSSIBILITY OF SUCH DAMAGES.

Some states do not allow the limitations on how long an implied warranty lasts or the exclusion of incidental or consequential damages, so the above limitations or exclusions may not apply to you.

In the event of a product defect during the warranty period, take the product and the RadioShack sales receipt as proof of purchase date to any RadioShack store. RadioShack will, at its option, unless otherwise provided by law: (a) correct the defect by product repair without charge for parts and labor; (b) replace the product with one of the same or similar design; or (c) refund the purchase price. All replaced parts and products, and products on which a refund is made, become the property of RadioShack. New or reconditioned parts and products may be used in the performance of warranty service. Repaired or replaced parts and products are warranted for the remainder of the original warranty period. You will be charged for repair or replacement of the product made after the expiration of the warranty period.

This warranty does not cover: (a) damage or failure caused by or attributable to acts of God, abuse, accident, misuse, improper or abnormal usage, failure to follow instructions, improper installation or maintenance, alteration, lightning or other incidence of excess voltage or current; (b) any repairs other than those provided by a RadioShack Authorized Service Facility; (c) consumables such as fuses or batteries; (d) cosmetic damage; (e) transportation, shipping or insurance costs; or (f) costs of product removal, installation, set-up service adjustment or reinstallation.

This warranty gives you specific legal rights, and you may also have other rights which vary from state to state.

RadioShack Customer Relations, Dept. W, 100 Throckmorton St., Suite 600, Fort Worth, TX 76102

*We Service What We Sell*

3/97

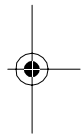
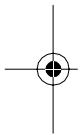

**RadioShack**  
**A Division of Tandy Corporation**  
**Fort Worth, Texas 76102**

UCZZ01403BZ  
 Printed in the Philippines

4A8

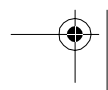
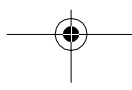



## Free Manuals Download Website

<http://myh66.com>

<http://usermanuals.us>

<http://www.somanuals.com>

<http://www.4manuals.cc>

<http://www.manual-lib.com>

<http://www.404manual.com>

<http://www.luxmanual.com>

<http://aubethermostatmanual.com>

Golf course search by state

<http://golfingnear.com>

Email search by domain

<http://emailbydomain.com>

Auto manuals search

<http://auto.somanuals.com>

TV manuals search

<http://tv.somanuals.com>