

RadioShack®



43-142

Expandable • Caller ID • Digital Answering System
5.8GHz Digital Cordless Phone



What's Included

- Handsets (2)
- Base (1)
- Charger (1)
- Quick Start Guide (1)
- User's Guide (1)
- Wall Mount Adapter (1)
- Ni-MH Battery Packs (2)
(inside handset)
- Modular Cord (1)
- AC Adapters (2)
- Belt Clips (2)

Please read this User's Guide before installing,
setting up and using your new phone.

www.radioshack.com

Contents

Contents

Selecting a Language	28
Setting the Day & Time	29
Activating Caller ID on Call Waiting and Call Waiting Deluxe	29
Activating the Key Touch Tone (Handset only)	30
Adjusting the LCD Contrast	30
Setting the Animation Screen (Handset only)	30
Adding Optional Accessory Handsets	31
Ten Multi-Handset Expandability	31
Registering Accessory Handsets	31
Resetting Handsets	32
Setting up the Phonebook	33
Creating Phonebook Entries	33
Finding a Phonebook Entry	35
Editing Phonebook Entries	35
Storing Caller ID or Redial Numbers in the Phonebook (Handset only)	36
Erasing Phonebook Entries	36
Copying Phonebook Entries to another Station	37
Customizing Your Phone	38
Changing the Handset Banner (Handset only)	38
Selecting a Ring Tone (Handset only)	39
Activating Distinctive Ring (Handset only)	40
Activating AutoTalk (Handset only)	40
Activating Any Key Answer (Handset only)	40
Using your Phone	41
Making a Call	41
Answering a Call	42
Hanging Up	42
Making a call from the Phonebook	43
Chain Dialing from the Phonebook	43
Making a call with Speed Dial	43

Contents

Switching to the Handset Speakerphone during a Call	44
Testing Stored Emergency Numbers	44
Using Caller ID, Call Waiting and Redial Lists	44
Using the Caller ID List	45
Making a call from a Caller ID Record	45
Deleting Caller ID Numbers	46
Using Call Waiting and Call Waiting Deluxe	46
Redialing a Number	48
Deleting a Redial Record (Handset only)	48
Adjusting the Ringer, Earpiece and Speaker Volume	49
Adjusting the Ringer Volume	49
Adjusting the Speaker Volume	49
T-coil (Handset only)	49
Finding a Lost Handset	50
Using Hold, Conference and Transfer	51
Placing a Call on Hold	51
Conferencing	51
Transferring a Call	52
Answering a Transferred Call	52
Using Special Features	53
Do Not Disturb (All calls)	53
Muting the Ringer (One call only)	53
Muting the Microphone	53
Privacy Mode	54
DirectLink™ Communication Feature	54
Intercom	55
Room Monitor	56
Tone Dialing Switch Over	57
Seven-Digit Dialing	58
Traveling Out of Range	58

Contents

Setting Up the Answering Machine	59
Features	59
Using the Answering Machine Interface	60
Selecting the Language	61
Your Greeting	61
Setting the Number of Rings	64
Setting the Record Time (or Announce only)	64
Activating the Message Alert	65
Activating Call Screening	65
Setting a Security Code or Personal Identification Number (PIN)	65
Using the Answering Machine	66
Turning your Answering Machine On and Off	66
Reviewing Messages	68
Screening Calls	70
Recording a Conversation	71
Message Alert	73
Remotely Operating Your Answering Machine	74
Troubleshooting	76
Changing the Digital Security Code	76
Common Issues	77
Care	80
Service and Repair	80
Appendix: Handset-Base Registration	80
Glossary	82

The Basics

Features

Convenient Extension Placement — Lets you add up to eight additional accessory handsets (*RadioShack* 43-144) anywhere you have an AC outlet, regardless of phone jack location.

Call Waiting/Caller ID — Lets you answer a call even when you are on the phone; see who's calling before you answer.

Speakerphone — Lets you conduct a hands-free conversation using the handset speaker.

Ample Talk and Standby Time — The supplied battery (when fully charged) provides about five hours of talk time or seven days of standby time.

Distinctive Ring — Allows you to assign a distinctive ringer to certain memory locations. When an incoming call is received and the Caller ID information matches the information in one of the memory locations, the distinctive ring that has been stored for that particular caller sounds.

DirectLink Mode — Lets you use two handsets like walkie-talkies, even if you are away from base unit.

Message Alert — Beeps when you have a new incoming message.

Call Screening — Lets you listen as a caller leaves a message.

Memo Recording — Lets you leave messages for yourself or others in your home or office, or record your phone conversation.

Handset Remote Operation — Lets you use the handset to listen to your incoming messages.

The Basics

Introduction

Thank you for purchasing your **RadioShack** 5.8 GHz Digital Multi-Handset Expandable Cordless Telephone. Unlike other conventional cordless telephones, your telephone supports up to ten handsets on a single telephone line. You can add a handset to any room in your home or office that has an AC outlet. You can transfer outside calls to other handsets. If you subscribe to Call Waiting with Caller ID, the phone shows you the incoming caller information, even when you are already talking on the phone.

NOTE

Cordless phones require AC power to operate. When the power is off, you cannot make or receive calls by using your phone. We recommend you also have a mobile phone so you can still make and receive calls in the event of an AC power failure.



IMPORTANT

- **Your phone operates on standard radio frequencies as allocated by the FCC.**
- **It is possible for other radio units operating nearby on similar frequencies to unintentionally intercept your conversation or cause interference. This possible lack of privacy can occur with any cordless phone.**

The Basics

Important Information

This telephone has been tested and found to comply with all applicable UL and FCC standards.

FCC Statement

This equipment complies with Part 68 of the FCC rules and the requirements adopted by the ACTA. On the base of this equipment is a label that contains, among other information, a product identifier in the format US:AAAEQ##TXXXX. If requested, this number must be provided to the telephone company. Your phone is not intended to be used with party-line systems. Connection to party line service is subject to state tariffs. Contact the state public utility commission, public service commission, or corporation commission for information.



You must not connect your phone to...

- coin-operated systems
- most electronic key telephone systems

The REN is used to determine the number of devices that may be connected to a telephone line. Excessive RENs on a telephone line may result in the devices not ringing in response to an incoming call. In most but not all areas, the sum of RENs should not exceed five (5.0). To be certain of the number of devices that may be connected to a line, as determined by the total RENs, contact the local telephone company. For products approved after July 23, 2001, the REN for this product is part of the product identifier that has the format US:AAAEQ##TXXXX. The digits represented by ## are the REN without a decimal point (e.g., 03 is a REN of 0.3). For earlier products, the REN is separately shown on the label.

If you use more than one phone or other device on the line, add up all of the RENs. If the total is more than five (three in rural areas), your telephones might not ring. If ringer operation is impaired, remove a device from the line.

The Basics

In the unlikely event that your phone causes problems on the phone line, the phone company can temporarily discontinue your service. If this happens, the phone company attempts to notify you in advance. If advance notice is not practical, the phone company notifies you as soon as possible and advises you of your right to file a complaint with the FCC.

Also, the phone company can make changes to its lines, equipment, operations, or procedures that could affect the operation of this phone. The telephone company notifies you of these changes in advance, so you can take the necessary steps to prevent interruption of your telephone service.

This device complies with part 15 of the FCC rules. Operation is subject to the following two conditions: (1) This device may not cause harmful interference, and (2) This device must accept any interference received, including interference that may cause undesired operation. Privacy of communications may not be ensured when using this phone.

To ensure the safety of users, the FCC has established criteria for the amount of radio frequency energy various products may produce depending on their intended usage. This product has been tested and found to comply with the FCC's exposure criteria. The FCC RF exposure guidelines were also met when used with the **RadioShack** accessories supplied or designed for this product. Use of other accessories may not ensure compliance with FCC RF exposure guidelines and should be avoided.

WARNING: To reduce the risk of fire or shock hazard, do not expose this product to rain or moisture.



CAUTION

RISK OF ELECTRIC SHOCK DO NOT OPEN



CAUTION: TO REDUCE THE RISK OF ELECTRIC SHOCK, DO NOT REMOVE COVER OR BACK. NO USER-SERVICEABLE PARTS INSIDE. REFER SERVICING TO QUALIFIED PERSONNEL.



The lightning symbol is intended to alert you to the presence of uninsulated dangerous voltage within this product's enclosure that might be of sufficient magnitude to constitute a risk of electric shock. Do not open the product's case.



The exclamation mark symbol is intended to inform you that important operating and maintenance instructions are included in the literature accompanying this product.

The Basics

Surge Protection

Your telephone has built-in protection circuits to reduce the risk of damage from surges in telephone line and power line current. These protection circuits meet or exceed the FCC requirements. However, lightning striking the telephone or power lines can damage your telephone.

Lightning damage is not common. Nevertheless, if you live in an area that has severe electrical storms, we suggest that you unplug your phone when storms approach to reduce the possibility of damage.

Important Safety Instructions

When using your telephone equipment, basic safety precautions should always be followed to reduce the risk of fire, electric shock and injury to persons, including the following:

Do not use this product near water, for example, near a bathtub, wash bowl, kitchen sink, or laundry tub, in a wet basement or near a swimming pool.

Avoid using a telephone (other than a cordless type) during an

The Basics

Important Caller ID Information

To use Caller ID and Call Waiting, you must be in an area where those services are available and you must subscribe to those services through your local phone company.

Where Caller ID is offered, one or more options are generally available:

- caller's number only
- caller's name only
- caller's name and number

If you subscribe to Call Waiting and Caller ID, the system can show you the incoming caller information, even when you are already talking on the phone.

Read This Before Installation

We have designed your phone to conform to federal regulations when you can connect it to most phone lines. However, each device that you connect to the telephone line draws power from the line. We refer to this power draw as the phone's ringer equivalence number, or REN. The REN is on the bottom of your phone.

The Basics

Controls & Functions

Handset

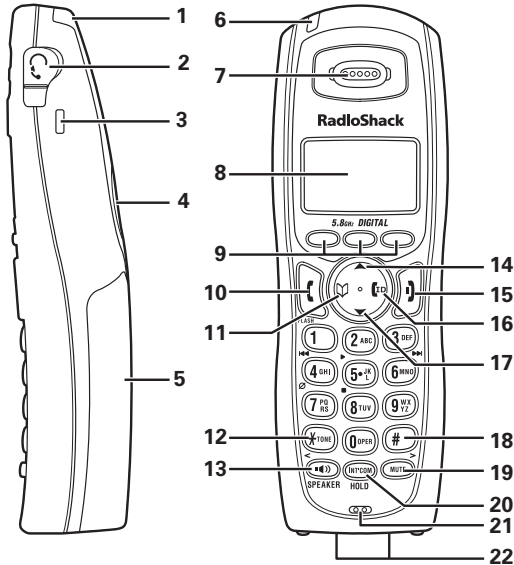

1. Handset Antenna
2. Headset Jack Cover
3. Belt Clip Hole
4. Speakerphone Speaker and Ringer
5. Handset Battery Compartment
6. New Message indicator
7. Handset Earpiece
8. Handset Display
9. Soft keys
10. **[FLASH]** (talk/flash) key
11. **[PHONEBOOK]** (phonebook) key
12. **[TONE]** key
13. **[SPEAKER]** key
14. **[UP]** (up) key
15. **[END CALL]** (end call) key
16. **[CALLER ID]** (caller ID) key
17. **[DOWN]** (down) key
18. **[#]** (pound) key
19. **[MUTE]** key
20. **[INT'COM/HOLD]** (intercom/hold) key
21. Handset Microphone
22. Handset Charging Contacts

The Basics

Base

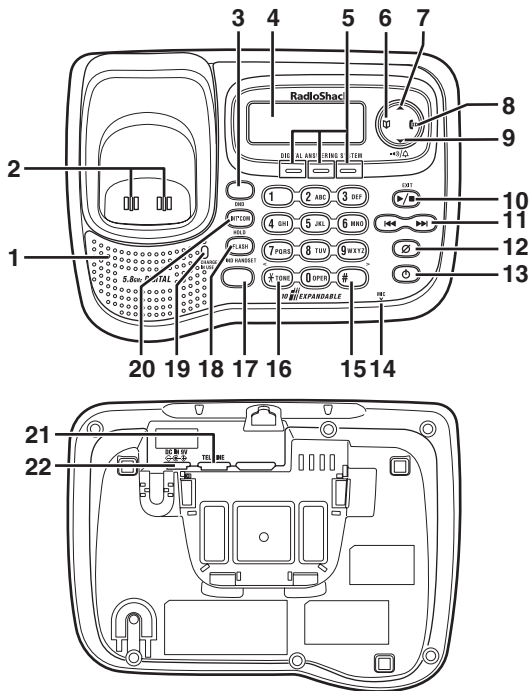

- | | |
|--|---|
| 1. Base Speaker | 13. ⏻ (answering machine on/off) key |
| 2. Base Charging Contacts | 14. Base Microphone |
| 3. DND (do not disturb) key and LED | 15. #/> key |
| 4. Base LCD | 16. ✖/TONE/< key |
| 5. Soft Keys | 17. ⏪ (speaker) key and speaker LED |
| 6. 📖 (phonebook) key | 18. FLASH/FIND HANDSET key |
| 7. ▲ (up) key | 19. CHARGE/IN USE LED |
| 8. 📞 (caller ID) key | 20. INT'COM/HOLD (intercom/hold) key |
| 9. ▼ (down) key | 21. TEL LINE Jack |
| 10. ▶/□/EXIT (play/stop/exit) key | 22. DC IN 9V Jack |
| 11. ⏮/⏭ (repeat/skip) key | |
| 12. ⌫ (delete) key | |

The Basics

Installation

Before using your phone, carefully peel the protective film off the display. The film protects the handset window during shipment and is not necessary for use.

Selecting a Location

You can place the phone's base on a desk or table. Select a location that is:

- near an accessible AC outlet
- near a telephone line jack
- away from electrical machinery, electrical appliances, metal walls, filing cabinets, wireless intercoms, alarms, and room monitors
- away from other cordless phones



NOTES

- **If your home has specially wired alarm equipment connected to the telephone line, be sure that installing the system does not disable your alarm equipment.**
- **If you have questions about what will disable alarm equipment, contact your telephone company or a qualified installer.**

The location of the base affects the handset's range. If you have a choice of several locations, try each to see which provides the best performance.

The Basics

The handset antenna is located on the back, above the ringer speaker. For maximum communication range, do not hold the handset in such a way as to cover the antenna by your hand. Also, place the handset in the upright position while not in use so the antenna can pick up the signals from the base.

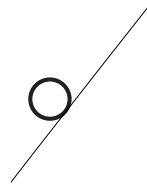

When there is an obstacle such as a metal or concrete wall between the handset and the base, the operation might be affected. Try to keep the path free from obstructions.



Your telephone connects directly to a modular telephone line jack. If your telephone wiring does not have a modular jack, you can update the wiring yourself using jacks and adapters (available at your local **RadioShack** store), or have the telephone company update the wiring for you. You must use compatible modular jacks that are compliant with Part 68 of FCC Rules.



The USOC number of the jack to be installed is RJ11C (or RJ11W for a wall plate jack).

Connecting the Phone Base

1. Plug one end of the supplied long modular cord into the **TEL LINE** jack on the back of the base.
2. Plug the other end of the modular cord into a modular phone line jack.

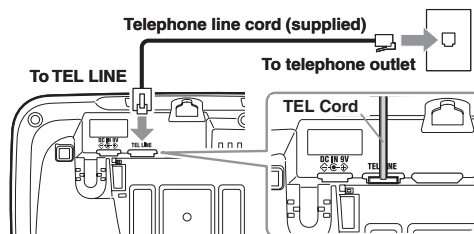

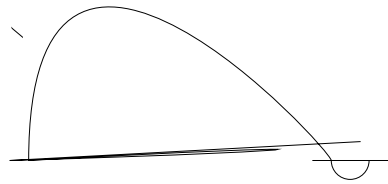
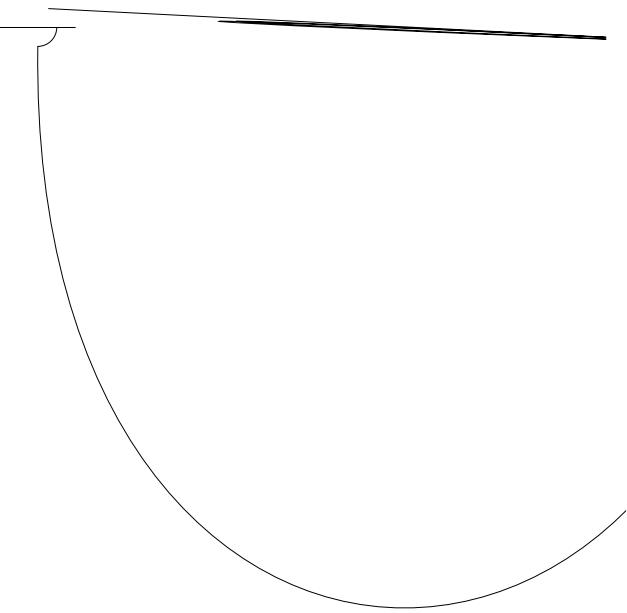



The Basics

Connecting/Charging the Battery Pack

The phone comes with a rechargeable nickel-metal hydride (Ni-MH) battery pack in the handset. Before using your phone, you must connect the battery pack. Then charge it for about 15 - 20 hours.

1. Press down and slide off the battery compartment cover.
 2. Lift the battery pack out of the compartment.
 3. Plug the battery pack's connector into the socket in the compartment (the connector fits only one way). Then place the battery pack in the compartment.
 4. Replace the cover.
 5. To charge the battery pack, place the handset on the base or charger. The **CHARGE/IN USE** indicator on the base or charger lights.
- Recharge the battery pack when LOW BATTERY flashes on the display.
 - If you have any trouble replacing the battery pack, take the phone to your local **RadioShack** store for assistance.



The Basics

Notes on Recharging

- If the battery pack becomes weak during a call, LOW BATTERY flashes. When this happens, you cannot make a call until you recharge the battery pack.



IMPORTANT: Be sure the battery pack is properly connected before charging. The CHARGE/IN USE indicator lights when the handset is on the base or charger.

- If the display is blank and the phone does not work, recharge the battery pack. (The battery power might be too low to light the display.)
- About once a month, fully discharge the battery by keeping the handset off the base until LOW BATTERY flashes on the display. Otherwise, the battery pack loses its ability to fully recharge.
- Using a damp cloth, clean the charging contacts on the handset about once a month.
- If you are not going to use your phone for an extended period, disconnect the battery pack. This increases the battery pack's usable life.
- The supplied battery pack should last for about a year. If the battery pack does not hold a charge for more than 2 hours after an overnight charge, replace it with a new 3.6-volt, 750 mAh battery pack with a connector that fits the socket in the battery compartment.

You can order a replacement battery pack through your local **RadioShack** store. Install the new battery pack and charge it for about 15 - 20 hours.



WARNING:

- **Dispose of the old battery pack promptly and properly.**
- **Do not burn or bury it. Dispose of used batteries according to the instructions.**
- **Danger! Risk of explosion if battery is replaced by an incorrect type.**

The Basics

Installing a Belt Clip

To Attach the Belt Clip, insert the belt clip into the holes on each side of the handset. Press down until it clicks.

To Remove the Belt Clip, pull either side of the belt clip to release the tabs from the holes.

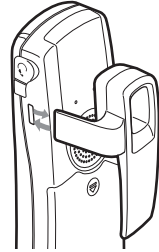

Using an optional Headset

You can make or answer calls handsfree using an optional headset that has a 3/32-inch (2.5-mm) plug. Your local **RadioShack** store has a variety of headsets available.

1. To connect the headset, gently flip open the rubber headset jack cover on the side of the handset. Then insert the headset's plug into the jack.
2. Use ▲ or ▼ on the handset to adjust the headset's volume.
3. With a headset connected, you can make or answer calls as usual using the keys on the handset.
4. When you finish using the headset, disconnect it from the handset and close the rubber cover to protect the jack.

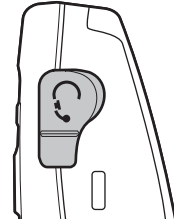

NOTES







- Always place the handset properly on the base or charger whenever you are recharging the handset.
- You can use a headset holder (available from your local **RadioShack** store) to hang the handset on your belt for added convenience.

The Basics

Using the Interface

Reading the Handset Display









The handset display uses icons to tell you the status of your phone. The table below lists the icons and what they mean.

Icon	Status	Description
	Talk	Appears when Privacy mode is turned on.
	Talk	Appears while recording a conversation.
	Talk	Appears when you mute the handset.
	Talk	Appears when the handset speakerphone is in use.
	Talk	Appears when T-coil mode is turned on.
	Standby	Indicates that the ringer is turned off.
	Standby/ Talk	Indicates the handset battery status: empty, low, medium, and full.

The Basics

Reading the Base Display

The base display uses icons to tell you the status of your phone. The table below lists the icons and what they mean.

Icon	Status	Description
	Talk	Appears when Privacy mode is turned on.
	Talk	Appears while recording a conversation.
	Talk	Appears when you mute the base.
	Standby	Appears when a new messages is received.
	Standby/ Talk	Appears when the answering machine is turned off.
	Standby/ Talk	Appears when the memory on the answering machine is full.
	Standby/ Talk	Appears when the answering machine is set to announce only greeting.
	Standby	Indicates that the ringer is turned off.

The Basics

The Standby Screen

When the phone is in standby, the handset and base display shows the following items:

Handset

Ringer off icon (when the ringer is off)/
day of the week and time / battery icon

Handset ID and Banner

Number of new Caller ID calls received
(If there are no new Caller ID messages,
the Handset ID appears here.)



Base

Day of the week and time

Status of your
answering machine

Number of message



The Basics

Soft Key Function

“Soft” keys are keys that change functions while you operate your phone. There are three soft keys on each station. Soft keys allow you to:

- Access the main menu
- Set up CIDCW options
- Store or edit phone numbers
- Remote answering operation
- Redial one of the last three numbers dialed

The icon that appears directly above each soft key determines the function shown.

For example, when the handset is in standby mode, pressing soft key 1 will access the redial list. When the handset is in talk mode, pressing soft key 1 will mute the microphone.

In st





The Basics

**NOTES**

- If you do not press a key within 30 seconds, the phone will time out and exit the menu. When setting Day and Time, the time-out period is extended to two minutes.
- For GLOBAL SETUP, ANSW. SETUP, and DEREGISTER HS menu options on the handset (GLOBAL SETUP and ANSW. SETUP menu options on the base), make sure the line is not in use, and if you access from a handset, the handset is within range of the base.
- Only one handset can change GLOBAL SETUP menu options at a time.
- If you change one of GLOBAL SETUP/GLOBAL menu options, you change that setting for all registered handsets.

The Basics

Entering Text from Your Phone

You can use the number keypad on your handset or base to enter text by referring to the letters printed on each number key. When you press the number key in a text entry field, the phone displays the first letter printed on the number key. Press the number key twice to display the second letter and three times to display the third. Capital letters are displayed first, then lower case letters, then the number on the key.

If two letters in a row use the same number key, enter the first letter. Then use **#** or ***/TONE** to move the cursor to the next position to enter the second letter.

For example, to enter Movies:

1. Press **6** once to enter M.
2. Use **#** to move the cursor to the right.
3. Press **6** six times to enter o.
4. Press **8** six times to enter v.
5. Press **4** six times to enter i.
6. Press **3** five times to enter e.
7. Press **7** eight times to enter s.
8. Press the **OK** soft key to end your text entry.

If you make a mistake while entering a name, use **#** or ***/TONE** to move the cursor to the incorrect character. Press the **DELETE** soft key to erase the wrong character, and then enter the correct character. To delete all characters, press and hold the **DELETE** soft key.



The Basics

Basic Setup

Changing the Dial Mode

Your phone can communicate with the telephone network in two different ways: tone dialing or pulse dialing. These days, most phone networks use a method called tone dialing, so your phone comes programmed for tone dialing. If your phone company uses pulse dialing, you will need to change your phone's dial mode. If you cannot connect to the telephone network, please follow the steps below to modify your phone's settings:

1. Press the **MENU** soft key. Select the GLOBAL SETUP menu, and then the DIAL MODE submenu.
2. Press ▼ on the four-way function key to select PULSE. (The initial setting is Tone).
3. Press the **OK** soft key. You will hear a confirmation tone.

**NOTE**

If you ever need to change the dial mode back to Tone, follow the same procedure, but select TONE in step 2.

Selecting a Language

Your phone supports two languages: English and Spanish for USA models or English and French for Canadian models. Once you select a language, the menus on the phone will display in that language. The default language is English.

1. Press the **MENU** soft key. Select the HANDSET SETUP or BASE SETUP menu, and then the LANGUAGE submenu.
2. Move the cursor to choose a language.
for USA models: Choose ENGLISH or ESPAÑOL (Spanish).
for Canadian models: Choose ENGLISH or FRANÇAIS (French).
3. Press the **OK** soft key. You will hear a confirmation tone.

The Basics

Setting the Day & Time

To change the day and time shown in the display, follow the steps listed below.

NOTE

If you don't press any keys for two minutes when setting the date and time, the phone will exit the menu.

Press the **MENU** soft key. Select the GLOBAL SETUP menu, and then the DAY & TIME submenu.

1. Press ▲ or ▼ to select the day of the week, and then the → soft key.
2. Press ▲ or ▼ to select hour, and then the → soft key.
3. Press ▲ or ▼ to select minute, and then the → soft key.
4. Press ▲ or ▼ to select AM or PM, then press the **SAVE** soft key. You will hear a confirmation tone.

Activating Caller ID on Call Waiting and Call Waiting Deluxe

Your phone supports Caller ID on Call Waiting (CIDCW), so you can see the name and number of someone who calls when you're already on the line. Your phone also supports Call Waiting Deluxe (CWDX), which gives you a choice of how you want to handle a waiting call. You'll need to subscribe to these features with your phone company before you can use them. To let your phone support these features, follow the steps below:

See page 46 for instructions on using Call Waiting Deluxe.

1. Press the **MENU** soft key. Select the GLOBAL SETUP menu, and then the CIDCW submenu.
2. Move the cursor to select CW ON /CWDX ON, CW ON /CWDX OFF or CW OFF/CWDX OFF.
3. Press the **OK** soft key. You will hear a confirmation tone.

The Basics

Activating the Key Touch Tone (Handset only)

Key Touch Tone is the tone your keypad makes when keys are pressed. You can turn this tone on or off.

1. Press the **MENU** soft key. Select the HANDSET SETUP menu, and then the KEY TOUCH TONE submenu.
2. Move the cursor to select ON or OFF.
3. Press the **OK** soft key. You will hear a confirmation tone.

Adjusting the LCD Contrast

Contrast adjusts the handset and base LCD brightness. Choose one from the 10 levels for optimum viewing.

1. Press the **MENU** soft key. Select the HANDSET SETUP or BASE SETUP menu, and then the CONTRAST submenu.
2. Press ▲ or ▼ on the four-way function key to adjust the contrast of the LCD.
3. Press the **OK** soft key. You will hear a confirmation tone.

Setting the Animation Screen (Handset only)

The Animation screen displays animation on the handset LCD. The animations will be displayed on the LCD screen during a call, ringer volume setting, when you hang up, and so on.

1. Press the **MENU** soft key. Select the HANDSET SETUP menu and then the ANIMATION SCREEN submenu.
2. Press ▲ or ▼ to select ON or OFF.
3. Press the **OK** soft key. You will hear a confirmation tone.

The Basics

Adding Optional Accessory Handsets

Ten Multi-Handset Expandability

Your phone supports up to ten handsets, including any handsets supplied with your phone. You can now place a fully-featured cordless handset anywhere AC power is available to connect the handset charger.

Up to two handsets can be used for outside and/or intercom calls. For example, you can have three-way conferencing (two handsets and one outside line) while on an intercom call using the other two handsets.

Registering Accessory Handsets

If you purchase an 43-144 accessory handset, you need to register the handset before use. Only one handset can be registered at a time.

Handsets supplied with the phone are registered to the base by the factory. When charged, pre-registered handsets display a handset ID number. Handsets that have not been registered display the message, **MODELS VARY! PLACE HANDSET ON THE BASE FOR REGISTRATION OR REFER TO OWNER'S MANUAL.**

When you register an accessory handset to the base, the handset ID number will be assigned.

1. Before registering the accessory handset, the battery pack **MUST** be charged for 15-20 hours.
2. Place the accessory handset in the base's charging cradle to begin registration.
3. While the handset is registering, **HANDSET REGISTERING** will appear in the handset display. When **REGISTRATION COMPLETE** is displayed, the handset has been registered to the base. If **REGISTRATION FAILED** appears, remove the handset from the base and try again.

The Basics

Resetting Handsets

If you want to register a handset to a different base or replace a handset with another one, you must first reset the existing registration data. To reset, please follow these steps:

1. Press the **MENU** soft key. Select the DEREGISTER HS submenu.
2. DEREGISTER HS? appears. Move the cursor to select YES. Press the **OK** soft key.

Or

From the handset, press and hold ***)** and **#** for more than 5 seconds. You will hear a confirmation tone, and DEREGISTRATION COMPLETE appears.

After resetting the handset, place the handset to the base to register. You must re-register the handset before you can use it.

NOTE



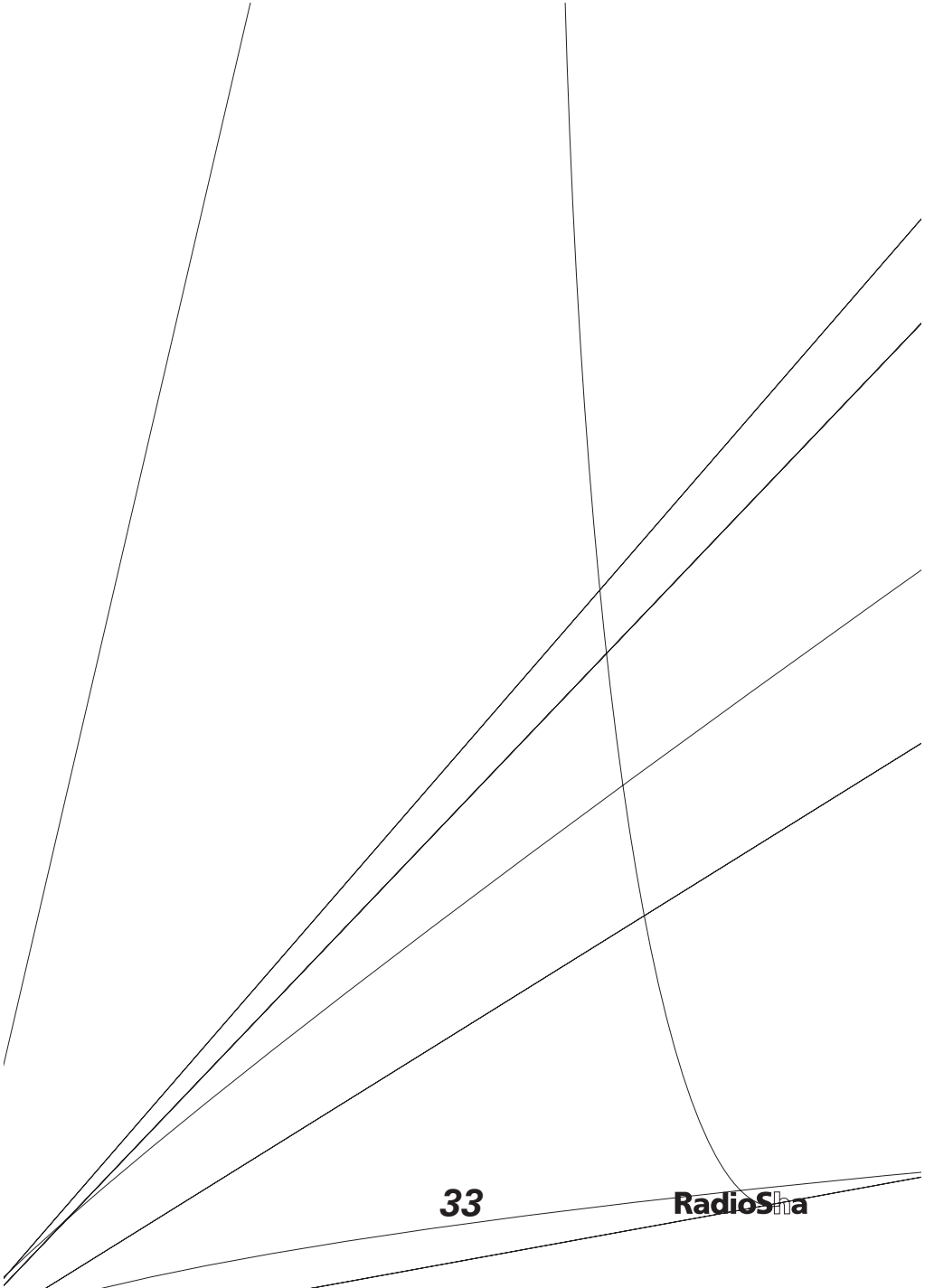

If the handset cannot contact the base, it will display OUT OF RANGE. If this happens, see "Appendix: Handset-Base Registration" on page 80. For instructions on registering the handset, see page 31.









Beyond the Basics

Beyond the Basics



Finding a Phonebook Entry

Phonebook entries are stored in alphabetical order. To scroll through the phonebook, press  and then press  or  on the four-way function key. Press and hold  or  on the four-way function key to scroll through the display quickly.

You can also use the letters on the number keys to jump to a name that starts with that letter. Press  and a number key (**0**, **2-9**) once for the first letter, twice for the second letter, and so on. The phonebook jumps to the first entry that begins with the letter you entered; you can then use  or  on the four-way function key to scroll to other entries. For example, to search for an entry beginning with the letter M, press **6** once.

To close the phonebook, press  on the handset or /EXIT on the base. If you are looking up a phonebook entry during a call and want to close the phonebook, press the **BACK** soft key instead of .

Editing Phonebook Entries

1. Press  to open.
2. Use  or  on the four-way function key to scroll through the phonebook entries. When you come to the entry you want to edit, press the **EDIT** soft key.
3. Follow the steps for “*Creating Phonebook Entries*” on page 33. If you do not wish to change the information at any step, simply press the **OK** soft key to go to the next step.

Beyond the Basics

Beyond the Basics

Copying Phonebook Entries to another Station

You can transfer stored phonebook entries from one station to another without having to re-enter names and numbers. You can transfer one phonebook entry at a time or all phonebook entries at once.

1. When the phone is in standby, press .
2. Press the **COPY** soft key.
3. Use **▲** or **▼** on the four-way function key to select the station to which you want transfer the phonebook entry and then press the **OK** soft key.
4. Use **▲** or **▼** on the four-way function key to select **ONE MEMORY** or **ALL MEMORIES**. Press the **OK** soft key.
5. If you select **ALL MEMORIES**, **ARE YOU SURE?** appears on the display screen.
6. Select **YES** or **NO**. Press the **OK** soft key.
7. If you select **ONE MEMORY**, use **▲** or **▼** on the four-way function key or the number key (**0, 2-9**) to select desired phonebook entry, then press the **COPY** soft key.

The phonebook entries will be transferred to the designated station. During the copy process, the receiving station shows **RECEIVING** and the Banner name of the sending handset. When the transfer is completed, **DONE!** appears.

NOTES

- If your Phonebook contains 100 entries, you cannot store any new phonebook entries. You will hear a beep, and **NOT ENOUGH MEMORY IN RECEIVING UNIT** appears on the display.
- If the selected handset is out of range or data transfer is canceled, **UNAVAILABLE** appears in the display. Phonebook listings will not be transferred.

Beyond the Basics

Beyond the Basics

Selecting a Ring Tone (Handset only)

You may choose from 10 melodies or 10 tones for your phone's primary ring tone. Each station can use a different ring tone or melody. The available ring tones are listed below:

Melodies	Ringers
Beethoven's Symphony #9 [Beethoven9]	Flicker
Fur Elise [Elise]	Clatter
We Wish You A Merry Christmas [Merry- Xmas]	Soft Alert
Home Sweet Home [Hm Swt Hm]	Wake Up
Lorri Song #6 [Lorri Song]	Light Bug
When the Irish Eyes Are Smiling [Irish Eyes]	Beep Boop
Aura Lee	Tone Board
Let Me Call You Sweet Heart [Sweetheart]	Chip Chop
Star Spangled Banner [Star Spngl]	Party Clap
Old MacDonald [Old MacDld]	Reminder

1. Press the **MENU** soft key. Select the HANDSET SETUP menu, and then the RINGER TONES submenu.
2. Move the cursor to highlight a ring tone. As each ring tone is highlighted, you will hear a sample of the ring tone.
3. When you hear the tone you want to use, press the **OK** soft key. You will hear a confirmation tone.

Beyond the Basics

Activating Distinctive Ring (Handset only)

You can assign special ring tones to anyone in your phonebook. When your phone gets a call, it looks up the Caller ID information in your phonebook. If you've assigned a Distinctive ring to that number, the phone uses it so you know who is calling. To turn on Distinctive ring, follow these steps:

1. Press the **MENU** soft key. Select the **HANDSET SETUP** menu, and then the **DISTINCTIVE RING** submenu.
2. Move the cursor to select **ON** or **OFF**.
3. Press the **OK** soft key. You will hear a confirmation tone.

Activating AutoTalk (Handset only)

AutoTalk allows you to answer the phone simply by removing the handset from the cradle. You do not have to press any keys to answer the call.

1. Press the **MENU** soft key.
2. Select the **HANDSET SETUP** menu, and then the **AUTO TALK** submenu.
3. Select **ON** or **OFF**, and press the **OK** soft key. You will hear a confirmation tone.

Activating Any Key Answer (Handset only)

Any Key Answer allows you to answer the phone by pressing any key in the number keypad.

1. Press the **MENU** soft key.
2. Select the **HANDSET SETUP** menu, and then the **ANYKEY ANSWER** submenu.
3. Select **ON** or **OFF**, and then press the **OK** soft key. You will hear a confirmation tone.

Beyond the Basics

Using your Phone







Making a Call

From the base speakerphone	<ol style="list-style-type: none">1. Press ☎.2. Listen for the dial tone.3. Dial the number. OR <ol style="list-style-type: none">1. Dial the Number.2. Press ☎.
From a cordless handset	<ol style="list-style-type: none">1. Remove the handset from the charging cradle.2. Press ☎/FLASH.3. Listen for the dial tone.4. Dial the number. OR <ol style="list-style-type: none">1. Remove the handset from the charging cradle.2. Dial the number.3. Press ☎/FLASH.
From a handset speakerphone	<ol style="list-style-type: none">1. Remove the handset from the charging cradle.2. Press ☎.3. Listen for the dial tone.4. Dial the number. OR <ol style="list-style-type: none">1. Remove the handset from the charging cradle.2. Dial the number.3. Press ☎.







Beyond the Basics

Beyond the Basics

Making a call from the Phonebook



1. When the phone is in standby, press  to open the phonebook.
2. Scroll through the list with the  or  on the four-way function keys until you find the phonebook entry you want to call. (See “*Finding a Phonebook Entry*” on page 35).
3. Press  **/FLASH** or  on the handset or  on the base to dial the number.

Or



1. Press  **/FLASH** or  on the handset or  on the base.
2. Press  to open the phonebook.
3. Scroll through the list with the  or  on the four-way function keys until you find the phonebook entry you want to call. (See “*Finding a Phonebook Entry*” on page 35).
4. Press the **DIAL** soft key to dial the number.

Chain Dialing from the Phonebook

You can use the phonebook entries to store a group of numbers (up to 20 digits) that you may need to enter once your call connects. Once the call has connected you will then do the following.

1. Press .
2. Use  and  to select the phonebook entry you want to dial.
3. Press the **DIAL** soft key.

Making a call with Speed Dial

1. When the phone is in standby, press and hold the number key **0-9** on the handset or on the base until the assigned phonebook entry appears in the display.
2. Press  **/FLASH** or  on the handset or  on the base to dial the number.

Beyond the Basics

Switching to the Handset Speakerphone during a Call

To switch a normal call to the speakerphone, press **☎** on the handset. To switch from a speakerphone call to a normal call, press **☎**.

Testing Stored Emergency Numbers

If you store an emergency service's number (police department, fire department, ambulance) and you choose to test the stored number, make the test call during the late evening or early morning hours to avoid peak demand periods. Also, remain on the line to explain the reason for your call.

Using Caller ID, Call Waiting and Redial Lists

If you subscribe to Caller ID from your phone company, your phone will show you the caller's phone number and name (if available) whenever a call comes in. If you subscribe to both Call Waiting and Caller ID, the phone also shows you the name and the number of any call that comes in while you are on the line.

NOTES

- **If you answer a call before the Caller ID message is received (for example, before the second ring), the Caller ID message may not appear.**
- **When the call is received via a Telephone Company that does not offer Caller ID service, the caller's phone number and name will not appear. (This includes some international calls.)**
- **When the Call is from a PBX (private branch exchange), the caller's phone number and name may not appear.**

Beyond the Basics

Using the Caller ID List

You can store up to 100 Caller ID numbers in each station. Your phone shares up to 100 memory entries between your Phonebook and Caller ID. When the shared memory is full and when you store a new phonebook entry, the oldest Caller ID message is overwritten. Once you reach your maximum phonebook entries of 100, Caller ID information will not be stored (but it will still display when the call comes in).

To open the Caller ID list, press

Beyond the Basics

Beyond the Basics



NOTES

- To activate the feature, select the **GLOBAL SETUP** menu, the **CIDCW** submenu, and then **CW ON/CWDX ON**. See page 29.
- If you don't choose a **CWDX** option within **30** seconds, the phone returns to the call.
- To return to the call, press the **BACK** soft key.

1. When you receive a Call Waiting call, press the **CWDX** soft key.
2. Move the cursor or use the number keypad **1-7** to select an option.

Ask to Hold — A prerecorded message states that the user will be available shortly, and the call is placed on hold.

Tell Busy — A prerecorded message tells the caller you are busy, and the waiting call is disconnected.

Forward Call — The caller is sent to your voice mail box, if available.

Answer/Drop 1 — Disconnects the first call, and connects to the new caller.

Conference — Starts a conference call with your first and second callers.

Drop First — During a conference call, allows you to choose to drop the first caller.

Drop Last — During a conference call, allows you to choose to drop the last caller.

3. Press the **OK** soft key. A confirmation screen will appear, and the phone returns to the call.

Beyond the Basics

Beyond the Basics

Adjusting the Ringer, Earpiece and Speaker Volume

Adjusting the Ringer Volume

You can choose from three ringer volume settings on the handset and the base (off, low, high). With the phone in standby, use ▲ or ▼ on the four-way function key to adjust the ringer volume.

Adjusting the Speaker Volume

Ear speaker: You can choose from six volume levels for the earpiece speaker. To adjust the earpiece volume while on a call, press ▲ (to make it louder) or ▼ (to make it softer).

Speaker: You can choose from six volume levels for the handset speakerphone and ten volume levels for the base speakerphone. To adjust the speaker volume while on a call, press ▲ (to make it louder) or ▼ (to make it softer).

T-coil (Handset only)

Digital spread spectrum cordless phones generate magnetic signals that could cause noise to be heard by users wearing hearing aids set to “T” mode. (The “T” mode is only found on hearing aids equipped with a telecoil (“T” coil) feature). This phone includes a special “T-coil” mode that, when activated, reduces the magnetic noise generated by the handset.

To activate the “T-coil” mode perform the following steps on your handset:

While on a call:

1. Press and hold **MUTE** for at least 5 seconds or until a beep tone is heard.
2. The “T-coil” mode icon  will appear on the handset LCD display.

The handset will remain in “T-coil” mode for all future calls or until the “T-coil” mode is turned off.

Beyond the Basics

To turn off the “T-coil” mode perform the following steps on your handset:

While on a call:

1. Press and hold **mute** for at least 5 seconds or until a beep tone is heard.
2. The “T-coil” mode icon will no longer appear on the handset LCD display.

NOTE

Using the T-coil mode may shorten the amount of time you can talk on your handset between battery charges. Therefore it is recommended that the handset be returned to the charging cradle when not in use. If this feature is not required, the “T-coil” mode should not be turned on.

Finding a Lost Handset

To locate a misplaced handset, press **FLASH/FIND HANDSET** on the base when the phone is in standby. All registered handsets will beep for 60 seconds, and **PAGING** appears on the handset display. To cancel paging, press **FLASH/FIND HANDSET** on the base.

NOTE

If the battery pack is completely drained, the handset will not beep when paging.

Beyond the Basics

Using Hold, Conference and Transfer

Placing a Call on Hold

1. During a call, press **INT'COM/HOLD** on the station to place the caller on hold. If you leave a caller on hold for more than ten seconds, the display screen will read, LINE ON HOLD.
2. To return to the party on hold, press **(/FLASH** or **⏏**) on a handset or **⏏** on the base. The phone will return to the holding party.

NOTES

- **You can only place a caller on hold for 5 minutes. Once 5 minutes has passed, that party's line will be disconnected and the phone will return to standby.**
- **While a call is on hold, Caller ID and Call Waiting cannot be received.**

Conferencing

If you have more than one handset, up to four people can participate in a conference call. A four-way conference call consists of an outside line, two handsets, and the base speakerphone. You can easily join a call already in progress.

1. Press **(/FLASH** or **⏏**) on the handset or **⏏** on the base to join the call.
2. To hang up, return the handset to the cradle or press **⏏** on the handset or **⏏** on the base. The other party will still be connected to the call.

Beyond the Basics

Beyond the Basics

Using Special Features

Do Not Disturb (All calls)

DND allows you to mute the ringer of all registered handsets and the base. With the phone in standby, press and hold **DND** on the base. You will hear a confirmation tone and the **DND** LED illuminates. To cancel, press **DND** again. You can also mute the ringer tone while the phone is ringing by pressing **DND** on the base.

NOTE

If the answering machine is off, it will automatically turn on when you activate DND. If you turn the answering machine off while DND is on, DND automatically turns off along with the answering machine.

Muting the Ringer (One call only)

While the phone is ringing, press the **MUTE** soft key on the handset or **M/D** on the base to mute the ringer for this call. The phone will ring again normally on the next call. (The handset must be off the cradle to mute the ringer.)

Muting the Microphone

Mute turns off the microphone so the caller cannot hear you. The display shows the **MUTE ON** icon while the microphone is muted.

From the handset

1. While you are on a call, press the **MUTE** soft key or **mute**.
2. **MUTE ON** will appear in the display for 2 seconds, but the  icon will appear and remain in the display until the feature is turned off.
3. To cancel muting, press the **MUTE** soft key or **mute**. **MUTE OFF** appears.

From the base

1. While you are on a call, press the **MUTE** soft key.
2. To cancel muting, press the **MUTE** soft key again.

Beyond the Basics

Beyond the Basics

Making a DirectLink Call

1. To call another handset with DirectLink, press the **DirectLink** soft key.
2. Select the handset you want to call by pressing the number key (0-9). If the handset is out of range or not in DirectLink operation, the display shows OUT OF RANGE. To exit DirectLink, press the **CANCEL** soft key.
3. On the receiving handset, press the **ANSWER** soft key or **[/FLASH**.

Exiting a DirectLink Call

To exit the DirectLink feature and return to standby, press the **CANCEL** soft key and then press the **OK** soft key.

DIRECTLINK MODE CANCEL appears in the display.

Intercom

Making an Intercom Page

You can use the intercom to talk to another station without using the phone line.

1. With the phone in standby, press **INT'COM/HOLD**.
2. Use **▲** or **▼** to select the station you want to talk with, and then press the **OK** soft key. If you select **ALL**, all other registered handsets and base will be paged. An intercom tone sounds. To cancel intercom, press **]** or the **CANCEL** soft key on either handset (or **INT'COM/HOLD** or the **CANCEL** soft key on the base).

Answering an Intercom Page

When the intercom page tone sounds, the display will show the ID of the station that is paging.

Beyond the Basics

Beyond the Basics

NOTES

- This telephone system is not intended to replace an AC powered room monitoring system. The length of time that a handset can monitor a room is limited to the talk time remaining on the handset battery (5 hours or less).
- This feature only works when both handsets are within range of the base.
- If the party is out of range, **UNAVAILABLE** appears in the display and the operation will be canceled.
- While a pair of handsets is in Room Monitoring mode, only the Handsets in monitoring mode can receive incoming calls. To resume normal telephone operation, you should terminate the monitoring session by pressing the **END** soft key on either handset.

Tone Dialing Switch Over

If your telephone company requires pulse dialing, you can switch to tone dialing after the call connects. This feature is useful when you need tone dialing to use automated menu systems, such as telephone bank tellers, telephone prescription refills, customer support menus, etc. If your phone is set to pulse dialing, make your call normally. Once your call connects, press ***/TONE/ <** on the handset. Any digits you enter from then on will be sent as tone dialing. When this call ends, the phone automatically returns to pulse dialing.

Beyond the Basics

Beyond the Basics

Setting Up the Answering Machine

Your phone has a built-in answering machine that answers and records incoming calls. You can also use your answering machine to record a conversation or leave a voice memo.

Features

- Digital Tapeless Recording
- Up to 12 Minutes of Recording Time
- Call Screening
- Personal or Pre-recorded Outgoing Messages
- Day and Time Announcement
- Remote Message Retrieval
- Toll Saver
- Conversation Recording
- Voice Memo
- Message Alert
- Hands Free Speakerphone at Base
- Records Up to 59 messages

Digital Tapeless Recording allows you to quickly review, save, or delete the messages you choose.

You will never have to worry about a tape wearing out, jamming, or resetting improperly.

Beyond the Basics

Using the Answering Machine Interface

Using Handset and Base Menus

You can set up your answering machine's primary features from the base or handset. The menu options of the base have voice prompt.

When the phone is in standby, press the **MENU** soft key and then scroll down and select **ANSW. SETUP**. Press the **OK** soft key. Use **▲** or **▼** to scroll through the answering machine setup menu options. Select the option by pressing the **OK** soft key.

To exit the menu and return to standby, press **)]** on the handset and **▷/□/EXIT** on the base.

Handset operation

You can use your handset to operate your answering machine from anywhere in your home. When the phone is in standby, press the **☒** soft key on the handset to access the answering machine. **REMOTE ANSWERING MACHINE OPERATION** appears on the handset display, and the answering machine announces the time, and number of new and old messages. Keep the following things in mind when you use your handset to access your answering machine:

- You can enter a command at any time during the announcements.
- After the first announcement, you have 30 seconds to enter your first command before the answering machine returns to standby.
- If you receive a call, the remote operation is cancelled.
- During the remote operation **REMOTE ANSWERING MACHINE OPERATION** appears on the base.

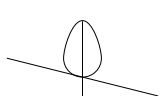
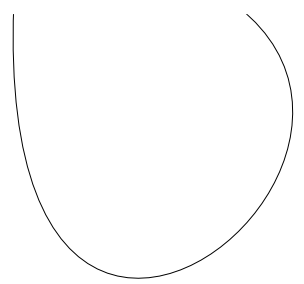
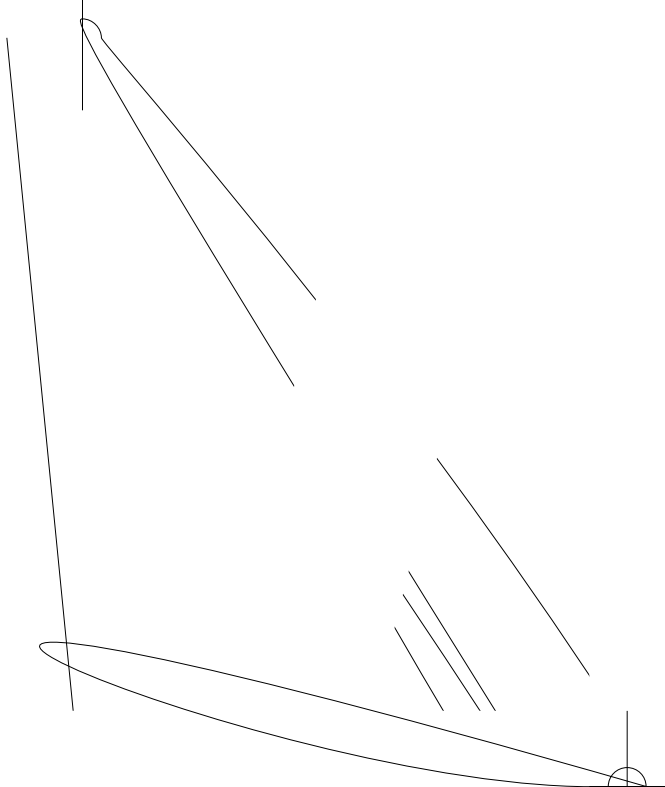

Beyond the Basics

Beyond the Basics

Selecting a Greeting (Base only)

Once you have recorded a personal greeting, the phone automatically switches to your personal greeting. You can also switch back and forth between the pre-recorded greeting and your own greeting at any time.

1. With the phone in standby, press the **MENU** soft key. Select **ANSW. SETUP** menu option, then the **SELECT GREETING** submenu and press the **OK** soft key. The answering machine plays the current greeting.
2. To keep this greeting, do nothing.
3. To switch to the other greeting, press the **CHANGE** soft key while the answering machine is playing the current greeting.
4. Each time you press the **CHANGE** soft key, the answering machine switches between the pre-recorded and the personal greeting. The last greeting you hear is used as the current greeting.

Deleting your Personal Greeting (Base only)

You can delete your personal greeting from the base. You cannot delete the pre-recorded greeting.

1. When the phone is in standby, press the **MENU** soft key. Select **ANSW. SETUP** menu option, then the **SELECT GREETING** submenu and press the **OK** soft key. The answering machine plays the current greeting.
2. While the personal greeting is playing, press the **DELETE** soft key.
3. The answering machine announces "Greeting has been deleted" and automatically switches back to the pre-recorded greeting.

Beyond the Basics

Beyond the Basics

Activating the Message Alert

The Message Alert feature sounds a short alert tone every 15 seconds whenever you have a new message. To turn on the message alert:

1. Press the **MENU** soft key. Select the ANSW. SETUP menu, and then the MESSAGE ALERT submenu.
2. Move the cursor to select ON or OFF.
3. Press the **OK** soft key. You will hear a confirmation tone.

Activating Call Screening

Your phone allows you to listen to callers leaving you a message. This, Call Screen, feature can be turned on or off.

1. Press the **MENU** soft key. Select the ANSW. SETUP menu and then the CALL SCREEN submenu.
2. Move the cursor to select ON or OFF.
3. Press the **OK** soft key. You will hear a confirmation tone.

Setting a Security Code or Personal Identification Number (PIN)

To play your messages from a remote location, you will need to enter a two-digit Personal Identification Number (PIN) or PIN Code.

1. Press the **MENU** soft key. Select the ANSW. SETUP menu, and then the SECURITY CODE submenu.
2. Enter a two-digit security code (01-99) using the number keypad **0-9**.
3. Press the **OK** soft key. You will hear a confirmation tone.

Beyond the Basics

Using the Answering Machine

The message counter on the LCD displays the number of messages stored in memory. If the display flashes, then there are new messages waiting for you that you have not yet listened to. The answering machine plays your new messages first. After you listen to all of your new messages, you can then play your old messages.



NOTE

Time stamp will not be heard until you have set the time.

Turning your Answering Machine On and Off

	From the base	From the handset
Turning On	<ol style="list-style-type: none">1. With the phone in standby, press 6.2. The answering machine announces "Answering System is on" and plays the current greeting.3. The message counter displays the number of messages stored in memory. If the counter flashes, then you have new messages waiting.	<ol style="list-style-type: none">1. With the phone in standby, press the  soft key on the handset. REMOTE ANSWERINGMACHINE OPERATION appears on the handset display, and the answering machine announces the time, and the number of new and old messages.2. Press 6 at any time during the announcement.3. The answering machine announces "Answering System is on" and plays the current greeting message.

Beyond the Basics

	From the base	From the handset
Turning Off	<ol style="list-style-type: none">1. With the phone in standby, press ϕ.2. The phone announces "Answering System is off."3.  appears.	<ol style="list-style-type: none">1. With the phone in standby, press the  soft key on the handset. REMOTE ANSWERING MACHINE OPERATION appears on the handset display, and the answering machine announces the time, and the number of new and old messages.2. Press 9 at any time during the announcement. The answering machine announces "Answering System is off."

Beyond the Basics

Beyond the Basics

	From the base	From the handset
Skipping a message	Press ⏮ or the >>1 soft key to go to the beginning of the next message. Press and hold to fast forward through the current message.	Press >>1/3 to go to the beginning of the next message.
Deleting a message	While a message is playing, press ⏻ or the DELETE soft key to delete it. The message is permanently deleted.	While a message is playing, press ⏻/4 to delete it. The message is permanently deleted.
Deleting all messages	With the phone in standby, press ⏻ to delete all messages. When the answering machine asks you to confirm, press ⏻ again. All messages are permanently deleted.	Not available
Stopping a message review	Press ⏻/⏻/EXIT to stop a message playback and return to standby.	Press ⏻/5 or the STOP soft key to stop a message playback. Press ⏻ to exit the answering machine and return to standby.

Beyond the Basics

NOTES

- You cannot delete unheard messages. If you try to delete messages before listening to them, the answering machine will beep and say "Please playback all messages."
- If you press **K1** or the **⏪** soft key on the base during the first two seconds (or press **⏪/1** on the handset during the first four seconds) of a message, the answering machine goes back to the previous message.

Screening Calls

Your phone allows you to listen to callers leaving a message without answering the phone. You can always hear callers from the base speaker. To screen an incoming call from the handset and base:

From the base	From the handset
<ol style="list-style-type: none">1. After the answering machine answers, the base speaker will let you hear the calls at the machine records the messages.2. To answer the call, press ⏪.3. To mute the call screen, press the MUTE soft key, or ⏻/0/EXIT. To cancel muting, press the SCREEN soft key.	<ol style="list-style-type: none">1. Press the SCREEN soft key when the answering machine is answering. If another station is screening a call, you will hear a beep and you will not be able to screen the call.2. To answer the call, press (/ FLASH.3. To mute the call screen, press the MUTE soft key. To cancel muting press the SCREEN soft key.

Beyond the Basics

Recording a Conversation

You can record a conversation between 2 seconds and 10 minutes long from the handset or the base. These recorded conversations are treated just like regular messages. When the answering machine is full, **Full** will appear on the base LCD and recording will be terminated. You can not record intercom conversations with this feature.

	From the base	From the handset
Starting a recording	<ol style="list-style-type: none">1. During a conversation, press the MENU soft key then select CALL RECORD. Press the OK soft key.2. The LCD will display RECORDING A CALL. A confirmation tone that can be heard by both parties sounds during recording.	<ol style="list-style-type: none">1. During a conversation, press the MENU soft key, and then ▼ or ▲ key to select CALL RECORD. Press the OK soft key.2. RECORDING A CALL appears on the display. A confirmation tone that can be heard by both parties sounds during recording.
Stopping a recording	<ol style="list-style-type: none">1. Press the MENU soft key then select CALL RECORD. Press the OK soft key.2. The LCD will display STOP RECORDING. You will hear a confirmation tone.	<ol style="list-style-type: none">1. Press the MENU soft key, and then ▼ or ▲ key to select CALL RECORD. Press the OK soft key.2. STOP RECORDING appears on the display, and you will hear a confirmation tone.

Beyond the Basics

Beyond the Basics

	From the base	From the handset
Stopping a memo	<ol style="list-style-type: none">1. Press the STOP soft key.2. You hear a confirmation tone, and the answering machine returns to standby.	<ol style="list-style-type: none">1. Press 7.2. You hear a confirmation tone, and the answering machine waits for your next command.3. Press ▶/2 to hear the message you just recorded or ⏏ to exit and return to standby.

Message Alert

The Message Alert feature sounds a short alert tone whenever you have a new message. When a new message is received and Message Alert is on, the alert tone will sound every 15 seconds. Set the Message Alert to on or off by using MENU. To activate the message alert, see page 65 for details.

When all new messages are played back (see page 68), the Message Alert tone will automatically deactivate.

The tone will not deactivate until all new messages are played back. To quickly turn off the Message Alert tone, press any key on the base.

Beyond the Basics

Beyond the Basics

Remote Commands

Command	Function
0 then 1	Repeat a Message*
0 then 2	Playback Messages
0 then 3	Skipping a Message
0 then 4	Deleting a Message
0 then 5	Stop Operation
0 then 6	Answering Machine On
0 then 7	Memo Record/Stop**
0 then 8	Greeting Record/Stop**
0 then 9	Answer Machine Off
1 then 0	Help Guidance

* To Repeat a Message, press **0** then **1** within four seconds to repeat the previous message, or press **0** then **1** after four seconds to repeat the current message.

** For the Memo Record and Greeting Record/Stop, the first time you enter the corresponding command, it starts the Recording. If you want to stop the recording, press **0** then **7**, **8**, or **5**.

1. When you finish, you will hear intermittent beeps indicating that the answering machine is in the command waiting mode. You can enter another command from the chart, or you can hang up to exit the answering machine.
2. When you hang up, the answering machine automatically returns to its normal standby setting.

Beyond the Basics

Beyond the Basics

Common Issues

If your phone is not performing to your expectations, please try these simple steps first.

Symptom	Suggestion
The CHARGE/IN USE LED won't illuminate when the handset is placed in the cradle.	<ul style="list-style-type: none">• Make sure the AC adapter is plugged into the base or the charger (if you have more than one handset) and wall outlet.• Make sure the handset is properly seated in the cradle.• Make sure the charging contacts on the handset are clean.
The audio sounds weak.	<ul style="list-style-type: none">• Move the handset and/or base away from metal objects or appliances and try again.• Make sure that you are not too far from the base.
Can't make or receive calls.	<ul style="list-style-type: none">• Make sure that you are not too far from the base.• Make sure the line is not in use. If an outside call is already using a line, you cannot use that line to make another outside call.• Check both ends of the base telephone line cord.• Make sure the AC adapter is plugged into the base and wall outlet.• Disconnect the AC adapter and reconnect.• Change the Digital Security Code (see page 76).
The handset doesn't ring or receive a page.	<ul style="list-style-type: none">• Make sure that you are not too far from the base.• Charge the battery in the handset for at least 15-20 hours by placing the handset on the base or charging cradle.• Change the Digital Security Code (see page 76).

Beyond the Basics

Symptom	Suggestion
Severe noise interference.	<ul style="list-style-type: none">• Keep the handset away from microwave ovens, computers, remote control toys, wireless microphones, alarm systems, intercoms, room monitors, fluorescent lights, and electrical appliances.• Move to another location or turn off the source of interference.
The Caller ID does not display.	<ul style="list-style-type: none">• The call was placed through a switchboard.• Call your telephone provider to verify your Caller ID service is current. There may be a problem with your Caller ID service.
You cannot register the handset at the base.	<ul style="list-style-type: none">• Charge the battery pack in the handset for 15-20 hours.• Change the Digital Security Code (see page 76).• Make sure you have not stored 10 handsets already.
The handset doesn't communicate with other handsets.	<ul style="list-style-type: none">• Change the Digital Security Code (see page 76).• Make sure that you have registered all handsets.
An extra handset can't join the conversation.	<ul style="list-style-type: none">• Make sure there are not 2 handsets already using the conference feature.• Make sure that another station is not in privacy mode.
The Room Monitor feature does not work.	<ul style="list-style-type: none">• Make sure to place the handset(s) within the range of the base.

Beyond the Basics

Symptom	Suggestion
The answering machine does not work.	<ul style="list-style-type: none">• Make sure the AC Adapter is plugged in.• Make sure that the answering machine is turned on.• Make sure that the message record time is not set to Announce only (see page 64).
Messages are incomplete.	<ul style="list-style-type: none">• The incoming messages may be too long. Remind callers to leave a brief message.• The memory may be full. Delete some or all of the saved messages.
There is no sound on the base or handset speaker during call monitoring or message playback.	<ul style="list-style-type: none">• Adjust the speaker volume on the base or handset.• Make sure the call screen feature is set to on.
Cannot access remote features from another touch-tone phone.	<ul style="list-style-type: none">• Make sure you are using the correct PIN number.• Make sure that the touch-tone phone you are using can transmit the tone for at least two seconds. If it cannot, you may have to use another phone to access your phone.
Time stamp cannot be heard.	<ul style="list-style-type: none">• Make sure you have set the time (see "<i>Setting the Day and Time</i>" on page 29).

If you still have problems, disconnect the phone. If other phones on the same line work properly, the fault is in this phone or its installation. If you cannot find the problem, take the phone to your local RadioShack store for assistance.

Beyond the Basics

Care

Keep the phone dry; if it gets wet, wipe it dry immediately. Use and store the phone only in “room” temperature environments. Handle the phone carefully; do not drop it. Keep the phone away from dust and dirt, and wipe it with a damp cloth occasionally to keep it looking new.

Service and Repair

If your phone is not performing as it should, take it to your local **RadioShack** store for assistance. To locate your nearest **RadioShack** store, use the store locator feature on **RadioShack**'s website (www.radioshack.com), or call 1-800-The Shack (843-7422) and follow the menu options. Modifying or tampering with the phone's internal components can cause a malfunction and might invalidate its warranty and void your FCC authorization to operate it.

Appendix: Handset-Base Registration

When you register the handset with the base, unique data is written on **both** the base and the handset. The handset registered to one base unit cannot be used with another base unit unless the registration data is “de-registered” with the original base unit. This means the handset must be within the range of the original base unit to de-register. If for any reason the original base unit is not within the range (or the registration data in the original base unit is erased), “OUT OF RANGE” error takes place and you cannot de-register the handset.

Should you encounter this trouble, follow these steps to de-register the handset and register to another base.

and the sa

e. The hand

connect the A

e base, and th

wait until the C

data on the base, n

able v
ding a

take your base and
) if you have) to your

ntire syst m
ep your registra

y handset if used) so we

Beyond the Basics

Glossary

Accessory Handset — This phone system is expandable: one base supports a total of ten handsets. The accessory handset is a handset that is compatible with this model.

Base — The main part of the phone that connects to your phone line.

CID — Caller ID is available from your telephone provider and it is offered to users on a subscription basis. With this service, you can see the name and number of incoming callers.

CIDCW — Caller ID on Call Waiting is available from your telephone provider and it is offered to users on a subscription basis. With this service, you can see incoming caller information while on another call.

CW Deluxe or Call Waiting Deluxe — Call Waiting Deluxe is available from your telephone provider and it is offered to users on a subscription basis. With this service and while on an existing phone call, you can use additional menu options when a new caller rings you.

DirectLink™ — If you have accessory handsets on your system, you can use two handsets as 2-way radios.

Global Settings — Global Settings apply to all registered handsets. If you change something under the global menu, you change it for all registered handsets. Only one handset can change global settings at a time, and you have to make sure the phone is not currently being used.

Standby — The handset is not in use. No line has been activated. No dial tone is present.

Station — Any handset or base.

Talk — A telephone line has been activated on the handset, enabling a dial tone.

Index

Index

A

Accessory handsets	31
Animation screen	30
Answering a call	42
Answering machine	59
Message alert	65
Reviewing messages	68
Screening calls	65
Setting up	59
Turning on and off	66
When away from home	74
Any key answer	40
Area code	58
Auto talk	40

B

Banner	38
Battery	18
Belt clip	20

C

Caller ID	44
CIDCW (Caller ID on Call Waiting)	29, 44
CWDX (Call Waiting Deluxe)	29, 46
Deleting Caller ID numbers	46
Making a call from a record	45
Storing a record in the phonebook	36
Using the list	45
Call waiting	44
Chain dialing	43
Conference call	51
Controls & Functions	12

D

Day and time	29
Dial mode	28
DirectLink	54
Displays and icons	21
Distinctive ring	40

E

Earpiece volume	49
Entering text	27

F

FCC statement	8
Finding handsets	50
Four way function key	25

G

Greeting	61
Deleting	63
Recording	62
Selecting	63

H

Hanging up	42
Headset	20
Hold	51

I

Important safety instructions	10
Installation	14
Intercom	55

K

Key touch tone	30
----------------	----

L

Language	28
For answering machine	61
For display	28
LCD contrast	30
Low battery alert	19

Index

M		Tone	39
Making a call	41	Volume	49
Message alert	65	Room monitor	56
Muting the microphone	53	S	
Muting the ringer	53	Screening calls	70
O		Security code	76
Out of range	58	Seven-digit dialing	58
P		Soft key	24
Personal identification		Speaker volume	49
number (PIN)	65	Speed dial	43
Phonebook	33	T	
Copying entries	37	T-Coil	49
Creating a new entry	33	Tone dialing switch over	57
Deleting entries	36	Transferring a call	52
Editing an entry	35	Traveling out of range	58
Finding an entry	35	W	
Making a call from the		Warranty	88
phonebook	43		
Storing a Caller ID			
record	36		
Storing a redial number	36		
Privacy mode	54		
R			
Recording a call	71		
Recording a voice memo	72		
Redial	48		
Deleting a record	48		
Making a call			
from a record	48		
Storing a record in			
the phonebook	36		
Using the list	44		
Registering handset	31, 80		
Remote operation	74		
Resetting handsets	32		
Ringer			
Distinctive ring	40		

Memo

Memo

Memo

Memo

Memo

RadioShack.

Limited One-Year Warranty

This product is warranted by **RadioShack** against manufacturing defects in material and workmanship under normal use for one (1) year from the date of purchase from **RadioShack** company-owned stores and authorized **RadioShack** franchisees and dealers. EXCEPT AS PROVIDED HEREIN, **RadioShack** MAKES NO EXPRESS WARRANTIES AND ANY IMPLIED WARRANTIES, INCLUDING THOSE OF MERCHANTABILITY AND FITNESS FOR A PARTICULAR PURPOSE, ARE LIMITED IN DURATION TO THE DURATION OF THE WRITTEN LIMITED WARRANTIES CONTAINED HEREIN. EXCEPT AS PROVIDED HEREIN, **RadioShack** SHALL HAVE NO LIABILITY OR RESPONSIBILITY TO CUSTOMER OR ANY OTHER PERSON OR ENTITY WITH RESPECT TO ANY LIABILITY, LOSS OR DAMAGE CAUSED DIRECTLY OR INDIRECTLY BY USE OR PERFORMANCE OF THE PRODUCT OR ARISING OUT OF ANY BREACH OF THIS WARRANTY, INCLUDING, BUT NOT LIMITED TO, ANY DAMAGES RESULTING FROM INCONVENIENCE, LOSS OF TIME, DATA, PROPERTY, REVENUE, OR PROFIT OR ANY INDIRECT, SPECIAL, INCIDENTAL, OR CONSEQUENTIAL DAMAGES, EVEN IF **RadioShack** HAS BEEN ADVISED OF THE POSSIBILITY OF SUCH DAMAGES.

Some states do not allow limitations on how long an implied warranty lasts or the exclusion or limitation of incidental or consequential damages, so the above limitations or exclusions may not apply to you. In the event of a product defect during the warranty period, take the product and the **RadioShack** sales receipt as proof of purchase date to any **RadioShack** store. **RadioShack** will, at its option, unless otherwise provided by law: (a) correct the defect by product repair without charge for parts and labor; (b) replace the product with one of the same or similar design; or (c) refund the purchase price. All replaced parts and products, and products on which a refund is made, become the property of **RadioShack**. New or reconditioned parts and products may be used in the performance of warranty service. Repaired or replaced parts and products are warranted for the remainder of the original warranty period. You will be charged for repair or replacement of the product made after the expiration of the warranty period. This warranty does not cover: (a) damage or failure caused by or attributable to acts of God, abuse, accident, misuse, improper or abnormal usage, failure to follow instructions, improper installation or maintenance, alteration, lightning or other incidence of excess voltage or current; (b) any repairs other than those provided by a **RadioShack** Authorized Service Facility; (c) consumables such as fuses or batteries; (d) cosmetic damage; (e) transportation, shipping or insurance costs; or (f) costs of product removal, installation, set-up service adjustment or reinstallation.

This warranty gives you specific legal rights, and you may also have other rights which vary from state to state.

RadioShack Customer Relations, 300 RadioShack Circle, Fort Worth, TX 76102-1964

UPZZ01846BZ(0)

43-142

04A07

Printed in China

©2007. **RadioShack** Corporation.

All rights reserved. **RadioShack** and **RadioShack.com** are trademarks used by **RadioShack** Corporation.

DirectLink is a registered trademark of Uniden Corporation.

Free Manuals Download Website

<http://myh66.com>

<http://usermanuals.us>

<http://www.somanuals.com>

<http://www.4manuals.cc>

<http://www.manual-lib.com>

<http://www.404manual.com>

<http://www.luxmanual.com>

<http://aubethermostatmanual.com>

Golf course search by state

<http://golfingnear.com>

Email search by domain

<http://emailbydomain.com>

Auto manuals search

<http://auto.somanuals.com>

TV manuals search

<http://tv.somanuals.com>