



Cat. No. 21-1588

OWNER'S MANUAL

Please read before using this equipment.

TRC-401

Portable Emergency CB Radio



RadioShack®

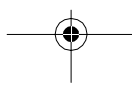

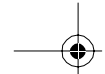

FEATURES

Your RadioShack TRC-401 Emergency CB Radio is a 40-channel citizen's band radio that is specially designed for emergency situations. It contains a CB, an antenna, and a power cord — all in a handy, impact-resistant carrying case that lets you store all of the equipment safely out of the way and easily move it from one vehicle to another.

Its features include:

Automatic Emergency Channel 9 Selection — immediately switches to Channel 9 (the universal emergency channel) each time the CB is turned on.

Important: REACT is a nationwide 24-hour network that monitors Channel 9. Switch to Channel 9 in an emergency, and report the problem. (REACT might not be available in all areas.)

Channel 19 Switch — immediately switches the CB to Channel 19, used by most travelers.

PLL (Phase-Locked Loop) Frequency Synthesizer — provides reliable and exact tuning.

Auto Squelch — eliminates the need to set the squelch level.

Digital Channel-Number Display — makes it easy to see which channel is selected.

Built-In Ceramic Filters — provide superior selectivity and prevent adjacent-channel interference.

Built-In Modulation Control — prevents the transmitter signal from over-modulating and distorting.

Built-In Automatic Noise Limiter (ANL) — reduces noise caused by nearby electrical equipment, such as motors or automotive ignition systems.

Impact-Resistant Storage Case — stores everything you need to power the CB from your vehicle.

Note: The TRC-401 comes with a telescoping antenna on a magnet-mount base that you can attach directly to the CB for use when your vehicle is not moving. If you plan to use the CB when your vehicle is moving, we recommend that you purchase a standard mount antenna.

We recommend you record the TRC-401's serial number here. The number is on the CB's back panel.

Serial Number: _____

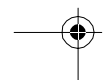
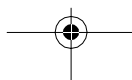



FCC INFORMATION

The Federal Communications Commission (FCC) does not require you to have a license to operate this CB. However, the FCC does require you to read and know Part 95 of *FCC Rules*. These rules apply to the operation of a Class D CB. We have provided a copy of these regulations with your CB.

Warning: Do not open your CB to make any internal adjustments. Internal adjustments can be made only by authorized service personnel.

Internal adjustments and/or modifications can lead to illegal operation as defined by Part 95 of *FCC Rules*. Such illegal operation can lead to very serious consequences.

To be safe and sure:

- Never open your CB's case.
- Never modify your CB.

Your CB might cause TV or radio interference even when it is operating properly. To determine if your CB is causing the interference, turn off your CB. If the interference goes away, your CB is causing it. Try to eliminate the interference by:

- Moving your CB away from the receiver
- Contacting your local RadioShack store for help

If you cannot eliminate the interference, the FCC requires that you stop using your CB.

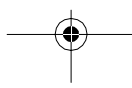

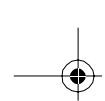

CONTENTS

Preparation	5
Attaching the Antenna	5
Connecting Power	6
Operation	7
CB Operation Tips	8
CB Courtesy	8
Maximum Range	8
Using Common 10-Codes	9
Common Uses for a CB Radio	10
Business Uses	10
Personal Uses	10
Troubleshooting	11
Reducing Noise	12
Care and Maintenance	13
Replacing the Power Cord's Fuse	14
Specifications	15

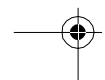
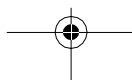
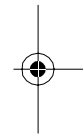
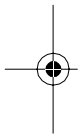

PREPARATION

ATTACHING THE ANTENNA

The supplied magnet-mount antenna is designed for use only in emergency or low speed, short-driving situations. If you want to use the CB while driving your vehicle at highway speeds, on long-distance trips, or during periods of high, gusty winds or heavy turbulence, you need an optional standard-mount antenna (available at your local RadioShack store). If you use a standard-mount antenna, you also need a plug adapter (Cat. No. 278-208) to connect the standard antenna's PL-259 plug to **ANT** on your CB.

Follow these steps to mount the supplied antenna.

1. Hold the antenna in an upright position and extend the antenna.

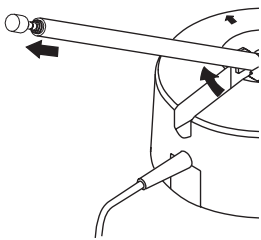

Note: Fully extend the antenna for maximum range.

2. While your vehicle is stopped, place the base as near as possible to the center of your vehicle's highest flat surface with ↓ pointing toward the front of your vehicle. (Do not remove the me-

tallic backing on the bottom of the magnetic base.)

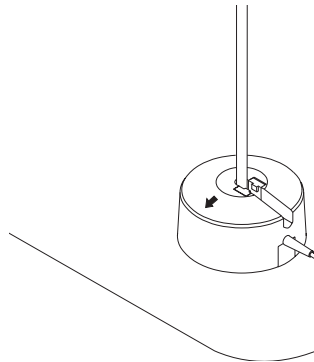

Notes:

- The base should have full surface contact with steel for the best possible range.
 - To reduce wind force, place the base toward the back window.
3. Plug the magnetic base's wire into the CB's **ANT** jack.

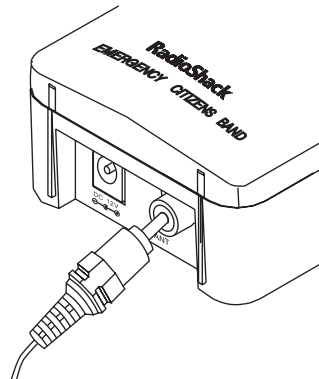



To remove the antenna from your vehicle, grasp the base and then firmly “peel” it up and off the vehicle’s surface.

Caution: Never slide the antenna’s magnetic base across your vehicle’s painted surface. Dust and dirt particles might scratch your vehicle’s finish.

Notes:

- If the CB does not operate properly, check that the lighter socket is clean and free of ashes or other debris.
- If the CB still does not work, check the fuse in the power cord (see “Replacing the Power Cord’s Fuse” on Page 14).

CONNECTING POWER

Follow these steps to power the CB from your vehicle’s battery.

1. Plug the barrel plug of the supplied power cord into **DC 12V** on the bottom of the CB.

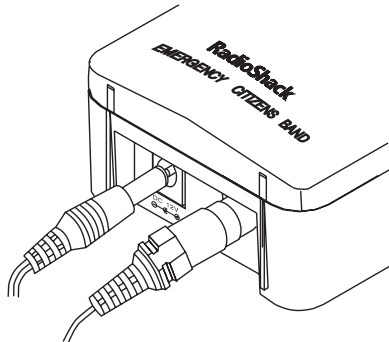

2. Ensure the cigarette-lighter plug cap is tightly screwed onto the plug and insert the plug into the cigarette-lighter socket.

OPERATION

Before you start using your CB, we recommend you read "CB Operation Tips" on Page 8 which contains information that will help you use your CB effectively and courteously.

Note: Before you operate the CB, be sure it is connected to power and an antenna.

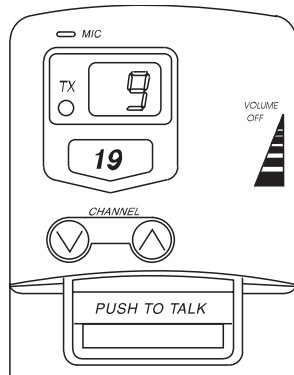

1. Turn **VOLUME** clockwise until it clicks to turn on the CB. The CB automatically tunes to Channel 9, the emergency channel.
2. Select another channel, if desired.
 - To immediately select Channel 19, press **19**. Channel 19 is another channel used for emergencies and traveler assistance.
 - To select any other channel, repeatedly press (or hold down) **CHANNEL** \wedge or \vee .

The display shows the channel number.

3. To transmit, hold the CB 2–3 inches from your mouth, hold down **PUSH TO TALK**, and speak directly into **MIC** (the built-in microphone). The TX (transmit) indicator lights.

In an emergency, broadcast your "CLIP":

Call sign — identify yourself

Location — be exact

Injuries — number of injured, type of injuries, and so on

Problem — give complete details. Give information calmly, clearly, and in as few words as possible

For example, "This is John Smith at Highway 80 and Alameda Street. There is a two-car accident here with three injured adults needing emergency care. Please send an ambulance."

4. When you finish transmitting, release **PUSH TO TALK**. You now hear other transmissions on that channel (such as the response to your call). Adjust **VOLUME** to the desired listening level.

Note: **VOLUME** only affects what you hear. It has no effect on transmissions.

5. To turn off the CB, turn **VOLUME** counterclockwise until it clicks.



CB OPERATION TIPS

Like most activities, CB radio use has its customs and courtesies. Although this CB radio is designed for emergency use, it does work on all 40 CB channels and can be used for more than just emergencies. The following tips will help you get the most benefit and satisfaction from your CB.

CB COURTESY

- Wait for a pause in someone else's transmission before you ask for a break.
- If you do not receive an answer to your call after a second attempt, sign off and wait several minutes before trying again.
- Do not hold down **PUSH TO TALK** when you are not talking. (This is called *dead keying*.)
- Assist callers with directions, road conditions, and any other reasonable requests.

MAXIMUM RANGE

The maximum range and quality of CB transmissions vary depending on these conditions:

- The type and quality of antenna used
- The height of the antenna's mounting location — the higher the antenna, the better the signal's range
- The surrounding terrain — mountains and tall buildings limit the range
- Weather conditions
- The number of nearby CBs operating on the same channel
- Standing Wave Ratio (SWR) between the antenna and the CB

You can check the SWR between the CB and a mobile antenna using an SWR meter (Cat. No. 21-523). Follow the instructions supplied with the SWR meter and the mobile antenna to change the SWR, if necessary.

Note: You cannot adjust the SWR of the supplied antenna.

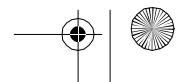
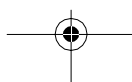

USING COMMON 10-CODES

Citizen's band operators have largely adopted the 10-codes for standard questions and answers. Their use permits faster communication and helps prevent misunderstanding in noisy areas.

This table lists the codes adopted by the Associated Public Safety Communications Officers (APCO).

Code	Meaning
10-1	Cannot understand your message.
10-2	Your signal is good.
10-3	Stop transmitting.
10-4	Message received and understood.
10-5	Relay information to _____.
10-6	I am busy.
10-7	Out of service.
10-8	In service.
10-9	Repeat last message.
10-10	Negative (No).
10-11	_____ in service.
10-12	Stand by.

Code	Meaning
10-13	Report _____ conditions.
10-14	Information.
10-15	Message delivered.
10-16	Reply to message.
10-17	En route.
10-18	Urgent.
10-19	Contact _____.
10-20	My location is _____.
10-21	Call ____ by telephone.
10-22	Cancel last message.
10-23	Arrived at the scene.
10-24	Assignment complete.
10-26	Estimated time of arrival is _____.
10-30	Use caution.
10-31	Pick up.
10-33	Emergency traffic. Clear the channel.
10-34	The time is _____.

Note: Although this table lists the 10-codes' meanings in the form of a statement, they can also be phrased as questions (10-6: Are you busy?, 10-20: What is your location?).



COMMON USES FOR A CB RADIO

Business Uses

- Truck drivers and delivery personnel can learn road and traffic conditions and get assistance in locating destinations. A CB is also good company on those “long hauls.”
- On construction crews, a CB quickly pays for itself when you are calling for additional materials or coordinating the activities of different work crews.
- For security officers, a CB is more than a convenience — it is a must for both safety and efficiency.

Personal Uses

- Keep in touch with home while driving to work, to the store, or to a social activity. Let your family know you are tied up in traffic or that you will stop by the store on the way home.
- If you are a two-car (or more) family, CBs are great for communicating with family members while they are in their cars.
- Contact friends or neighbors — find out “what’s happening” or plan a get-together.
- Ever have car trouble or run out of gas on the highway? What a relief it is to be able to radio for assistance!
- Camping, fishing, and other sports are more fun with a CB. Locate a buddy or find out “what’s cooking” back at camp.



TROUBLESHOOTING



With proper care and handling, your CB should give you years of trouble-free service. However, if your CB is not working properly, follow these suggestions to see if you can eliminate the problem. If you still have a problem, take the CB to your local RadioShack store for assistance.

Problem	Suggestion
Not transmitting well.	Fully press PUSH TO TALK .
	Secure the antenna connection.
	Fully extend the antenna.
Not receiving well.	Secure the antenna connection.
	Fully extend the antenna.
Distorted or unclear sound.	This may be caused by SSB (single side band) transmissions on your channel. Try another channel. (Common SSB channels are Channels 16 and 36–40.)
CB does not operate at all.	Turn VOLUME clockwise to turn on the CB.
	Check the power connection.
	Replace the blown fuse in the power cord. See "Replacing the Power Cord's Fuse" on Page 14.

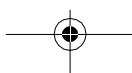



REDUCING NOISE

Because your CB is exceptionally quiet, any noise you hear is probably from an external source in your vehicle — the ignition, another radio, spark plugs, and so forth.

You can determine the source of the noise by turning off the engine and operating the CB with the ignition set to ACC. If most or all of the noise goes away, the problem is in your vehicle's ignition or electrical system. Here are a few hints to help you reduce or eliminate such noise:

- Do not route the power cord next to the antenna wire.
- Be sure the antenna's magnetic base is securely attached to a metallic surface. If you use an antenna other than the magnet-mount type, be sure that the vehicle battery's ground connection is secure.
- Try replacing old ignition wires with new, high-voltage, noise-suppression ignition wires.
- Install noise suppressors on your spark plugs or install spark plugs that have built-in suppressors.

- If problems persist, check your alternator/generator and regulator gauges. Noise from these sources can be reduced or eliminated using bypass capacitors at the various voltage points.

Note: Your local RadioShack store has a wide selection of noise-suppression equipment.



CARE AND MAINTENANCE



Your TRC-401 Emergency CB Radio is an example of superior design and craftsmanship. The following suggestions will help you care for your TRC-401 so you can enjoy it for years.



Keep the TRC-401 dry. If it gets wet, wipe it dry immediately. Liquids might contain minerals that can corrode the electronic circuits.



Handle the TRC-401 gently and carefully. Dropping it can damage circuit boards and cases and can cause the TRC-401 to work improperly.



Keep the TRC-401 away from dust and dirt, which can cause premature wear of parts.



Wipe the TRC-401 with a damp cloth occasionally to keep it looking new. Do not use harsh chemicals, cleaning solvents, or strong detergents to clean the TRC-401.

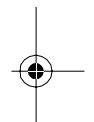
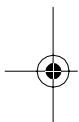

Modifying or tampering with the TRC-401's internal components can cause a malfunction and might invalidate your TRC-401's warranty and void your FCC authorization to operate it. If your TRC-401 is not performing as it should, take it to your local RadioShack store for assistance.

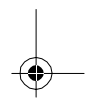
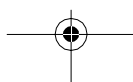
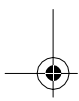

REPLACING THE POWER CORD'S FUSE

The power cord's 2-amp fuse helps protect your CB from power surges and short circuits. If the fuse is blown, replace it with a 2-amp, 250-volt, fast-acting fuse (Cat. No. 270-1052).

Follow these steps to replace the fuse.

1. Unplug the power cord from the vehicle's cigarette lighter and the CB.
2. To open the cigarette-lighter plug and remove the fuse, turn the cap counterclockwise and remove it. (Take care not to lose the tip.)

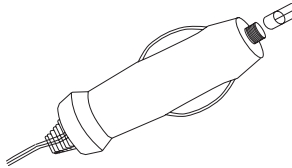

3. If the fuse is blown, replace it.

Caution: Make sure you replace the fuse only with another fuse of the same type and rating.

4. To close the cigarette-lighter plug, replace the cap and turn it clockwise.

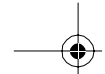

SPECIFICATIONS



Receiver

Frequency Coverage	26.965–27.405 MHz (all 40 channels)
Sensitivity (Maximum)	0.5 μ V for 10 dB (S+N)/N
Adjacent Channel Rejection (EIA-204).....	45 dB
Squelch Sensitivity	0.25–1 μ V
Audio Output	400 Milliwatts (10% THD)
Current Drain	130–600 mA
Minimum Volume Audio Output	10 Milliwatts
Frequency Response (–6 dB)	450–2500 Hz
Cross Modulation	50 dB

Transmitter

Frequency Coverage	26.965–27.405 MHz (all 40 channels)
Power Input (at 12 V DC)	5 Watts
Power Output (at 12 V DC)	2.5 Watts
Spurious Emission	60 dB or Better
Type of Modulation	A3
Modulation Capacity	80–90%
Frequency Tolerance	0.002%
Antenna Impedance	50 Ohms
Antenna Length	34.6 Inches (880 mm)
Current Drain	450–1200 mA

General

Weight	9.9 oz (280 g)
Dimensions (HWD)	7 $\frac{1}{2}$ $\frac{1}{2}$ $\frac{1}{16}$ Inches (178 $\frac{1}{2}$ 64 $\frac{1}{16}$ 36 mm)

Specifications are typical; individual units might vary. Specifications are subject to change and improvement without notice.

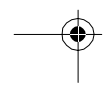
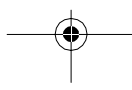



Limited Ninety-Day Warranty

This product is warranted by RadioShack against manufacturing defects in material and workmanship under normal use for ninety (90) days from the date of purchase from RadioShack company-owned stores and authorized RadioShack franchisees and dealers. EXCEPT AS PROVIDED HEREIN, RadioShack MAKES NO EXPRESS WARRANTIES AND ANY IMPLIED WARRANTIES, INCLUDING THOSE OF MERCHANTABILITY AND FITNESS FOR A PARTICULAR PURPOSE, ARE LIMITED IN DURATION TO THE DURATION OF THE WRITTEN LIMITED WARRANTIES CONTAINED HEREIN. EXCEPT AS PROVIDED HEREIN, RadioShack SHALL HAVE NO LIABILITY OR RESPONSIBILITY TO CUSTOMER OR ANY OTHER PERSON OR ENTITY WITH RESPECT TO ANY LIABILITY, LOSS OR DAMAGE CAUSED DIRECTLY OR INDIRECTLY BY USE OR PERFORMANCE OF THE PRODUCT OR ARISING OUT OF ANY BREACH OF THIS WARRANTY, INCLUDING, BUT NOT LIMITED TO, ANY DAMAGES RESULTING FROM INCONVENIENCE, LOSS OF TIME, DATA, PROPERTY, REVENUE, OR PROFIT OR ANY INDIRECT, SPECIAL, INCIDENTAL, OR CONSEQUENTIAL DAMAGES, EVEN IF RadioShack HAS BEEN ADVISED OF THE POSSIBILITY OF SUCH DAMAGES.

Some states do not allow the limitations on how long an implied warranty lasts or the exclusion of incidental or consequential damages, so the above limitations or exclusions may not apply to you.

In the event of a product defect during the warranty period, take the product and the RadioShack sales receipt as proof of purchase date to any RadioShack store. RadioShack will, at its option, unless otherwise provided by law: (a) correct the defect by product repair without charge for parts and labor; (b) replace the product with one of the same or similar design; or (c) refund the purchase price. All replaced parts and products, and products on which a refund is made, become the property of RadioShack. New or reconditioned parts and products may be used in the performance of warranty service. Repaired or replaced parts and products are warranted for the remainder of the original warranty period. You will be charged for repair or replacement of the product made after the expiration of the warranty period.

This warranty does not cover: (a) damage or failure caused by or attributable to acts of God, abuse, accident, misuse, improper or abnormal usage, failure to follow instructions, improper installation or maintenance, alteration, lightning or other incidence of excess voltage or current; (b) any repairs other than those provided by a RadioShack Authorized Service Facility; (c) consumables such as fuses or batteries; (d) cosmetic damage; (e) transportation, shipping or insurance costs; or (f) costs of product removal, installation, set-up service adjustment or reinstallation.

This warranty gives you specific legal rights, and you may also have other rights which vary from state to state.

RadioShack Customer Relations, Dept. W, 100 Throckmorton St., Suite 600, Fort Worth, TX 76102

We Service What We Sell

3/97

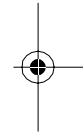
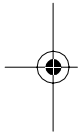

RadioShack
A Division of Tandy Corporation
Fort Worth, Texas 76102

811080920B
 Printed in Hong Kong

4A8

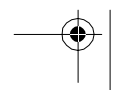
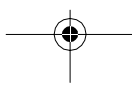

Free Manuals Download Website

<http://myh66.com>

<http://usermanuals.us>

<http://www.somanuals.com>

<http://www.4manuals.cc>

<http://www.manual-lib.com>

<http://www.404manual.com>

<http://www.luxmanual.com>

<http://aubethermostatmanual.com>

Golf course search by state

<http://golfingnear.com>

Email search by domain

<http://emailbydomain.com>

Auto manuals search

<http://auto.somanuals.com>

TV manuals search

<http://tv.somanuals.com>