

AROBOT

*Mobile Robot
For Hobbyist, Research and
Education*

Assembly and User Guide

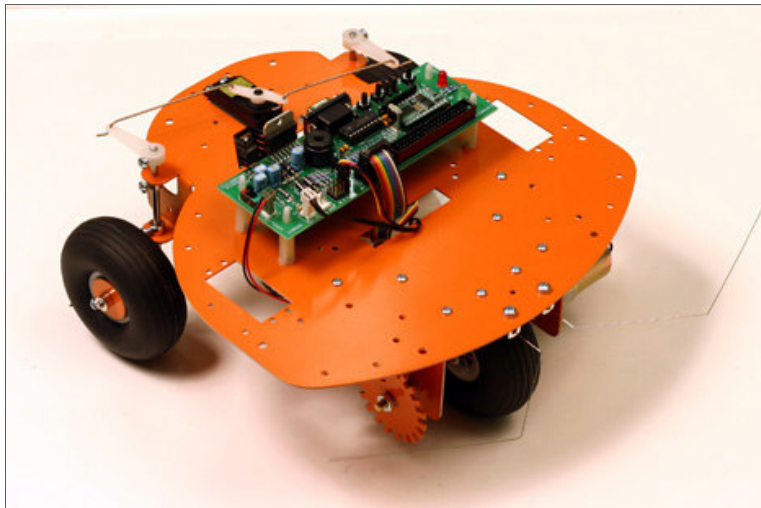

Copyright (c) 2005 Arrick Robotics
All Rights Reserved



Robotics.com

A Robot Mobile Robot

Revision D
11/17/2005

Table of Contents

Introduction

Introduction.....	1
About A Robot.....	1
What You'll Need.....	2
Feature List.....	2
Specifications.....	3
Precautions.....	4
Component Locator.....	5
Glossary of Terms.....	6

Assembly

Assembly Overview.....	9
Parts.....	10
Painting.....	13
Whiskers.....	14
Drive Motor and Brackets.....	16
Encoder Sensor.....	17
Front Wheel Assembly.....	18
Steering Motor and Rear Wheels.....	19
Controller Board.....	21
Battery Pack.....	22
Body Cable.....	23
Finishing Up.....	24

Usage

About the Controller.....	25
Basic Stamp II Installation.....	25
Cable to your PC.....	26
PC Editor/Downloader.....	26
The Test Program.....	27
Steering Straightening Steering.....	27
Wander Program.....	27
Controller Schematic.....	28
Batteries.....	29
Power On/Off Switch.....	29
Reset Button.....	29
Whiskers.....	30
Speaker.....	30
LED Indicators.....	30
Push Buttons and Jumpers.....	31
Drive Motor and Encoder.....	31
Steering Motor.....	32
Coprocessor Command Summary.....	33
Hexadecimal, Binary, Bytes, Words.....	35

Table of Contents Continued

Connectors

Battery Connector	36
Body Connector	36
Serial Port Connector	36
RC Servo Motor Connectors.....	37
DC Motor Connector	37
Powerful Output Connector	37

Expansion

Expansion Connector	38
User RC Servo Motors.....	38
Expansion Circuit Examples.....	39
Coprocessor Network Expansion.....	42
Using Other Controllers	43

Additional Information

Suggested Reading.....	44
Component/Accessory Suppliers	45
Internet Robot Resources	47
Troubleshooting	49
Warranty Information	50

ARobot Project Database – www.robotics.com/arobot/projects.html

ARobot FAQ – www.robotics.com/arobot/faq.html

Introduction

Congratulations for purchasing the ARobot mobile robot. This manual should answer all of your questions. We suggest that you read and understand all of it before using your new robot. If you have any questions, please view our web site at www.robotics.com/arobot

The software provided is designed for use with IBM-style personal computers. This manual assumes the user has full understanding of how to use their computer and operating system. Refer to the documentation for the computer for additional information.

ARobot is designed for the beginning robot hobbyist, but if it looks beyond your skill level, please return the unit before going any further.

Parents: If you're buying ARobot for a young person, be prepared to help them.

About ARobot

The ARobot (pronounced "A robot") is a computer controlled mobile robot designed for hobbyists and educators. Ages 16 and up (younger if helped by an adult) can enjoy unlimited experimentation by programming the on-board Basic Stamp II control computer. Learn and use concepts such as computer programming, motion control, sensor reading, path planning, object avoidance, and more. Easily assembled in a few hours using common hand tools (no soldering required). Connect ARobot to your personal computer for programming and begin your adventure.

Basic Stamp II Control Computer

The Basic Stamp II is a small, self-contained computer controller manufactured by Parallax Inc. This easy-to-use system is programmed using a Basic-like language called PBasic. Programs are written on an IBM-style PC then downloaded to the Basic Stamp II for execution. Large libraries of programs can be created and saved. ARobot's controller board accepts the Basic Stamp II (purchased separately) which controls motors, LEDs, buzzer, and other devices. The Parallax Web site at www.parallaxinc.com provides complete information about the Basic Stamp II including the programming manual.

ARobot is a versatile system that can perform a variety of tasks. Here are just a few examples:

- Hobby robotics projects.
- Education and training.
- Research in artificial intelligence, A-life, etc.
- Science projects.
- Testing platform for navigation algorithms.
- Simulation of planetary exploration.
- Maze solving.
- Contests.
- Publicity.
- Fun, Fun, Fun!

What You'll Need

To build and program ARobot you will need the following items:

- Common hand tools – screwdriver, pliers, etc.
- Your choice of spray paint (optional).
- Basic Stamp II computer chip.
- Basic Stamp II programming information – available free on the Internet or you can purchase a book.
- Understanding of Basic programming or a willingness to learn.
- IBM style PC running DOS or Windows, 3-1/2" disk drive, unused serial port (9 pin connector).
- Internet access for technical support and application notes.
- 8 AA batteries. (over 5 hours of continuous run time).
- A never-ending desire to experiment and play with robots!

Note: Expansion may require knowledge of electronics, soldering and other advanced skills.

Feature List

The following list of features will help you get acquainted with ARobot.

- Safe, low voltage system.
- Dimensions: 10" x 10", 5" tall, 2-1/4 lbs. Whiskers extend beyond these dimensions.
- High quality machined aluminum frame (no plastic or wood).
- Dual front whisker sensors.
- Maximum speed: 10" per second.
- Surfaces: Low pile carpet, tile, concrete, moderate bumps and inclines.
- 1 pound payload capacity for radio data link, embedded PC, accessories.
- Removable battery pack uses 8 standard AA-cells or rechargeables.
- 5 hour or longer typical run time.
- Socket accepts the popular Basic Stamp II controller.
- Controllable Red and Green LEDs.
- Sound output transducer.
- Two user defined push button switches.
- Two user defined jumper switches.
- Rear wheel steering RC servo motor.
- Front wheel DC gear drive motor.
- Optical wheel encoder for distance measurement.
- Second H-bridge for motor or power device control.
- 3 User defined RC servo motor control ports.
- Serial communications port.
- Program using a desktop PC then download for autonomous operation.
- Expansion port allows unlimited possibilities.
- Mounting holes for Radio Shack Breadboard or perfboard.
- Coprocessor network allows multiple processors to communicate and distribute tasks.
- Application notes for sonar range finding, head light, light sensors, compass, and more.

Technical Specifications

- Body: .062 aluminum - cut, punched, and formed.
- Configuration: 3-wheel, front wheel drive, rear wheel steer.
- Dimensions: 10" x 10", 5" tall, 2-1/4 lbs.
- Payload capacity: 1 lbs.
- Wheel size: 3.25" diameter.
- Drive Motor: 12 volt DC gear motor, 74 full load RPM, 1.6 amp full load current.
- Quality machined wheel coupling and bearings.
- Optical wheel encoder for distance measurement
- Encoder: 20 counts per revolution - 2 per inch of travel (1/2" resolution).
- Motor driver: H bridge - 1 amp max.
- Speed control: Pulse Width Modulation.
- Controller PCB size: 2.1" x 6"
- Steering Motor: Standard size RC servo motor.
- Power source: 8-AA cells in removable pack.
- Runs on 8 AA-cell batteries for 5 hours or more.
- Current draw: 50ma at standstill, 200ma with motor running typical.
- Coprocessor: PIC16F84 for motor control.
- Expansion connector - 40 pin (2x20) IDC .1 centers.

Precautions

The following precautions must be taken to insure trouble free operation of ARobot. The order that these precautions are listed does not indicate their importance. Failure to observe these precautions may result in loss of life, damage of property and/or damage to the Robot.

- Never attach or remove cables while power is applied to the Robot.
- Never use the robot in areas near water such as swimming pools.
- Never allow the whisker wires to be inserted into electrical outlets or other dangerous places.
- Never use the robot in areas that could result in a fall such as lofts, stairways, hills.
- Never allow cables to fall out or to be broken by the robot's motion.
- Never control devices with the robot that could be dangerous to life or property such as lawn mowers or high power lasers.
- Never connect the robot's controller to inappropriate equipment.
- Never use the robot in situations where a programming error or other malfunctions could cause damage to property or life.
- Never exceed the specifications such as payload, incline, current drain, etc.



Failure to observe these precautions may result in loss of life, damage to property and/or damage to the robot.

Component Locator

Use the following diagrams to familiarize yourself with ARobot's various components.

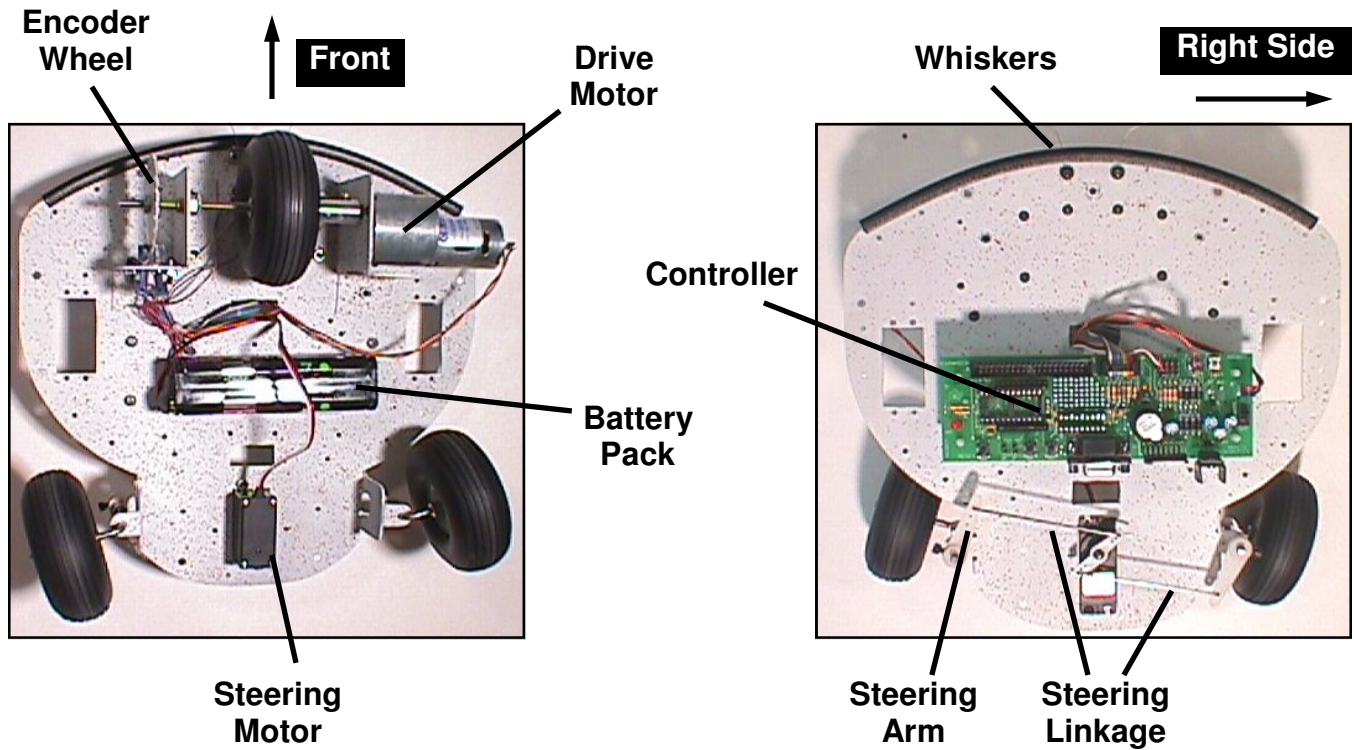

Controller

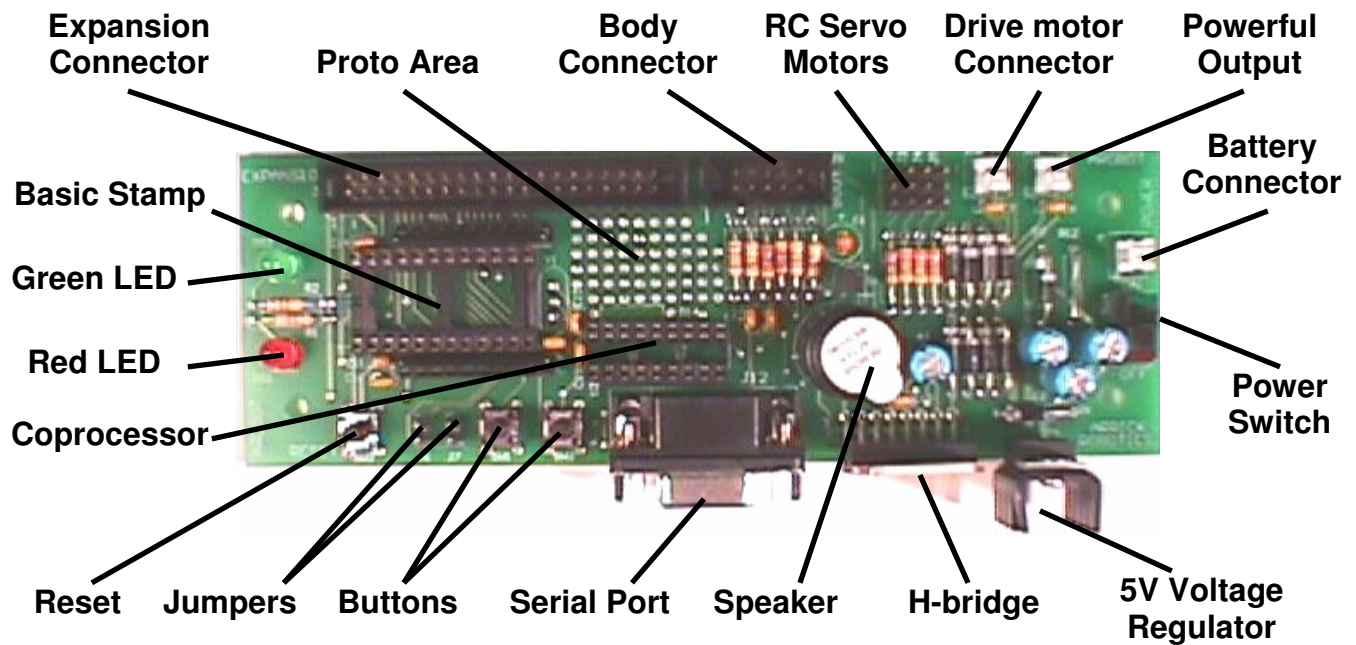

Glossary of Terms

Analog Signals – Signals that have values between on and off (1 and 0).

Android – A robot that has a human-like form.

Artificial Intelligence (AI) – A computer program that simulates intelligence like that found in biological systems.

Artificial Life – Behavior that is simulated by a computer program or other machine that mimics some or all aspects of biological life.

Baud Rate – The number of bits per second. In a serial signal from a typical personal computer, the baud rate is the number of bytes per second times 10. Each byte consists of 8 data bits, 1 start bit, and 1 stop bit.

BASIC – A high-level programming language.

Binary – A numbering system using 2 numbers – 1 and 0.

Bit – Abbreviation for binary digit. Each bit can have a value of 1 or 0.

Byte – A group of 8 bits.

C – A high-level programming language.

Cellular Automata – A system constructed with an array of cells where each cell can act according to preset instructions and can respond to nearby cells. Once started the system proceeds without further instructions.

Central Processing Unit (CPU) - The central component of a computer that executes instructions written by a programmer and controls I/O devices and memory.

Chaos – Disorder displayed by some complex systems.

Closed Loop – In motor control, the use of a feedback device such as an encoder to adjust the motor driver to achieve the desired position, speed, or acceleration. A Robot's drive motors are closed loop.

Compiler – A program that converts a high-level program into a low-level program that can be executed directly by a CPU.

Digital Signals – Signals that can have a value of on or off (1 or 0).

Encoder – A feedback device used by a motor to sense position and speed. Normally a wheel with holes or slots that are detected with an optical sensor.

EEPROM – Electrically Erasable Programmable Read Only Memory. A type of memory IC that can be written and read, and will retain data even after power is turned off. Used by the Basic Stamp to store programs and parameters.

EPROM – Erasable Programmable Read Only Memory. A type of memory that can be read only, and retains its data after power is turned off.

Emergent Behavior – Unexpected behavior in a robot that was not explicitly programmed.

Expert System – An intelligent system based on a database of rules.

Feedback – A signal produced by a sensor such as an encoder that is used to adjust motor position and/or speed.

Finite State Machine (FSM) – A machine or program that has a limited number of states, can examine its own state, can change its own state according to a set of rules, and can receive input from external sources.

Firmware – Programs that are stored on EPROM such as the Basic Stamps PBasic interpreter.

Fractals – A geometric pattern in which an object looks the same regardless of the viewing scale. Fractal concepts can be used in AI programming.

Fuzzy Logic – Logic in which boundaries between sets are not crisp. This concept is often used to control systems that would be too complex to model with traditional sequential programs.

Genetic Algorithm – A set of instructions that mimic biological life by simulating genes, mutation, and other aspects of living systems.

Gripper – A device that allows a robot to grasp objects.

Hardware – Physical circuitry including circuit boards, ICs (integrated circuits), transistors, etc.

H-Bridge – An arrangement of 4 transistors in the shape of the letter ‘H’ used to control the direction of a DC motor. A Robot uses a single IC that contains 2 H-bridges to control the drive motor and powerful output..

Hexadecimal – Base 16 numbering system. Each digit is written as 0-9,A-F. Hexadecimal makes it easier to enter data and address values. Example of a hex byte is 4A, example of a hex word is A04F.

High-Level Language – A computer programming language that allows the user to create complex programs using instructions that represent many simpler instructions. PBasic used by the Basic Stamp II is a high level language.

Infrared (IR) - Electromagnetic radiation generated by thermal agitation. IR is invisible to the human eye. IR is used by most TV and Stereo remote controls. Also see Passive Infrared

Integrated Circuit (IC) - A device where many electrical components are built together as a single component. A Robot uses integrated circuits on it’s circuit boards to perform most functions.

Interpreter – A computer language that converts instructions while the program is running. Unlike a compiler that first converts the program to machine code. Interpreters are normally slower than compilers.

Joystick – A control device that employs a stick to achieve 2 axis control.

Laws of Robotics - Three laws written by Isaac Asimov which prevent robots from intentionally harming humans and set other task priorities.

- A robot may not injure a human being or, through inaction, allow a human being to come to harm

- A robot must obey the orders given it by human beings except where such an order would conflict with the First Law.

- A robot must protect its own existence as long as such protection does not not conflict with the First or Second Law.

Light Emitting Diodes (LED) - Semiconductor that gives off light.

Liquid Crystal Display (LCD) - A type of display that can be controlled electrically and uses minimal power. Many calculators use LCD type displays.

Loops – In a computer program, the re-execution of instructions using control flow statements such as GOTO and WHILE.

Low-Level Language – The set of instructions used directly by a CPU to perform operations. Often referred to as assembly language.

Glossary of Terms continued

Mechatronics – A combination of mechanical and electrical devices to create a system.

Natural Language – Language used by humans to communication.

Neural Network – A network of processing elements that are connected together to simulate the intelligence created by biological brains. Often used to perform pattern recognition.

Open Loop – in motor control, the lack of a feedback device.

Parallel Data – Data that is transmitted multiple bits at a time using multiple wires.

Parameters – Values used to control functions.

Passive Infrared (PIR) sensor - A type of sensing device that converts infrared energy into electrical signals. Motion detectors for alarm systems often use PIR sensors to detect moving living objects.

PC/104 – Embedded computer system standard which has connectors with 104 pins. PC/104 modules are similar to cards found in desktop personal computers except that they stack together instead of plugging into a mother board. Complete computer systems can be created using PC/104 products.

Printed Circuit Board (PCB) - A non-conductive board that is laminated with layers of copper to provide electrical connections between components. A Robot's controller is a PCB.

Pulse Width Modulation (PWM) - In motor control, the use of electrical pulses of various widths to control the motor's position and speed. In speech and sound creation, the use of various pulse widths to generate an analog signal by using a low-pass filter.

RAM – Random Access Memory. Read/write memory.

Remote Control – Control of a system at a distance.

Resolution – In a motor control system, the smallest motion that a motor can make.

Robot – Any device that operates automatically performing tasks like a human.

Rule-based System – See Expert Systems.

Sensor – A device that converts light, temperature, and other phenomena to electrical signals. Also referred to as transducer. The ARobot uses many different sensors to detect the environment.

Serial Data – Data that is transmitted a signal bit at a time over one wire.

Servo Motors RC, DC – DC (direct current) servo motors use encoder feedback to monitor speed and position such as ARobot's drive motor. RC (remote control) servo motors are small servo systems that include motor, gear train, feedback device, and controller in a small package intended for remote control airplanes and cars. RC servos are used by ARobot to control the steering.

Software – Instructions used to direct operations on a CPU.

Sonar – See Ultrasonic.

Speech Synthesizer – An electronic device that generates human speech and sounds.

Subsumption Architecture – A programming method designed by Rodney Brooks of MIT that allows various functions to subsume other functions based on a predefined priority scheme.

Telepresence – Control of a robotic system at a different location. The operator may be provided feedback using various sensors.

Transistor – A silicon-based semiconductor device that can be used as an electrical switch or as an amplifier.

Ultrasonic – Sound waves with a frequency greater than humans can detect. Polaroid offers an ultrasonic ranging system that can be used to avoid obstacles.

Whiskers – Hair-like, flexible wires used to detect walls and other objects. ARobot has 2 such whiskers to aid in navigation.

Assembly Overview

ARobot's assembly normally takes about 2 hours or less excluding time for painting. Children as young as 10 can build ARobot with the help of an adult. The controller board and cables are pre-built, so soldering is not required.

During assembly you will do these things:

- Sand and paint the metal robot body pieces (this is optional).
- Mounting whiskers, drive motor, steering motor, wheels, etc.
- Route cables.
- Install the Basic Stamp II onto the controller board.

You'll learn:

- Identification and names of all parts.
- Screw, nut, and washer sizes.
- Basic electronic terminology.
- Basic mechanical assembly techniques.
- Basic wiring skills.

Tools you'll need:

- Medium Phillips screwdriver
- Needle nose pliers
- Sand paper (200-600 grit), or file
- Wire cutters

Parts

ARobot is easy to put together. Make sure you have all of the parts listed below before beginning. If something doesn't look right, send us some email at info@robotics.com

Quantity	Description	Used For
1)	Robot Body Sheetmetal	Body
2)	Motor Brackets	Mounting front drive wheel assembly
1)	Encoder wheel	Encoder assembly
7)	Screw, 4-40 x 3/16"	Whisker spacers, drive motor
12)	Screw, 4-40 x 3/8"	Motor brackets, encoder sensor, steering motor
16)	Screw, 6-32 x 1/4"	Collars, whisker brackets, steering arms, controller spacers
12)	Nut, 4-40	Motor brackets, encoder sensor, steering motor
5)	Nut, 10-32	Front axle, encoder wheel
13)	Washer, #4 star (teeth)	Motor brackets, encoder sensor, steering motor
2)	Washer, #6 plastic	Under whisker brackets
2)	Washer, #6 shoulder	Whisker bracket mounting
4)	Washer, #10 star (teeth)	Encoder wheel, front axle
2)	Spacer, 4-40 x 1/4"	Whisker mounting
4)	Spacer, 1" plastic	Controller circuit board mounting
1)	RC Servo Motor	Rear wheel steering motor with horns (attachments).
1)	DC Gear Motor	Front wheel drive motor
4)	Plastic wire tie	Bundling wires
1)	Body Cable	Connects controller to whiskers and encoder sensor
1)	Encoder sensor	To sense encoder wheel slots, mounts to motor bracket
1)	Shaft coupling	Attach front wheel axle to drive motor
8)	Collar	Rear wheel assemblies
2)	Rear axle	Rear wheels
1)	Front axle	Front wheel assembly – Don't damage threads!
1)	Bronze bearing	Front axle
2)	Steering arm	Connects steering linkage wire to rear wheel axle
2)	Steering arm linkage wire	Links steering servo motor to steering arm
2)	Whisker wires, 8-3/4"	Whiskers
3)	Wheel, 3-1/4" diameter	Front and rear wheels
1)	3" Velcro	Battery pack mounting
1)	Battery holder for 8-AA cells	Power source
1)	Battery cable	Connects battery pack to controller

About Screw, nut, and washer sizes

Numeric screw sizes start with a number indicating the diameter such as #4, #6, #10, etc (lower numbers are smaller) followed by the number of threads per inch (32, 40 etc), then the length. For example: **4-40 x 3/16** is a #4 screw with 40 threads per inch and a length of 3/16". Nut sizes are the same except they do not have a length. Spacers are like nuts but have a length. Washers simply have the # size and no threads per inch or length. Star washers have small teeth to prevent slipping.

Parts continued

Here are drawings of SOME of the parts in the ARobot package. Drawings are not to scale. As you build ARobot, refer back to these drawings to identify parts.

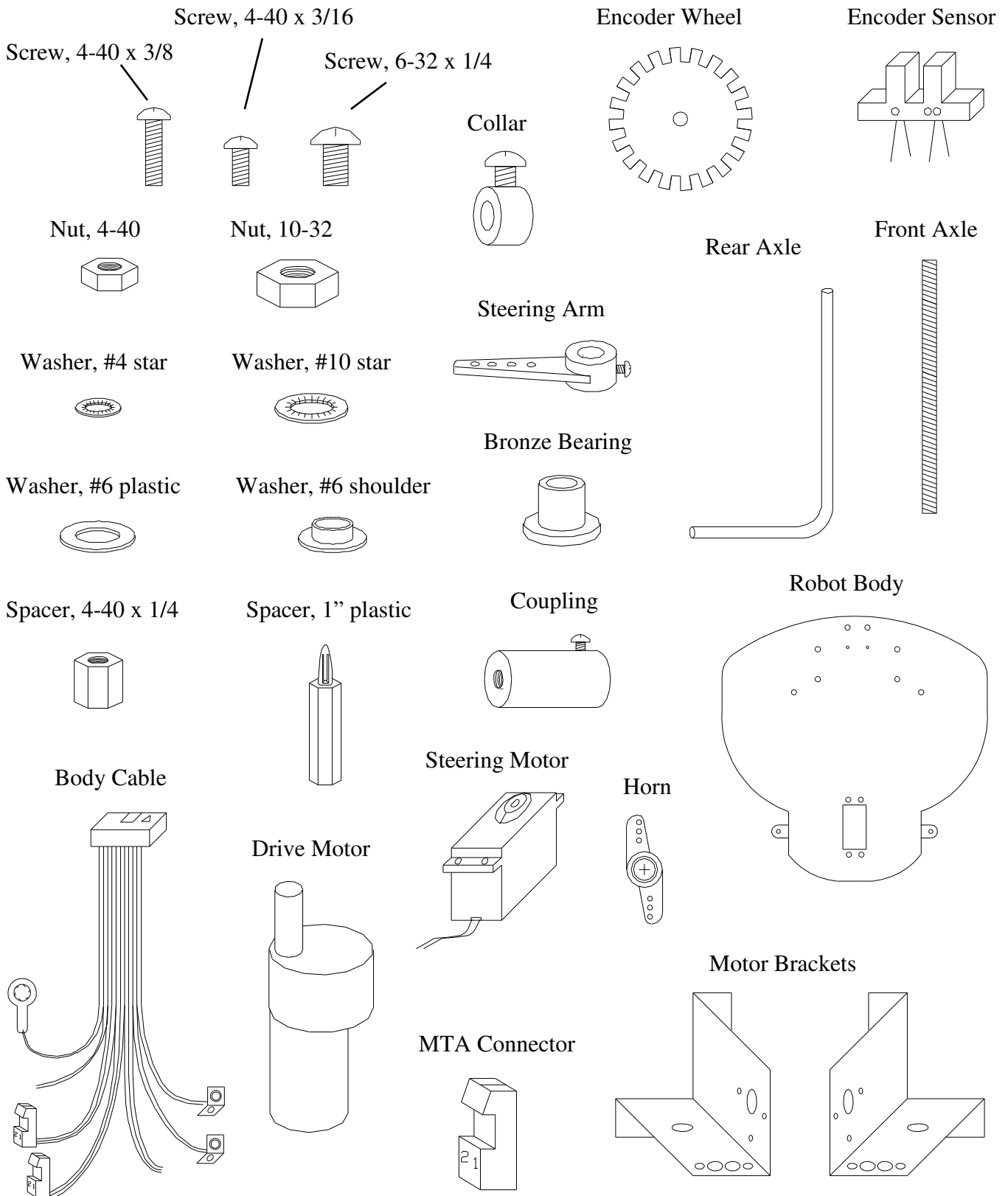

Parts continued

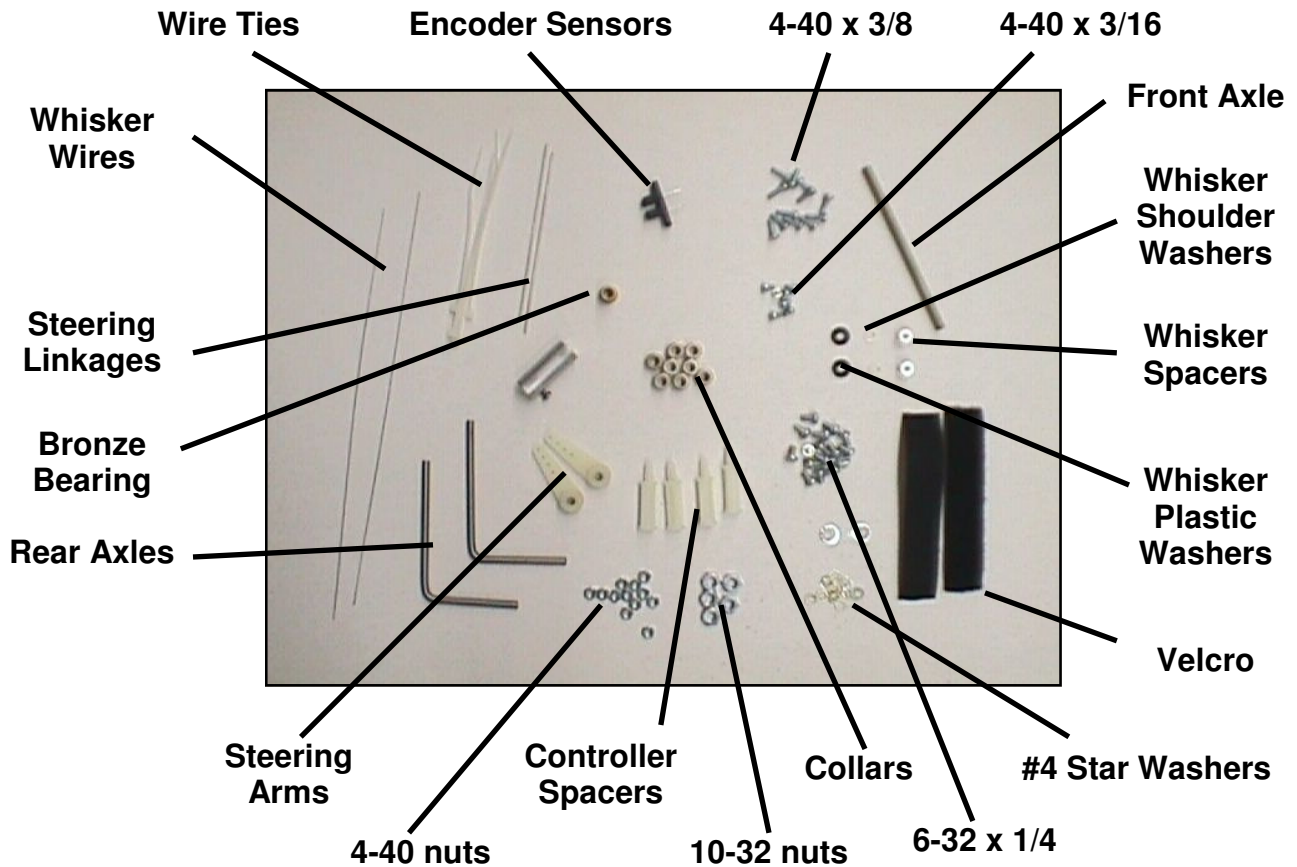
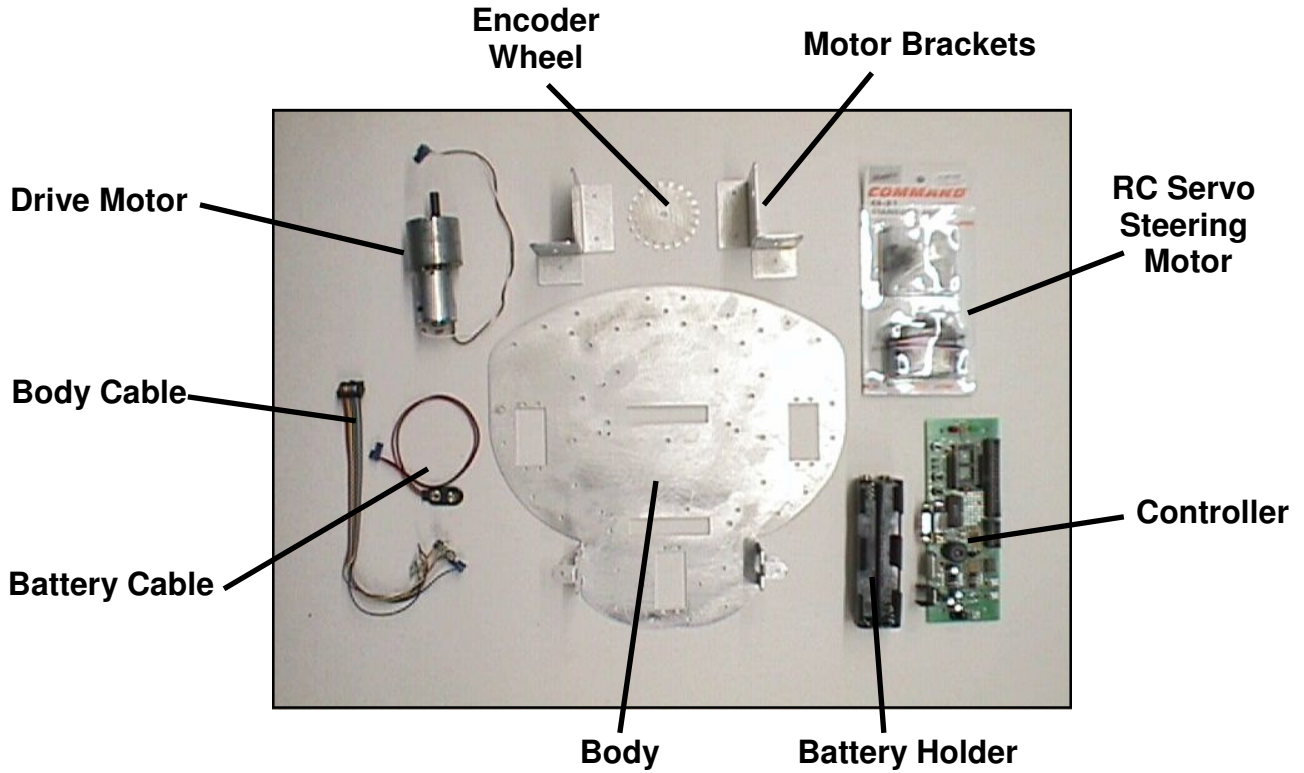

Painting

A Robot's paint job is your first chance to be creative and have a little fun. Who wants every robot to look alike anyway? Five parts are candidates for painting: The robot base, 2 motor brackets, encoder wheel, and the motor coupling. Or if you prefer, simply leave these parts unpainted.

Here's the process:

- Sanding
- Paint primer
- Finish coat
- Accents

Sanding

Sand the metal, especially the edges, with fine sand paper (200-600 grit). This process could also be done with a file. When done, clean the surface well using soapy water. Dry thoroughly before continuing.

Paint Primer

Paint primer is a special kind of fast-drying paint that helps paint stick to a surface. Primer is normally gray or red and comes in a normal spray can. You'll need less than one can. Read and follow the instructions on the paint can. Make sure the surface is clean and dry before priming.

Finish Coat

Apply the finish coat according to the directions on the paint can. You may want to check out some of the non-conventional paints that add texture to a surface. Normally you should let the finish coat dry overnight before continuing.

Accents

Be creative, consider using special accents to make your robot stand out.

- Masking to create special shapes such as flames or zebra stripes.
- Colored electrical tape from Radio Shack - Catalog #64-2340.
- Colored adhesive dots from an office supply store.
- Flexible, plastic molding from an auto parts store.
- Stick-on reflectors from a motor cycle shop.
- Textured paint for special effects.
- Text using stick-on letters or a permanent marker.
- Use large washers on the rear wheel axles as hub caps.
- Oh I almost forgot, try using your imagination!.

See some great examples of creative paint jobs on our web site at www.robotics.com/arobot

It may be necessary to clean out holes on the robot that have a build-up of paint. Simply use a pocket knife or Exact-o knife to clean them out. This is especially important on the whisker wire mounting holes since they must make electrical contact to the base for grounding. We'll deal with this later.

Whiskers

Two whisker wires are mounted on the front of the robot to detect obstacles. Locate the 4 whisker mounting holes near the front center of the robot body. Scratch off paint around the two smaller holes. Next, bend each whisker wire using the drawing as a full scale pattern. Locate the body cable and find the ground lug. Mount the 2 whisker spacers like the drawing and place the ground wire from the body cable under one of the whisker spacers and a #4 star washer under the other. Next, mount the whisker brackets which are wired to the body cable. The bracket connected to the white wire is the robot's right side, the black wire is the left side. Pay special attention to the plastic insulating washers. The brackets **MUST NOT** make electrical connection to the body. Slide the whisker wires through the bracket hole. Mount the whisker to the spacer with a 4-40 x 3/16 screw through the whisker's loop. When done, bend each whisker so it rests in the center of the bracket hole without touching. Place a piece of tape on the end of each whisker.

Summary:

- Locate the 4 mounting holes (2 per whisker) 2 small, 2 large.
- Scratch off any paint around the two small spacer holes.
- Bend whisker wires using the drawing as a full scale pattern.
- Mount the spacers and brackets according to the drawing.
- The whisker wires should rest inside the bracket hole without touching.
- Place a small piece of tape over the ends of prevent poking people.

How it Works:

The robot's body is connected to the battery minus wire (ground) which connects to the spacers and the whisker wires. When the whisker wire is bumped, it touches the metal bracket. These metal brackets are wired to the controller through the body cable. In a program, the robot can read the whisker status.

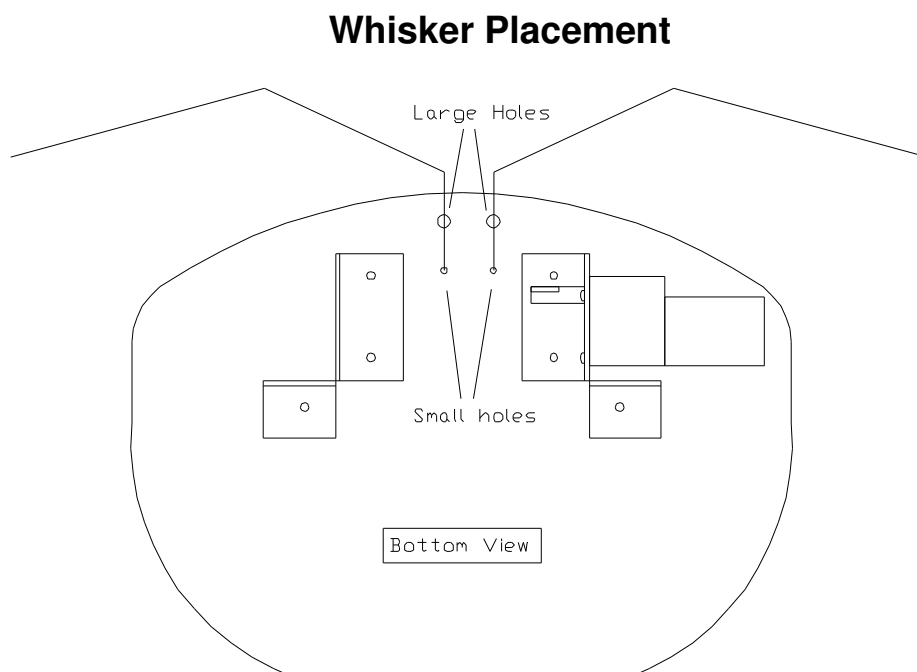

Whiskers continued

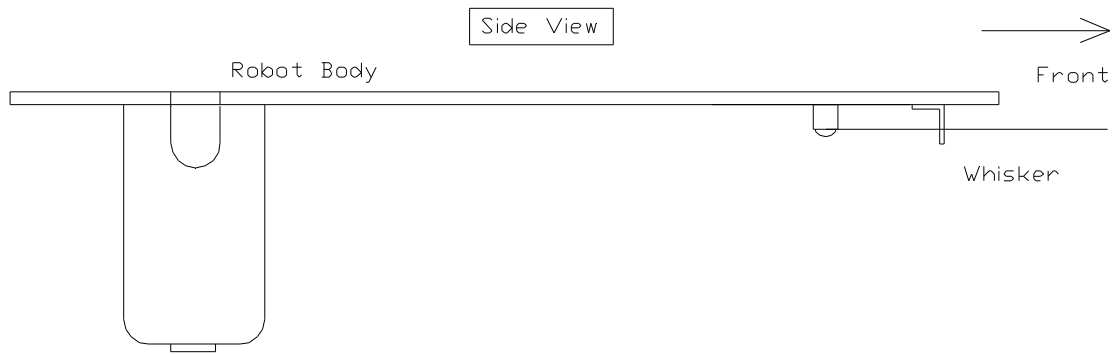

Whisker Detail

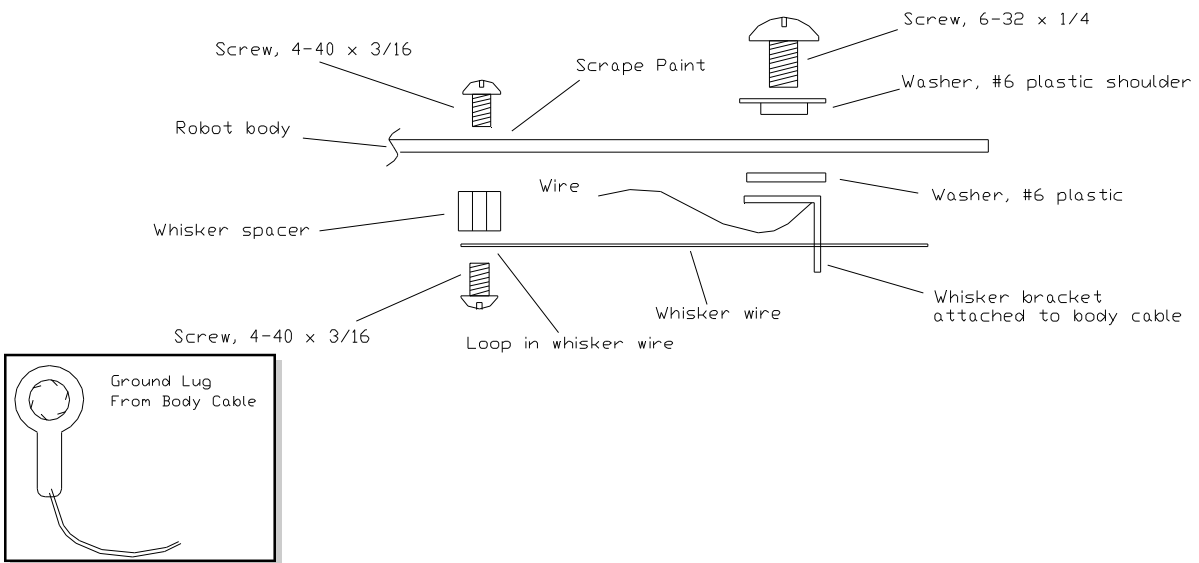

Full Scale Whisker Wire Pattern

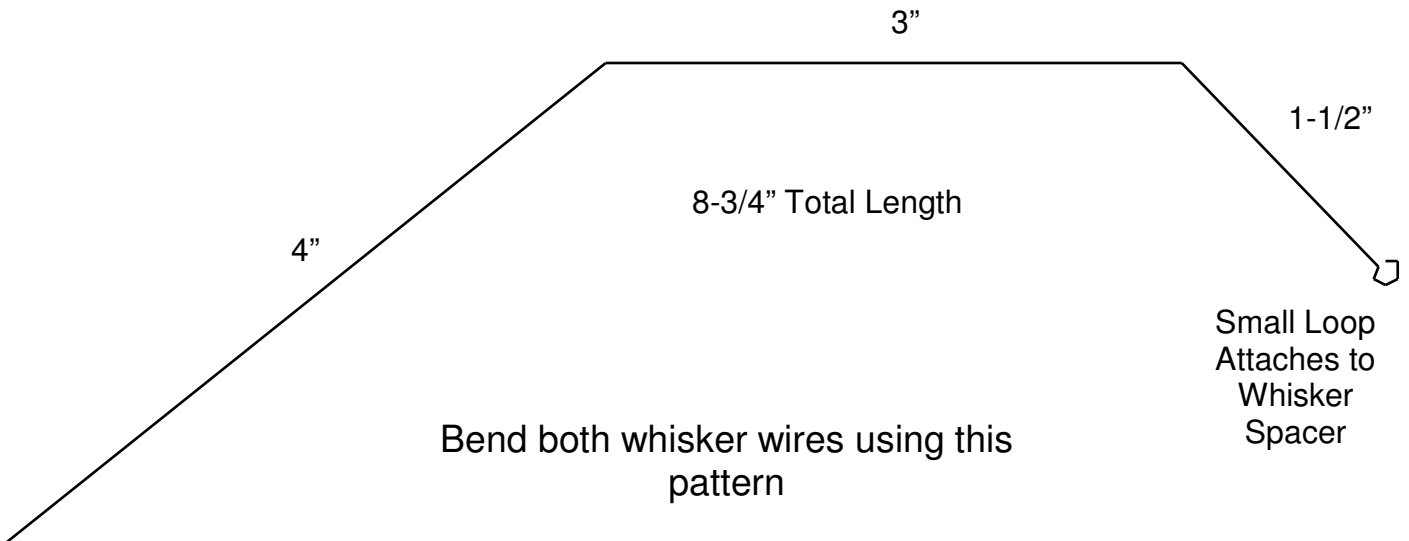

Drive Motor and Brackets

Locate the two motor brackets – a left side and a right side. Locate the drive motor. Mount the drive motor to the left motor bracket using 2 or 3 screws according to the drawing. Next, attach the motor brackets to the robot's body using 3 screws, 3 star washers, and 3 nuts per motor bracket. Minor bending may be required to align the mounting holes.

Summary:

- Locate the 2 motor brackets (left and right sides), and the drive motor.
- Mount the drive motor to the left bracket using 3 screws.
- Locate the 6 motor bracket mounting holes on the robot body (3 per bracket).
- Mount both brackets to the robot body.

Drive Motor Mounting

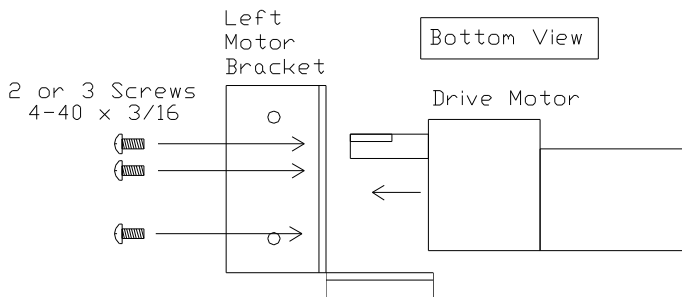

Motor Bracket Mounting

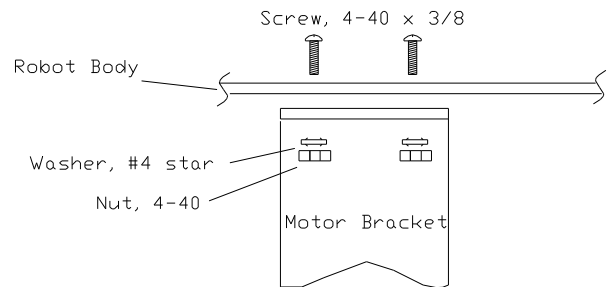

Motor Bracket Placement

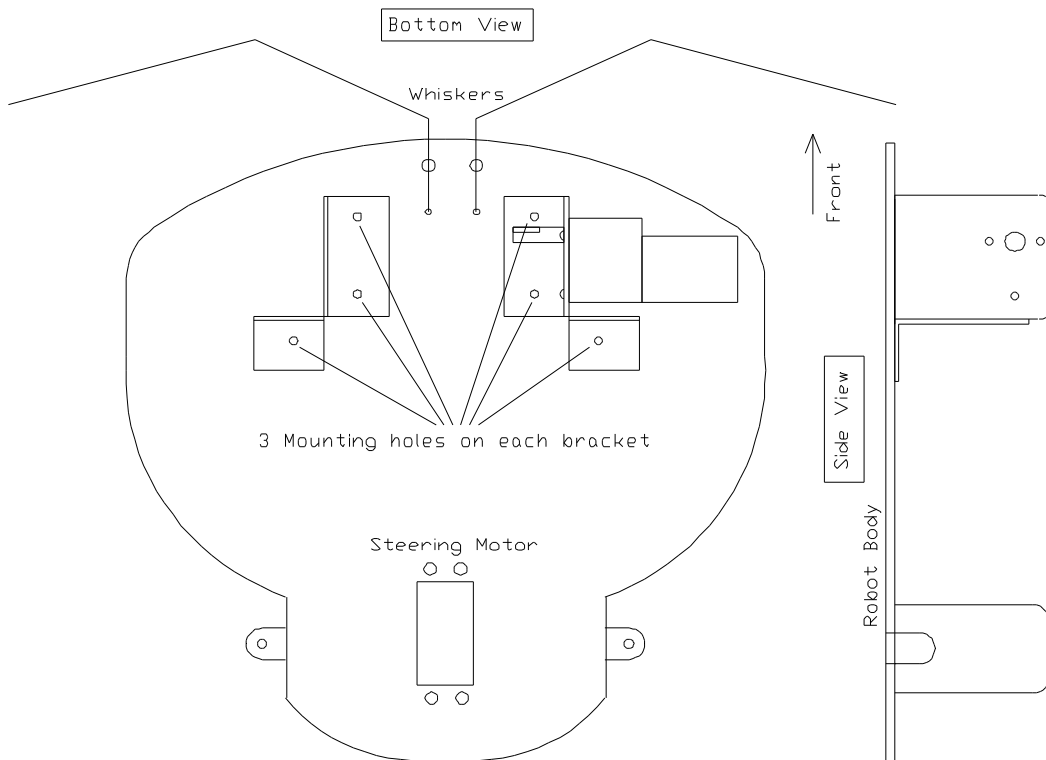

Encoder Sensor

The encoder sensor counts the teeth in the encoder wheel using invisible IR (infrared) light to measure the distance traveled. The encoder wheel has teeth that interrupt the beam of light. Locate the encoder sensor and notice the dots placed on it (see the drawing). Mount the sensor using 2 screws, 2 star washers, and 2 nuts. The encoder wheel will be mounted to the axle later.

Summary:

- Locate the encoder sensor.
- Mount the encoder sensor on the right wheel bracket according to the drawing.

Encoder Wheel

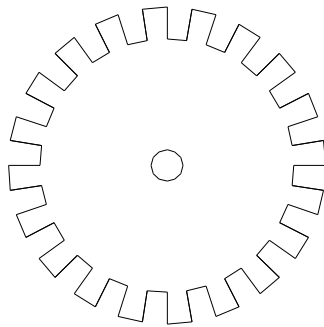

Encoder Sensor

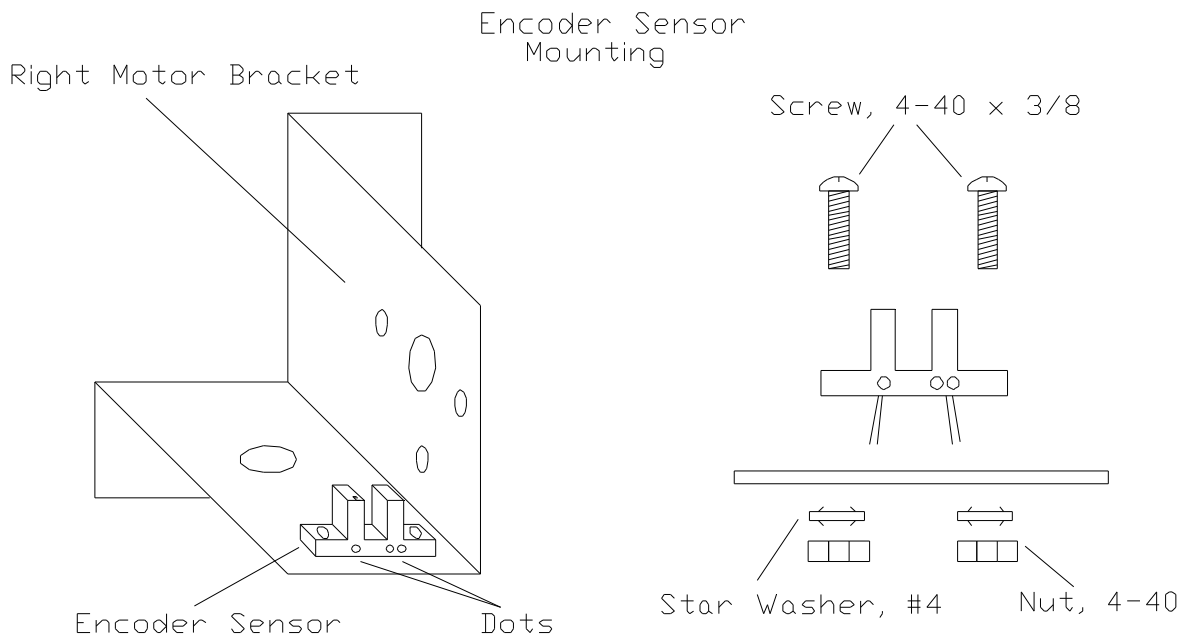
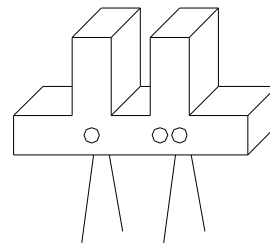

Front Wheel Assembly

A picture is worth a thousand words – so take a look at the drawings below before starting to building the front wheel assembly. First locate the front wheel which has a threaded bore and a red mark on the hub. Screw the threaded front axle into the wheel so that one side of the axle protrudes about 1/2 inch from the wheel's hub. Follow the assembly summary below while looking at the drawings. If you bend the whisker wires in this process don't worry, we'll fix them later.

Summary:

- Locate the wheel with the threaded bore. It has a red mark on the hub.
- Thread the front axle through the wheel so that it protrudes 1/2" on one side.
- Don't damage the threads on the axle!
- On the short axle side, slide on a star washer and screw on the coupling – tighten.
- On the long axle side, slide on a star washer then screw on a nut – tighten.
- On the long axle side. screw on a nut, a washer, then another nut per the drawing.
- Slip the bronze bearing onto the long side of the axle – flange first.
- Insert the long axle side through the hole in the right motor bracket and the coupling on to the drive motor shaft. The bronze bearing should fit in the hole. If not, use a knife to enlarge the hole.
- Move the nut/washer/nut combination installed earlier so they push against the bronze bearing.
- Now install the encoder wheel with the nuts and washer as shown in the drawing. The encoder wheel should ride in the slot in the encoder sensor without touching it.
- Tighten the set screw in the coupling against the motor shaft, tighten the wheel against the coupling, tighten the other nut against the wheel, tighten the two nuts together, and finally, tighten the nuts against the encoder wheel. The encoder wheel should not touch the sensor.

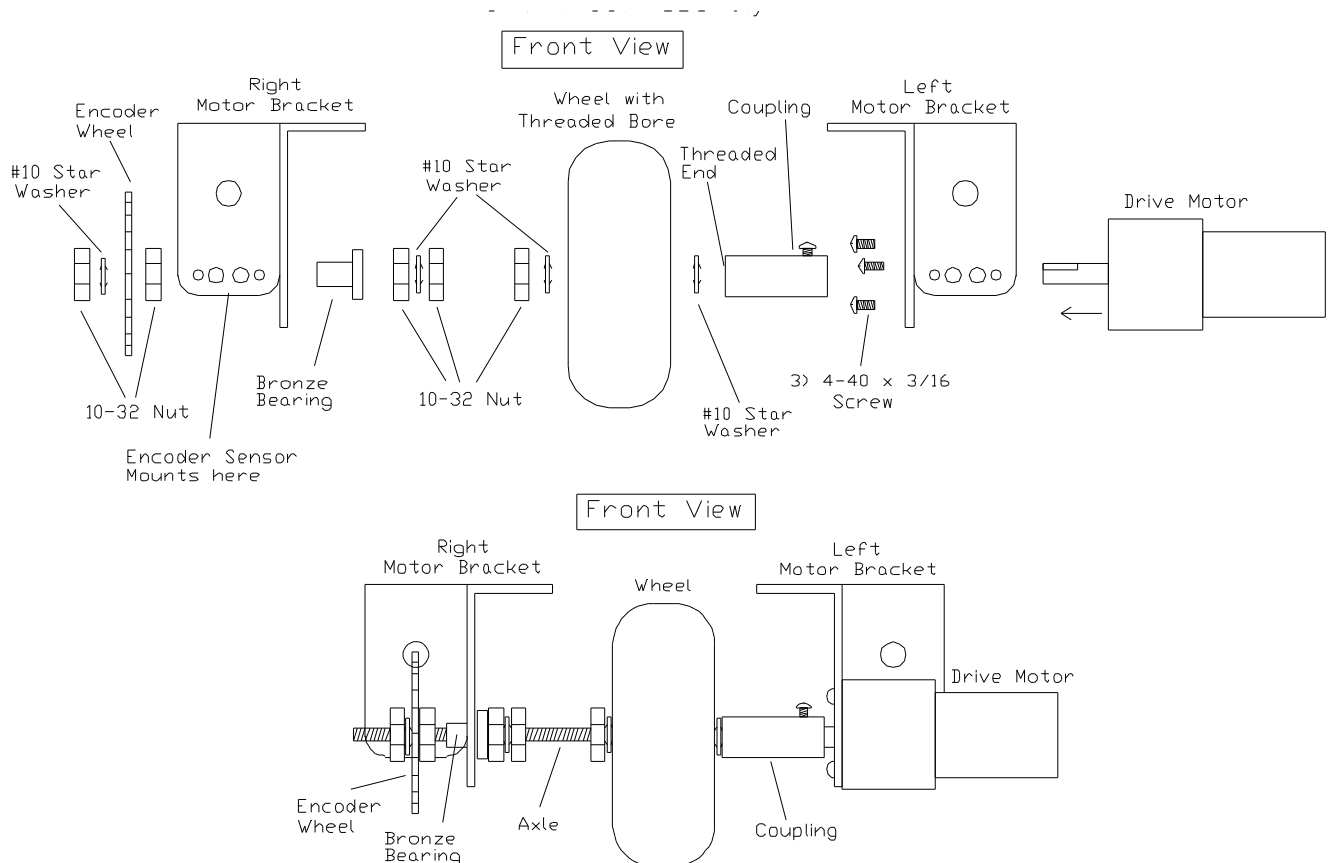

Steering Motor and Rear Wheels

Steering of the robot is accomplished using a standard RC servo motor attached to the rear wheels. Read the assembly summary while viewing the drawings.

Summary:

- Bend both 4" wires into steering linkages with pliers using the drawing as a pattern.
- Attach the horn to the steering motor with a screw. Turn the horn in both directions to determine the center position. In the center position, the horn should be oriented like the drawing shows.
- Mount the steering motor to the robot body per the drawing.
- Mount the rear axles to the robot body using collars. You may have to put 6-32 x 1/4 screws in each collar first.
- Mount the wheels to the axles using collars.
- Attach the linkages to the steering motor and to both steering arms.
- Attach the steering arms to the axles.
- Straighten the system, put the steering horn in the center of travel, loosen the steering arms and straighten the wheels then retighten the arms.

Full Scale Steering Linkage Pattern

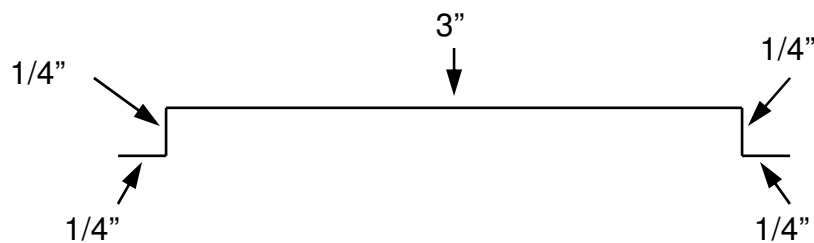

Steering Motor and Horn

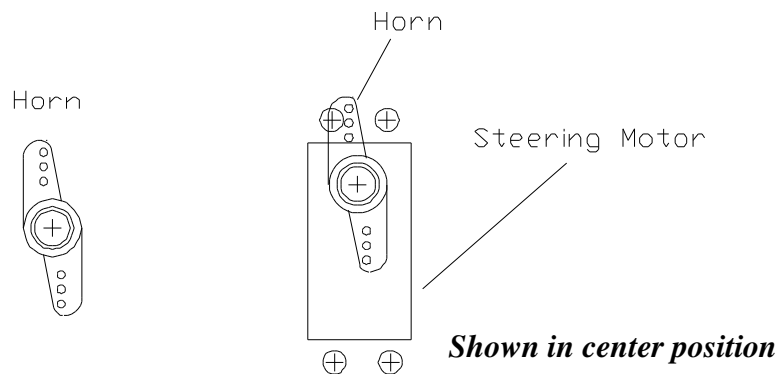

More drawings on the next page →

Steering Motor Mounting

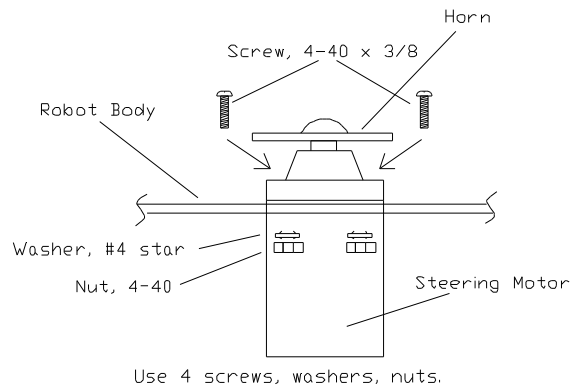

Wheel and Axle

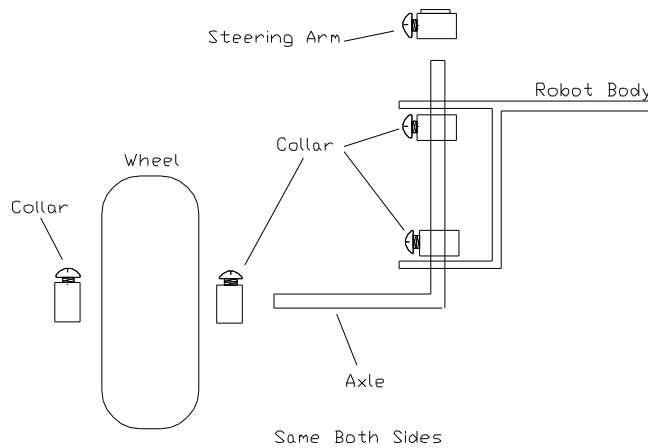

Steering System

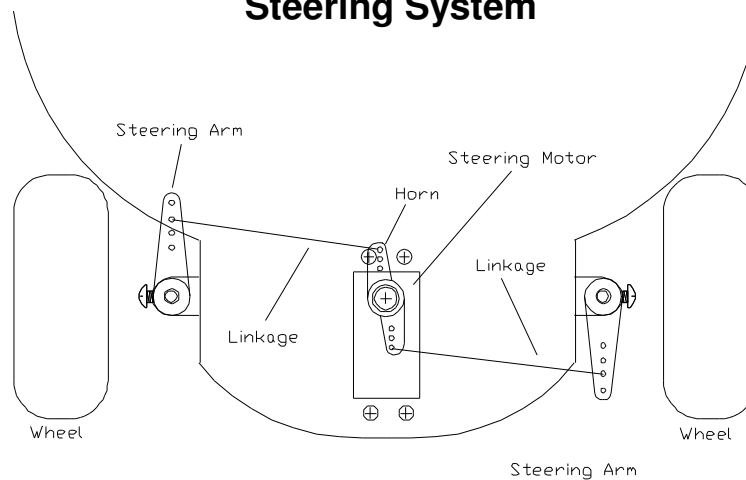

Controller Board

A Robot's controller board is the brains of the system. It accepts a Basic Stamp II controller chip which can be programmed from a personal computer. The controller board contains electronics used to drive the motors, sound the speaker, control the LEDs, read whiskers, etc. An expansion port allows additional circuits to be added to the system.

The controller board is mounted to the robot body using 4) 1" plastic spacers and 4) 6-32 x 1/4 screws. Place the controller board on the robot body and find the 4 holes that match the 4 mounting holes on the corners of the controller board. There are 2 sets of mounting holes, select the set towards the robot's rear. Install the 4 spacers in those holes. The controller board will simply snap onto these spacers and can be removed any time. The 9 pin serial port connector should point towards the rear of the robot, the expansion connector will be towards the front.

Summary:

- Find 4 mounting holes on robot body. There are 2 sets, select the set towards the rear.
- Mount 4 plastic spacers.
- Snap the controller board onto the spacers.

Controller Mounting Detail

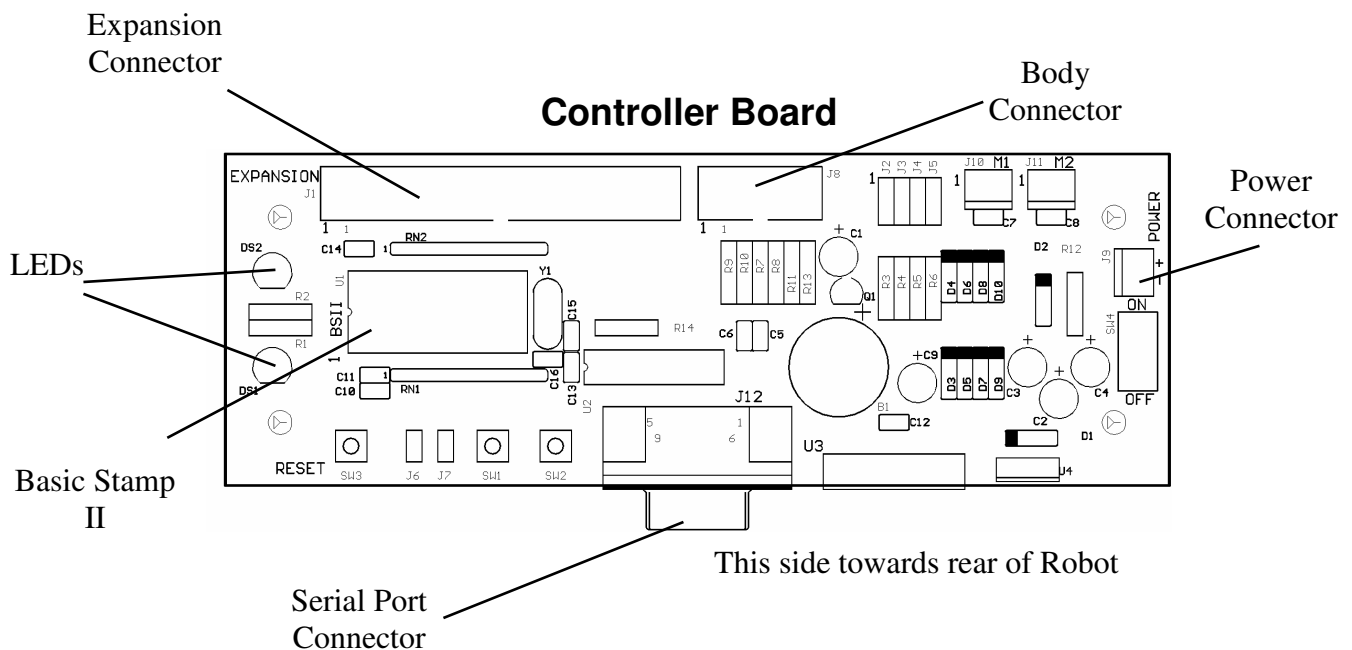
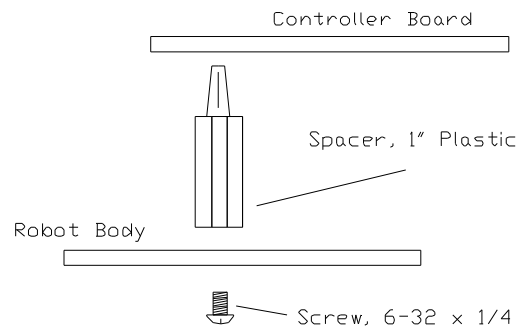

Battery Pack

Don't install batteries yet.

Power is supplied to ARobot using a battery pack that contains 8 AA size batteries. Locate the battery cable which has a batter snap on one end and a 2-pin MTA connector on the other. Pin 1 has the red wire and is +12 volts, Pin 2 is the black wire and is ground (0 volts). Plug the MTA connector from the battery cable onto the power connector on the controller board. Route the other end through a nearby hole in the robot body. Place Velcro on the battery holder and on the robot body – make sure the cable can reach. Connect the cable and mount the battery holder.

Summary:

- Don't install batteries yet.
- Locate the battery cable.
- Plug the cable into the controller board.
- Route the cable through a nearby hole in the body.
- Place one side of the Velcro strip on to the battery holder.
- Place the other side of the Velcro strip on the bottom of the robot where the cable can reach it.
- Connect the cable to the battery holder.
- Mount the battery holder using the Velcro.

Note:

The power connector can be plugged in backwards. Make sure the black wire matches up with the MINUS on the controller board, and the red wire matches up with the POSITIVE.

2 pin MTA connector

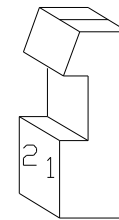
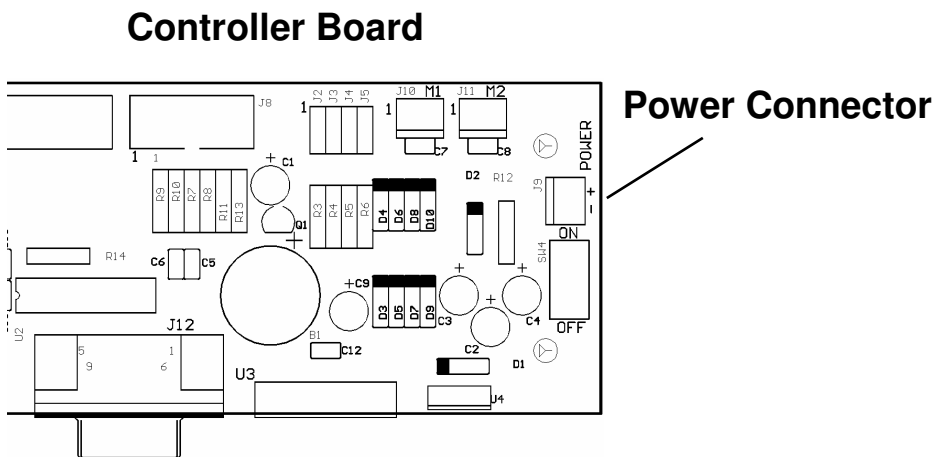

Body Cable

The body cable connects the controller to the encoder sensor, whiskers, and ground lug. The body cable will already be attached to the robot because we have already installed the whiskers and ground lug. Route the body cable up through the rectangular hole in the robot's body. Plug the body cable into the controller's 10 pin body connector which is next to the expansion connector. It will only install one way. Next find the 2 MTA connectors on the body cable. Attach them to the encoder sensor by matching the dots.

Summary:

- Route the body cable up through the opening in the body.
- Plug the cable into the body connector on the controller board.
- Plug the MTA connectors onto the encoder sensor by matching the dots.

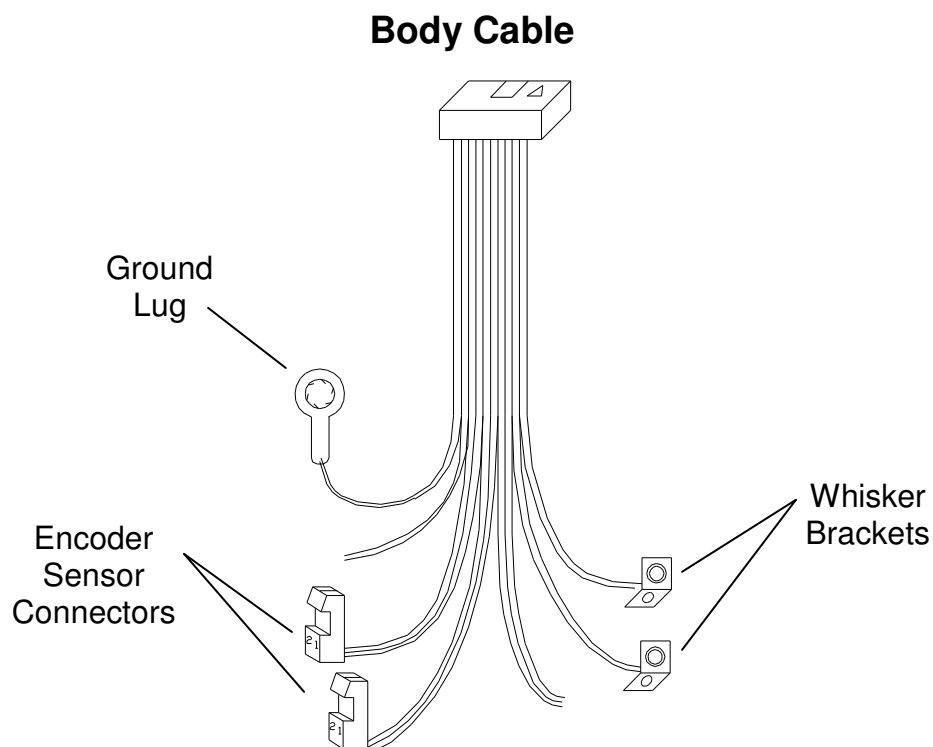
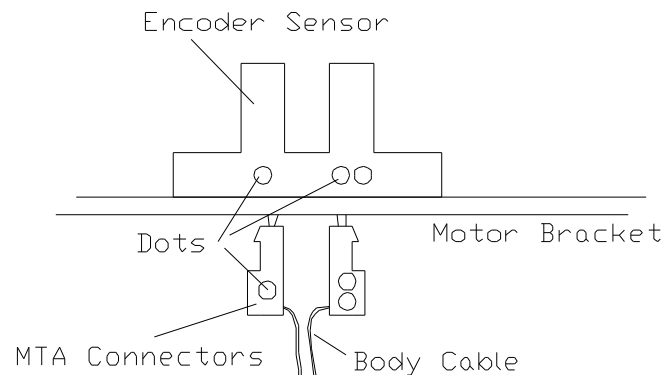

Finishing Up

You're almost finished building ARobot. Finish up by doing these things:

- Route the steering motor cable up through the rectangular hole in the robot body. Connect the steering motor cable to the 3 pin connector on the controller board near the body connector (see the controller drawing). Align the white (sometimes yellow) wire to pin 1. Installing this cable backwards will not harm the motor or controller, but it will not work.
- Use the plastic wire ties to attach the body cable to the robot body. Use any unused holes in the body. You can also attach the steering motor and the battery cable if you want.
- Route the drive motor cable up through the rectangular opening in the body and attach it to the motor connector on the controller board. It will only plug in one way.

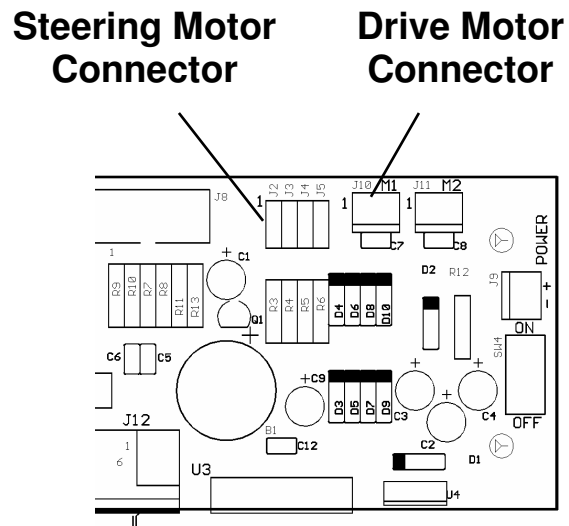

Feel Free to Celebrate!

About the Controller Board

The Controller board is the brains of ARobot. It contains circuitry to control the steering and drive motors, read the whiskers, control LEDs, speaker, buttons, etc. The controller board has a socket that accepts a Basic Stamp II control computer chip designed by Parallax Inc. www.parallaxinc.com
 The Basic Stamp II is programmed with a desktop PC through the serial port in the PBasic Language which is much like standard Basic but with some interesting additions.

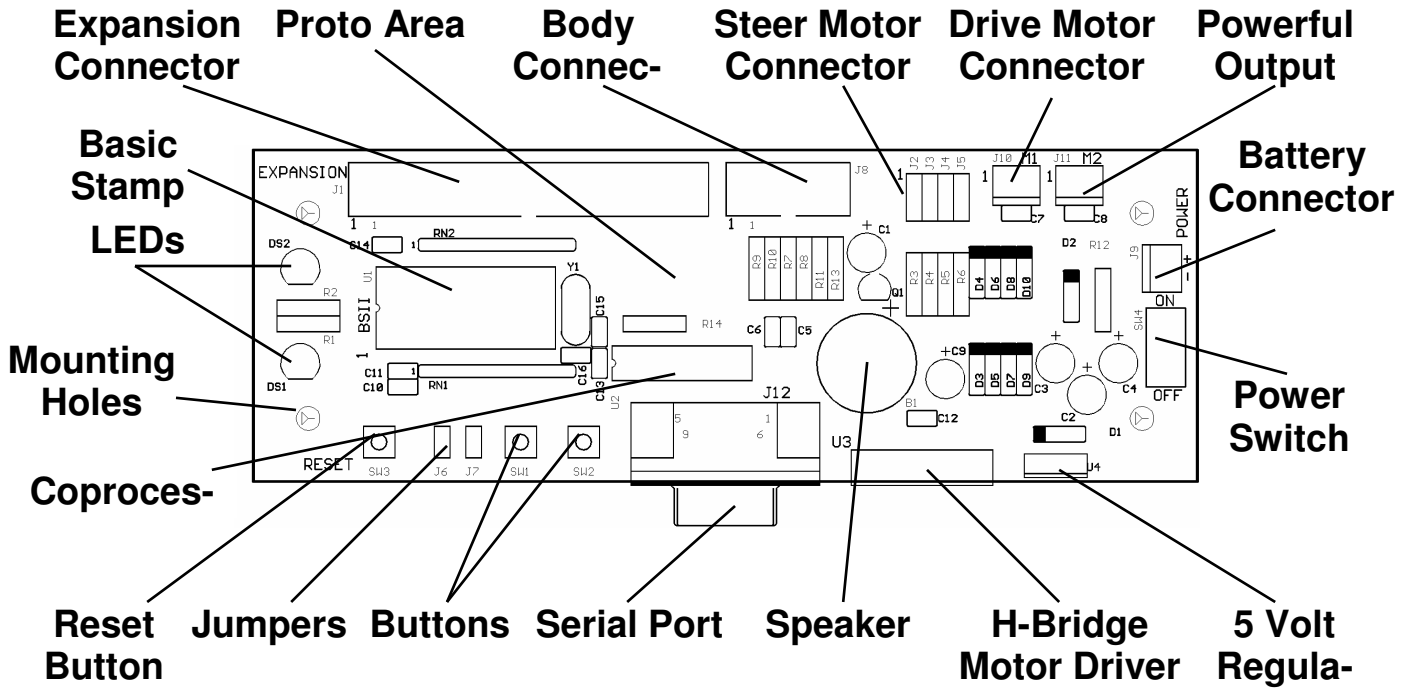

Basic Stamp II Installation

The Basic Stamp II is the computer that controls the robot. It plugs into the controller board. When installing the Basic Stamp II, remove the battery cable from the controller, then insert the pins into the socket noticing the pin 1 indicator. Make sure that no pins are bent. **Installing the Basic Stamp II incorrectly may damage it or the controller board.** To remove the Stamp, remove the battery cable and use a small screw driver to pry it up without bending any pins. ****NOTICE PIN 1 INDICATORS!!!**

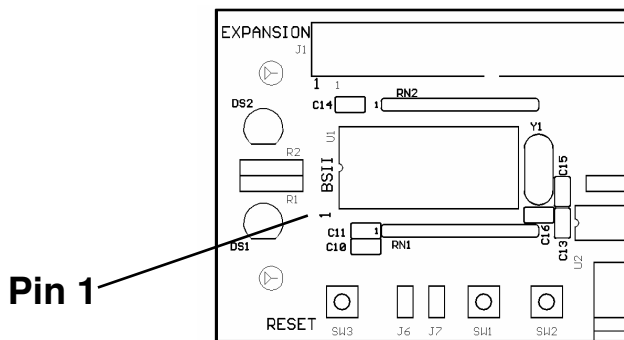

Programming
 You'll be programming the Basic Stamp II in a language called PBasic. Documentation for PBasic is available free from the Parallax Inc web site at:

<http://www.parallaxinc.com>

Cable to your PC

ARobot's controller board is programmed by connecting it to an Personal Computer (PC) running Microsoft Windows. The serial port (9 pin male connector) will be used for this. A 9 pin male-female cable is included to connect your PC's serial port to ARobot. It may be necessary to remove your modem or other device (except your mouse) to free up the serial port. Switch boxes are also available from computer stores that allow one serial port to serve two devices. Most computer stores also offer serial port cards that can be added to your computer.

USB Port:

If you don't have a serial port on your computer, you can use a USB to serial converter cable.

Programming Note:

You'll be Programming the Basic Stamp II. These programming details are beyond the scope of the ARobot User's Guide. Therefore, you'll need documentation that details the commands and procedures. Parallax Inc, the makers of the Basic Stamp II, offer this information free on their web site at www.parallaxinc.com Also, due to the popularity of the Basic Stamp, many books on the topic exist.

PC Editor/Downloader Software

The makers of the Basic Stamp II, Parallax Inc., offers PC-based software that allows you to edit and download programs to the Basic Stamp II. The disk included in the ARobot package includes a version of this program. We suggest you visit their web site and download the latest version of software and also their documentation which gives greater detail about programming than we can offer here.

Install the software by coping the disk contents to a newly created directory on your hard disk. Then run the editor/downloader which is named STAMPW.EXE for the windows version, or STAMP2.EXE for the DOS version. The program will require that you select the serial (COMM) port number.

Overview of programming:

- Install programming cable between your PC's serial port and ARobot's serial port.
- Install ARobot's batteries and turn the power switch on.
- Start the editor/downloader software and select the correct serial port number.
- Load a program from disk or create a new one.
- Download the software to ARobot.
- Remove the programming cable.
- Press the reset button on ARobot's controller to start the program.

Programs

The ARobot package includes programs to:

- Test Program to test motors, buttons, whiskers, speaker, LEDs, etc.
- Steering adjustment program to set the straight position of the steering motor.
- Wander program will move around avoiding obstacles.

Other programs and projects for ARobot are available at our website:

www.robotics.com/arobot

Test Program: TEST.BS2

The test program tests all functions on ARobot. When it powers up, it beeps several times to test the speaker. The program then responds to the following inputs:

Whiskers: One whisker makes it beep once and turns on the green LED.
The other whisker beeps twice and turns on the red LED.

Buttons: One button toggles the LEDs on and off and sends data out the serial port (counts from 1 to 25). The other button moves all RC servo motors from left to right and back again.

Jumpers: One jumper causes the drive motor to move forward.
The red LED will go on and off as the motor turns indicating an operating encoder.
The other jumper turns on the powerful output.
If one button is pressed, the powerful output will reverse polarity.

Steering Adjustment Program: STRAIGHT.BS2

This program helps the robot builder adjust the steering system for straightness. The program will wait for the user to push one of the buttons. Once the button is pushed, the robot straightens the steering wheels, beeps once, moves forward 10 feet, then reverse 10 feet. Adjust the steering arms and check the robot's travel until straight.

Wander Program: WANDER.BS2

This program is a simple object detection/avoidance routine. It drives forward until a whisker comes in contact with an object. It then reverses direction and steers away from the object. After a short period, it returns to straight forward movement. The Wander program is an excellent starting point for the creation of new programs.

About the Controller Board

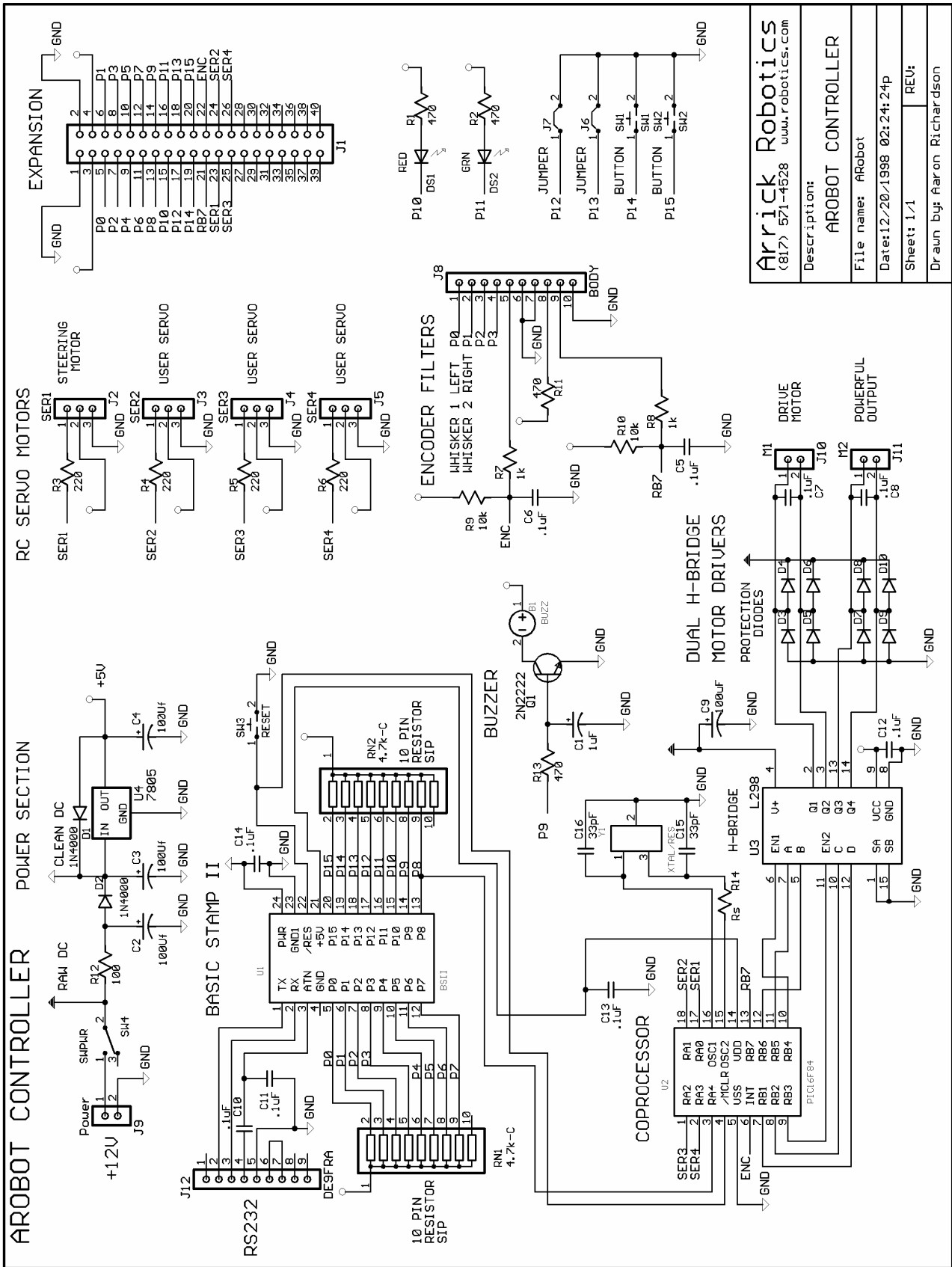

Batteries

A Robot's controller board requires 9 to 12 volts supplied by 8 AA size batteries. We've found that the best batteries are DuraCells. You can also use AA size rechargeable batteries. First turn the controller board off and remove the battery pack from the battery cable. Install the 8 batteries observing polarity + - which is indicated on the holder. Snap the cable back onto the pack and stick the pack to the body with Velcro.

When the batteries get low, you will notice that the drive motor will be slow and erratic operation or re-sets may occur. This will not harm the robot.

Power On/Off Switch

The power switch is located next to the power connector on the controller board. The ON position is shown by a green dot. The OFF position is shown by a red dot. Make sure to turn power off when attaching cables, installing batteries, or installing the Basic Stamp or other parts.

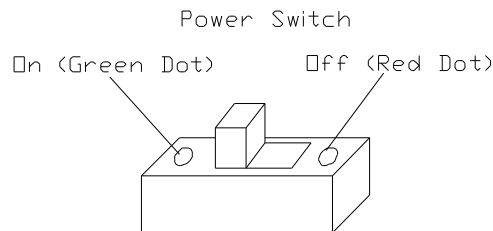

Reset Button

The Reset button is located on the edge of the controller board near the Basic Stamp II. It's used to re-start the Basic Stamp II and the coprocessor which controls the motors. Reset can also be performed by turning off the power and back on again.

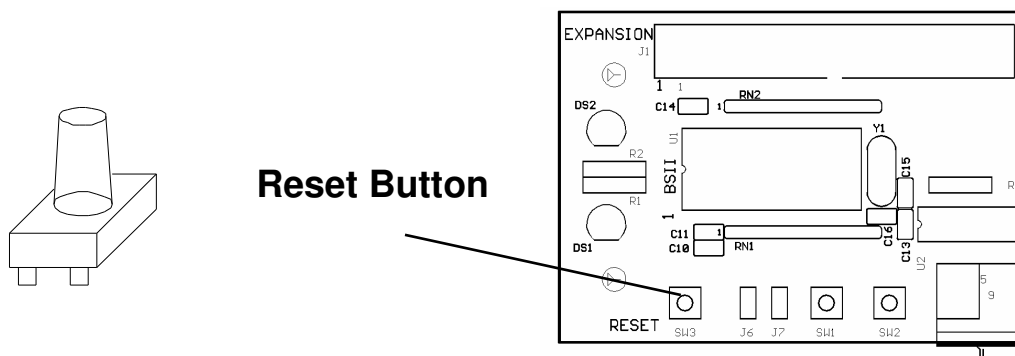

Whiskers

Whisker wires are used to detect objects while the robot is moving. There is a left and right whisker which can be read separately to determine the location of the object. The left whisker is connected to the P0 pin and the right whisker is connected to the P1 pin. When an object is detected, these pins return a logic zero (low). The pins must be in the input mode. The following PBasic code example shows how the whiskers can be read.

```
if in0=0 then wh1           'If left whisker on then jump to wh1.
if in1=0 then wh2           'If right whisker on then jump to wh2.
```

See the WANDER and TEST program for examples on how to use the whiskers for navigation.

It is possible to attach additional whiskers to the robot. Simply wire them to unused Basic Stamp pins available on the expansion connector and read them in your program. Mounting holes are provided for side and rear whiskers.

Speaker

A speaker is connected to P9 on the Basic Stamp II. It can be used to send various signals to the operator. Simply toggle the pin at various frequencies to create different tones. Here's a PBasic code example:

```
speaker con 9               'Define speaker pin to 9.
freqout speaker,200,1500    '200=frequency, 1500=duration.
low speaker                 'Finish with pin LOW.
```

It's very important to leave the speaker output pin LOW when done or power will be drained from the battery. This pin should also be set LOW upon program startup. See WANDER and TEST programs for additional examples.

LED indicators

Green and red LED (Light Emitting Diodes) are mounted on the controller board and are connected to the Basic Stamp II pins P10 (red) and P11 (green). A low condition will turn an led on. Here's a PBasic code example to control them:

```
redled con 10               'Define red led pin.
grnled con 11               'Define green led pin.
low grnled                  'Green LED on.
high redled                 'Red LED off.
```

To help conserve battery power, turn off the LEDs when not needed.

Push Buttons and Jumpers (switches)

Two general purpose buttons and jumpers (also called switches) are provided on the controller card which can be read by the Basic Stamp II. Buttons are momentary – after you press them they return to the off state. Jumpers can be left in the on or off position using the jumper plug or wired to external switches. Buttons and Jumpers can be use in your program to set certain parameters or modes as needed. They may be ignored and not used at all. Here is a piece of PBasic example code that reads them: Notice they are active LOW (LOW=on).

```
if in12=0 then jmp1on           'If jumper 1 on then jmp1on.
if in13=0 then jmp2on           'If jumper 2 on then jmp2on.
if in14=0 then button1         'If button 1 on then but1on.
if in15=0 then button2         'If button 2 on then but2on.
```

Drive Motor and Encoder

The drive motor moves the motor forward and backward using the H-Bridge driver circuit (see the controller drawing for location). The H-Bridge is controlled by the coprocessor which receives commands from the Basic Stamp II using serial I/O commands over the coprocessor network pin – P8. This frees the Basic Stamp II for other tasks.

An encoder wheel and encoder sensor are used to measure rotation of the drive wheel resulting in distance measurement. There are 20 encoder slots (counts) per revolution. As it rotates, the slots are detected by the encoder sensor. The drive wheel is about 3-1/2” in diameter, so each count represents about 1/2” of robot travel – $(3.25 \times 3.141) / 20$. Reading of the encoder is also handled by the coprocessor to free up the Basic Stamp II. The count (distance) can be read from the coprocessor by the Basic Stamp II when needed.

The following PBasic subroutine will show how to control the drive motor through the coprocessor. We suggest you also study the WANDER and TEST program.

```
'Drive Motor Control Subroutine.
speed var byte           'Speed variable. '0'-'9', 'A'.
distance var word        'Motor distance variable 0-65535.
direction var byte       'Direction. 1=fwd, 0=rev.
net con 8                 'Coprocessor network pin.
baud con 396             'Coprocessor baud rate.

'Subroutine to start drive motor.
'
drivemotor:
  serout net,baud,["!1M1", decl direction, speed, hex4 distance]
  serin net,baud,[char]    'Get "A" back.
  return
```

Drive Motor and Encoder continued

The previous subroutine will START the drive motor. You can monitor the progress of the drive wheel by reading the encoder counter from the coprocessor. Here is example code that will read the encoder.

```
ec var word           'Encoder count.

    serout net,baud,["!1E1"]   'Ask for encoder count.
    serin net,baud,[hex4, ec]  'Get encoder count into ec.
```

You can use this code within a loop to wait until the desired distance is completed. Put a 100 ms delay between reads using a `pause 100` command.

Steering Motor

The steering is an RC (remote control) style servo motor that is commonly used on model race cars and airplanes. The coprocessor can control 4 RC servo motors - #1 is used for steering. When the Basic Stamp II needs to control an RC servo motor, it simply sends a command to the coprocessor which handles the task. This frees up the Basic Stamp II for other tasks.

Here is a subroutine that can be used to control all 4 RC servo motors including the steering motor #1. Study the WANDER and TEST programs for additional insight.

```
'Constants and Variables.
net con 8           'coprocessor network pin.
baud con 396       'coprocessor baud rate.
position var byte  'Position of motor.
motor var byte     'Motor #.

'Subroutine to control RC servo motors.
'Motor # 1-4.
'Position = 1-255, 0=off, 128=center.
'The servo is moved to the desired position for 500 ms
'then turned off to conserve power.
'
rcservo:
    serout net,baud,["!1R", decl motor, hex2 position] 'Move Motor.
    serin net,baud,[charn]                             'Get A.
    pause 500                                           'Wait for servo to turn.
    serout net,baud,["!1R", decl motor, "00"]          'Motor off.
    serin net,baud,[charn]                             'Get A.
    return
```

If you need your RC servo motor to resist movement after it has turned to the desired position, don't turn

Coprocessor Command Summary

This section describes how the coprocessor works and how each command is constructed.

The controller board contains a coprocessor that is used to control the drive motor, powerful output, encoder sensor, and the 4 RC servo motors (#1 is used as the steering motor). This frees the Basic Stamp II for other tasks. The coprocessor receives commands from the Basic Stamp II via the coprocessor network bus on pin P8. SERIN and SEROUT commands are used in PBasic to communicate with the coprocessor. Each command sent to the coprocessor is preceded by a “!” start character and an address character. This allows other coprocessors to be attached to the network.

The coprocessor responds to some commands by returning an “A” to indicate “acknowledged”. The coprocessor never speaks until spoken to – this is called a “Master/Slave” network. The Basic Stamp II is the master and the coprocessor is the slave. This creates a multi-processor system.

Each command intended for the motor control coprocessor begins with “!1”

Drive Motor Control:

Example: **!1M11200E7**

The command begins with “!1M1” to indicate the drive motor. The next character (1 in the example) indicates the direction 1=forward, 0=reverse. The next character (2 in the example) is the speed which should be 0, 1, 2 ,3 ,4 ,5 ,6 ,7 ,8 ,9 ,A. Speed of 0 is off, A is full speed. The next 4 characters are the desired encoder count in hexadecimal (00E7 in the example). Each encoder count represents about 1/2” of travel. When this command is given the current encoder count is reset. If the command is accepted, an “A” will be returned indicating “acknowledged”.

Read The Encoder Count:

Example: **!1E1**

This command asks the coprocessor to return the current encoder count as 4 hexadecimal digits which represents the current distance that the robot has traveled. Each encoder count represents about 1/2” of travel.

Continued on next page.....

RC Servo Motor and Steering Motor Control:

Example: **!1R380**

This command begins with “!1R” and is followed by a character indicating the RC servo motor number (3 in the example), followed by the position in hexadecimal (80 in the example). Possible position values are “01” through “FF” which results in about 120 degrees of motion. This varies depending on the motor. A position value of 80 hexadecimal will center the motor. A position value of “00” will de-energize the servo motor to conserve power. It normally takes less than one second for the motor to position itself. During that time, do not de-energize the motor. If the command is accepted, an “A” will be returned indicating “acknowledged”.

Motor 2 Control (Powerful Output):

Example: **!1M20**

A second motor control port is provided that can be used to control DC motors or other powerful loads such as lamps. We refer to this as the Powerful Output. The command begins with “!1M2” and is followed by a character indicating the action 0=off, 1=forward, 2=reverse. If the command is accepted, an “A” will be returned indicating “acknowledged”.

Coprocessor Communication Rules

Communication between the Basic Stamp II Master and the coprocessors follow these rules:

- Single-wire bidirectional serial communication.
- Serial communication parameters: 2400 baud, 8 data bits, and 1 stop bit.
- Coprocessor network is a master/slave setup. Slaves only talk when asked to.
Coprocessors never send “!” which is reserved to identify the beginning of a command.
- Each command sent by the master begins with “!”.
- All commands should be upper case.
- Second character of each command is the coprocessor address character. Usually “1”, “2”, etc.
- The third character of each command is normally the actual command itself.
Such as “M”, “R”, etc.
- Commands are fixed length and do not require carriage returns or other termination.
- 8-bit values are sent/received using 2 hex digits. 00-FF. 16-bit values are 4 hex digits.
Leading zeros required to maintain fixed length.
- Single digit values from 0-9 can be a single character 0-9. Such as motor #, etc.
- Commands return a value or return an “A” to indicate “acknowledged”.

Hexadecimal, Binary, Bytes, Words, etc.

Most commands require parameters in the form of hexadecimal values and many commands return hexadecimal values. Sometimes the bits in these values will represent certain things. We'll use the term "hex" to refer to hexadecimal.

Hexadecimal

Hex numbers are easy for computers to work with because each hex digit can represent 4 bits, 2 hex digits can represent a byte, and 4 hex digits can represent a word. Sometimes hex digits are referred to as nibbles. Hex numbers are base 16 instead of base 10 like our decimal numbering system. Hex digits are: 0 1 2 3 4 5 6 7 8 9 A B C D E F (16 total).

Bits

A bit is a single binary (base 2) digit which can be a "1" or a "0". Digital computers such as the Basic Stamp, use binary values for processing. A "1" is ON or HIGH, a "0" is OFF or LOW.

Bytes

A byte consists of 8 bits. A byte can be represented as a hex value such as "00" or "FF". The range of values that a byte can represent is 0-255 decimal (00-FF hex).

Words

A word consists of 2 bytes (16 bits). A word can be represented as a hex value such as "0000" or "FFFF". The range of values that a word can represent is 0-65535 decimal (0000-FFFF hex).

The following table shows the binary equivalent for each hex digit:

Hex digit	Binary value (bits)	Decimal	Hex digit	Binary value (bits)	Decimal
0	0000	0	8	1000	8
1	0001	1	9	1001	9
2	0010	2	A	1010	10
3	0011	3	B	1011	11
4	0100	4	C	1100	12
5	0101	5	D	1101	13
6	0110	6	E	1110	14
7	0111	7	F	1111	15

Basic Stamp Commands

The Basic Stamp II's PBasic language has special commands used to convert numbers to hexadecimal as needed by the coprocessor. See the SERIN and SEROUT commands in the Basic Stamp Programming manual for details (available at the Parallax web site <http://www.parallaxinc.com>). Examples:

```
serout net,baud,["!1R1", hex2 position] 'Move RC Servo Motor.
```

```
serin net,baud,[hex4, ec] 'Get encoder as 4-hex characters into ec.
```

Battery Connector (J9)

Usage: Supplies battery power to all systems.

Type: 2 pin, MTA, .1"

Pinout:

- 1 – +12 volts
- 2 – Ground

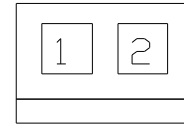

Body Connector (J8)

Usage: Connects controller to encoder, whiskers, and ground lug.

Connector: 10 pin, dual row header, .1"

Pinout:

- 1 – P0 on Basic Stamp II, whisker #1
- 2 – P1 on Basic Stamp II, whisker #2
- 3 – P2 on Basic Stamp II, optional
- 4 – P3 on Basic Stamp II, optional
- 5 – Encoder #1 output (drive motor)
- 6 – Ground for encoder sensor
- 7 – Ground for encoder sensor
- 8 – Encoder + LED drive
- 9 – Encoder #2 output (open collector)
- 10 – Body Ground Lug

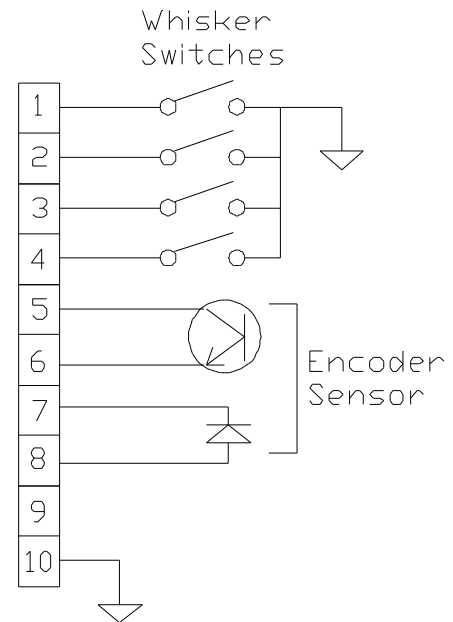
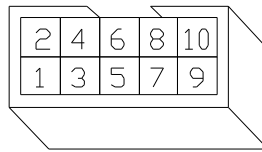

Serial Port (J12)

Usage: Connects controller to PC's serial port.

Connector: 9 pin female D-sub connector.

Cable: Use a 9 pin straight through cable for connection to PC serial (COMM) port.

Pinout:

- 1 – No connect
- 2 – Transmit data from Basic Stamp II
- 3 – Receive data to Basic Stamp II
- 4 – Attention signal
- 5 – Ground
- 6 – Jumpered to pin 7
- 7 – Jumpered to pin 6
- 8 – No connect
- 9 – No connect

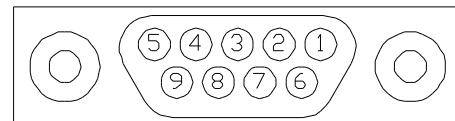

RC Servo Motor Connectors (J2-J5)

Usage: Connects controller to RC servo motors.

J2 is used for the steering motor.

J3, J4, J5 are user defined.

Controlled by the coprocessor

Connector: 3 pin, .1", 4 total

Pinout:

1 – Control Pulse

2 – +5 volts

3 – Ground

J2	J3	J4	J5
1	1	1	1
2	2	2	2
3	3	3	3

Drive Motor Connector (J10)

Usage: Connects H-Bridge driver to DC motors.

Controlled by coprocessor. Polarity can be controlled.

Type: 2 pin, MTA, .1"

Voltage: 12 volts

Maximum Current: 500ma

Pinout:

1 – +

2 – -

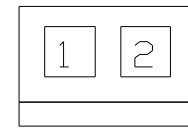

Circuit Example

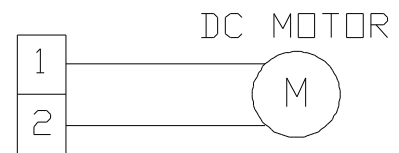

Powerful Connector (J11)

Usage: Connects H-Bridge driver to accessory devices such as a DC motor or light. Controlled by coprocessor. Polarity can be controlled.

Type: 2 pin, MTA, .1"

Voltage: 12 volts

Maximum Current: 500ma

Pinout:

1 – +

2 – -

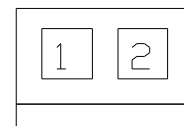

Circuit Example

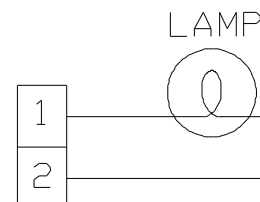

Expansion Connector (J1)

Usage: Connects controller to user devices.

Connector: 40 pin .1 IDC Header

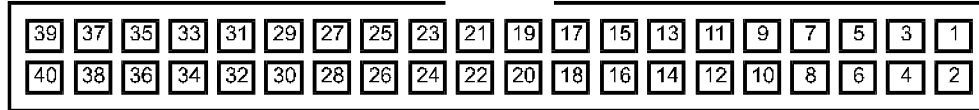

Pinout:

1 – Ground	21 – RB7 to coprocessor
2 – Ground	22 – Encoder signal
3 – +5 volts, 200ma max	23 – RC servo motor #1 (steering)
4 – +5 volts, 200ma max	24 – RC servo motor #2
5 – P0 of Basic Stamp II, Left whisker	25 – RC servo motor #3
6 – P1 of Basic Stamp II, Right whisker	26 – RC servo motor #4
7 – P2 of Basic Stamp II, to body conn.	27 – No connect
8 – P3 of Basic Stamp II, to body conn	28 – No connect
9 – P4 of Basic Stamp II	29 – No connect
10 – P5 of Basic Stamp II	30 – No connect
11 – P6 of Basic Stamp II	31 – No connect
12 – P7 of Basic Stamp II	32 – No connect
13 – P8 of Basic Stamp II, network I/O	33 – No connect
14 – P9 of Basic Stamp II, speaker	34 – No connect
15 – P10 of Basic Stamp II, Red LED	35 – No connect
16 – P11 of Basic Stamp II, Green LED	36 – No connect
17 – P12 of Basic Stamp II, Jumper #1	37 – No connect
18 – P13 of Basic Stamp II, Jumper #2	38 – No connect
19 – P14 of Basic Stamp II, Button #1	39 – No connect
20 – P15 of Basic Stamp II, Button #2	40 – No connect

Expansion Port RC Servo Motor Signals

All four RC servo motor signals are available on the expansion connector for use with user devices. These are the same signals available on J2, J3, J4, and J5. RC servo motor signal #1 (J2) is dedicated to the robot's steering motor. The signals are standard 1ms to 2ms positive going pulses at 50hz which is required by most RC servo motors.

Using very large servos that need a lot of current may require an additional power supply to prevent overload or electrical noise that could crash the Basic Stamp II or coprocessor.

Expansion Port Circuit Examples

ARobot's expansion connector provides access to the Basic Stamp II's I/O pins, to the RC servo motor signals, and to the wheel encoder's signal. These signals can be used to control accessories and to read sensors. +5 volts is made available to power accessories. Observe current specifications to prevent overload of the power supply components on the controller board. Many unused pins are also available that can be soldered to various signals on the controller board or to components in the prototype area.

Breadboards and Perfboards

ARobot's controller board is the same size and has the same mounting hole pattern as breadboards and perfboards from Radio Shack – Part numbers 276-174 and 276-170 respectively (2" x 6"). The breadboard allows circuits to be created easily without soldering. The perfboard allow construction of more permanent circuits. Boards can be stacked on top of each other using long screws or spacers. Two sets of board mounting holes exist on ARobot's body. The set towards the rear is occupied by the controller board and the other set can be used to mount breadboards or perfboards.

Soldering and other basic electronic skills

Books are available from Radio Shack and other sources that teach basic electronic skills such as component identification and soldering. These subjects are beyond the scope of this text and will not be taught here. Expansion ideas in this book require these basic skills and knowledge.

Expansion port cables

The expansion connector is a common 40 pin dual row header with pins on .1" centers. The cable is 40 pin flat cable with .05" centers and is easily cut with scissors. Cable is crimped onto the connector by pressing. This is the same type of connector used for many disk drives on desktop computers. You can simply purchase a disk drive cable which has connectors and cut it to length or buy individual cable and connectors from an electronic supply company such as Radio Shack or Digi-Key.

Part sources

Here are some sources for electronic components useful for the robot experimenter:

Radio Shack

www.radioshack.com

Digi-Key Electronics

701 Brooks Ave. South
Thief River Falls, MN 56701 USA
800-344-4539
www.digikey.com

Mouser Electronics

958 N. Main St.
Mansfield, TX 76063 USA
800-346-6873
www.mouser.com

Expansion Port Cable

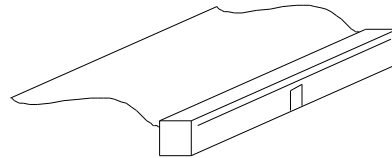

ARobot with Breadboard & Expansion

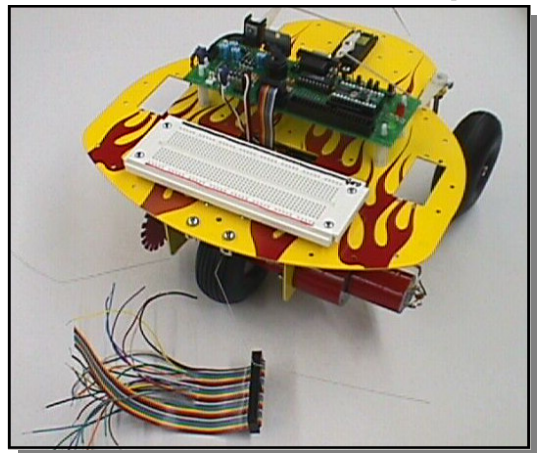

Expansion Port Circuit Examples continued

Digital Inputs -

Basic Stamp input signals can be used to read TTL level signals such as switches or sensors. The input signal should not exceed +5 volts DC or go below 0 volts. Each input pin has a pull-up resistor to +5 volts.

Sensor Input Example:

This example shows how to interface a sensor that has an open collector (OC) output to a digital input.

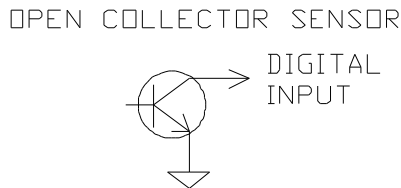

Switch Input Example:

This example shows how to interface a mechanical switch to one of the digital

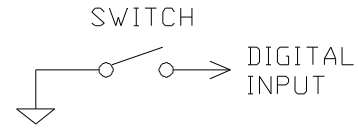

Digital Circuit Input Example:

This example shows how to attach logic gates to the digital input signals.



Digital/Power Output -

The digital signals can be used to control external circuitry. Large loads can be driven with an external power transistor such as a MOSFET. A clamping diode should be included to protect the transistor when switching inductive loads such as relays.

Digital Output Example

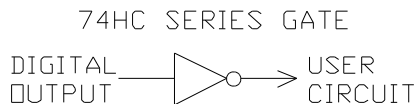

Power Output Example

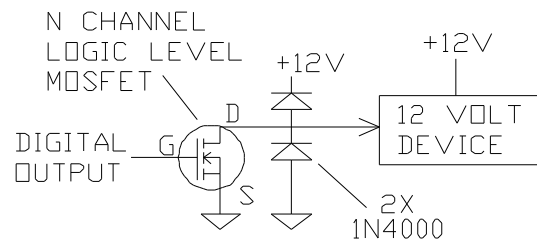

More expansion information

Our space is limited here so make sure to visit our web site for the latest expansion application notes complete with program examples. www.robotics.com/robot/projects.html

Also visit the Parallax web site which has an entire section dedicated to application notes for the Basic Stamp II. www.parallaxinc.com

Expansion Port Circuit Examples continued

Analog Inputs -

Analog inputs are inputs that can vary from 0 to 5 volts. While the Basic Stamp II doesn't have a true analog input, analog signals can be read using a little trick. This is done by adding a capacitor to ground on a digital I/O pin and a resistive sensor to +5 volts. The sensor value can be read by first setting the digital I/O pin low to drain the capacitor, then the I/O pin is changed into an input, the resistive sensor will gradually charge the capacitor towards +5 volts. The time it takes for the signal to read a logic one (high) is the value of the sensor.

Analog Light Sensor

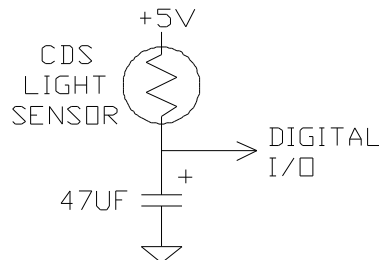

Basic Stamp II light sensor example code

```
'This routine demonstrates detecting light. The light level is  
'read by determining the time it takes to charge the capacitor.  
'The CDS photodetector changes resistance as the light  
'intensity changes. This changes the current that is charging the  
'capacitor. The output result is then output to the debug screen.
```

```
light var word                'light variable.  
  
main:  
  pause 500                    'check every half a sec.  
  
  low 2                         'drain cap.  
  pause 50                      'wait for cap to drain.  
  rctime 2,0,light              'time cap charging.  
  
  debug ? light                 'send result to PC.
```

More expansion information

Our space is limited here so make sure to visit our web site for the latest expansion application notes complete with program examples. www.robotics.com/robot/projects.html

Also visit the Parallax web site which has an entire section dedicated to application notes for the Basic Stamp II. www.parallaxinc.com

Coprocessor Network Expansion

The complete application note for coprocessor expansion can be found on our website at:

www.robotics.com/arobot/projects.html

A coprocessor is one of the most powerful expansions that can be added to ARobot. A coprocessor can remove time consuming tasks from the master processor, leaving it for higher level routines. The coprocessor could be used to add a ring of sonar range finders, read a time consuming compass, process video images, control motors, etc. Any microprocessor, embedded PC, or computer can be used as a coprocessor. A Basic Stamp II is an excellent choice because it doesn't need any external circuitry to communicate with ARobot's controller. The Basic Stamp II can also be programmed by plugging it into ARobot's controller which eliminates the need for a programmer.

Communications

ARobot's controller can communicate in a serial fashion with the coprocessor using the dedicated coprocessor network pin (P8 on the Basic Stamp) or by using any other unused pin(s). A program on the coprocessor will receive commands from the master (ARobot's controller) and respond accordingly. Review the coprocessor command summary to see how commands must be constructed to prevent communication conflicts.

Basic Stamp II Coprocessor

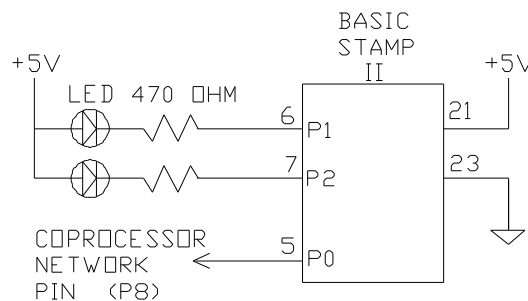

Multiple Basic Stamp II Coprocessors

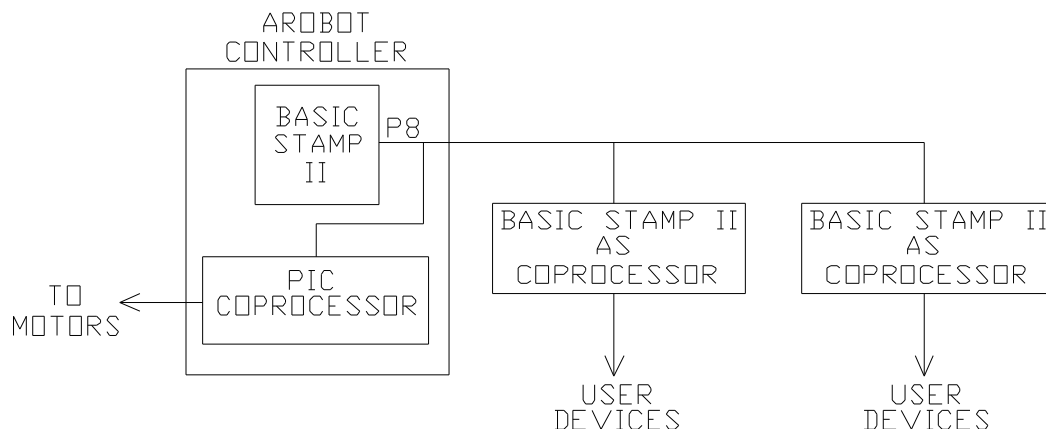

Using Other Controllers

ARobot's controller board is designed to accept the Basic Stamp II controller chip made by Parallax (www.parallaxinc.com). Parallax makes other Basic Stamp II compatible controllers which offer more memory and greater speed. Other manufacturers also make controllers that are compatible with the Basic Stamp II and most of them should work fine with ARobot's controller board.

It is possible to remove the Basic Stamp II and use a different type of high-level controller board. Instead of removing ARobot's entire controller board, leave it to make use of the DC motor drivers, powerful output, encoder sensor circuit, RC servo motor drivers, speaker, LEDs, switches, and power regulation that is available there. Simply make a cable between the two controllers.

Cabling between ARobot's controller and another controller

You have two cabling choices: #1 Cable from the Basic Stamp II socket to the new controller, #2 Cable from the expansion port to the new controller. See the expansion port connector pinout and the Basic Stamp II pinout in the schematic for pin numbers and signal usage. Cabling to the Basic Stamp II socket will allow access to the RS-232 connector, raw DC voltage, and the reset button. These signals could also be wired to unused pins on the expansion connector if needed. Signals that go directly from the Basic Stamp II socket to the Expansion connector and are not used anywhere else can be ignored. The ones you're interested in are the signals that go to the coprocessor, whiskers, LEDs, speaker and other devices you wish to utilize. See the coprocessor command structure section of this manual to learn how to control the DC drive motor, RC servo motors, and powerful output through the coprocessor.

Using ARobot's controller as a coprocessor

Another option is to use ARobot's existing controller with a Basic Stamp II installed as a coprocessor which receives commands from a master controller. Communication between these two controllers could be accomplished using the serial port. A program could be written on the Basic Stamp II that would respond to commands as needed. This arrangement would offload motor control and other tasks such as whisker reflexes to the coprocessor and free up the master processor.

Using ARobot's controller as a coprocessor

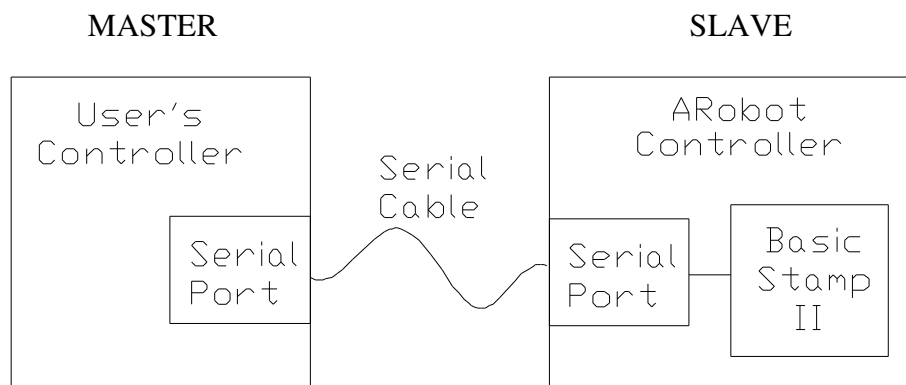

Suggested Reading

PC AI Magazine

Knowledge Technology, Inc.
3310 West Bell Rd., Suite 119
Phoenix, AZ 85023
(602) 971-1869
Periodical covering PC-based AI topics.

Robot Science & Technology Magazine

Dedicated to Real Robots.
2351 Sunset Blvd. Suite 170
Rocklin, CA 95765
<http://www.robotmag.com>
1-888-510-7728

Robotics Digest

Practical Applications of Systems, Control,
Vision, Motion, and Navigation in Robotic
Mechanisms.
Willian E. Gates
1700 Washington Ave.
Rocky Ford, CO 81067
719-254-4558
102505.3055@compuserve.com

AI Magazine

AAAI
445 Burgess Dr.
Menlo Park, CA 94025
(415) 328-3123
Periodical by the American Association for
Artificial Intelligence.

Computer Applications Journal

4 Park St. #20
Vernon, CT 06066
(203) 875-2751
Monthly periodical covering computer control
projects.

Embedded Systems Programming

Miller Freeman Inc.
600 Harrison St.
San Francisco, CA 94107
(415) 905-2200
Monthly periodical covering embedded
computer programming.

Robot Builder's Bonanza

By Gordon McComb
Tab Books
ISBN 0-8306-2800-2
Book popular among some robot hobbyist
containing many circuits and ideas about robot
building. Some circuits do not work when
breadboarded.

Artificial Life Explorer's Kit

By Ellen Thro
Sams Publishing
ISBN 0-672-30301-9
Book covering artificial life, cellular automata
and other various other interesting topics. Disk
included.

Artificial Life Lab

By Rudy Rucker
Waite Group Press
ISBN 1-878739-48-4
Book covering artificial life programming and
related topics. Disk included.

Component Suppliers

The following list of suppliers has been compiled to help in the expansion of ARobot. These vendors offer such items as single board computer, sensors and actuators. Most of the companies listed have catalogs which contain detailed part and technical information and can be obtained at little or no cost.

Ampro Computers

990 Almanor Ave.
Sunnyvale, CA 94086
(408) 522-2100

Manufactures a wide variety of computers and controller boards including PC/104 based systems.

Boston Gear

14 Hayard St.
Quincy, MA 02171
(800) 343-3352

A good selection of medium and large gears, pulleys, gear reducers and shaft components.

DU-BRO Products, Inc.

P.O. Box 815
Wauconda, IL 60084
(708) 526-2136

Manufactures minature servo linkages and hardware.

Edmund Scientific

101 E. Gloucester Pike
Barrington, NJ 08007
(609) 573-6250

Optical and other educational supplies and equipment.

Helical Products

901 W. McCoy Lane
Santa Maria, CA 93456
(805) 928-3851

Manufactures precision shaft couplers.

McMaster-Carr Supply Company

P.O. Box 740100
Atlanta, GA 30374
(404) 346-7000

Huge catalog containing mechanical parts, tools and materials.

Mouser Electronics

2401 Hwy 287 N.
Mansfield, TX 76063-4827
(800) 346-6873

Distributor carrying a variety of electronic components.

Nordex

50 Newtown Rd.
Danbury, CT 06810-6216
(203) 792-9050

Source for small gears, bearings, shafts and various other precision components.

Parallax Inc.

3805 Atherton Road #102
Rocklin, CA 95765
<http://www.parallaxinc.com>

Makers of the Basic Stamp and related tools and accessories.

PIC Design

P.O. Box 1004
Middlebury, CT 06762
(203) 758-8272

Stocks a wide variety of gears, pulleys, bearings and lead screw assemblies.

SAVA Industries

70 Riverdale Rd.
Riverdale, NJ 07457
(201) 835-0882
Manufactures cables and pulleys.

Small Parts

6891 N.E. 3rd Ave.
P.O. Box 381736
Miami, FL 33238-1736
(305) 751-0856
This company stocks a broad range of precision parts such as screws, tubing, and tools.

Stock Drive Products

2101 Jericho Turnpike
New Hyde Park, NY 11040
(516) 328-0200
Broad line of precision mechanical components available including gears, pulleys, bearings and hardware. Metric sizes. Several catalogs and technical books are available.

SuperCircuits

13552 Research Blvd, #B
Austin, TX 78750
(512) 335-9777
Small video products including cameras and transmitters

Tower Hobbies

P.O. Box 9078
Champaign, IL 61826-9078
(800) 637-6050
Catalog lists a wide variety of model kit components such as servos and linkages.

Winfred M. Berg

499 Ocean Ave.
East Rockaway, NY 11518
(516) 599-5010
The Berg catalog contains gears, bearings and large assortment of unusual belts and pulley systems.

Z-World Engineering

1724 Picasso Ave.
Davis, CA 95616
(916)757-3737
Manufactures single board computer for control applications.

Internet Robot Resources

The Internet contains a wide variety of resource pertaining to robots. Virtually all Universities provide research documents and files on the Internet for those interested. Many contain information about robot programming, navigation and control issues. This information can be obtained using a Web browser such as Netscape or via FTP (File Transfer Protocol). Various newsgroups are available that allow readers to exchange ideas and ask questions.

Arrick Robotics maintains an Internet Web Site at **www.robotics.com**. At this site you can browse pages describing various product offerings and view the latest demonstration code and example programs. You can also send e-mail to **info@robotics.com** to get technical and sales questions answered.

The following information is a sample of robot-related information available on the Internet at the time this manual was printed.

Web Sites

www.robotics.com/arobot - A Robot Information Page, FAQ, Projects, etc.

www.robotics.com/arobot/faq.html - A Robot FAQ.

www.robotics.com/arobot/projects.html - A Robot Projects.

www.parallaxinc.com - Parallax Basic Stamp Information

www.robotics.com/robots.html - Robotics Information Central, Tons of good links.

www.robotics.com/mechpart.html - Mechanical Parts Source List

www.robotics.com/robomenu - The RoboMenu allows you to show off your robot

www.robotics.com/motors.html - What's the difference between servo and stepper motors

www.robotics.com/highload.html - Driving high-power loads

www.controlled.com - Journal of Computer Controlled Systems, PC/104

www.dprg.org - Dallas Personal Robotics Group

www.frc.ri.cmu.edu/robotics-faq - The Robotics FAQ (Frequently Asked Questions)

www.ncc.com/misc/rcfaq.html - The Robotics Competition FAQ

www.cs.ruu.nl/wais/html/na-dir/microcontroller-faq/.html - Microcontroller FAQ

www.realtime-info.be/encyc/techno/publi/faq/rtfaq.htm - Real Time Computing FAQ

piglet.cs.umass.edu:4321/robotics.html - UMass Laboratory for Perceptual Robotics

mpfwww.jpl.nasa.gov - NASA Mars Pathfinder

www.yahoo.com/Science/Engineering/Mechanical_Engineering/Robotics/ - Robotics at Yahoo

robotics.eecs.berkeley.edu/ - UC Berkeley Robotics and Intelligent Machines Lab

cwis.usc.edu/dept/robotics/ - Univ of S. CA Robotics Research Lab

www.ai.mit.edu - Artificial Intelligence at MIT

sfbox.vt.edu:10021/A/afalck/www/research/Controls-2.html - Line Following by Arturo Falck

www.hut.fi/Misc/Electronics/opto.html - Tomi Engdahl's Optoelectronics / IR Page

turbine.kuee.kyoto-u.ac.jp/staff/onat/servobasics.html - RC Servo Motor Basics by Ahmet ONAT

www.engin.umich.edu/research/mrl/00MoRob_19.html - Robotics Aids for the Disabled

ranier.oact.hq.nasa.gov/telerobotics_page/telerobotics.shtm - Telerobotics at NASA

For more links see: **www.robotics.com/robots.html**

Internet News Groups

The following newsgroups are a goldmine of information. Most newsgroups have a FAQ (frequently asked questions) file associated with them that will answer many questions about the particular subject. Questions not answered in the FAQ can be posted to the newsgroup for a direct response from other readers. Parallax also offers a Basic Stamp forum – see www.parallaxinc.com

Newsgroup Name	Description
comp.robotics.misc	All aspects of robots and their applications.
comp.ai	Artificial intelligence discussions.
comp.ai.alife	Research about artificial life.
comp.ai.fuzzy	Fuzzy set theory, aka fuzzy logic.
comp.ai.genetic	Genetic algorithms in computing.
comp.ai.jair.announce	Announcements of the Journal of AI Research.
comp.ai.jair.papers	Papers published by the Journal of AI Research.
comp.ai.nat-lang	Natural language processing by computers.
comp.ai.neural-nets	All aspects of neural networks.
comp.ai.nlang-know-rep	Natural Language and Knowledge Representation.
comp.ai.philosophy	Philosophical aspects of Artificial Intelligence.
comp.ai.shells	Expert systems and other artificial intelligence shells.
comp.ai.vision	Vision processing.
comp.cog-eng	Cognitive engineering.
comp.edu.languages.natural	Computer assisted languages instruction issues.
comp.graphics.visualization	Info on scientific visualization.
comp.home.automation	Home automation devices, setup, sources, etc.
comp.lang.prolog	Discussion about PROLOG.
comp.lang.smalltalk	Discussion about Smalltalk 80.
comp.realttime	Issues related to real-time computing.
comp.robotics.misc	All aspects of robots and their applications.
comp.speech	Speech processing
comp.std.wireless	Examining standards for wireless network technology.
comp.sys.transputer	The Transputer computer and OCCAM language.
misc.books.technical	Discussion of books about technical topics.
misc.creativity	Promoting the use of creativity in all human endeavors.
rec.games.mecha	Giant robot games.
rec.models.rc	Radio-controlled models for hobbyists.
rec.radio.amateur.digital.misc	Packet radio and other digital radio modes.
rec.toys.lego	Discussion of Lego, Duplo (and compatible) toys.
rec.video	Video and video components.
sci.engr.control	The engineering of control systems.
sci.engr.mech	The field of mechanical engineering.
sci.fractals	Objects of non-integral dimension and other chaos.
sci.image.processing	Scientific image processing and analysis.
sci.lang	Natural languages, communication, etc.
sci.nanotech	Self-reproducing molecular-scale machines.
sci.virtual-worlds	Virtual Reality - technology and culture.
sci.virtual-worlds.apps	Current and future uses of virtual-worlds technology.

Troubleshooting

The following list describes the most common problems and their remedies.

Check our FAQ (Frequently Asked Questions) at www.robotics.com/robot/faq.html

Problem: Turning the power switch ON does not result in any activity.

Remedy: ARobot is not getting power. Insure that the batteries are good and installed correctly. Insure that the batteries are touching the contacts on the battery holder. Insure that the power connector is plugged into the controller card correctly. Remove any expansion connector to eliminate the possibility of defective expansion circuitry.

Problem: Whiskers activate without being touched

Remedy: Make sure all whisker wires are resting in the center of the bracket's hole. Make sure that the screw that holds the wire is tight.

Problem: Drive motor never stops when asked to go a certain distance.

Remedy: The optical encoder system is not working. Check the cabling and connectors. Make sure that the encoder wheel is INSIDE the slot of the encoder sensor. Make sure that the entire front wheel assembly is tight.

Problem: ARobot will not move even though the drive motor is turning.

Remedy: Tighten all the nuts on the front drive axle. Don't damage the threads of the axle. If the rubber part of the wheel is turning against the plastic hub, you'll probably have to squirt some glue between the rubber and the plastic to keep them together.

Problem: ARobot quits working when the drive motor or accessory is activated.

Remedy: A low battery could cause this. Or an accessory that is defective or pulling too much current or creating electrical noise.

Problem: Communication can not be established with ARobot.

Remedy: Insure that you are using the correct communications parameters. Make sure you are using the right serial (COMM) port number. Check cable connections.

Problem: ARobot does not drive in a straight line when requested to.

Remedy: Make sure you're using a steering direction of 80. Adjust the steering arms using the steering program. Make sure the servo horn on the steering motor is straight when in the center of travel.

Problem: Some other problem.

Remedy: If you've read the manual and our on-line FAQ but the problem still can't be resolved, don't waste another second, e-mail us at info@robotics.com for the answer!

Warranty Information

ARRICK ROBOTICS warrants this product to be in good working order for a period of one (1) year from the date of purchase. Should this product fail to be in good working order at any time during this period, ARRICK ROBOTICS will, at its option, repair or replace the product at no additional charge except as set forth below. This limited warranty does not include service to repair damage to the product resulting from accident, disaster, misuse, abuse, or modification of the product. To obtain warranty service, send the product along with proof of purchase in its original packaging to:

ARRICK ROBOTICS
Attn: Repair Dept.
10768 Technology Dr. CR2335
Tyler, TX 75707 USA

You agree to prepay shipping charges and to insure the product or assume the risk of loss or damage in transit. All express or implied warranties for this product including the warranties of merchantability and fitness for a particular purpose are limited in duration to a period of one (1) year from the date of purchase, and no warranties, whether expressed or implied, will apply after this period.

If this product is not in good working order as warranted above, your sole remedy shall be repair or replacement as provided above. In no event will ARRICK ROBOTICS be liable to you for damages, including any lost profits, lost savings or other incidental or consequential damages arising out of the use of or inability to use this product.

Some states do not allow limitations on how long an implied warranty lasts, so the above limitations may not apply to you. Some states do not allow the exclusion or limitation of incidental or consequential damages for consumer products, so the above limitations may not apply to you. This warranty gives you specific legal rights and you may also have other rights which may vary from state to state.



Robotics.com

Free Manuals Download Website

<http://myh66.com>

<http://usermanuals.us>

<http://www.somanuals.com>

<http://www.4manuals.cc>

<http://www.manual-lib.com>

<http://www.404manual.com>

<http://www.luxmanual.com>

<http://aubethermostatmanual.com>

Golf course search by state

<http://golfingnear.com>

Email search by domain

<http://emailbydomain.com>

Auto manuals search

<http://auto.somanuals.com>

TV manuals search

<http://tv.somanuals.com>