

Cat. No. 43-986
OWNER'S MANUAL

Please read before using this equipment.

System 1250

**Caller ID Telephone
with Call Waiting ID**



RadioShack®

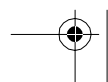
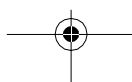

FEATURES

Your RadioShack System 1250 Caller ID Telephone combines a telephone and a Caller ID unit in one system. It shows the caller's telephone number (and name, if available in your area) and the current date and time, as provided by your local phone company to Caller ID service subscribers. (The date and time are updated with each incoming call). It saves up to 60 Caller ID records that you can review and call back.

And, if you have Call Waiting with Caller ID, the System 1250 shows you the incoming caller information, even when you are already on the phone.

Your System 1250 has these features:

3-Line Liquid Crystal Display — lets you view an entire Caller ID record on one screen.

Caller ID Memory — stores up to 60 Caller ID records with name and number or name only, depending on the information your phone company provides.

Call Waiting ID — displays Caller ID information about an incoming call when you are on the phone (if you subscribe to this service from your local phone company).

New Call Indicator — lets you see at a glance that you have new calls.

Trilingual — displays Caller ID messages in English, French, or Spanish.

20-Number Memory Dialing — you can store up to 20 numbers in memory for easy dialing.

Headset Jack — lets you connect an optional headset (available at your local RadioShack store) for hands-free convenience.

Volume Control — lets you adjust the volume of the sound you hear through the handset.

Redial — lets you quickly redial the last number dialed.

Flash — sends an electronic switch-hook signal for use with special phone services such as Call Waiting.

Hold — lets you put a call on hold.

Adjustable Ringer Volume — lets you set the ringer to low or high, or even turn it off.

Review Scrolling — lets you easily scroll through all records in Caller ID memory.

Callback — lets you dial the phone number in a Caller ID record with the touch of a button.

Programmable Area Codes — lets you store your local area code and up to two others for easy local callback.

Message Waiting — lets you know that you have received a voice mail message (if you subscribe to a message waiting service from your local telephone company).

Clock — shows the date and time as provided to Caller ID service subscribers by your local phone company. (Each incoming call updates the clock).

Tone/Pulse Dialing — lets you use either type of service, and you can easily switch from pulse to tone dialing for long-distance, bank-by-phone, or other special services.

Hearing-Aid Compatible — lets you use the System 1250 with hearing aids that have a T (telephone) switch.

This telephone has been tested and found to comply with all applicable UL and FCC standards.

We recommend you record the System 1250's serial number here. The number is on the bottom of the phone.

Serial Number: _____

Important Caller ID Information



To use the phone's Caller ID and Call Waiting features, you must be in an area where Caller ID and Call Waiting services are available and you must subscribe to those services.

Where Caller ID is offered, one or more options are generally available:

- caller's number only
- caller's name only
- caller's name and number

To use the System 1250's Caller ID memory dial feature, you must receive the caller's number.

Warning: To prevent fire or shock hazard, do not expose this product to rain or moisture.

	CAUTION RISK OF ELECTRIC SHOCK. DO NOT OPEN.	
CAUTION: TO REDUCE THE RISK OF ELECTRIC SHOCK, DO NOT REMOVE COVER OR BACK. NO USER-SERVICEABLE PARTS INSIDE. REFER SERVICING TO QUALIFIED PERSONNEL.		



This symbol is intended to alert you to the presence of uninsulated dangerous voltage within the product's enclosure that might be of sufficient magnitude to constitute a risk of electric shock. Do not open the product's case.



This symbol is intended to inform you that important operating and maintenance instructions are included in the literature accompanying this product.

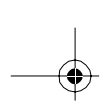

READ THIS BEFORE INSTALLATION

We have designed your phone to conform to federal regulations and you can connect it to most phone lines. However, each device that you connect to the telephone line draws power from the line. We refer to this power draw as the phone's *ringer equivalence number*, or REN. The REN is shown on the bottom of your phone.

If you use more than one phone or other device on the line, add up all the RENs. If the total is more than five, your phones might not ring. In rural areas, a total REN of three might impair ringer operation. If ringer operation is impaired, remove one of the devices from the line.

FCC STATEMENT

Your telephone complies with Part 68 of *FCC Rules*. Upon request, you must provide the phone's FCC registration number and REN to your telephone company. These numbers are on the bottom of the base.

Note: You must not connect your telephone to:

- Coin-operated systems
- Party-line systems
- Most electronic key phone systems

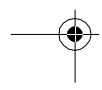
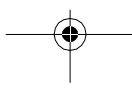
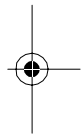
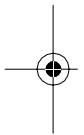

CONTENTS

Preparation	6
Installing a Backup Battery	6
Mounting the Phone	7
On a Desk	7
On a Wall or Wall Plate	8
Connecting the Handset	10
Setting the Dialing Mode	10
Setting the Ringer Volume	10
Setting the Display Language	11
Setting the Area Codes	11
Setting the Display Contrast	11
Telephone Operation	12
Setting the Handset's Volume	12
Using Redial	12
Using Flash	12
Using Hold	13
Using Tone Services on a Pulse Line	13
Memory Dialing	14
Storing a Number in Memory	14
Entering a Pause in a Memory Number	15
Dialing a Memory Number	15
Chain-Dialing	15
Testing Stored Emergency Numbers	15
Using a Headset	16
Caller ID Operation	17
Caller ID Messages	18
Reviewing Caller ID Records	19
Using Callback	19
Storing Caller ID Numbers in Memory	20
Deleting Caller ID Records	20
Troubleshooting	21
Care and Maintenance	22
The FCC Wants You to Know	23
Lightning	23

PREPARATION

INSTALLING A BACKUP BATTERY

You can install an optional 9V backup battery so if the AC power fails or you unplug the phone (☞ appears), the System 1250 will save the memory numbers and Caller ID records. We recommend you use an alkaline battery, such as RadioShack Cat. No. 23-553.

Caution: Use only a fresh battery of the required size and recommended type.

Follow these steps to install a battery.

1. Use a Phillips screwdriver to remove the battery compartment cover's screw on the bottom of the system, then remove the cover.

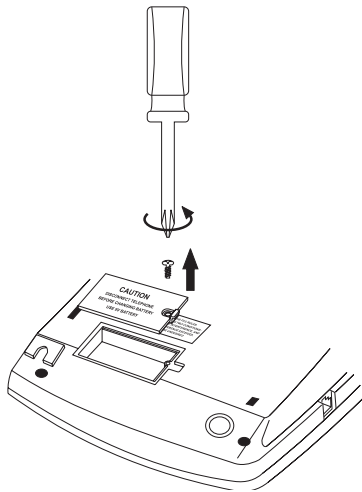

2. Place a fresh battery into the compartment as indicated by the polarity symbols (+ and -) marked inside.

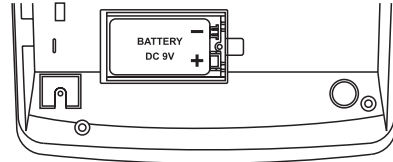

3. Replace the cover and secure it with the screw.

The System 1250 automatically tests the battery each time it receives a call. If ☞ appears or the display dims, replace the battery.

Important: You must install the fresh battery within 2 minutes after removing the old battery. Otherwise, you might lose the information stored in the phone's memory.

Cautions:

- Always remove old or weak batteries. Batteries can leak chemicals that can destroy electronic parts.
- Dispose of old batteries promptly and properly. Do not burn or bury them.

MOUNTING THE PHONE

You can place the phone on a desk or table, mount it on a standard wall plate, or mount it directly on a wall.

Select a location that is:

- Near an AC outlet
- Near a modular phone line jack
- Out of the way of normal activities

Notes:

- Your telephone connects directly to a modular phone line jack. If your phone line jack is not a modular jack, you can update the wiring yourself, using jacks and adapters available from your local RadioShack store. Or, you can let the telephone company update the wiring for you.
- The USOC number of the jack to be installed is RJ11C, or RJ11W for a wall plate jack.

Caution: The supplied AC adapter was designed specifically for your System 1250. Use only the supplied adapter.

On a Desk

1. Remove the mounting bracket by holding in the tab on the right side of the bracket and gently pulling out the bracket.

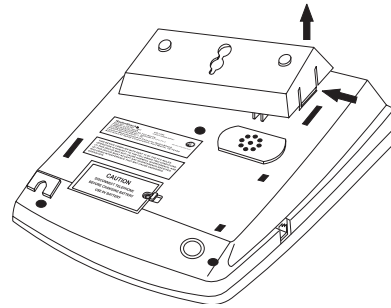

2. Plug one end of the supplied long modular cord into the phone jack on the back of the phone.

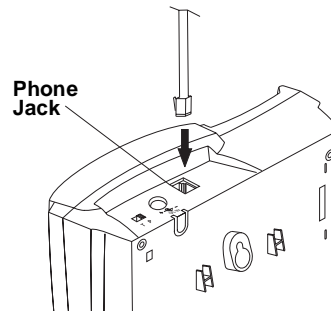

3. Insert the supplied AC adapter's barrel plug into the **DC 9V** jack on the back of the phone.

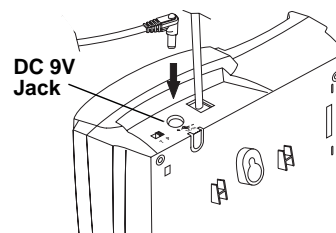

4. Route the adapter's cord through the strain relief slot on the back of the phone.

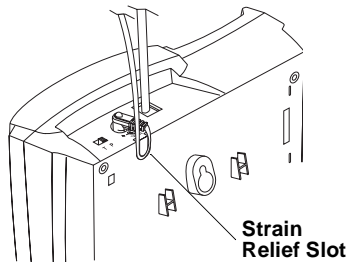

5. Insert the bracket's two small tabs into the matching slots near the top of the phone and snap the bracket into place.

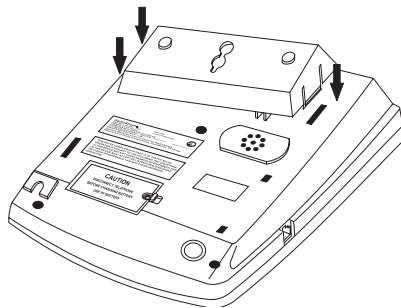

6. Plug the other end of the modular cord into a modular phone line jack.
7. Plug the adapter into a standard AC outlet.

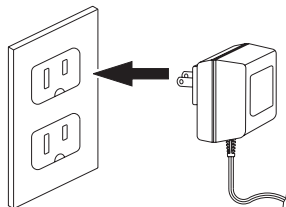

On a Wall or Wall Plate

Note: To mount the System 1250 directly on a wall, you need two screws (not supplied) with heads that fit the keyhole slots on the bottom of the phone. Drill two holes $3^{15}/16$ inches (100 mm) apart. Then thread a screw into each hole, letting the heads extend about $5/16$ inch (7 mm) from the wall.

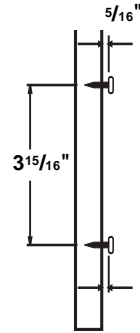

1. Remove the mounting bracket by holding in the tab on the right side of the bracket and gently pulling out the bracket.

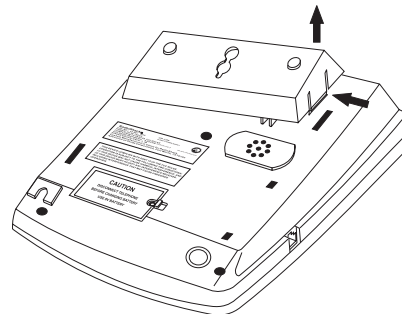

2. Insert the bracket's two small tabs into the matching slots near the bottom of the phone and snap the bracket into place.

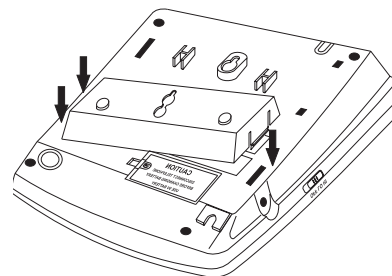

3. Plug the supplied long modular cord (or the short cord for a wall plate) into the phone jack on the back of the phone.

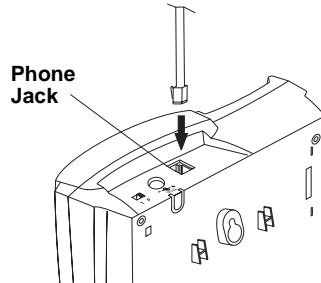

4. Insert the supplied AC adapter's barrel plug into the DC 9V jack.

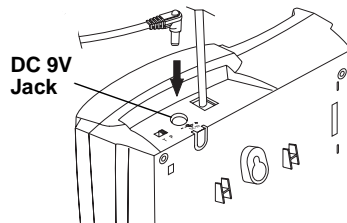

5. If you are mounting the phone on a wall plate, route the adapter cord as shown. Plug the modular cord into the wall plate jack, then align the phone's keyhole slots with the wall plate studs and slide the phone downward to secure it.

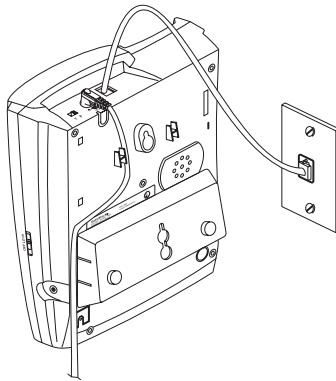

If you are mounting the phone on a wall, route the adapter and modular cords as shown. Align the phone's keyhole slots with the screws and slide the phone downward to secure it, then plug the modular cord into a modular phone line jack.

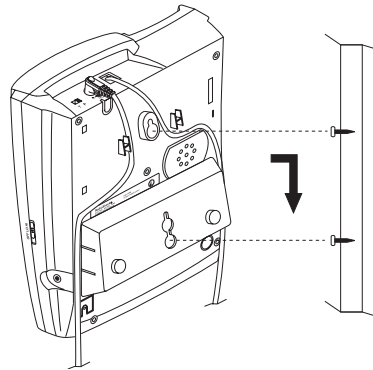

6. Plug the adapter into a standard AC outlet.

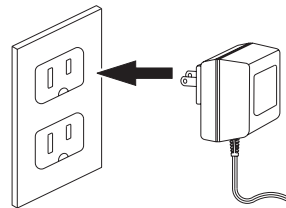

CONNECTING THE HANDSET

Plug one end of the supplied coiled cord into the modular jack on the left side of the phone and the other end into the modular jack on the handset. Then place the handset on the base.

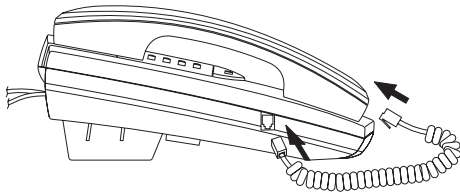

Note: Your local RadioShack store sells a variety of longer coiled handset cords, which are especially useful when you mount the phone on the wall.

SETTING THE DIALING MODE

Set **T/P** (Tone/Pulse) for the type of service you have. If you are not sure which type you have, do this simple test.

1. Be sure **T/P** is set to **T**.

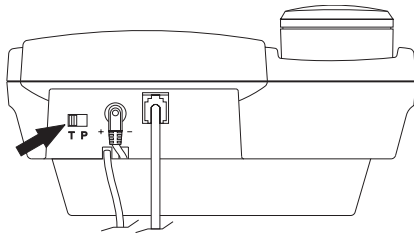

2. Lift the handset and listen for a dial tone.

3. Press any number except 0.

Note: If your phone system requires that you dial an access code (9, for example) before you dial an outside number, do not press the access code either.

If the dial tone stops, you have touch-tone service. If the dial tone continues, you have pulse service.

4. If you have pulse service, set **T/P** to **P**. Otherwise, leave it set to **T**.

SETTING THE RINGER VOLUME

RINGER controls the volume of the phone's ring. To adjust the ringer volume, set **RINGER** to **HI** or **LO**.

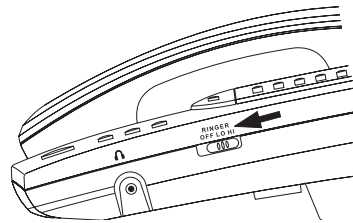

If you do not want the ringer to sound, set **RINGER** to **OFF**. You can still make calls with the ringer off, and you can answer calls if you hear another phone on the same phone line ring or if you see the **NEW CALL** indicator flashing.

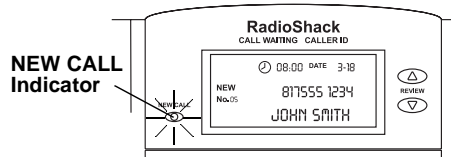

SETTING THE DISPLAY LANGUAGE

The System 1250 is preset to show caller ID messages in English, but you can change that. Follow these steps to change the language to French or Spanish.

Note: If you do not finish a step within 15 seconds, the phone exits from setup.

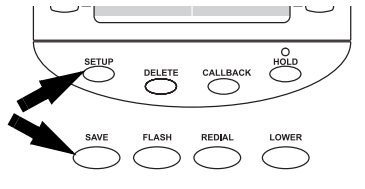

1. Press **SETUP**. The currently set language appears. To change it, press:
Q to select English
0 to select French
to select Spanish
2. Press **SAVE**.
3. You can set your area codes at this point (see "Setting the Area Codes") or press **SETUP** to exit.

SETTING THE AREA CODES

Follow these steps to store your home area code and up to two others that do not require you to dial a "1" before them into the System 1250's memory.

Note: If you do not finish a step within 15 seconds, the phone exits from setup.

1. Press **SETUP** then **SAVE**. **01** and **ENTER AREA CODE** appear.

2. Enter your local area code then press **SAVE**. **02** and **ENTER AREA CODE** appear.

Note: If you make a mistake, simply re-enter the code before you press **SAVE**.

3. If you do not need to enter a second area code, press **SAVE**. Or, enter a second area code then press **SAVE**. **03** and **ENTER AREA CODE** appear.

4. If you do not need to enter a third area code, press **SAVE**. Or, enter a third area code then press **SAVE**. **03** and **ENTER AREA CODE** appear.

5. You can set the display contrast at this point (see "Setting the Display Contrast") or press **SETUP** to exit.

To delete an area code, press **SETUP** then repeatedly press **SAVE** until you see the area code you want to delete. Press **DELETE** then **SETUP**.

SETTING THE DISPLAY CONTRAST

To adjust the display contrast, press **SETUP** then press **SAVE** four times. **CONTRAST** appears, followed by a number from **1** (lightest) to **4** (darkest). Press a number key to adjust the display contrast, then press **SAVE**.

Note: If you do not finish a step within 15 seconds, the phone exits from setup.

TELEPHONE OPERATION

You make and answer calls with your System 1250 as you would with any other phone. You see the number as you dial, then (after 15 seconds) the elapsed time for this call.

SETTING THE HANDSET'S VOLUME

You can select any of three volume settings by repeatedly pressing **VOLUME** s or t during a call.

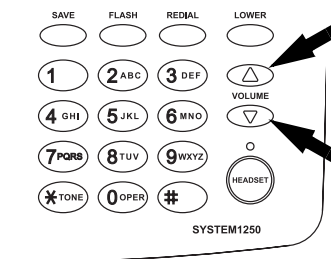

The display shows **VOL. :** and **1 MIN** for low volume; **2** for medium volume; and **3 MAX** for high volume. After each call, the System 1250 resets to the minimum volume level.

USING REDIAL

The redial memory holds up to 24 digits, so it can store long-distance as well as local numbers. To redial the last number you dialed, lift the handset then press **REDIAL**.

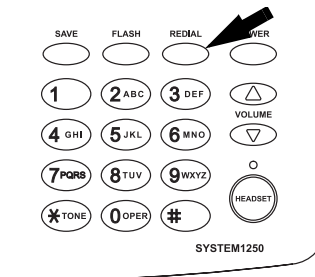

Note: The redial memory only stores the first 24 digits of any number dialed.

USING FLASH

Use **FLASH** to perform the switchhook operation for special services, such as Call Waiting.

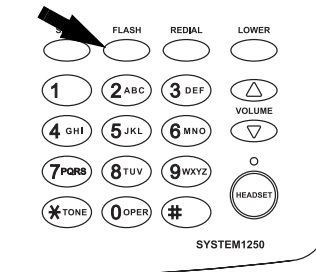

For example, if you have Call Waiting, press **FLASH** to take an incoming call without disconnecting the current call. Press **FLASH** again to return to the first call.

Note: If you do not have special phone services, pressing **FLASH** might disconnect the current call.

USING HOLD

To put a caller on hold, press **HOLD**. The **HOLD** indicator lights.

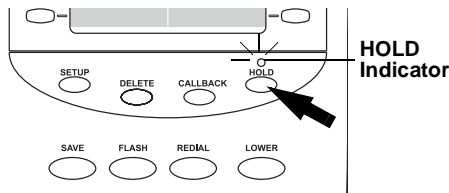

To resume the call, press **HOLD** again or pick up an extension phone on the same line.

Notes:

- Caller ID information does not appear for an incoming call while a call is on hold.
- We do not recommend keeping a call on hold for very long if you subscribe to Caller ID. The Caller ID information sent by the phone company might disconnect the call on hold if a new call comes in.

USING TONE SERVICES ON A PULSE LINE

If you have pulse service, you can still use special services that require tone signals, such as bank-by-phone, by following these steps.

1. Be sure **T/P** is set to **P**.
2. Dial the service's main number.
3. When the service answers, press *****. **␣** appears. Any additional numbers you dial are sent as tone signals.

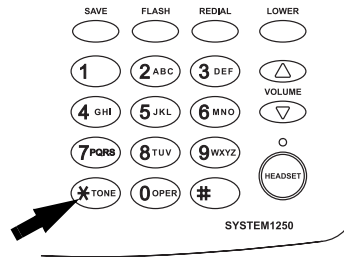

After you complete the call and hang up, the phone resets to pulse dialing.

MEMORY DIALING

You can store up to 20 numbers in memory and dial any stored number by pressing one or two keys.

Each stored number can be up to 24 digits long.

Storing a Number in Memory

The System 1250 has 10 memory location buttons, and each button can recall two stored numbers: one upper memory number and one lower memory number.

Follow these steps to store a number in memory.

Notes:

- You must complete each step within 15 seconds.
- To keep your accounts secure, we recommend you do not store personal access codes for services such as bank-by-phone.
- Leave the handset on the base when you store numbers.

1. Press **SAVE**. **ENTER NUMBER** appears.

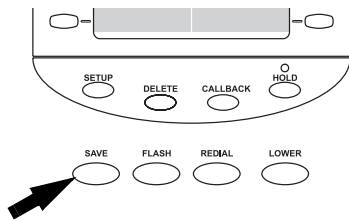

2. Enter the number you want to store, including any pause or **TONE** entries (see “Entering a Pause in a Memory Number” on Page 15 or “Using Tone Services on a Pulse Line” on Page 13).

You can store the very last number you dialed by pressing **REDIAL**.

Notes:

- If you make a mistake while entering the number, press **SAVE** to exit and start again at Step 1.
- If you enter more than 24 digits, the number flashes. Wait 15 seconds or press **SAVE** to exit and start again at Step 1.

3. Choose a memory location and store the number there.

- To store an upper memory location, simply press a memory location button.
- To store a lower memory location, press **LOWER** (**LO** appears), then press a memory location button.

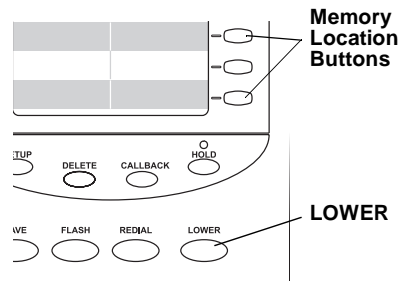

4. To keep a record of each stored number, use a flat-blade screwdriver to lift the plastic cover from the telephone number index card. Write the name on the index card. For easy reference, you can use the shaded areas for lower memory numbers and the blank areas for upper memory numbers. Use a pencil in case you want to change it later.

Entering a Pause in a Memory Number

In some telephone systems, you must dial an access code (9, for example) and wait for a second dial tone before you can dial an outside number. You can store the access code with the phone number; however, you should also store a pause after the access code to allow the outside line time to connect. To do so, press **REDIAL** to enter a 2-second pause. **P** (pause) appears. For a longer pause, press **REDIAL** again.

Note: Each pause entry uses one digit of memory.

Dialing a Memory Number

To dial a number stored in an upper memory, press the desired memory location button.

To dial a number stored in a lower memory, press **LOWER** then the desired memory location button.

Chain-Dialing

For quick recall of numbers for special services (such as bank-by-phone or alternate long-distance), you can store each group of numbers in its own memory location. Then, when calling special services, dial the service's main number first. At the appropriate place in the call, press the memory location button for the additional numbers you want to send.

Testing Stored Emergency Numbers

If you store an emergency service's number (police department, fire department, ambulance) and you want to test the stored number, make the test call during the late evening or early morning hours to avoid peak demand periods. Remain on the line to explain the reason for your call.

USING A HEADSET

You can make or answer calls with hands-free convenience using an optional headset with a $\frac{3}{32}$ -inch (2.5 mm) plug. Contact your local RadioShack store for a suitable headset.

To connect the headset, insert the headset's plug into the  jack on the right side of the phone.

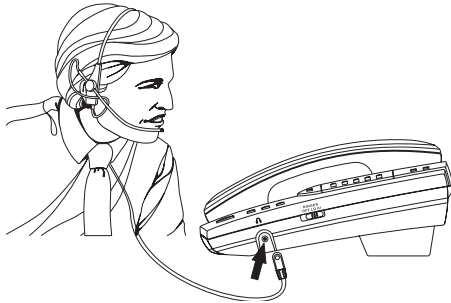

Note: Connecting a headset disconnects the handset's earpiece and microphone.

With a headset connected, press **HEADSET** instead of lifting the handset to make or answer calls. To end a call, press **HEADSET** again.

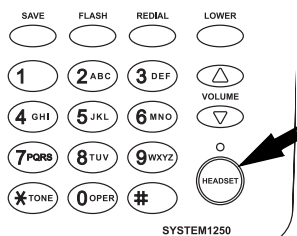



CALLER ID OPERATION

If you subscribe to Caller ID service from your phone company, the phone company sends information about the call, as well as the time and date, between the first and second rings of every call you receive. The System 1250 displays this information and updates the phone's built-in clock. (You cannot manually set the date and time.)

The System 1250 can also show other information about the call. See "Caller ID Messages" on Page 18.

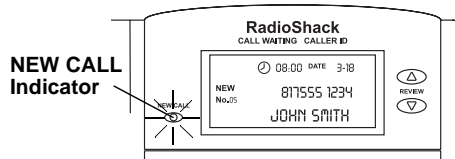
The **NEW CALL** indicator flashes during an incoming call, and **NEW** appears on the display. The Caller ID record appears for about 15 seconds, then the Caller ID and new Caller ID record totals appear.



If you subscribe to your phone company's message waiting service, the System 1250's display briefly shows **MESSAGE WAITING** when you receive a message, then  remains on the display until you retrieve the message.

Note: The message waiting feature only works with phone systems that use FSK (frequency-shift keying) services.

If you receive more than one call from the same phone number, **REP** and the number of calls flash alternately on the display. The number appearing by **REP** is the number of additional calls from that phone number.

If you subscribe to Call Waiting and a call comes in while you are on the phone, the incoming call symbol flashes.

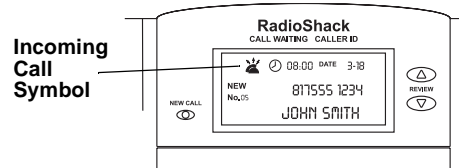

If you subscribe to Call Waiting with Caller ID, the System 1250 also displays the Caller ID information for the incoming call.

To answer the incoming call, press **FLASH**. To resume the previous phone conversation, press **FLASH** again.

CALLER ID MESSAGES

English Display — French Spanish	Description
TOTAL XX NEW XX APP XX NOU XX TOTAL XX NUEV XX	Indicates the total numbers of all calls and new calls. XX is the number of calls.
PRIVATE CONFIDENTIEL PRIVADO	The caller has blocked the Caller ID information from being sent.
UNAVAILABLE INCONNU NO DISPONIBLE	The caller is not within a Caller ID service area. No caller information appears.
MESSAGE WAITING MESSAGE EN ATT MENSAJE ESPERA	Appears when a message is waiting (if you subscribe to your phone company's message waiting service).
ERROR ERROR ERROR	Appears if there was an error during the transmission of Caller ID information.
END OF LIST FIN DE LISTE FIN DE LA LISTA	Appears after the first or last Caller ID record when you scroll through the list.
NO CALLS AUCUN MESSAGE NO HAY LLAMADAS	Tells you there are no Caller ID records stored.

REVIEWING CALLER ID RECORDS

Each time you receive a call, your system stores a Caller ID record that you can review later, even during a call. A Caller ID record includes:

- call number
- time and date of the call (a • next to the time indicates a PM hour)
- caller's telephone number (if available)
- caller's name (if available)

Repeatedly press **REVIEW** t or s to see Caller ID records. **END OF LIST** appears after the first or last record as you scroll through the list.

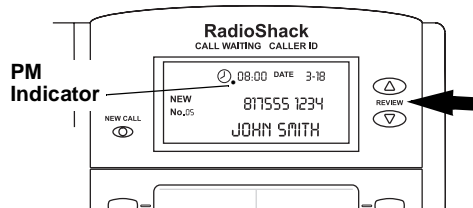

Notes:

- The display shows up to 12 digits of a phone number. If an incoming phone number is longer, the display shows only the last 12 digits.
- The System 1250 returns to the time/date display after 15 seconds if you do not press a key.

USING CALLBACK

You must store your home area code for Callback to work correctly (see “Setting the Area Codes” on Page 11). If the call came from your home area code, the display shows only the seven-digit number (without an area code). When you press **CALLBACK**, the phone dials the seven displayed digits.

However, you can also store up to two other local area codes. These are area codes that do not require you to dial a “1” first. If the call came from one of these stored area codes, the display shows the ten-digit number (three digits of area code plus seven digits of phone number). When you press **CALLBACK**, the phone dials the ten displayed digits, without inserting a “1” before the area code.

If you receive a call from an area code not stored in the phone, the display shows eleven digits (“1” plus the area code plus the phone number). When you press **CALLBACK**, the phone dials the eleven displayed digits.

Follow these steps to call back any number stored in a Caller ID record.

1. Lift the handset (or press **HEADSET** if you are using a headset).
2. Repeatedly press **REVIEW** s or t to select the Caller ID record that contains the number you want to call.

3. Press **CALLBACK**. The system dials the phone number.

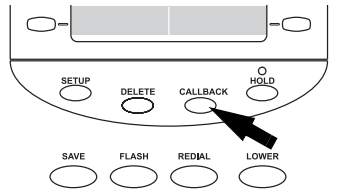

When you review the caller list after using **CALLBACK**,  appears. This indicates the phone number has been called back from that record.

STORING CALLER ID NUMBERS IN MEMORY

Follow these steps to store a number from a Caller ID record into a memory location.

1. Select the number you want to store.
2. Press **SAVE**.
3. Choose a memory location and store the number there.
 - To store to an upper memory number, simply press a memory location button.
 - To store to a lower memory number, press **LOWER** (**LO** appears), then press a memory location button.

DELETING CALLER ID RECORDS

The System 1250 lets you delete individual Caller ID records or all reviewed Caller ID records at once. It will not delete Caller ID records that have not been reviewed.

Note: You cannot delete Caller ID records during a call.

To delete a single Caller ID Record, repeatedly press **REVIEW** s or t to select a record, then press **DELETE**. The next Caller ID Record appears. If there are no other records, **NO CALLS** appears.

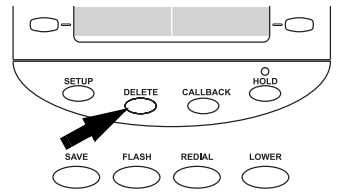

Follow these steps to delete all Caller ID records.

1. Repeatedly press **REVIEW** s or t until **END OF LIST** appears, or wait until the system returns to the date and time display.
2. Press **DELETE**. **REMOVE ALL?** appears.

If you decide not to delete the records, press **REVIEW** s or t or wait 15 seconds until the system returns to the date and time display.

3. Press **DELETE** again. **NO CALLS** appears.

TROUBLESHOOTING

We do not expect you to have any problems with your telephone, but if you do, the following suggestions might help.

Problem	Suggestion
No dial tone.	Check that the phone line and handset cords are securely connected.
Display is blank.	Batteries are weak or not installed and AC adapter is not connected.
☒ appears.	AC power is interrupted. Be sure AC adapter is correctly and securely connected.
Volume drops or you hear unusual sounds.	Someone has picked up another phone on the same line. Hang up the other phone.
Call is noisy.	Check that the phone line and handset cords are securely connected.
	Hang up and redial the number.
Phone dials 1+area code+number when dialing a local number from a Caller ID record.	Store the local area code (see "Setting the Area Codes" on Page 11).
Can receive calls, but cannot make calls.	Set T/P correctly for the type of service you have (see "Setting the Dialing Mode" on Page 10).

If you still have problems, disconnect the phone. If other phones on the same line work properly, the fault is in this phone or its installation. If you cannot find the problem, take your System 1250 to your local RadioShack store for assistance.

CARE AND MAINTENANCE

Your RadioShack System 1250 Caller ID Telephone is an example of superior design and craftsmanship. The following suggestions will help you care for your System 1250 so you can enjoy it for years.



Keep the System 1250 dry. If it gets wet, wipe it dry immediately. Liquids might contain minerals that can corrode the electronic circuits.



Use and store the System 1250 only in normal temperature environments. Temperature extremes can shorten the life of electronic devices, damage batteries, and distort or melt plastic parts.



Keep the System 1250 away from dust and dirt, which can cause premature wear of parts.



Handle the System 1250 gently and carefully. Dropping it can damage circuit boards and cases and can cause the System 1250 to work improperly.



Use only fresh batteries of the required size and type. Batteries can leak chemicals that damage your System 1250's electronic parts.



Wipe the System 1250 with a damp cloth occasionally to keep it looking new. Do not use harsh chemicals, cleaning solvents, or strong detergents to clean the System 1250.

Modifying or tampering with the System 1250's internal components can cause a malfunction and might invalidate your System 1250's warranty and void your FCC authorization to operate it. If your System 1250 is not performing as it should, take it to your local RadioShack store for assistance. If the trouble is affecting the telephone lines, the phone company can ask you to disconnect your System 1250 until you have resolved the problem.



THE FCC WANTS YOU TO KNOW

In the unlikely event that your telephone causes problems on the telephone line, the telephone company can disconnect your service. The telephone company normally attempts to notify you in advance. If advance notice is not practical, the telephone company notifies you as soon as possible and advises you of your right to file a complaint with the FCC.

Also, the telephone company can make changes to its lines, equipment, operations, or procedures that could affect the operation of this telephone. The telephone company notifies you of these changes in advance so you can take the necessary steps to prevent interruption of your telephone service.

LIGHTNING

Your telephone has built-in protection circuits to reduce the risk of damage from surges in telephone line current. These protection circuits meet or exceed the FCC requirements. However, lightning striking the telephone lines can damage your telephone.

Lightning damage is not common. Nevertheless, if you live in an area that has severe electrical storms, we suggest that you unplug your telephone during storms to reduce the possibility of damage.



Limited One-Year Warranty

This product is warranted by RadioShack against manufacturing defects in material and workmanship under normal use for one (1) year from the date of purchase from RadioShack company-owned stores and authorized RadioShack franchisees and dealers. EXCEPT AS PROVIDED HEREIN, RadioShack MAKES NO EXPRESS WARRANTIES AND ANY IMPLIED WARRANTIES, INCLUDING THOSE OF MERCHANTABILITY AND FITNESS FOR A PARTICULAR PURPOSE, ARE LIMITED IN DURATION TO THE DURATION OF THE WRITTEN LIMITED WARRANTIES CONTAINED HEREIN. EXCEPT AS PROVIDED HEREIN, RadioShack SHALL HAVE NO LIABILITY OR RESPONSIBILITY TO CUSTOMER OR ANY OTHER PERSON OR ENTITY WITH RESPECT TO ANY LIABILITY, LOSS OR DAMAGE CAUSED DIRECTLY OR INDIRECTLY BY USE OR PERFORMANCE OF THE PRODUCT OR ARISING OUT OF ANY BREACH OF THIS WARRANTY, INCLUDING, BUT NOT LIMITED TO, ANY DAMAGES RESULTING FROM INCONVENIENCE, LOSS OF TIME, DATA, PROPERTY, REVENUE, OR PROFIT OR ANY INDIRECT, SPECIAL, INCIDENTAL, OR CONSEQUENTIAL DAMAGES, EVEN IF RadioShack HAS BEEN ADVISED OF THE POSSIBILITY OF SUCH DAMAGES.

Some states do not allow the limitations on how long an implied warranty lasts or the exclusion of incidental or consequential damages, so the above limitations or exclusions may not apply to you.

In the event of a product defect during the warranty period, take the product and the RadioShack sales receipt as proof of purchase date to any RadioShack store. RadioShack will, at its option, unless otherwise provided by law: (a) correct the defect by product repair without charge for parts and labor; (b) replace the product with one of the same or similar design; or (c) refund the purchase price. All replaced parts and products, and products on which a refund is made, become the property of RadioShack. New or reconditioned parts and products may be used in the performance of warranty service. Repaired or replaced parts and products are warranted for the remainder of the original warranty period. You will be charged for repair or replacement of the product made after the expiration of the warranty period.

This warranty does not cover: (a) damage or failure caused by or attributable to acts of God, abuse, accident, misuse, improper or abnormal usage, failure to follow instructions, improper installation or maintenance, alteration, lightning or other incidence of excess voltage or current; (b) any repairs other than those provided by a RadioShack Authorized Service Facility; (c) consumables such as fuses or batteries; (d) cosmetic damage; (e) transportation, shipping or insurance costs; or (f) costs of product removal, installation, set-up service adjustment or reinstallation.

This warranty gives you specific legal rights, and you may also have other rights which vary from state to state.

RadioShack Customer Relations, Dept. W, 100 Throckmorton St., Suite 600, Fort Worth, TX 76102

We Service What We Sell

3/97

RadioShack
A Division of Tandy Corporation
Fort Worth, Texas 76102

7A8

Printed in China

Free Manuals Download Website

<http://myh66.com>

<http://usermanuals.us>

<http://www.somanuals.com>

<http://www.4manuals.cc>

<http://www.manual-lib.com>

<http://www.404manual.com>

<http://www.luxmanual.com>

<http://aubethermostatmanual.com>

Golf course search by state

<http://golfingnear.com>

Email search by domain

<http://emailbydomain.com>

Auto manuals search

<http://auto.somanuals.com>

TV manuals search

<http://tv.somanuals.com>