



Cat. No. 43-860

OWNER'S MANUAL

Please read before using this equipment.

COUNTRY LIFE PHONE



Radio Shack

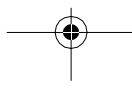



FEATURES

Your Radio Shack Country Life Phone combines nostalgic styling with convenient, modern features. The phone's authentic, country-style wooden case, decorative brass bells, and old-fashioned handset make it a conversation piece as well as a beautiful addition to your home's decor.

It also includes these features:

Pulse/Tone Option — lets you use your phone with pulse or tone service and lets you easily switch from pulse to tone dialing for long-distance, bank-by-phone, or other special services.

Last Number Redial — at the press of a button, lets you redial the last number dialed.

Simulated Rotary Dial — gives you the look of an old-fashioned, rotary dial but has the modern convenience of touch-tone dialing.

Wooden Writing Board and Storage Compartment — provides you with a convenient space for writing phone messages and storing small items, such as an address book.

Built-In Wall-Mounts — let you easily mount the phone on almost any wall, even directly over a telephone wall-plate.

Hearing-Aid Compatibility — lets you use your phone with hearing aids that have a T (telephone) switch.

Your telephone has been tested and found to comply with all applicable UL and FCC standards.

For your records, we recommend you record the phone's serial number in the space below. The number is located on the back of the phone.

Serial Number: _____

© 1995 Tandy Corporation.

All Rights Reserved.

Radio Shack is a registered trademark used by Tandy Corporation.

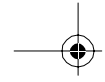

READ THIS BEFORE INSTALLATION



We have designed your telephone to conform to federal regulations and you can connect it to most telephone lines. However, each phone that you connect to the telephone line draws power from the line. We refer to the power draw as the phone's ringer equivalence number (REN). The REN is shown on the back of your phone.

If you are using more than one phone or other device on the line, add up all the RENs. If the total is more than five, your phones might not ring. In rural areas, a total REN of three might impair ringer operation. If ringer operation is impaired, remove a device from the line.

This telephone also complies with the limits for a Class B device as specified in Part 15 of *FCC* Rules. These limits provide reasonable protection against radio and TV interference in a residential area. However, your telephone might cause TV or radio interference even when it is operating properly. To determine whether your telephone is causing the interference, turn off your telephone. To eliminate interference, you can try one or more of the following corrective measures.

- Reorient or relocate the radio or TV's receiving antenna.
- Increase the distance between the telephone and the radio or TV.

Consult your local Radio Shack store if the problem still exists.

FCC STATEMENT

This telephone complies with Part 68 of *FCC* Rules. You must, upon request, provide the phone's FCC registration number and the REN to your telephone company. These numbers are located on the back of your phone.

Note: You must not connect your phone to:

- Coin-operated systems
- Party-line systems
- Most electronic key telephone systems

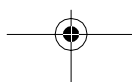
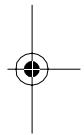
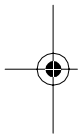

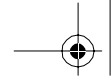

CONTENTS



Installation	5
Mounting the Phone	5
Preparation	5
Mounting on Dry Wall/Sheet Rock	6
Mounting on Plaster/Lathe or Solid Wood	8
Connecting the Phone	8
Operation	10
Setting the Dialing Mode	10
Turning the Ringer Off/On	10
Redial	11
Using Tone Services on a Pulse Line	11
Care and Maintenance	12
If You Have Problems	13
The FCC Wants You to Know	13
Lightning	13

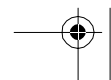
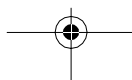
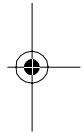
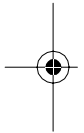

INSTALLATION

Your telephone connects directly to a modular telephone line jack. Choose a mounting location for the phone that is near a modular phone jack and away from normal activities.

If your telephone wiring does not have a modular jack, you can update the wiring yourself. Radio Shack stores sell the necessary wall jacks and adapters to convert older wiring methods to modular wiring. Or, you can have the telephone company update your telephone wiring for you.

Notes:

- The telephone company charges to install the necessary jacks.
- The USOC number of the jack to be installed is RJ11C for a base-board jack, or RJ11W for a wall jack.

MOUNTING THE PHONE

In addition to the supplied mounting hardware (anchors, plugs, screws, and rubber spacers), you need the following tools/supplies to mount your phone:

- A large piece of paper (at least 8 × 18 in.)
- Phillips screwdriver
- Hammer
- Electric drill with a $\frac{3}{16}$ -inch drill bit

Preparation

Follow these steps to prepare an easy-to-use template for marking the wall at the desired mounting location.

1. Lay the phone flat on a large piece of paper. Then, without moving the phone, trace the location of each of the four mounting holes onto the paper.

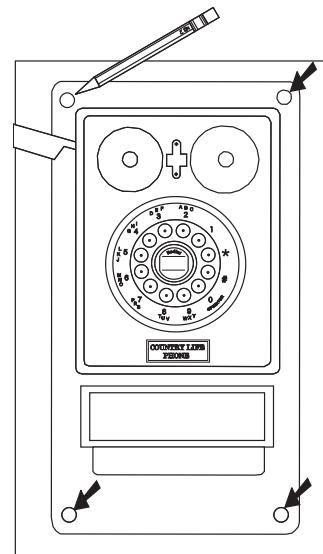

2. Tape the paper "template" on the wall at the desired mounting location.

- Depending on the distance between the modular phone jack and the desired mounting location, plug either the supplied 7-foot or 10-inch silver phone line cord into the jack on the back of the phone, then set the phone aside.

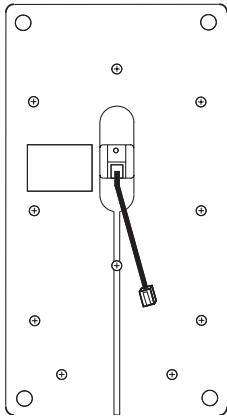

Note: If you are not mounting the phone directly over the modular phone jack, press the phone cord into the groove on the back of the phone so the cord is flush with the back.

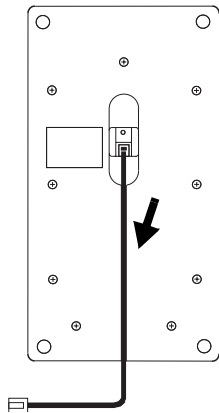

Mounting on Dry Wall/ Sheet Rock

- Screw a metal anchor into the wall with a Phillips screwdriver at each top mark on the template.

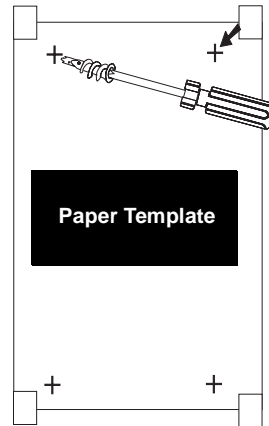

- Using an electric drill, drill a $\frac{3}{16}$ -inch hole at each of the bottom marks.

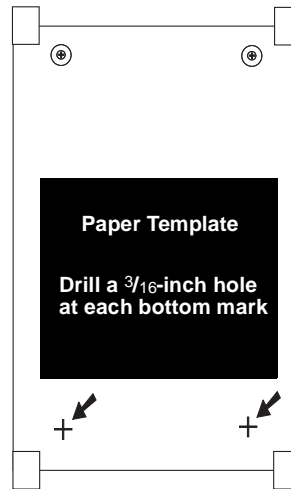

3. Press a plastic anchor into the hole at each bottom mark and tap the anchor into the wall with a hammer until the anchor is seated.

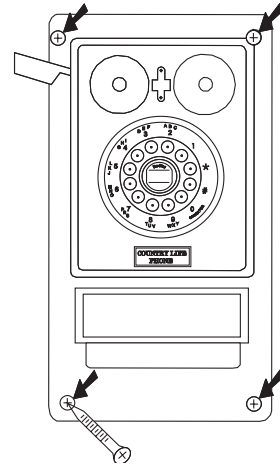
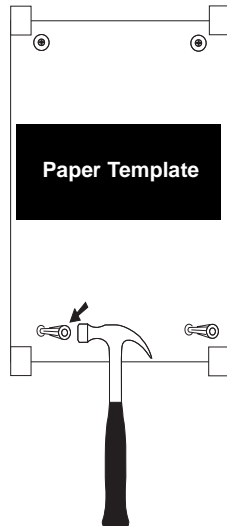

For additional stability, you can also use the supplied rubber spacers in addition to the screws. After you insert the screws through the phone's mounting holes, place a rubber spacer over each screw, so the spacer is between the back of the phone and the wall, then place the phone against the wall

4. Carefully pull the paper template away from the wall to remove it.

Note: If you are mounting the phone directly over the modular phone jack, plug the phone cord plug into the jack now (see "Connecting the Phone").

5. Place the phone against the wall so the phone's mounting holes align with the mounting locations in the wall, then insert a self-tapping screw into each mounting hole and tighten the screw with a screwdriver.

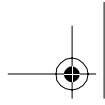

and tighten the screws with a screwdriver.

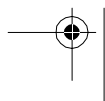
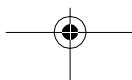
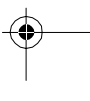
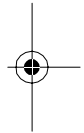
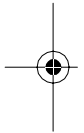
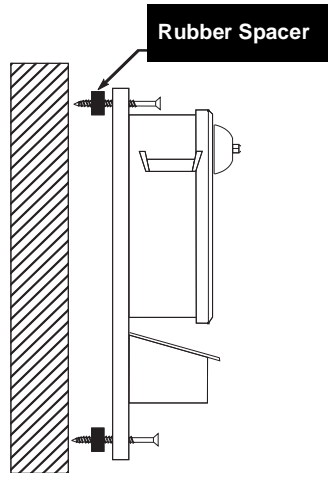

Mounting on Plaster/Lathe or Solid Wood

1. At each mounting mark on the template, turn a self-tapping screw clockwise a few rotations with a screwdriver to start it, then turn the screw counterclockwise to remove it.

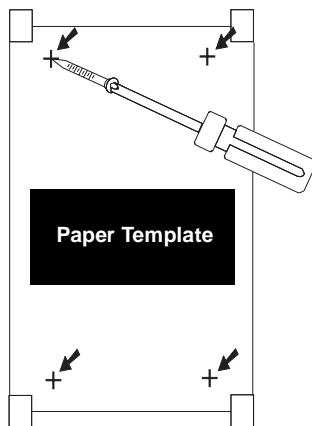

2. Carefully pull the paper template away from the wall to remove it.

Note: If you are mounting the phone directly over the modular phone jack, plug the phone cord plug into the jack now (see "Connecting the Phone").

3. Place the phone against the wall so the phone's mounting holes align with the mounting locations in the wall, then insert a screw into each mounting hole and tighten the screw with a screwdriver.

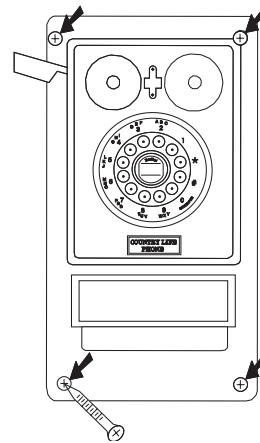

CONNECTING THE PHONE

1. To connect the handset to the phone, plug one end of the brown, fabric-covered cord into the handset jack, then plug the other end into the modular jack beneath the phone (above the writing/storage box).

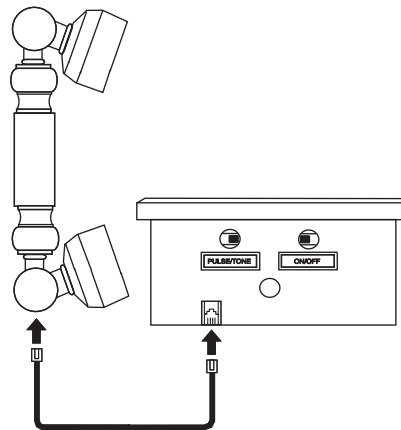



2. Place the handset on the cradle.

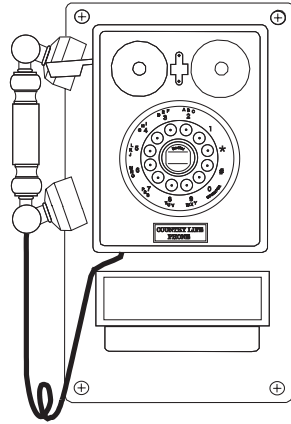

3. To connect your phone to the telephone line, plug the other end of the phone cord into the modular phone jack.

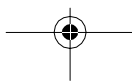
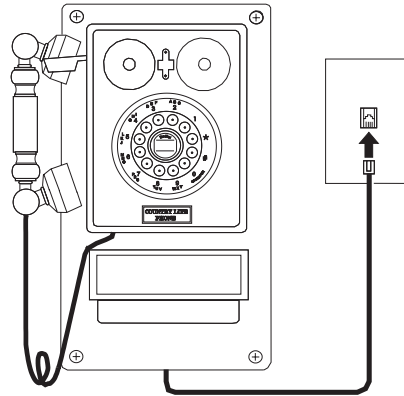

OPERATION

SETTING THE DIALING MODE

Set **PULSE/TONE** for the type of phone service you have, either tone or pulse (rotary). If you are not sure which type you have, do this simple test.

1. Set **PULSE/TONE** beneath the phone to **TONE**.

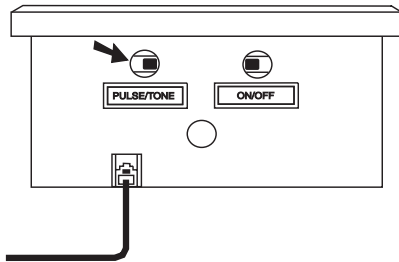

2. Lift the handset and listen for a dial tone.
3. Press any number except **0**.

If the dial tone stops, you have touch-tone service. Leave **PULSE/TONE** set to **TONE**.

If the dial tone continues, you have pulse service. Set **PULSE/TONE** to **PULSE**.

Notes:

- If you have pulse service and want to use a special service requiring tone signals (such as bank-by-phone), see "Using Tone Services on a Pulse Line."
- The * and # buttons have no effect when **PULSE/TONE** is set to **PULSE**.

TURNING THE RINGER OFF/ON

To turn off the ringer on the phone, set (ringer) **ON/OFF** on the bottom of the phone to **OFF**. You can still make calls, and you can answer calls if you hear another phone on the same phone line ring.

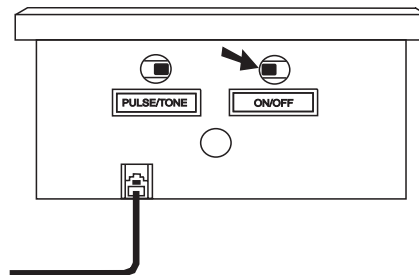

To turn the ringer back on, set (ringer) **ON/OFF** to **ON**.

REDIAL

Each time you dial a telephone number, the phone stores it in a redial memory. The redial memory holds up to 32 digits in either pulse or tone mode.

To quickly redial the last number dialed, lift the handset and press **REDIAL** (the large button in the center of the dial pad). The phone automatically redials the last phone number entered.

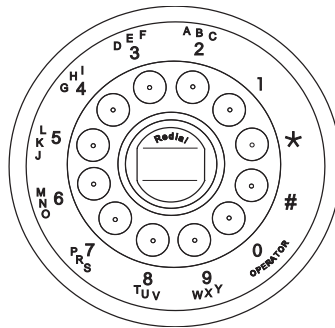

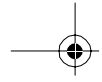

USING TONE SERVICES ON A PULSE LINE



Some special services, such as bank by phone, require tone signals. If you have pulse service, you can still use these special tone services by following these steps.

1. Call the special service using pulse dialing.
2. When the service answers, set **PULSE/TONE** to **TONE**, then press the keys as you normally would while using the special service. Your phone sends a tone signal for each key you press.
3. When you complete the call, hang up the phone, then set **PULSE/TONE** back to **PULSE**.

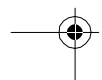
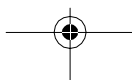
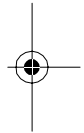
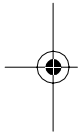

CARE AND MAINTENANCE

Your Radio Shack Country Life Phone is an example of superior design and craftsmanship. The following suggestions will help you care for your phone so you can enjoy it for years.



Keep the phone dry. If it gets wet, wipe it dry immediately. Liquids might contain minerals that can corrode the electronic circuits.



Handle the phone gently and carefully. Dropping it can damage circuit boards and cases and can cause the phone to work improperly.



Use and store the phone only in normal temperature environments. Temperature extremes can shorten the life of electronic devices and distort or melt plastic parts.



Keep the phone away from dust and dirt, which can cause premature wear of parts.



Wipe the phone with a damp cloth occasional-

ly to keep it looking new. Do not use harsh chemicals, cleaning solvents, or strong detergents to clean the phone.

Modifying or tampering with the phone's internal components can cause a malfunction and might invalidate its warranty and void your FCC authorization to operate it. If your phone is not performing as it should, take it to your local Radio Shack store for assistance.

IF YOU HAVE PROBLEMS

If your telephone is not performing as it should, check the connection to the telephone line. Calls are automatically switched and routed through complex equipment, so you might occasionally hear noise on the line. When a call is too noisy, hang up and redial the number.

If you still have problems, immediately disconnect the telephone. If another telephone on the same line works properly, the fault is in this telephone or its installation. If the trouble is harming the telephone lines, the telephone company might ask you to disconnect your telephone until you resolve the problem.

THE FCC WANTS YOU TO KNOW

In the unlikely event that your phone causes problems on the phone line, the phone company can temporarily discontinue your service. If this happens, the phone company attempts to notify you in advance. If advance notice is not practical, the phone company notifies you as soon as possible and advises you of your right to file a complaint with the FCC.

Also, the phone company can make changes to its lines, equipment, operations, or procedures that could affect the operation of this telephone. The telephone company notifies you of these changes in advance, so you can take the necessary steps to prevent interruption of your telephone service.

LIGHTNING

Your telephone has built-in protection circuits to reduce the risk of damage from surges in telephone line and power line current. These protection circuits meet or exceed the FCC requirements. However, lightning striking the telephone or power lines can damage your telephone.

Lightning damage is not common. Nevertheless, if you live in an area that has severe electrical storms, we suggest that you unplug your phone during storms to reduce the possibility of damage.



RADIO SHACK LIMITED WARRANTY

This telephone product is warranted against manufacturing defects in material and workmanship for one (1) year from the date of purchase from Radio Shack company owned stores and authorized Radio Shack franchisees and dealers. Within this period **bring your Radio Shack sales slip** as proof-of-purchase date to any Radio Shack store.

This warranty does not cover damage or failure caused by or attributable to Acts of God, abuse, misuse, improper or abnormal usage, faulty installation, improper maintenance, lightning or other incidence of excess voltage, or any repairs other than those provided by a Radio Shack Authorized Service Facility, or transportation costs. **Radio Shack is not responsible or liable for indirect, special, or consequential damages arising out of or in connection with the use or performance of the product or other damages with respect to loss of property, loss of revenue or profit, or costs of removal, installation or reinstallation.**

EXCEPT AS PROVIDED HEREIN, RADIO SHACK MAKES NO EXPRESS WARRANTIES AND ANY IMPLIED WARRANTIES ARE LIMITED IN DURATION TO THE DURATION OF THE WRITTEN LIMITED WARRANTIES CONTAINED HEREIN. Some states do not allow the limitation or exclusion of incidental or consequential damages and some states do not allow limitation or exclusion of implied warranties; therefore, the aforesaid limitation(s) or exclusion(s) may not apply to the purchaser. There will be charges rendered for repairs to the product made after the expiration of the aforesaid one (1) year warranty period.

This warranty gives you specific legal rights and you may also have other rights which vary from state to state.

We Service What We Sell

9/94



RADIO SHACK
A Division of Tandy Corporation
Fort Worth, Texas 76102

9A5

Printed in Hong Kong

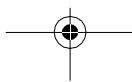

Free Manuals Download Website

<http://myh66.com>

<http://usermanuals.us>

<http://www.somanuals.com>

<http://www.4manuals.cc>

<http://www.manual-lib.com>

<http://www.404manual.com>

<http://www.luxmanual.com>

<http://aubethermostatmanual.com>

Golf course search by state

<http://golfingnear.com>

Email search by domain

<http://emailbydomain.com>

Auto manuals search

<http://auto.somanuals.com>

TV manuals search

<http://tv.somanuals.com>