

8-in-1 Universal Remote Control with Remote Finder

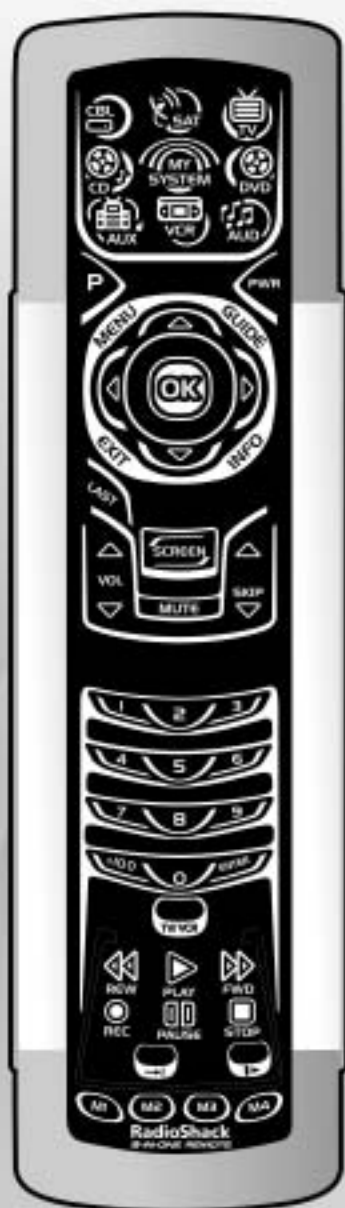

Owner's Manual
in English/Español



RadioShack.
www.RadioShack.com

15-2138

RadioShack 8-IN-ONE REMOTE POWERED BY KAMELEON

TABLE OF CONTENTS

Introduction	3
How Kameleon™ Works	3
Installing Batteries	4
Battery Use And Safety	4
About Battery Life	4
Installing Batteries In The Remote	4
About The Finder Transmitter	5
A Quick Look At The Controls	6
Key Functions	8
Device Table	12
Adjusting Brightness	13
Programming A Device	14
Programming A DVD Player/VCR Combo	16
Searching For Your Code	17
Checking The Codes	18
Using Learning	19
Learning Precautions	19
Programming A Learning Key	20
Deleting A Single Learned Key	21
Deleting All Learned Keys In A Specific Mode	22
Changing Volume Lock	22
Locking Volume Control To One Mode	23
Unlocking Volume Control For A Single Device	23
Unlocking All Volume Control	24
Using Macros	25
Programming A Favorite Channel Macro	25
Programming A Master Power Macro In My System Mode	26
Programming The COM MUTE Key	27
Clearing A Macro	28
Using Keymover	28
Programming Keymover	28
Restoring A Single Keymoved Key	29
Restoring All Keymoved Keys In A Single Mode	30
Programming Favorite Channel Scan	30
Using Channel Scan	32
Using My System Mode	32
Control Organization	32
Programming My System Mode	33
Reassigning Device Keys	35
Using Commercial Skip	36
Using The Default Settings	36
Programming Commercial Skip	36
Setting The Tilt Switch	38
Disabling The Tilt Switch	38
Enabling The Tilt Switch	38
Setting The Finder Receiver	39
Disabling The Finder Receiver	39
Enabling The Finder Receiver	39
Restoring Factory Default Settings	40
Clearing All Custom Programming	40
Specifications	41
About Upgrading	42
Upgrade Procedure	42
Upgrade Exclusions	42
Troubleshooting	43
Device Menu Screens	45
Care	57
Additional Information	57



Instruction To The User	58
Limited 90-Day Warranty	59
Manual De Deüño	60
Manufacturer's Codes	118
Setup Codes For Audio Amplifiers	118
Setup Codes For Audio Receivers	118
Setup Codes For Cable Boxes	119
Setup Codes For CD Players	120
Setup Codes For DVD Players	121
Setup Codes For DVD Players, PlayStation2 And Xbox Models	123
Setup Codes For DVD Player/VCR Combos	123
Setup Codes For Home-Theater-in-a-Box Devices	123
Setup Codes For PVRs	124
Setup Codes For Satellite Receivers	124
Setup Codes For TVs	125
Setup Codes For TV/DVD Player Combos	129
Setup Codes For TV/VCR Combos	129
Setup Codes For VCRs	130
Setup Codes For Video Accessories	132



INTRODUCTION

The RadioShack 8-in-One Remote powered by Kameleon™ is a revolutionary universal remote control that uses Universal Electronics' Kameleon Technology. It is designed to control up to eight home entertainment devices, including TV, video, and audio components.

After installing four (4) new AAA alkaline batteries, you can immediately use the remote to control an RCA TV, VCR, DVD Player, and Satellite Receiver, a Motorola Cable Box, a Tivo PVR (DVR), and a Pioneer CD Player and Audio Receiver. To control other brands, please perform the instructions in *Programming A Device* on page 14.



HOW KAMELEON™ WORKS

The RadioShack 8-in-One Remote Powered By Kameleon provides the versatility of an LCD remote control with the feel of a traditional push button unit. The result is a stunning, bright display with engaging animation and touch-sensitive graphics for the user.

The remote control includes convenient *Menu Driven* programming. The displays are divided into two types of interactive screens: *Device Menus* for normal remote control use, and *Programming Menus* for feature setup. Acting like its namesake, Kameleon changes the *Device Menu* for the device being selected. For example, selecting TV displays a main menu that contains channel selection, volume control, and a keypad. However, selecting a DVD player still displays a menu with those same keys as the TV, but now navigation keys and transport controls are added for the DVD device.

continued on next page...



RadioShack 8-IN-ONE REMOTE POWERED BY KAMELEON

HOW KAMELEON™ WORKS (Continued)

Several devices have a second menu that can be accessed using **SCREEN** (see *Device Menu Screens*, starting on page 45). For example, TV has two menus: a main menu with extra feature keys for **COM MUTE**, **+100**, **ENTER**, **SLEEP**, **TV/VCR**, and **PIP** functions, and a second menu screen that adds navigation keys but removes the extra feature keys. This way a user has the flexibility to use any menu screen that works best for the selected device.

*NOTE: Even though **SCREEN** is displayed in all modes, only **TV**, **CD**, and **AUD** modes have a second menu screen.*

Animated key graphics also provided enhanced operational feedback, so the user can easily see what mode is active and when the commands are communicating with a device. The end result of Kameleon technology is a simple, elegant, and intelligent way of organizing a large number of remote control keys for eight different devices.



INSTALLING BATTERIES

BATTERY USE AND SAFETY

- Use only fresh batteries of the required size and recommended type.
- Do not mix old and new batteries, different types of batteries (e.g., standard, alkaline, or rechargeable), or rechargeable batteries of different capacities.
- If you do not plan to use the remote for an extended period, remove the batteries. They can leak chemicals that can destroy electronic parts.

WARNING: Dispose of old batteries promptly and properly. Do not burn or bury them.

ABOUT BATTERY LIFE

As with all battery-operated devices, battery life will vary depending on use, including frequency and duration of key presses on the Kameleon screen. Battery life may be extended by:

- Reducing the brightness level of the display screen (see *Adjusting Brightness* on page 13).
- Disabling the Kameleon “tilt on” feature (see *Setting The Tilt Switch* on page 38).
- Disabling the Kameleon Finder feature (see *Setting The Finder Receiver* on page 39).

INSTALLING BATTERIES IN THE REMOTE

Your remote requires four AAA batteries (not supplied) for power.



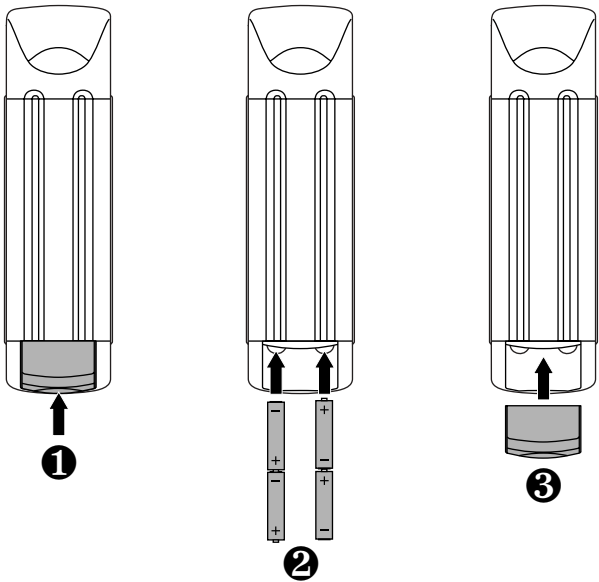

1. Push forward on the battery compartment cover (on the back of the remote) and lift it off.
2. Slide the AAA batteries into the compartment as indicated by the polarity symbols (+ and -) shown above.
3. Align the cover with the compartment opening and slide it back into place.
4. If batteries are inserted correctly, the display will turn on and show all keys. If a key is not pressed after 7 seconds, the display will turn off.

NOTE: The batteries will need replacement if one of the following conditions occurs:

1. The top IR segment flashes five times after pressing a key.
2. The Tilt Switch (if enabled, see page 38) no longer activates the remote and only pressing a key turns on the display.

ABOUT THE FINDER TRANSMITTER

NOTE: If you do not plan to use the Finder Transmitter, store it away for future use and skip this section.

Included in the package is a Finder Transmitter that you can use to audibly locate a lost or misplaced RadioShack 8-in-One Remote. The unit also comes with double-sided “hook and loop” tape for use in mounting it on a TV cabinet side or other surface.

The Finder Transmitter requires a 9-volt battery for power. For best performance and longest life, we recommend using a RadioShack alkaline battery.

continued on next page...



RadioShack 8-IN-ONE REMOTE POWERED BY KAMELEON

INSTALLING BATTERIES

ABOUT THE FINDER TRANSMITTER (CONTINUED)

INSTALLING A BATTERY IN THE FINDER TRANSMITTER

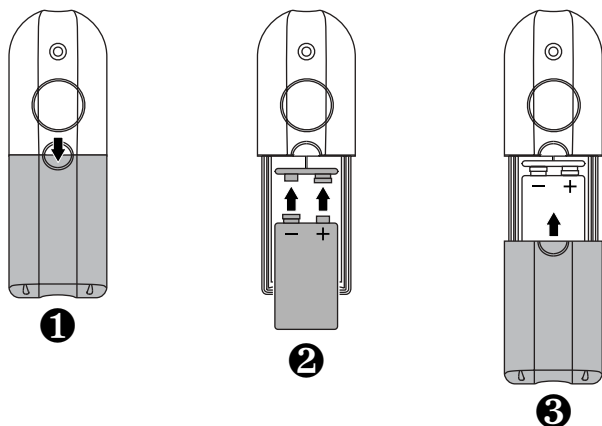

1. Press down on the battery compartment cover (on the front of the Finder Transmitter) and slide it off.
2. Locate the snap harness and connect the 9-volt battery to mating terminals. Then insert the battery and harness into the compartment.
3. Align the cover with the compartment opening and slide it back into place.

OPERATING THE FINDER TRANSMITTER

1. Point the Finder Transmitter in the general direction of the lost RadioShack 8-in-One Remote.
2. Press and hold the Finder Transmitter's button until the lost RadioShack 8-in-One Remote emits a chirping sound to help you find it.

NOTE: If the RadioShack 8-in-One Remote does not emit a chirping sound, verify the Finder Receiver is enabled (see page 39) and the battery is fresh.



A QUICK LOOK AT THE CONTROLS

Use the illustration on the next page to locate controls and then study the *Key Functions* to learn how they function.

NOTE: The illustration shows all remote control keys. In actual operation, only active keys used by the selected device are displayed and non-active keys are hidden. These controls work like the ones found on your original remote controls.

To find out what type of devices can be controlled by each device key after programming, see the *Device Table* on page 12.



To find out what keys appear when the program mode is activated or when a device is selected, see the *Device Menu Screens* section starting on page 45. Included are brief descriptions of how the keys work for each displayed screen.

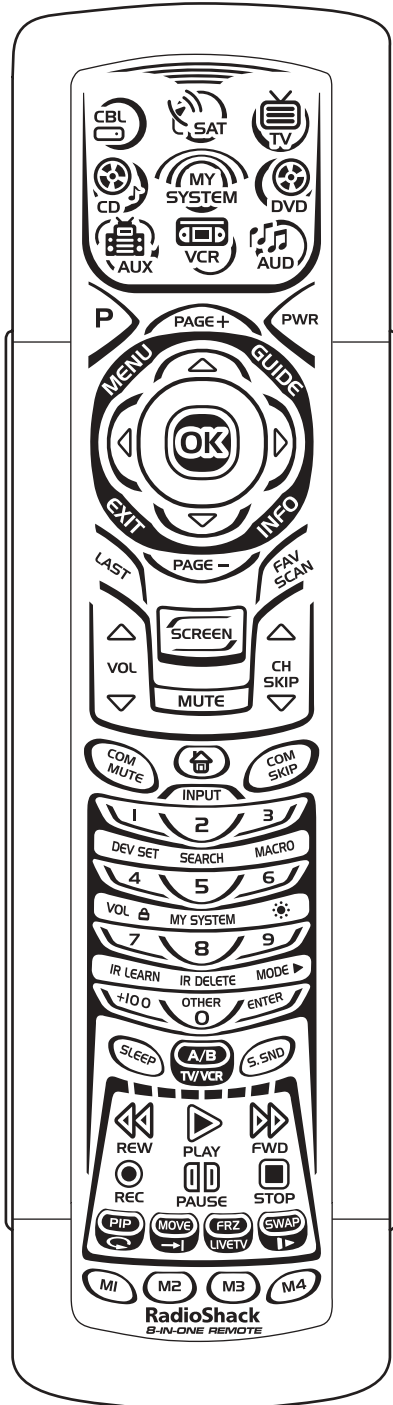

continued on next page...



RadioShack 8-IN-ONE REMOTE POWERED BY KAMELEON

A QUICK LOOK AT THE CONTROLS (Continued)

KEY FUNCTIONS



When a key is pressed, the IR segments will animate. Outgoing animation (see arrow) indicates the remote is sending IR signals to a selected device.



Incoming animation indicates the remote is receiving IR signals from a device being learned (see *Using Learning* on page 19).



During programming, the bottom IR segment flashes to confirm setup actions.



Press **CBL**, **SAT**, **TV**, **DVD**, **AUD**, **VCR**, **AUX**, or **CD** once to select a device to control. The selected device key will animate to indicate it is currently active. Also see the *Device Table* on page 12.

After programming, press **MY SYSTEM** once to select your custom system controls. See *Using My System Mode* on page 32.



Use **P** to enable the programming screen.



In the **CBL** or **SAT** mode, use **PAGE+** or **PAGE-** to page up or page down through channels in the program guide.



Press **PWR** once to turn on or off a selected device.



Use the navigation keys as follows:

Use **MENU** to display the your device's main menu. In the **TV**, **CD**, or **AUD** mode, the selected device's main menu screen will appear.

Use **GUIDE** to display your device's program guide, or setup or program menu.

In the **TV**, **CD**, or **AUD** mode, the selected device's main menu screen will appear.

Use **INFO** to display the current channel and program information.

Use **EXIT** to exit from your device's guide or menu.

Use the cursor keys (**▲**, **▼**, **◀**, or **▶**) to navigate through the program guide and menu screens.





In the **CD** mode, use ▲ (or ▼) to select the next (or previous) disc.

In the **AUD** mode, use ▲ (or ▼) to raise (or lower) rear channel volume and use ◀ (or ▶) to balance audio left (or right).

Use **OK** to choose options from your device's menu or guide.



Press **LAST** once to recall the last channel.

In the **CD** or **AUD** mode, use **LAST** to repeat the last track.



In the **TV**, **CD**, or **AUD** mode, use **SCREEN** to view additional key screens for the selected device.



In all modes except **CD**, **DVD**, and **AUD**, use **FAV SCAN** to scan through all channels, or after programming, to scan through 10 favorite channels.



Use **VOL ▲** (or **VOL ▼**) to raise (or lower) volume for the selected device (also see *Changing Volume Lock* on page 22).



Press **MUTE** once to turn the sound off or on.

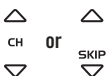

In all modes except **CD** and **DVD**, use **CH ▲** (or **CH ▼**) to select the next higher (or lower) channel.

In the **CD** or **DVD** mode, use **SKIP ▲** (or **SKIP ▼**) to select the next (or previous) track or chapter.



After programming, in the **CBL**, **SAT**, **TV**, **VCR**, or **AUX** mode use **COM MUTE** to drop the volume to preset level and raise it back to its original level. See *Using Macros* on page 25.



During programming, the home key will appear. Use it to exit the program screen or to return to the previous device key screen.



In the **CBL**, **SAT**, **VCR**, or **AUX** mode, use **COM SKIP** to skip commercials on devices with PVR capabilities (see *Using Commercial Skip* on page 36).

continued on next page...



RadioShack 8-IN-ONE REMOTE POWERED BY KAMELEON

A QUICK LOOK AT THE CONTROLS

KEY FUNCTIONS (CONTINUED)

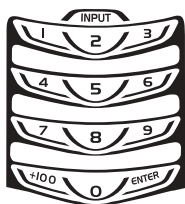

In all modes except **AUD**, use the number keys (1 ~ 9 and 0) to directly select channels (e.g., **009** or **031**) or enter numbers.

In the **AUD** mode, **INPUT** will appear. Use the number keys to directly select inputs 1 ~ 9 and 10.

For certain brands in all modes except **CD**, press **ENTER** once after entering numbers (if required on original remote control).

In the **TV** mode, use **+100** to enter numbers above 100 (if required on original remote control). In the **CD** or **DVD** mode, use **+100** to access tracks above 10 (if required on original remote control). In the **AUD** mode, use **+100** to change the radio band.

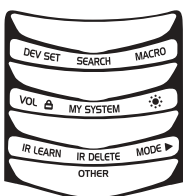

NOTE: Press above the title to activate a desired program. For **OTHER**, press below the title.

In the program mode, use the program keys to personalize the remote control as follows:

Use **DEV SET** to program your device codes. See *Programming A Device* on page 14.

Use **SEARCH** as an alternate way to set up a device by searching available codes. See *Searching For Your Code* on page 17.

Use **MACRO** to program a series of commands on five available macro keys. See *Using Macros* on page 25.

Use **VOL** with the lock icon to set volume controls for individual or global device use. See *Changing Volume Lock* on page 22.

Use **MY SYSTEM** to create a custom mode with favorite remote control keys from different devices in your home theater system. See *Using My System Mode* on page 32.

Use the sun icon to adjust the brightness level of the EL display. See *Adjusting Brightness* on page 13.

Use **IR LEARN** and **IR DELETE** to add and delete key functions learned from your original device remote controls. See *Using Learning* on page 19.



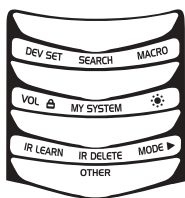

NOTE: Press above the title to activate a desired program. For **OTHER**, press below the title.

Use **MODE** ► to reassign an unused device key to control a second device. See *Reassigning Device Keys* on page 35.

Use **OTHER** to program other functions. See *Table of Contents* on page 2 for sections on *Checking The Codes*, *Programming Favorite Channel Scan*, *Using Keymover*, *Programming Commercial Skip*, *Upgrading*, *Restoring Default Settings*, or *Clearing Programming*.



In the **CBL**, **SAT**, **VCR**, or **AUX** mode, use **SLEEP** to activate your device's sleep timer (if one is available for the device).



In the **CBL** or **SAT** mode, use **A/B** to act as your cable box's or satellite receiver's A/B switch.



In the **TV**, **VCR**, or **DVD** mode, use **TV/VCR** to switch the TV's input to view TV or video programs.

In the **AUD** mode, use **TV/VCR** to switch between program and input.



In the **AUD** mode, use **S.SND** to turn surround sound on or off. Also see cursor keys on page 8.



In the **CD**, **DVD**, **AUD**, **VCR**, or **AUX** mode, use the transport keys (i.e., **REW**, **PLAY**, **FWD**, **PAUSE**, and **STOP**) to control the device's transport. Press **REC** twice to record a program on your device (if the function is available).

In the **CBL** or **SAT** mode, use the transport keys to control VOD (Video On Demand) or PVR, if available on your cable/satellite service.



In the **CBL**, **SAT**, **VCR**, or **AUX** mode, use the replay key to instantly replay the last 7 seconds of a program you are watching (if the feature is available).



In the **CBL**, **SAT**, or **AUX** mode, use the advance key to skip past commercials or other uninteresting scenes (if the feature is available).

In the **DVD** or **CD** mode, use the advance key to change discs.



In the **CBL**, **SAT**, **VCR**, or **AUX** mode, use **LIVE TV** to switch between live TV and video programming (if the feature is available).







continued on next page...



RadioShack 8-IN-ONE REMOTE POWERED BY KAMELEON

A QUICK LOOK AT THE CONTROLS









KEY FUNCTIONS (CONTINUED)

	In the CBL , SAT , VCR , DVD , or AUX mode, use the slow key to view slow motion video (if the feature is available).
	Use PIP to switch the Picture-In-Picture feature on or off.
	Use MOVE to move the window picture to different places in the main picture.
	Press FRZ once to capture a frame of video in the main picture. Press it again to resume normal viewing.
	Use SWAP to switch images and sound between the main and window pictures.
	After programming, press M1 ~ M4 once to run a macro (see <i>Using Macros</i> on page 25).

DEVICE TABLE

NOTE: Please refer to the table below when performing the instructions in "Programming A Device" on page 14.

After programming, the RadioShack 8-in-One Remote will be able to control the following types of devices:

DEVICE KEY	CONTROLS THESE DEVICES
	Cable Box (Converter) or Video Accessory
	Satellite Receiver or Satellite/PVR Combo
	Television
	DVD Player, TV/DVD Player Combo, or DVD/VCR Player Combo
	Audio Amplifier, Audio Receiver, or Home-Theater-in-a-Box (HTiB) Device
	VCR, TV/VCR Combo, or PVR (DVR)
	PVR (DVR), VCR, or TV/VCR Combo
	CD Player or CD Recorder



ADJUSTING BRIGHTNESS

The RadioShack 8-in-One Remote has five levels of brightness adjustment and is set to the fourth one at the factory. To increase or decrease the brightness, perform the following steps:

1. Press and hold **P** until the bottom IR segment flashes twice.

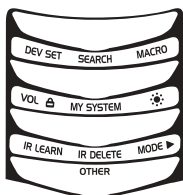

The program keys will appear:

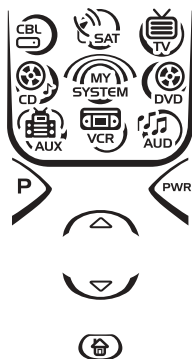

NOTE: If the display turns off because of inactivity, you will need to start the programming sequence again by repeating this step.

2. Press above  once. The *Brightness Programming* screen will appear:



- To increase brightness, press  one or more times.
 - To decrease brightness, press  one or more times.
3. When desired brightness is achieved, press  twice to exit programming and return to the last-selected device menu screen.

NOTE: The remote includes a tilt switch that turns on the display when the unit is moved. If desired, you can disable this feature. See “Setting The Tilt Switch” on page 38.



RadioShack 8-IN-ONE REMOTE POWERED BY KAMELEON

PROGRAMMING A DEVICE

The RadioShack 8-in-One Remote is preset at the factory to operate the following devices:

- Motorola Cable Box
- RCA TV, VCR, DVD Player, Satellite Receiver, CD Player, and Audio Receiver
- ReplayTV PVR (DVR) using the **AUX** key

To control devices other than the default brands, perform the following steps; otherwise skip this section:



NOTE: To control a DVD Player/VCR Combo, perform the instructions in “Programming A DVD Player/VCR Combo” on page 16.

1. Turn on a desired device (e.g., VCR or DVD player) and, if applicable, insert media (e.g., cassette or disc).

NOTE: Please read steps 2 through 9 completely before proceeding. Before starting step 2, review the “Manufacturer’s Codes” (starting on page 118). Brands are listed alphabetically in order of the most popular codes first. Highlight or write down the devices and the codes you wish to program.

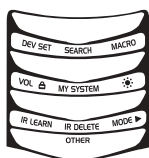
2. Press and hold **P** until the bottom IR segment flashes twice. The program keys will appear:



NOTE: If the display turns off due to inactivity, the remote will exit programming and return to the last-selected device menu screen. To start programming again, repeat this step. To stop programming at any time, press  once to return to the program keys screen. Press  once more to exit completely.

3. Press above **DEV SET** once. The *Device Setup* programming screen will appear:



- Press a device key once (i.e., **CBL, SAT, TV, DVD, AUD, VCR, AUX, or CD**). The selected device key will animate.

NOTE: Refer to the "Device Table" on page 12 when choosing a device key for programming.

- Use the *Manufacturer's Codes* (starting on page 118) to locate the type of device and brand name and then use the number keys to enter the first four-digit code for your device. If performed correctly, the bottom IR segment will flash twice.

NOTE: If the bottom IR segment displays one long flash instead, a mistake has occurred. Try entering the same code again.

- Aim the remote at the device and press **PWR** once. The device should turn off. If it does not, repeat steps 5 and 6, trying each code for your brand until you find one that works. If it still doesn't work, try *Searching For Your Code* on page 17.
- If the code works, press **OK** once. The bottom IR segment flashes twice.
- If desired, repeat steps 4 through 7 for each device you want to control. When finished, press  twice to exit programming and return to the last-selected device menu screen.

- For future reference, write down each working device code in the following boxes:

CBL Code:

Brand Name: _____

SAT Code:

Brand Name: _____

TV Code:

Brand Name: _____

DVD Code:

Brand Name: _____

AUD Code:

Brand Name: _____

VCR Code:

Brand Name: _____

AUX Code:

Brand Name: _____

CD Code:

Brand Name: _____



RadioShack 8-IN-ONE REMOTE POWERED BY KAMELEON

PROGRAMMING A DVD PLAYER/VCR COMBO

NOTE: If you own a Sylvania TV/DVD Player Combo with a separate TV code (see page 129), use the below steps to program it with these changes: in step 5 (on the next page), enter **0675** as the DVD code; in step 8a, substitute TV for VCR; and in step 8b enter **0171** as the TV code.

1. Turn on the DVD Player/VCR Combo and insert a DVD.

NOTE: Please read steps 2 to 8 completely before proceeding. Review the “Setup Codes For DVD Player/ VCR Combos” (on page 123). Highlight or write down the brand and the codes you wish to program.

2. Press and hold **P** until the bottom IR segment flashes twice.
The program keys will appear:



3. Press above **DEV SET** once. The *Device Setup* programming screen will appear:



4. Press **DVD** once. The key will animate.
5. Use the *Setup Codes For DVD Player/VCR Combos* (on page 123) to locate the brand name and use the number keys to enter the four-digit code for your device. If performed correctly, the bottom IR segment will flash twice.

NOTE: If the bottom IR segment displays one long flash instead, an error has occurred. Try entering the same code again.

6. Aim the remote at the device and press **PWR** once. The device should turn off. Press **OK** once to save the code. The bottom IR segment flashes twice.
7. (Optional) If you've located a setup code that works, but it also has a separate VCR code as listed on page 123, you'll need to program it into the remote to access VCR controls, as follows:



- a. Press **VCR** once.
- b. Using the number keys, enter the four-digit VCR code for your DVD Player/VCR Combo. If performed correctly, the bottom IR segment will flash twice.
- c. Press **OK** once. The bottom IR segment displays one long flash.

*NOTE: If a VCR setup code is not listed, you can use the **VCR** key to program a separate VCR or another device (see "Reassigning Device Keys" on page 35).*

8. To exit programming, press  twice. The display returns to the last-selected device menu screen. For future reference, write the working code in the below boxes:

DVD Player/VCR Code:

Brand Name: _____

VCR Code (if used):

Brand Name: _____



SEARCHING FOR YOUR CODE

If your device does not respond to the RadioShack 8-in-One Remote after trying all codes listed for your brand, or if your brand is not listed at all, try searching for your code.

NOTE: Before performing a code search for a CD or DVD player or a VCR, turn on the device and insert the required media.

For example, to search for a code for your TV:

1. Press and hold **P** until the bottom IR segment flashes twice. The program keys will appear:

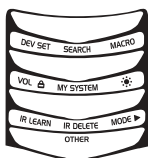

2. Press above **SEARCH** once. The *Search Codes* programming screen will appear:



continued on next page...



RadioShack 8-IN-ONE REMOTE POWERED BY KAMELEON

SEARCHING FOR YOUR CODE (Continued)

3. Press a device key once (e.g., **TV**). The selected device key will animate. The device's *Main Menu* screen will appear with  still displayed.
4. Press **PWR** once to select it as the search test function. The *Search Programming* screen will appear again.

*NOTE: With **PWR** as the search test function, a "Power On" IR command will be sent to the device each time a test code is sent. As a confirmation, the IR segments will display an outgoing animation.*

*NOTE: If your device or its original remote control does not have a Power key, select a different test function in this step (e.g., **CH+**, **VOL+**, **PLAY**, etc).*

5. Aim the remote at the device (e.g., **TV**) press **▲** one or more times and stop when a working code performs the test function selected in step 4. If desired, use **▼** to try a previous code.

NOTE: In the search mode, the remote control will send IR codes from its library to the selected device, starting with the most popular code first.

6. To lock in the code, press **OK** once. The bottom IR segment flashes twice.
7. To search for codes of your other devices, repeat steps 3 to 6, but use the appropriate device key and test function key for the device you are searching for.
8. To exit programming, press  twice. The display will return to the last-selected device menu screen.



CHECKING THE CODES

If you have set up the RadioShack 8-in-One Remote using the *Searching For Your Code* procedure (on the previous page), you may need to find out which four-digit code is operating your equipment. For example, to find out which code is operating your TV:

1. Press and hold **P** until the bottom IR segment flashes twice. The program keys will appear:

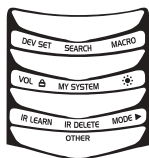

2. Press below **OTHER** once. The *Other* programming screen will appear:



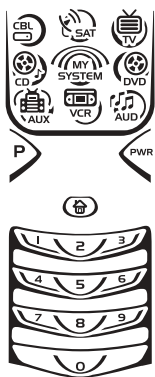

- Using the number keys, enter **9 9 0**. The bottom IR segment will flash twice and the *Code Verification* screen will appear.
- Press a desired device key once (i.e., **CBL, SAT, TV, DVD, AUD, VCR, AUX,** or **CD**). The selected device key will animate.
- To view the code for the first digit, press **1** once. Count the number of times the bottom IR segment flashes (e.g., three flashes = 3) and write down the number in leftmost box in the TV code boxes on page 15.

NOTE: If a code digit is "0", the bottom IR segment will not flash.

- Repeat step 5 three more times for remaining digits. Use **2** for the second digit, **3** for the third digit, and **4** for the fourth digit. Write down the code digits in the remaining TV code boxes on page 15.

*NOTE: If you enter an invalid number (e.g., **7**) or key (e.g., **PLAY**), the bottom IR segment will display one long flash and return to the "Other" programming screen. Start again with step 2 above.*

- To check for codes of other devices, repeat steps 4 to 6, but substitute the appropriate device key for each device you are checking. Write down the device's code digits in the appropriate code boxes on page 15.
- To exit programming, press  twice. The display will return to the last-selected device menu screen.



USING LEARNING

The RadioShack 8-in-One Remote includes a Learning feature so you can add functions that are unique to your home entertainment devices (e.g., VCR Tracking Up or Down). However, there are some considerations:

LEARNING PRECAUTIONS

- Your original remote controls must be in working order for learning to work properly.
- Learned keys are mode specific, so each one can store a unique function for each mode.

continued on next page...



RadioShack 8-IN-ONE REMOTE POWERED BY KAMELEON

USING LEARNING

LEARNING PRECAUTIONS (CONTINUED)

- Learned keys can be used in macros (see *Using Macros* on page 25).
- Do not use the following keys for learning: **P**, **SCREEN**, **M1~M4**, **FAV SCAN**, **COM SKIP**, **COM MUTE**, or any device key.
- Learning capacity is approximately 16 to 25 keys, depending on the code being learned.
- If both learned and keymoved functions are assigned to the same key, the last programmed function will be stored.
- A learned function cannot be used as a source for Keymover (see *Using Keymover* on page 28).
- Certain device codes are not learnable, including multi-frequency types, some high-frequency ones, and other unusual formats.
- For optimum learning, avoid high levels of ambient light such as natural sunlight or energy-efficient fluorescent lights.

NOTE: Please have your original remote controls handy before programming learning. Be sure to press each teaching key within 5 seconds of the previous entry. Otherwise, the RadioShack 8-in-One Remote will exit the programming mode.

PROGRAMMING A LEARNING KEY

1. Press and hold **P** until the bottom IR segment flashes twice.
The program keys will appear:



2. Press above **IR LEARN** once. The *IR Learn* programming screen will appear:

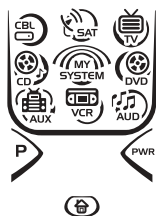

3. Press a device key once (i.e., **CBL**, **SAT**, **TV**, **DVD**, **AUD**, **VCR**, **AUX**, or **CD**) to assign a mode for learning. The selected device menu screen, including , will be displayed.
4. Place the RadioShack 8-in-One Remote head-to-head (about 2" apart, as shown on the next page) from your original remote control. Also locate the key (on your original remote control) that will serve as the teaching function.



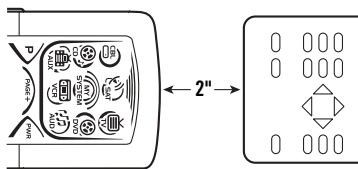



- On the RadioShack 8-in-One Remote, select and press a desired key where the learned function will be stored. The IR segments will display an incoming animation, continue for three revolutions, and then the entire display will turn off.

After the display is off, press and hold the teaching key (on your original remote control) until the display (on the RadioShack 8-in-One Remote) turns on again. The bottom IR segment will flash twice when the code is successfully captured.

NOTE: If the bottom IR segment displays one long flash, a learning error has occurred. Try repeating this step again until a successful capture occurs.

If the function is still not captured, press  twice to exit programming and review the "Learning Precautions" on page 19. If needed, also see "Troubleshooting" on page 43. After review, start programming again at step 1.

- To learn other functions, repeat steps 3 through 5 as desired.
- To exit programming, press  twice. The display will return to the last-selected device menu screen.

DELETING A SINGLE LEARNED KEY

- Press and hold **P** until the bottom IR segment flashes twice. The program keys will appear:

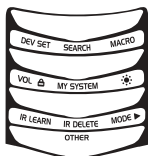

- Press above **IR DELETE** once. The *IR Delete* programming screen will appear:

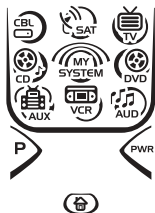

- Press a device key once (i.e., **CBL, SAT, TV, DVD, AUD, VCR, AUX,** or **CD**) for the mode where the learned key to be deleted resides. The selected device menu screen, including , will be displayed.
- Press the learned key to be deleted twice. Upon deletion, the bottom IR segment will flash twice as confirmation. The program keys will appear again.

continued on next page...



RadioShack 8-IN-ONE REMOTE POWERED BY KAMELEON

USING LEARNING

DELETING A SINGLE LEARNED KEY (CONTINUED)

5. If desired, repeat steps 2 through 4 to delete another learned key.
6. Exit programming by pressing  once. The display will return to the last-selected device menu screen.



DELETING ALL LEARNED KEYS IN A SPECIFIC MODE

1. Press and hold **P** until the bottom IR segment flashes twice. The program keys will appear:

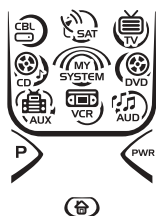

2. Press above **IR DELETE** once. The *IR Delete* programming screen will appear:



3. Press a device key once (i.e., **CBL, SAT, TV, DVD, AUD, VCR, AUX, or CD**) for the mode where the learned keys to be deleted reside. The selected device menu screen, including , will be displayed.
4. Press the same device key (as in step 3) once. Upon deletion, the bottom IR segment will flash twice as confirmation. The program keys will appear again.
5. If desired, repeat steps 2 through 4 to delete other learned keys from another mode.
6. Exit programming by pressing  once. The display will return to the last-selected device menu screen.



CHANGING VOLUME LOCK

The RadioShack 8-in-One Remote is set at the factory for independent volume control of each selected device.

However, you may change the Volume Lock setting to *Global Volume Lock* so that a device's volume will be locked to one mode (e.g., to control TV volume in all other modes). After that, if desired, you can perform *Individual Volume Unlock* on a selected device to set its volume control for independent operation.





LOCKING VOLUME CONTROL TO ONE MODE (GLOBAL VOLUME LOCK)

1. Press and hold **P** until the bottom IR segment flashes twice.
The program keys will appear:

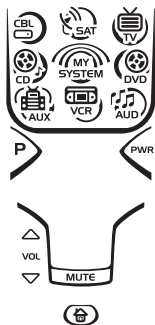

2. Press above **VOL ▲** once. The *Volume Lock* programming screen will appear:



3. Press a device key once (i.e., **CBL, SAT, TV, DVD, AUD, VCR, AUX,** or **CD**) where you want the volume controls locked to. The bottom IR segment will flash twice and the program keys will appear again.
4. To exit programming, press  once. The display will return to the last-selected device menu screen. Now, when you press **VOL ▲**, **VOL ▼**, or **MUTE**, the selected device's volume will be controlled in any mode.

UNLOCKING VOLUME CONTROL FOR A SINGLE DEVICE (INDIVIDUAL VOLUME UNLOCK)

1. Press and hold **P** until the bottom IR segment flashes twice.
The program keys will appear:

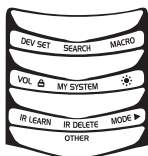

2. Press above **VOL ▲** once. The *Volume Lock* programming screen will appear:

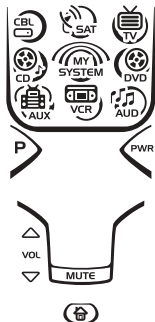

continued on next page...



RadioShack 8-IN-ONE REMOTE POWERED BY KAMELEON

CHANGING VOLUME LOCK

UNLOCKING VOLUME CONTROL FOR A SINGLE DEVICE (INDIVIDUAL VOLUME UNLOCK), CONTINUED

3. Press **VOL** ▼ once. Then press a device key once (i.e., **CBL, SAT, TV, DVD, AUD, VCR, AUX, or CD**) where you want the volume controls unlocked. The bottom IR segment will flash four times and the program keys will appear again.
4. If desired, repeat steps 1 through 3 (of this section) for each device that you want volume to be unlocked.
5. To exit programming, press  once. The display will return to the last-selected device menu screen.
6. Now, after you select a device that has volume unlocked, pressing **VOL** ▲, **VOL** ▼, or **MUTE** will control the device's volume only in its own mode.

UNLOCKING ALL VOLUME CONTROL (RESTORING DEFAULT SETTING)

1. Press and hold **P** until the bottom IR segment flashes twice. The program keys will appear:



2. Press above **VOL** ▲ once. The *Volume Lock* programming screen will appear:

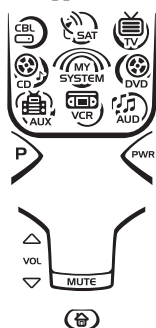

3. Press **VOL** ▲ once. The bottom IR segment will flash four times and the program keys will appear again.
4. To exit programming, press  once. The display will return to the last-selected device menu screen.
5. Volume will again be independently controlled according to its default states for all programmed devices.



USING MACROS

The RadioShack 8-in-One Remote includes six macro keys: **M1** through **M4**, **COM MUTE**, and **PWR**. Each one can be set up to perform a repetitive, time-consuming operation with the press of a single key.

*NOTES: A macro programmed onto the **PWR** key can only be accessed in the **MY SYSTEM** mode. Pressing it in any other mode will only send a “Power On/Off” IR command to the selected device. The **COM MUTE** key can be programmed as a two-state rotating macro. See “Programming The COM MUTE Key” on page 27.*

A macro can be used to control a home theater operation, to set a favorite channel, or for other multiple functions you would like to control with one key press. Moreover, each macro key can hold up to 15 key presses total.

NOTE: Programming a new macro over an existing one will erase the original macro.

PROGRAMMING A FAVORITE CHANNEL MACRO

With so many channels available on your cable or satellite system, you can program a macro that directly selects a favorite channel with one key press. For example, let's assume your favorite cable programs are on channel 71. Use the following instructions to program a macro for direct access of this channel:

NOTE: The following example assumes all equipment is turned off and that the TV is connected through the Cable Box with TV tuning set to channel 3.

1. Press and hold **P** until the bottom IR segment flashes twice. The program keys will appear:

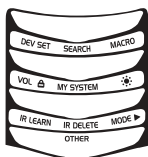

2. Press above **MACRO** once. The *Macro* programming screen will appear:

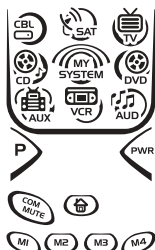

3. Press an open macro key (e.g., **M1**, **M2**, **M3**, or **M4**). The last-selected device menu screen, including , will be displayed.
4. Enter a desired macro sequence of up to 15 key presses. For this example, press **TV** once, followed by **PWR** once, and then enter **0 3** for the TV's channel number. Next, press **CBL** once, followed by **PWR** once, and then enter **0 7 1** for the Cable Box's channel number.

continued on next page...



RadioShack 8-IN-ONE REMOTE POWERED BY KAMELEON

USING MACROS

PROGRAMMING A FAVORITE CHANNEL MACRO (CONTINUED)

NOTE: If there are more than 15 key presses in the sequence, the bottom IR segment will display a long flash, denoting an error. The display will return to the last-selected device menu screen. To program the macro, start again with step 3.

5. To save the macro, press and hold **P** until the bottom IR segment flashes twice. The program keys will appear again.
6. Exit programming by pressing  once. The display will return to the last-selected device menu screen.
7. Now, if you aim the remote at the devices selected in step 4 and press the programmed macro key once, the TV will turn on and tune to channel 3. Then, the Cable Box will turn on and tune to channel 071.

PROGRAMMING A MASTER POWER MACRO IN MY SYSTEM MODE

A macro can be programmed onto the **PWR** key to turn on or off as many as seven home theater devices.

NOTE: This following example assumes the Home Theater system contains a Satellite Receiver, a DVD Player, an Audio Receiver, and a TV.

1. Press and hold **P** until the bottom IR segment flashes twice. The program keys will appear:

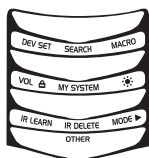

2. Press above **MACRO** once. The *Macro* programming screen will appear:

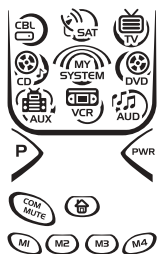

3. Press **PWR** once. The last-selected device menu screen, including , will be displayed.
4. Enter the macro sequence. For this example, press **SAT** once, followed by **PWR** once. Next, press **DVD** once, followed by **PWR** once. Then press **AUD** once, followed by **PWR** once. Finally, press **TV** once, followed by **PWR** once, and then **MY SYSTEM** once.
5. To save the power macro, press and hold **P** until the bottom IR segment flashes twice. The program keys will appear again.



- Exit programming by pressing  once. The display will return to the last-selected device menu screen.
- To test the power macro, first make sure all home theater devices selected in step 4 are turned on. Aim the remote control at the devices and press **MY SYSTEM** once, followed by **PWR** once. The devices should turn off in this order: Satellite Receiver, DVD Player, Audio Receiver, and TV.

To turn on the devices on again in the same order as above, press **PWR** once.

PROGRAMMING THE COM MUTE KEY

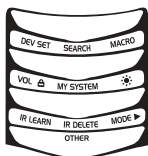

If desired, a two-state rotating macro can be programmed onto the **COM MUTE** key, so a key press will drop volume (in the **CBL**, **SAT**, **TV**, **VCR**, or **AUX** mode) to a preset level during a commercial. When the program resumes, another key press will raise it back to the original level.

- Press and hold **P** until the bottom IR segment flashes twice. The program keys will appear:

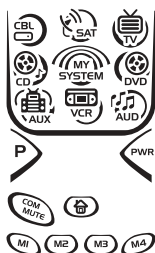

- Press above **MACRO** once. The *Macro* programming screen will appear:



- Press **COM MUTE** once. The last-selected device menu screen, including , will be displayed.
- Enter the first macro sequence by pressing **TV** once, then press **VOL▼** four times (to lower the volume four steps).
- To save the macro, press and hold **P** until the bottom IR segment flashes twice. The program keys will appear again.
- To program the second macro, repeat steps 2 through 5, but substitute **VOL▲** for **VOL▼** this time (to raise the level four steps).
- Exit programming by pressing  once. The display will return to the last-selected device menu screen.

continued on next page...



RadioShack 8-IN-ONE REMOTE POWERED BY KAMELEON

USING MACROS (Continued)

CLEARING A MACRO

1. Press and hold **P** until the bottom IR segment flashes twice.
The program keys will appear:



2. Press above **MACRO** once. The *Macro* programming screen will appear:

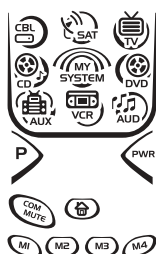

3. Select the macro key to be cleared and press it once. The last-selected device menu screen will be displayed.
4. Press and hold **P** until the bottom IR segment flashes twice.
The program keys will appear again.
5. Exit programming by pressing  once. The display will return to the last-selected device menu screen.



USING KEYMOVER

The RadioShack 8-in-One Remote includes a Keymover feature that allows you to map (or copy) keys from one mode (i.e., source mode) to another mode (i.e., destination mode).

NOTE: Do not use any of the device keys as a source or destination key.

PROGRAMMING KEYMOVER

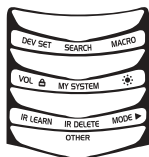

For example, if your DVD player does not have volume control, you can map those keys (i.e., **VOL ▲**, **VOL ▼**, and **MUTE**) from the TV mode to DVD mode as follows:

1. Press and hold **P** until the bottom IR segment flashes twice.
The program keys will appear:

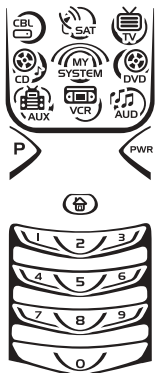

- Press below **OTHER** once. The *Other* programming screen will appear:



- Using the number keys, enter **9 9 4**. The bottom IR segment will flash twice.
- For the source mode, press a desired device key once (i.e., **CBL, SAT, TV, DVD, AUD, VCR, AUX, or CD**). For this example, press **TV** once. The selected source device menu screen, including , will be displayed.
- For the source key, press a key to be moved once. For this example press **VOL ▲** once.
- For the destination mode, press a desired device key once (i.e., **CBL, SAT, TV, DVD, AUD, VCR, AUX, or CD**). For this example, press **DVD** once. The selected destination device menu screen, including , will be displayed.
- For the destination key, press a key to be moved once. For this example press **VOL ▲** once. Upon keymoving, the bottom IR segment will flash twice as confirmation. The program keys will appear again.
- Repeat steps 2 through 7 two more times to map the remaining volume control keys, substituting **VOL ▼** and **MUTE** as source and destination keys in steps 5 and 7.
- Exit programming by pressing  once. The display will return to the last-selected device menu screen.

Upon completion of the above procedure, you can now use your RadioShack 8-in-One Remote to control the TV's volume and mute in the DVD mode, as well as in the TV mode.

RESTORING A SINGLE KEYMOVED KEY

- Press and hold **P** until the bottom IR segment flashes twice. The program keys will appear:

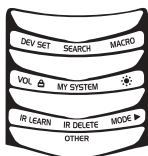

continued on next page...





RadioShack 8-IN-ONE REMOTE POWERED BY KAMELEON

USING KEYMOVER

RESTORING A SINGLE KEYMOVED KEY (CONTINUED)

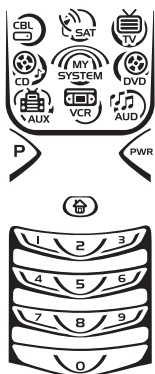
2. Press below **OTHER** once. The *Other* programming screen will appear:



3. Using the number keys, enter **9 9 4**. The bottom IR segment will flash twice.
4. Press the destination mode once where the keymoved key is stored. Then press the destination key twice. Upon key restoration, the bottom IR segment will flash twice as confirmation. The program keys will appear again.
5. If desired, repeat steps 2 through 4 to restore another key.
6. Exit programming by pressing  once. The display will return to the last-selected device menu screen.

RESTORING ALL KEYMOVED KEYS IN A SINGLE MODE

1. Perform steps 1 through 3 of *Programming Keymover* on the previous page.
2. Press the destination mode twice where the keymoved keys are stored. Upon key restoration, the bottom IR segment will flash twice as confirmation. The program keys will appear again.
3. Exit programming by pressing  once. The display will return to the last-selected device menu screen.



PROGRAMMING FAVORITE CHANNEL SCAN

In the **CBL**, **SAT**, **TV**, **VCR**, or **AUX** mode, the RadioShack 8-in-One Remote can store a list of up to 10 favorite channels, in any order, that will be immediately scanned when you press **FAV SCAN** once (see *Using Channel Scan* on page 32).

NOTE: Favorite channels can only be programmed for one mode. After programming, if **FAV SCAN** is pressed while in another mode, the remote control will start a normal channel scan instead (if applicable to the selected device).



1. Press and hold **P** until the bottom IR segment flashes twice.

The program keys will appear:



2. Select a *Favorite Channel Mode* by pressing **CBL**, **SAT**, **TV**, **VCR**, or **AUX** once. The bottom IR segment flashes once as the selected device key animates.
3. Press below **OTHER** once. The *Other* programming screen will appear:

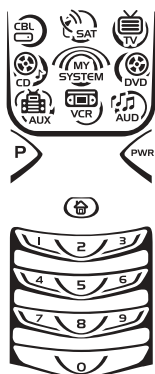

4. Using the number keys, enter **9 9 6**. The bottom IR segment will flash twice and the *Favorite Channel* programming screen will appear.

NOTE: If the bottom IR segment displays one long flash, an error has occurred. Try repeating this step.

5. Using the number keys, enter a favorite channel number (e.g., **0 1 2**). Then press **P** once.

*NOTE: If the original remote control required pressing an Enter key to change the channel, also press the **ENTER** key after the channel number (e.g., **0 1 2 ENTER**).*

6. If desired, repeat step 5 for each channel to be stored, up to a total of 10 channels.

NOTE: After storing 10 channels, the remote control will exit the Favorite Channel programming screen and again display the program keys.

7. To exit programming with less than 10 favorite channels stored, press and hold **P** until the bottom IR segment flashes twice. The display will return to the last-selected device menu screen.



RadioShack 8-IN-ONE REMOTE POWERED BY KAMELEON

USING CHANNEL SCAN

In the **CBL, SAT, TV, VCR**, or **AUX** mode, use **FAV SCAN** to start a 3-second scan of all favorite channels (if programmed – see *Programming Favorite Channel Scan* on page 30) and/or all channels for the selected mode.

1. If *Favorite Channel Scan* has been set up, skip to step 2. Otherwise, press **CBL, SAT, TV, VCR**, or **AUX** once. The bottom IR segment flashes once as the selected device key animates.
2. Press **FAV SCAN** once. The IR segments will display outgoing animation as each channel is changed.
 - If *Favorite Channel Scan* has been set up, scanning of favorite channels will start and cycle through stored channels for 3 minutes or until any key press stops it.
 - If *Favorite Channel Scan* has not been set up, scanning will start with the current channel, then proceed to the next channel up and cycle through all channels for 3 minutes or until stopped by pressing any key.
3. To stop scanning channels at any time, press any key once.



USING MY SYSTEM MODE

The RadioShack 8-in-One Remote includes a custom *Home Theater* mode. After **MY SYSTEM** is programmed, it will allow you to access four groups of remote control keys without having to change device modes.

CONTROL ORGANIZATION

ABOUT CONTROL GROUPS

For *Home Theater* programming, the remote's keys are grouped by type of control into the following four control groups:

<i>Video Playback Group:</i>	Transport controls (REW, PLAY, FWD, REC, PAUSE , and STOP)
<i>Volume Controls Group:</i>	VOL ▲, VOL ▼ , and MUTE
<i>Channel Controls Group:</i>	CH ▲, CH ▼, INPUT , number keys (0 ~ 9), TV/VCR, FAV SCAN, ENTER , and LAST
<i>Menu Controls Group:</i>	Cursor controls (▲, ▼, ◀, ▶), OK, PAGE+, PAGE-, MENU, INFO, GUIDE , and EXIT

ABOUT DEVICE MODES

Moreover, the above *Control Groups* can be used in the following modes:

<i>Video Playback Group:</i>	CBL, SAT, DVD, AUD, VCR, AUX , and CD
<i>Volume Controls Group:</i>	CBL, SAT, TV, DVD, AUD, VCR, AUX , and CD



Channel Controls Group: **CBL, SAT, TV, DVD, VCR, and AUX**

Menu Controls Group: **CBL, SAT, TV, DVD, AUD, VCR, AUX, and CD**

FACTORY DEFAULT SETTINGS

At the factory, the Control Groups are assigned the following modes as default settings:

Video Playback Group: **DVD**

Volume Controls Group: **AUD**

Channel Controls Group: **CBL**

Menu Controls Group: **CBL**

If the default settings fit your needs, you can skip programming this mode. Otherwise, perform the steps in the following section to assign device modes to the *Control Groups*.

PROGRAMMING MY SYSTEM MODE

1. Press any device key once (i.e., **CBL, SAT, TV, DVD, AUD, VCR, AUX, or CD**). The selected device key will animate.
2. Press and hold **P** until the bottom IR segment flashes twice. The program keys will appear:

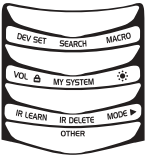

3. Press above **MY SYSTEM** once. The *Video Playback* programming screen will appear:

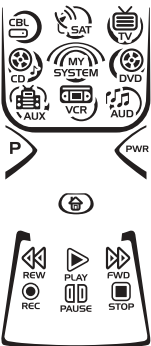

NOTE: For steps 3 through 7, if a device key is animated, it is assigned to its respective function group. To continue programming the My System mode, you must select a device key, even if it is the same one that is currently animated.

continued on next page...



RadioShack 8-IN-ONE REMOTE POWERED BY KAMELEON

USING MY SYSTEM MODE

PROGRAMMING MY SYSTEM MODE (CONTINUED)

4. To assign a mode to the *Video Playback* group, press a device key once (i.e., **CBL, SAT, TV, DVD, AUD, VCR, AUX, or CD**). Then the *Volume Controls* programming screen will appear:

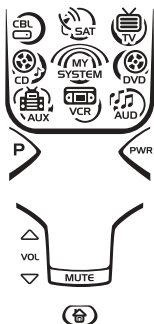

5. To assign a mode to the *Volume Controls* group, press a device key once. Then the *Channel Controls* programming screen will appear:

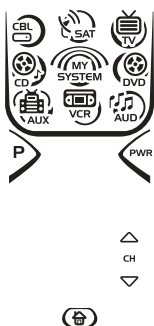

6. To assign a mode to the *Channel Controls* group, press a device key once. Then the *Menu Controls* programming screen will appear:



7. To assign a mode to the *Menu Controls* group, press a device key once. Since *My System* programming is now complete, the program keys will appear again.
8. Exit programming by pressing  once. The display will return to the last-selected device menu screen.



REASSIGNING DEVICE KEYS

The RadioShack 8-in-One Remote can be set to control a second device. For example, to control a TV, a Cable Box, and *two* DVD Players, you can reassign the unused **AUX** key to operate the second DVD Player as follows:

1. Press and hold **P** until the bottom IR segment flashes twice.

The program keys will appear:

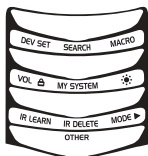

2. Press above **MODE** once. The *Mode Mover* programming screen will appear:

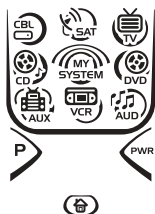

3. For the source mode, press a device key once (i.e., **CBL, SAT, TV, DVD, AUD, VCR, AUX,** or **CD**). For this example, press **DVD** once. The selected device menu screen, including , will be displayed.

NOTE: Only one device can be assigned to an unused device key at a time.

4. For the destination mode, press a device key once (i.e., **CBL, SAT, TV, DVD, AUD, VCR, AUX,** or **CD**). For this example, press **AUX** once. Upon reassignment, the bottom IR segment will flash twice as confirmation. The program keys will appear again.
5. For this example, the **AUX** key is now ready to be set up to control your second DVD player. See *Programming A Device* on page 14. If desired, repeat steps 2 through 5 to reassign another device.
6. Exit programming by pressing  once. The display will return to the last-selected device menu screen.



RadioShack 8-IN-ONE REMOTE POWERED BY KAMELEON

USING COMMERCIAL SKIP

The RadioShack 8-in-One Remote includes a unique feature for skipping past commercials on recorded programs when using a PVR (DVR) or VCR. This feature works in the **CBL, SAT, VCR,** or **AUX** mode and you can use the default settings or program custom ones..

USING THE DEFAULT SETTINGS

The **COM SKIP** key is preprogrammed to perform the *Commercial Skip* function of your original remote control (if available).

To use the default setting, simply aim the remote at the desired device, and press **COM SKIP** once for each skip of two commercials.

PROGRAMMING COMMERCIAL SKIP

To customize *Commercial Skip* settings, perform the following steps:

1. Turn on a desired device (e.g., VCR or PVR) and view the commercials you want to skip. Then position the media back to the start of first commercial in the sequence.
2. Press the appropriate assigned device key once (i.e., **CBL, SAT, VCR,** or **AUX**). The selected device key will animate.
3. Press and hold **P** until the bottom IR segment flashes twice. The program keys will appear:



4. Press below **OTHER** once. The *Other* programming screen will appear:

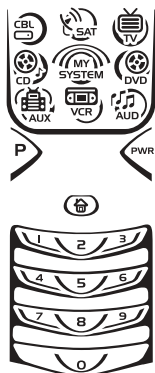

5. Using the number keys, enter **9 7 4**. The The bottom IR segment will flash twice and the *Commercial Skip* programming screen will appear:

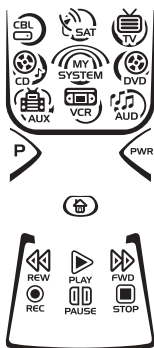

6. Select a *Commercial Skip* mode by pressing **CBL**, **SAT**, **VCR**, or **AUX** once.
7. Press **FFWD** once and watch for the end of a commercial sequence that typically may have four to six commercials and last 2 to 3 minutes in real time. As it ends, press **PLAY** once.

*NOTE: If the time between **FFWD** and **PLAY** key presses exceeds 30 seconds, the program will ignore your action. The bottom IR segment will display a long flash to denote the time limit has been exceeded and the screen will return to the Program Keys menu. You will need to start again at step 4 and perform this step within 30 seconds.*

*NOTE: Although **FFWD** and **PLAY** keys are used in programming this step, other keys may be used depending on how they functioned on the original remote control.*

8. To save the settings, press and hold **P** until the bottom IR segment flashes twice. The program keys will appear again.
9. Exit programming by pressing  once. The display will return to the last-selected device menu screen.



RadioShack 8-IN-ONE REMOTE POWERED BY KAMELEON

SETTING THE TILT SWITCH

The RadioShack 8-in-One Remote contains a *Tilt Switch* that activates the display when the unit is moved. If desired, you can disable it so only pressing a key will turn on the display.

NOTE: Disabling the Tilt Switch can help conserve battery life.

DISABLING THE TILT SWITCH

1. Press and hold **P** until the bottom IR segment flashes twice. The program keys will appear:

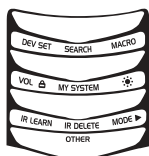

2. Press below **OTHER** once. The *Other* programming screen will appear:

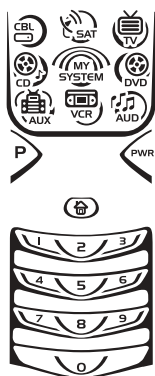

3. Using the number keys, enter **9 8 5**. The The bottom IR segment will flash four times, confirming the *Tilt Switch* is disabled. The program keys will appear again.
4. Exit programming by pressing  once. The display will return to the last-selected device menu screen.

ENABLING THE TILT SWITCH

1. Perform steps 1 and 2 of the previous section, *Disabling The Tilt Switch*.
2. Using the number keys, enter **9 8 5**. The The bottom IR segment will flash twice, confirming the *Tilt Switch* is enabled. The program keys will appear again.
3. Exit programming by pressing  once. The display will return to the last-selected device menu screen.



SETTING THE FINDER RECEIVER

The RadioShack 8-in-One Remote comes with a *Finder Transmitter* that can be used to quickly locate the main remote if it is accidentally lost or misplaced. At the factory, the *Finder Receiver* (inside the remote) is set to wake up every few seconds, listen for a signal from the *Finder Transmitter*, and then emit an audible alert to pinpoint the location of the main remote. This is a great feature, but it does use extra battery power. If you do not plan to use the *Finder Transmitter*, we recommend turning off the remote's *Finder Receiver* to conserve battery life.

DISABLING THE FINDER RECEIVER

1. Press and hold **P** until the bottom IR segment flashes twice.

The program keys will appear:

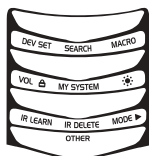

2. Press below **OTHER** once. The *Other* programming screen will appear:

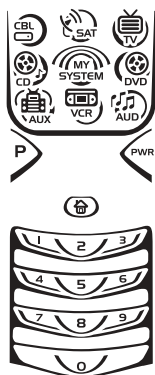

3. Using the number keys, enter **9 7 2**. The bottom IR segment will flash four times, confirming the *Finder Receiver* is disabled. The program keys will appear again.
4. Exit programming by pressing  once. The display will return to the last-selected device menu screen.

ENABLING THE FINDER RECEIVER

1. Perform steps 1 and 2 of the previous section, *Disabling The Finder Receiver*.
2. Using the number keys, enter **9 7 2**. The bottom IR segment will flash twice, confirming the *Finder Receiver* is enabled. The program keys will appear again.
3. Exit programming by pressing  once. The display will return to the last-selected device menu screen.



RadioShack 8-IN-ONE REMOTE POWERED BY KAMELEON

RESTORING FACTORY DEFAULT SETTINGS

The RadioShack 8-in-One Remote includes a *Setup Code Reset* program. You can use it to restore all your programmed codes to factory settings and delete all custom programming.

IMPORTANT: *Executing this program will erase all code settings (except upgraded codes) and all custom settings for My System, Macros, Learned Keys, Reassigned Device Keys, Keymoved Keys, Favorite Channels, and all device settings.*

1. Press and hold **P** until the bottom IR segment flashes twice.
The program keys will appear:

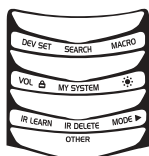

2. Press below **OTHER** once. The *Other* programming screen will appear:

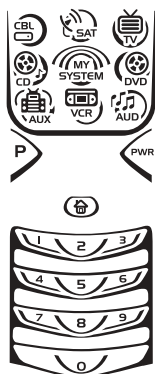

3. Using the number keys, enter **9 7 7**. The bottom IR segment will flash twice, pause and flash twice again to confirm restoration.
4. Exit programming by pressing  once. The display will return to the last-selected device menu screen.



CLEARING ALL CUSTOM PROGRAMMING

The RadioShack 8-in-One Remote contains a *Custom Programming Reset* program. You can use it to remove all custom programming, except your setup codes and reassigned device keys.

IMPORTANT: *Executing this program will erase all custom settings for My System, Macros, Learned Keys, Keymoved Keys, and Favorite Channels.*



1. Press and hold **P** until the bottom IR segment flashes twice.

The program keys will appear:

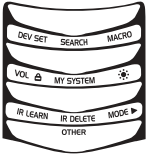

2. Press below **OTHER** once. The *Other* programming screen will appear:

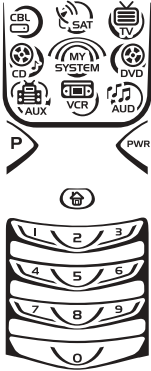

3. Using the number keys, enter **9 8 0**. The bottom IR segment will flash twice, pause and flash twice again to confirm restoration.
4. Exit programming by pressing once. The display will return to the last-selected device menu screen.



SPECIFICATIONS

Remote Power (4) AAA Batteries

Finder Transmitter Power (1) 9 V Battery

Finder Transmitter to Remote Range 30 ft (9.1 m)

Remote Dimensions

(H x W x D) 9.44 x 2.64 x 1.02 in.

(H x W x D) 240 x 67.2 x 26 mm

Finder Transmitter Dimensions

(H x W x D) 4.8 x 1.6 x 0.92 in.

(H x W x D) 120 x 40 x 23 mm

Remote Weight (no batteries) 0.4 lb (181.4 g)

Finder Transmitter Weight (no battery) 0.1 lb (45.4 g)

NOTE: Specifications are typical. Individual units might vary. Specifications are subject to change and improvement without notice.



RadioShack 8-IN-ONE REMOTE POWERED BY KAMELEON

ABOUT UPGRADING

Your RadioShack 8-in-One Remote has the largest infrared code library available and contains a unique feature that allows new codes to be added to its memory over the phone. In a matter of seconds, your remote will quickly and reliably record the new information without complex plugs, adapters, or attachments.

This means that as you buy new entertainment devices in the future, the RadioShack 8-in-One Remote will never become obsolete. Simply call our consumer help-line, and one of our customer service representatives will assist you through the entire process of upgrading your RadioShack 8-in-One Remote.

Consumer Help-Line: (800) 950-7044

NOTE: RadioShack reserves the right to replace a returned remote-control with a new one of equal or superior functionality.

UPGRADE PROCEDURE

1. Call our Consumer Help-Line at: (800) 950-7044 on any business day, between 9:00 A.M. and 5:30 P.M., EST.
2. Our customer service agent will ask for and record the brand name(s) and model number(s) of your device(s). Then the agent will lead you through the upgrade procedure by asking you to place your telephone's speaker next to the **PWR** key on the RadioShack 8-in-One Remote (see below).

NOTE: Only use a land-line phone for the upgrade procedure. Do not use a mobile phone, because it will not transmit the signals correctly.

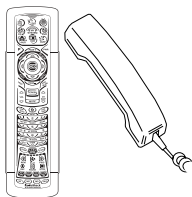

In a matter of seconds, new setup codes for your device(s) will be transmitted through the telephone and stored in your RadioShack 8-in-One Remote.

3. After your RadioShack 8-in-One Remote has been successfully upgraded by telephone, stay on the line. Our customer service agent will ensure that your unit is working properly with your device(s) and answer any other questions you may have.

UPGRADE EXCLUSIONS

- Home entertainment or home automation devices controlled by radio frequency (RF/UHF), wired, or ultrasonic remote controls. Only devices controlled by infrared remote controls are covered.
- Home entertainment or home automation devices not controlled by remote controls.



- Broken or defective product.
- Products that operate over 100 kHz.
- Infrared keyboards and infrared pointing devices (such as mouse substitutes).
- All products for sale and/or use outside the continental United States, Hawaii, Alaska, or Canada.



TROUBLESHOOTING

PROBLEM: No display at all times.

SOLUTION: Replace batteries with four new AAA alkaline batteries.

PROBLEM: No display when programming.

SOLUTION: Display has turned off due to inactivity. Start programming again and do not pause while performing instructions.

PROBLEM: Remote Finder does not work.

SOLUTION: Replace battery with new 9-volt alkaline battery; also verify *Finder Receiver* is enabled (see page 39).

PROBLEM: During programming, the bottom IR segment displays a long flash.

SOLUTION: An invalid entry has occurred. Check the keys to be pressed and start program again.

PROBLEM: How do I stop programming?

SOLUTION: Press  once to return to the program keys screen. Press it once more to exit completely.

PROBLEM: The unit does not control home entertainment devices or commands are not working properly.

SOLUTION: Try all listed codes for the device brands being set up. Make sure they can be operated with an infrared remote control.

PROBLEM: Tried *Searching For Your Code* method and still could not find a working code.

SOLUTION: Perform *Restoring Factory Default Settings* on page 40. Then repeat *Searching For Your Code* on page 17.

PROBLEM: Cannot program a macro onto **M1 ~ M4, PWR, or COM MUTE** keys.

SOLUTION: Make sure the total number of key presses being programmed is less than 15.

continued on next page...



RadioShack 8-IN-ONE REMOTE POWERED BY KAMELEON

TROUBLESHOOTING (Continued)

PROBLEM: Power macro does not work.

SOLUTION: First press **MY SYSTEM** once, then press **PWR** once.

PROBLEM: Favorite channel function does not work properly.

SOLUTION: Some devices (e.g., Cable Boxes or Satellite Receivers) use two-digit channel numbers. During programming, press **ENTER** or **OK** once after entering a channel number (e.g., **0 2 ENTER** for channel 2). See *Programming Favorite Channel Scan* on page 30.

PROBLEM: Changing channels does not work properly.

SOLUTION: If the original remote control required pressing **ENTER** to change channels, then press **ENTER** on the remote control after entering channel numbers.

PROBLEM: No remote control of volume.

SOLUTION: See *Changing Volume Lock* on page 22 to lock/unlock volume.

PROBLEM: Bottom IR segment flashes when pressing a key, but home entertainment device does not respond.

SOLUTION: Make sure the remote is aimed at your home entertainment device and is not farther away than 15 feet.

PROBLEM: **CH ▲** and **CH ▼** do not work for your RCA TV.

SOLUTION: Due to RCA design (1983-1987), only the original remote control will operate these functions.

PROBLEM: Pressing **SCREEN** one or more times in **CBL**, **SAT**, **DVD**, **VCR**, **AUX**, or **MY SYSTEM** mode does not display a secondary menu screen.



SOLUTION: Although **SCREEN** is displayed, for these modes, there are no additional menu screens.

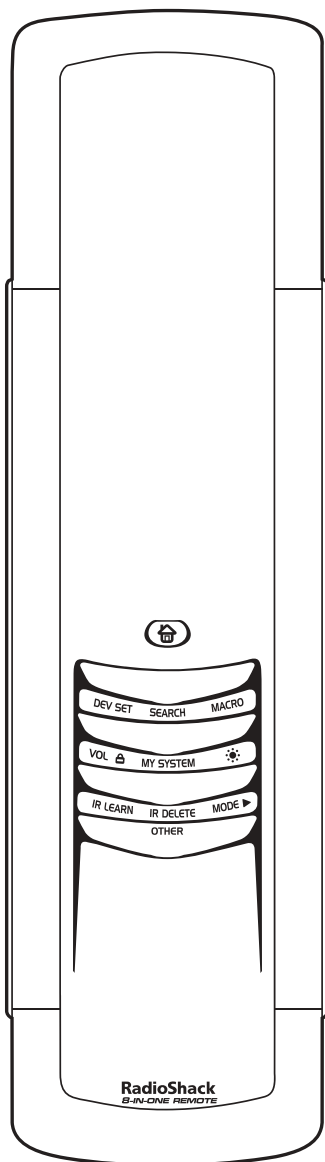

DEVICE MENU SCREENS

PROGRAMMING MAIN MENU



Pressing and holding **P** displays the *Programming Main Menu* screen. Use the program keys to program device control (**DEV SET**), code search (**SEARCH**), home theater mode (**MY SYSTEM**), volume lock (**VOL** ) , macros (**MACRO**), display brightness (), function learning (**IR LEARN** and **IR DELETE**), device key reassignment (**MODE** ), or other functions (**OTHER**).

See the *Table of Contents* on page 2 to locate a section of interest.



RadioShack 8-IN-ONE REMOTE POWERED BY KAMELEON

DEVICE MENU SCREENS (Continued)

AUD MAIN MENU

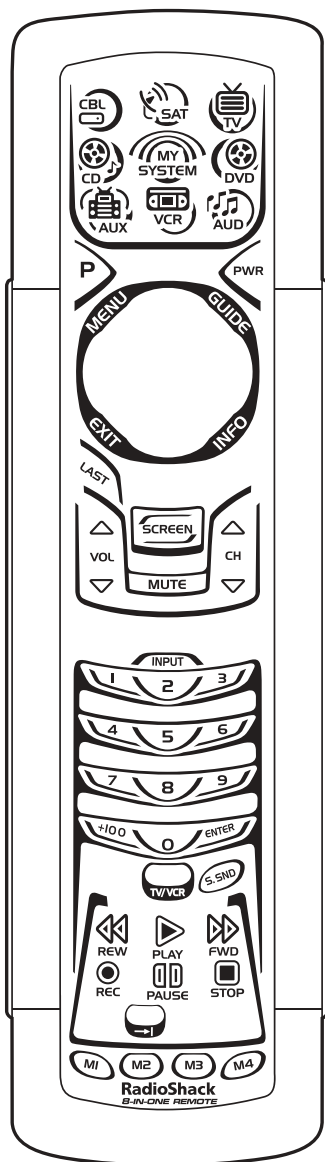

Pressing **AUD** once displays the *AUD Main Menu* screen. After device programming, use these keys to remotely control your Audio Receiver's or Amplifier's volume and stations, select source inputs, operate transport functions on a built-in CD player (or DVD player, if HTiB device), and access menu or preset functions.

Pressing **SCREEN** once will display a secondary *AUD Menu* (as shown on the next page).



AUD MENU

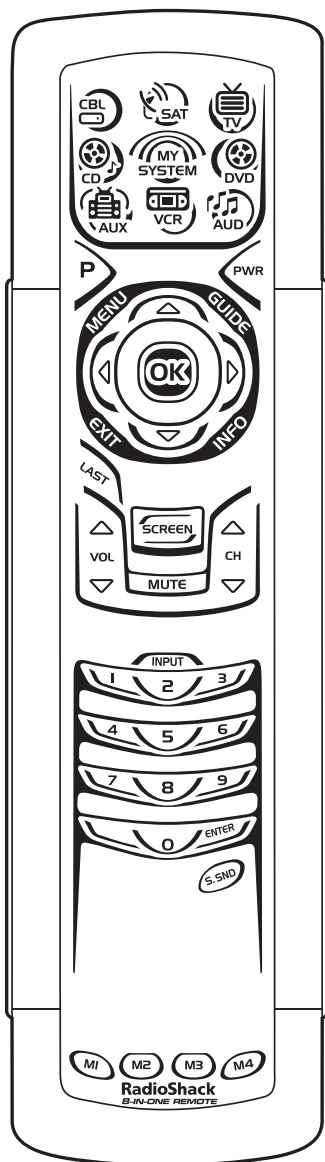

Pressing **SCREEN** once (on the *AUD Main Menu*, as shown on the previous page) displays a secondary *AUD Menu* screen. Use these keys to remotely control your Audio Receiver's or Amplifier's volume, stations, and surround functions.

Pressing **SCREEN** once more returns the display to the *AUD Main Menu* screen.



RadioShack 8-IN-ONE REMOTE POWERED BY KAMELEON

DEVICE MENU SCREENS (Continued)

AUX MAIN MENU

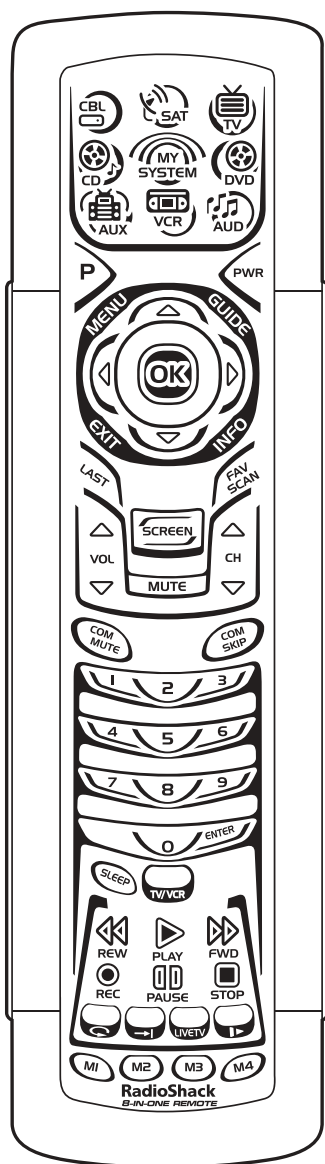

Pressing **AUX** once displays the *AUX Main Menu* screen. After device programming, use these keys to remotely control all your device's common features, such as volume and channels, and menu, guide, and navigation functions.



CBL MAIN MENU

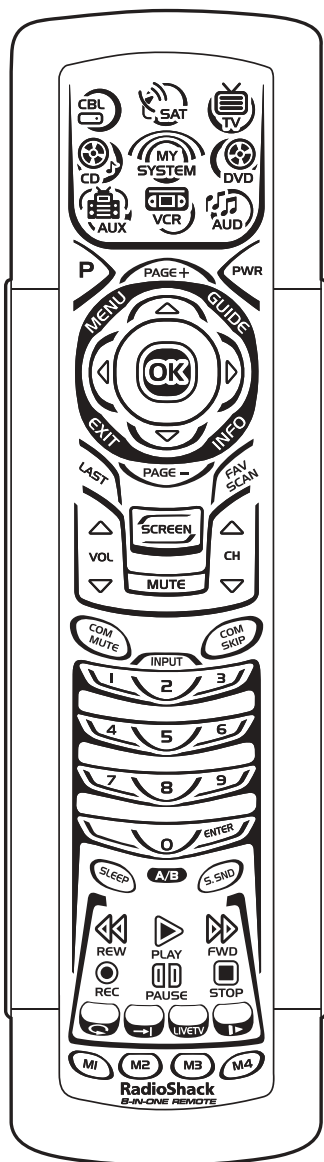

Pressing **CBL** once displays the *CBL Main Menu* screen. After Cable Box programming, use these keys to remotely control all your device's common features, such as volume and channels, and menu, guide, and navigation functions.



RadioShack 8-IN-ONE REMOTE POWERED BY KAMELEON

DEVICE MENU SCREENS (Continued)

CD MAIN MENU

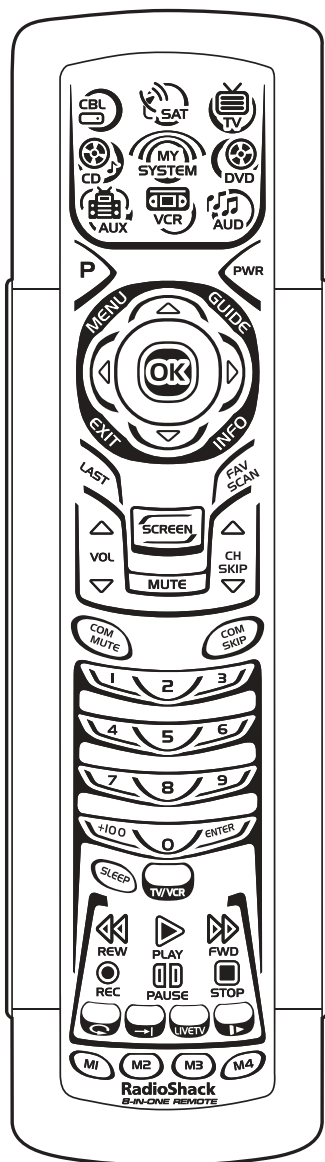

Pressing **CD** once displays the *CD Main Menu* screen. After device programming, use these keys to remotely control your CD player's common features, such as transport keys and skip, menu, and random functions.

Pressing **SCREEN** once will display a secondary *CD Menu* (as shown on the next page).



CD MENU

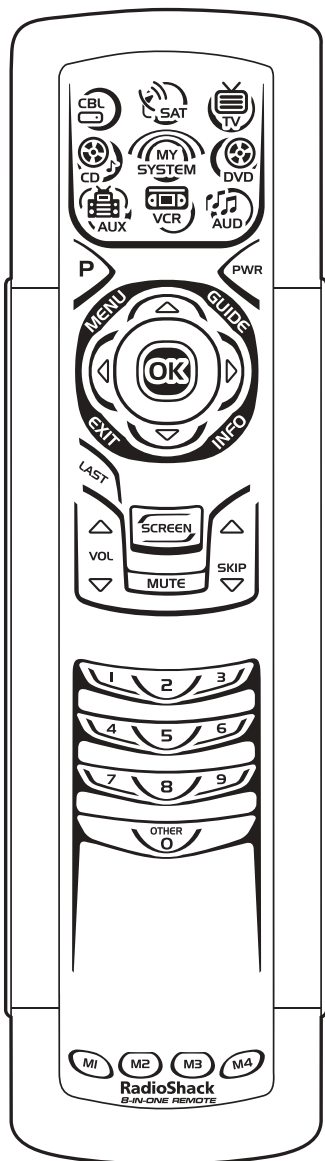

Pressing **SCREEN** once (on the *CD Main Menu*, as shown on the previous page) displays a secondary *CD Menu* screen. Use these keys to remotely control your CD player's navigation functions.

Pressing **SCREEN** once more returns the display to the *CD Main Menu* screen.



RadioShack 8-IN-ONE REMOTE POWERED BY KAMELEON

DEVICE MENU SCREENS (Continued)

DVD MAIN MENU

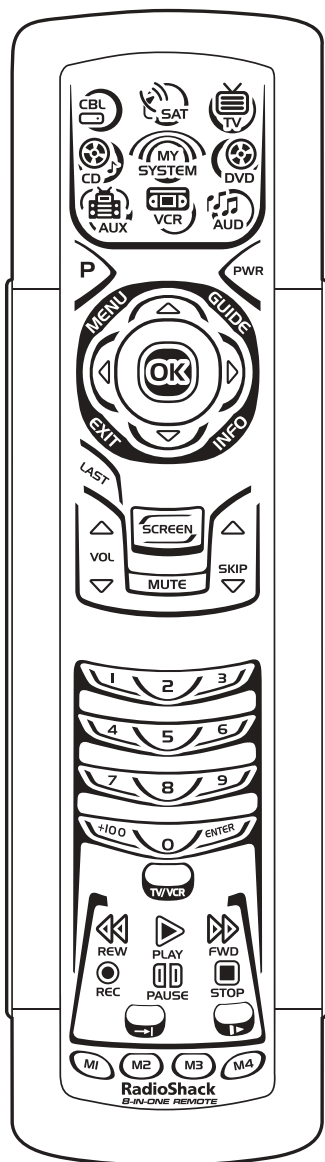

Pressing **DVD** once displays the *DVD Main Menu* screen. After device programming, use these keys to remotely control all your DVD player's common features, such as transport keys and menu, navigation, subtitle, and audio functions.



MY SYSTEM MAIN MENU

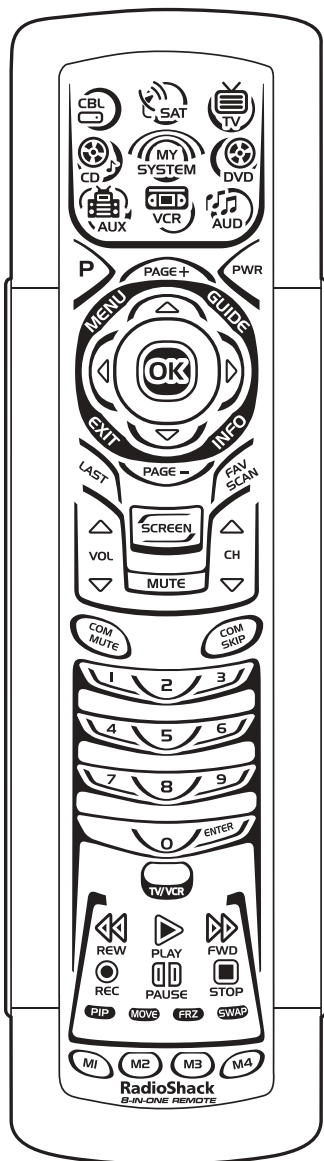

After mode programming, pressing **MY SYSTEM** once displays the *My System Main Menu* screen. Use these keys to remotely access all common features and functions of your home theater system. For details, see *Using My System Mode* on page 32.



RadioShack 8-IN-ONE REMOTE POWERED BY KAMELEON

DEVICE MENU SCREENS (Continued)

TV MAIN MENU

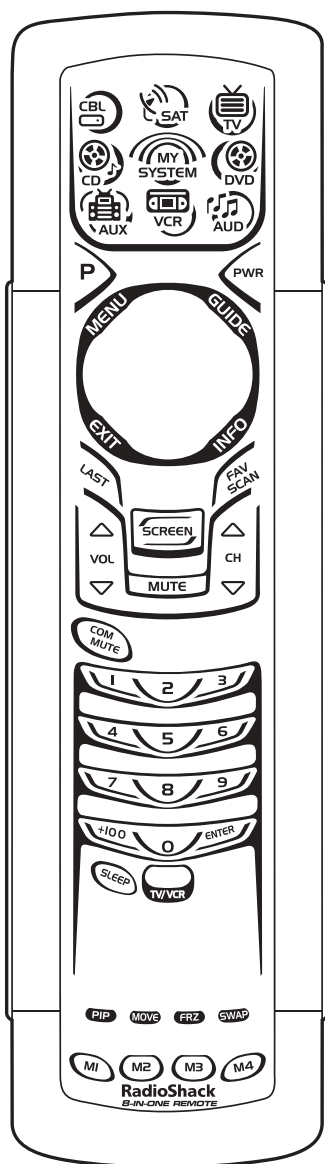

Pressing **TV** once displays the *TV Main Menu* screen. After device programming, use these keys to remotely control all your TV's common features, such as volume and channels, and last channel, menu, and information/display functions.

Pressing **SCREEN** once will display a secondary *TV Menu* (as shown on the next page).



TV MENU

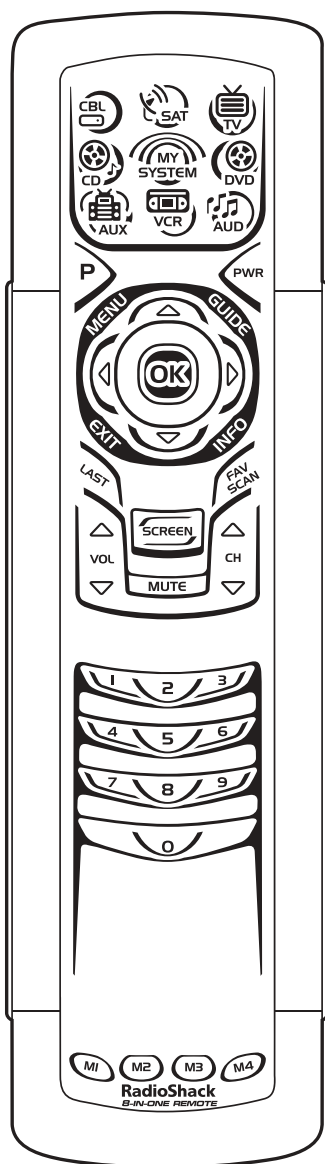

Pressing **SCREEN** once (on the *TV Main Menu*, as shown on previous page) displays a secondary *TV Menu* screen. Use these keys to remotely control all your TV's common menu features.

Pressing **SCREEN** once more returns the display to the *TV Main Menu* screen.



RadioShack 8-IN-ONE REMOTE POWERED BY KAMELEON

DEVICE MENU SCREENS (Continued)

VCR MAIN MENU

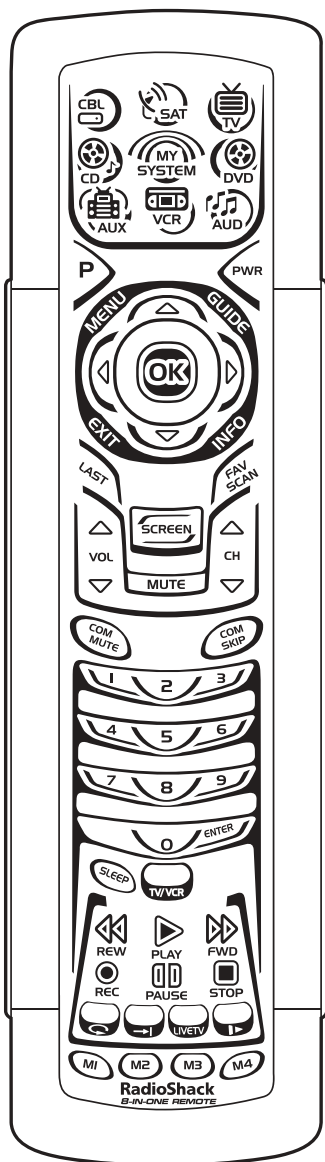

Pressing **VCR** once displays the *VCR Main Menu* screen. After device programming, use these keys to remotely control all your TV's common features, such as volume and channels, and last channel, menu, and information/display functions, and VCR transport controls.



CARE

- Keep the remote dry. If the remote gets wet, wipe it dry immediately.
- Handle the remote gently and carefully. Don't drop it.
- Use and store the remote only in normal temperature environments.
- Keep the remote away from dust and dirt.
- Wipe the remote with a damp cloth to keep it looking new.

Modifying or tampering with internal parts can cause damage and invalidate the warranty. If your remote is not performing as it should, please contact us at:

www.radioshack.com

or visit your local RadioShack store for help.



ADDITIONAL INFORMATION

© 2003 Universal Electronics. No part of this publication may be reproduced, transmitted, transcribed, stored in any retrieval system, or translated to any language, in any form or by any means, electronic, mechanical, magnetic, optical, manual, or otherwise, without the prior written permission of Universal Electronics Inc. Kameleon is a trademark (registration pending) of Universal Electronics.

© 2002 RadioShack Corporation. All Rights Reserved. RadioShack and RadioShack.com are trademarks used by RadioShack Corporation.

The RadioShack 8-in-One Remote Powered By Kameleon is compatible for use in North America. This product uses technologies licensed under one or more of the following U.S. patents: 6,496,135; 6,330,091; 6,195,033; 6,097,309; 6,014,092; 5,959,751; 5,953,144; 5,686,891; 5,638,050; 5,532,463; 5,515,052; 5,481,256; 5,414,761; 5,255,313; 5,228,077; 4,959,810; and patents pending.

M6123



RadioShack 8-IN-ONE REMOTE POWERED BY KAMELEON

INSTRUCTION TO THE USER

This equipment has been tested and found to comply with the limits for a class B digital device, pursuant to part 15 of the FCC Rules. These limits are designed to provide reasonable protection against harmful interference in a residential installation. This equipment generates, uses and can radiate radio frequency energy and if not installed and used in accordance with the instructions, may cause harmful interference to radio communications. However, there is no guarantee that interference will not occur in a particular installation. If this equipment does cause harmful interference to radio or television reception, which can be determined by turning the equipment off and on, the user is encouraged to try to correct the interference by one or more of the following measures:

- Reorient or relocate the receiving antenna.
- Increase the separation between the equipment and receiver.
- Connect the equipment into an outlet on a circuit different from that to which the receiver is connected.
- Consult the dealer or an experienced radio/TV technician for help.

This equipment has been verified to comply with the limits for a class B computing device, pursuant to FCC Rules. In order to maintain compliance with FCC regulations, shielded cables must be used with this equipment. Operation with non-approved equipment or unshielded cables is likely to result in interference to radio and TV reception. The user is cautioned that changes and modifications made to the equipment without the approval of manufacturer could void the user's authority to operate this equipment.



LIMITED 90-DAY WARRANTY

This product is warranted by RadioShack against manufacturing defects in material and workmanship under normal use for ninety (90) days from the date of purchase from RadioShack company-owned stores and authorized RadioShack franchisees and dealers.

EXCEPT AS PROVIDED HEREIN, RadioShack MAKES NO EXPRESS WARRANTIES AND ANY IMPLIED WARRANTIES, INCLUDING THOSE OF MERCHANTABILITY AND FITNESS FOR A PARTICULAR PURPOSE, ARE LIMITED IN DURATION TO THE DURATION OF THE WRITTEN LIMITED WARRANTIES CONTAINED HEREIN. EXCEPT AS PROVIDED HEREIN, RadioShack SHALL HAVE NO LIABILITY OR RESPONSIBILITY TO CUSTOMER OR ANY OTHER PERSON OR ENTITY WITH RESPECT TO ANY LIABILITY, LOSS OR DAMAGE CAUSED DIRECTLY OR INDIRECTLY BY USE OR PERFORMANCE OF THE PRODUCT OR ARISING OUT OF ANY BREACH OF THIS WARRANTY, INCLUDING, BUT NOT LIMITED TO, ANY DAMAGES



RESULTING FROM INCONVENIENCE, LOSS OF TIME, DATA, PROPERTY, REVENUE, OR PROFIT OR ANY INDIRECT, SPECIAL, INCIDENTAL, OR CONSEQUENTIAL DAMAGES, EVEN IF RadioShack HAS BEEN ADVISED OF THE POSSIBILITY OF SUCH DAMAGES.

Some states do not allow limitations on how long an implied warranty lasts or the exclusion or limitation of incidental or consequential damages, so the above limitations or exclusions may not apply to you.

In the event of a product defect during the warranty period, take the product and the RadioShack sales receipt as proof of purchase date to any RadioShack store. RadioShack will, at its option, unless otherwise provided by law: (a) correct the defect by product repair without charge for parts and labor; (b) replace the product with one of the same or similar design; or (c) refund the purchase price. All replaced parts and products, and products on which a refund is made, become the property of RadioShack. New or reconditioned parts and products may be used in the performance of warranty service. Repaired or replaced parts and products are warranted for the remainder of the original warranty period. You will be charged for repair or replacement of the product made after the expiration of the warranty period.

This warranty does not cover: (a) damage or failure caused by or attributable to acts of God, abuse, accident, misuse, improper or abnormal usage, failure to follow instructions, improper installation or maintenance, alteration, lightning or other incidence of excess voltage or current; (b) any repairs other than those provided by a RadioShack Authorized Service Facility; (c) consumables such as fuses or batteries; (d) cosmetic damage; (e) transportation, shipping or insurance costs; or (f) costs of product removal, installation, set-up service adjustment or reinstallation.

This warranty gives you specific legal rights, and you may also have other rights which vary from state to state.

RadioShack Customer Relations,
200 Taylor Street, 6th Floor,
Fort Worth, TX 76102

Cat. No. 15-2138

07/02

RadioShack
Fort Worth, Texas 76102



Free Manuals Download Website

<http://myh66.com>

<http://usermanuals.us>

<http://www.somanuals.com>

<http://www.4manuals.cc>

<http://www.manual-lib.com>

<http://www.404manual.com>

<http://www.luxmanual.com>

<http://aubethermostatmanual.com>

Golf course search by state

<http://golfingnear.com>

Email search by domain

<http://emailbydomain.com>

Auto manuals search

<http://auto.somanuals.com>

TV manuals search

<http://tv.somanuals.com>