

- This guide shows you how to connect your speakers and DVD player and enjoy multi-channel surround sound.
- For full details on using this unit, refer to the main operating instructions.
- Please be certain that this unit is unplugged from the AC outlet before making any connections.

## Placing Speakers

### ■ If you have 5.1 ch speakers

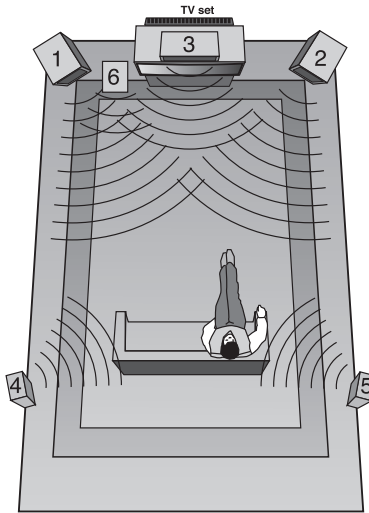

1. Front Left
2. Front Right
3. Center
4. Surround Left
5. Surround Right
6. Subwoofer

## Connecting Speakers

- Be sure to connect speakers firmly and correctly according to the channel (left and right) and the polarity (+ and -). If the connections are faulty, no sound will be heard from the speakers, and if the polarity of the speaker connection is incorrect, the sound will be unnatural and lack bass.

### ■ Caution

- Be sure to use the speakers with the impedance of 6 ohms or above.
- Do not let the bare speaker wires touch each other or any metal part of this unit. This could damage this unit and/or the speakers.
- Never touch the speaker terminals while the AC input cord is connected to the wall AC outlet. Doing so could result in electric shocks.

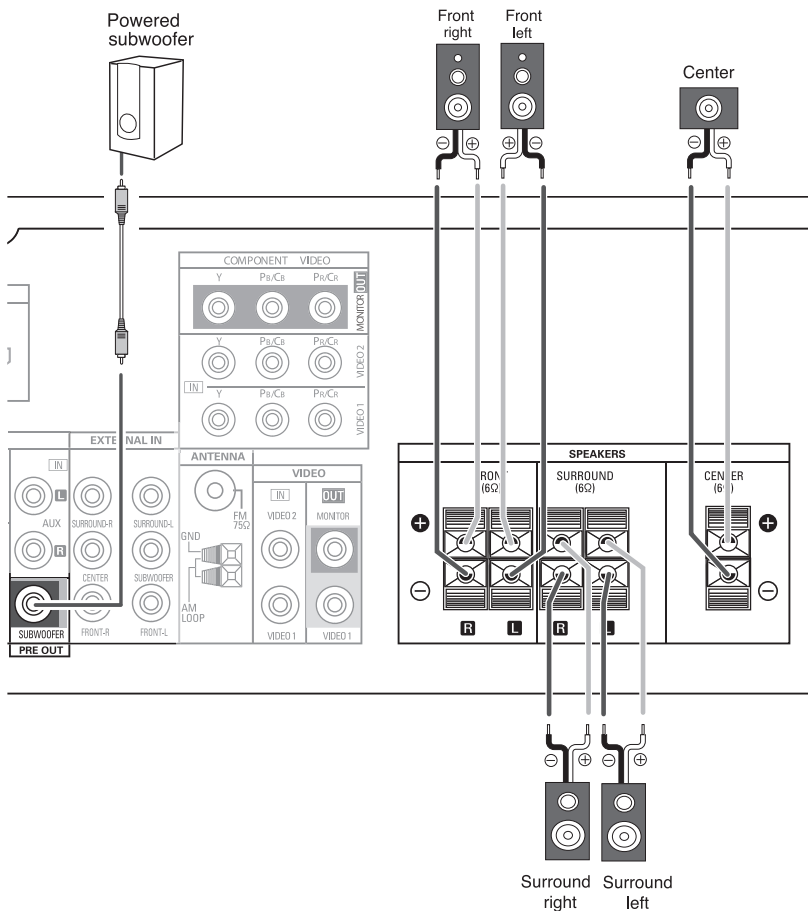

## Connecting TV & DVD Player

### ■ Connecting a TV

- Connect the TV to the same type of Monitor video output that you did connect to the DVD player, as shown.

### ■ Connecting a DVD Player

- Use a Component, S-video or (composite) video cable to connect this unit's VIDEO 2 to the corresponding video output on your DVD player, as shown.
- Use an Optical or Coaxial cable to connect this unit's OPTICAL IN or COAX IN 2 to the optical output or the coaxial output on your DVD player. (You don't need to do both.)
- Use an Audio (analog) cable to connect this unit's VIDEO 2 (L/R) to audio output on your DVD player.
- Use a HDMI cable to connect this unit's HDMI 2 to HDMI output on your DVD player.

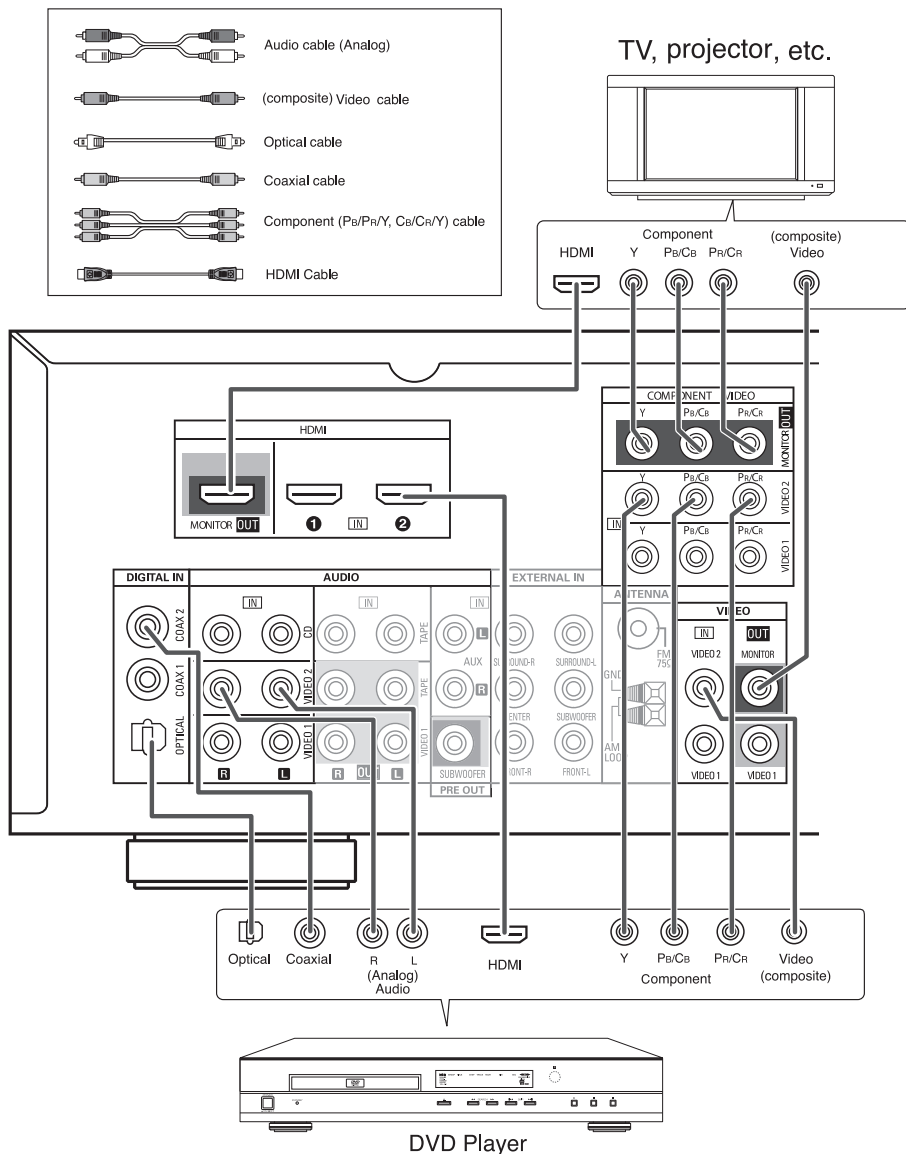

- There are two types of video jacks (COMPONENT, (composite) VIDEO) for analog video connections and the HDMI connector for digital video and audio connections.

Connect them to the corresponding video jacks according to their capability.

- For your reference, the excellence in picture quality is as follows : "HDMI" > "COMPONENT" > "(composite) VIDEO".
- When making COMPONENT VIDEO connections, connect "Y" to "Y", "Pb/Cb" to "Cb" (or "B-Y", "Pb") and "Pr/Cr" to "Cr" (or "R-Y", "Pr").

## Turning on the Unit

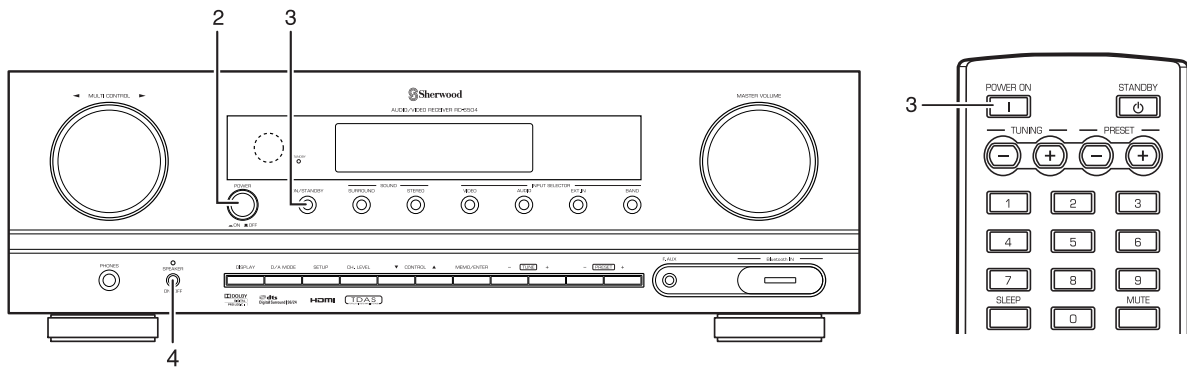

1. Connect the AC input cord.
2. Press the [POWER] switch on the front panel to enter the standby mode.
3. In the standby mode, press the [ON/STANDBY] button on the front panel or [POWER ON] button on the remote control to enter the operating mode.
4. Press the [SPEAKER] button to switch the speakers on.  
Then the SPEAKER indicator lights up and the sound can be heard from the speakers.

## Playing a DVD Player (VIDEO 2)

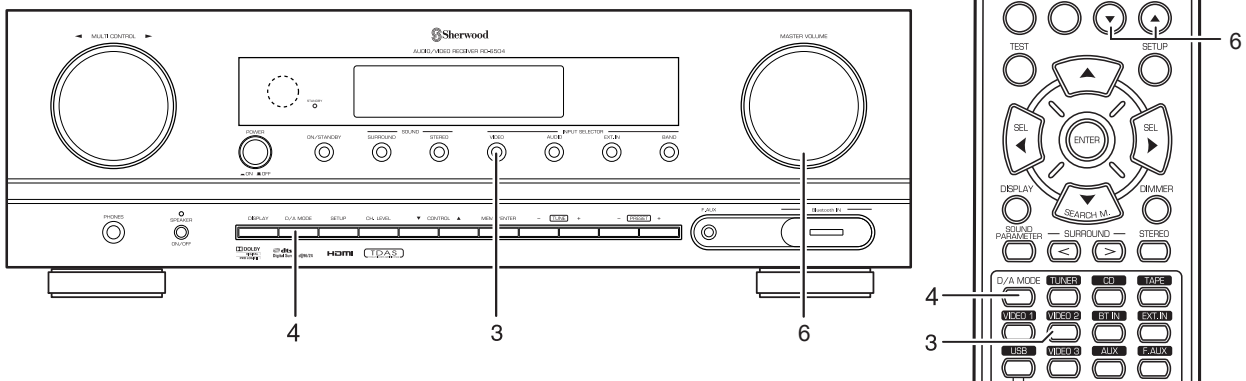

1. Turn on your DVD player and TV.
2. Select the appropriate input on your TV.
3. Press the [VIDEO] button on the front panel to select [VIDEO 2] input source.  
On the remote control, press the [VIDEO 2] button directly.
4. Press the [D/A MODE] button to select the digital input ([o(optical)], [c2(coaxial 2)] or [H(HDMI audio)]) or the analog input ([A(analog)]). When the selected digital input is not connected, the [DIGITAL] indicator flickers and the analog input is automatically selected.
5. Start playback on your DVD player.
6. Adjust the volume.

## Enjoying Surround Sound

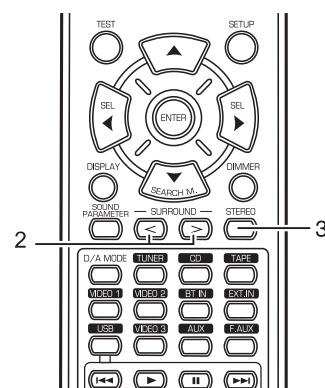
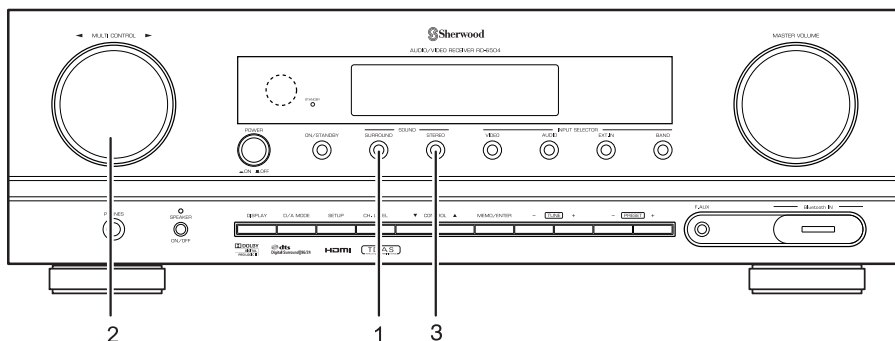

### ■ When CD or VIDEO 1 ~ 2 is selected as an input source

1. Depending on how to select a surround mode, press the [SURROUND] button to select the auto surround mode or the manual surround mode.

Auto Surround Mode : The optimum surround mode will be automatically selected depending on the signal format ([AUTO]) lights up) being input.

Manual Surround Mode : You can select the desired of different surround modes selectable for the signal being ([AUTO]) goes off) input with using the [MULTI CONTROL] knob or the [SURROUND </>] buttons.

### ■ Note :

- When the input source other than CD and VIDEO 1 ~ 2 is selected, you cannot select the auto surround mode and can select the surround mode as desired (the manual surround mode).

### ■ When selecting the manual surround mode.

2. Rotate the [MULTI CONTROL] knob or press the [SURROUND </>] buttons to select the desired surround mode.
  - Then the surround mode changes depending on the input signal format.

### ■ To cancel the surround mode for stereo operation.

3. Press the [STEREO] button.
  - Then either the stereo mode or the 2 CH downmix mode is selected depending on the signal format which is being input.
  - To cancel either the stereo mode or the 2 CH downmix mode, rotate the [MULTI CONTROL] knob or press the [SURROUND </>] buttons to select the surround mode.

### ■ Note :

- You should adjust the speaker settings for the optimum sound acoustics according to your environment and speaker layout. (For details, refer to "SETTING THE SPEAKER SETUP" on the main operating instructions.)

## Free Manuals Download Website

<http://myh66.com>

<http://usermanuals.us>

<http://www.somanuals.com>

<http://www.4manuals.cc>

<http://www.manual-lib.com>

<http://www.404manual.com>

<http://www.luxmanual.com>

<http://aubethermostatmanual.com>

Golf course search by state

<http://golfingnear.com>

Email search by domain

<http://emailbydomain.com>

Auto manuals search

<http://auto.somanuals.com>

TV manuals search

<http://tv.somanuals.com>