

# Safety Information

**EN**

## UK Plug Information

### CONNECT THE MAIN LEAD INTO A MAINS POWER SOCKET

POWER SUPPLY **230V**. It must not be connected to **D.C.** mains.

Note: The mains lead of the set is fitted with a moulded plug. If the mains socket are not compatible or if for any reason the plug is removed please follow the directions below. The moulded plug cannot be rewired and if removed must be disposed of safely.

**DO NOT** under any circumstances plug the severed plug into any mains socket as this could result in electric shock.

**Important:** If the plug is removed, rewire the new plug as follow:

The wires in the mains plug are coloured in accordance to the following code:

**BLUE = NEUTRAL/BROWN = LIVE**

If the colours of the wires in the mains lead of this apparatus may not correspond with the coloured markings identifying the terminals in your plug, proceed as follows:

**BLUE** wire to the terminal coded N (Neutral) or coloured black.



**BROWN** wire to the terminal coded L (Live) or coloured red.

**DO NOT** make any connection to the terminal in the plug which is marked

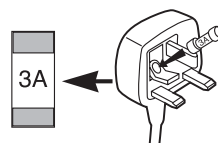
by the letter E or by the earth symbol or coloured green or green and yellow.



A fused plug must be fitted with a 3A fuse approved by ASTA or BS1362 and fuse covers must be always be securely replaced. If you set does not work, the fuse may be blown.

 <p>THE LIGHTNING FLASH AND ARROW-HEAD WITHIN THE TRIANGLE IS A WARNING SIGN ALERTING YOU OF "DANGEROUS VOLTAGE" INSIDE THE PRODUCT.</p>	<p><b>CAUTION</b> RISK OF ELECTRIC SHOCK DO NOT OPEN</p> <p>CAUTION: TO REDUCE THE RISK OF ELECTRIC SHOCK, DO NOT REMOVE COVER (OR BACK). NO USER-SERVICEABLE PARTS INSIDE. REFER SERVICING TO QUALIFIED SERVICE PERSONNEL.</p>	 <p>THE EXCLAMATION POINT WITHIN THE TRIANGLE IS A WARNING SIGN ALERTING YOU OF IMPORTANT INSTRUCTIONS ACCOMPANYING THE PRODUCT.</p>
<p>SEE MARKING ON BOTTOM / BACK OF PRODUCT</p>		

**WARNING: TO PREVENT FIRE OR ELECTRICAL SHOCK HAZARD, DO NOT EXPOSE THIS PRODUCT TO RAIN OR MOISTURE.**

# Safety Information

## CAUTION!

Invisible laser radiation when open. Avoid exposure to beam. Class 1 laser product. This system must be opened only by qualified technicians to prevent accidents caused by the laser beam.

LASER  $\lambda = 780 \text{ nm}$ , P max = 5 mW

Rating Information: At bottom/rear of the unit.

This unit comply with the existing requirements



In accordance with the rating plate of the unit, this unit complies with current standards concerning electrical safety and electromagnetic compatibility.



Please respect the environment. Before throwing any batteries away, consult your distributor who may be able to take them back for specific recycling.



Have a Blast- Just Not in Your Eardrums!

Make sure you turn down the volume on the unit before you put on headphones. Increase the volume to the desired level only after headphone are in place.

EN

**CAUTION** – INVISIBLE LASER RADIATION WHEN OPEN AND INTERLOCKS FAILED OR DEFEATED. AVOID EXPOSURE TO BEAM.

**ATTENTION** – RAYONNEMENT LASER INVISIBLE DANGEREUX EN CAS D'OUVERTURE ET LORSQUE LA SECURITE EST NEUTRALISEE. EXPOSITION DANGEREUSE AU FAISCEAU.

**ADVARSEL!**  
USYNLIG LASERSTRÅLING, NÅR ENHEDEN ER ÅBEN OG SIKKERHEDSÅFBRYDERNE ER UDE AF FUNKTION ELLER OMGÅET. UNDGÅ EKSPONERING FOR STRÅLEN.

**VORSICHT!**  
UNSICHTBARE LASERSTRAHLUNG BEI GEÖFFNETER ABDECKUNG. FALLS SICHERHEITS-VERRIEGELUNG NICHT EINGERASTET IST ODER WENN SIE BEEINTRÄCHTIGT IST. SETZEN SIE SICH NICHT DEM LASERSTRAHL AUS!



CLASS 1 LASER PRODUCT  
LASER KLASSE I  
LASERAPPARAT AV KLASSE I  
AREIL A LASER DE CLASSE I  
LUOKAN I LASERLAITE  
LASERPRODUKT AF KLASSE I

**WARNING!**  
OSYNLIG LASERSTRÅLNING NÅR DENNA DEL ÄR ÖPPNAD OCH SPÄRRARNA ÄR URKOPPLADE. TITTA EJ IN I STRÅLEN.  
**VARO**  
AVÄTTAESSA JA OHITETTAESSA SUOJALUKITUS OLET ALTTIINA NÄKYMÄTTÖMÄLLE LASERSÄTEILYLLE. ÄLÄ KATSO SÄTEESEEN.



# Table of Contents

**EN**

## **Safety Information**

**Table of Contents ..... 1**

**Getting Started ..... 2**

Unpacking Your System ..... 2

Installation ..... 2

    Connecting the Speakers ..... 2

    Using the Antenna ..... 2

**General Controls ..... 3**

Front View ..... 3

Top View ..... 3

Remote Control ..... 4

    Installing Batteries ..... 4

**Settings ..... 5**

Display ..... 5

Setting the Clock ..... 5

Setting the Timer ..... 5

    Activating the Timer ..... 5

Setting Sleep Time ..... 6

    View Remaining Sleep Time ..... 6

    Adjust Sleep Time ..... 6

**Sound Features ..... 6**

Preset Equalizer Curves ..... 6

X-Bass ..... 6

Muting Audio ..... 6

**CD Player ..... 7**

Notes on CD-R/RW ..... 7

Notes on mp3 Discs ..... 7

Loading a Disc ..... 8

Playback ..... 8

Skipping Tracks ..... 8

Searching Through a CD ..... 8

Track Information ..... 8

Selecting Folders ..... 8

Random Playback ..... 9

Sampling Tracks ..... 9

Repeat ..... 9

Setting Up a CD Program ..... 9

    Playing a Program List ..... 9

    View Program List ..... 9

    Deleting Program List ..... 9

**Radio ..... 10**

Selecting Tuner Band ..... 10

Searching for a Station ..... 10

Presetting a Station ..... 10

    Auto Preset Programming ..... 10

    Listening to the Preset Station ..... 10

Suppressing Stereo Signal ..... 10

Tuning to a RDS Station ..... 11

    Displaying RDS Station Information ..... 11

**Tape Player ..... 12**

Playing Cassette Tape ..... 12

Recording a Radio Program ..... 12

Recording a CD ..... 12

Reset Tape Counter ..... 12

**Troubleshooting Tips ..... 13**

**Maintenance ..... 15**

Cleaning ..... 15

CD Player ..... 15

Tape Player ..... 15

Handling CDs ..... 15

Cleaning CDs ..... 15

CD Lens Care ..... 15

**Important Information ..... 16**

Safety Precautions ..... 16

Important Battery Information ..... 16

Headset Safety ..... 16

Don't Infringe ..... 16

Technical Specification ..... 16

# Getting Started

## Unpacking Your System

You should have:

- One main unit (with 2 speakers);
- One remote control;
- One user's guide;
- One Thomson Warranty Card

## Installation

To ensure sufficient ventilation, keep the spacing shown as below:

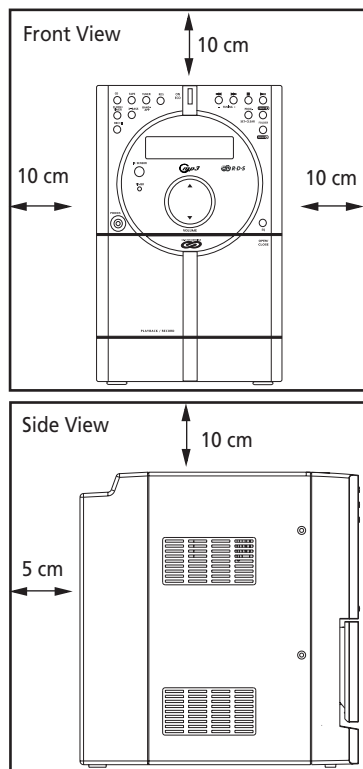

## Connecting the Speakers

When connecting the speakers, match the red wires to the red jacks and the black wires to the black jacks. Each speaker has a black and a red jack, one for positive and one for negative. The top two jacks are for the left speaker, while the bottom two jacks are for the right speaker.

EN

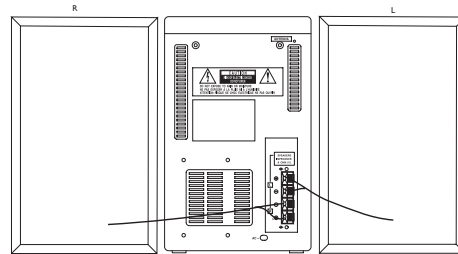

### Speaker Wire Connection

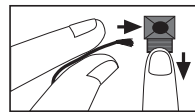

Push Speaker terminal tab down to insert wire.



Release tab to lock wire in the terminal.

**NOTE:** Make sure the insulation is completely removed from the ends of the speaker wires at all connection points.

## Using the Antenna

Before you use your audio system, you'll want to make sure the FM antenna is positioned properly. The FM antenna is the coiled wire connected to the back of the unit. Uncoil it, making sure it is fully extended (you may even want to tape it to the wall behind the unit, if possible. The higher, the better.)

For better AM reception, move or rotate the unit.

# General Controls

EN

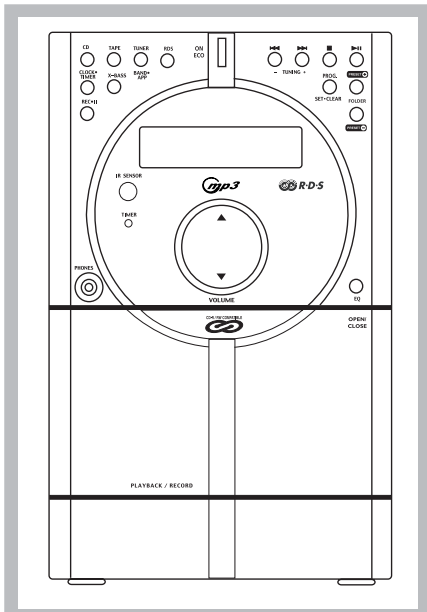

## Front View

**ON•ECO** – Turns on/off the unit. Remember to unplug the power cord from the power outlet if you are not going to use the system for some time. Press and hold to enter ECO mode. In ECO mode, the power consumption is below 3W.

**CD** – Selects CD mode.

**TAPE** – Selects tape mode.

**TUNER/BAND•APP** – Selects tuner mode; selects radio band in tuner mode; begins auto preset programming.

**RDS** - *In Tuner mode* - Shows RDS information in FM broadcast (station name (RT), station type (PTY) and clock time (CT)).

**CLOCK•TIMER** – Shows clock time and timer on/off time; enters clock and timer setting mode; enable or disable timer mode.

**X-BASS** – Enables / disables X-Bass

**REC•II** – Starts/pauses recording from CD / Tuner mode.

**TUNING - / + (SKIP BACKWARD ◀◀ / SKIP FORWARD ▶▶)** – *In CD mode* - skips backward or forward to the other tracks.

*In Tape mode* - Rewinds or fast forwards tape.

*In tuner mode* - searches down or up radio frequency.

**STOP (■)** – *In CD mode* - Stops CD playback.

*In Tape mode* – Stops tape playback.

**PLAY/PAUSE (▶||)** – *In CD mode* – Plays and pauses CD playback.

*In Tape mode* – Plays and pauses tape playback.

**PROG•SET•CLEAR** – Enters program setting mode; confirms your settings; clears settings.

**PRESET / FOLDER - / +** – *In tuner mode* – selects preset station.

*In mp3 CD mode* - Selects the previous and next folder.

**EQ** – Selects among different sound effects (flat / classic / rock / pop / jazz).

**VOLUME** – Adjusts the sound level.

**PHONES** 🎧 – Jack for connecting headphones.

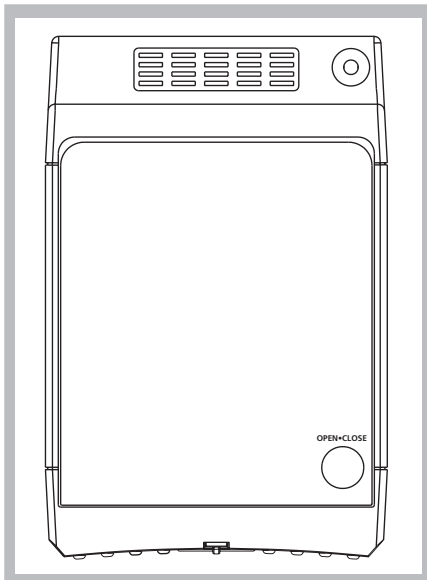

## Top View

**OPEN•CLOSE** – Press to open the CD compartment door.

# General Controls

## Remote Control

EN

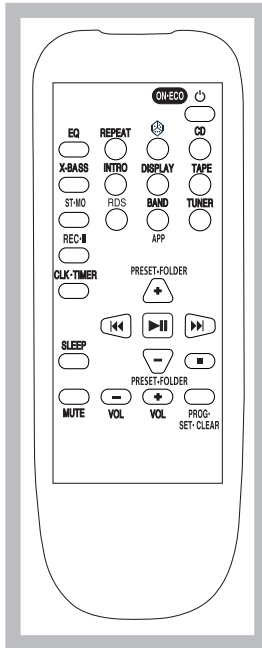

**ON•ECO** - Turns the unit on/off

**EQ** - Selects among different sound effects (flat / classic / rock / pop / jazz)

**REPEAT** - *In CD mode* - toggles repeat options (repeat disc / repeat track / repeat off).

**MIX** - Selects random playback in CD mode.

**CD** - Selects CD player.

**X-BASS** - Enable and disables X-Bass.

**INTRO** - Selects Intro play in CD mode.

**DISPLAY** - *In normal audio CD mode* - toggles among displaying track elapse time, track remain time and disc remain time.

*In mp3 CD mode* - toggles among displaying FILE name, FOLDER name, TITLE, ARTIST, ALBUM, GENRE, YEAR and BIT RATE.

*In FM Tuner mode* - toggles RDS station information (Frequency, RDS name, Radio text, RDS type, Clock time, RDS day and PI code)

**TAPE** - Selects tape player.

**ST•MO** - Toggles stereo and mono mode in FM tuner.

**RDS** - *In Tuner FM mode* - Enters to select RDS PTY; radio text (INFO ON/OFF); RDS Clock/day (SYNC ON/OFF).

**BAND/APP** - Selects radio bands; starts auto preset programming.

**TUNER** - Selects radio tuner.

**REC•II** - Starts recording or pause recording.

**CLK•TIMER** - Enters clock and timer setting mode.

**SLEEP** - Selects sleep time.

**PRESET / FOLDER + / -** - *In tuner mode* - Selects next / previous preset stations. *In mp3 CD mode* - Selects the next and previous folder.

**SKIP BACKWARD** / **SKIP FORWARD** - *In Tuner mode* - Searches down or up radio frequency.

*In CD mode* - Skips to the previous or next track.

**▶ || PLAY/PAUSE** - *In CD mode* - Plays disc and pauses CD playback.

*In Tape mode* - Plays tape and pauses tape playback.

**■ STOP** - Stops CD and tape playback.

**MUTE** - Mutes Volume.

**VOL + / -** - Turns up or down volume level.

**PROG•SET•CLEAR** - Enters program setting mode; confirms your settings; clears preset station in tuner programming mode; clears CD program in CD programming mode and resets tape counter in tape mode.

## Installing Batteries

The remote control must be inserted with 2 "AA" or "UM-3" or "R6" batteries prior use. Follow the steps below to ensure correct installation.

1. Remove the battery compartment door (located at the back of the remote control) by sliding the compartment door in the direction of the arrow and then lifting the door out and off the cabinet.
2. Before inserting the batteries, observe the polarities (that is, + and -) of the battery, then relate the polarities to the engraved diagram inside the battery compartment. Now insert the batteries.
3. After installation of the batteries, replace and fit the lid to cover the batteries. Lightly push it close with a snap.

4

# Settings

EN

## Display

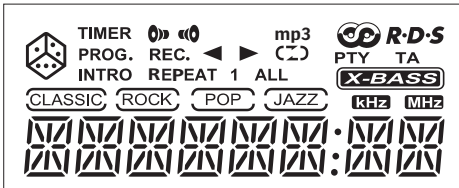

9. Press **PROG•SET•CLEAR** to move to timer off time setting. "OFF -- --:00" is displayed.
10. Repeat steps 3-5 to set timer off hour and minute.
11. Press **PROG•SET•CLEAR** to confirm settings.

Timer will be activated automatically after settings are finished.

## Setting the Clock

1. Press **CLOCK•TIMER** to enter clock setting mode. "CLK -- --:00" is displayed.
2. Press **TUNING** - or + to set the hour.
3. Press **PROG•SET•CLEAR** to shift to the minute digits.
4. Press **TUNING** - or + to set the minute.
5. Press **PROG•SET•CLEAR** to confirm the setting.

## Activating the Timer

Press and hold **CLOCK•TIMER** for 2 seconds on the main unit to activate and deactivate the timer function.



### Note:

Timer can not be set or activated if clock time is not set. *SET CLK* will flash on the display when you try to activate the timer. Follow instructions under "Setting the Clock" to set clock.

If timer settings have not been entered, *SET TMR* will flash on the display when you try to activate the timer. Follow instructions under "Setting the Timer" to enter timer settings.

If timer off time is set as the same as timer on time, *TIMER NG* will flash on the display. Set the correct timer off time again.



# Settings

## Setting Sleep Time

You can select the time interval in minutes before the unit turns off automatically.

Press **SLEEP** on the remote control to toggle among OFF, 90, 80, 70, 60, 50, 40, 30, 20, and 10 minutes.

## View Remaining Sleep Time

When sleep is activated, press **SLEEP** once to view remaining sleep time in minutes.

## Adjust Sleep Time

Press **SLEEP** again when the remaining sleep time is displayed to change sleep time.

EN



### Note:

Sleep is automatically de-activated when the unit is turned off.

# Sound Features

## Preset Equalizer Curves

Press **EQ** to toggle among FLAT, CLASSIC, ROCK, POP and JAZZ.

The selection is highlighted.

**CLASSIC** ROCK POP JAZZ

## Muting Audio

Press **MUTE** to silence playback.

## X-Bass

Press **X-BASS** to turn on/off the x-bass feature.

The **X-BASS** icon is displayed.



# CD Player

EN



This unit is compatible with audio CD-R/RW discs.



## Notes on CD-R/RW

- Do not affix any type of labels to either side (recordable or labeled side) of a CD-R/RW disc as this may result in the unit malfunctioning.
- To avoid damages to the CD-R/RW disc, do not open the disc compartment door while the disc is being read.
- Do not load an unrecorded CD-R/RW disc into the unit. This may take a longer time to read the disc.
- **Playback capability for CD-RW discs may vary due to variations in the quality of the CD-RW disc and the recorder used to create the disc.**



## Note:

Be sure to remove all discs from the disc compartment before moving or transporting the unit!



## Notes on mp3 Disc:

- Use .mp3 as the extension when converting audio files into mp3 for saving onto CD-R(W) or CD-ROM, e.g. Abc08.mp3. Do not use any other extension e.g. .doc, .pdf.
- Do not use the .mp3 extension for other text or non-audio data files as this may result in serious malfunction and harmful noise interference.
- For better quality in mp3 disc playback, the CD quality should be recorded 128kbps or above.
- Disc data size > 650MB is not recommended.
- Total files should not exceed 412 and the total folders should not exceed 100. It also depends on the length of the file/folder names.
- For mixed mode discs, only one mode will be selected for playback depending on the recording format.
- To ensure good performance, wait until the disc changer completely reads the disc before proceeding.
- mp3 files in CD ROM EXTRA format disc cannot be recognized.



## Note:

mp3 file names are limited to 32 characters.  
Folder names are limited to 16 characters.

# CD Player

## Loading a Disc

1. Press **CD** to select CD mode.
2. Press down on the **OPEN/CLOSE** area on the top of the unit to open the CD compartment door.
3. Insert up a disc with the label facing up.
4. Close the CD compartment door.

If the disc is a mp3 CD, the mp3 icon lights on the display. mp3 discs may take a longer time to read. Wait while the unit reads and counts the total number of songs on the disc.



### Tips:

If the CD compartment is not loaded with a CD or the CD is unreadable, the message "NO DISC" will be shown.

## Track Information

EN

- For normal audio CDs, press **DISPLAY** on the remote control repeatedly during playback to display track remain time, disc remain time and track elapsed time.
- For mp3 discs, press **DISPLAY** on the remote control during playback repeatedly to display the following song information.
  - FILE name
  - FOLDER name
  - TITLE
  - ARTIST
  - ALBUM
  - GENRE
  - YEAR
  - BIT RATE

The selected song information type shows briefly on the display (e.g. FILE), then the detailed information scrolls along the display.

FILE<0123>FILENAME.mp3  
"0123" indicates the file number of the current track on the disc.



### Note:

The display continues to show the selected display mode until another selection is activated.

## Playback

- Press **PLAY/PAUSE** ►|| to begin or pause playback.
  - Press **STOP** ■ to stop play.
- See Troubleshooting Tips for mp3 playback sequence details.

## Skipping Tracks

Press **SKIP BACKWARD** ◀◀ or **SKIP FORWARD** ▶▶ to skip to the previous or next track on the disc.

## Searching Through a CD

Press and hold **SKIP BACKWARD** ◀◀ or **SKIP FORWARD** ▶▶ to search through a CD while it is playing.

## Selecting Folders (mp3 CDs Only)

- Press **PRESET / FOLDER** - to go to the previous non-empty folder.
- Press **PRESET / FOLDER** + to go to the next non-empty folder.

# CD Player



EN

## Random Playback

Press  to turn on/off the playing of tracks in random order. (Remote Only)

## Sampling Tracks

Intro Play lets you enjoy the CD tracks for 10 seconds. When the last track has played for 10 seconds, the Intro Play stops.

1. Load a CD into the disc compartment.
2. Press **INTRO** on the remote control and the **INTRO** icon will be shown.
3. Press **PLAY/PAUSE**  to start playback from the first track. Press **SKIP BACKWARD**  or **SKIP FORWARD**  to select a particular track.
4. Press **INTRO** again to exit intro play.

## Repeat



- Press **REPEAT** on the remote control once to repeat all tracks. **REPEAT ALL** is shown in the display simultaneously.
- Press again to play a particular track repeatedly, at the same time, **REPEAT 1** is displayed.
- Press a third time to de-select the function.

## Setting Up a CD Program



### Tips:



A maximum of 20 tracks can be stored into memory.

1. Select CD mode by pressing **CD**.
2. In stop mode, press **PROG•SET•CLEAR** after the CD has been loaded into the system. The message "0 Pr 01" will be shown on the display.
3. Press **SKIP BACKWARD**  or **SKIP FORWARD**  to select a track to be stored into memory location 1.
4. Press **PROG•SET•CLEAR** to confirm your selection and store that track into memory. The next available memory locations shows on the display. Repeat step 3 and this step to store additional tracks.  
In CD program mode, the PROG. icon lights on the display.

## Playing a Program List

While in PROGRAM mode, press **PLAY/PAUSE** . When the unit is playing the program, "PROG" icon will be displayed.

## View and Edit Program List

1. Press **PROG•SET•CLEAR** repeatedly to view program list.  
To edit program location, press **PROG•SET•CLEAR** until the location you want to edit is displayed.
2. Press **SKIP BACKWARD**  or **SKIP FORWARD**  to select the new track to be stored.
3. Press **PROG•SET•CLEAR** to confirm.

## Deleting Program List

Press and hold **PROG•SET•CLEAR** for 2 seconds to clear program list. The program list will also be cleared once the CD compartment door is opened. The system displays the message CLEAR briefly.



# Radio

## Selecting Tuner Band

- Press **TUNER/BAND•APP** on the main unit or **TUNER** on the remote control to select radio mode.
- Select a radio band by pressing **TUNER/BAND•APP** on the main unit or **BAND/APP** on the remote control:
  - FM – Frequency Modulation (87.5 – 108 MHz)
  - MW – Medium Wave (522 – 1611 KHz)
  - LW – Long Wave (150 – 283 KHz)

## Searching for a Station

- Press **TUNING -** or **+** on the main unit or **SKIP BACKWARD** ◀◀ or **SKIP FORWARD** ▶▶ on the remote control to search for a radio station.
- To search automatically, press and hold **TUNING -** or **+** on the main unit or **SKIP BACKWARD** ◀◀ or **SKIP FORWARD** ▶▶ on the remote control for 1 second.

## Presetting a Station



### Tips:

A maximum of 30 stations can be stored.

1. Press **TUNER/BAND•APP** on the main unit or **BAND•APP** on the remote control to select band.
2. Press **TUNING -** or **+** on the main unit or **SKIP BACKWARD** ◀◀ or **SKIP FORWARD** ▶▶ on the remote control to select station to be stored.

3. Press **PROG•SET•CLEAR** to enter program mode.
4. Press **PRESET -** or **+** to select memory location (up to 30 memory locations). When you are selecting the preset location, the preset station number is flashing.
5. Press **PROG•SET•CLEAR** to confirm the setting.

EN

## Auto Preset Programming

Press and hold **TUNER/BAND•APP** on the main unit or **BAND/APP** on the remote control to scan stations in selected band. A maximum of 30 stations can be stored. Beware of your preset channels being erased accidentally because the scanning and storing process is automatic upon pressing the button. Press any button to stop scanning.

## Listening to the Preset Station

1. Press **TUNER/BAND•APP**.
2. Press **PRESET + / -** repeatedly to locate your desired memory location.

## Suppressing Stereo Signal

Press **ST•MO** on the remote control to toggle between FM mono and stereo for FM broadcast. If FM stereo reception is weak, select mono sound to reduce noise.

# Radio

EN

## Tuning to a RDS Station (FM only)

1. Press **TUNING** - or + on the main unit or **SKIP BACKWARD** ◀◀ or **SKIP FORWARD** ▶▶ on the remote control to select desired frequency or press **PRESET** + / - to access preset stations.
2. If RDS station is found, *RDS* lights on the display with station name shown.

## Displaying RDS station Information

Press **DISPLAY** on the remote control repeatedly to display station information:

### 1. Frequency

### 2. RDS name

### 3. Radio text (RT) "INFO OFF"

Press **RDS** repeatedly to select "INFO OFF".

Press **PRESET** - or + to toggle "INFO OFF" and "INFO ON".

### 4. RDS type (PTY)

- RDS NEWS (news),
- AFFAIRS (current affairs),
- INFO (weather, medical),
- SPORT (sports),
- EDUCATE (education),
- DRAMA (series and plays),
- CULTURE (religion),
- SCIENCE (science and technology),
- VARIOUS (miscellaneous),
- POP M (pop music),
- ROCK M (rock music),
- MOR M (middle-of-the road music),
- LIGHT M (light music),
- CLASSICS (classical music),
- OTHER M (unclassified music),

- WEATHER (weather),
- FINANCE (financial information),
- CHILDREN (children's program),
- SOCIAL (social news),
- RELIGION (religious program),
- PHONE IN (phone-in program),
- TRAVEL (travel & leisure),
- HOBBY (hobby),
- JAZZ (Jazz music),
- COUNTRY (country music),
- NATIONAL (national),
- OLDIES (oldies),
- FOLK M (folk music),
- DOCUMENT (documentary),
- TEST (test)
- ALARM (alarm)

### PTY Search

1. Press **RDS** repeatedly to select "FIND".
2. Press **PRESET** - or + to toggle the desired RDS station type.
3. Press **TUNING** + or - on the main unit or **SKIP BACKWARD** ◀◀ or **SKIP FORWARD** ▶▶ on the remote control to begin searching for RDS stations in the selected category.

### 5. clock time (CT) - "SYNC OFF"

Press **RDS** repeatedly to select "SYNC OFF".

Press **TUNING** + or - on the main unit or **SKIP BACKWARD** ◀◀ or **SKIP FORWARD** ▶▶ on the remote control to toggle "SYNC OFF" and "SYNC ON".

### 6. RDS DAY

### 7. PI CODE

# Tape Player

## Playing Cassette Tape

1. Press **TAPE** to select tape mode.
2. Press on the **OPEN/CLOSE** area to open the deck door.
3. Load a cassette tape into the deck. Then, lightly press the deck door closed.
  - Press **PLAY/PAUSE** **▶||** to start tape play.
  - Press **SKIP BACKWARD** **◀◀** or **SKIP FORWARD** **▶▶** to position the tape at the desired position.
  - Press **STOP** **■** to stop.

## Recording a Radio Program

1. Press **TUNER/BAND•APP** on the main unit or **BAND•APP** on the remote control to select tuner mode and desired band.
2. Tune to the station you want to record by pressing **TUNING -** or **+** on the main unit or **SKIP BACKWARD** **◀◀** or **SKIP FORWARD** **▶▶** on the remote control.
3. Press **REC•II** on the main unit. The REC. icon will flash on the display. Press **REC•II** again to start recording.
4. Press **STOP** **■** to stop recording. Press **REC•II** again to pause recording. To resume recording, press again.

## Recording a CD

1. Press **CD** to select CD mode.
2. Press **SKIP BACKWARD** **◀◀** or **SKIP FORWARD** **▶▶** to select the track that you want to record.
3. Press **REC•II** to record. The REC. icon will flash on the display. Press **REC•II** again to start recording. CD automatically starts playback at the same time.
4. Press **STOP** **■** to stop recording.

## Reset Tape Counter

Press **PROG•SET•CLEAR** to reset counter.

EN



# Troubleshooting Tips

EN	Problem	Solution	Problem	Solution
	<i>System will not turn on</i>	<ul style="list-style-type: none"> <li>• Check power cord for a secure connection.</li> <li>• Unplug the unit for a moment, and then plug into power source again.</li> <li>• Check the outlet by plugging in another device.</li> </ul>	<i>CD sound skips</i>	<ul style="list-style-type: none"> <li>• Clean the disc.</li> <li>• Check disc for warping, scratches, or other damage.</li> <li>• Check if something is causing the system to vibrate. If so, move the system.</li> <li>• Make sure the speakers are at least 3 feet away or on a different surface from the main unit.</li> </ul>
	<i>No sound</i>	<ul style="list-style-type: none"> <li>• Increase the volume setting.</li> <li>• Check connection to speakers.</li> <li>• Check that you have selected the appropriate function: CD, TAPE, Tuner.</li> <li>• Make sure mute is off.</li> <li>• Make sure headphones are not plugged in.</li> </ul>	<i>CD button will not respond</i>	<ul style="list-style-type: none"> <li>• Switch to another function (TAPE, Tuner) and then back to CD.</li> </ul>
	<i>Poor radio reception</i>	<ul style="list-style-type: none"> <li>• Check antenna connection.</li> <li>• Move antenna.</li> <li>• Turn off nearby electrical appliances, such as hair dryer, vacuum cleaner, microwave, fluorescent lights.</li> </ul>	<i>Distorted or noisy tape recordings</i>	<ul style="list-style-type: none"> <li>• Inspect the tape head, clean it if necessary.</li> </ul>
	<i>CD does not play</i>	<ul style="list-style-type: none"> <li>• Check that CD is in the tray.</li> <li>• Check that CD label is facing up.</li> <li>• Check that PAUSE mode is not on.</li> <li>• Check that CD function is selected.</li> <li>• Use CD lens cleaner.</li> <li>• Clean the disc.</li> <li>• Try another disc</li> </ul>	<i>Remote control does not work</i>	<ul style="list-style-type: none"> <li>• Check that the batteries are properly installed.</li> <li>• Replace weak batteries.</li> <li>• Check the system is plugged into power source.</li> <li>• Point the remote directly at the system's front panel.</li> <li>• Move closer to the system.</li> <li>• Remove any obstacles between the remote and the system.</li> </ul>



# Troubleshooting Tips

EN

Problem	Solution
<p><i>mp3 playback sequence is out of order</i></p>	<ul style="list-style-type: none"> <li>Refer to the diagram below for playback sequence details on multi-level folder structure.</li> <li>Songs are played before playing songs placed in folders at each level.</li> </ul>
<div style="display: flex; justify-content: space-around; text-align: center;"> <div>LEVEL 1</div> <div>LEVEL 2</div> <div>LEVEL 3</div> <div>LEVEL 4</div> </div>	
<p><b>Note:</b></p> <ul style="list-style-type: none"> <li>Folder playback sequence is indicated by the letters from A to G</li> <li>Song playback sequence is indicated by the number 1 to 15 in front of the song name.</li> </ul>	





# Maintenance

**EN**

Disconnect the audio system from the power source before performing any maintenance.

## Cleaning

Clean the exterior of the system using a soft dust cloth.

## CD Player

CAUTION! This system operates with a laser. It must be opened by only a qualified technician.

## Tape Player

To prevent deterioration of sound quality, periodically open the door of each deck and clean the magnetic heads, pinch roller, and capstan with a cotton bud dipped in alcohol. Also, demagnetize the head by playing a demagnetizing cassette (available through an audio equipment store).

To protect recordings on one or both sides of a tape, remove the corresponding tab. If you later want to record on the tape, affix a piece of adhesive tape over the hole.

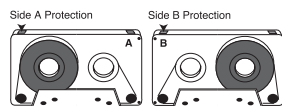

Quit Slacking - A little bit of slack in your tapes can cause scratches on the tape, or worse yet, the tape could break. If you notice some slack in the tape, use a pencil to tighten it up before you insert it.

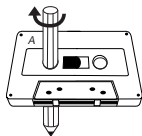

## Handling CDs

• Do not touch the signal surfaces. Hold CDs by the edges, or by one edge and the hole. Do not affix labels or adhesive tapes to the label surfaces. Do not scratch or damage the label. CDs rotate at high speeds inside the player. Do not use damaged (cracked or warped) CDs

## Cleaning CDs

- Dirty CDs can cause poor sound quality. Always keep CDs clean by wiping them gently with a soft cloth from the inner edge toward the outer perimeter.
- If a CD becomes dirty, wet a soft cloth in water, wring it out well, wipe the dirt away gently, and then remove any water drops with a dry cloth.
- Do not use record cleaning sprays or antistatic agents on CDs. Also, never clean CDs with benzene, thinner, or other volatile solvents which may cause damage to disc surface.

## CD Lens Care

When your CD lens gets dirty it can also cause the system to output poor sound quality. To clean the lens you will need to purchase a CD lens cleaner which can maintain the output sound quality of your system. For instructions on cleaning the CD lens, refer to the ones accompanying the lens cleaner.



# Important Information

## Safety Precautions

- Never open the cabinet under any circumstances. Any repairs or internal adjustments should be made only by a trained technician.
- Never operate this product with the cabinet removed.
- Do not use your System immediately after transporting it from a cold place to a warm place, as condensation may cause the system to malfunction.
- Keep your unit away from humid areas and abnormally hot places.
- Do not touch the player with wet hands. If any liquid enters the player cabinet, take the player to a trained technician for inspection.
- This compact disc player uses a laser to read the music on the disc. The laser mechanism corresponds to the cartridge and stylus of a record player. Although this product incorporates a laser pick-up lens, it is completely safe when operated according to directions.
- Discs rotate at high speed inside the player. Do not use damaged, warped, or cracked discs.
- Do not touch the pick-up lens which is located inside the disc compartment. To keep dust from collecting on the pick-up lens, do not leave the compartment door open for an extended period of time. If the lens becomes dirty, clean it with a soft brush, or use an air blower brush designed for camera lenses.
- The apparatus shall not be exposed to dripping and splashing.

## Important Battery Information

- Remove the batteries to avoid leakage if you do not use your remote control for more than one month.
- Discard leaky batteries immediately as leaking batteries may cause skin burns or other personal injuries. Dispose of batteries in the proper manner, according to provincial and local regulations.

- Any battery may leak electrolyte under the following circumstances:
  - if mixed with a different battery type,
  - if inserted incorrectly,
  - if all batteries are not replaced at the same time,
  - if disposed of in fire, or
  - if an attempt is made to charge a battery not intended to be recharged

EN

## Headset Safety

- Do not play your headset at high volume. Hearing experts warn against extended high-volume play.
- If you experience ringing in your ears, reduce volume or discontinue use.
- You should use with extreme caution or temporarily discontinue use in potentially hazardous situations.  
Even if your headset is an open-air designed to let you to hear outside sounds, do not turn up the volume so high that you are unable to hear what is around you.

## Don't Infringe

This product should only be used for the purposes for which it is sold, that is, entertainment, violating no copyright law. Any attempts to use this product for which it is not intended is unlawful and therefore not condoned by Thomson.

## Technical Specification

Power supply: 230V~50Hz  
Dimensions (H x W x D mm):  
Unit size - 237 x 145 x 231  
Speaker - 237 x 145 x 173  
Tape deck: Response curve: 125Hz-8kHz (-5dB)  
CD player: Response curve (+/- 2dB): 60Hz to 20 kHz  
Rating Plate: Look for it at the back of the set.

## Free Manuals Download Website

<http://myh66.com>

<http://usermanuals.us>

<http://www.somanuals.com>

<http://www.4manuals.cc>

<http://www.manual-lib.com>

<http://www.404manual.com>

<http://www.luxmanual.com>

<http://aubethermostatmanual.com>

Golf course search by state

<http://golfingnear.com>

Email search by domain

<http://emailbydomain.com>

Auto manuals search

<http://auto.somanuals.com>

TV manuals search

<http://tv.somanuals.com>