

EN

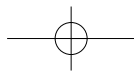

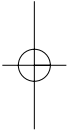

THOMSON multimedia
46/47 quai A. Le Gallo
92648 Boulogne Cedex
FRANCE
RCS nanterre
B 322 019 464
55639060
www.thomson-multimedia.com

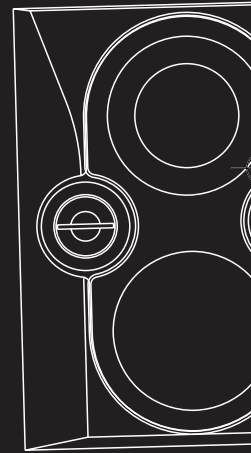
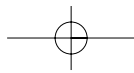

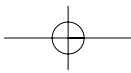

THOMSON

u
s
e
r
m
a
n
u
a
l

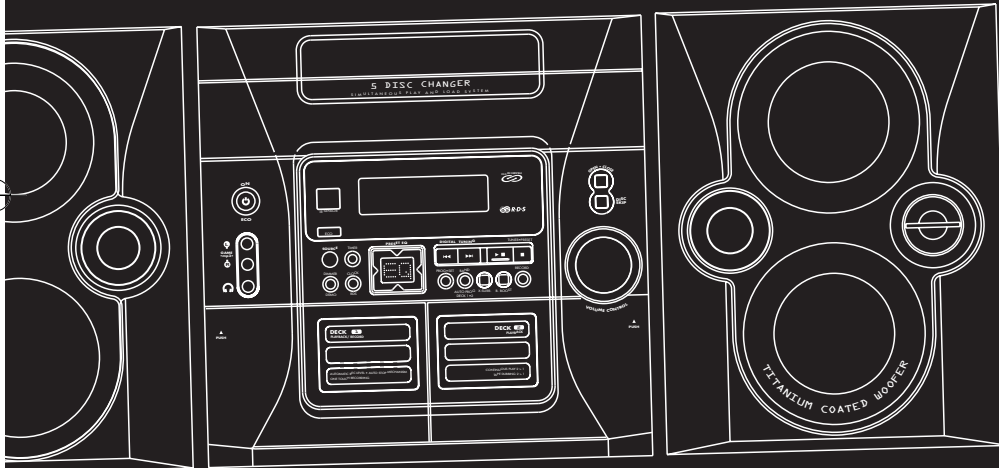

MS4000



Safety Information

EN

Thomson Information

CAUTION!

Invisible laser radiation when open. Avoid exposure to beam. Class 1 laser product. This system must be opened only by qualified technicians to prevent accidents caused by the laser beam.

LASER $\lambda = 780 \text{ nm}$, $P_{\text{max}} = 5 \text{ mW}$

Rating Information: At bottom/rear of the unit.

This unit comply with the existing requirements



In accordance with the rating plate of the unit, this unit complies with current standards concerning electrical safety and electromagnetic compatibility.



Please respect the environment Before throwing any batteries away, consult your distributor who may be able to take them back for specific recycling.



Have a Blast- Just Not in Your Eardrums
Make sure you turn down the volume on the unit before you put on headphones. Increase the volume to the desired level only after headphone are in place.

ADVARSEL!
USYNLIG LASERSTRÅLNING VED ÅBNING NÅR SIKKERHEDSÅFBRYDERE ER UDE AF FUNKTION. UNGDÅ UDSÆTTELSE FOR STRÅLNING.
VORSICHT!
UNSIHTBARE LASERSTRALUNG WENN ABDECKUNG GEÖFFNET UND SICHERHEITS-VERRIEGELUNG ÜBERBRÜCKT. NICHT DEM LASERSTRAHL AUSSETZEN!

CAUTION - INVISIBLE LASER RADIATION WHEN OPEN AND INTERLOCKS FAILED OR DEFEATED. AVOID EXPOSURE TO BEAM.

ATTENTION - RAYONNEMENT LASER INVISIBLE DANGEREUX EN CAS D'OUVERTURE ET LORSQUE LA SECURITE EST NEUTRALISEE. EXPOSITION DANGEREUSE AU FAISCEAU.



CLASS 1 LASER PRODUCT
LASER KLASSE 1
APPAREIL A LASER DE CLASSE 1
LUOKAN 1 LASERLAITE
KLASS 1 LASERAPPARAT

VARNING-
OSYNLIG LASERSTRÅLNING NÅR DENNA DEL ÄR ÖPPNAD OCH SPÄRRAN ÄR URKOPPLADE. BETRAKTA EJ STRÅLEN.
VARO!
A/ÄTTÄESSA JA SOUJALUKITUSOHITETTAESSA OLET ALTIINA NÄKYMÄTTÖMÄLLE. LASERSÄTEILYLLE ÄLÄ KATSO SÄTEESEEN.

For UK Only

CONNECT THE MAIN LEAD INTO A MAINS POWER SOCKET

POWER SUPPLY **230V**. It must not be connected to D.C. mains.

Note; The mains lead of the set is fitted with a molded plug. If the mains socket are not compatible or if for any reason the plug is removed please follow the directions below. The molded plug cannot be rewired and if removed must be disposed of safely.

DO NOT under any circumstances plug the severed plug into any mains socket as this could result in electric shock.

Important: If the plug is removed, rewire the new plug as follow:

The wires in the mains plug are colored in accordance to the following code:

BLUE = NEUTRAL/BROWN = LIVE

If the colors of the wires in the mains lead of this apparatus may not correspond with the colored markings identifying the terminals in your plug, proceed as follows:

BLUE wire to the terminal coded N (Neutral) or colored black.

BROWN wire to the terminal coded L (Live) or colored red.

DO NOT make any connection to the terminal in the plug which is marked by the letter E or by the earth symbol or colored green or green and yellow.

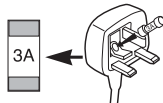



A fused plug must be fitted with a 3A fuse approved by ASTA or BS1362 and fuse covers must be always be securely replaced. If you set does not work, the fuse may be blown.



Safety Information

EN

	<p>CAUTION RISK OF ELECTRIC SHOCK DO NOT OPEN</p>	
<p>THE LIGHTNING FLASH AND ARROW-HEAD WITHIN THE TRIANGLE IS A WARNING SIGN ALERTING YOU OF "DANGEROUS VOLTAGE" INSIDE THE PRODUCT.</p>	<p>CAUTION: TO REDUCE THE RISK OF ELECTRIC SHOCK, DO NOT REMOVE COVER (OR BACK). NO USER-SERVICEABLE PARTS INSIDE. REFER SERVICING TO QUALIFIED SERVICE PERSONNEL.</p>	<p>THE EXCLAMATION POINT WITHIN THE TRIANGLE IS A WARNING SIGN ALERTING YOU OF IMPORTANT INSTRUCTIONS ACCOMPANYING THE PRODUCT.</p>
<p>SEE MARKING ON BOTTOM / BACK OF PRODUCT</p>		

WARNING: TO PREVENT FIRE OR ELECTRICAL SHOCK HAZARD, DO NOT EXPOSE THIS PRODUCT TO RAIN OR MOISTURE.

Contents

Safety Information

Getting Started

- Unpacking the System 2
- Back View 2
- Installation 2

Controls & Indicators

- Main Unit 3
- Remote Control 4

Display Settings

- Showing the Demonstration 5
- Display Alarm/Clock 5
 - Setting the Clock 5
 - Setting the Timer 5
 - Activating the Timer 5
- Adjusting the Display
 - Brightness 5
 - Sleep Mode 5

Sound Features

- Using Preset Equalizer Curves 6
- Creating a Custom Curve 6
- Bass Boost 6
- Muting Audio 6
- X-Surround 6

CD Player

- Notes on CD-R/CD-RW Disc 6
- Loading Discs 6
- Playing Discs 6
 - Skipping a Disk 7
 - Searching through a CD 7
 - Mixing the Play Order 7
 - Sampling Tracks 7
 - Repeat 7
- Setting Up a CD program 7
- Playing a Program List 7
- Displaying the Program list 7
- Deleting a Program List 7

Tuner

- Selecting Tuner 8
- Tuning to a Station 8
- Using Presets 8
 - Auto Preset Program (for FM only) 8
 - Setting Presets 8
- Suppressing Stereo Signal 8
- Tuning to an RDS Station 8
 - Displaying RDS Station Information 8
- Searching by Program Type (PTY) 8

Tape Player

- Playing a Tape 9
- Continuous Play 9
- Recording 9
 - From Tuner 9
 - From CD 9
 - Tape to Tape 9
 - From an Auxiliary Input 9

Troubleshooting Tips

- 10

Maintenance

- Cleaning 10
- CD Player 10
- Tape Player 10
- Handling CDs 10
- Cleaning CDs 10
- CD Lens Care 10

More Information . . . 11

- Safety Precautions 11
- Important Battery Information 11
- Headset Safety 11
- Don't Infringe 11
- Technical Specification 11

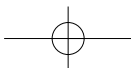

Getting Started

EN

Unpacking the system:

You should have the following:

- one main unit (with 2 main speakers);
- one remote control;
- one AM loop antenna;
- one FM antenna wire
- one user's guide;
- One Thomson Warranty Card

Back View

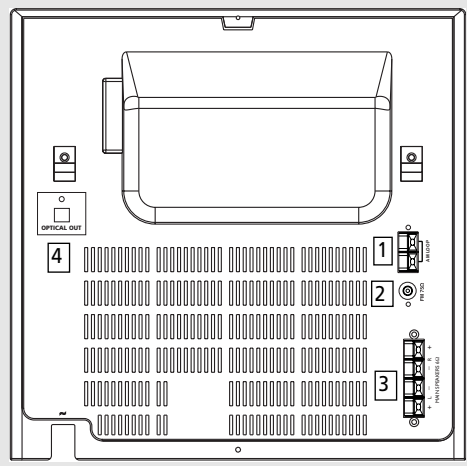

1. AM Loop Antenna Jacks
2. FM Antenna Connector
3. Main Speaker Jacks
4. Optical Out Connector

Using the FM and AM Antennas

Before you use your audio system, you'll want to make sure both the FM and AM antennas are positioned properly. Connect the FM antenna to the FM connector on the back of the unit. Uncoil it, making sure it is fully extended. (you may even want to tape it to the wall behind the unit if possible. The higher the better.)

You'll also need to connect the AM antenna loop to the back of the unit if you listen to AM stations. Rotate the AM loop antenna for better reception.

Connecting the Speakers

Match the red wire (on the left speaker) to red terminal for the left speaker (L) on the back of the unit and the black wire (on the left speaker) to the black terminal for left speaker (L). Follow the same procedure to connect the right (R) speaker.

Antenna and Speaker Wire Connection

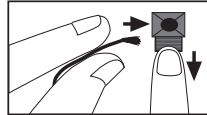

Push terminal tab down to insert wire.



Release tab to lock wire in the terminal.

NOTE: Make sure the insulation is completely removed from the ends of the Antenna and speaker wires at all connection points.

Installation

To ensure sufficient ventilation, keep the spacings shown below free from other surfaces:

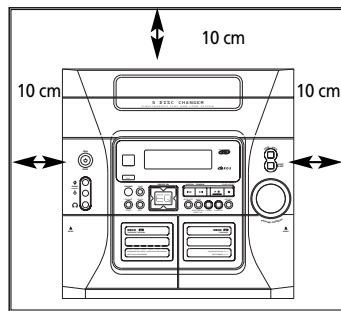

Front View

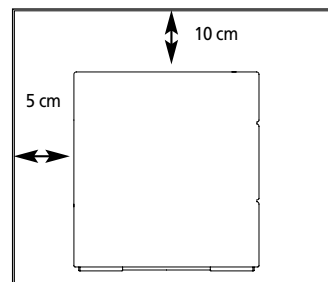

Side View

Controls and Indicators

EN

Main Unit



ON/ECO — keep pressing briefly to enter ECO (power saving, without clock display) mode.

Tip: In **STANDBY** mode (press **ON/ECO** off), the system displays the time. Press **ON/ECO** to turn the system on in the previously used mode. Press **CD**, **TAPE**, **TUNER**, or **AUX** (Remote only) to select the corresponding mode. Look at the display icons to identify the current mode.

GAME • MP3 • L / R - Jack for auxiliary connection.

PHONES — Jack for connecting headphones.

OPEN•CLOSE — Opens or closes the disc tray.

SOURCE— Selects the CD player/ tuner/ tape player/ external source.

DIMMER / DEMO — Turns the feature demonstration on or off; adjusts display contrast.

TIMER — Enters timer setting mode; turns timer on/off.

CLOCK/RDS — Shows clock time and enters clock setting mode; shows RDS information in Tuner Mode (FM).

PRESET EQ — selects among the different EQ modes.

DIGITAL TUNING ◀◀ (SKIP BACKWARD) — Decrements radio frequency, preset down, goes to the previous CD track or setting option; rewind tape or preset down.

DIGITAL TUNING ▶▶ (SKIP FORWARD) — Increments radio frequency, preset up, goes to the next CD track or setting option; fast forward tape or preset up.

▶◻◻ PLAY / PAUSE — Plays or pauses CD and tape operation.

TUNE•PRESET ■ — Stops CD track and tape operations, Sets tune or preset mode.

PROG•SET - Enters program mode for CD and Tuner; Applies new settings for Clock and Timer modes.

BAND /AUTO PROG./DECK 1•2 — Changes among tuner bands; enters auto-preset program in FM mode; switches between

deck 1 and 2 on cassette player.

X-SURR. — Turns X-Surround on or off.

B. BOOST— Turns bass boost on or off.

RECORD - Starts tape recording.

DISC SKIP — Skips to the next CD in the tray.

VOLUME UP/DOWN — Increases/ decreases volume.

Controls and Indicators

EN

Remote Control

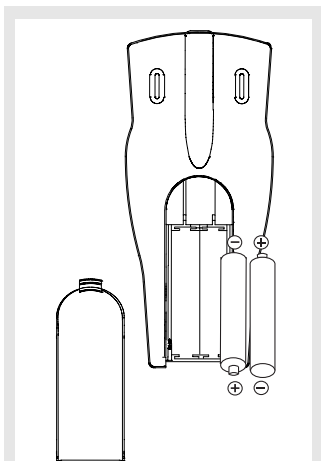
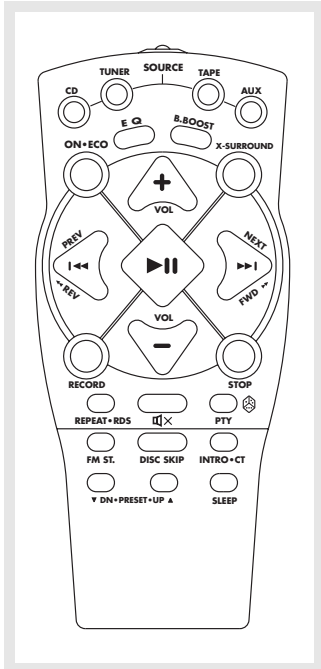

Battery Size:
"AAA" or "UM-4" or "R03"

ON+ECO — keep pressing briefly **STANDBY** mode to enter ECO (power saving, without clock display) mode.

CD — Selects CD player.

TUNER — Selects radio tuner.

TAPE — Selects tape player.

AUX — Selects external input.

EQ — Selects equalizer presets.

B.BOOST — Turns on or off Bass Boost.

X-SURROUND — Activates SURROUND.

VOL+ or VOL- — Increases/ decreases volume.

▶|| PLAY/PAUSE — Plays and Pauses the CD or tape.

NEXT ▶▶ / FWD ▶▶ — In CD mode - Increments CD track and setting options; searches forward through CD;

In Tuner mode - tunes up radio frequency;

In Tape mode - fast forwards tape.

PREV ◀◀ / REV ◀◀ — In CD mode - Decrements CD track and setting options; searches backward through CD;

In Tuner mode - tunes down radio frequency;

In Tape mode - rewinds tape.

RECORD — Starts tape recording.

STOP — Stops CD and tape playback.

REPEAT+RDS — Repeats a track, CD, or all CDs. When the radio is active, displays **RDS** information.

MUTE — Mutes volume.

PTY — Turns on/off random listening, selects search by program type in tune mode.

FM ST. — Toggles between FM stereo and mono.

DISC SKIP — Skips to next CD.

INTRO+CT — Turns INTRO mode on or off to play the first 10 seconds of each track, shows RDS time.

PRESET UP/DOWN — Selects next/ previous preset station.

SLEEP — Press to select the time interval in minutes before the unit turns off.

Installing Batteries

The remote control must be inserted with 2 "AAA" or "R3" or "UM 4" batteries prior to use. Follow the steps below to ensure correct installation.

1. Open the battery compartment door (located at the back of the remote control) by sliding the cover out.
2. Before inserting the batteries, observe the polarities (that is, + and -) of the battery then relate the polarities to the engraved diagram inside the battery compartment. Now insert the batteries.
3. After installation of the batteries, place the lid to cover the batteries. Lightly push it closed with a snap.

Display Settings

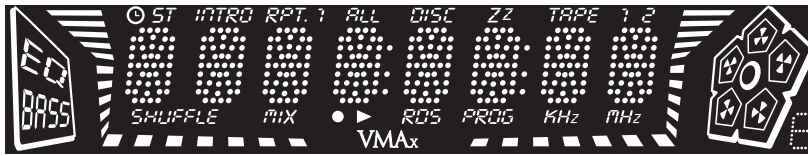

EN

Showing the Demonstration

Magic demonstration is available in all modes except for when timer is on or sleep mode is activated. Press **DIMMER/DEMO** to turn on/off magic demonstration mode. The demonstration scrolls through all display operations.

Display Clock / Alarm

Setting the Clock

1. Press and hold **CLOCK/RDS** until the hour flashes on the display.
2. Press **DIGITAL TUNING** ◀ or ▶ to set the hour and then press **CLOCK/RDS** to shift to minute digits.
3. Press **DIGITAL TUNING** ◀ or ▶ to set the minute.
4. Press **PROG•SET** to save settings and **STOP** ■ to quit setting.

Note:

- When system is ON, you can press **CLOCK/RDS** to display the current time for about 2 seconds.
- Clock cannot be set in FM Mode.

Setting the Timer

1. Press and hold **TIMER** until the **ON** and clock time flash on the display (**ON** - timer on time).
2. For setting time, press **DIGITAL TUNING** ◀ or ▶ to set the hour and then press **TIMER** to shift to minute digits.
3. Press **DIGITAL TUNING** ◀ or ▶ to set the minute.
4. Press **TIMER** to change to **OF** (timer off time) with clock time flashing. Repeat steps 2 & 3 for timer off time setting.

5. Press **TIMER** to select source. Press **DIGITAL TUNING** ◀ or ▶ to select between CD /TUNER/ TAPE/REC TU.
6. Press **TIMER** to set volume. Adjust volume with the **VOLUME CONTROL** to set desired volume level.
7. Press **PROG•SET** to save settings or **STOP** ■ to quit setting.

Activating the Timer

Press and release **TIMER** to turn on/off the alarm. The alarm is active when the clock icon indicator ⌚ is lit.

Adjusting the Display Brightness

1. Press and hold **DIMMER/DEMO** for more than 2 seconds.
2. While the dimmer is displayed, press and release **DIMMER/DEMO** to select the desired level (DIMM 1 - 3).

Note:

- The dimmer level can only be adjust for when the unit is in ON mode.
- In standby mode, the dimmer level remains at DIMM 3 and in magic demo mode, the dimmer level is at DIMM 1.

Sleep Mode

You can select the time interval in minutes before the unit turn off automatically. Press **SLEEP** on the remote to select among OFF, 120, 90, 60, 45, 30, 15 and 5 minutes. (Remote only)

Sound Features

EN

Using Preset Equalizer Curves

Press **PRESET EQ** on the main unit or **EQ** on the remote to toggle among FLAT, ROCK, POP, JAZZ, CLASS and CUSTOM. The display shows the selection briefly.

Creating a Custom Curve

1. Press **PRESET EQ** to select **CUSTOM** mode.
2. While "**CUSTOM**" is displayed, press **DIGITAL TUNING** ◀◀ / ▶▶ to cycle among displayed bass- and treble - range levels.
3. While **BAS** or **TRE** is displayed, press **VOLUME UP / DOWN** to set the associated gain between -10 - +10.



BASS BOOST

Press **B. BOOST** to turn on/off boosting the bass frequency.

Muting Audio

Press **MUTE**  on the remote to cut the sound. (Remote Only)



X- Surround

Press **X-SURROUND** to enjoy enriched sound quality. This feature gives you:

1. Better width and depth for vocal and instrumental sound.
2. More powerful presence for studio recording.
3. Enhanced surround effects with greater flexibility in positioning speakers.

CD PLAYER



CD-R / RW



This unit is compatible with CD-RW/ CD-R discs for playback.

Notes on CD-R/RW Disc:



- Do not affix any type of labels to either side (recordable or labeled side) of a CD-R/RW disc as this may result in the unit malfunctioning.
- To avoid damages to the CD-R/RW disc, do not open the disc compartment door while the disc is being read.
- Do not load an unrecorded CD-R/RW disc into the unit. This may take a longer time to read the disc.
- **Playback capability for CD-RW discs may vary due to variations in the quality of the CD-RW disc and the recorder used to create the disc.**

Note: Be sure to remove all discs from the disc compartment before moving or transporting the unit!



Loading Discs

1. Press **SOURCE** repeatedly to select **CD** mode.
2. Press **OPEN•CLOSE**  to open the drawer.
3. Insert up to five discs with label face up. (Press **DISC SKIP** to rotate the disc carrier.)
4. Press **OPEN•CLOSE**  to close the drawer. Loaded disc position icon lights.

Playing Discs

- Press **PLAY/PAUSE**  to begin or pause play, and **STOP**  to stop play.
- Press **SKIP BACKWARD** ◀◀ / **SKIP FORWARD** ▶▶ to select a specific track.

Play and load simultaneously by:

1. Press **OPEN•CLOSE**  to open the tray while a CD is playing
2. Load/change discs for available trays by pressing **DISC SKIP**.
3. Press **OPEN•CLOSE**  to close the tray.



CD Player

EN

Skipping a Disk

Press **DISC SKIP**.

Searching Through a CD

Press and hold **SKIP BACKWARD**  / **SKIP FORWARD**  to search through a CD while it is playing.

Tip: While playing a CD, press and hold **SKIP-FORWARD** or **BACKWARD** for more than 2 seconds to search through the CD.

Mixing the Play Order

Press  / **PTY** to turn on/off the playing of tracks in random order. (Remote Only)

Sampling Tracks

Press **INTRO** to play the first 10 seconds of each track on the current disc, all discs in the tray, or turn **INTRO** mode off. (Remote Only)

Repeat

Press **REPEAT** to repeat the current track, current disc, all discs, or turn **REPEAT** mode off. (Remote Only)



Note: You may also press **REPEAT** to select 1 disc or all discs before activating **INTRO & MIX** functions

Setting Up a CD Program

You can program the CD player to play up to any 32 tracks on the CDs in the tray.

1. While the CD player is stopped, press **PROG•SET** to enter program mode.

The system displays the next available program number: "-- P:01," with "--" flashing, prompts you for the first track in the program list.

2. Press **SKIP BACKWARD**  / **SKIP FORWARD**  to select a track (press **DISC SKIP** to select a track from a different disc).

5 P:01

3. Immediately press **PROG•SET** to assign the selected track to the program number. After 3 seconds, you are prompted for the next track in the program list. (In CD program mode, **PROG** icon will be lit.)

Playing a Program List

While in PROGRAM mode, press **PLAY/PAUSE** .

Displaying the Program List

1. While the CD player is stopped, press **PROG•SET** to enter PROGRAM mode.

2. Press **PROG•SET** repeatedly to list each track assignment in the program list.

Deleting Program List

While in program mode, press and hold **STOP**  for 3 seconds. The system displays the message CLEAR.

Tips:

- You can create a program of up to 32 tracks.

Caution: Do not push to force closing of the tray during CD playback or tray opening.

Tuner

EN Selecting Tuner

1. Press **SOURCE** to select **TUNER**.
2. Press **BAND** to select between FM/MW/LW radio band.

Tip: Your audio system has 32 preset stations.

Tuning to a Station

Press **SKIP BACKWARD** ◀◀ / **SKIP FORWARD** ▶▶ to select frequencies.

87.50 MHz

Using Presets

The tuner can be either TUNE or PRESET mode. When in PRESET mode, the PROG light is on.

- Press **TUNE•PRESET** to toggle between Preset and Tune mode.
- Press **SKIP BACKWARD** ◀◀ / **SKIP FORWARD** ▶▶ or **PRESET UP** or **PRESET DOWN** on the remote control to access the previous or next preset station. The display first shows the preset program number and after a few seconds, the frequency will be displayed. (FM:PR:01 is FM preset 1)

PR:01

Auto Preset Programming (for FM only)

Press and hold **BAND/AUTO PROG/DECK1•2** button for 2 second to scan stations in the selected band. The stations will then be stored as preset channels. A maximum of 32 stations can be stored. Beware of your preset channels being erased accidentally because the scanning and storing process is automatic upon pressing the button.

You can stop the automatic scan by pressing any button, but the erased stations cannot be recovered.

Manually Setting Presets

1. Press **TUNE•PRESET** to enter TUNE mode.
2. Press **SKIP BACKWARD** ◀◀ / **SKIP FORWARD** ▶▶ to access the desired frequency.
3. Press the **PROG•SET** button once.

4. The most recently accessed program location will be displayed.
5. If a different program location is preferred, press **SKIP BACKWARD** ◀◀ / **SKIP FORWARD** ▶▶ to move to the desired preset number (1-32).
6. Press **PROG•SET** to store the selected frequency at that preset.

Suppressing Stereo Signal

Press **FM ST** to toggle between FM mono and stereo for stereo FM stations. (Remote Only)

Tuning to an RDS Station

Tip: RDS stations broadcast on FM only. When the tuner detects an RDS signal, the RDS icons turns on.

1. Press **TUNE•PRESET** to access preset station or press **SKIP BACKWARD** ◀◀ / **SKIP FORWARD** ▶▶ to desired frequency.
2. If RDS station found, **RDS** lights on display with station name shown.

Displaying RDS Station Information

Press **CLOCK/RDS** on the main unit or **REPEAT•RDS** on the remote control to display the frequency, station name (PS), station type (PTY), clock time (CT), or radio text (RT). In CT mode, press **INTRO•CT** key to replace the displayed time by RDS station time. If clock time is not yet set, this information will be shown as clock time automatically.

BBC No...
SCIENC... 12:05

Searching by Program Type (PTY) (Remote Only)

1. Press **PTY** to enter PTY selection
2. Toggle **PTY** to select a **PTY** mode.
3. Within 5 seconds, press **SKIP BACKWARD** ◀◀ / **SKIP FORWARD** ▶▶ to search for a station broadcasting the selected type of program.

Tuner

You can search for stations using one of the following program types:

RDS NEWS (news), AFFAIR (news and documentaries), INFO (weather, medical), SPORT (sports), EDUCAT (education), DRAMA (series and plays), CULTUR (religion), SCIENC (science and technology),

VARIED (miscellaneous), POP M (pop music), ROCK M (rock music), MOR M (middle-of-the road music), LIGHTM (light music), CLASSI (classical music), OTHERM (unclassified music), ALARM (alarm).

EN

Tape Player

Playing a Tape

Tip: You can play a tape from either deck.

1. Press **SOURCE** repeatedly to select **TAPE**.
2. Press the cassette door to open it.
3. Insert a tape into the door and push the door closed.
4. Press **BAND/AUTO PROG/DECK 1•2** to select deck 1 or 2.
5. Press **SKIP BACKWARD** ◀◀ / **SKIP FORWARD** ▶▶ to position the tape to the desired starting position.
6. Press **PLAY** ▶|| to begin playback .

Continuous Play

1. Press **PRESET UP** ▲ on the remote control to enable continuous play. "C" will appear before the counter.
2. Insert cassette tapes into deck 1 and 2.
3. Press **BAND/DECK 1/2** to select the deck to play first.
4. Press **PLAY** ▶|| to begin continuous playback.
5. Press **PRESET DOWN** ▼ to disable continuous play

Tape Counter

You can keep track of tape position with the tape counter. Press **PROG•SET** to reset.

Recording

From Tuner

1. Insert a tape into deck 1.
2. Press **SOURCE** repeatedly to select **TUNER** and to access the desired radio band.
3. Tune to the station to be recorded.
4. Press **RECORD** to begin recording.

5. Press **STOP** ■ to end recording.

From CD

1. Insert a tape into deck 1.
2. Press **SOURCE** repeatedly to select **CD**.
3. Insert the disc(s) to be recorded.
4. Select the track, CD, or program to be recorded.
5. Press **RECORD** to begin recording.
6. **CD** begins to play.
7. Press **STOP** ■ to end recording.

Tape to Tape

Synchronize Recording

1. Insert the destination tape in deck 1.
2. Insert the source tape into deck 2.
3. Press **RECORD**. The playback and recording start simultaneously.

Normal Recording

1. Insert the destination tape in deck 1.
2. Insert the source tape into deck 2 and press **PLAY** ▶|| .
3. Press **RECORD** when ready to record.

From an Auxiliary Input

1. Insert the cassette in deck 1.
2. Check that the auxiliary device has been connected correctly to the **GAME •MP3• L / R** connector on the front of the audio system.
3. Start playback on the auxiliary device.
4. Press **RECORD** to begin recording.
5. Press **STOP** ■ to end recording.

Troubleshooting Tips

EN

Problem	Solution	Problem	Solution
<i>System will not turn on</i>	<ul style="list-style-type: none"> • Check power cord for a secure connection. • Unplug the unit for a moment, and then plug into power source again. • Check the outlet by plugging in another device. 	<i>CD button will not respond, or does not change discs when you press DISC SKIP</i>	<ul style="list-style-type: none"> • Switch to another function (TAPE, Tuner) and then back to CD.
<i>No sound</i>	<ul style="list-style-type: none"> • Increase the volume setting. • Check connection to speakers. • Check that you have selected the appropriate function: CD, TAPE, Tuner. • Make sure mute is off. • Make sure headphones are not plugged in. 	<i>Distorted or noisy tape recordings</i>	<ul style="list-style-type: none"> • Inspect the tape heads, clean it if necessary.
<i>Poor radio reception</i>	<ul style="list-style-type: none"> • Check antenna connection. • Move antenna. • Turn off nearby electrical appliances, such as hair dryer, vacuum cleaner, microwave, fluorescent lights. 	<i>Remote control does not work</i>	<ul style="list-style-type: none"> • Check that the batteries are properly installed. • Replace weak batteries. • Check the system is plugged into power source. • Point the remote directly at the system's front panel. • Move closer to the system. • Remove any obstacles between the remote and the system.
<i>CD does not play</i>	<ul style="list-style-type: none"> • Check that CD is in the tray. • Check that CD label is facing up. • Check that PAUSE mode is not on. • Check that CD function is selected. • Use CD lens cleaner. • Clean the disc. • Try another CD. 		
<i>CD sound skips</i>	<ul style="list-style-type: none"> • Clean the disc. • Check disc for warping, scratches, or other damage. • Check if something is causing the system to vibrate. If so, move the system. • Make sure the speakers are at least 3 feet away or on a different surface from the main unit. 		

Maintenance

EN

Disconnect the audio system from the power source before performing any maintenance.

Cleaning

Clean the exterior of the system using a soft dust cloth.

CD Player

CAUTION! This system operates with a laser. It must be opened by only a qualified technician.

Tape Player

To prevent deterioration of sound quality, periodically open the door of each deck and clean the magnetic heads, pinch roller, and capstan with a cotton bud dipped in alcohol. Also, demagnetize the head by playing a demagnetizing cassette (available through an audio equipment store).

To protect recordings one or both sides of a tape, remove the corresponding tab. If you later want to record on the tape, affix a piece of adhesive tape over the hole.

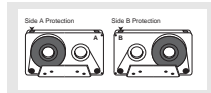

Quit Slacking - A little bit of slack in your tapes can cause scratches on the tape, or worse yet, the tape could break. If you notice some slack in the tape, use a pencil to tighten it up before you insert it.

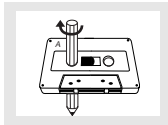

Handling CDs

- Do not touch the signal surfaces. Hold CDs by the edges, or by one edge and the hole. Do not affix labels or adhesive tapes to the label surfaces. Do not scratch or damage the label. CDs rotate at high speeds inside the player. Do not use damaged (cracked or warped) CDs

Cleaning CDs

- Dirty CDs can cause poor sound quality. Always keep CDs clean by wiping them gently with a soft cloth from the inner edge toward the outer perimeter.
- If a CD becomes dirty, wet a soft cloth in water, wring it out well, wipe the dirt away gently, and then remove any water drops with a dry cloth.
- Do not use record cleaning sprays or antistatic agents on CDs. Also, never clean CDs with benzene, thinner, or other volatile solvents which may cause damage to disc surface

CD Lens Care

When your CD lens gets dirty it can also cause the system to output poor sound quality. To clean the lens you will need to purchase a CD lens cleaner which can maintain the output sound quality of your system. For instructions on cleaning the CD lens, refer to the ones accompanying the lens cleaner.

Important Information

EN Safety Precautions

- Never open the cabinet under any circumstances. Any repairs or internal adjustments should be made only by a trained technician.
- Never operate this product with the cabinet removed.
- Do not use your System immediately after transporting it from a cold place to a warm place, as condensation may cause the system to malfunction.
- Keep your unit away from humid areas and abnormally hot places.
- Do not touch the player with wet hands. If any liquid enters the player cabinet, take the player to a trained technician for inspection.
- This compact disc player uses a laser to read the music on the disc. The laser mechanism corresponds to the cartridge and stylus of a record player. Although this product incorporates a laser pick-up lens, it is completely safe when operated according to directions.
- Discs rotate at high speed inside the player. Do not use damaged, warped, or cracked discs.
- Do not touch the pick-up lens which is located inside the disc compartment. To keep dust from collecting on the pick-up lens, do not leave the compartment door open for an extended period of time. If the lens becomes dirty, clean it with a soft brush, or use an air blower brush designed for camera lenses.
- The apparatus shall not be exposed to dripping and splashing.

Important Battery Information

- Remove the batteries to avoid leakage if you do not use your remote control for more than one month.
- Discard leaky batteries immediately as leaking batteries may cause skin burns or other personal injuries. Dispose of batteries in the proper manner, according to provincial and local regulations.
- Any battery may leak electrolyte under the following circumstances:
 - if mixed with a different battery type,
 - if inserted incorrectly,
 - if all batteries are not replaced at the same time,
 - if disposed of in fire, or
 - if an attempt is made to charge a battery not intended to be recharged.

Headset Safety

- Do not play your headset at high volume. Hearing experts warn against extended high-volume play.
 - If you experience ringing in your ears, reduce volume or discontinue use.
 - You should use with extreme caution or temporarily discontinue use in potentially hazardous situations.
- Even if your headset is an open-air designed to let you hear outside sounds, do not turn up the volume so high that you are unable to hear what is around you.

Don't Infringe

This product should only be used for the purposes for which it is sold, that is, entertainment, violating no copyright law. Any attempts to use this product for which it is not intended is unlawful and therefore not condoned by Thomson.

Technical Specification

Power supply: 230V~50Hz
 Dimensions (H x W x D mm):
 Unit size - 311 x 306 x 390
 Speaker - 311 x 240 x 197
 Tape deck: Response curve: 125Hz-8kHz (-5dB)
 CD player: Response curve (+/- 2dB): 60Hz to 5kHz
 Rating Plate: Look for it at the back of the set.

The descriptions and characteristics given in this document are given as a general indication and not as a guarantee. In order to provide the highest quality product possible, we reserve the right to make any improvement or modification without prior notice. The English version serves as the final reference on all products and operational details should any discrepancies arise in other languages.

Free Manuals Download Website

<http://myh66.com>

<http://usermanuals.us>

<http://www.somanuals.com>

<http://www.4manuals.cc>

<http://www.manual-lib.com>

<http://www.404manual.com>

<http://www.luxmanual.com>

<http://aubethermostatmanual.com>

Golf course search by state

<http://golfingnear.com>

Email search by domain

<http://emailbydomain.com>

Auto manuals search

<http://auto.somanuals.com>

TV manuals search

<http://tv.somanuals.com>