

# AIR CONDITIONER (SPLIT TYPE)

For general public use

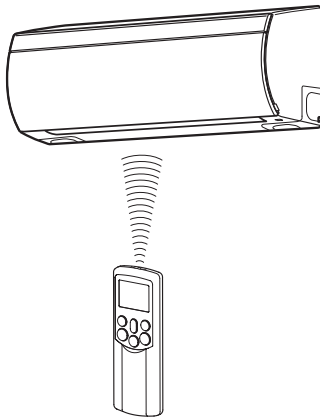

ENGLISH

EN

Indoor Unit	Outdoor Unit
RAS-07PKVP-E	RAS-07PAVP-E
RAS-10PKVP-E	RAS-10PAVP-E
RAS-13PKVP-E	RAS-13PAVP-E
RAS-16PKVP-E	RAS-16PAVP-E
RAS-18PKVP-E	RAS-18PAVP-E
RAS-07PKVP-ND	RAS-07PAVP-ND
RAS-10PKVP-ND	RAS-10PAVP-ND
RAS-13PKVP-ND	RAS-13PAVP-ND
RAS-16PKVP-ND	RAS-16PAVP-ND
RAS-18PKVP-ND	RAS-18PAVP-ND

# CONTENTS

## ENGLISH

ACCESSORIES.....	1
PRECAUTION FOR SAFETY .....	1
NAMES OF PARTS.....	4
NAMES AND FUNCTIONS OF INDICATORS AND CONTROLS ON INDOOR UNIT.....	4
REMOTE CONTROLLER AND ITS FUNCTIONS.....	5
NAMES AND FUNCTIONS OF INDICATORS ON REMOTE CONTROLLER.....	6
PREPARATION AND CHECK BEFORE USE .....	7
USING THE REMOTE CONTROLLER .....	9
AUTOMATIC OPERATION .....	10
AUTOMATIC OPERATION (AUTO CHANGEOVER) .....	10
COOLING/HEATING OPERATION.....	11
DRY OPERATION.....	11
8°C OPERATION (RAS-***-ND model only) .....	12
PURE OPERATION .....	13
Hi POWER OPERATION .....	13

TIMER OPERATION.....	14
MEMORY/MY COMFORT OPERATION .....	16
ADJUSTING AIR FLOW DIRECTION.....	17
AUTO RESTART OPERATION .....	18
HOW THE AIR CONDITIONER WORKS .....	19
TEMPORARY OPERATION .....	20
CLEANING OPERATION.....	20
USUAL MAINTENANCE .....	21
AIR CONDITIONER OPERATION AND PERFORMANCE .....	23
TROUBLESHOOTING .....	24
TROUBLESHOOTING (Remote Controller) .....	27
SPECIFICATIONS .....	28

\* Thank you for purchasing this TOSHIBA Air Conditioner.  
Please read this owner's manual carefully before using  
your Air Conditioner.

# ACCESSORIES

Remote controller

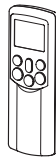

Remote controller holder



Batteries (two)



## PRECAUTION FOR SAFETY

Store this owner's manual in a location where it can be easily accessed when needed.  
 Be sure to read this owner's manual carefully before operating.  
 The supplied CD-ROM contains the owner's manual translated into many languages.  
 It is recommended that maintenance be performed by a specialist when the unit has been operated for a long time.

Be sure to follow the precautions provided here to avoid safety risks.  
 The symbols and their meanings are shown below.

DANGER	It indicates that incorrect use of this unit can result in a high possibility of severe injury(*1) or death.
WARNING	It indicates that incorrect use of this unit may cause severe injury or death.
CAUTION	It indicates that incorrect use of this unit may cause personal injury(*2), or property damage(*3).

\*1: A severe injury refers to blindness, injury, burns (hot or cold), electrical shock, bone fracture, or poisoning that leaves aftereffects and requires hospitalization or extended out-patient treatment.  
 \*2: Personal injury means a slight accident, burn, or electrical shock which does not require admission or repeated hospital treatment.  
 \*3: Property damage means greater damage which affects assets or resources.

























Never do.	Beware of rotating parts
Electrical hazard. Contact with water will cause electric shock. Do NOT touch with wet hands. Always unplug when not in use.	Risk of finger injury
Always follow the instructions	Do not get the product wet











### DANGER

Do not install, repair, open or remove the cover. It may expose you to dangerous voltages. Ask the dealership or the specialist to do this.
Turning off the power supply will not prevent potential electric shock.

### WARNING

The appliance shall be installed in accordance with national wiring regulation.
Means for disconnection from the supply having a contact separation of at least 3 mm in all poles must be incorporated in the fixed wiring.
Installation must be requested from the supplying retail dealership or professional installation vendors. Installation requires special knowledge and skill. If customers install on their own, it can be a cause of fire, electric shock, injury or water leakage.
Do not disassemble, modify or relocate the unit by yourself. It may become the cause of fire, electric shock, or water leakage. For repair or relocation, please request service from the supplying retail dealership or a dealership.
When relocating or repairing the unit, please contact the supplying retail dealership. When there is a kink in the wiring, it may be the cause of electric shock or fire.

	Do not select a location for installation where flammable gas may leak. If there is any gas leakage or accumulation around the unit, it can be a cause of fire.
	Do not select a location for installation where there may be excessive water or humidity, such as a bathroom. Deterioration of insulation may be a cause of electric shock or fire.
	Earth work should be requested from the supplying retail dealership or professional vendors. Insufficient grounding work may be the cause of electric shock. Do not connect the earth wire to a gas pipe, water pipe, lightning conductor, or telephone earth wire.
	You must use an independent power outlet for the power supply. If a power outlet other than the independent outlet is used, it may cause a fire.
	Check that the circuit breaker is installed correctly. If the circuit breaker is not properly installed, it may cause an electric shock. To check the installation method, please contact the supplying retail dealership or the professional vendor who installed the unit.
	During an error (such as a burning odor, not cooling, or not warming), stop operating the unit and turn off the circuit breaker. Continuous operation may be a cause of fire, or electric shock. Please request repair or service from the supplying retail dealership.
	Do not turn ON/OFF the circuit breaker or operate buttons with a wet hand. It may be a cause of electric shock.
	Do not insert any material (metal, paper, or water, etc) into the air outlet or air intake opening. Fan may be rotating at high speed inside or there are high voltage sections, which may cause an injury or electric shock.
	When the air-conditioning unit does not cool or warm, there may be a leakage of refrigerant. Please consult the supplying retail dealership. The refrigerant used in the air-conditioning unit is safe. It will not leak under normal operating conditions but if it leaks into the room and contacts a heat source such as a heater, or stove, it may cause a harmful reaction.
	When water or other foreign substances enter the internal parts, stop operating the unit immediately and turn off the circuit breaker. Operating the unit continuously may cause fire or electric shock. Please contact the supplying retail dealership for repair.
	Do not clean the inside of the air-conditioning unit yourself. Please request internal cleaning of the air-conditioning unit from the supplying retail dealership. Incorrect cleaning may cause breakage of resin parts or insulation defects of electrical parts, causing water leakage, electric shock or fire.
	Do not damage or modify the power cable. Do not connect the cable midway, or use a multiple outlet extension cord that is shared by other devices. Failure to do so may cause fire.
	Do not place heavy objects on the power cable, expose it to heat, or pull it. To do so may cause electrical shock or fire.
	Do not expose your body directly to cool air for a long time.
	Do not insert your finger or any article into the air inlet/outlet.
 <b>CAUTION</b>	
	Ensure that drained water is discharged. When the discharging water process is not sufficient, water may leak, causing water damage to furniture. To check that the installation method used is correct, please contact the supplying retail dealership or the professional vendor who installed the unit.
	If the indoor unit piping outlet is exposed due to relocation, close the opening, Touching internal electrical parts may cause injury or electric shock.
	Do not wash the main air-conditioning unit with water. It may cause an electric shock.
	Do not place any containers such as a vase containing fluid on the unit. It might cause water to enter the unit and deteriorate the electrical insulation, causing an electric shock.
	When using the unit in a closed room, or operating with other combustion appliances, make sure to open a window occasionally for ventilation. Insufficient ventilation may cause suffocation due to a lack of oxygen.
	Do not use combustion appliances in the direct flow of the air from the air-conditioning unit. Poor combustion of a combustion appliance may cause suffocation.
	Avoid operating for long periods in a high humidity environment (over 80%) such as with the windows or doors open. There may be condensation on the indoor unit and droplets may fall onto the furniture.
	When the unit won't be used for a long time, turn off the main switch or the circuit breaker.
	At least once a year check if the mounting table of the outdoor unit is damaged or not. If a damaged state is ignored, the unit may fall or over-turn, causing an injury.

	Stand on a sturdy ladder when attaching/detaching the front panel/air filter/air cleaning filter. Failure to do so may cause a fall or injury.
	Do not stand on the outdoor unit or place anything on the unit. It may be the cause of injury due to falling or over-turning. Any damage to the unit may cause an electric shock or fire.
	Do not place anything around the outdoor unit or allow fallen leaves to accumulate around it. If there are fallen leaves, small animals could enter and contact internal electrical parts, causing a failure or fire.
	Do not place animals and plants in places where wind from the air-conditioning unit flows directly. It may have a negative influence on the animal or plant.
	Do not use for special applications such as storage of food or animals, or to display plants, precision devices, or art objects. Do not use on ships or in other vehicles. It may cause a failure in the air-conditioning unit. In addition, it may damage these items.
	Do not place other electrical appliances or furniture under the unit. Water droplets might fall, causing damage or failure.
	When performing maintenance, you must stop operating the unit and turn off the circuit breaker. Since the fan inside may be rotating at high speed, it may cause an injury.
	After the front panel/air filter is cleaned, wipe away any water and allow to dry. If water remains, it may cause an electric shock.
	Once the front panel is removed, do not touch the metal parts (aluminum fins, etc.) of the unit. It may cause an injury.
	When you hear thunder and there might be a lightning strike, stop operating the unit and disconnect the circuit breaker. If lightning strikes, it may cause a failure.
	Do not hang laundry or other objects from the moving panel. The moving panel could fall and cause an injury.

# NAMES OF PARTS

## Outdoor unit

- ① Refrigerant connecting pipe, electric wires and drain hose
- ② Air inlet
- ③ Air outlet

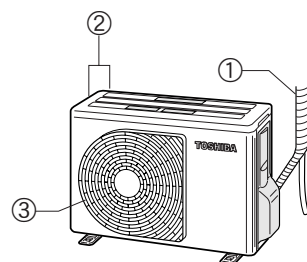

## Indoor unit

- ④ Humidity sensor/temperature sensor
- ⑤ Front panel
- ⑥ Moving panel
- ⑦ Air filter
- ⑧ Air outlet
- ⑨ Horizontal air flow louver
- ⑩ Vertical air flow louver
- ⑪ Plasma ion charger
- ⑫ Display panel
- ⑬ Infrared signal receiver
- ⑭ Remote controller
- ⑮ Panel support

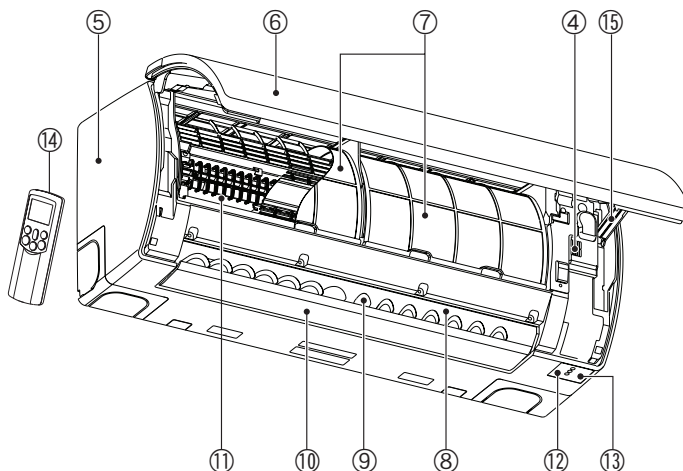

### CAUTION

(RAS-\*\*\*-ND model only)

Use care to avoid burns. A heater is installed on the base plate of the outdoor unit. When the outside air temperature is low, the heater runs to warm the base plate even if the unit is not operating so that snow does not accumulate inside the outdoor unit.

# NAMES AND FUNCTIONS OF INDICATORS AND CONTROLS ON INDOOR UNIT

## Display panel

The operating states are shown below.

- ① RESET button
- ② OPERATION indicator (Green)
- ③ TIMER/S.CLEAN indicator (Orange)
- ④ PURE indicator (Blue) \*1
- ⑤ Infrared signal receiver

\*1: If the orange light of the PURE indicator is turned on, this indicates a problem in the plasma ion charger. Please contact the dealer where you made the purchase.

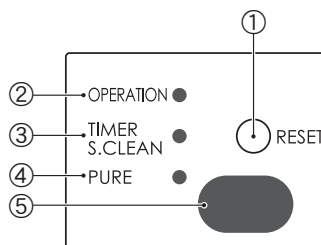





## RESET button

The RESET button has the following function.

- Temporary operation function  
Use when you misplace or lose the remote controller, or when its batteries are used up. (☞ see page 20.)

# REMOTE CONTROLLER AND ITS FUNCTIONS

- ① **Infrared signal transmitter**  
Transmits signals to the indoor unit.
- ② **⏻ button**  
Press the button to start operation. (A receiving beep is heard.) Press the button again to stop operation. (A receiving beep is heard.)  
If no receiving sound is heard from the indoor unit, press the button again.
- ③ **Mode select button (MODE)**  
Press this button to select a mode. Each time you press the button, the modes cycle in order from A: Auto changeover control, ⚙️: COOL, ☁️: DRY, ☀️: HEAT and back to A.  
(A receiving beep is heard.)
- ④ **Temperature button (TEMP)**  
▲ .. The temperature setting is raised to 30°C.  
▼ ... The temperature setting is lowered to 17°C.  
(A receiving beep is heard.)
- ⑤ **Set horizontal air flow button (FIX)**  
Press this button to adjust the horizontal air flow direction. (A receiving beep is heard.) (☞ see page 17.)
- ⑥ **Set vertical air flow button (FIX)**  
Press this button to adjust the vertical air flow direction. (A receiving beep is heard.) (☞ see page 17.)
- ⑦ **Auto louver button (SWING)**  
Each time you press the SWING button, you can change the swing mode. (A receiving beep is heard.)  
(Vertical swing → Horizontal swing → Vertical and Horizontal swing → Stop swinging)  
Press the button again to stop the swinging mode. (A receiving beep is heard.) (☞ see page 17.)
- ⑧ **ON timer button (ON)**  
Use this button to change the clock and ON timer times.  
  
To move up the time, press ▲ of the ON  button.  
  
To move down the time, press ▼ of the ON  button.
- ⑨ **OFF timer button (OFF)**  
Use this button to change the OFF timer times.  
  
To move up the time, press ▲ of the OFF  button.  
  
To move down the time, press ▼ of the OFF  button.
- ⑩ **Reserve button (SET)**  
Press this button to store the time settings. (A receiving beep is heard.)
- ⑪ **Cancel button (CLR)**  
Press this button to cancel the ON timer and OFF timer. (A receiving beep is heard.)
- ⑫ **High power button (Hi POWER)**  
Press this button to start high power operation. (☞ see page 19.)
- ⑬ **Memory button (MEMO)**  
Press this button to be ready for storing the settings. Hold down the button for 3 seconds or more to store the setting indicated on the remote controller and until the  mark is displayed. (☞ see page 16.)

- ⑭ **Automatic operation button (AUTO)**  
Press this button to operate the air conditioner automatically.  
(A receiving beep is heard.) (☞ see page 10.)
- ⑮ **SLEEP MODE button**  
Press this button to start sleep mode. (☞ see page 19.)
- ⑯ **MY COMFORT button**  
Press this button to operate the air conditioner according to the settings stored using the MEMO button. (☞ see page 16.)
- ⑰ **PURE button (PURE)**  
Press this button to start the electrical air purifying operation.  
Press the button again to stop operation. (☞ see page 13.)
- ⑱ **Fan speed button (FAN)**  
Press this button to select the fan speed. When you select AUTO, the fan speed is automatically adjusted according to the room temperature. You can also manually select the desired fan speed from five available settings.  
(LOW —, LOW+ —, MED —, MED+ —, HIGH —) (A receiving beep is heard.)
- ⑲ **8°C operation button (8°C)**  
Press this button to start the 8°C set temperature heating operation. (☞ see page 12.) (RAS-\*\*\*-ND model only)

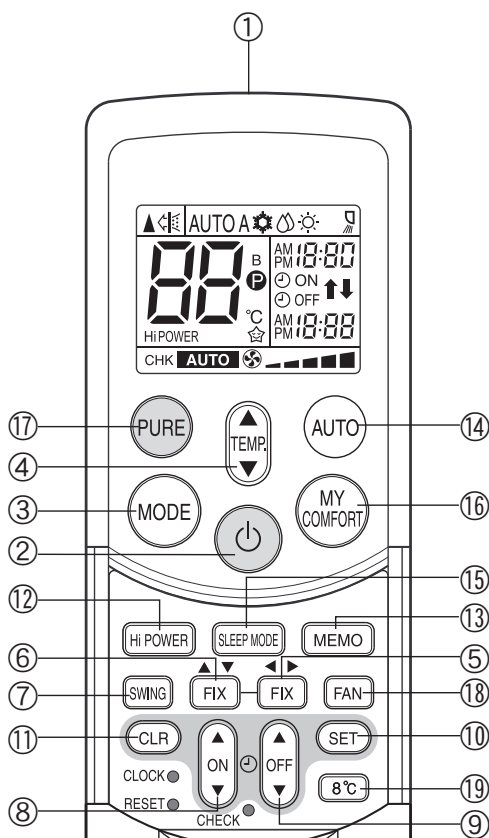

# NAMES AND FUNCTIONS OF INDICATORS ON REMOTE CONTROLLER

## Display

All indicators, except for the clock time indicator, are displayed by pressing the  button.



### ① Transmission mark

This transmission mark () indicates when the remote controller transmits signals to the indoor unit.

### ② Mode indicator

Indicates the current operation mode.

- Heat pump models

(AUTO: Automatic control, A: Auto changeover control, : COOL, : DRY, : HEAT)





### ③ Temperature indicator

Indicates the temperature setting (17°C to 30°C).

### ④ PURE indicator

Shows that the electrical air purifying operation is in progress.

### ⑤ FAN speed indicator

Indicates the selected fan speed. AUTO or one of five fan speed levels (LOW , LOW+ , MED , MED+ , HIGH ) can be shown.

Indicates AUTO when the operating mode is either AUTO or : DRY.

### ⑥ TIMER and clock time indicator

The time setting for timer operation or the clock time is indicated.

The current time is always indicated except during TIMER operation.

### ⑦ Hi POWER indicator

Indicates when Hi POWER operation starts.

Press the Hi POWER button to start and press it again to stop operation.

### ⑧ (MEMORY) indicator

Flashes for 3 seconds when the MEMO button is pressed during operation.

The  mark is shown when holding down the button for 3 seconds or more while the mark is flashing.

Press another button to turn off the mark.

### ⑨ SLEEP MODE indicator

Indicates when the SLEEP MODE is activated.

Press the SLEEP MODE button to start and press it again to stop operation.

### ⑩ A. B change indicator remote controller

- When the remote controller switching function is set, "B" appears in the remote controller display. (When the remote controller setting is "A", there is no indication at this position.)

#### Remote controller switching function

- If two indoor units are installed in the same room or adjoining rooms, both units may start and stop at the same time when the remote controller is operated. This can be prevented by setting the switching function so that each indoor unit is operated only by the corresponding remote controller.
- To use the remote controller switching function, contact the air conditioner dealer or the installation company.

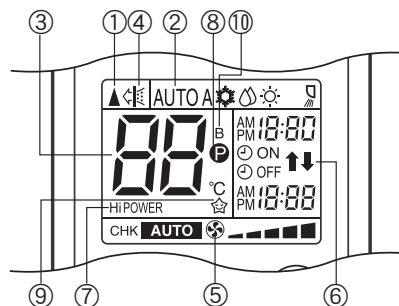

- In the illustration, all indicators are shown for purposes of explanation. During operation, only the relevant indicators are shown on the remote controller.

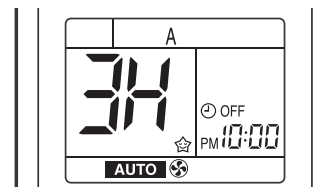



# PREPARATION AND CHECK BEFORE USE

## Loading the remote controller batteries

- ① Remove the cover, and insert the batteries.
- ② Reattach the cover.

## Removing the batteries

- ① Remove the cover, and take out the batteries.
- ② Reattach the cover.

\* Please dispose of the batteries according to the local regulation.

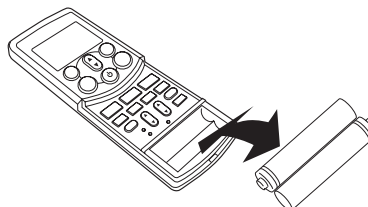
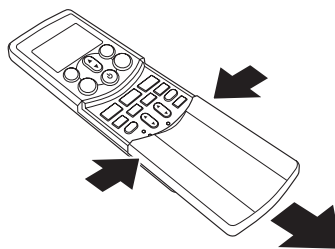

## Batteries

- To replace the batteries, use two new batteries (AAA type).
- The batteries will last about one year under normal usage.
- Replace the batteries if there is no receiving beep from the indoor unit or when the air conditioner cannot be operated using the remote controller.
- To avoid malfunctions due to battery leakage, remove the batteries when not using the remote controller for over one month.
- Slide off the cover while pressing the sides.

## Battery replacement



Be careful not to reverse the (+) position and the (-) position.



## Setting the clock

Before you start operating the air conditioner, set the clock of the remote controller using the procedures given in this section. The clock panel on the remote controller will indicate the time regardless of whether the air conditioner is in use or not.

## Initial setting

When batteries are inserted in the remote controller, the clock panel displays AM 0:00 and flashes.

- ① **ON**  button (or **OFF**  button)

Press the ON  button (or OFF  button) to set the current time.

Each press of the ON button (or OFF button) changes the time in one minute increments.

Holding down the ON button (or OFF button) changes the time in ten minute increments.

- ② **SET**  button

Press the SET  button.

The current time is displayed and the clock starts.

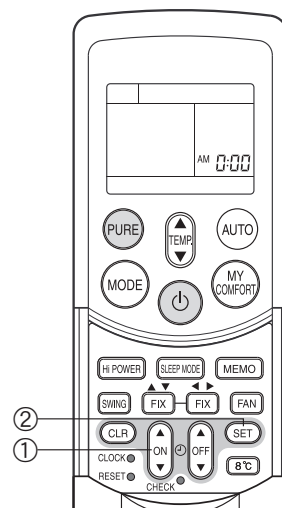



## Adjusting the clock

### ① CLOCK button

Press the CLOCK button.

The clock time indicator flashes.

### ② ON button (or OFF button)

Press the ON  button (or OFF  button) to set the current time.

Each press of the ON button (or OFF button) changes the time in one minute increments. Holding down the ON button (or OFF button) changes the time in ten minute increments.

### ③ SET button

Press the SET  button.

The current time is displayed and the clock starts.

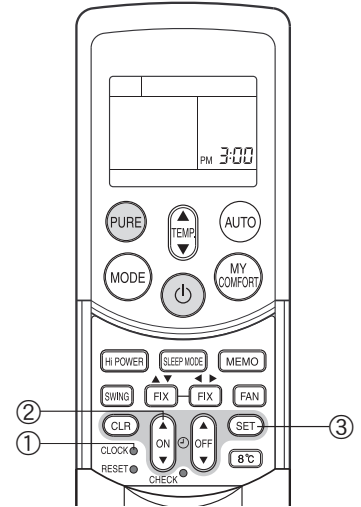
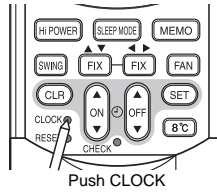

# USING THE REMOTE CONTROLLER

## CAUTION

- The air conditioner will not operate if curtains, doors or other objects block the signals from the remote controller to the indoor unit.
- Be careful that liquids do not spill onto the remote controller.
- Do not expose the remote controller to direct sunlight or heat.  
If the infrared signal receiver on the indoor unit is exposed to direct sunlight, the air conditioner may not function properly. Use curtains to prevent sunlight from reaching the receiver.
- Signals may not be properly received, if the room using the air conditioner has fluorescent lighting with electronic starters. If you plan to use fluorescent lamps, consult with your local dealer.
- If other electrical appliances are activated by the remote controller, move these appliances or consult with your local dealer.

## Location of the remote controller

- Keep the remote controller where its signals can reach the receiver of the indoor unit (a distance of up to 7 m is allowed).
- When you select timer operation, the remote controller automatically transmits a signal to the indoor unit at the specified time.  
If you keep the remote controller in a location where proper signal transmission is blocked, a time lag of up to 15 minutes may occur.

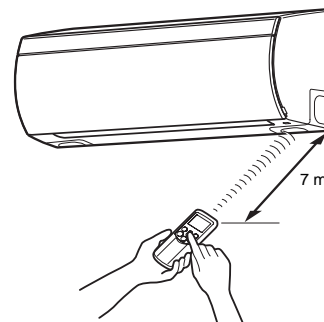

## Remote controller holder

### Installing the remote controller holder

- Before you actually install the remote controller holder on a wall or pillar, check whether the remote controller signals can be received by the indoor unit.

### Mounting and removing the remote controller

- To mount the remote controller, hold it parallel to the remote controller holder and push it in fully. To remove the remote controller, slide the remote controller upwards and out from the holder.

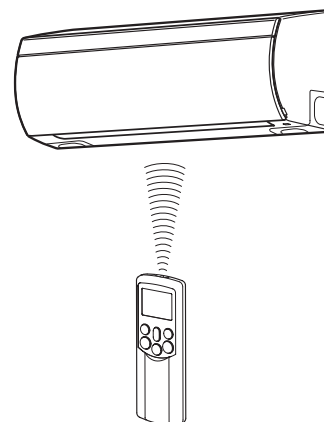
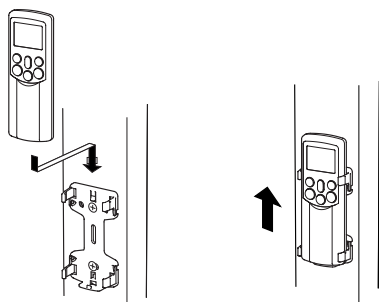

## Types of signal receiving tones

When the receiver of the indoor unit receives a signal, a signal receiving tone is made from the indoor unit.

- ♪ Beep♪ ..... Start/Change
- ♪ Prolonged beep♪ ..... Stop
- ♪ Beep-beep♪ ..... Notify

## When the notification sound ♪ beep-beep♪ is made

- This indicates that the temperature, fan speed, or air flow direction settings were returned to the basic settings.

Item	Basic setting
Temperature	22°C (8°C~8°C OPERATION (RAS-***-ND model only))
Fan speed	AUTO
Horizontal air flow	When the horizontal air flow louver faces the front.
Vertical air flow	When the vertical air flow louver stops at the louver limit position.

# AUTOMATIC OPERATION

When you set the air conditioner to AUTO mode, it automatically selects cooling, heating, or fan only operation depending on the room temperature. (☞ see page 19.)

The fan speed and louver are also automatically controlled.

## Start

- ① **Power button**  
Press this button to start the air conditioner.
- ② **AUTO button (AUTO)**  
Press AUTO button.
- ③ **Temperature button (TEMP)**  
Set the desired temperature.

- The OPERATION indicator (green) on the display panel of the indoor unit lights. The operating mode is selected according to the room temperature and operation starts after approximately 3 minutes.
- If the AUTO mode is uncomfortable, you can select the desired conditions manually. The fan speed and louver position can be changed, and MODE is also changed from AUTO to A when the fan speed or louver position is changed. The fan speed indicator is also shown.

## Stop

- Power button**  
Press this button again to stop the air conditioner.

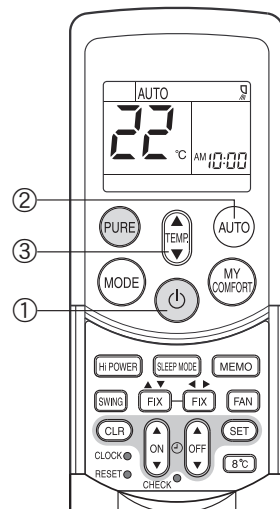

# AUTOMATIC OPERATION (AUTO CHANGEOVER)

When you set the air conditioner to A mode or switch over from AUTO operation because of a change in settings, the air conditioner automatically selects cooling or heating operation depending on the room temperature. (☞ see page 19.)

## Start

- ① **Power button**  
Press this button to start the air conditioner.
- ② **Mode select button (MODE)**  
Select A.
- ③ **Temperature button (TEMP)**  
Set the desired temperature.
- ④ **Fan speed button (FAN)**  
Select one of "AUTO" LOW —, LOW+ — — —, MED — — — —, MED+ — — — — —, HIGH — — — — — — —.

- The OPERATION indicator (green) on the display panel of the indoor unit lights. The operating mode is selected according to the room temperature and operation starts after approximately 3 minutes.
- The temperature, fan speed and louver position can be changed. You can select the desired conditions manually.

## Stop

- Power button**  
Press this button again to stop the air conditioner.

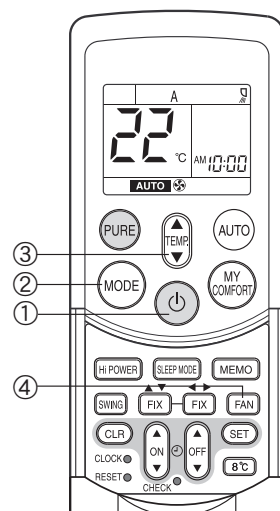

# COOLING/HEATING OPERATION

## Start

- ① **⏻ button**  
Press this button to start the air conditioner.
  - ② **Mode select button (MODE)**  
Select COOL ❄️ or HEAT ☀️.
  - ③ **Temperature button (TEMP)**  
Set the desired temperature.
  - ④ **Fan speed button (FAN)**  
Select one of "AUTO" LOW —, LOW+ — —, MED — — —, MED+ — — — —, HIGH — — — — —.
- The OPERATION indicator (green) on the display panel of the indoor unit turns on.  
Operation starts after approximately 3 minutes.

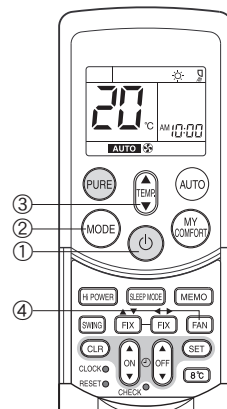

## Stop

- ⏻ button**  
Press this button again to stop the air conditioner.

# DRY OPERATION

## Start

- ① **⏻ button**  
Press this button to start the air conditioner.
  - ② **Mode select button (MODE)**  
Select DRY ☁️.
  - ③ **Temperature button (TEMP)**  
Set the desired temperature.
- The fan speed setting is fixed to AUTO and the AUTO is displayed.
  - The OPERATION indicator (green) on the display panel of the indoor unit turns on, and operation starts after approximately 3 minutes.

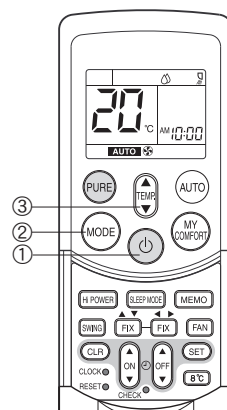

## Stop

- ⏻ button**  
Press this button again to stop the air conditioner.

## 8°C OPERATION (RAS-\*\*\*-ND model only)

This function is usable for prevention of freeze of an uninhabited room.  
Press this button to start the 8°C set temperature heating operation.  
The air conditioner controls the room temperature to about 8°C.  
The room temperature may deviate slightly from 8°C depending on the size of the room and the installation condition of the unit.

### Starting the 8°C heating operation while the air conditioner is stopped

#### Start

##### ① 8°C button

Press this button to start the 8°C set temperature heating operation.

- The OPERATION indicator (green) on the display panel of the indoor unit turns on. Operation starts after approximately 3 minutes.

#### Stop

##### ⏻ button

Press this button to stop the air conditioner.

If the 8°C heating operation starts while the air conditioner is stopped, press the 8°C button again to stop the operation.

### Starting the 8°C heating operation while the air conditioner is operating

#### Start

##### ① 8°C button

Press this button to change to the 8°C set temperature heating operation.

- If the air conditioner performs a cooling (including automatic cooling) or dry operation, it stops and the 8°C set temperature heating operation starts after approximately 3 minutes. If the air conditioner performs a heating operation, it changes immediately to the 8°C heating operation.
- If the air conditioner performs a PURE operation, it performs both the pure operation and 8°C heating.

#### Stop

##### ⏻ button

Press this button to stop the air conditioner.

If the 8°C heating operation starts while the air conditioner is operating, press the 8°C button again to return to the previous operating condition.

Check the operating condition on the screen of the remote control.

When a heating operation starts from 8°C heating, it can take approximately 5 minutes for the warm air to start blowing.

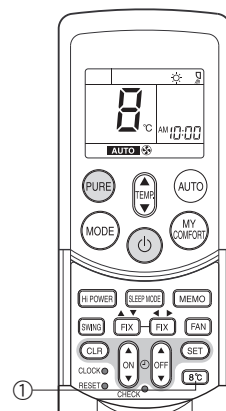

### CAUTION

The heating performance could worsen if the louver direction is too high during 8°C heating operation.

### NOTE

- The fan speed at the start of 8°C heating is operated with AUTO.
- If a timer operation is set to before the 8°C heating operation, the timer operation setting is cancelled. Timer operation settings cannot be made during 8°C heating operation.
- Settings for SWING (louver swing), FIX (louver position), FAN (fan speed) and PURE (pure operation) can be changed during 8°C heating operation. Setting changes cannot be made with other buttons.
- Temperature can be changed from 5°C to 13°C during 8°C heating operation.
- The temperature of the blown air is lower than during normal heating operation.

# PURE OPERATION

Press this button to start the electrical air purifying operation.

## During air conditioner operation

### ① PURE button

PURE operation starts by pressing this button.

- The PURE indicator (blue) on the display panel of the indoor unit turns on.
- Plasma ion charger is activated.

## To stop only PURE operation

### PURE button

PURE operation stops by pressing this button.

- The PURE indicator (blue) on the display panel of the indoor unit turns off, while air conditioner is operating.
- Plasma ion charger is deactivated.

## To stop air conditioner operation at the same time

### ⏻ button

Air conditioner operation and PURE operation stop by pressing this button.

- The OPERATION indicator (green) and PURE indicator (blue) on the display panel of the indoor unit turn off.

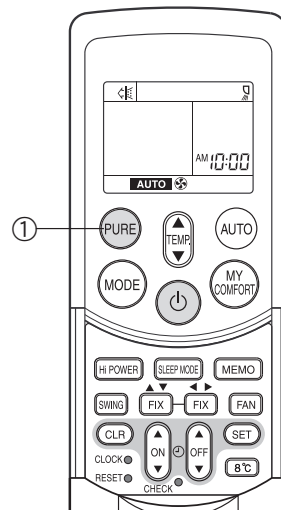

## CAUTION

- When the ⏻ button is pressed the next time, operation starts with the combined air conditioner and PURE operation.
- During the combined air conditioner and PURE operation, air conditioner operation only cannot be stopped.

## When the air conditioner is stopped

### ① PURE button

PURE operation starts by pressing this button.

- The PURE indicator (blue) on the display panel of the indoor unit turns on.

## INFORMATION

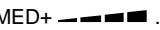
- During PURE operation, a small amount of ozone is produced, and you might notice the smell.
- When the fan speed is automatic, it changes up to MED+ .
- During Hi POWER operation, the position of the vertical air flow louver changes to the high power position.

# Hi POWER OPERATION

## High power (Hi POWER)

- The Hi POWER (high power operation) mode automatically controls room temperature, air flow and the operation mode so that the room is quickly cooled in summer and warmed in winter. (☞ see page 19.)

## Setting Hi POWER mode

### ① Hi POWER button

Press the Hi POWER button. The Hi POWER mark on the remote controller is shown.

## Canceling Hi POWER mode

### ① Hi POWER button

Press the Hi POWER button once again.

The Hi POWER mark on the remote controller turns off.

## CAUTION

The Hi POWER mode cannot be activated during DRY operation.

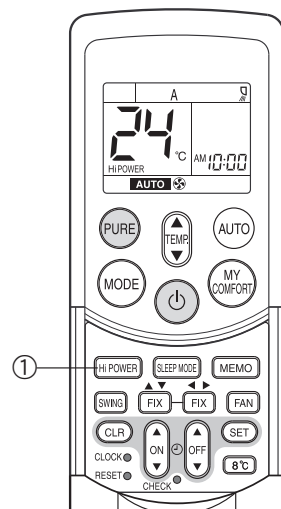

# TIMER OPERATION

## ON timer and OFF timer

### Setting the ON Timer

① **ON**  button

Press the ON  button. Set the timer to the desired time.

Each time the ON button is pressed, the time changes in ten minute increments.  
Holding down the ON button changes the time in one hour increments.

② **SET**  button

Press the SET  button to set the timer.  
The timer time is displayed, and the timer starts.

③ **CLR**  button

Press the CLR  button to cancel the timer setting.

### Setting OFF Timer

① **OFF**  button

Press the OFF  button.

Set the timer to the desired time.

Each time the OFF button is pressed, the time changes in ten minute increments.  
Holding down the OFF button changes the time in one hour increments.

② **SET**  button

Press the SET  button to set the timer.  
The timer time is displayed, and the timer starts.

③ **CLR**  button

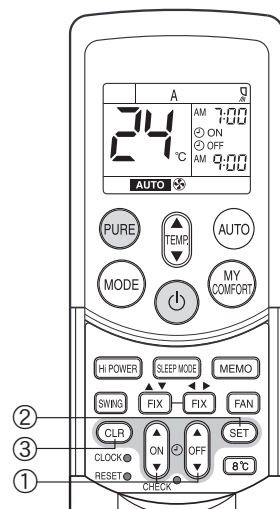

Press the CLR  button to cancel the timer setting.



### CAUTION

- When you select timer operation, the remote controller automatically transmits the timer signal to the indoor unit at the specified time. Therefore, keep the remote controller in a location where it can transmit the signal to the indoor unit properly.
- If you do not press the SET  button within 30 seconds after setting the time, the setting will be cancelled.

Once you select timer operation mode, the settings are saved in the remote controller.

Thereafter, the air conditioner will start operating under the same conditions as you adjusted by the  or  button on the remote controller.

You cannot set the timer when the clock display is flashing.

Follow the instructions in the section "Setting the clock" on page 7 to set the clock, and then set the timer.



## Combined timer (Setting the ON and OFF timers simultaneously)

### OFF timer → ON timer



#### (Operation → Stop → Operation)

This feature is useful when you want to stop the air conditioner after you go to sleep, and start it again in the morning when you wake up or you return home.

Example:

To stop the air conditioner and start it again next morning

#### Setting combined TIMER

- (1) Press the OFF  button to set the OFF timer.
- (2) Press the ON  button to set the ON timer.
- (3) Press the SET  button.

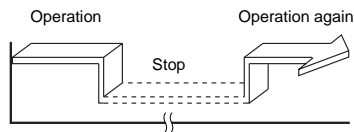

### ON timer → OFF timer



#### (Stop → Operation → Stop)

You can use this setting to start the air conditioner when you wake up and stop it when you leave the house.

Example:

To start the air conditioner the next morning and stop it

#### Setting combined TIMER

- (1) Press the ON  button to set the ON timer.
- (2) Press the OFF  button to set the OFF timer.
- (3) Press the SET  button.

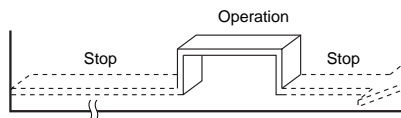

- The ON or OFF timer function that is closer to the current time is activated first.
- If the same time is set for both ON and OFF timers, no timer operation is performed. Also, the air conditioner may stop operating.





### CAUTION

Approximately 3 seconds later, the remote controller will transmit the signal to the indoor unit and a receiving beep will sound from the indoor unit after you press the SET  button.

## Daily combined timer (setting the ON and OFF timers simultaneously and activating every day)

This feature is useful when you want to use the combined timers at the same time every day.

#### Setting combined TIMER

- (1) Press the ON  button to set the ON timer.
- (2) Press the OFF  button to set the OFF timer.
- (3) Press the SET  button.
- (4) After step (3), an arrow mark (↑ or ↓) flashes for about 3 seconds. Press the SET  button during this flashing.

- Both arrows (↑, ↓) are shown while the daily timer is activated.

#### Cancelling timer operation

Press the CLR  button.

#### Clock display

During TIMER operation (ON-OFF, OFF-ON, OFF timer), the clock time indicator is not shown so the setting time can be displayed. To view the current time, press the SET button briefly and the current time will be displayed for about 3 seconds.

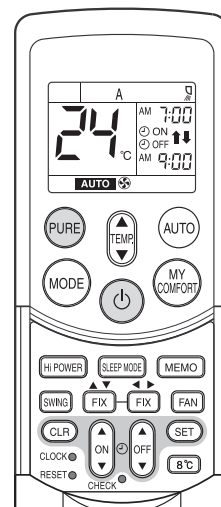

# MEMORY/MY COMFORT OPERATION

Use the MEMO button to store a frequently used operation setting for convenience. Start the air conditioner in the operation mode that you want the remote controller to store.

Press the button as shown below while the air conditioner is operating.

## ① MEMO button

Press this button briefly to ready for storing the setting.

All the icons currently shown flash, except for the clock time indicator and mode indicator.

## ② MEMO button

Hold down the MEMO button for 3 seconds or more while the indicator flashes.

The **P** mark is shown and the setting is stored.

- If you do not press the MEMO button within 3 seconds or if you press another button, the MEMORY setting is cancelled.
- Operation modes which can be stored with the MEMO button are MODE, Temperature, FAN, TIMER and Hi POWER.

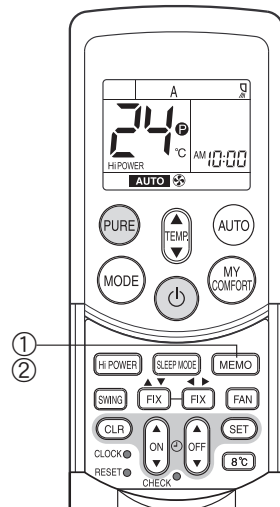

To operate the air conditioner with the setting stored using the MEMO button.

## ① MY COMFORT button

Press the MY COMFORT button. The setting stored with the MEMO button will be shown and the air conditioner operates based on the setting.

### (A): When the MY COMFORT button is pressed while operation is stopped

- The OPERATION indicator (green) on the display panel of the indoor unit turns on, and operation starts after approximately 3 minutes.

### (B): When the MY COMFORT button is pressed during operation

- The operation mode changes to the setting stored with the MEMO button.

- Initial setting:

MODE : AUTO

Temperature : 22

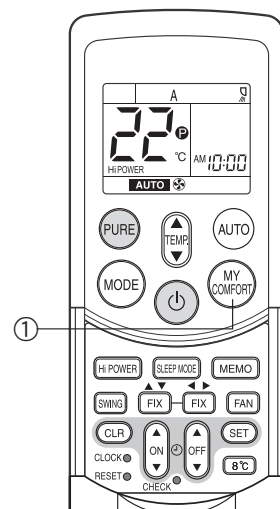

# ADJUSTING AIR FLOW DIRECTION

- Adjust the air flow direction properly. Failure to do so could cause discomfort and make an uneven room temperature distribution.
- Adjust the vertical air flow using the remote controller.
- Adjust the horizontal air flow using the remote controller.

## Adjusting the vertical air flow

The air conditioner automatically adjusts the vertical air flow direction according to the operating conditions when AUTO or A mode is selected.

## Adjusting the horizontal air flow

### Preparation:

- While the air conditioner is operating, you can use the remote controller to change the air flow in the horizontal (left/right) direction.

### To set a selected vertical air flow direction

Use this function when the air conditioner is operating.

#### ① FIX ▲▼ button

Hold down or briefly press the FIX button on the remote controller to move the louver in the desired direction.

### To set a selected horizontal air flow direction

Use this function when the air conditioner is operating.

#### ② FIX ◀▶ button

Hold down or briefly press the FIX button on the remote controller to move the louver in the desired direction.

### NOTE

- Change the vertical/horizontal air flow louver direction within the range indicated.
- In subsequent operations, the vertical/horizontal air flow is automatically set to the direction that you set the louver using the FIX button.

### To automatically swing the air flow direction

Perform this function when the air conditioner is operating.

#### ③ SWING button

Each time you press the SWING button, the air conditioner's operation mode is changed as follows:

- The vertical air flow louver swings.
- The horizontal air flow louver swings.
- The vertical air flow louver and horizontal air flow louver swing at the same time.
- The swinging of the vertical air flow louver and horizontal air flow louver is stopped.
- Press FIX ▲▼ to change the center position of the vertical air flow louver swinging.
- Press FIX ◀▶ to change the center position of the horizontal air flow louver swinging.
- To stop the function, press the SWING button.

### CAUTION

- The FIX and SWING buttons will be disabled when the air conditioner is not operating (including when ON TIMER is set).
- Do not operate the air conditioner for an extended period of time with the air flow direction set downward during the cooling or dry operation. Otherwise, condensation may occur on the surface of the vertical air flow louver and cause water dripping.
- Do not move the vertical air flow louver and horizontal air flow louver manually. Always use the FIX button. If you move the louver manually, it may malfunction during operation. If the louver malfunctions, stop the air conditioner once, and restart.
- When the air conditioner is started immediately after it was stopped, the vertical air flow louver might not move for about 10 seconds.

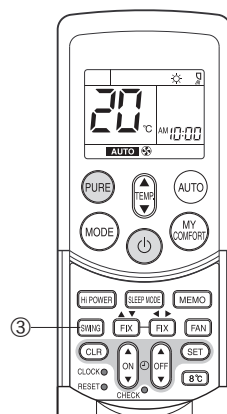
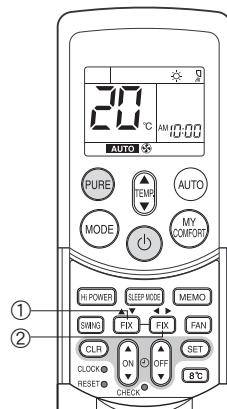
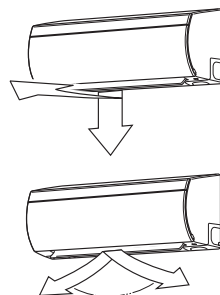

When the vertical air flow louver is opened with the FIX button, it reverses direction while opening.

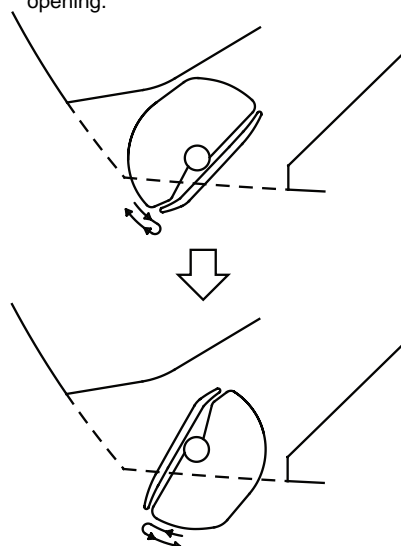

# AUTO RESTART OPERATION

This air conditioner is equipped with an automatic restarting function which allows the air conditioner to resume without the use of the remote controller under the operating settings in the event of a power shutdown. Operation resumes without warning 3 minutes after power is restored.

## INFORMATION

The AUTO RESTART OPERATION is not set to work at factory shipment, and so it is necessary to set it to this function if required.

## HOW TO SET AUTO RESTART

To set the auto restart function, proceed as follows:

The power supply to the unit must be on. The function will not be set if the power is off.

To enable the auto restart function, hold down the RESET button for 3 seconds.

The air conditioner receives the setting and beeps 3 times. Now the auto restart setting is activated. The system can restart automatically.

(1) When the air conditioner is in stand-by (not running).

Hold down the RESET button for 3 seconds or more.

- The air conditioner starts to operate. The green indicator turns on.
- After about 3 seconds, the air conditioner beeps 3 times.

**The green indicator flashes for 5 seconds.**

- The air conditioner is operating.

If the air conditioner is not required to run at this time, push the RESET button again or use the remote controller to stop the air conditioner.

(2) When the air conditioner is operating.

Hold down the RESET button for 3 seconds or more.

- The air conditioner stops operating. The green indicator turns off.
- 3 seconds after pushing the button, the air conditioner beeps 3 times.

**The green indicator flashes for 5 seconds**

- The air conditioner stops.

If you do not need the air conditioner to stop at this time, use the remote controller to restart the air conditioner. During the subsequent operation, the green indicator is turned on.

The auto restart operation will not accept a command if timer operation with the remote controller is activated.

- After restarting the air conditioner by the AUTO RESTART OPERATION, the louver swing (AUTO) operation resumes.

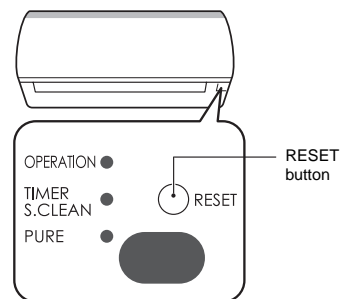

## HOW TO CANCEL AUTO RESTART

To cancel the auto restart operation, proceed as follows:

Repeat the setting procedure. The air conditioner receives the setting and beeps 3 times.

Now the auto restart setting is cancelled.

The air conditioner needs to be manually restarted with the remote controller after the main supply is turned off.

(1) When the air conditioner is in stand-by (not running).

Hold down the RESET button for 3 seconds or more.

- The air conditioner starts to operate.  
The green indicator will turn on.
- After about 3 seconds, the air conditioner beeps 3 times.
- The air conditioner is operating.

If the air conditioner is not required to run at this time, push the RESET button again or use remote controller to stop the air conditioner.

(2) When the air conditioner is operating.

Hold down the RESET button for 3 seconds or more.

- The air conditioner stops operating.  
The green indicator is turned off.
- After about 3 seconds, the air conditioner beeps 3 times.
- The air conditioner stops.

If you do not need the air conditioner to stop at this time, use the remote controller to restart the air conditioner.

During subsequent operation, the green indicator is turned on.

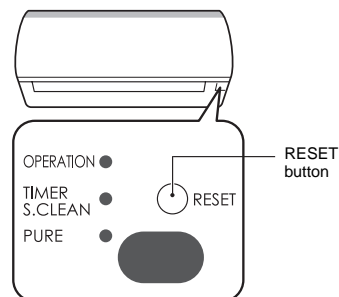

## INFORMATION

Do not hold down the RESET button for more than 10 seconds. Otherwise, the forced cooling operation used during servicing and re-installation will activate.

To stop the forced cooling operation, press the RESET button again.

# HOW THE AIR CONDITIONER WORKS

## Automatic Operation

As shown in Figure 1, Automatic Operation mode selects the operation based on the room temperature data when operation begins.

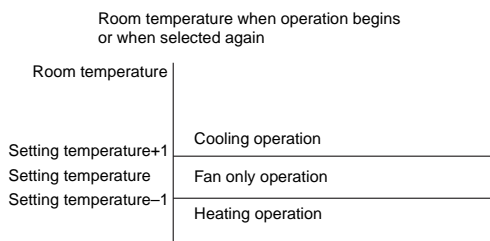

Figure 1

The operation mode is selected again after the compressor has remained stopped for 15 minutes.

## Hi POWER operation

When you press the Hi POWER button during cooling, heating or A operation, the air conditioner starts the following operation.

### • Cooling operation

The cooling operation is performed at 1°C lower than the temperature setting.

The fan speed is also set to high\*.

\* The noise level raises, according to the fan speed.

### • Heating operation

The heating operation is performed at 2°C higher than the temperature setting.

The fan speed is automatically switched according to the operating condition.

## SLEEP MODE operation

The air conditioner automatically controls the room temperature, air flow and noise level, to prevent overcooling in summer and maintain a warm and comfortable room in winter.

### INFORMATION

- The power and noise level are reduced during sleep mode, so the room may not be cooled sufficiently if the mode is used for a long period of time.
- The sleep mode cannot be used during dry operation, PURE operation (independent operation). (PURE operation (independent operation) is when the PURE button is pressed while the air conditioner is stopped to perform PURE operation by itself. The air conditioner does not operate at this time.)
- If the FAN button is pressed during sleep mode, the sleep mode is canceled.
- Sleep mode is not a timer operation.

## Dry operation ( )

The dry mode automatically selects the cooling dry operation based on the difference between the temperature setting and the actual room temperature.

The fan speed indicator shows AUTO, and low speed is used.

- The display panel indicators will decrease in brightness in sleep mode.

## HINTS FOR ECONOMICAL OPERATION

### Maintain room temperature at a comfortable level

#### Clean the air filters

Clogged air filters impair the performance of the air conditioner. Clean them every two weeks.

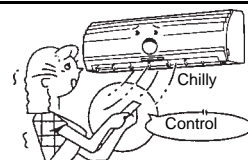
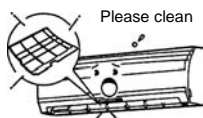

#### Never open doors and windows more than necessary

To keep cool or warm air in the room, never open doors and windows more than necessary.

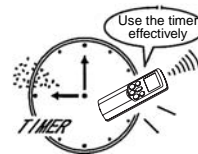
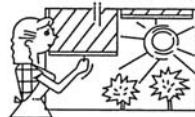

#### Window curtains

During cooling operation, close the curtains to avoid direct sunlight. During heating operation, close the curtains to keep the heat in.

#### Use the timer effectively

Set the timer for the desired operating time.

#### Allow uniform circulation of room air

Adjust the air flow direction for even circulation of room air.

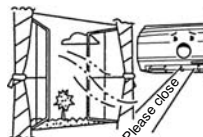

Blows upward

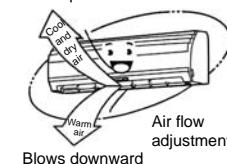

## TEMPORARY OPERATION

### Temporary operation

This function is used to operate the unit temporarily in case you misplace the remote controller or the batteries are used up.

- Push the RESET button to start the automatic operation (AUTO).
- While the temporary operation is activated, the remote controller operation is disabled.

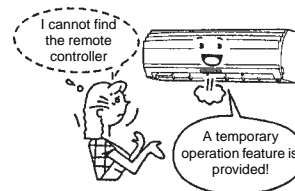

### INFORMATION

Do not hold down the RESET button for more than 3 seconds. (☞ see page 18.)

## CLEANING OPERATION

### Cleaning operation

This function is used to dry the inside of the air conditioner to reduce the growth of mold, etc. inside the air conditioner.

- When the unit shuts down after having operated for 10 or more minutes in the cooling or dry mode, the cleaning operation is started automatically, and the S.CLEAN indicator on the unit's display panel turns on.

### Cleaning operation duration

- The cleaning operation lasts for 4 hours if the unit has been operating in the cooling or dry mode for 10 minutes or more.

### About the cleaning operation

- The cleaning operation will not make the room cleaner or remove the mold and dust already inside the air conditioner.
- During operation, a small amount of frost may be visible: this is normal and does not indicate a malfunction.
- The vertical airflow louvers and moving panel open slightly.
- If an ongoing cleaning operation is suspended, the effect of the cleaning will be compromised.
- To forcibly stop the cleaning operation, press the  button twice during the cleaning operation.

# USUAL MAINTENANCE

## ⚠ WARNING

Before you clean the air conditioner, be sure to turn off the circuit breaker or main power switch.

### Cleaning of indoor unit and remote controller

## CAUTION

- Use a dry cloth to wipe the indoor unit and remote controller.
- When the air conditioner is extremely dirty, use a cloth dipped in cold water to wipe the indoor unit.
- Never use a damp cloth on the remote controller.
- Do not use a chemical-based duster for wiping or leave such materials on the unit for extended periods of time. Doing so could damage or cause the surface of the unit to fade.
- Do not use benzine, thinner, polishing powder, or other solvents for cleaning. These can cause the plastic surface to crack or deform.

### When not using the unit for at least 1 month

- (1) Perform fan operation for 3 to 4 hours to dry the inside of the unit.
  - If a high temperature setting is used with cooling operation, fan operation is performed.
- (2) Stop the air conditioner and turn off the circuit breaker.
- (3) Clean the air filters.
- (4) Remove the batteries from the remote controller.

### Check before operation

## CAUTION

- Check that the air filters are installed.
- Check that the air outlet and inlet of the outdoor unit are not blocked.

### Cleaning the air filter

Clean the air filters every 2 weeks.

The performance of the air conditioner will degrade if the air filters are covered with dust.

Clean the air filters as often as possible.

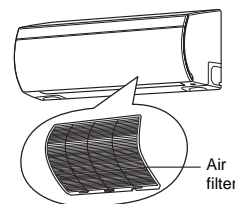
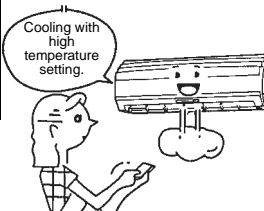
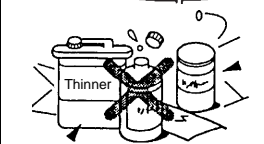

## Preparation:

- 1 Open the moving panel.  
Pull the handles on the bottom of the right and left sides, and open the moving panel until it is horizontal.

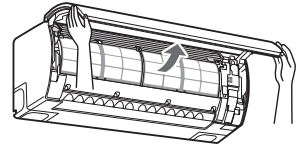

- 2 Be sure to always **grasp the handles** when opening the moving panel. (The moving panel cannot be removed.)

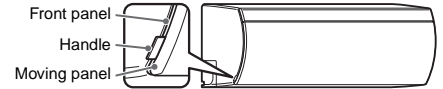

- 3 Support the moving panel with the panel support.  
Grasp the moving panel with your left hand, and use your right hand to pull up the panel support and fit it into the slot.

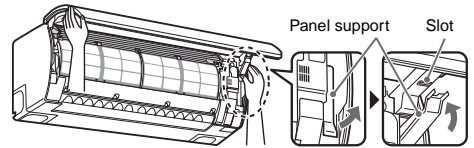

- 4 Remove the air filter.  
Lift the air filter knob, and pull it out to the front.

- 5 Use a vacuum cleaner to remove the dust from the filters or wash them with water. After washing the air filters, dry them in the shade.

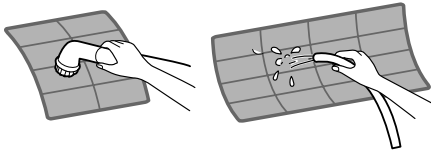

- 6 Insert the top section of the air filter so that its right and left edges fit on the indoor unit.

- 7 Close the moving panel.  
Grasp the moving panel with your left hand, and use your right hand to lower the panel support downward, and push on the two locations shown in the figure to close it. If the moving panel is opened, use the remote control to perform the start and stop operations. (The moving panel can be damaged if you try to close it with your hand while it is open.)





# AIR CONDITIONER OPERATION AND PERFORMANCE

## Three-minute protection feature

A protection feature is provided that prevents the air conditioner from being activated for approximately 3 minutes when it is restarted immediately after operation or when the power supply switch is set to on. This is used to protect the machine.

## Heating characteristics

### Preheating operation

The air conditioner does not deliver warm air immediately after it is started.

Warm air flows out after approximately 5 minutes when the indoor heat exchanger has warmed up.

### Warm air control

When the room temperature reaches the temperature setting, the fan indoor speed is automatically reduced.

The outdoor unit is stopped at this time.

### Defrosting

If frost has formed on the outdoor unit during the heating operation, defrosting is started automatically (for approximately 5 to 10 minutes) to maintain the heating effect.

- The fans in both the indoor and outdoor units stop during the defrost operation.
- During the defrost operation, defrosted water is drained from the bottom plate of the outdoor unit.

### Heating capacity

In the heating operation, heat is absorbed from outdoors and released into the room. That is called the heat pump system. When the outdoor temperature is too low, usage of another heating apparatus in combination with the air conditioner is recommended.

### Consideration for accumulated snow

Select the position for the outdoor unit where it will not be subjected to snow drifts, accumulation of leaves or other seasonal debris. It is important that the air flow of the outdoor unit is not blocked as this will result in reduced heating or cooling performance. During the heating mode and at sub-zero temperatures, the water drained off the outdoor unit as a result of the automatic defrost may accumulate and freeze. It is important that adequate drainage or a soak-way be provided.



## CAUTION

(RAS-\*\*\*-ND model only)

A heater is installed on the base plate of the outdoor unit. When the outside air temperature is low, the heater runs to warm the base plate even if the unit is not operating so that snow does not accumulate inside the outdoor unit. Do not use the supplied drain nipple for draining water. Drain the water from all the drain holes directly. Provide a space of at least 50 cm under the outdoor unit so that the draining water does not freeze and block the drain holes.

## Power failure

Power failure during operation stops the unit completely.

- The OPERATION indicator (green) on the indoor unit starts flashing when power is restored.
- To restart operation, push the  button on the remote controller.
- Lightning or a car wireless telephone operating nearby may cause the unit to malfunction. Turn the power supply switch off and then on again. Push the  button on the remote controller to restart.

## Air conditioner operating conditions

For proper performance, operate the air conditioner under the following temperature conditions.

Cooling operation	Outdoor temperature: $-10^{\circ}\text{C}$ to $46^{\circ}\text{C}$
	Room temperature: $21^{\circ}\text{C}$ to $32^{\circ}\text{C}$
	<b>CAUTION</b> Room relative humidity — less than 80%. If the air conditioner operates outside this range, the surface of the air conditioner may attract condensation.
Heating operation	Outdoor temperature: $-15^{\circ}\text{C}$ to $24^{\circ}\text{C}$
	Room temperature: Less than $28^{\circ}\text{C}$
Dry operation	Outdoor temperature: $-10^{\circ}\text{C}$ to $46^{\circ}\text{C}$
	Room temperature: $21^{\circ}\text{C}$ to $32^{\circ}\text{C}$
8°C Heating	Setting temperature: $5^{\circ}\text{C}$ to $13^{\circ}\text{C}$

If the air conditioner is used in conditions other than above, the safety protection functions may be activated.

# TROUBLESHOOTING

## CAUTION

If any of the following conditions occur, stop the air conditioner immediately, turn off the main power switch and contact the dealer.

- The indicators flash at short intervals (5 Hz). Reset the circuit breaker 2 to 3 minutes after the power main switch is turned off. Despite the resetting operation, the indicators still continue turning on and off.
- The main power fuse often blows, or the circuit breaker is often activated.
- Foreign matter or water has fallen inside the air conditioner.
- Any other unusual conditions are observed.

Before asking for servicing or repairs, check the following points.

### Inoperative

- The power main switch is turned off.
- The circuit breaker is activated to cut off the power supply.
- The main power fuse has blown.
- The electric current has stopped.
- The batteries in the remote controller used up.
- The ON timer is set.
- As a protective mechanism for the air conditioner, it does not operate for 3 minutes immediately after restarting operation or turning on the main power.

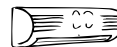

### Poor cooling or heating performance

- The air inlet or outlet of the outdoor unit is blocked.
- Doors or windows are opened.
- The air filter is clogged with dust.
- The louver is not at the correct position.
- The fan speed is set to low.
- The air conditioner is set to the DRY or SLEEP MODE.
- The temperature setting is too high (during cooling operation).
- The temperature setting is too low (during heating operation).
- Is the air conditioner being used outside its operating conditions? (☞ see page 23.)
- The protective device may be activated if there is a change in voltage, the air inlet is blocked, or other condition causes an excessive load on the machine.



Remove the cause of the problem, and after about 30 seconds, turn on the circuit breaker again.

Recheck

Before asking for servicing or repairs, check the following points.

**Condensation forms on the back of the indoor unit.**

- Condensation on the back of the indoor unit is automatically collected and drained out.



**Indoor unit or outdoor unit makes a strange noise.**

- When the temperature changes sharply, the indoor or outdoor unit may make a strange noise (such as a tit-tack noise or flowing noise) because of the expansion/contraction of parts or change in refrigerant flow.

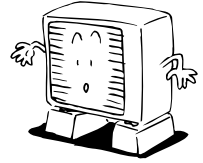

**The room air smells.**

**A bad odor comes from the air conditioner.**

- Smells absorbed in the wall, carpet, furniture, clothing, or furs are coming out.
- During PURE operation, a small amount of ozone is produced, and you might notice the smell.

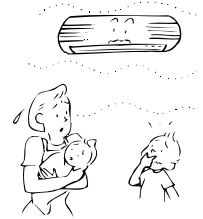

**The OPERATION indicator turns on and off.**

- The indicator turns on and off (1 Hz) when power is restored after a power failure or when the power main switch is set to on.



**Frost forms on the outdoor unit during heating operation.**

**Water is drained from the outdoor unit.**

- Frost sometimes forms on the outdoor unit during heating operation. In that case, the unit automatically performs defrosting (for 2 to 10 minutes) for improving the heating efficiency.
- In the defrosting operation, the airflow from both the indoor and outdoor units stops.
- A hiss sound is heard when the flow of the refrigerant is changed for defrosting.
- The water resulting from automatic defrosting during the heating operation is drained from the outdoor unit.

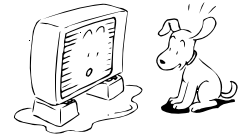

**The air flow changes even though the FAN button is not set to the AUTO mode.**

- When the temperature of the blown air goes down during heating operation, the air conditioner automatically changes or stops the air flow from the indoor unit so that the people in the room do not feel chilly.

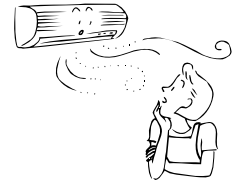

**A white mist of chilled air or water is generated from the outdoor unit.**

- Steam is sometimes generated from the indoor unit during cooling operation or the outdoor unit during defrosting operation.

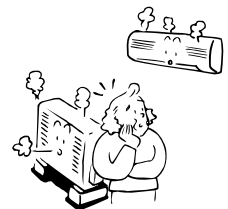

**Automatic operation of vertical air flow louvers**

- When the room temperature or outdoor temperature is high during the heating operation, the vertical air flow louvers close once and then set themselves automatically to the original position setting again.



These are not defects.

Before asking for servicing or repairs, check the following points.

**The PURE indicator (Orange) turns on.**

- The indicator may turn on if the moving panel is not firmly closed.

**Sounds made from the indoor unit**

- The ion charger unit may make a humming, clicking, or buzzing sound during electrical air purifying or cleaning operation.
- When the power is turned on or the air conditioner is stopped, the vertical air flow louvers may make a rattling sound or shuttling sound.
- Some parts may expand or shrink due to temperature fluctuations, and this can result in a slapping sound.
- When the refrigerant is flowing, a hissing sound or gurgling sound can result.
- A hissing sound can be made when the air conditioner is switched to defrosting operation during heating operation.
- An operation sound is made when the moving panel is opened and closed.





**Sounds made from the outdoor unit**

- A rustling sound can be made when the air conditioner is switched to defrosting operation during heating operation.



These are not defects.

# TROUBLESHOOTING (Remote Controller)

Before asking for servicing or repairs, check the following points.

The remote controller does not operate correctly.		
Symptoms	Causes	Possible Solution
The operating mode switches.	<ul style="list-style-type: none"> <li>Check whether the MODE indicated on the display is AUTO.</li> </ul> <p style="text-align: center;"><b>AUTO</b></p>	The fan speed and louver direction cannot be changed in AUTO mode. When the SWING, FIX or FAN buttons are pressed in AUTO mode, the mode changes to A mode.
The fan speed cannot be changed.	<ul style="list-style-type: none"> <li>Check whether the MODE indicated on the display is : DRY.</li> </ul> <p style="text-align: center;"> : <b>DRY</b></p>	When dry operation is selected, the air conditioner automatically selects the fan speed. The fan speed can be selected during  COOL and  HEAT.

The Display Goes Off		
Symptoms	Causes	Description
The indicators on the display are not shown after a short time.	<ul style="list-style-type: none"> <li>Check whether the timer operation is over when the OFF TIMER is shown on the display.</li> </ul>	The air conditioner stops since the setting time has elapsed.
The TIMER display turns off after a certain period of time.	<ul style="list-style-type: none"> <li>Check whether the timer operation has started when the ON TIMER is shown on the display.</li> </ul> <p style="text-align: center;"> : <b>ON</b></p>	When the time reaches the time setting for the ON timer operation, the air conditioner starts to operate automatically and the ON timer display turns off.

The Signal Receiving Tone Does Not Sound		
Symptoms	Causes	Description
No receiving tone is made from the indoor unit even when the  button is pushed.	<ul style="list-style-type: none"> <li>Check whether the infrared signal transmitter of the remote controller is properly pointed towards the receiver of the indoor unit when the  button is pushed.</li> </ul>	Point the infrared signal transmitter of the remote controller towards the receiver of the indoor unit, and then press the  button repeatedly.

# SPECIFICATIONS

Type		Reverse cycle, Split type			
Model		Indoor Unit	Outdoor Unit	Indoor Unit	Outdoor Unit
		RAS-07PKVP-E RAS-07PKVP-ND	RAS-07PAVP-E RAS-07PAVP-ND	RAS-10PKVP-E RAS-10PKVP-ND	RAS-10PAVP-E RAS-10PAVP-ND
Power supply		220–240 V ~50 Hz 220–230 V ~60 Hz		220–240 V ~50 Hz 220–230 V ~60 Hz	
Cooling capacity	(kW) CAPA.	2.0		2.5	
Heating capacity	(kW) CAPA.	2.5		3.0	
Cooling current	(A) AMP.	0.21–0.19	1.86–1.70	0.21–0.19	2.19–2.01
Cooling power	(W) WATT.	25	330	25	450
Heating current	(A) AMP.	0.21–0.19	2.35–2.15	0.21–0.19	2.56–2.35
Heating power	(W) WATT.	25	415	25	535
Dimensions	Width (mm)	790	780	790	780
	Height (mm)	295	550	295	550
	Depth (mm)	242	290	242	290
Net weight	(kg)	12	39	12	39

Type		Reverse cycle, Split type			
Model		Indoor Unit	Outdoor Unit	Indoor Unit	Outdoor Unit
		RAS-13PKVP-E RAS-13PKVP-ND	RAS-13PAVP-E RAS-13PAVP-ND	RAS-16PKVP-E RAS-16PKVP-ND	RAS-16PAVP-E RAS-16PAVP-ND
Power supply		220–240 V ~50 Hz 220–230 V ~60 Hz		220–240 V ~50 Hz 220–230 V ~60 Hz	
Cooling capacity	(kW) CAPA.	3.5		4.5	
Heating capacity	(kW) CAPA.	4.0		5.5	
Cooling current	(A) AMP.	0.24–0.22	3.44–3.15	0.27–0.25	5.54–5.08
Cooling power	(W) WATT.	30	740	35	1195
Heating current	(A) AMP.	0.24–0.22	3.77–3.46	0.27–0.25	5.97–5.47
Heating power	(W) WATT.	30	810	35	1305
Dimensions	Width (mm)	790	780	790	780
	Height (mm)	295	550	295	550
	Depth (mm)	242	290	242	290
Net weight	(kg)	12	40	12	40

Type		Reverse cycle, Split type	
Model		Indoor Unit	Outdoor Unit
		RAS-18PKVP-E RAS-18PKVP-ND	RAS-18PAVP-E RAS-18PAVP-ND
Power supply		220–240 V ~50 Hz 220–230 V ~60 Hz	
Cooling capacity	(kW) CAPA.	5.0	
Heating capacity	(kW) CAPA.	6.0	
Cooling current	(A) AMP.	0.30–0.28	6.68–6.12
Cooling power	(W) WATT.	40	1450
Heating current	(A) AMP.	0.30–0.28	6.86–6.29
Heating power	(W) WATT.	40	1500
Dimensions	Width (mm)	790	780
	Height (mm)	295	550
	Depth (mm)	242	290
Net weight	(kg)	12	40

• These specifications are subject to change without notice for the purpose of incorporating technical improvements.

The specified air-conditioning performance is based on the data determined under the following conditions.

**For cooling**

Air inlet temperature °C			
Indoor coil assembly		Outdoor coil assembly	
Dry bulb	Wet bulb	Dry bulb	Wet bulb
27	19	35	24

**For heating**

Air inlet temperature °C			
Indoor coil assembly		Outdoor coil assembly	
Dry bulb	Wet bulb	Dry bulb	Wet bulb
20	—	7	6

<b>Information according to EMC Directive 2004/108/EC</b>	
(Name of the manufacturer)	<b>TOSHIBA CARRIER CORPORATION</b>
(Address, city, country)	336 Tadehara, Fuji-shi, Shizuoka-ken, 416-8521 Japan
(Name of the Importer / Distributor in EU)	Toshiba Carrier UK Ltd.
(Address, city, country)	Porsham Close, Belliver Industrial Estate, PLYMOUTH, Devon, PL6 7DB. United Kingdom

**TOSHIBA CARRIER CORPORATION**



## Free Manuals Download Website

<http://myh66.com>

<http://usermanuals.us>

<http://www.somanuals.com>

<http://www.4manuals.cc>

<http://www.manual-lib.com>

<http://www.404manual.com>

<http://www.luxmanual.com>

<http://aubethermostatmanual.com>

Golf course search by state

<http://golfingnear.com>

Email search by domain

<http://emailbydomain.com>

Auto manuals search

<http://auto.somanuals.com>

TV manuals search

<http://tv.somanuals.com>