

TOSHIBA

Blu-ray Disc Player BDX2000KC

OWNER'S MANUAL



- INTRODUCTION
- CONNECTIONS
- PLAYBACK
- FUNCTION SETUP
- OTHERS

Owner's Record

The model number and serial number are on the back of this unit. Record these numbers in the spaces below. Refer to these numbers whenever you communicate with your Toshiba dealer about this unit.

Model number:

Serial number :

INTRODUCTION

Safety Instructions

WARNING: TO REDUCE THE RISK OF FIRE OR ELECTRIC SHOCK, DO NOT EXPOSE THIS APPARATUS TO RAIN OR MOISTURE.



CAUTION
RISK OF ELECTRIC SHOCK
DO NOT OPEN

CAUTION:

TO REDUCE THE RISK OF ELECTRIC SHOCK, DO NOT REMOVE COVER (OR BACK). NO USER SERVICEABLE PARTS INSIDE. REFER SERVICING TO QUALIFIED SERVICE PERSONNEL.

The important note is located on the rear or bottom of the cabinet.



The lightning flash with arrowhead symbol, within an equilateral triangle, is intended to alert the user to the presence of uninsulated "dangerous voltage" within the product's enclosure that may be of sufficient magnitude to constitute a risk of electric shock to persons.



The exclamation point within an equilateral triangle is intended to alert the user to the presence of important operating and maintenance (servicing) instructions in the literature accompanying the appliance.



The symbol for CLASS II (Double Insulation)

IMPORTANT SAFETY INSTRUCTIONS

1. Read these instructions.
2. Keep these instructions.
3. Heed all warnings.
4. Follow all instructions.
5. Do not use this apparatus near water.
6. Clean only with dry cloth.
7. Do not block any ventilation openings. Install in accordance with the manufacturer's instructions.
8. Do not install near any heat sources such as radiators, heat registers, stoves, or other apparatus (including amplifiers) that produce heat.
9. Do not defeat the safety purpose of the polarized or grounding-type plug. A polarized plug has two blades with one wider than the other. A grounding type plug has two blades and a third grounding prong. The wide blade or the third prong are provided for your safety. If the provided plug does not fit into your outlet, consult an electrician for replacement of the obsolete outlet.
10. Protect the power cord from being walked on or pinched particularly at plugs, convenience receptacles, and the point where they exit from the apparatus.
11. Only use attachments/accessories specified by the manufacturer.
12. Use only with the cart, stand, tripod, bracket, or table specified by the manufacturer, or sold with the apparatus. When a cart is used, use caution when moving the cart/apparatus combination to avoid injury from tip-over. 
13. Unplug this apparatus during lightning storms or when unused for long periods of time.
14. Refer all servicing to qualified service personnel. Servicing is required when the apparatus has been damaged in any way, such as power-supply cord or plug is damaged, liquid has been spilled or objects have fallen into the apparatus, the apparatus has been exposed to rain or moisture, does not operate normally, or has been dropped.

Additional Safety Instructions

15. Do not overload wall outlets; extension cords, or integral convenience receptacles as this can result in a risk of fire or electric shock.
16. Apparatus shall not be exposed to dripping or splashing and no objects filled with liquids, such as vases, shall be placed on the apparatus.
17. Keep your fingers well clear of the disc tray as it is closing. Neglecting to do so may cause serious personal injury.
18. Do not place a heavy object on or step on the apparatus. The object may fall, causing serious personal injury and serious damage to the apparatus.
19. Do not use a cracked, deformed, or repaired disc. These discs are easily broken and may cause serious personal injury and apparatus malfunction.
20. If the apparatus should smoke or smell, immediately disconnect the power cord from the wall outlet. Wait until the smoke or smell stops, then ask your dealer for a check and repair. Neglecting to do so may cause fire.
21. While it is thundering, do not touch the connecting cables or the apparatus.
22. Warning: To prevent the spread of fire, keep candles or other open flames away from this product at all times.
23. Disconnect the mains plug to shut off when find trouble or not in use. The mains plug shall remain readily operable.

INTRODUCTION

FCC WARNING

This equipment may generate or use radio frequency energy. Changes or modifications to this equipment may cause harmful interference unless the modifications are expressly approved in the manual. The user could lose the authority to operate this equipment if an unauthorized change or modification is made.

RADIO-TV INTERFERENCE

This equipment has been tested and found to comply with the limits for a Class B digital device, pursuant to Part 15 of the FCC Rules. These limits are designed to provide reasonable protection against harmful interference in a residential installation. This equipment generates, uses, and can radiate radio frequency energy and, if not installed and used in accordance with the instructions, may cause harmful interference to radio communications. However, there is no guarantee that interference will not occur in a particular installation. If this equipment does cause harmful interference to radio or television reception, which can be determined by turning the equipment off and on, the user is encouraged to try to correct the interference by one or more of the following measures:

- 1) Reorient or relocate the receiving antenna.
- 2) Increase the separation between the equipment and receiver.
- 3) Connect the equipment into an outlet on a circuit different from that to which the receiver is connected.
- 4) Consult the dealer or an experienced radio/TV technician for help.

This Class B digital apparatus complies with Canadian ICES-003.

ALWAYS plug the product into an outlet that is located in such a manner that it can be easily unplugged in case the product requires service.

CAUTION: Danger of explosion if battery is incorrectly replaced. Replace only with the same or equivalent type.

WARNING: Batteries (Battery pack or battery installed) shall not be exposed to excessive heat such as sunshine, fire, or the like.

LASER SAFETY

This apparatus employs a laser. Only a qualified service person should remove the cover or attempt to service this apparatus, due to possible eye injury.

CAUTION: Use of controls or adjustments or performance of procedures other than those specified herein may result in hazardous radiation exposure.

CAUTION: Visible and invisible laser radiation when open and interlocks defeated. Do not stare into beam.

LOCATION: Inside, near the deck mechanism.

IMPORTANT COPYRIGHT INFORMATION

Unauthorized copying, broadcasting, public performance and lending of discs are prohibited. This product incorporates copyright protection technology that is protected by U.S. patents and other intellectual property rights. Use of this copyright protection technology must be authorized by Macrovision, and is intended for home and other limited viewing uses only unless otherwise authorized by Macrovision. Reverse engineering or disassembly is prohibited.

Do not place the unit on the furniture that is capable of being tilted by a child and an adult leaning, pulling, standing or climbing on it. A falling unit can cause serious injury or even death.

To Avoid the Hazards of Electrical Shock and Fire

- Do not handle the AC power cord with wet hands.
- Do not pull on the AC power cord when disconnecting it from an AC outlet. Grasp it by the plug.
- Do not put your fingers or objects into the unit.

Location and Handling

- Do not install the unit in direct sunlight, near strong magnetic fields, or in a place subject to dust or strong vibration.
- Avoid a place with drastic temperature changes.
- Install the unit in a horizontal and stable position. Do not place anything directly on top or bottom of the unit. Depending on your external devices, noise or disturbance of the picture and/or sound may be generated if the unit is placed too close to them. In this case, please ensure enough space between the external devices and the unit.
- Depending on the environment, the temperature of this unit may increase slightly. This is not a malfunction.
- Be sure to remove the disc and unplug the AC power cord from the outlet before carrying the unit.

Dew Condensation Warning

- Dew condensation may form inside the unit in the following conditions. If so, do not use this unit at least for a few hours until its inside gets dry.
 - The unit is moved from a cold place to a warm place.
 - Under conditions of high humidity.
 - After heating a cold room.

INTRODUCTION

CONNECTIONS

PLAYBACK

FUNCTION SETUP

OTHERS

INTRODUCTION

Note about Recycling

- This unit's packaging materials are recyclable and can be reused. Please dispose of any materials in accordance with your local recycling regulations.
- Batteries should never be thrown away or incinerated but disposed of in accordance with your local regulations concerning chemical wastes.



Notice for Progressive Scan Output

- Consumers should note that not all high definition television sets are fully compatible with this product and may cause artifacts to be displayed in the picture. In case of picture problems with 525(480) progressive scan output, it is recommended that the user switch the connection to the 'standard definition' output. If there are questions regarding your TV set compatibility with this 525p(480p) BD/DVD player, please contact Toshiba Customer Service.



Products that earn the ENERGY STAR® prevent greenhouse gas emissions by meeting strict energy efficiency guidelines set by the U.S. Environmental Protection Agency and the U.S. Department of Energy. ENERGY STAR and the ENERGY STAR mark are registered U.S. marks.

MPEG Layer - 3 audio coding technology licensed from Fraunhofer IIS and Thomson.

Because of problems and errors that can occur during the creation of DVD and CD software and / or the manufacture of DVD and CD discs, Toshiba cannot assure that this Blu-ray Disc Player will successfully play every disc bearing the DVD and CD logos. If you happen to experience any difficulty playing a DVD and / or CD disc on this Blu-ray Disc Player, please contact Toshiba Customer Service.

Supplied Accessories

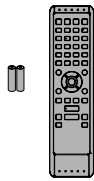

remote control with
batteries (AAx2)

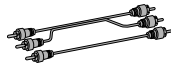

composite audio / video
cables

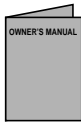

owner's manual (EN/FR)



quick start guide (EN/FR)

Symbols Used in this Manual

To specify for which media type each function is, we put the following symbols at the beginning of each item to operate.

Symbol	Description
	Description refers to BD-video and BD-RE (ver.2.1) / BD-R (ver.1.1/1.2/1.3) recorded in BDMV format
	Description refers to DVD-video
	Description refers to audio CD / DTS-CD
	Description refers to DVD-RW/-R and SD Memory Card with AVCHD files
	Description refers to BD-RE/-R, DVD-RW/-R, CD-RW/-R and SD Memory Card with MP3 files
	Description refers to BD-RE/-R, DVD-RW/-R, CD-RW/-R and SD Memory Card with Windows Media™ Audio files
	Description refers to BD-RE/-R, DVD-RW/-R, CD-RW/-R and SD Memory Card with JPEG files

If you do not find any of the symbols listed above under the function heading, the operation is applicable to all media.

INTRODUCTION

Trademark Information



HDMI, the HDMI logo and High-Definition Multimedia Interface are trademarks or registered trademarks of HDMI Licensing LLC.



Manufactured under license from Dolby Laboratories. Dolby and the double-D symbol are trademarks of Dolby Laboratories.



Manufactured under license under U.S. Patent #'s: 5,451,942; 5,956,674; 5,974,380; 5,978,762; 6,226,616; 6,487,535; 7,392,195; 7,272,567; 7,333,929; 7,212,872 & other U.S. and worldwide patents issued & pending. DTS is a registered trademark and the DTS logos, Symbol, DTS-HD and DTS-HD Master Audio | Essential are trademarks of DTS, Inc. ©1996-2008 DTS, Inc. All Rights Reserved.

x.v.Color

"x.v.Color" and "x.v.Color" logo are trademarks of Sony Corporation.

"Blu-ray Disc" and  are trademarks.

 is a trademark of DVD Format/Logo Licensing Corporation.



"AVCHD" and the "AVCHD" logo are trademarks of Panasonic Corporation and Sony Corporation.



"BONUSVIEW" is trademark of Blu-ray Disc Association.



"BD-LIVE" logo is trademark of Blu-ray Disc Association.



Java and all other Java trademarks and logos are trademarks or registered trademarks of Sun Microsystems, Inc. in the United States and/or other countries.



Windows Media and the Windows logo are trademarks or registered trademarks of Microsoft Corporation in the United States and/or other countries.



is trademark of Eastman Kodak Company.

INTRODUCTION

CONNECTIONS

PLAYBACK

FUNCTION SETUP

OTHERS

INTRODUCTION

Content

INTRODUCTION

Safety Instructions	2
Supplied Accessories	4
Symbols Used in this Manual	4
Trademark Information	5
Features	7
Front Panel	8
Rear Panel	8
Remote Control	9
Front Panel Display	11

CONNECTIONS

Connection to the TV	12
Connection to an Audio System	14
Network Connection with LAN	15
Finding the Video Channel on Your TV	16

PLAYBACK

Information on Playback	17
How to Insert a Disc	20
Reading an SD Memory Card	20
Selecting the Media	21
Playing Back (BD, DVD or a Disc with AVCHD files)	22
Playing Back (Audio CD or a Disc with MP3/ Windows Media™ Audio/JPEG Files)	23
Kodak Picture CD	24
Fast Forward / Fast Reverse	25
Slow Motion Playback	25
Step by Step Playback	26
Repeat Playback	26
A-B Repeat	26
Program Playback	26
Random Playback	27
Rapid Playback	28
Adjusting the Picture	28
Virtual Surround	28
PIP (BONUSVIEW) Setting	29
Camera Angle	29
Enjoying BD-Live Discs with Online Content	29
Search	30
Switching Subtitles	31
Switching Audio Soundtrack	31
Setting the BD Audio Mode	32

FUNCTION SETUP

Using the Setup Menu	33
Quick	33
Custom	34
Language	35
Video	36
Audio	38
Parental	43
Others	44
Network Connection	46
Connection Test	46
Enable(Easy)	46
Enable(Custom)	46
Disable	49
Software Update	49
Current Version	49
Disc Update	49
Initialize	50

OTHERS

Troubleshooting	51
Glossary	53
Language Code List	55
Specifications	56
Maintenance	57
LIMITED WARRANTY	58

INTRODUCTION

Features

Blu-ray Disc

You can enjoy Blu-ray Disc which is capable of storing five times more data than a conventional DVD.

BD-Java

With some BDs which support Java applications, you can enjoy the interactive functions such as games or interactive menus.

BD-Live

BD-Live (BD-ROM version 2 Profile 2.0) that allows interactive functions to be used when this unit is connected to the Internet in addition to the BONUSVIEW function. The various functions differ depending on the disc.

Full high-definition video playback

Watch movies in the highest picture quality available for your HDTV. This unit offers full high-definition video playback up to 1080p resolution for an amazing viewing experience. A highly detailed picture and increased sharpness delivers a more true-to-life picture.

DVD Upconversion for enhanced picture quality

Your current DVD will look even better than before thanks to video upconversion. Upconversion will increase the resolution of standard definition DVD to high definition up to 1080p over an HDMI connection. The picture will be less jagged and more realistic for a near high-definition experience.

Enjoy your content on different kinds of media

Full backwards compatibility with BD, DVD, CD and SD card ensures that you can continue to enjoy your current audio-video collection. Additionally, you can view JPEG digital pictures or listen to MP3 or Windows Media™ Audio music files.

Experience rich multi-channel surround sound

Multi-channel surround sound, which recognizes real-to-life sound and makes you feel like you are really there.

PIP (BONUSVIEW)

Some BD-videos have the PIP function which enables you to display the secondary video in the primary video. You can call up the secondary video by pressing [PIP] whenever the scene contains the secondary video.

Pop-up menu

Some BD-video have pop-up menu which is a navigation menu that can be called up and be operated on the TV screen without interrupting the playback. You can call up the pop-up menu by pressing [POP MENU / MENU]. Contents in the pop-up menu vary depending on the disc.

Rapid playback

Playback in slightly faster speed while keeping the sound output. Rapid playback is available only on discs recorded in the Dolby Digital format.

Playback of Content from an SD Memory Card

You can play back AVCHD / MP3 / WMA / JPEGs stored in an SD Memory Card. You can store picture-in-picture commentary, subtitles or other extras for BD-ROM ver. 2 (Profile 2.0 / Profile 1.1) files in an SD Memory Card and play back with the BD-video.

Playing back AVCHD files

This unit supports playback of AVCHD format files (new format for high definition video camcorders) recorded on disc/SD card. Your high definition personal archive is playable in HD quality.

x.v.Color

This unit supports playback of video contents on discs recorded with "x.v.Color" technology. To watch this video content with the "x.v.Color", a TV or other display device supporting both video image reproduction using the "x.v.Color" standard and capable of manually switching it's color setting is required. Please refer to the owner's manual of your display device for further information.

Easy and simple connection to your HDTV via HDMI

Connect this unit to your HDTV with one single HDMI (High-Definition Multimedia Interface) cable. It is recommended to use a High Speed HDMI Cable for optimal compatibility. The high definition video output signal will be transferred to your HDTV without conversion to analog signals, so you will get excellent picture and sound quality, completely free from noise.

Thanks to other multiple outputs, you can also easily connect to your home theater system or amplifier.

HDMI Deep Color

Deep Color reduces the posterization effect of the playback image. Refer to "HDMI Deep Color" in "FUNCTION SETUP" on page 36.

HDMI CEC (Consumer Electronics Control)

This unit supports HDMI CEC, which allows integrated system control over HDMI and is part of the HDMI standard. This function may not work properly on some devices.

HDMI 1080p24 output (BD only)

This unit is equipped with a feature which can provide the smooth movement in the playback of film originated material with the frame rate of 24 frames per second with progressive scan. (Available only when the TV is connected by an HDMI cable and compatible with 1080p24 frame input.) Refer to "HDMI Video Resolution" in "FUNCTION SETUP" on page 36.

Copyright protection system

To play back the digital video images of a BD / DVD via an HDMI connection, it is necessary that both the unit and the TV (or an AV amplifier) support a copyright protection system called HDCP (high-bandwidth digital content protection system). HDCP is copy protection technology that comprises data encryption and authentication of the connected AV device. This unit supports HDCP. Please read the operating instructions of your TV (or AV amplifier) for more information.

INTRODUCTION

Front Panel

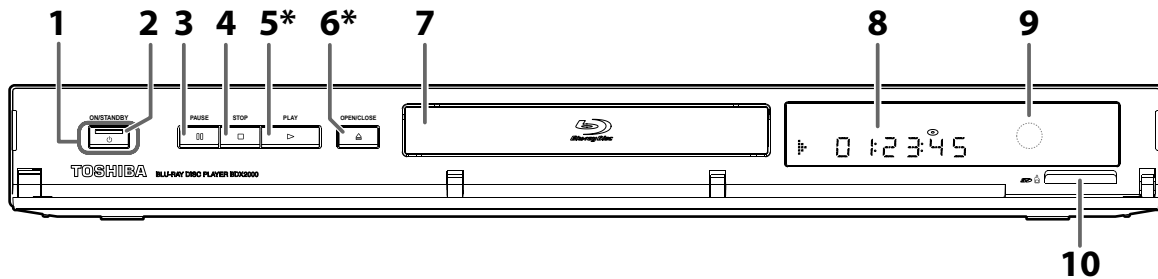

(*) The unit can also be turned on by pressing these buttons.

1. **ON/STANDBY** **button**
 - Press to turn on the unit, or to turn the unit into the standby mode. (To completely turn off the unit, you must unplug the AC power cord.)
2. **ON/STANDBY** **indicator**
3. **PAUSE** **button**
4. **STOP** **button**
5. **PLAY** **button***
6. **OPEN/CLOSE** **button***
7. **Disc tray**
8. **Display**
 - Refer to "Front Panel Display" on page 11.
9. **Infrared sensor window**
10. **SD card slot**

Rear Panel

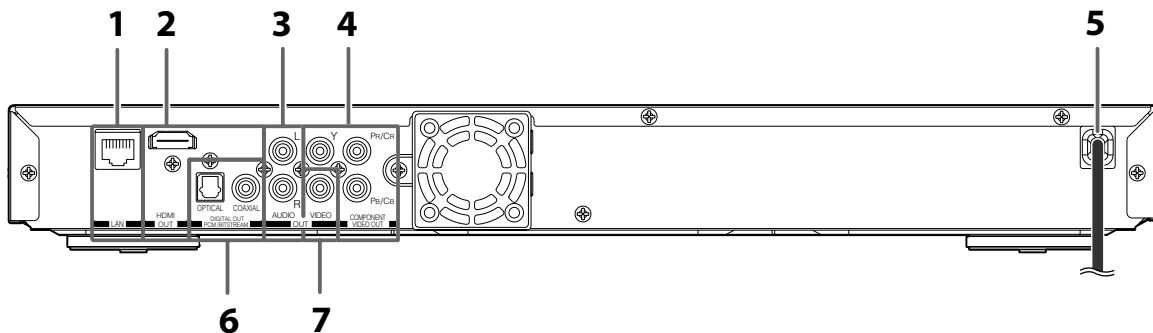

1. **LAN terminal**
 - Use to connect a network equipment with LAN cable.
2. **HDMI OUT jack**
 - Use to connect a TV with an HDMI compatible port using an HDMI cable.
3. **AUDIO OUT jacks**
 - Use to connect a TV, an AV receiver / amplifier or other device with a composite audio cable.
4. **COMPONENT VIDEO OUT jacks**
 - Use to connect a TV with component video inputs with a component video cable.
5. **AC power cord**
 - Connect to a standard AC outlet to supply power to this unit.
 - Unplug this cord from the AC outlet to completely turn off the unit.
6. **DIGITAL OUT (OPTICAL / COAXIAL) jacks**
 - Use to connect an AV receiver / amplifier, Dolby Digital / DTS decoder or other device with a digital audio optical / coaxial input jack with a digital audio optical / coaxial cable.
7. **VIDEO OUT jack**
 - Use to connect a TV, an AV receiver or other device with a composite video cable.

Note

- Do not touch the inner pins of the jacks on the rear panel. Electrostatic discharge may cause permanent damage to the unit.

INTRODUCTION

Remote Control

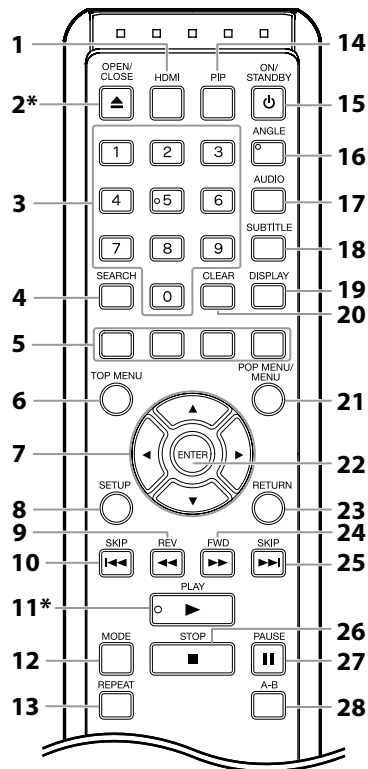

(*) The unit can also be turned on by pressing these buttons.

1. HDMI button

- Press to set the HDMI output mode.

2. OPEN/CLOSE ▲ button*

- Press to open or close the disc tray.

3. Number buttons

- Press to enter the title, chapter, track or file number.
- Press to enter values in the input field.

4. SEARCH button

- Press to display the search menu.

5. RED / GREEN / BLUE / YELLOW button

- Press to select items on some BD contents.
- When file list / thumbnail list is shown, press to switch between pages.

6. TOP MENU button

- Press to display the top menu.

7. ▲ / ▼ / ◀ / ▶ buttons

- Press to select items or settings.

8. SETUP button

- Press to display the setup menu.

9. REV ◀◀ button

- During playback, press to fast reverse the playback.

10. SKIP ◀◀ button

- During playback, press once to return to the beginning of the current title, chapter, track or file.
- During playback, press twice to return to the previous title, chapter, track or file.
- During the JPEG playback, press to return to the previous file.

11. PLAY ▶ button*

- Press to start playback or resume playback.

12. MODE button

- During BD, DVD or AVCHD playback, press to display the setting for the rapid playback and the picture adjustment.
- During BD, DVD, CD, AVCHD, MP3 and WMA playback, press to display the setting for the virtual surround.
- During BD playback, press to turn the picture-in-picture feature on or off (only applicable to BD-video which supports the PIP function).
- During the JPEG playback, press to display menus for changing the visual effect for switching the image or changing the size of the image.
- In stop mode with BD inserted, press to display a menu for setting the BD audio mode.
- In stop mode with audio CD or MP3 / WMA / JPEG files inserted, press to display menus for program and random playback.

13. REPEAT button

- Press to toggle between various repeat modes.

14. PIP button

- Press to switch picture-in-picture feature on or off (only applicable to BD-video which supports the PIP function).

15. ON/STANDBY ⏻ button

- Press to turn on the unit, or to turn the unit into the standby mode. (To completely turn off the unit, you must unplug the AC power cord.)

16. ANGLE button

- Press to access various camera angles on the disc.
- Press to rotate the JPEG files clockwise by 90 degrees.

17. AUDIO button

- Press to display the audio menu.

18. SUBTITLE button

- Press to display the subtitle menu.

19. DISPLAY button

- Press to display the on-screen display menu.

20. CLEAR button

- Press to clear the information once entered or to cancel the programming for audio CD, etc.

21. POP MENU / MENU button

- Press to display the pop-up menu / disc menu.

22. ENTER button

- Press to confirm or select menu items.

23. RETURN button

- Press to return to the previously displayed menu screen.

24. FWD ▶▶ button

- During playback, press to fast forward the playback.
- In pause mode, press to slow motion the playback.

25. SKIP ▶▶▶ button

- During playback, press to skip to the next title, chapter, track or file.

26. STOP ■ button

- Press to stop playback.

27. PAUSE || button

- Press to pause playback.
- When playback is in pause mode, press repeatedly to forward the playback step by step.

28. A-B button

- Press to play back a defined section between point A and B repeatedly.

INTRODUCTION

Installing the Batteries in the Remote Control

Install the batteries (AAx2) matching the polarity indicated inside battery compartment of the remote control.

1) Open the cover.

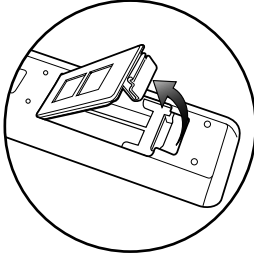

2) Insert batteries.

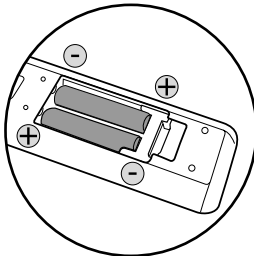

Make sure to match + and - on the batteries to the marks indicated in the battery compartment.

3) Close the cover.

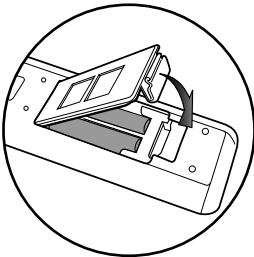

Note

Incorrect use of batteries can result in hazards such as leakage and bursting. Please observe the following:

- Do not mix new and old batteries together.
- Do not use different kinds of batteries together. Although they may look similar, different batteries may have different voltages.
- Make sure that the + and - ends of each battery match the indications in the battery compartment.
- Remove batteries from battery compartment that are not going to be used for a month or more.
- When disposing of used batteries, please comply with governmental regulations or environmental public rules that apply in your country or area. (Refer to page 4.)
- Do not recharge, short-circuit, heat, burn or disassemble batteries.

Using a Remote Control

Keep in mind the following when using the remote control:

- Make sure that there are no obstacles between the remote control and the infrared sensor window on the unit.
- Remote operation may become unreliable if strong sunlight or fluorescent light is shining on the infrared sensor window of the unit.
- Remote control for different devices can interfere with each other. Avoid using remote control for other device located close to the unit.
- Replace the batteries when you notice a fall off in the operating range of the remote control.
- The maximum operable ranges from the unit are as follows.
 - **Line of sight:** approx. 23 feet (7 m)
 - **Either side of the center:** approx. 16 feet (5 m) within 30°
 - **Above:** approx. 16 feet (5 m) within 15°
 - **Below:** approx. 10 feet (3 m) within 30°

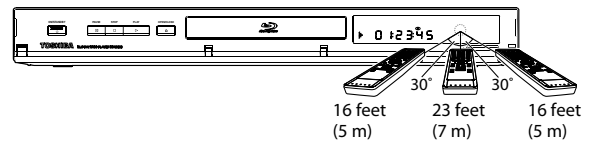

INTRODUCTION

Front Panel Display

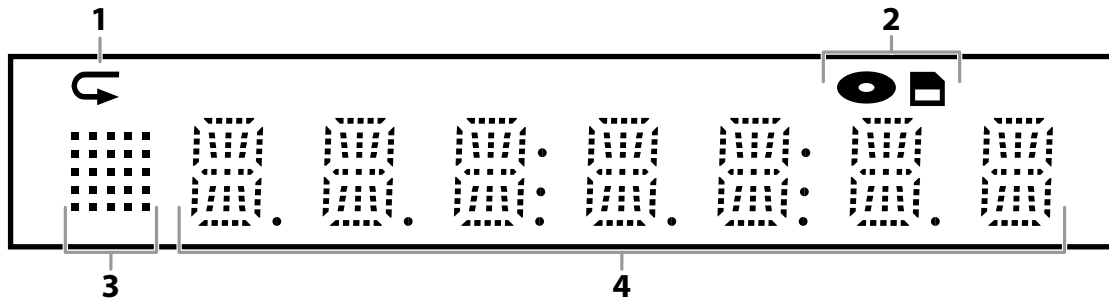

* Brightness of the display can be adjusted. Refer to "Panel Display" in "FUNCTION SETUP" on page 44.

1. Displays repeat icon. (Appears during repeat playback.)
2. Displays media icon (disc mode or SD card mode).
3. Displays playback status icon. Refer to the table below.
4. Displays various kinds of information such as title number, elapsed playing time, repeat type, menu type, etc.

Playback status icon	Mode
	Playback is in progress
	Stop mode
	Pause mode
	Fast forward mode
	Fast reverse mode
	Slow motion mode

Example of Display Message

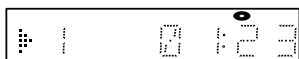

Title is being played back.
Indicating the current title number and the elapsed time.

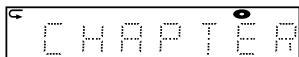

Current chapter is in chapter repeat mode.



Loading a disc.

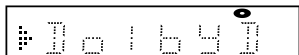

Dolby Digital audio is being played back.

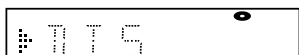

DTS audio is being played back.

CONNECTIONS

Connection to the TV

- 1 Choose the appropriate connection, then proceed to the corresponding instruction (A, B or C) on the next page.

Best (Supports up to 1080i / 1080p, 1080p24 resolution.)

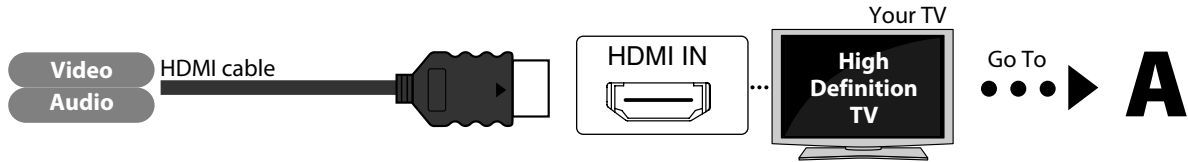

No analog audio connection required.

HDMI Cable NOT INCLUDED
High Speed HDMI Cable (also known as HDMI category 2 cable) is recommended for optimal compatibility.

Better (Supports up to 1080i resolution.)

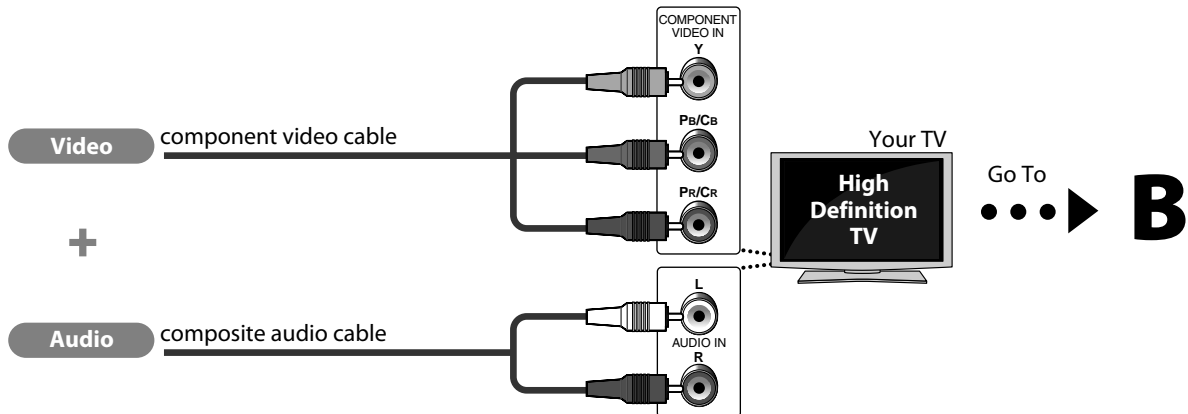

Component Video Cables NOT INCLUDED

Basic (Supports only 480i resolution.)

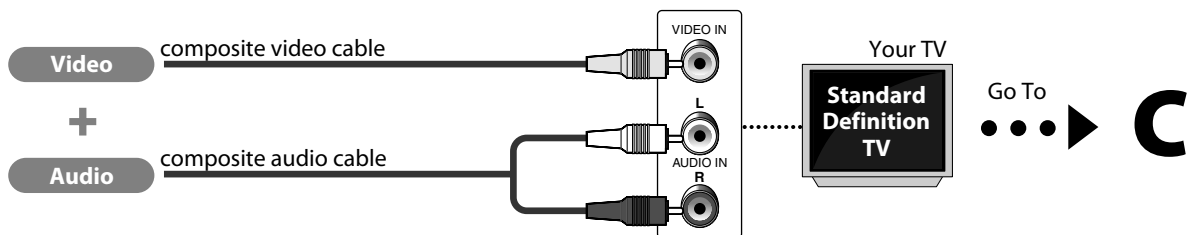

- Connect this unit directly to the TV. If the composite audio / video cables are connected to a VCR, pictures may be distorted due to the copy right protection system.

Composite Audio / Video Cables included

CONNECTIONS

2 Connect the cables by following the descriptions below.

HDMI Video / Audio Connection

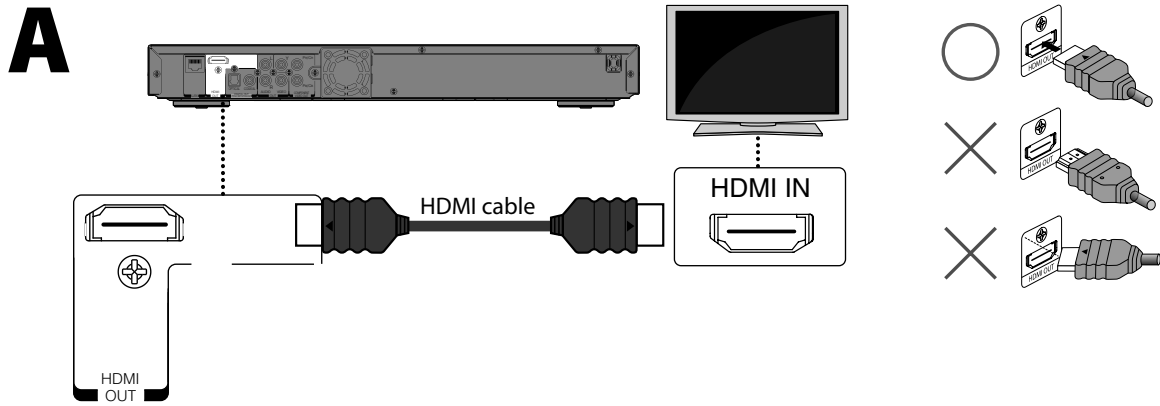

Note

- Do not tilt the connector when inserting it into the HDMI jack, and make sure the shapes of the jack and the connector are matched.
- When using non-HDCP compatible TV, the image may not display properly.

Component Video + Standard Audio Connection

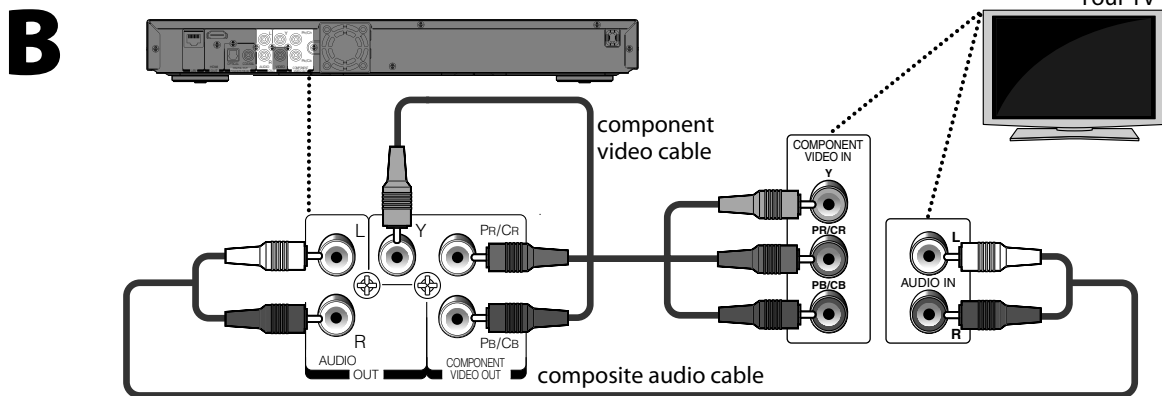

Standard Video + Standard Audio Connection

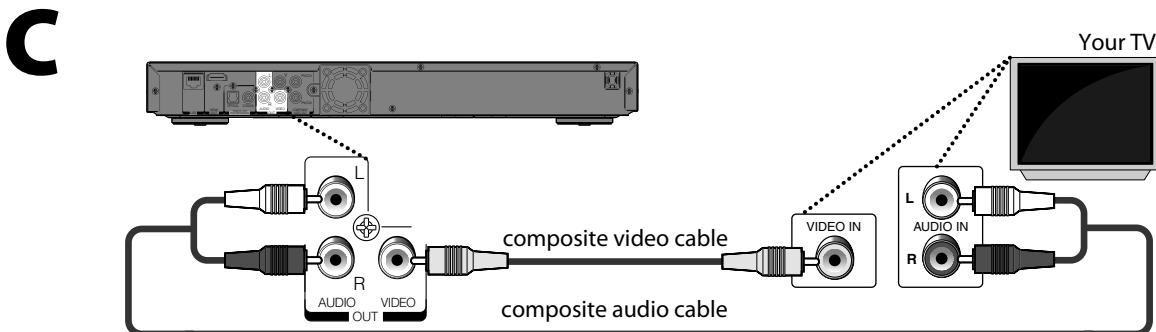

CONNECTIONS

Connection to an Audio System

- When you change the connections, all devices should be turned off.
- Refer to the manual accompanying external devices for more information.

2-Channel Analog Audio Connection

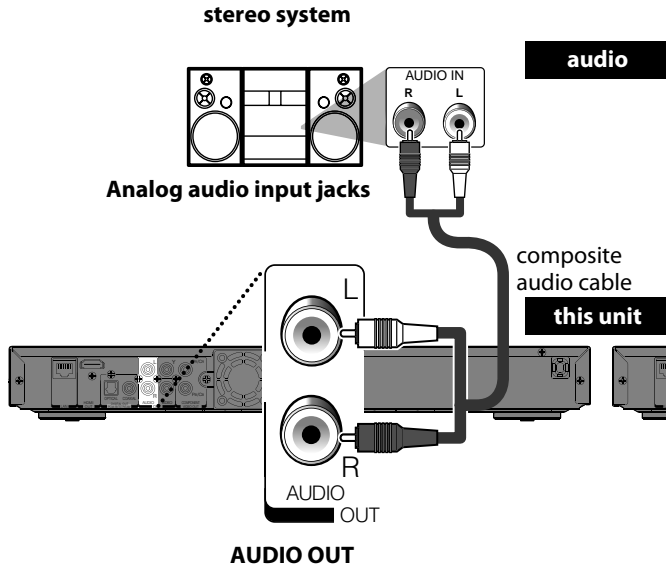

Digital Audio Connection

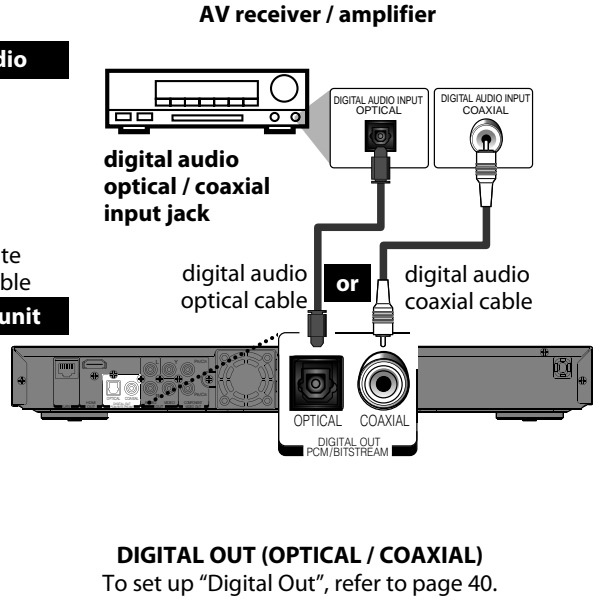

HDMI Audio Connection

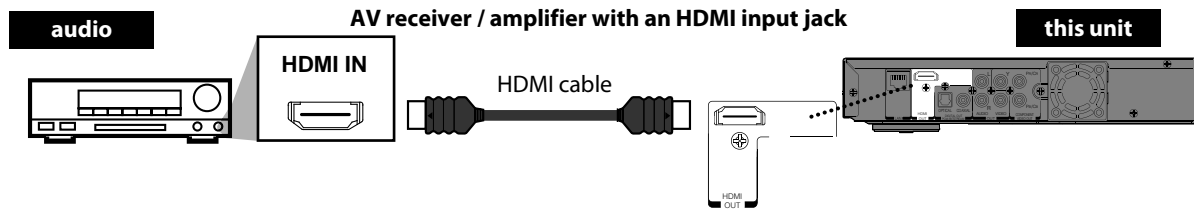

To set up "HDMI Audio Out", refer to pages 38 and 39.

Digital Audio Optical / Coaxial Cable and HDMI Cable NOT INCLUDED

CONNECTIONS

Network Connection with LAN

- You can use a disc which offers BD-Live function by connecting the unit to the Internet.
(For BD-Live information, please refer to page 29.)

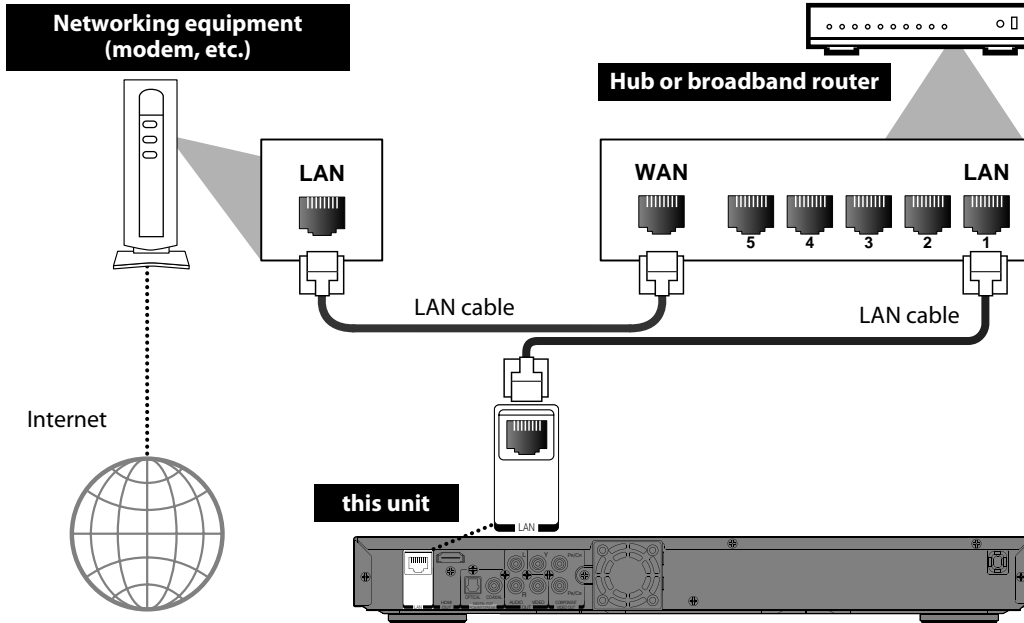

Networking Equipment, Hub or Broadband Router and Cables NOT INCLUDED

Note

- After connecting a LAN cable, set up necessary network settings.
- Do not insert any cable other than a LAN cable to the LAN terminal to avoid damaging the unit.
- If your network equipment (modem, etc.) does not have broadband router functions, connect a broadband router.
- If your network equipment (modem, etc.) has broadband router functions but there is no vacant port, use a hub.
- For a broadband router, use a router which supports 10BASE-T/100BASE-TX.
- Do not connect your PC directly to the LAN terminal of this unit.
- For the network setup, refer to "Network Connection" on pages 46-49.

CONNECTIONS

After you have completed all the connections, you must find the correct video channel (external input channel) on your TV.

Finding the Video Channel on Your TV

- 1** After you have made all the necessary connections, press [ON/STANDBY - 2** Turn on your TV.
- 3** Press the button on the TV's remote control that accesses the external input channel. It may be labeled "SOURCE", "AV" or "INPUT" (refer to your TV's user manual).



Note

- If the TV is connected by an HDMI cable, please allow a few moments for the opening screen to display.

PLAYBACK





Information on Playback

Before you start playing back a disc, read the following information.

Playable Discs and Files

This unit is compatible to play back the following discs / files. To play back a disc / file, make sure that it meets the requirements for region codes and color systems as described below. You can play back discs that have the following logos.

Other disc types are not guaranteed to play back.

Playable discs	Logos
Blu-ray Disc - BD-video (single / dual layer) - BD-RE ver. 2.1 (single / dual layer) (Recorded in BDMV format) - BD-R ver. 1.1 / 1.2 / 1.3 (single / dual layer) (Recorded in BDMV format) (Unclosed discs may not be played back.)	
DVD-video	
DVD-RW	
DVD-R	
CD-DA (audio CD)	
CD-RW	 
CD-R	 
Kodak Picture CD	
DTS-CD	-

Playable files	Media
AVCHD	DVD-RW/-R, SD Memory Card (including SDHC), miniSD Card, microSD Card
MP3	BD-RE/-R, DVD-RW/-R, CD-RW/-R, SD Memory Card (including SDHC), miniSD Card, microSD Card
Windows Media™ Audio	SD Memory Card (including SDHC), miniSD Card, microSD Card
JPEG	

- This unit cannot play back the disc contents protected by Windows Media™ Digital Rights Management (DRM).

Readable cards	Playable files / data
SD Memory Card (8 MB - 2 GB)	AVCHD, MP3, Windows Media™ Audio, JPEG, picture-in-picture commentary, subtitles or other extras for BD-ROM Profile 1 ver.1.1
SDHC Memory Card (4 GB - 8 GB)	
miniSD Card (8 MB - 2 GB)	
microSD Card (8 MB - 2 GB)	

Note for SD Memory Cards

- This unit supports SD Memory Card with FAT12/ FAT16 file system, and SDHC Memory Card with FAT32 file system.
- This unit does not support NTFS file system.
- This unit may not read the SD Memory Cards formatted on a computer. If that is the case, please reformat the SD Memory Cards in this unit and try again.
- This unit does not support miniSDHC and microSDHC Memory Card.
- For miniSD Card and microSD Card, the adapter is necessary.

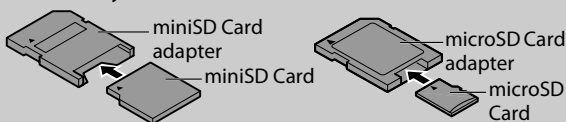

- Portions of this product are protected under copyright law and are provided under license by ARIS / SOLANA / 4C.
- Please keep the SD Memory Cards in their cases when you are not using them.
- Do not try to open or modify the card.
- Do not touch the terminal surface with your fingers or any metals.
- Do not attach additional labels or stickers to cards.
- Do not remove the label of the SD Memory Cards.
- This unit recognizes up to 8 characters of file name in the SD Memory Card. Characters after 8th will not be displayed.

Unplayable Discs and Files

The following discs will not be played back in this unit.

- CD-ROM
- CD-I (compact disc-interactive)
- DVD-RAM
- VSD (video single disc)
- DVD-audio
- Video CD
- HD DVD
- SVCD
- Unfinalized disc
- BD-RE (ver.1.0)
- BD-RE (ver.2.1) (Recorded in BDAV format)
- BD / DVD / SD Memory Card contains DivX® files.
- BD / DVD hybrid disc (played back as a BD-video only)
- BD that contains AVCHD files
- BD-R (ver.1.1 / 1.2 / 1.3) (Recorded in BDAV format)
- DVD-RW/-R recorded in non compatible recording format.
- Super Audio CD - Only the sound on the CD layer can be heard. The sound on the high-density Super Audio CD layer cannot be heard.
- Playability of dual discs are not guaranteed.

PLAYBACK

Color Systems

BD-video and DVD-video are recorded in different color systems throughout the world. The most common color system is NTSC (which is used primarily in the United States and Canada).

This unit employs NTSC color system, so the disc you play back must be recorded in the NTSC system. You cannot play back the disc recorded in other color systems.

Region Codes

This unit has been designed to play back BD-video with region "A" and DVD-video with region "1" or "ALL". You cannot play back BD-video or DVD-video that are labeled for other regions. Look for the symbols on the right on your BD-video or DVD-video.

If these region symbols do not appear on your BD-video or DVD-video, you cannot play back the disc in this unit. The letter or number inside the globe refers to region of the world. A BD-video or DVD-video labeled for a specific region can only be played back in the unit with the same region code.

BD-video



DVD-video



Structure of Disc / SD Memory Card Contents

The contents of BD / DVD / AVCHD are generally divided into titles. Titles may be further subdivided into chapters.

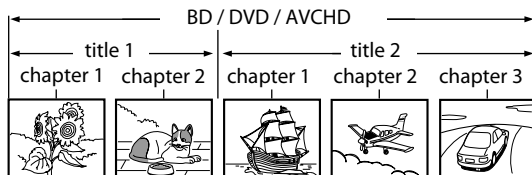

Audio CD is divided into tracks.



Data discs or SD Memory Cards containing MP3 / WMA / JPEG are divided into folders, and the folders are subdivided into files.

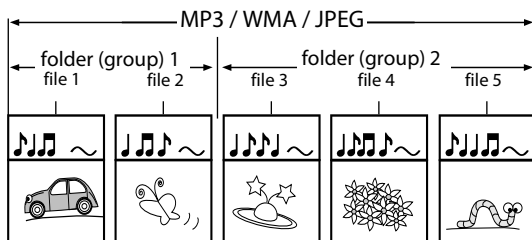

On-Screen Display

You can check information about the current disc by pressing **[DISPLAY]**.

To call the on-screen display menu, press **[DISPLAY]** during playback. Every time you press **[DISPLAY]**, the information changes. Depending on the media, available information varies.



- off → Title / Chapter information
- Title information (elapsed time)
- Title information (remaining time)
- Decoding format information → off



- off → Chapter information (elapsed time)
- Chapter information (remaining time)
- Title information (elapsed time)
- Title information (remaining time)
- Decoding format information → off



- Track information (elapsed time)
- Track information (remaining time)
- Disc information* (elapsed time)
- Disc information* (remaining time)
- Track information (elapsed time)
- (* not available during program / random playback)

MP3

- off (File information (elapsed time))
- File name information
- off (File information (elapsed time))

WMA

- off (File information (elapsed time))
- File name information
- Tag information (title name)
- Tag information (artist name)
- off (File information (elapsed time))

JPEG

- off → File information → File name information → off

PLAYBACK

■ Chapter information

<Title / Chapter information for BD and AVCHD>



<Chapter information for DVD>



- 1 **Current title number**
- 2 **Current chapter number / Total number of chapters**
- 3 **Current repeat setting (Only when repeat setting is active)**
(C: Chapter repeat, T: Title repeat, AB: A-B repeat)
- 4 **Indicates that the multi camera angle images are available on the scene**
- 5 **Current playback status**
- 6 **Elapsed time (or remaining time) of the current chapter**

■ Title information



- 1 **Current title number / Total number of titles**
- 2 **Elapsed time (or remaining time) of the current title**

■ Track / File information



- 1 **Current track (file) number / Total number of track (file)**
- 2 **Elapsed time (or remaining time) of the current track / file (except for JPEG files)**
- 3 **Indication of SD Memory Card playback**
- 4 **Current repeat setting (Only when repeat setting is active)**
(T: Track repeat, G: Group repeat, A: All repeat, AB: A-B repeat)

■ Disc information



- 1 **Current track number / Total number of tracks**
- 2 **Elapsed time (or remaining time) of the current disc**

■ File name information



- 1 **Media icon and file name**

: MP3 files

: WMA files

: JPEG files

■ Tag information

<Title name information>



<Artist name information>



- 1 **Title name based on tag information of current Windows Media™ Audio file**
- 2 **Artist name based on tag information of current Windows Media™ Audio file**

■ Decoding format information



- 1 **Decoding format**

INTRODUCTION

CONNECTIONS

PLAYBACK

FUNCTION SETUP

OTHERS

PLAYBACK

How to Insert a Disc

1 Press [OPEN/CLOSE ▲] to open the disc tray.

2 Place the disc on the disc tray with its label side facing up.

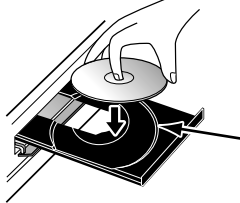

Align the disc to the disc tray guide.

- Make sure the disc is compatible with this unit. (Refer to page 17 for the list of compatible discs.)

3 Press [OPEN/CLOSE ▲] to close the disc tray.

Please allow time for the disc to load.

To eject the disc:

Press [OPEN/CLOSE ▲] to open the disc tray.

Remove the disc.

Press [OPEN/CLOSE ▲] to close the disc tray.

Reading an SD Memory Card

AVCHD MP3 WMA JPEG

You can play back the AVCHD / MP3 / WMA / JPEG files in an SD Memory Card.

With the SD Memory Card, you can also enjoy the following functions.

- Special additional contents for BD-ROM Profile 1 ver.1.1. (For more information about the special additional contents, refer to the instruction book that came with the disc.)
- BD-Live function (BD-ROM ver. 2 Profile 2.0). (For more information about BD-Live, refer to page 29.)

1 Insert an SD Memory Card, with the label side facing up, into the SD card slot until it clicks.

If no disc is in operation, "Media Select" screen will appear on the TV screen.

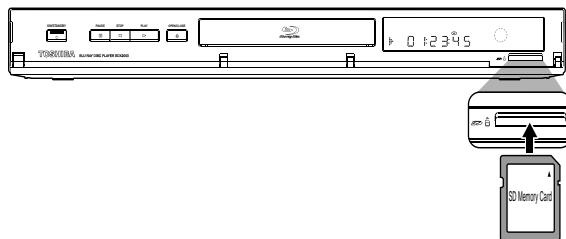

2 Use [▲ / ▼] to select "SD Card", then press [ENTER].

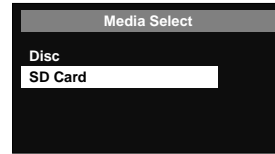

- Media filter screen will appear.
- When the SD Memory Card contains only one type of file, skip to step 4.

3 Select the type of the file you want to play back in the media filter screen. Then press [ENTER] to display the file list.

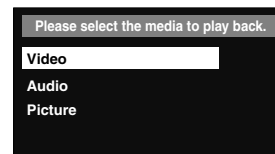

- Playback of AVCHD files will start right after you choose "Video". (The file list is not available for AVCHD files.)

4 Use [▲ / ▼] to select a desired track, folder or file, then press [ENTER]. Use [◀ / ▶] to go back and forward between the hierarchies.

- If you press [ENTER] on the desired file, playback will start.

To remove the SD Memory Card:

In stop mode, gently push in the SD Memory Card, then pull it out slowly.

Note

- The "Media Select" screen will disappear under the conditions listed below:
 - when the screen saver is activated.
 - when [RETURN] is pressed.
 - when the setup menu is called up.
- If the "Media Select" screen disappears before you make the selection, refer to "Selecting the Media" on page 21.
- Do not remove the SD Memory Card or turn the unit to the standby mode while the contents of the card are in playback. It may result in malfunction or loss of the card's data.
- Do not delete the folders or files in the SD Memory Card with your computer. This unit may not read the SD Memory Cards formatted on a computer.
- If a folder or file name includes one of the following unrecognizable characters, the folder or file name may not be displayed correctly.
 - Unrecognizable characters: [., " = + [] ; / \ : | ¥]

PLAYBACK

Selecting the Media

For the playback media to be read by this unit, the correct media should be selected. You can switch the media by following the steps below. **"Media Select" is available only when an SD Memory Card is inserted.**

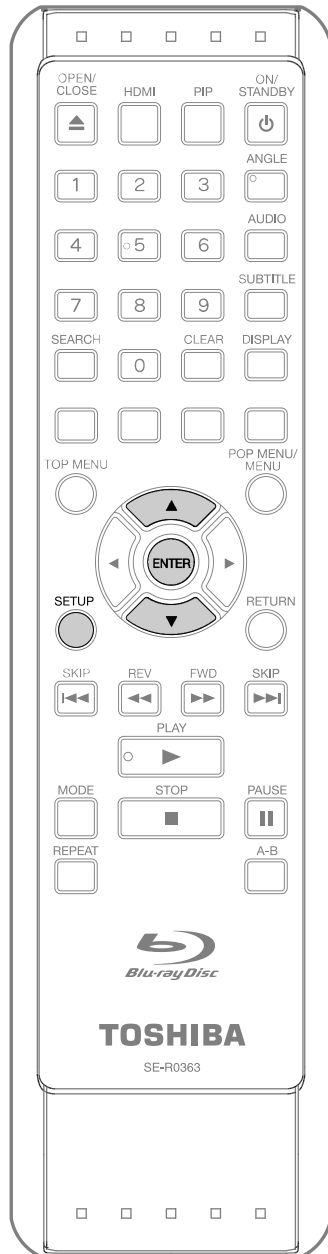

1 In stop mode, press [SETUP].

2 Use [▲ / ▼] to select , then press [ENTER].

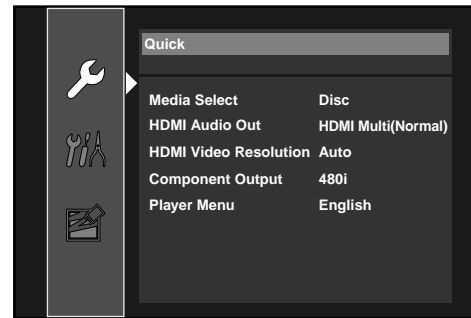

3 Use [▲ / ▼] to select "Media Select".

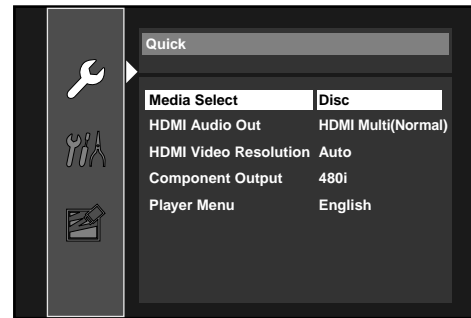

4 Press [ENTER] repeatedly to select the desired media.

5 Press [SETUP] to exit.

Even if you turn the unit to the standby mode in "SD Card" mode, it will be in "Disc" mode the next time you turn it on.

PLAYBACK

Playing Back (BD, DVD or a Disc with AVCHD files)

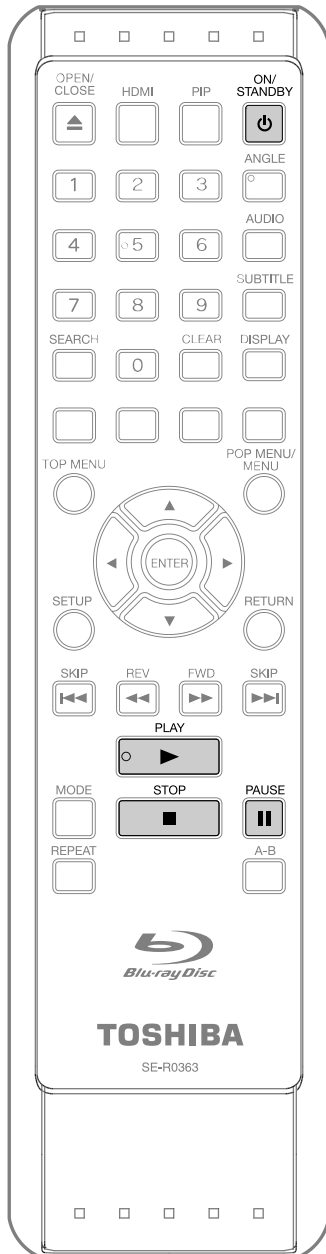

- 1** Press [ON/STANDBY].
- 2** Turn on the TV and select the appropriate input on the TV to which the unit is connected.
- 3** Insert a disc (refer to page 20 on how to insert a disc).
- 4** Playback may start automatically.
If not, press [PLAY].
 - Some discs may show a title or a disc menu. In such case, refer to "Using the Title / Disc / Pop-up Menu" on page 23.
 - For a disc with AVCHD files, title menu is displayed.

To pause playback:
Press [PAUSE].

To return to the normal playback:
Press [PLAY].

To stop playback:
Press [STOP].
Playback will be in Resume-On-Stop mode.

Resume-On-Stop mode

If a playback is in Resume-On-Stop mode, when you press [PLAY] next time, the playback will start from the point where it has been stopped.

Note

- Resume playback may not be available for the BD that supports Java applications (BD-Java).
- In the "Disc" mode, the resume information will be cleared when;
 - [STOP] is pressed while in the Resume-On-Stop mode.
 - the parental level is changed.
 - the disc tray is opened.
- In the "SD Card" mode, the resume information will be cleared when;
 - [STOP] is pressed while in the Resume-On-Stop mode.
 - the SD Memory Card is removed.
 - the unit is turned into the standby mode.

Note

- may appear at the top-right on the TV screen when the operation is prohibited by the disc or this unit.
- During the playback of 2-layered disc, pictures may stop for a moment. This happens when the 1st layer switches to the 2nd layer. This is not a malfunction.
- The operation may vary when you play back BD-video and DVD-video with disc menu. Refer to the manual accompanying the disc for details.
- Set "Still Mode" setting to "Field" in "Video" menu if pictures in the pause mode are blurred. Refer to "Still Mode" on page 37.

PLAYBACK

Using the Title / Disc / Pop-up Menu



Many of BD-video and DVD-video discs contain title menu (BD-video / DVD-video / AVCHD), disc menu (DVD-video) or pop-up menu (BD-video) which guides you through the available functions in the disc. The contents of the menus may differ depending on the discs.

Title menu (BD-video / DVD-video / AVCHD)

- 1 Press [TOP MENU].
- 2 Use [▲ / ▼ / ◀ / ▶] to select an item, then press [ENTER].
- 3 Press [TOP MENU] to exit.

Disc menu (DVD-video)

- 1 Press [POP MENU / MENU].
- 2 Use [▲ / ▼ / ◀ / ▶] to select an item, then press [ENTER].
- 3 Press [POP MENU / MENU] to exit.

Pop-up menu (BD-video)

- This is a special feature available for some BD-videos. When you press [POP MENU / MENU], a menu pops out on the TV screen during the playback.

- 1 During the playback of BD-video, press [POP MENU / MENU].
- 2 Use [▲ / ▼ / ◀ / ▶] to select an item, then press [ENTER].
- 3 Press [POP MENU / MENU] to exit.

Note

- Contents of menus and corresponding menu operations may vary among discs. Refer to the manual accompanying the disc for details.
- Title menu is also available for SD Memory Card with AVCHD files.

Playing Back (Audio CD or a Disc with MP3/Windows Media™ Audio/JPEG Files)



Before you begin, make sure the correct media is selected. Refer to "Selecting the Media" on page 21.

- 1 **Insert an audio CD or a disc/card with MP3, WMA or JPEG files.**
 - Media filter screen will appear.
 - For audio CD and a disc contains only one type of file, skip to step 3.
- 2 **Select the type of the file you want to play back in the media filter screen. Then press [ENTER] to display the file list.**
- 3 **Use [▲ / ▼] to select a desired track, folder or file, then press [ENTER]. Use [◀ / ▶] to go back and forward between the hierarchies (only for MP3 / WMA / JPEG files).**
 - If you press [ENTER] on the desired file, playback will start.

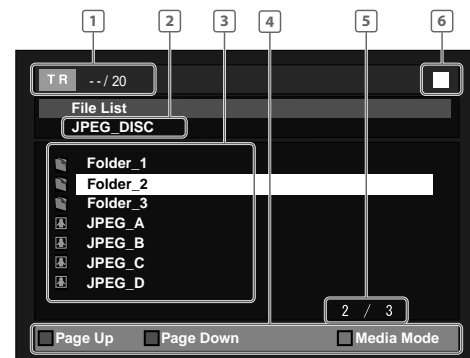

e.g.) JPEG

- 1 **audio CD** : Track information
MP3 / WMA : File information
JPEG
- 2 **audio CD** : "CD-DA" will be displayed
MP3 / WMA : Current Disc, SD Memory Card, or JPEG
JPEG : folder name will be displayed
- 3 **audio CD** : List of the track number and time
MP3 / WMA : List of the file or folder names in the current folder or disc
- 4 **Operation** : Press [RED] to go to the previous page
Press [GREEN] to go to the next page
Press [YELLOW] to select "Media Mode"
- 5 **Current page / Total page number**
- 6 **Playback status**

PLAYBACK

Media icon and File name

-  : Folder
-  : audio CD tracks
-  : MP3 files
-  : WMA files
-  : JPEG files

4 Press [STOP ■] to stop playback.

It is recommended that files to be played back in this unit are recorded under the following specifications:
<MP3/Windows Media™ Audio>

- Sampling frequency : 32 kHz, 44.1 kHz or 48 kHz
- Constant bit rate : 112 kbps - 320 kbps (MP3),
48 kbps - 192 kbps (Windows Media™ Audio)

<JPEG>

- Upper limit : 2,560 x 1,900 dots (sub sampling is 4:4:4)
5,120 x 3,840 dots (sub sampling is up to 4:2:2)
- Lower limit : 32 x 32 dots
- File size of image : 12 MB maximum

Note

- Unrecognizable characters will be replaced with asterisks.
- Some unplayable folders or files may be listed due to the recording status.
- High-resolution JPEG files take longer to be displayed.
- Progressive JPEG files (JPEG files saved in progressive format) cannot be played back in this unit.
- The system can recognize up to 255 folders / 999 files for CD, 999 folders / 9,999 files for BD, DVD and SD Memory Card.
- The 9th and deeper hierarchies cannot be displayed for CD. The 10th and deeper hierarchies cannot be displayed for DVD and SD Memory Card.
- For the SD Memory Card playback, refer to "Reading an SD Memory Card" on page 20.
- For an SD Memory Card, only an extension of ".jpg" can be recognized. For other media, only ".mp3(MP3)", ".wma(WMA)" and ".jpg/.jpeg(JPEG)" can be recognized, and any other extensions cannot be read.
- If a disc contains AVCHD files, the playback of other files which are in the same disc is not available.
- With regard to the multi-border BD-RE/-R, additionally recorded sections cannot be recognized.
- With regard to the multi-border DVD-RW/-R, additionally recorded sections may not be recognized.

Kodak Picture CD

JPEG

This unit can also run JPEG files stored on Kodak Picture CD. You can enjoy picture images on the TV set by playing back the Kodak Picture CD. This unit conforms to ver.7.0 of Kodak Picture CD. For details of Kodak Picture CD, contact a shop that provides developing service of Kodak Inc.

1 When Kodak Picture CD is inserted in this unit, Kodak Picture CD menu will appear automatically on the TV screen.



- 1 File information
- 2 Current page / Total page number
- 3 Operation guide: Press [BLUE] to go to the previous page
Press [YELLOW] to go to the next page
- 4 Playback status

2 Use [▲ / ▼ / ◀ / ▶] to select a desired file to be played back, then press [PLAY ▶] or [ENTER].

- An image will be played back from the selected file and go to the next one in turn.

3 Press [STOP ■] to stop playback.

To return to the first item:
Press [TOP MENU].

To return to the file played last:
Press [POP MENU / MENU].

PLAYBACK

Tips for JPEG / Kodak Picture CD Playback

- Every press on [ANGLE] will turn the image clockwise by 90 degrees when an image is displayed.
- To change the visual effect for switching the playback image, press [MODE] once, then use [◀/▶] or [ENTER] to switch between "Cut In/Out" and "Fade In/Out".
- During JPEG / Kodak Picture CD playback, press [MODE] twice to change the size of the playback image, then use [◀/▶] or [ENTER] to switch between "Normal" (100 %) and "Small" (95 %). The size change may have no effect on some files (e.g. files with a small picture size).

Fast Forward / Fast Reverse



- 1 During playback, press [FWD ▶▶] repeatedly for fast forward.
During playback, press [REV ◀◀] repeatedly for fast reverse.
Every time you press [FWD ▶▶] or [REV ◀◀], the playback speed will change.
- 2 Press [PLAY ▶] to return to normal playback.

Note

- For BD, DVD and AVCHD, speed changes in 5 different levels.
- For audio CD, MP3 and Windows Media™ Audio, speed changes in 3 different levels.
- For audio CD, fast forward / fast reverse search between different tracks are not available during program and random playback.
- For MP3 and Windows Media™ Audio, fast forward / fast reverse search between different files are not available.

Slow Motion Playback



- 1 During playback, press [PAUSE II], then press [FWD ▶▶].
Every time you press [FWD ▶▶], playback speed will change.
- 2 Press [PLAY ▶] to return to normal playback.

Note

- Slow motion speed changes in 3 different levels.
- Only forward slow motion is available.
- Set "Still Mode" setting to "Field" in "Video" menu if pictures in the slow motion playback mode are blurred. Refer to "Still Mode" on page 37.

INTRODUCTION

CONNECTIONS

PLAYBACK

FUNCTION SETUP

OTHERS

PLAYBACK

Step by Step Playback



- 1 In pause mode, press [PAUSE III] repeatedly.
Every time you press [PAUSE III], playback will advance one step at a time.
- 2 Press [PLAY ►] to return to normal playback.

Note

- Only step by step forward is available.
- Set "Still Mode" setting to "Field" in "Video" menu if pictures in step by step playback mode are blurred. Refer to "Still Mode" on page 37.

Repeat Playback

Available repeat functions vary depending the discs.

- 1 During playback, press [REPEAT] repeatedly to select the desired repeat mode.

Repeat mode	Available media
Chapter repeat	
The current chapter will be played back repeatedly.	 AVCHD
Title repeat	
The current title will be played back repeatedly.	 AVCHD
Track repeat	
The current track will be played back repeatedly.	 WMA
Group repeat	
The current folder will be played back repeatedly.	 JPEG
All repeat	
All tracks or files in the media will be played back repeatedly.	 WMA

Note

- The repeat setting will be canceled when you stop playback.
- The chapter, title, track or group repeat will be cleared when moving to another chapter, title, track / file or folder.
- Repeat playback does not function during A-B repeat playback.
- Chapter and title repeat are not available with some scenes.
- When the repeat setting is set for a MP3 or WMA folder (file), the repeat setting will be canceled if you select other MP3 or WMA folder (file) to playback.

A-B Repeat



You can play back the specific part (between point A and point B) repeatedly.

- 1 During playback, press [A-B] at the desired starting point A.
- 2 During playback, press [A-B] at the desired ending point B.

As soon as you set the point B, the part between point A and point B will start playback repeatedly.

- To cancel the A-B repeat, press [A-B] again.

Note

- Point B should be set within the same title or track as point A.
- A-B repeat is not available with some scenes.
- To cancel the A point which was set, press [CLEAR].
- A-B repeat does not function during chapter, title, track, group or all repeat playback.

Program Playback



You can play back the disc/card in your desired order.

- 1 In stop mode, press [MODE].
- 2 Use [▲ / ▼] to select a track / folder / file, then press [ENTER].

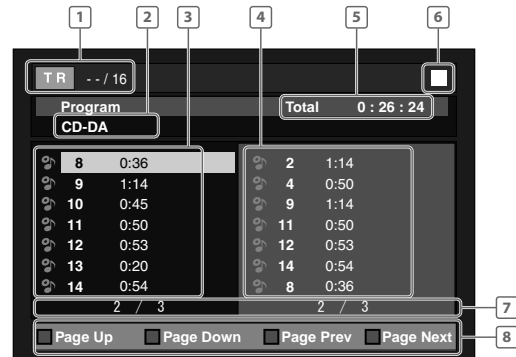

e.g.) audio CD

- 1 **audio CD** : Track information
MP3 / WMA / : File information
JPEG
- 2 **audio CD** : "CD-DA" will be displayed
MP3 / WMA / : Current Disc, SD Memory Card,
JPEG : or folder name will be displayed
- 3 **Track / Folder /** : Track / Folder / File list in the
File list : original order
- 4 **Programmed list** : Track / File list in the
programmed order
- 5 **Cumulative playback time of all tracks in the**
programmed list (audio CD only)
- 6 **Playback status**
- 7 **Current page / Total page number**

PLAYBACK

- 8 Operation Guide:** Press [RED] to go to the previous page in the track / folder / file list
 Press [GREEN] to go to the next page in the track / folder / file list
 Press [BLUE] to go to the previous page in the programmed list
 Press [YELLOW] to go to the next page in the programmed list

- For MP3, WMA or JPEG files, use [▲ / ▼] to select a folder, then press [ENTER] first, and then use [▲ / ▼] to select a file, then press [ENTER].
- Press [CLEAR] to erase the last file of the program.
- Use [▲ / ▼] to select "All Clear" at the bottom of the list to erase all the tracks / files in the program.
- The programmed tracks / files is displayed in the right hand screen.
- Use [◀ / ▶] to go back / forward between the hierarchy of folders.

3 Press [PLAY ▶] to start program playback.

- The program playback will start.

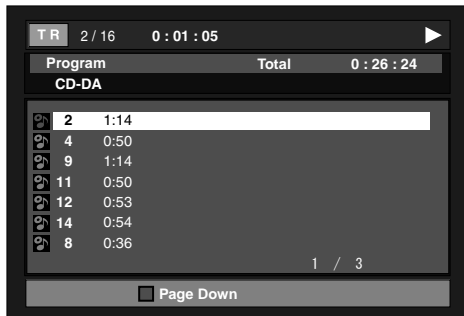

To exit from the program playback mode:
 • Press [RETURN] in stop mode.

Note

- During program playback, press [STOP ■] once to set the resume point, and then press [PLAY ▶] to resume program playback from where [STOP ■] was pressed (audio CD) or from beginning of the file where [STOP ■] was pressed (MP3 / WMA / JPEG).
- During program playback, press [STOP ■] twice to display the program screen. To go back to the normal program playback, press [RETURN] to exit from the program screen, then press [PLAY ▶].
- Up to 99 tracks / files can be entered.
- To repeat the current track / file in the program, press [REPEAT] repeatedly until "🔄 Track" appears during playback. To repeat the entire program, press [REPEAT] repeatedly until "🔄 All" appears during playback.
- Playback from a desired track / file and random playback are not available during program playback.
- Press [MODE] to switch to the random playback mode.
- The program will be cleared when;
 - the unit is turned into the standby mode.
 - the media is switched.
 - the disc / card is removed (as for "Disc" mode, just opening the disc tray will clear the program info).

Random Playback



This function shuffles the playback order of tracks / files.

1 In stop mode, press [MODE] twice.

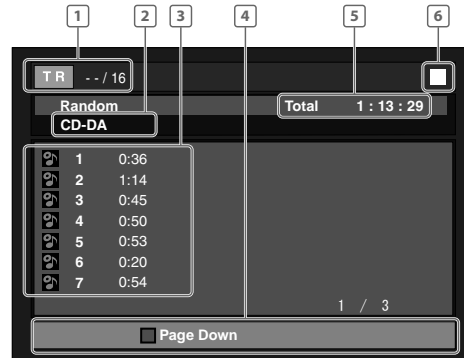

e.g.) audio CD

- 1 audio CD** : Track information
MP3 / WMA / JPEG : File information
- 2 audio CD** : "CD-DA" will be displayed
MP3 / WMA / JPEG : Current Disc, SD Memory Card, or folder name will be displayed
- 3 Track / File list** : Track / File list in the original order will be displayed
- 4 Operation Guide** : Press [RED] to go to the previous page in the track / file list
 Press [GREEN] to go to the next page in the track / file list
- 5 Total playback time of all tracks (audio CD only)**
- 6 Playback status**

2 Press [PLAY ▶] to start random playback.

To exit from the random playback mode:
 • Press [MODE] in stop mode.

Note

- During the random playback, press [STOP ■] once to set the resume point, and then press [PLAY ▶] to resume random playback from where [STOP ■] was pressed (audio CD) or from beginning of the file where [STOP ■] was pressed (MP3 / WMA / JPEG).
- To repeat the current track / file in the random selection, press [REPEAT] repeatedly until "🔄 Track" appears during playback. To repeat the entire random selection press [REPEAT] repeatedly until "🔄 All" appears during playback.
- Playback from a desired track / file is not available during random playback.
- In stop mode, press [RETURN] to switch to the program playback mode.
- For a disc containing mixed MP3 and Windows Media™ Audio files, random playback of those files will be performed.

PLAYBACK

Rapid Playback



This function plays back approximately at 1.3 times the normal playback while keeping the sound output. This function is available only on discs recorded in the Dolby Digital format.

- 1 During playback, press [MODE] repeatedly until the Rapid playback setting appears.

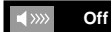

- 2 Press [ENTER] or [◀/▶] to switch 1.3x, or off.

"Off" : Plays back in normal speed.

"1.3x" : Plays back approximately at 1.3 times of normal playback.

- 3 Press [PLAY ▶] to return to normal playback.

Note

- Picture adjustment and audio language setting cannot be changed during this function.
- Virtual surround does not work during this function.
- This function may not work at some points on a disc.
- During this function, 2ch LPCM will be output from HDMI OUT jack and DIGITAL OUT jack.

Adjusting the Picture



You can adjust the picture quality.

- 1 During playback, press [MODE] repeatedly until  appears.
- 2 Use [▲/▼] to select your desired item, then use [◀/▶] to adjust the setting.



e.g.) DVD-video

Black level

You can adjust the black level setting to make the black parts of the pictures as bright as you prefer. You can select "On" or "Off".

"On" : Enhances detail in darker areas.

"Off" : Shows the original picture as recorded.

Noise reduction (DVD-video only)

Reduces the noise of the playback picture.

"Off" : Shows the original picture as recorded.

"1" : Executes 3D noise reduction which detects and deletes the noise by comparing each picture frames.

"2" : Executes MPEG noise reduction which reduces the block noise and mosquito noise on the subtitles on the movie.

"3" : Executes both MPEG noise reduction and 3D noise reduction.

- 3 Press [RETURN] to exit.

Note

- The setting will remain the same even if the unit is turned to the standby mode.
- "Black Level" is not effective under the following conditions.
 - When the picture is output from HDMI OUT jack.
 - When the picture is output from COMPONENT VIDEO OUT jack with "Component Output" set to "480p / 720p / 1080i".
- You cannot adjust the setting during rapid playback.

Virtual Surround



You can enjoy stereophonic virtual space through your existing 2 channel stereo system.

- 1 During playback, press [MODE].
- 2 Use [▲/▼] to select your desired setting.



"Off" : No surround effect

"1" : Natural surround effect

"2" : Stronger surround effect

- 3 Press [RETURN] to exit.

Note

- Set the virtual surround setting to "Off" or lower the volume if the sound is distorted.
- Virtual surround does not function during rapid playback.
- For the virtual surround, audio signal will always be 2-channel LPCM.

PLAYBACK

PIP (BONUSVIEW) Setting



Some BD-video have the PIP function which enables you to display the secondary video in the primary video. You can call up the secondary video by pressing **[PIP]** whenever the scene contains the secondary video.

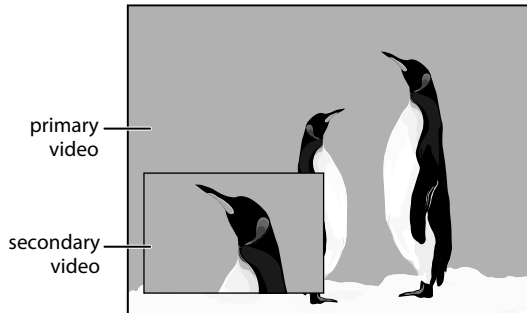

- 1 During playback, press [PIP].**
- 2 Use [▲ / ▼] to select the secondary video you want.**
 - The secondary video will be displayed and the secondary audio will be output.
- 3 Press [RETURN] or [PIP] to remove the PIP information.**

Note

- The secondary audio will not be output when the secondary audio is set to "Off" or when "BD Audio Mode" is set to "HD Audio Output". Refer to "Switching Audio Soundtrack" on page 31 and "Setting the BD Audio Mode" on page 32.

Camera Angle



Some BD-video and DVD-video contain scenes which have been shot simultaneously from various angles. You can change the camera angle when  appears on the TV screen.

- 1 During playback, press [ANGLE].**
 - The selected angle will be displayed on the display bar at the top of the TV screen.
- 2 Use [▲ / ▼] to select your desired angle.**



Note

- If "Angle Icon" setting is "Off" in "Others" menu,  will not appear. Refer to page 44.

Enjoying BD-Live Discs with Online Content



You can enjoy the BD-Live functions which enable you to use the interactive functions when the unit is connected to the Internet. (For the Network connection, refer to page 46.)

Examples for BD-Live interactive functions:

- Download the additional contents such as the movie's trailer, subtitles and BD-Java, etc.
- While downloading, special video data may be played back.

Service and functions differ depending on the disc. Follow the instructions given by the disc when using the BD-Live function.

Note

- You must connect the unit to the Internet and set up necessary settings in order to use the BD-Live function.
- For certain discs, setting for "BD-Live Setting" may need to be changed.
- Depending on your connection environment, it may take time to connect to the Internet or the Internet may not be connected.
- When BD-Live functions are used and the unit is connected to the Internet, you may be charged for this communication.
- While connecting to BD-Live, sometimes it can take awhile before the next page is downloaded or refreshed.
- You must insert an SD Memory Card when using the BD-Live function. (SD Memory Card of 1GB is recommended.)
- Do not remove the SD Memory Card when using the BD-Live function.

Note for AACs Online

- The player or disc IDs may be sent to the content provider when playing back a disc with BD-Live function.
- If you save your viewing history on the server by using these IDs, you will be introduced to other similar movies.
- You can save game score histories.

PLAYBACK

Search

Using [SKIP |◀◀ / ▶▶|]

1 During playback, press [SKIP ▶▶] to move to the next track / title / chapter / file. Press it repeatedly to skip to subsequent tracks. Press [SKIP |◀◀] once to go back to the beginning of the current track. Press it repeatedly to go to the previous tracks.









- For JPEG files, press [SKIP |◀◀] to go back to the previous file.

Note

- If title contains no chapters, [SKIP |◀◀ / ▶▶] changes the title.
- For JPEG files, [◀ / ▶] is also available.

Using [SEARCH]

By using [SEARCH], you can select the following search modes.

Search mode	Available media
 / TT Chapter / Title search	  AVCHD
TR Track search	 MP3 WMA 
 Time search	   AVCHD

1 During playback, press [SEARCH] repeatedly until your desired search mode appears.

2 Enter the desired chapter, title, track, file number or time to search for using [Number buttons].

- Chapter, title, track or time search will start.
- Press [CLEAR] to erase an incorrect input.

Note

- During program and random playback, search functions are not available except the search using [SKIP |◀◀ / ▶▶].
- Time search is available only in the same track, file or title.
- For BD and AVCHD, chapter and time search are available only during playback.

Using [Number buttons] (Direct Search)

Title Search

In stop mode, enter the title number you want to search using [Number buttons].

Playback of the title will start in a few seconds.

Chapter Search

During playback of a title, enter the chapter number you want to search using [Number buttons].

Playback of the chapter will start in a few seconds.

Track / File Search

Enter the track / file number you want to search using [Number buttons].

Playback of the track / file will start in a few seconds.

Note

- As for the BD-video, how it performs will be strongly determined by the disc, and may not perform as described here.

PLAYBACK

You can select the format of audio and video as you prefer depending on the contents of the disc you are playing back.

Switching Subtitles

Some BD, DVD and AVCHD may have subtitles in 1 or more languages. For commercially available discs, the supported languages can be found on the disc case. Follow the steps below to switch the subtitle languages during playback.



- 1 During playback, press [SUBTITLE].
- 2 Use [▲ / ▼] to select "Primary Subtitle", "Secondary Subtitle" or "Subtitle Style", then press [ENTER].

	Primary Subtitle	2 ENG/11
	Secondary Subtitle	2 ENG/11
	Subtitle Style	2/25

- "Primary Subtitle" : Sets the subtitle for the primary video.
 "Secondary Subtitle" : Sets the subtitle for the secondary video.
 "Subtitle Style" : Sets style of the subtitle.

- 3 Use [▲ / ▼] to select your desired subtitle or style.

- Use [◀ / ▶] to switch between current subtitle setting and "Off".

- 4 Press [SUBTITLE] to exit.



- 1 During playback, press [SUBTITLE].
- 2 Use [▲ / ▼] to select your desired subtitle.



- Use [◀ / ▶] to switch between current subtitle setting and "Off".

- 3 Press [SUBTITLE] to exit.

Note

- Some discs will only allow you to change the subtitles from the disc menu or pop-up menu. Press [TOP MENU] or [POP MENU / MENU] to display the disc menu or pop-up menu.
- If 4-digit-language code appears in the subtitle menu, refer to "Language Code List" on page 55.
- If the disc has no subtitle language or subtitle style, "Not Available" will be displayed on the TV screen.
- During playback of the secondary video, the primary subtitle setting is not available except when there is no subtitle for the secondary video.
- If you select a language that has a 3-letter-language code, the code will be displayed every time you change the subtitle language setting. If you select any other languages, "----" will be displayed instead. (Refer to page 55.)

Switching Audio Soundtrack

Some BD, DVD, audio CD and AVCHD contain multiple audio streams. Those are often in different audio languages or audio formats. For BD, available audio varies depending on "BD Audio Mode" setting. Refer to page 38 for more information.



- 1 During playback, press [AUDIO].
- 2 Use [▲ / ▼] to select "Primary" or "Secondary" audio to set, then press [ENTER].

	Primary				
	1	ENG	Dolby D	Multi-ch	/3
	Secondary				
	2	ENG	Dolby D+	Multi-ch	/3

- "Primary" : Sets the audio for the primary video.
 "Secondary" : Sets the audio for the secondary video.

- 3 Use [▲ / ▼] to select your desired audio stream channel.

- For "Secondary", use [◀ / ▶] to switch between current audio setting and "Off".

- 4 Press [AUDIO] to exit.



- 1 During playback, press [AUDIO].
- 2 Use [▲ / ▼] to select your desired audio stream channel.



e.g.) DVD-video

- For audio CD, you can select following options.

"Stereo" : Both right and left channels are active (stereo).

"L-ch" : Only left channel is active.

"R-ch" : Only right channel is active.

- 3 Press [AUDIO] to exit.

- For DTS-CD (5.1 music disc), "DTS" will be displayed. (Selecting audio streams or channels is not available.)

PLAYBACK

Note

- The secondary audio will not be output when the secondary video is not displayed or when "BD Audio Mode" is set to "HD Audio Output". (For some BD, secondary audio will be output even when secondary video is off.)
- The sound mode cannot be changed during playback of discs not recorded in multiple audio.
- Some discs allow changing the audio language setting on the disc menu. (Operation varies depending on the discs. Refer to the manual accompanying the disc.)
- **[AUDIO]** may not work on some discs with multiple audio streams or channels (e.g. DVDs that allow changing audio setting on the disc menu).
- If you select a language that has a 3-letter-language code, the code will be displayed every time you change the audio language setting. If you select any other languages, "---" will be displayed instead. (Refer to page 55.)
- Audio Language selection cannot be made during rapid playback. (Refer to page 28.)
- If 4-digit-language code appears in the audio menu, refer to page 55.
- If the disc has no audio language, "Not Available" will be displayed on the TV screen.

Setting the BD Audio Mode



There are 2 options for the "BD Audio Mode" setting; either by setting the output to the secondary and interactive audio accompanied by the primary audio or by setting only the primary audio. Depending on the setting of the mode, Dolby Digital, Dolby Digital Plus, Dolby TrueHD, DTS, or DTS-HD output changes between multi LPCM and bitstream.

- 1 In stop mode with BD inserted, press [MODE].**
- 2 Use [▲ / ▼] to select your desired setting.**

BD Audio Mode Mix Audio Output ⇅

"Mix Audio Output":

If it is available, BD-video's secondary and interactive audio will be output with the primary audio.

- The secondary audio is the audio for the secondary video (Director's commentary, etc.) and the interactive audio is the audio for the interactive application (Button click sounds etc.).

"HD Audio Output":

Only the primary audio will be output. Set this mode in order to output: Dolby Digital Plus, Dolby TrueHD, or DTS-HD audio of BD through HDMI connection.

- 3 Press [RETURN] to exit.**

Note

- You can also set "BD Audio Mode" from the setup menu. Refer to page 38.
- Refer to "Audio signals output from HDMI OUT jack" on page 39 and "Audio signals output from DIGITAL OUT (OPTICAL / COAXIAL) jack" on page 40 for how BD Audio will be output.
- In "Mix Audio Output" mode, if there is no secondary and interactive audio, the audio will be output as "HD Audio Output" mode.

FUNCTION SETUP

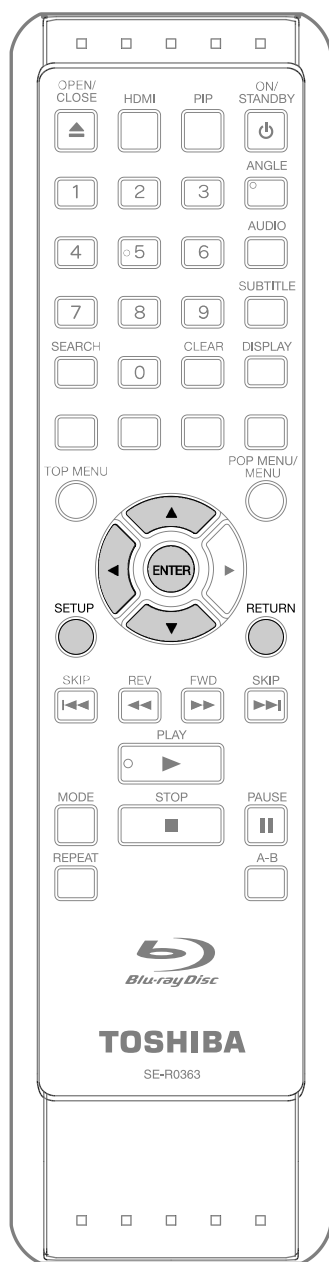

Using the Setup Menu

In the setup menu you can change the setting for audio, video, language, etc. You cannot change the setting during playback.

Setting items displayed in gray indicates they are not available under the conditions at the time.

Quick

"Quick" menu contains setting items extracted from "Custom" menu which may be used frequently.

- 1** In stop mode, press [SETUP].
- 2** Use [▲ / ▼] to select , then press [ENTER].
- 3** Use [▲ / ▼] to select your desired setting items.

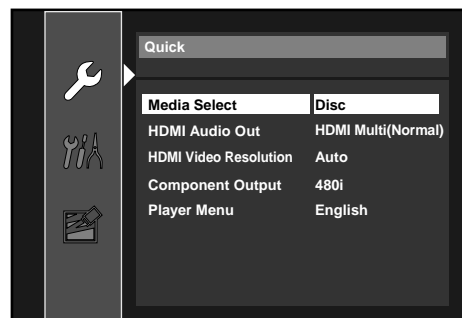

- 4** Follow the procedure below depending on the setting items.
 - A)** If "▶" does not appear on the right side of the setting items when you select the items:
Press [ENTER] repeatedly to change options.
 - B)** If "▶" appears on the right side of the setting items when you select the items:
 - 1)** Press [ENTER].
 - 2)** Use [▲ / ▼] to select options, then press [ENTER].
 - Use [◀] or [RETURN] to go back to the previous screen.

- 5** Press [SETUP] to exit.

INTRODUCTION

CONNECTIONS

PLAYBACK

FUNCTION SETUP





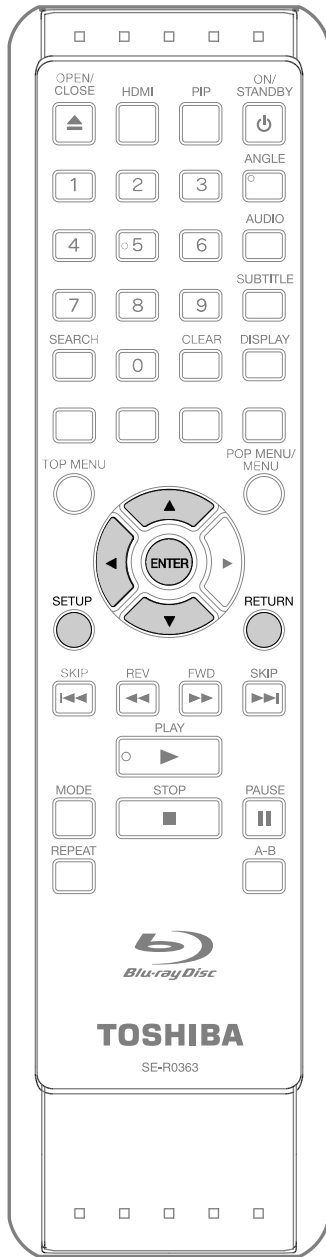

OTHERS

FUNCTION SETUP



Custom

" Custom" menu contains all the setting items.

- 1** In stop mode, press [SETUP].
- 2** Use [▲ / ▼] to select , then press [ENTER].
- 3** Use [▲ / ▼] to select your desired setting category, then press [ENTER].
 - : Language
 - : Video
 - : Audio
 - : Parental
 - : Others
 - For "Parental" menu, follow the procedure on page 43.
- 4** Use [▲ / ▼] to select your desired setting items.
- 5** Follow the procedure below depending on the setting items.
 - A) If "▶" does not appear on the right side of the setting items when you select the items:
Press [ENTER] repeatedly to change options.
 - B) If "▶" appears on the right side of the setting items when you select the items:
 - 1) Press [ENTER].
 - 2) Use [▲ / ▼] to select options, then press [ENTER].
 - Use [◀] or [RETURN] to go back to the previous screen.
- 6** Press [SETUP] to exit.

FUNCTION SETUP

Language



- To select the setting items and options, refer to “ Custom” on page 34.
- “ Quick” menu consists of the setting menus frequently used, and they are accompanied with .

Setting items	Options
Audio Sets the language for audio.	Original* / English / French / Spanish / German / Italian / Swedish / Dutch / Russian / Chinese / Japanese / Korean / Danish / Finnish / Norwegian / Icelandic / Hungarian / Romanian / Turkish / Greek / Irish / Portuguese / Polish / Czech / Slovak / Bulgarian / Other
Subtitle Sets the language for subtitle.	Off* / English / French / Spanish / German / Italian / Swedish / Dutch / Russian / Chinese / Japanese / Korean / Danish / Finnish / Norwegian / Icelandic / Hungarian / Romanian / Turkish / Greek / Irish / Portuguese / Polish / Czech / Slovak / Bulgarian / Other
Disc Menu Sets the language for disc menu or pop-up menu.	English* / French / Spanish / German / Italian / Swedish / Dutch / Russian / Chinese / Japanese / Korean / Danish / Finnish / Norwegian / Icelandic / Hungarian / Romanian / Turkish / Greek / Irish / Portuguese / Polish / Czech / Slovak / Bulgarian / Other
Player Menu Sets the language for OSD (on-screen display).	Auto(XXXX) ^{*1} / English* / Français / Español

)Settings with () are the default.

*1) “Auto” activates the Get & Set Menu Language function. Refer to page 45.

- “Auto” is available only when “HDMI CEC” is set to “On”.
- Inside the parentheses next to “Auto” will be the language which is currently selected by your TV.

- For “Audio”, “Subtitle”, and “Disc Menu”, if you select “Other”, enter the 4-digit-number code for the desired language. (Refer to “Language Code List” on page 55.) Only the languages supported by the disc can be selected.

FUNCTION SETUP

Video



- To select the setting items and options, refer to “Custom” on page 34.
- “Quick” menu consists of the setting menus frequently used, and they are accompanied with .

Setting items	Options
TV Aspect Sets the picture size according to aspect ratio of the connected TV.	16:9 Wide*: Select this when a wide-screen TV is connected. Discs recorded in wide-screen format is played back over the entire TV screen. 4:3 Pan & Scan: Select this to play back the discs recorded in wide-screen format with 4:3 TV in the pan & scan mode (with the sides of the picture cut off). Discs which are not specified for pan & scan are played back in the letter box mode. 4:3 Letter Box: Select this to play back the discs recorded in wide-screen format with 4:3 TV in the letter box mode (with black strips at the top and bottom). 16:9 Squeeze: When playing back 4:3 images, the picture is displayed in the center of the 16:9 screen with a 4:3 aspect ratio.
HDMI Video Resolution Sets the HDMI video resolution.	Auto*: HDMI video resolution will be selected automatically depending on the connected HDMI device. 480p 720p 1080i 1080p 1080p24: Gives a natural and high quality film reproduction of 24-frame film material. The connected TV has to be compatible with 1080p24 frame input.
HDMI Deep Color Sets whether to output the picture from HDMI OUT jack with Deep Color or not.	Auto*: The picture from HDMI OUT jack will be output with Deep Color to the connected TV which supports HDMI Deep Color. Off: The picture from HDMI OUT jack will be output without Deep Color.
Component Output Sets the video resolution for component output.	480i* 480p 720p 1080i
Progressive Mode Sets the optimum progressive mode for the image material output from HDMI OUT jack and COMPONENT VIDEO OUT jacks.	Auto*: The progressive mode will detect 24-frame film material (movies) and automatically select appropriate progressive mode. Video: Suited for playing back video material discs (TV shows or animation).

FUNCTION SETUP

Setting items	Options
Still Mode *1 Adjusts picture resolution and quality in still mode.	Auto *: Automatically selects the best resolution setting ("Frame" or "Field") based on the data characteristics of the pictures.
	Field : Stabilizes the pictures, although the picture quality may become coarse due to the limited amount of data. Select "Field" when the pictures are still unstable even if "Auto" is selected.
	Frame : Displays relatively motionless pictures in higher resolution. "Frame" improves the picture quality, although it may unstabilize the pictures due to alternate output of 2-field data.

)Settings with () are the default.

*1) An individual picture on the TV screen is called "Frame", which consists of two separate images called "Field". Some pictures may be blurred at the auto setting in "Still Mode" setting due to their data characteristics.

Note for "HDMI Video Resolution" and "Component Output"

- Even if you set "HDMI Video Resolution" setting to "Auto", when this unit is connected to a DVI compatible display devices with an HDMI-DVI cable, 480p signal will be output.
- Video and audio signals may be distorted temporarily when switching to / from the HDMI output mode.
- You cannot change the video resolution during Blu-ray Disc / AVCHD playback. To change the resolution, stop playback.
- In order to get natural and high quality film reproduction of 24-frame film material, use an HDMI cable (High Speed HDMI Cable is recommended) and select "Auto" if the connected TV is compatible with 1080p24 frame input.
- Even if the connected TV is compatible with 1080p24 frame input and you set "HDMI Video Resolution" setting to "Auto", when the contents of the disc are not compatible for 1080p24 frame, 1080p60 frame will be output.
- If the picture is not output properly to the TV because of "HDMI Video Resolution" or "Component Output" setting, press and hold [PLAY ►] on the front panel for more than 5 seconds. Both settings will be reset to the default automatically.
- For video resolution of the component output, you can only select the video resolution which is currently output from HDMI OUT jack or "480i" if HDMI cable is connected.
- If the video resolution for the component output and HDMI video resolution do not match, the video resolution for the component output will be switched to "480i".
- If you play back copy-protected DVD-video, 480p signal will be output from COMPONENT VIDEO OUT jacks, when "Component Output" setting is set to "720p" or "1080i".
- For AVCHD, 24-frame film material will be output as 60 frame, even if the connected device is compatible with 1080p24 frame input and "HDMI Video Resolution" is set to "1080p24", "Auto".

INTRODUCTION

CONNECTIONS

PLAYBACK

FUNCTION SETUP

OTHERS

FUNCTION SETUP

■ Audio



- To select the setting items and options, refer to “Custom” on page 34.
- “Quick” menu consists of the setting menus frequently used, and they are accompanied with .

Setting items	Options
BD Audio Mode For BD, selects whether to output the secondary and interactive audio with primary audio if it is available or only the primary audio. Refer to “Setting the BD Audio Mode” on page 32.	Mix Audio Output*: Outputs the secondary and interactive audio with primary audio if it is available. HD Audio Output: Outputs only the primary audio. Set this mode in order to output Dolby Digital, Dolby Digital Plus, Dolby TrueHD, DTS or DTS-HD audio of BD through HDMI connection.
HDMI Audio Out Sets the audio format for the audio output from HDMI OUT jack. Refer to page 39.	HDMI Multi(Normal)*: The multi-channel audio signals are output from HDMI OUT jack with bitstream or LPCM. HDMI Multi(LPCM): The multi-channel audio signals are output from HDMI OUT jack with LPCM. Refer to pages 41-42 for setting options. Audio Mute: Mutes the HDMI audio signal, and set the signal format from DIGITAL OUT jack. Refer to “Digital Out setting” on page 40 for setting options.
Down Sampling Sets the digital audio output when playing back BD or DVD recorded in LPCM.	On*: LPCM signals are converted to 48 kHz for output. Set to “On” when using digital connections to an AV amplifier that is not compatible with sampling frequencies of 96 kHz. Off: For BD and DVD recorded in LPCM without copyright protection, 2-channel audio signals up to 192 kHz are output as LPCM signals with no conversion.
DRC Sets whether to compress the range of sound volume (dynamic range control) when Dolby Digital, Dolby Digital Plus or Dolby TrueHD audio is played back.	Auto*: When the discs that are recorded in the Dolby TrueHD format is in playback, this unit detects DRC setting of the disc and set the DRC setting of this unit to “On” or “Off” automatically. Off On

)Settings with () are the default.

- Under following circumstances, “HDMI Multi(Normal)” and “HDMI Multi(LPCM)” are not available.
 - HDMI cable is not connected to HDMI OUT jack.
 - Connected TV is off.
 - Connected TV is not compatible with audio output.

FUNCTION SETUP

HDMI Audio Out Setting

When using HDMI connections make "HDMI Audio Out" setting in "Audio" menu according to the specifications of the device to be connected. Refer to page 38. Normally, set it to "HDMI Multi(Normal)" so that the unit automatically picks and outputs the best audio format suited to your connected device.

Device to be connected	"HDMI Audio Out" setting	Output HDMI audio signal
Device compatible with Dolby Digital, Dolby Digital Plus, Dolby TrueHD, DTS or DTS-HD decoding	HDMI Multi(Normal)	Dolby Digital, Dolby Digital Plus, Dolby TrueHD, DTS, or DTS-HD bitstream are output from HDMI OUT jack. Make the speaker settings on the connected AV amplifier, etc.
Device compatible with 3 or more channels of audio inputs (not Dolby Digital, Dolby Digital Plus, Dolby TrueHD, DTS or DTS-HD compatible)	HDMI Multi(LPCM)	Multi-channel audio signals are output from HDMI OUT jack. Make the speaker settings with the speaker setting items appear after you select "HDMI Multi(LPCM)". Refer to page 38.
HDMI connection to a TV and digital audio connection (optical / coaxial) to an AV amplifier	Audio Mute	HDMI audio will be mute, and Dolby Digital / DTS bitstream or LPCM will be output from DIGITAL OUT jack depending on "Digital Out setting". Refer to page 40.

Audio signals output from HDMI OUT jack

Media	Recording format	"HDMI Audio Out" setting			
		HDMI Multi(Normal)		HDMI Multi(LPCM)	
		When "BD Audio Mode" is set to "HD Audio Output"	When "BD Audio Mode" is set to "Mix Audio Output"	When "BD Audio Mode" is set to "HD Audio Output"	When "BD Audio Mode" is set to "Mix Audio Output"
BD-video	Dolby Digital	Dolby Digital	Dolby Digital	Multi LPCM	Multi LPCM
	Dolby Digital Plus	Dolby Digital Plus	Dolby Digital	Multi LPCM ^{*1}	Multi LPCM ^{*2}
	Dolby TrueHD	Dolby TrueHD	Dolby Digital	Multi LPCM ^{*3}	Multi LPCM ^{*4}
	DTS	DTS	DTS	Multi LPCM ^{*6}	Multi LPCM ^{*6}
	DTS-HD	DTS-HD	DTS	Multi LPCM ^{*1,6}	Multi LPCM ^{*5,6}
	LPCM	Multi LPCM	Multi LPCM	Multi LPCM	Multi LPCM
DVD-video	Dolby Digital	Dolby Digital		Multi LPCM	
	DTS	DTS		Multi LPCM	
	LPCM	2ch LPCM		2ch LPCM	
AVCHD	Dolby Digital	Dolby Digital		Multi LPCM	
	LPCM	2ch LPCM		Multi LPCM	
audio CD / MP3 / Windows Media™ Audio		2ch LPCM		2ch LPCM	
DTS-CD		DTS		Multi LPCM	

*1) Full decoded.

*2) Only the independent substream is decoded.

*3) Dolby TrueHD stream is decoded.

*4) Only the Dolby Digital substream is decoded.

*5) Only the core substream is decoded.

*6) When audio source is Multi-channel, decoded as 7.1ch. However, number of the output audio channel will depend on the number of the connected speakers.

- If the connected device is not compatible with the HDMI BITSTREAM, audio will be output as multi LPCM or 2-channel down-mixed LPCM depending on the capability of the connected device even if you select "HDMI Multi(Normal)" in "HDMI Audio Out" setting.
- When playing back a BD-video which only contains the primary audio, the audio output will be the same case as the "HD Audio Output" even if the "BD Audio Mode" is set to "Mix Audio Output".

Note

- The audio signals from HDMI OUT jack (including the sampling frequency, the number of channels and bit length) maybe limited by the device that is connected.
- Among the devices that support HDMI, some do not support audio output (e.g. projectors). In connections with device such as this unit, audio signals are not output from HDMI OUT jack.
- Video and audio signals may be distorted temporarily when switching to / from the HDMI output mode.

FUNCTION SETUP

Digital Out setting

When "Audio Mute" is selected in "HDMI Audio Out" setting, HDMI audio signal will be mute and the audio signals output from DIGITAL OUT jack changes depending on "Digital Out" setting.

Quick → HDMI Audio Out → Audio Mute → Digital Out

Bitstream* :

When playing back discs recorded in Dolby Digital, Dolby Digital Plus, Dolby TrueHD, DTS or DTS-HD, the corresponding core stream (Dolby Digital or DTS) are output.

LPCM :

LPCM signal will be output from DIGITAL OUT jack.

- This setting is not effective when the HDMI audio signal is output.

Audio signals output from DIGITAL OUT (OPTICAL / COAXIAL) jack

For the settings in the "Digital Out" to take effect, "HDMI Audio Out" should be set to "Audio Mute". Otherwise, the settings made in the "HDMI Audio Out" will have a priority, and the same signal as being output from the HDMI OUT jack will be output from the DIGITAL OUT jack as well. (Except that Dolby Digital will be output instead of Dolby Digital Plus and Dolby TrueHD, and DTS signal will be output instead of DTS-HD.)

Media	Recording format	"Digital Out" setting			
		Bitstream		LPCM	
		When "BD Audio Mode" is set to "HD Audio Output"	When "BD Audio Mode" is set to "Mix Audio Output"	When "BD Audio Mode" is set to "HD Audio Output"	When "BD Audio Mode" is set to "Mix Audio Output"
BD-video	Dolby Digital	Dolby Digital	Dolby Digital	2ch Downmix LPCM	2ch Downmix LPCM
	Dolby Digital Plus	Dolby Digital	Dolby Digital	2ch Downmix LPCM ^{*1}	2ch Downmix LPCM ^{*2}
	Dolby TrueHD	Dolby Digital	Dolby Digital	2ch Downmix LPCM ^{*3}	2ch Downmix LPCM ^{*4}
	DTS	DTS	DTS	2ch Downmix LPCM	2ch Downmix LPCM
	DTS-HD	DTS	DTS	2ch Downmix LPCM ^{*1}	2ch Downmix LPCM ^{*5}
	LPCM	2ch Downmix LPCM	2ch Downmix LPCM	2ch Downmix LPCM	2ch Downmix LPCM
DVD-video	Dolby Digital	Dolby Digital		2ch Downmix LPCM	
	DTS	DTS		2ch Downmix LPCM	
	LPCM	2ch LPCM		2ch LPCM	
AVCHD	Dolby Digital	Dolby Digital		2ch Downmix LPCM	
	LPCM	2ch Downmix LPCM		2ch Downmix LPCM	
audio CD / MP3 / Windows Media™ Audio		2ch LPCM		2ch LPCM	
DTS-CD		DTS		2ch Downmix LPCM	

*1) Full decoded.

*2) Only the independent substream is decoded.

*3) Dolby TrueHD stream is decoded.

*4) Only the Dolby Digital substream is decoded.

*5) Only the core substream is decoded.

- When playing back a BD-video which only contains the primary audio, the audio output will be the same case as the "HD Audio Output" even if the "BD Audio Mode" is set to "Mix Audio Output".

Note

- In order to output LPCM signal from DIGITAL OUT jack while outputting the HDMI audio signal, set "HDMI Audio Out" setting to "HDMI Multi(LPCM)".

FUNCTION SETUP

Speaker setting (Available when you have HDMI cable connected to HDMI OUT jack)

This unit allows you to enjoy multi-channel surround sound such as 7.1-channel / 5.1-channel surround. To make the most of its feature, set up your speakers appropriately by referring to the following table.

How to navigate through "HDMI Multi(LPCM)":

- 1) Use [▲ / ▼] to select your desired menu item then press [ENTER].
- 2) Use [▲ / ▼] to select your setting items.
 - Press [RETURN] to go back to the previous screen.
- 3) Use [◀ / ▶] to select desired options. (Except for "Test Tone", "Default" and setting options in "Speaker Size" setting.)

For setting options in "Speaker Size" setting:
Press [ENTER] to select desired options.

For "Test Tone":

Use [◀ / ▶] to select "Off", "Manual" or "Auto", then press [ENTER].

- The test tone will be output. If you select "Manual", use [▲ / ▼] to select desired speaker, then use [◀ / ▶] to adjust the volume. If you select "Auto", use [◀ / ▶] to adjust the volume of the speaker that outputs the test tone.
- If you want to stop the test tone, press [RETURN].

For "Default":

Press [ENTER] to reset to the default.

- 4) Press [SETUP] to exit.

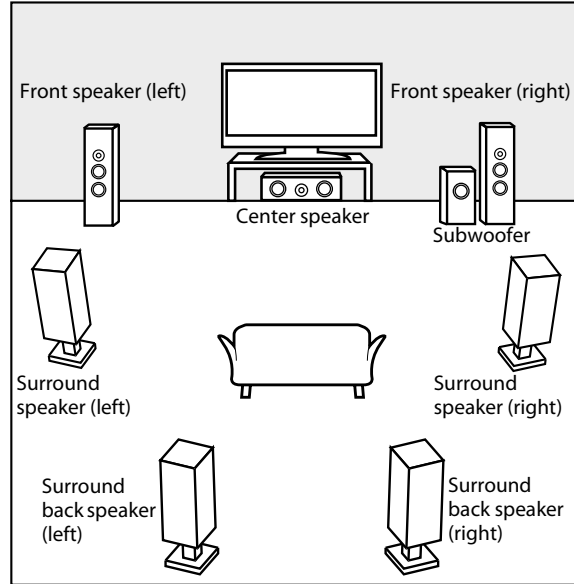

<Speaker setting for the audio signal output from HDMI OUT jack>

Quick → HDMI Audio Out → HDMI Multi(LPCM)			
Custom → Audio → HDMI Audio Out → HDMI Multi(LPCM)			
Menu	Setting items	Options	Descriptions
Speaker Size Selects the desired speaker to set. Then change the setting by referring to the descriptions.	Front	Large*	Large: For the large speakers with strong low frequency reproduction capabilities.
		Small	
	Center	Large*	Small: For the small speakers which do not provide strong bass sound.
		Small	
	Subwoofer	On	You cannot change the setting of "Subwoofer".
	Surround	Large*	Speakers which are not supported by the connected device will be displayed in gray.
		Small	
Surround Back	Large*		
	Small		
Default			Select "Default", then press [ENTER] to reset "Speaker Size" setting to the default.

FUNCTION SETUP

Menu	Setting items	Options	Descriptions
Channel Level Tests or sets the volume for each speaker.	Test Tone: "Test Tone" is the test tone which can be output from the speakers so you can adjust the volume for each speaker.	Off*	Select "Off" to deactivate "Test Tone". Select "Manual", then press [ENTER] to manually set the volume for the desired speaker. Select "Auto", then press [ENTER] to automatically output the test tone from each speaker.
		Manual	
		Auto	
	Front Lch	0dB to -12dB (0dB*)	If you have selected "Manual" in "Test Tone", select the desired speaker to set and adjust the volume for the selected speaker. If you select "Auto" in "Test Tone", test tone will automatically be output in order. Adjust the volume of the speaker that outputs the test tone.
	Center	0dB to -12dB (0dB*)	
	Subwoofer	0dB to -12dB (0dB*)	
	Front Rch	0dB to -12dB (0dB*)	
	Surround Rch	0dB to -12dB (0dB*)	
	Surround Back Rch	0dB to -12dB (0dB*)	
	Surround Back Lch	0dB to -12dB (0dB*)	
Surround Lch	0dB to -12dB (0dB*)		
Default		Select "Default", then press [ENTER] to reset "Channel Level" setting to the default.	
Delay Time This is a parameter for optimizing the timing at which the sound outputs from the speakers according to the distance from the listening position.	Distance	Feet*	Set the desired measure system. This measure system will be used for "Delay Time" setting. Press [ENTER] to switch the settings.
		Meters	
	Front	0ft to 60ft (12ft*) (0 m to 18 m (3.6 m*))	Select the distance from the listening position to the speaker to get the ideal delay time.
	Center	0ft to 60ft (12ft*) (0 m to 18 m (3.6 m*))	
	Surround	0ft to 60ft (10ft*) (0 m to 18 m (3.0 m*))	
	Surround Back	0ft to 60ft (10ft*) (0 m to 18 m (3.0 m*))	
	Default		Select "Default", then press [ENTER] to reset "Delay Time" setting to the default.

)Settings with () are the default.

- For "Speaker Size" setting, the settings of each speaker size may be adjusted automatically corresponding to each setting. (e.g. If "Front" is set to "Small", you cannot set "Center", "Surround", and "Surround Back" to "Large".)
- For "Delay Time", the difference between the value of the "Front", "Surround" and "Surround Back" setting cannot exceed 15 ft (4.5m), and the difference between the value of the "Front" and "Center" setting cannot exceed 5 ft (1.5m).
- For "Delay Time", the value of the "Center", "Surround" and "Surround Back" setting cannot exceed the value of the "Front" setting.
- For "Delay Time", the setting of "Center", "Surround" and "Surround Back" will be changed automatically to the setting value of the "Front". (e.g. If the "Front" is set to 60ft (18m), the setting of "Center", "Surround" and "Surround Back" will be changed to 60ft (18m) as well.)

FUNCTION SETUP

■ Parental

Ratings control allows you to set a limit, which prevents your children from viewing inappropriate materials. Playback will be stopped if the ratings exceed the levels you set, and it will require you to enter a password before playing back the disc.

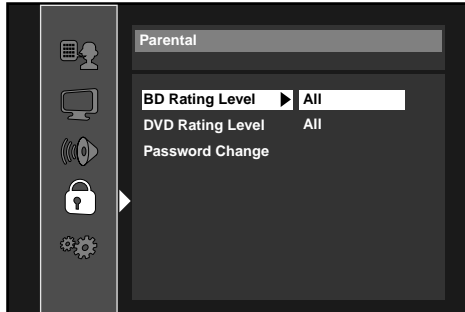

1 Use [**▲** / **▼**] to select , then press [**ENTER**].

2 Use [**Number buttons**] to enter your 4-digit password.

For the first time use: Use [**Number buttons**] to enter any 4-digit number (except for 4737), then press [**ENTER**].

That number will be used as the password from the second time. Record your password in case you forget it.

- If you forget the password, enter [**4**], [**7**], [**3**], [**7**]. The password will be cleared and rating level will be set to "All".
- While you input the password, press [**CLEAR**] to clear the number, then re-enter the password.

3 Proceed to **A – C**

A) BD Rating Level

1) Use [**▲** / **▼**] to select "BD Rating Level", then press [**ENTER**].

2) Use [**▲** / **▼**] to select your desired option, then press [**ENTER**].

"All": To release the limitation.

"Age Setting": To set the age limitation.

- After selecting "Age Setting", use [**Number buttons**] to enter the age from 0 – 254.
(e.g. for age 15, press [**0**], [**1**], [**5**])

3) Press [**SETUP**] to exit.

B) DVD Rating Level

1) Use [**▲** / **▼**] to select "DVD Rating Level", then press [**ENTER**].

2) Use [**▲** / **▼**] to select your desired level, then press [**ENTER**].

3) Press [**SETUP**] to exit.

RATING EXPLANATIONS

- **All** : Parental Control is inactive; all discs can be played back.
- **8 [Adult]** : DVD software of any grades (adult / general / children) can be played back.
- **7 [NC-17]** : No one under 18 admitted.
- **6 [R]** : Restricted; under 18 requires accompanying parent or adult guardian.
- **5 [PGR]** : Parental guidance recommended.
- **4 [PG-13]** : Unsuitable for children under 13.
- **3 [PG]** : Parental guidance suggested.
- **2 [G]** : General audience.
- **1 [Kid Safe]** : Suitable for children.

C) Password Change

1) Use [**▲** / **▼**] to select "Password Change", then press [**ENTER**].

2) Enter a new 4-digit password, then press [**ENTER**].

3) Press [**SETUP**] to exit.

FUNCTION SETUP

Others

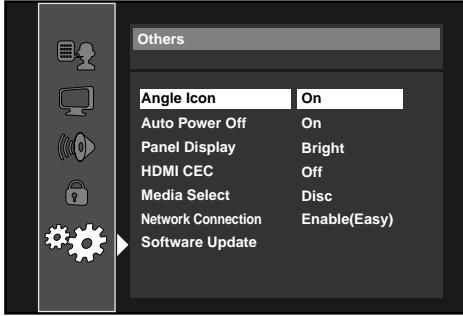

- To select the setting items and options, refer to “ Custom” on page 34.
- “ Quick” menu consists of the setting menus frequently used, and they are accompanied with .

Setting items	Options			
Angle Icon	On*: The angle icon appears on the TV screen when playing back the scene with various angle.			
	Off: The angle icon does not appear on the TV screen.			
Auto Power Off	On*: If this unit is left with no activity for more than 30 minutes, this unit turns off automatically.			
	Off: Deactivate the auto power off function.			
Panel Display Sets the brightness of the front panel display.	Auto: Front panel display gets darker during playback.			
	Bright*: Front panel display gets brighter.			
	Dimmer: Front panel display gets darker.			
HDMI CEC Sets whether to utilize the HDMI CEC function. Refer to page 45.	On			
	Off*			
Media Select Selects the media to playback.	Disc*: Select this when you play back a disc.			
	SD Card: Select this when you play back an SD Memory Card.			
Network Connection	Connection Test		Perform the network connection test. After you change the IP address or DNS setting, always perform this test.	
	Enable(Easy)*		If you select “Enable(Easy)”, connection test will automatically start.	
	Enable(Custom)	IP Address Setting	Auto(DHCP)*	Set the IP address.
			Manual	IP Address
Subnet Mask				
Default Gateway				
DNS Setting	Auto(DHCP)*	Manual	Set the DNS setting.	
		Primary DNS	Secondary DNS	In most cases, you can connect to the Internet without making any changes to the default setting.

FUNCTION SETUP

Setting items	Options			
Network Connection	Enable(Custom)	Proxy Setting	Do Not Use*	Set the proxy server. In most cases, you can connect to the Internet without using proxy server.
			Use	
			Proxy Port	
	Connection Speed	Auto*	Set the connection speed.	
		10BASE Half	In most cases, you can connect to the Internet without making any changes to the default setting.	
10BASE Full				
100BASE Half				
100BASE Full				
BD-Live Setting	Allow*	You can restrict Internet access when BD-Live functions are used.		
	Limited Allow			
	Prohibit			
	MAC Address		You can check the MAC address.	
	Disable		Deactivate the network connection.	
Software Update Allows you to update this unit's firmware. Refer to page 49.	Current Version: Indicates the current firmware version.			
	Disc Update: Allows you to update this unit's firmware using a disc.	No*		
		Yes		

HDMI CEC (REGZA - LINK)

You can control all HDMI CEC compatible components connected via an HDMI cable by simple button operations of the remote control of this unit. In order to enable the function, you need to set "HDMI CEC" to "On".

One Touch Play

When the operations with following buttons of the remote control of this unit are performed, the TV will automatically be turned on and switched to the appropriate input channel.

Buttons for one touch play:

- [PLAY ►]
- [TOP MENU] or [POP MENU / MENU] (when a disc is inserted in the unit)

Standby

When you press and hold [ON/STANDBY ⏻] for 2 seconds, it turns off the power of the TV first and then turns off the power of this unit.

When the connected HDMI CEC compatible display device is turned off, this unit may also turn off together.

System Information

Get & Set Menu Language

The unit recognizes the OSD language set for the TV and automatically sets the same language as the player menu language (OSD menu language) for this unit.

- This feature is available only when "Auto(XXXX)" is selected in "Player Menu" in the setup menu. (Refer to "Player Menu" on page 35.)

Receiving operational signal from TV's remote control:

You can operate this unit with TV's remote control. Check your TV owner's manual for details.

- This function may not work properly depending on the connected TV.
- The available operation may differ depending on the TV's remote control you use.
- Other components must be compatible with HDMI CEC in order to use this function.

FUNCTION SETUP

Network Connection

Set up the network connection settings in order to use the BD-Live function with a BD-Live disc.

Connection Test

After you made IP address/DNS settings or when a LAN cable is connected, always perform the connection test to check if the connection is correctly made.

- 1 In stop mode, press [SETUP].
- 2 Use [▲ / ▼] to select , then press [ENTER].
- 3 Use [▲ / ▼] to select "Others", then press [ENTER].
- 4 Use [▲ / ▼] to select "Network Connection", then press [ENTER].
- 5 Use [▲ / ▼] to select "Connection Test", then press [ENTER].

Connection test will start automatically and the test result will appear right after the connection test finishes.

- "Testing..." : The test is in progress.
- "Pass" : Connection test is successfully completed.
- "Fail" : Connection test failed.

Check the connection settings.

Press [ENTER] to go to the list of network status confirmation screen.

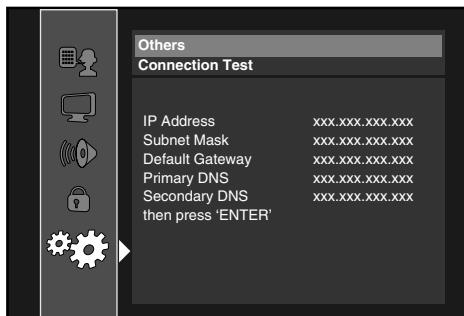

- 6 Press [ENTER] to go back to the previous screen, or press [SETUP] to exit.

Note

- If the connection test passes, you can enjoy the BD-Live functions using the Internet without making any extra settings.
- If the connection test fails, you may need to change the MAC address settings of your router. You can check the MAC address of this unit on "Enable(Custom)" screen.
- "Connection Test" is not available when "Disable" is selected in "Network Connection".

Enable(Easy)

Network settings are set to the following settings initially. (In most cases, you can connect to the Internet without making any changes to the default settings.)

- IP Address Setting Auto(DHCP)
- DNS Setting Auto(DHCP)
- Proxy Setting Do Not Use
- Connection Speed Auto
- BD-Live Setting Allow

If you want to set the network settings back to the default settings as above (except "BD-Live Setting"), follow the procedure below.

- 1 Follow steps 1 to 4 in "Connection Test" on this page.
- 2 Use [▲ / ▼] to select "Enable(Easy)", then press [ENTER].
 - The unit will start the connection test automatically and the test result will appear right after the test finishes.
 - After the connection test finishes, press [ENTER] to go to network status confirmation screen.
- 3 Press [ENTER] to activate the network settings and set the network connection automatically. Press [SETUP] to exit.

Note

- The setting of "BD-Live Setting" will not be set back to the default, even if you follow the procedure.

Enable(Custom)

In following cases, select "Enable(Custom)" to set each setting as necessary.

- When connection test failed with the setting of "Enable(Easy)".
- When instructed by your Internet service provider to make specific settings in accordance with your network environment.

• IP Address Setting / DNS Setting

- 1 Follow steps 1 to 4 in "Connection Test" on this page.
- 2 Use [▲ / ▼] to select "Enable(Custom)", then press [ENTER].
- 3 Use [▲ / ▼] to select "IP Address Setting", then press [ENTER] repeatedly to select the desired setting.

- | | |
|--------------|---|
| "Auto(DHCP)" | : If your router has DHCP server function, select "Auto(DHCP)". |
| "Manual" | : If your router does not have DHCP server function, select "Manual". |

FUNCTION SETUP

If you select "Manual", follow the following instruction to set the IP address and DNS.

- 3-a) Use [▲ / ▼] to select "IP Address", "Subnet Mask" or "Default Gateway", then press [ENTER]. IP address setting screen will appear. Enter IP address, subnet mask and default gateway with cursor buttons and number buttons.

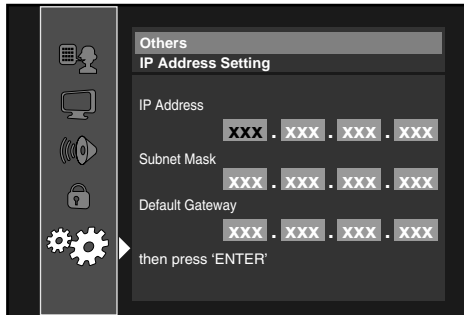

- Enter the IP address number after checking the specifications of your router.
- If the IP address number is unknown, check the IP address number of other devices (e.g. PC connected via LAN cable) and assign a different number from those of other devices.

- 3-b) After you enter all correctly, press [ENTER].
- Confirmation message will appear. Select "Yes" to complete the settings.

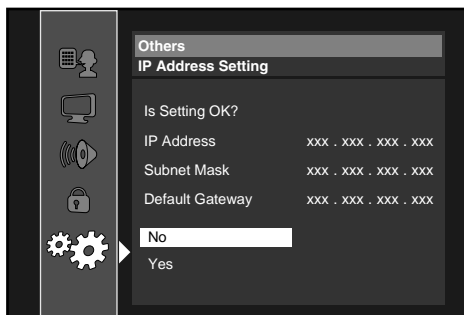

- 3-c) Use [▲ / ▼] to select "Primary DNS" or "Secondary DNS", then press [ENTER]. DNS setting screen will appear. Enter primary DNS and secondary DNS with cursor buttons and number buttons.

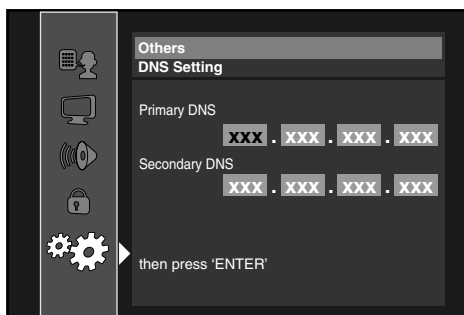

- Enter the numbers instructed by your Internet provider.
- If the number is unknown, check the number of other devices (e.g. PC connected via LAN cable) and assign the same number.

- 3-d) After you enter all correctly, press [ENTER].

- Confirmation message will appear. Select "Yes" to complete the settings.

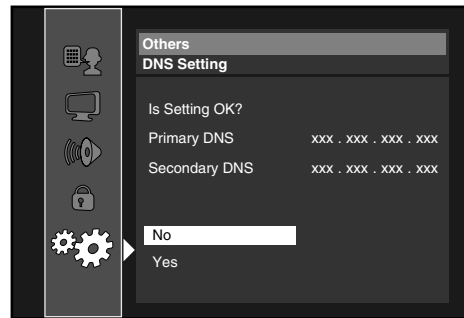

- 4 Press [RETURN] to go back to the previous screen, or press [SETUP] to exit.

Note

- The range of input number is between 0 and 255.
- If you enter a number larger than 255, the number will automatically be 255.
- The manually entered number will be saved even if you change the setting to "Auto(DHCP)".
- When you enter a wrong number, press [CLEAR] to cancel. (The number will be back to "0".)
- If you want to enter 1 or 2 digit number in one cell, press [▶] to move on to the next cell.
- If the entered IP address or the default gateway or primary DNS number is same as the default setting, IP address setting will be set to "Auto(DHCP)". (The manually entered number will be saved.)
- When IP address setting is set to "Manual", the setting of DNS setting will automatically be "Manual" and when IP address setting is set to "Auto(DHCP)", you can set either "Auto(DHCP)" or "Manual" for DNS setting.

• Proxy Setting

- 1 Follow steps 1 to 4 in "Connection Test" on page 46.
- 2 Use [▲ / ▼] to select "Enable(Custom)", then press [ENTER].
- 3 Use [▲ / ▼] to select "Proxy Setting", then press [ENTER] repeatedly to select the desired setting.

- For default settings, select "Do Not Use".
- If you need to change the proxy setting as instructed by your Internet service provider to set the designated proxy address and port, select "Use".

If you select "Use", follow the following instructions to set the proxy address and proxy port.

FUNCTION SETUP

- 3-a) Use [▲ / ▼] to select "Proxy Address", then press [ENTER]. Proxy address setting screen will appear.
 Enter proxy address.
 • The keyboard screen will appear.

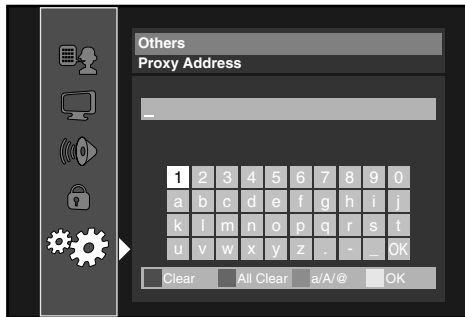

[▲ / ▼ / ◀ / ▶] : Move the highlight.
 [Number buttons] : Enter number.
 [ENTER] : Enter the highlighted number/word.
 [RED] : Clear the entered number or word.
 [GREEN] : Clear all the entered numbers or words.
 [BLUE] : Switch between abc ? ABC ? @!?
 [YELLOW] : Set the entered number or word.

- 3-b) After you enter proxy address correctly, press [YELLOW].
 • Confirmation message will appear. Select "Yes" to complete the settings.



- 3-c) Use [▲ / ▼] to select "Proxy Port", then press [ENTER]. Proxy port setting screen will appear.
 Enter proxy port number with number buttons.

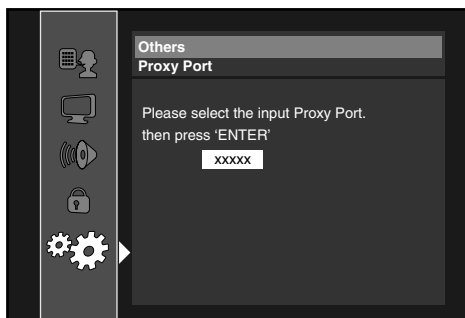

- 3-d) After you enter proxy port correctly, press [ENTER].

- 4 Press [RETURN] to go back to the previous screen, or press [SETUP] to exit.

Note

- The range of input number for the port number is between 0 and 65535. (If you enter a number larger than 65535, it will be regarded as 65535.)
- For proxy port, the selected ports may be blocked and not be able to use depending on your network environment.

• **Connection Speed**

You can set connection speed as your preference. (The default setting is "Auto".)

- 1 Follow steps 1 to 4 in "Connection Test" on page 46.
- 2 Use [▲ / ▼] to select "Enable(Custom)", then press [ENTER].
- 3 Use [▲ / ▼] to select "Connection Speed", then press [ENTER].
- 4 Use [▲ / ▼] to select the desired setting, then press [ENTER].

"Auto":

Set the appropriate connection speed automatically, in accordance with your network environment.

"10BASE Half":

Set the connection speed to "10BASE Half".

"10BASE Full":

Set the connection speed to "10BASE Full".

"100BASE Half":

Set the connection speed to "100BASE Half".

"100BASE Full":

Set the connection speed to "100BASE Full".

- 5 Press [RETURN] to go back to the previous screen, or press [SETUP] to exit.

Note

- Choose a connection speed in accordance with your network environment.
- The network connection may be disabled depending on the device, when the settings are changed.

FUNCTION SETUP

• BD-Live Setting

You can limit the Internet access from the BD-Live functions. (The default setting is "Allow".)

- 1 Follow steps 1 to 4 in "Connection Test" on page 46.
- 2 Use [▲ / ▼] to select "Enable(Custom)", then press [ENTER].
- 3 Use [▲ / ▼] to select "BD-Live Setting", then press [ENTER].
- 4 Use [▲ / ▼] to select the desired setting, then press [ENTER].

"Allow":

Internet access is permitted from all BD-Live contents.

"Limited Allow":

Internet access is permitted only for BD-Live contents which have content owner certificates. Internet access without the certificates are prohibited.

"Prohibit":

Internet access is prohibited from all BD-Live contents.

- 5 Press [RETURN] to go back to the previous screen, or press [SETUP] to exit.

Disable

Deactivate all the network connection and settings.

- 1 Follow steps 1 to 4 in "Connection Test" on page 46.
- 2 Use [▲ / ▼] to select "Disable", then press [ENTER].
- 3 Press [RETURN] to go back to the previous screen, or press [SETUP] to exit.

Note

- The network connection can be reactivated by setting the network connection to "Enable(Easy)" or "Enable(Custom)".

Software Update

Current Version

You can confirm the current software version.

- 1 Follow steps 1 to 3 in "Connection Test" on page 46.
- 2 Use [▲ / ▼] to select "Software Update", then press [ENTER].

- 3 Use [▲ / ▼] to select "Current Version", then press [ENTER].



- 4 Press [ENTER] or [RETURN] to exit.

Note

- Please visit <http://www.toshiba.ca> to download the latest firmware version.

Disc Update

You can upgrade the software by using disc.

- 1 Follow steps 1 to 3 in "Connection Test" on page 46.
- 2 Use [▲ / ▼] to select "Software Update", then press [ENTER].
- 3 Use [▲ / ▼] to select "Disc Update", then press [ENTER].
- 4 Use [▲ / ▼] to select "Yes", then press [ENTER].
- 5 Disc tray will open automatically.
 - Insert the disc for software update and then press [OPEN/CLOSE ▲].
- 6 After completing loading disc, confirmation message will appear. Select "Yes" and press [ENTER] to start upgrading.
 - It may take awhile to complete the updating. (Please wait until "100%" appears on the front panel display.)
- 7 After the disc update finishes, this unit will restart and eject the disc.

Note

- You can check the current firmware version in "Current Version" in "Software Update" menu.
- Please do not unplug the AC power cord while executing the "Disc Update".
- All settings will remain the same even if you update the firmware version.

FUNCTION SETUP

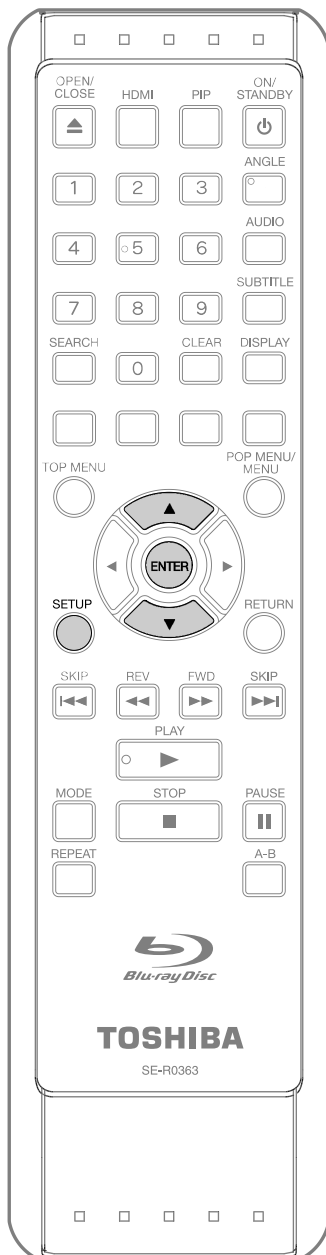

Initialize

Initialize the setting or SD Memory Card.

- 1** In stop mode, press [SETUP].
- 2** Use [▲ / ▼] to select , then press [ENTER].
- 3** Use [▲ / ▼] to select a desired option, then press [ENTER].
 - “Setup”:**
Resets the setup menu to the default. The setting for “Parental”, “Network Connection” and “Media Select” will not be reset.
 - “Format SD Card” (Available only when an SD Memory Card is inserted.):**
Initializes the SD Memory Card. After confirmation message appears, use [▲ / ▼] to select “Yes”, then press [ENTER].
 - “Erase Saved BD-ROM Data (Player)”:**
Clears the data saved for the BD-ROM contents, such as BD-ROM game scores, from this player.
 - “Erase Saved BD-ROM Data (SD Card)” (Available only when an SD Memory Card is inserted.):**
Clears the supplemental data for the BD-ROM playback, such as subtitle data, from the SD Memory Card.
 - “Network Settings”:**
Resets the Network Settings menu to the default.
- 4** Press [ENTER]. (For “Setup” and “Format SD Card” only)
 - Final confirmation message will appear. Select “Yes”, then press [ENTER].
- 5** Press [SETUP] to exit.

Caution

- Do not remove the SD Memory Card while executing the “Format SD Card” or the “Erase Saved BD-ROM Data (SD Card)”. It damages the card.

OTHERS

Troubleshooting

If the unit does not perform properly when operated as instructed in this manual, check the unit, consulting the following checklist.

Problem	Solution
No power	<ul style="list-style-type: none"> - Check if the AC cord is properly connected. - Unplug the AC cord once, and wait for 5-10 seconds and then plug it in again.
No sound or picture	<ul style="list-style-type: none"> - Check if the connected TV is turned on. - Check if the connections are made securely and correctly. - Check whether the connected TV or other device supports HDCP. (This unit will not output a video signal unless the other device supports HDCP.) - Check whether the output format of this unit (HDMI FORMAT) matches the supported input format of other connected device.
Distorted picture	<ul style="list-style-type: none"> - Sometimes a small amount of picture distortion may appear. This is not a malfunction. - Connect this unit directly to the TV. If the composite audio / video cables are connected to a VCR, pictures may be distorted due to the copy right protection system.
Completely distorted picture or black / white picture with BD / DVD	<ul style="list-style-type: none"> - Make sure the disc is compatible with this unit.
No sound or distorted sound	<ul style="list-style-type: none"> - Adjust the volume. - Check if speakers are connected correctly. - Check the HDMI connections. - Check the settings in "Audio" menu.
Picture freezes momentarily during playback	<ul style="list-style-type: none"> - Check the disc for fingerprints / scratches and clean with a soft cloth wiping from center to edge. - Clean the disc.
Disc cannot be played back	<ul style="list-style-type: none"> - Clean the disc. - Ensure the disc label is facing up. - Check if the disc is defective by trying another disc. - Cancel the ratings control or change the control level. - Insert a correct disc that can be played back on this unit.
SD Memory Card cannot be read	<ul style="list-style-type: none"> - The format of the card does not match that accepted by this unit or the card is not compatible.
No return to start-up screen when disc is removed	<ul style="list-style-type: none"> - Reset this unit by turning it off, then on again.
The unit does not respond to the remote control	<ul style="list-style-type: none"> - Aim the remote control directly at infrared sensor window on the front panel. - Reduce the distance to infrared sensor window. - Replace the batteries in the remote control. - Re-insert the batteries with their polarities (+ / - signs) as indicated.
Buttons do not work or the unit stops responding	<ul style="list-style-type: none"> - To completely reset the unit, press and hold [ON/STANDBY ⏻] on the front panel for 10 seconds to shut down the unit or unplug the AC cord from the AC outlet for 5-10 seconds.
The unit does not respond to some operating commands during playback	<ul style="list-style-type: none"> - Operations may not be permitted by the disc. Refer to the instructions of the disc.
The unit cannot read BD / DVD / CD	<ul style="list-style-type: none"> - Dew condensation may form inside the unit. Do not use this unit for at least a few hours until its inside gets dry. - You are attempting to playback a disc other than one with one of the Logos on page 17. - Wipe the dirt off the disc or replace the disc.
Angle does not switch	<ul style="list-style-type: none"> - The angle cannot be switched for BD / DVD which do not contain multiple angles. In some cases multiple angles are only recorded for specific scenes.
Playback does not start when the title is selected	<ul style="list-style-type: none"> - Check the settings in "Parental" menu.
The password for rating level has been forgotten	<ul style="list-style-type: none"> - Enter the default password "4737", then your forgotten password will be cleared.

INTRODUCTION

CONNECTIONS

PLAYBACK

FUNCTION SETUP

OTHERS

OTHERS

Problem	Solution
Cannot connect to the network	<ul style="list-style-type: none">- Check if the LAN cable connection is properly made.- Turn on the modem or broadband router.- Check the network setting.- Check if the broadband router and/or modem is correctly connected.- Check the "BD-Live Setting".
Cannot connect to the network while my PC is connected to the network	<ul style="list-style-type: none">- Check the content of your Internet service contract to see if your Internet service provider prevents multiple terminals connecting at the same time.
Cannot use the BD-Live function	<ul style="list-style-type: none">- Use an SD card with enough space.
The playback of BD-video or download of data does not perform properly	<ul style="list-style-type: none">- Check if an SD Card is correctly inserted. Do not remove the card during playback as some BD-videos require an SD Card during playback.

Note

- Some functions are not available in specific modes, but this is not a malfunction. Read the description in this manual for details on correct operations.
- Some functions are prohibited on some discs.

OTHERS

Glossary

Analog Audio

An electrical signal that directly represents sound. Compare this to digital audio which can be an electrical signal, but is an indirect representation of sound. See also "Digital Audio".

Aspect Ratio

The width of a TV screen relative to its height. Conventional TVs are 4:3 (in other words, the TV screen is almost square); widescreen models are 16:9 (the TV screen is almost twice as wide as it is high).

AVCHD

AVCHD is a new format for high definition video camcorders which can record and play high-resolution HD images.

BD-Java

With some BD which support Java applications, you can enjoy the interactive functions such as games or interactive menus.

BD-Live

BD-Live is a BD-video (BD-ROM version 2 Profile 2.0/ Profile 1.1) which contains new functions (e.g. Internet connection), in addition to the BONUSVIEW function.

Blu-ray Disc (BD)

Blu-ray Disc is a next generation optical video disc which is capable of storing much more data than a conventional DVD is. The large capacity makes it possible to benefit from the features such as high-definition videos, multi-channel surround sounds, interactive menus and so on.

Chapter

Just as a book is split up into several chapters, a title on a BD-video or DVD-video is usually divided into chapters. See also "Title".

Component Video Output

Each signal of luminance (Y) and component (P_B/C_B, P_R/C_R) is independent to output so that you can experience picture Color as it is. Also, due to compatibility with progressive video (525p/480p), you can experience higher-density picture than that in interlace (525i/480i).

Digital Audio

An indirect representation of sound by numbers. During recording, the sound is measured at discrete intervals (44,100 times a second for CD audio) by an analog-to-digital converter, generating a stream of numbers. On playback, a digital-to-analog converter generates an analog signal based on these numbers. See also "Sampling Frequency" and "Analog Audio".

DNS Server

A server which translates Internet domain names into IP addresses.

Dolby Digital

The system to compress digital sound developed by Dolby Laboratories. It offers you sound of stereo (2ch) or multi-channel audio.

Dolby Digital Plus

Dolby Digital Plus is the next generation digital audio compression technology developed as an extension to Dolby Digital. Blu-ray Disc supports 7.1 multi-channel surround sound output.

Dolby TrueHD

Dolby TrueHD is a lossless coding technology developed for next generation optical discs. Blu-ray Disc supports 7.1 multi-channel surround sound output.

DTS (Digital Theater System)

DTS is a multi-channel surround sound system. By connecting to DTS decoder, you can enjoy movie dynamic and realistic sound like movie theater. DTS surround sound technologies were developed by DTS, Inc.

DTS-HD

DTS-HD is a lossless coding technology developed as an extension of the original DTS Coherent Acoustics format. Blu-ray Disc supports 7.1 multi-channel surround sound output.

Gateway

IP Address of the electronic devices (such as router) which provide Internet access.

HDMI (High-Definition Multimedia Interface)

A digital interface between audio and video source. It can transmit component video, audio, and control signal with one cable connection.

Hub

A device used for connecting multiple device to the network.

IP Address

A set of numbers which are assigned to devices participating in a computer network.

JPEG (Joint Photographic Experts Group)

JPEG is a method of compressing still picture files. You can copy JPEG files on BD-RE/-R, DVD-RW/-R, CD-RW/-R or SD Memory Card from a computer and play back the files in this unit.

LAN (Local Area Network)

A group of computer networks covering a small area like a company, school or home.

OTHERS

Local Storage

A storage area of sub contents for playing virtual packages on BD-video.

MP3 (MPEG audio layer 3)

MP3 is a method of compressing files. You can copy MP3 files on BD-RE/-R, DVD-RW/-R, CD-RW/-R or SD Memory Card from the computer and play back the files on this unit.

PCM (Pulse Code Modulation)

The most common system of encoding digital audio, found on CD and DAT. Excellent quality that requires a lot of data compared to formats such as Dolby Digital and MPEG audio. For compatibility with digital audio recorders (CD, MD and DAT) and AV amplifiers with digital inputs, this unit can convert Dolby Digital, DTS, and MPEG audio to PCM. See also "Digital Audio".

Proxy Server

Proxy server is a server which acts as an intermediary between a workstation user and the Internet to ensure security.

Region Code

Regions associate discs and players with particular areas of the world. This unit will only play back discs that have compatible region codes. You can find the region code of your unit by looking on the rear panel. Some discs are compatible with more than one region (or all regions).

Router

A networking device which distinguishes the IP address assigned to each device and routing and forwarding information in the computer network.

Sampling Frequency

The rate which sound is measured by a specified interval to turn into digital audio data. The numbers of sampling in one second defines as sampling frequency. The higher the rate, the better the sound quality.

Subnet Mask

A mask which is used to determine what subnet an IP address belongs to.

Title

A collection of chapters on BD-video or DVD-video. See also "Chapter".

Track

Audio CD use tracks to divide up the content of a disc. The BD-video or DVD-video equivalent is called a chapter. See also "Chapter".

Virtual Package

The function which copies data to other media (local storage) from the Internet and play the secondary video, secondary audio and the subtitle at the same time. The method of the playback varies depending on discs.

Windows Media™ Audio

Windows Media™ Audio is the audio compressing technology developed by Microsoft. You can copy Windows Media™ Audio files on BD-RE/-R, DVD-RW/-R, CD-RW/-R or SD Memory Card from a computer and play them back on this unit.

x.v.Color

"x.v.Color" is a promotion name given to the products that have the capability to realize a wide color space based on the xvYCC specifications and is a trademark of Sony Corporation.

OTHERS

Language Code List

Language	Code	Language	Code	Language	Code	Language	Code
A-B		French [FRE]	5264	Macedonian	5957	Siswat	6565
Abkhazian	4748	Frisian	5271	Malagasy	5953	Slovak [SLO]	6557
Afar	4747	Galician	5358	Malay	5965	Slovenian	6558
Afrikaans	4752	Georgian	5747	Malayalam	5958	Somali	6561
Albanian	6563	German [GER]	5051	Maltese	5966	Spanish [SPA]	5165
Amharic	4759	Greek [GRE]	5158	Maori	5955	Sundanese	6567
Arabic	4764	Greenlandic	5758	Marathi	5964	Swahili	6569
Armenian	5471	Guarani	5360	Moldavian	5961	Swedish [SWE]	6568
Assamese	4765	Gujarati	5367	Mongolian	5960		
Aymara	4771	Hausa	5447	Nauru	6047	T	
Azerbaijani	4772	Hebrew	5569	Nepali	6051	Tagalog	6658
Bashkir	4847	Hindi	5455	Norwegian [NOR]	6061	Tajik	6653
Basque	5167	Hungarian [HUN]	5467			Tamil	6647
Bengali;Bangla	4860			O-R		Tatar	6666
Bhutani	5072	I-K		Occitan	6149	Telugu	6651
Bihari	4854	Icelandic [ICE]	5565	Oriya	6164	Thai	6654
Bislama	4855	Indonesian	5560	Oromo (Afan)	6159	Tibetan	4861
Breton	4864	Interlingua	5547	Panjabi	6247	Tigrinya	6655
Bulgarian [BUL]	4853	Interlingue	5551	Pashto;Pushto	6265	Tonga	6661
Burmese	5971	Inupiak	5557	Persian	5247	Tsonga	6665
Byelorussian	4851	Irish [IRI]	5347	Polish [POL]	6258	Turkish [TUR]	6664
		Italian [ITA]	5566	Portuguese [POR]	6266	Turkmen	6657
C-E		Japanese [JPN]	5647	Quechua	6367	Twi	6669
Cambodian	5759	Javanese	5669	Rhaeto-Romance	6459		
Catalan	4947	Kannada	5760	Romanian [RUM]	6461	U-Z	
Chinese [CHI]	7254	Kashmiri	5765	Russian [RUS]	6467	Ukrainian	6757
Corsican	4961	Kazakh	5757			Urdu	6764
Croatian	5464	Kinyarwanda	6469	S		Uzbek	6772
Czech [CZE]	4965	Kirghiz	5771	Samoan	6559	Vietnamese	6855
Danish [DAN]	5047	Kirundi	6460	Sangho	6553	Volapuk	6861
Dutch [DUT]	6058	Korean [KOR]	5761	Sanskrit	6547	Welsh	4971
English [ENG]	5160	Kurdish	5767	Scots Gaelic	5350	Wolof	6961
Esperanto	5161			Serbian	6564	Xhosa	7054
Estonian	5166	L-N		Serbo-Croatian	6554	Yiddish	5655
		Laothian	5861	Sesotho	6566	Yoruba	7161
F-H		Latin	5847	Setswana	6660	Zulu	7267
Faroese	5261	Latvian;Lettish	5868	Shona	6560		
Fiji	5256	Lingala	5860	Sindhi	6550		
Finnish [FIN]	5255	Lithuanian	5866	Singhalese	6555		

Note

- If you choose a language that has a 3-letter-language code (written in bracket), the code will be displayed every time you change the audio or subtitle language setting on page 31. If you choose any other languages, "----" will be displayed instead.

OTHERS

Specifications

General

Signal system	NTSC color
Power requirements	120 V AC, 60 Hz
Power consumption	20 W (standby: 0.5 W)
Dimensions (width x height x depth)	17-3/16 x 2-1/4 x 8-5/8 inches (435 x 56 x 218 mm)
Weight	5.08 lbs. (2.3 kg)
Operating temperature	41°F (5°C) to 95°F (35°C)
Operating humidity	Less than 80 % (no condensation)

Terminals

Rear	Video output			
	RCA jack x 1	1 Vp-p (75Ω)		
	Component video output			
	RCA jack x 3	Y: 1 Vp-p (75Ω)	P _B /C _B : 700 mVp-p (75Ω)	P _R /C _R : 700 mVp-p (75Ω)
	HDMI output	Video: 480p, 720p, 1080i, 1080p, 1080p24 / Audio		
	Audio output (Analog)	L/R: 2 Vrms (output impedance: more than 1kΩ)		
	Audio output (Digital)			
	RCA jack x 1	500 mVp-p (75Ω)		
	Optical jack x 1	Digital connector		
	LAN terminal	10BASE-T/100BASE-TX		

Note

- The specifications and design of this product are subject to change without notice.

OTHERS

Maintenance

Servicing

- Please refer to relevant topics on "Troubleshooting" on page 51 before returning the product.
- If this unit becomes inoperative, do not try to correct the problem by yourself. There are no user-serviceable parts inside. Turn off, unplug the power plug, and please call our helpline to locate an Authorized Service Center.

Cleaning the cabinet

- Never use a solvent, thinner, benzene or alcohol to clean the unit. Do not spray insecticide liquid near the unit. Such chemicals may discolor the surface or damage the unit.

Cleaning discs

- When a disc becomes dirty, clean it with a cleaning cloth. Wipe the disc from the center to out. Do not wipe in a circular motion.
- Do not use solvents such as benzene, thinner, commercially available cleaners, detergent, abrasive cleaning agents or antistatic spray intended for analog records.

Cleaning the disc lens

- If this unit still does not perform properly although you refer to the relevant sections and to "Troubleshooting" in this manual, the laser optical pickup unit may be dirty. Consult your dealer or an Authorized Service Center for inspection and cleaning of the laser optical pickup unit.

Disc handling

- Handle the discs so that fingerprints and dust do not adhere to the surfaces of the discs.
- Always store the disc in its protective case when it is not used.
- Note that discs with special shapes (heart-shaped discs, octagonal discs, etc.) cannot be played back on this unit. Do not attempt to playback such discs, as they may damage the unit.

IR signal check

- If the remote control is not working properly, you can use a digital camera (including a cellular phone with built-in camera) to see if it is sending out an infrared signal.

With a digital camera (including built-in cell phone cameras):



Point a digital camera towards the remote control. Push any button on the remote control and look through the digital camera. If the infrared light appears through the camera, the remote control is working.

LIMITED WARRANTY

Limited Canadian Warranty For Toshiba Brand Digital Audio/Video Products

Toshiba of Canada Limited ("TCL") makes the following limited warranties to original consumers in Canada. **THESE LIMITED WARRANTIES EXTEND TO THE ORIGINAL CONSUMER PURCHASER OR ANY PERSON RECEIVING THIS TOSHIBA BRAND DIGITAL AUDIO/VIDEO PRODUCT (the "DAV PRODUCT(S)" or "DAV Product(s)") AS A GIFT FROM THE ORIGINAL CONSUMER PURCHASER AND TO NO OTHER PURCHASER OR TRANSFEREE.**

DAV PRODUCTS PURCHASED IN CANADA, AND USED ANYWHERE OUTSIDE OF CANADA INCLUDING, WITHOUT LIMITATION, THE UNITED STATES AND MEXICO, ARE NOT COVERED BY THESE WARRANTIES.

DAV PRODUCTS PURCHASED ANYWHERE OUTSIDE OF CANADA, INCLUDING, WITHOUT LIMITATION, THE UNITED STATES AND MEXICO, AND USED IN CANADA, ARE NOT COVERED BY THESE WARRANTIES.

Limited One (1) Year Warranty on Parts and Labour

Subject to the more limited warranty if the DAV Product is used for any commercial or business purposes as set out below, TCL warrants the DAV Product and its parts against material defects in materials or workmanship that result in the DAV Product failing for a period of one (1) year after the date of original retail purchase.

DURING THIS PERIOD, TCL WILL, AT TCL'S OPTION, REPAIR OR REPLACE A DEFECTIVE PART WITH A NEW OR REFURBISHED PART, WITHOUT CHARGE TO YOU FOR PARTS OR LABOUR. YOU MUST DELIVER THE ENTIRE DAV PRODUCT TO A TCL DAV PRODUCT AUTHORIZED SERVICE PROVIDER ("ASP"). YOU MUST PAY FOR ALL TRANSPORTATION AND INSURANCE CHARGES FOR THE DAV PRODUCT TO AND FROM THE ASP.

Rental Units

The warranty for DAV Product rental units begins with the date of first rental or thirty (30) days from the date of shipment to the rental firm, whichever comes first.

Limited Warranty for Commercial Units

TCL warrants DAV Products that are used for any commercial or business purposes as follows: all parts are warranted against material defects in materials or workmanship that result in the DAV Product failing for a period of ninety (90) days after the date of original retail purchase. **DURING THIS PERIOD, TCL WILL, AT TCL'S OPTION, REPAIR OR REPLACE A DEFECTIVE PART WITH A NEW OR REFURBISHED PART, WITHOUT CHARGE TO YOU FOR PARTS OR LABOUR. YOU MUST DELIVER THE ENTIRE DAV PRODUCT TO AN ASP. YOU MUST PAY FOR ALL TRANSPORTATION AND INSURANCE CHARGES FOR THE DAV PRODUCT TO AND FROM THE ASP.**

Your Responsibility

THE ABOVE WARRANTIES ARE SUBJECT TO THE FOLLOWING CONDITIONS:

- (1) You must provide your bill of sale or other proof of purchase.
- (2) All warranty servicing of this DAV Product must be performed by an ASP.
- (3) The warranties from TCL are effective only if the DAV Product is (i) purchased as new and unopened from TCL or from TCL's authorized distributors, dealers or resellers ("ADR's") and (ii) located/operated in Canada.
- (4) Warranties extend only to material defects in materials or workmanship as limited above, and do not extend to:
 - a. Service, repairs or replacement made necessary by accident, misuse, abuse, moisture, liquids, dust, dirt, neglect, accident, damage, 24/7 applications, improper installation, improper operation, improper cleaning, improper maintenance, normal wear and tear, or any other external cause or event, act or omission outside the control of TCL, including fire, theft, acts of God, alteration, power failures, power surges or power shortages, lightning, other electrical faults, or repairs, modifications or replacements by persons other than those authorized by TCL to service the DAV Product;
 - b. Replacement of missing, discarded or lost parts, the provision of retrofits, or preventive maintenance;

- c. Repair of damage that is cosmetic only or does not affect the DAV Product functionality, such as wear and tear, scratches and dents;
- d. Service on Toshiba-branded accessory items (such as accessory items may be covered by their own warranty);
- e. Service on third party products or service made necessary by use of incompatible third party products;
- f. Service made necessary by the simultaneous use of this DAV Product and connected equipment;
- g. Modifications to the DAV Product not approved in writing by TCL, and service made necessary by the use or installation of non-Toshiba modifications to the DAV Product;
- h. Service of a DAV Product on which the TOSHIBA label or logo, rating label or serial number have been defaced or removed;
- i. On-site service and repair of the DAV Product;
- j. Damage to the DAV Product caused by failure to follow the specifications, User manuals or guides as to usage and/or storage.

Disclaimer and Limitation of Remedy

TO THE EXTENT NOT PRECLUDED BY LAW, ALL OTHER EXPRESS AND IMPLIED WARRANTIES, CONDITIONS AND REPRESENTATIONS FOR THIS DAV PRODUCT, INCLUDING THE IMPLIED WARRANTIES AND CONDITIONS OF MERCHANTABILITY AND FITNESS FOR A PARTICULAR PURPOSE, ARE HEREBY DISCLAIMED AND EXCLUDED. IF THE APPLICABLE LAW, STATUTORY OR OTHERWISE, PRECLUDES THE EXCLUSION OF ANY IMPLIED WARRANTIES, CONDITIONS AND REPRESENTATIONS THEN SUCH IMPLIED WARRANTIES, CONDITIONS AND REPRESENTATIONS ARE OTHERWISE LIMITED IN DURATION TO THE TERM OF THIS EXPRESS WRITTEN LIMITED WARRANTY. TO THE EXTENT NOT PRECLUDED BY LAW, STATUTORY OR OTHERWISE, THIS WRITTEN WARRANTY SUPERCEDES AND SPECIFICALLY DISCLAIMS ANY OTHER WARRANTY, CONDITION OR REPRESENTATION NOT STATED IN THIS WARRANTY, WHETHER MADE BY TCL, TOSHIBA CORPORATION, THEIR AFFILIATES, ADRs AND ASPs AND WHETHER MADE ORALLY OR IN WRITING (INCLUDING ANY STATEMENT IN ANY BROCHURE, PRESS RELEASE, ANNOUNCEMENT, ADVERTISEMENT, POINT OF SALE DISPLAY, ETC.).

YOU MUST READ AND FOLLOW ALL SET-UP AND USAGE INSTRUCTIONS IN THE APPLICABLE USER GUIDES AND/OR MANUALS. IF YOU FAIL TO DO SO, THIS DAV PRODUCT MAY NOT FUNCTION PROPERLY AND YOU MAY SUFFER DAMAGE. THIS WARRANTY WILL NOT COVER ANY SERVICE THAT IS REQUIRED, IN PART OR IN WHOLE, AS A RESULT OF ANY FAILURE TO FOLLOW THE SET-UP AND USAGE INSTRUCTIONS. THIS WARRANTY DOES NOT APPLY AND SHALL BE VOID AND UNENFORCEABLE IF THE DAV PRODUCT IS OPENED, SERVICED, OR REPAIRED BY PERSONS OTHER THAN THOSE AUTHORIZED BY TCL TO SERVICE OR REPAIR THE DAV PRODUCT.

LIMITED WARRANTY

IF THE DAV PRODUCT FAILS TO WORK AS WARRANTED ABOVE, YOUR SOLE AND EXCLUSIVE REMEDY SHALL BE REPAIR OR REPLACEMENT OF THE DEFECTIVE PART. IN NO EVENT WILL TCL, TOSHIBA CORPORATION, THEIR AFFILIATES, ADRs OR ASPs (THE "RELATED PARTIES") BE LIABLE TO YOU OR ANY THIRD PARTY FOR ANY DAMAGES, MONEY, REIMBURSEMENT, COSTS OR EXPENSES. THIS LIMITATION APPLIES TO DAMAGES, MONEY, REIMBURSEMENT, COSTS OR EXPENSES OF ANY KIND WHATSOEVER INCLUDING ANY DIRECT OR INDIRECT DAMAGES, DAMAGE TO PROPERTY OR PERSON, LOST PROFITS, LOST SAVINGS, INCONVENIENCE OR OTHER SPECIAL, INCIDENTAL, EXEMPLARY OR CONSEQUENTIAL DAMAGES, WHETHER FOR BREACH OF WARRANTY, BREACH OF CONTRACT, TORT (INCLUDING NEGLIGENCE), UNDER A STATUTE OR UNDER ANY OTHER LAW OR FORM OR ACTION, OR WHETHER ARISING OUT OF THE USE OF OR INABILITY TO USE THE DAV PRODUCT, EVEN IF ANY OF THE RELATED PARTIES HAS BEEN ADVISED OF THE POSSIBILITY OF SUCH DAMAGES OR OF ANY CLAIM BY ANY OTHER PARTY.

No person, agent, distributor, dealer or company is authorized to change, modify or extend the terms of these warranties in any manner whatsoever.

Arbitration and Dispute Resolution

To the extent not precluded by law, any claim, dispute, controversy or disagreement (whether for breach of warranty, breach of contract, tort (including negligence), under a statute or under any other law or form of action) against any of the Related Parties arising out of, or otherwise relating to: (i) this warranty; (ii) the DAV Product; (iii) any oral or written representations, statements, brochures, press releases, advertising, announcement, point of sale display, or promotional material relating to the DAV Product; (iv) the relationships that result from this warranty, (the foregoing claims, disputes controversies and disagreements are collectively referred to as the "Dispute"), shall be referred to and resolved by final and binding arbitration (to the exclusion of the courts). To the extent not precluded by law, you agree to waive any right that you may have to commence or participate in any representative or class proceeding against the Related Parties relating to any Dispute. If and where applicable and to the extent not precluded by law, you further agree to opt out of any such representative or class proceedings. Arbitration of any Dispute will be conducted in the forum and in the manner as agreed to between you and TCL. Failing such agreement, the arbitration will be conducted by one arbitrator pursuant to the laws and rules relating to arbitration generally in force in the jurisdiction in which you reside at the time that the Dispute arises. To the extent not precluded by law, no claim, dispute, controversy or disagreement of any other person may be joined or combined with any Dispute by you, without the prior written consent of TCL.

Critical Applications

The DAV Product you have purchased is not designed for any "critical applications." "Critical applications" means life support systems, medical applications, connections to implanted medical devices, commercial transportation, nuclear facilities or systems or any other applications where DAV Product failure could lead to injury to persons or loss of life or catastrophic property damage.

IF THE CUSTOMER USES THE DAV PRODUCT IN ANY CRITICAL APPLICATION, THE CUSTOMER – AND NOT TCL, ITS AFFILIATES, ADRs OR ASPs – ASSUME SOLE AND FULL RESPONSIBILITY FOR SUCH USE. TCL RESERVES THE RIGHT TO REFUSE TO SERVICE ANY DAV PRODUCT USED IN A CRITICAL APPLICATION. TCL, ITS AFFILIATES, ADRs AND ASPs HEREBY DISCLAIM ANY AND ALL LIABILITY, DAMAGES AND CONSEQUENCES ARISING OUT OF THE SERVICE OR REFUSAL TO SERVICE SUCH DAV PRODUCT AND FURTHER DISCLAIM ANY AND ALL LIABILITY, CONSEQUENCES AND DAMAGES THAT MAY ARISE OR RESULT FROM THE USE OF THE DAV PRODUCT IN ANY CRITICAL APPLICATIONS.

General Provisions

If and to the extent that any provision of this limited warranty should generally be found to be unenforceable, the unenforceable provision shall be severed from the warranty and deemed not to form part of the warranty. The remaining provisions of this warranty shall be and remain valid and enforceable. If and to the extent that any provision of this limited warranty as it relates to any of the Related Parties is found to be invalid or unenforceable in respect of that party (the "Excluded Party"), the Excluded Party shall be deemed to be severed or excluded from the provision, and the provision shall remain valid, enforceable and applicable in respect of the other or remaining Related Parties.

To the extent permitted by law, this limited warranty shall be governed and construed in accordance with the laws of Ontario.

If there is any inconsistency between this limited warranty, on the one hand, and any statement in the packaging of the DAV Product or in any other document enclosed with, or used in the context of the promotion or sale of, the DAV Product, on the other hand, the provisions of this limited warranty shall prevail.

How to Obtain Warranty Services

If, after following all of the operating instructions in this manual and checking the "Troubleshooting" section, you find that service is needed:

- (1) To find the nearest ASP, visit TCL's web site at www.toshiba.ca, or call toll free 1-800-268-3404.
- (2) Present your bill of sale or other proof of purchase to the ASP.

For additional information, visit TCL's website at www.toshiba.ca

INTRODUCTION

CONNECTIONS

PLAYBACK

FUNCTION SETUP

OTHERS

License Information on the Software Used in This Product

This document is statement purpose only. Not concerned with operation of this product.

The software pre-installed in this product consists of multiple, independent software components. Each software component is copyrighted by a third party.

This product uses software components that are distributed as freeware under a third-party end-user license agreement or copyright notice (hereinafter referred to as a "EULA").

TOSHIBA provides a warranty for this product you have purchased under conditions set forth by TOSHIBA. However, some of the software components distributed under an EULA are made available for use by the user on the assumption that they are not copyrighted or warranted by a third party. These software components are licensed to the user free of charge and therefore not covered by any warranty within the scope of the applicable laws. These software components are not subject to any copyrights or other third-party rights and are provided in "as is" condition without any warranty, whether express or implied. "Warranty" here includes, but not limited to, an implied warranty for marketability or fitness for specific uses. All risks associated with the quality or performance of these software components are assumed by the user. TOSHIBA shall not be liable whatsoever for any cost of repair or correction or other incidental expense incurred in connection with a defect found in any of these software components. Unless specified under the applicable laws or in a written agreement, a party who changes or redistributes the software with consent from the copyright holders or based on the aforementioned licenses shall not be held liable whatsoever for any loss arising from the use of or inability to use such software components. The same applies even when the copyright holders or relevant third parties have been informed of the possibility of such loss. "Loss" here includes normal, special, incidental and indirect loss (including, but not limited to, the loss of data or its accuracy; loss incurred by the user or any third party; and interface incompatibility with other software). Please read each EULA for details on the use conditions and items that must be observed regarding these software components.

The table below lists the software components pre-installed in this product, which are subject to EULAs. The user should read the applicable EULAs carefully before using these software components. The EULAs are exhibited in their original text (English) as exactly written by the respective parties.

Program name	EULA	Program name	EULA
e2fsprogs	Exhibit A	directfb	Exhibit B
linux	Exhibit A	glibc	Exhibit B
module-init-tools	Exhibit A	Free Type	Exhibit C
mount	Exhibit A	LibJPEG	Exhibit C
netkit	Exhibit A	Open SSL	Exhibit C
nettools	Exhibit A		
sash	Exhibit A		
util-linux	Exhibit A		

- Reverse engineering, disassembling, decompiling, dismantling, or otherwise attempting to analyze or modify the software included in this product is prohibited.

Exhibit A

GPL

GNU GENERAL PUBLIC LICENSE
Version 2, June 1991

Copyright (C) 1989, 1991 Free Software Foundation, Inc.,
51 Franklin Street, Fifth Floor, Boston, MA 02110-1301 USA
Everyone is permitted to copy and distribute verbatim copies of this license document, but changing it is not allowed.

Preamble

The licenses for most software are designed to take away your freedom to share and change it. By contrast, the GNU General Public License is intended to guarantee your freedom to share and change free software—to make sure the software is free for all its users. This General Public License applies to most of the Free Software Foundation's software and to any other program whose authors commit to using it. (Some other Free Software Foundation software is covered by the GNU Lesser General Public License instead.) You can apply it to your programs, too.

When we speak of free software, we are referring to freedom, not price. Our General Public Licenses are designed to make sure that you have the freedom to distribute copies of free software (and charge for this service if you wish), that you receive source code or can get it if you want it, that you can change the software or use pieces of it in new free programs; and that you know you can do these things.

To protect your rights, we need to make restrictions that forbid anyone to deny you these rights or to ask you to surrender the rights. These restrictions translate to certain responsibilities for you if you distribute copies of the software, or if you modify it.

For example, if you distribute copies of such a program, whether gratis or for a fee, you must give the recipients all the rights that you have. You must make sure that they, too, receive or can get the source code. And you must show them these terms so they know their rights.

We protect your rights with two steps: (1) copyright the software, and (2) offer you this license which gives you legal permission to copy, distribute and/or modify the software.

Also, for each author's protection and ours, we want to make certain that everyone understands that there is no warranty for this free software. If the software is modified by someone else and passed on, we want its recipients to know that what they have is not the original, so that any problems introduced by others will not reflect on the original authors' reputations.

Finally, any free program is threatened constantly by software patents. We wish to avoid the danger that redistributors of a free program will individually obtain patent licenses, in effect making the program proprietary. To prevent this, we have made it clear that any patent must be licensed for everyone's free use or not licensed at all.

The precise terms and conditions for copying, distribution and modification follow.

GNU GENERAL PUBLIC LICENSE TERMS AND CONDITIONS FOR COPYING, DISTRIBUTION AND MODIFICATION

0. This License applies to any program or other work which contains a notice placed by the copyright holder saying it may be distributed under the terms of this General Public License. The "Program", below, refers to any such program or work, and a "work based on the Program" means either the Program or any derivative work under copyright law: that is to say, a work containing the Program or a portion of it, either verbatim or with modifications and/or translated into another language. (Hereinafter, translation is included without limitation in the term "modification".) Each licensee is addressed as "you".

Activities other than copying, distribution and modification are not covered by this License; they are outside its scope. The act of running the Program is not restricted, and the output from the Program is covered only if its contents constitute a work based on the Program (independent of having been made by running the Program). Whether that is true depends on what the Program does.

1. You may copy and distribute verbatim copies of the Program's source code as you receive it, in any medium, provided that you conspicuously and appropriately publish on each copy an appropriate copyright notice and disclaimer of warranty; keep intact all the notices that refer to this License and to the absence of any warranty; and give any other recipients of the Program a copy of this License along with the Program.

You may charge a fee for the physical act of transferring a copy, and you may at your option offer warranty protection in exchange for a fee.

2. You may modify your copy or copies of the Program or any portion of it, thus forming a work based on the Program, and copy and distribute such modifications or work under the terms of Section 1 above, provided that you also meet all of these conditions:

a) You must cause the modified files to carry prominent notices stating that you changed the files and the date of any change.

b) You must cause any work that you distribute or publish, that in whole or in part contains or is derived from the Program or any part thereof, to be licensed as a whole at no charge to all third parties under the terms of this License.

c) If the modified program normally reads commands interactively when run, you must cause it, when started running for such interactive use in the most ordinary way, to print or display an announcement including an appropriate copyright notice and a notice that there is no warranty (or else, saying that you provide a warranty) and that users may redistribute the program under these conditions, and telling the user how to view a copy of this License. (Exception: if the Program itself is interactive but does not normally print such an announcement, your work based on the Program is not required to print an announcement.)

These requirements apply to the modified work as a whole. If identifiable sections of that work are not derived from the Program, and can be reasonably considered independent and separate works in themselves, then this License, and its terms, do not apply to those sections when you distribute them as separate works. But when you distribute the same sections as part of a whole which is a work based on the Program, the distribution of the whole must be on the terms of this License, whose permissions for other licensees extend to the entire whole, and thus to each and every part regardless of who wrote it.

Thus, it is not the intent of this section to claim rights or contest your rights to work written entirely by you; rather, the intent is to exercise the right to control the distribution of derivative or collective works based on the Program.

In addition, mere aggregation of another work not based on the Program with the Program (or with a work based on the Program) on a volume of a storage or distribution medium does not bring the other work under the scope of this License.

3. You may copy and distribute the Program (or a work based on it, under Section 2) in object code or executable form under the terms of Sections 1 and 2 above provided that you also do one of the following:

- Accompany it with the complete corresponding machine-readable source code, which must be distributed under the terms of Sections 1 and 2 above on a medium customarily used for software interchange; or,
- Accompany it with a written offer, valid for at least three years, to give any third party, for a charge no more than your cost of physically performing source distribution, a complete machine-readable copy of the corresponding source code, to be distributed under the terms of Sections 1 and 2 above on a medium customarily used for software interchange; or,
- Accompany it with the information you received as to the offer to distribute corresponding source code. (This alternative is allowed only for noncommercial distribution and only if you received the program in object code or executable form with such an offer, in accord with Subsection b above.)

The source code for a work means the preferred form of the work for making modifications to it. For an executable work, complete source code means all the source code for all modules it contains, plus any associated interface definition files, plus the scripts used to control compilation and installation of the executable. However, as a special exception, the source code distributed need not include anything that is normally distributed (in either source or binary form) with the major components (compiler, kernel, and so on) of the operating system on which the executable runs, unless that component itself accompanies the executable.

If distribution of executable or object code is made by offering access to copy from a designated place, then offering equivalent access to copy the source code from the same place counts as distribution of the source code, even though third parties are not compelled to copy the source along with the object code.

- You may not copy, modify, sublicense, or distribute the Program except as expressly provided under this License. Any attempt otherwise to copy, modify, sublicense or distribute the Program is void, and will automatically terminate your rights under this License. However, parties who have received copies, or rights, from you under this License will not have their licenses terminated so long as such parties remain in full compliance.
- You are not required to accept this License, since you have not signed it. However, nothing else grants you permission to modify or distribute the Program or its derivative works. These actions are prohibited by law if you do not accept this License. Therefore, by modifying or distributing the Program (or any work based on the Program), you indicate your acceptance of this License to do so, and all its terms and conditions for copying, distributing or modifying the Program or works based on it.
- Each time you redistribute the Program (or any work based on the Program), the recipient automatically receives a license from the original licensor to copy, distribute or modify the Program subject to these terms and conditions. You may not impose any further restrictions on the recipients' exercise of the rights granted herein. You are not responsible for enforcing compliance by third parties to this License.
- If, as a consequence of a court judgment or allegation of patent infringement or for any other reason (not limited to patent issues), conditions are imposed on you (whether by court order, agreement or otherwise) that contradict the conditions of this License, they do not excuse you from the conditions of this License. If you cannot distribute so as to satisfy simultaneously your obligations under this License and any other pertinent obligations, then as a consequence you may not distribute the Program at all. For example, if a patent license would not permit royalty-free redistribution of the Program by all those who receive copies directly or indirectly through you, then the only way you could satisfy both it and this License would be to refrain entirely from distribution of the Program.

If any portion of this section is held invalid or unenforceable under any particular circumstance, the balance of the section is intended to apply and the section as a whole is intended to apply in other circumstances.

It is not the purpose of this section to induce you to infringe any patents or other property right claims or to contest validity of any such claims; this section has the sole purpose of protecting the integrity of the free software distribution system, which is implemented by public license practices. Many people have made generous contributions to the wide range of software distributed through that system in reliance on consistent application of that system; it is up to the author/donor to decide if he or she is willing to distribute software through any other system and a licensee cannot impose that choice.

This section is intended to make thoroughly clear what is believed to be a consequence of the rest of this License.

- If the distribution and/or use of the Program is restricted in certain countries either by patents or by copyrighted interfaces, the original copyright holder who places the Program under this License may add an explicit geographical distribution limitation excluding those countries, so that distribution is permitted only in or among countries not thus excluded. In such case, this License incorporates the limitation as if written in the body of this License.
 - The Free Software Foundation may publish revised and/or new versions of the General Public License from time to time. Such new versions will be similar in spirit to the present version, but may differ in detail to address new problems or concerns.
- Each version is given a distinguishing version number. If the Program specifies a version number of this License which applies to it and "any later version", you have the option of following the terms and conditions either of that version or of any later version published by the Free Software Foundation. If the Program does not specify a version number of this License, you may choose any version ever published by the Free Software Foundation.
- If you wish to incorporate parts of the Program into other free programs whose distribution conditions are different, write to the author to ask for permission. For software which is copyrighted by the Free Software Foundation, write to the Free Software Foundation; we sometimes make exceptions for this. Our decision will be guided by the two goals of preserving the free status of all derivatives of our free software and of promoting the sharing and reuse of software generally.

NO WARRANTY

- BECAUSE THE PROGRAM IS LICENSED FREE OF CHARGE, THERE IS NO WARRANTY FOR THE PROGRAM, TO THE EXTENT PERMITTED BY APPLICABLE LAW. EXCEPT WHEN OTHERWISE STATED IN WRITING THE COPYRIGHT HOLDERS AND/OR OTHER PARTIES PROVIDE THE PROGRAM "AS IS" WITHOUT WARRANTY OF ANY KIND, EITHER EXPRESSED OR IMPLIED, INCLUDING, BUT NOT LIMITED TO, THE IMPLIED WARRANTIES OF MERCHANTABILITY AND FITNESS FOR A PARTICULAR PURPOSE. THE ENTIRE RISK AS TO THE QUALITY AND PERFORMANCE OF THE PROGRAM IS WITH YOU. SHOULD THE PROGRAM PROVE DEFECTIVE, YOU ASSUME THE COST OF ALL NECESSARY SERVICING, REPAIR OR CORRECTION.
- IN NO EVENT UNLESS REQUIRED BY APPLICABLE LAW OR AGREED TO IN WRITING WILL ANY COPYRIGHT HOLDER, OR ANY OTHER PARTY WHO MAY MODIFY AND/OR REDISTRIBUTE THE PROGRAM AS PERMITTED ABOVE, BE LIABLE TO YOU FOR DAMAGES, INCLUDING ANY GENERAL, SPECIAL, INCIDENTAL OR CONSEQUENTIAL DAMAGES ARISING OUT OF THE USE OR INABILITY TO USE THE PROGRAM (INCLUDING BUT NOT LIMITED TO LOSS OF DATA OR DATA BEING RENDERED INACCURATE OR LOSSES SUSTAINED BY YOU OR THIRD PARTIES OR A FAILURE OF THE PROGRAM TO OPERATE WITH ANY OTHER PROGRAMS), EVEN IF SUCH HOLDER OR OTHER PARTY HAS BEEN ADVISED OF THE POSSIBILITY OF SUCH DAMAGES.

END OF TERMS AND CONDITIONS How to Apply These Terms to Your New Programs

If you develop a new program, and you want it to be of the greatest possible use to the public, the best way to achieve this is to make it free software which everyone can redistribute and change under these terms.

To do so, attach the following notices to the program. It is safest to attach them to the start of each source file to most effectively convey the exclusion of warranty; and each file should have at least the "copyright" line and a pointer to where the full notice is found.

<one line to give the program's name and a brief idea of what it does.>
Copyright (C) <year> <name of author>

This program is free software; you can redistribute it and/or modify it under the terms of the GNU General Public License as published by the Free Software Foundation; either version 2 of the License, or (at your option) any later version.

This program is distributed in the hope that it will be useful, but WITHOUT ANY WARRANTY; without even the implied warranty of MERCHANTABILITY or FITNESS FOR A PARTICULAR PURPOSE. See the GNU General Public License for more details.

You should have received a copy of the GNU General Public License along with this program; if not, write to the Free Software Foundation, Inc., 51 Franklin Street, Fifth Floor, Boston, MA 02110-1301 USA.

Also add information on how to contact you by electronic and paper mail.

If the program is interactive, make it output a short notice like this when it starts in an interactive mode:

Gnomovision version 69, Copyright (C) year name of author
Gnomovision comes with ABSOLUTELY NO WARRANTY; for details type `show w'.
This is free software, and you are welcome to redistribute it under certain conditions; type `show c' for details.

The hypothetical commands `show w' and `show c' should show the appropriate parts of the General Public License. Of course, the commands you use may be called something other than `show w' and `show c'; they could even be mouse-clicks or menu items—whatever suits your program.

You should also get your employer (if you work as a programmer) or your school, if any, to sign a "copyright disclaimer" for the program, if necessary. Here is a sample; alter the names:

Yooyodyne, Inc., hereby disclaims all copyright interest in the program "Gnomovision" (which makes passes at compilers) written by James Hacker.

<signature of Ty Coon>, 1 April 1989
Ty Coon, President of Vice

This General Public License does not permit incorporating your program into proprietary programs. If your program is a subroutine library, you may consider it more useful to permit linking proprietary applications with the library. If this is what you want to do, use the GNU Lesser General Public License instead of this License.

Exhibit B LGPL

GNU LESSER GENERAL PUBLIC LICENSE
Version 2.1, February 1999

Copyright (C) 1991, 1999 Free Software Foundation, Inc.
51 Franklin Street, Fifth Floor, Boston, MA 02110-1301 USA
Everyone is permitted to copy and distribute verbatim copies of this license document, but changing it is not allowed.

[This is the first released version of the Lesser GPL. It also counts as the successor of the GNU Library Public License, version 2, hence the version number 2.1.]

Preamble

The licenses for most software are designed to take away your freedom to share and change it. By contrast, the GNU General Public Licenses are intended to guarantee your freedom to share and change free software—to make sure the software is free for all its users.

This license, the Lesser General Public License, applies to some specially designated software packages—typically libraries—of the Free Software Foundation and other authors who decide to use it. You can use it too, but we suggest you first think carefully about whether this license or the ordinary General Public License is the better strategy to use in any particular case, based on the explanations below.

When we speak of free software, we are referring to freedom of use, not price. Our General Public Licenses are designed to make sure that you have the freedom to distribute copies of free software (and charge for this service if you wish); that you receive source code or can get it if you want it; that you can change the software and use pieces of it in new free programs; and that you are informed that you can do these things.

To protect your rights, we need to make restrictions that forbid distributors to deny you these rights or to ask you to surrender these rights. These restrictions translate to certain responsibilities for you if you distribute copies of the library or if you modify it.

For example, if you distribute copies of the library, whether gratis or for a fee, you must give the recipients all the rights that we gave you. You must make sure that they, too, receive or can get the source code. If you link other code with the library, you must provide complete object files to the recipients, so that they can relink them with the library after making changes to the library and recompiling it. And you must show them these terms so they know their rights.

We protect your rights with a two-step method: (1) we copyright the library, and (2) we offer you this license, which gives you legal permission to copy, distribute and/or modify the library.

To protect each distributor, we want to make it very clear that there is no warranty for the free library. Also, if the library is modified by someone else and passed on, the recipients should know that what they have is not the original version, so that the original author's reputation will not be affected by problems that might be introduced by others.

Finally, software patents pose a constant threat to the existence of any free program. We wish to make sure that a company cannot effectively restrict the users of a free program by obtaining a restrictive license from a patent holder. Therefore, we insist that any patent license obtained for a version of the library must be consistent with the full freedom of use specified in this license.

Most GNU software, including some libraries, is covered by the ordinary GNU General Public License. This license, the GNU Lesser General Public License, applies to certain designated libraries, and is quite different from the ordinary General Public License. We use this license for certain libraries in order to permit linking those libraries into non-free programs.

When a program is linked with a library, whether statically or using a shared library, the combination of the two is legally speaking a combined work, a derivative of the original library. The ordinary General Public License therefore permits such linking only if the entire combination fits its criteria of freedom. The Lesser General Public License permits more lax criteria for linking other code with the library.

We call this license the "Lesser" General Public License because it does Less to protect the user's freedom than the ordinary General Public License. It also provides other free software developers Less of an advantage over competing non-free programs. These disadvantages are the reason we use the ordinary General Public License for many libraries. However, the Lesser license provides advantages in certain special circumstances.

For example, on rare occasions, there may be a special need to encourage the widest possible use of a certain library, so that it becomes a de-facto standard. To achieve this, non-free programs must be allowed to use the library. A more frequent case is that a free library does the same job as widely used non-free libraries. In this case, there is little to gain by limiting the free library to free software only, so we use the Lesser General Public License.

In other cases, permission to use a particular library in non-free programs enables a greater number of people to use a large body of free software. For example, permission to use the GNU C Library in non-free programs enables many more people to use the whole GNU operating system, as well as its variant, the GNU/Linux operating system.

Although the Lesser General Public License is Less protective of the users' freedom, it does ensure that the user of a program that is linked with the Library has the freedom and the wherewithal to run that program using a modified version of the Library.

The precise terms and conditions for copying, distribution and modification follow. Pay close attention to the difference between a "work based on the library" and a "work that uses the library". The former contains code derived from the library, whereas the latter must be combined with the library in order to run.

GNU LESSER GENERAL PUBLIC LICENSE TERMS AND CONDITIONS FOR COPYING, DISTRIBUTION AND MODIFICATION

0. This License Agreement applies to any software library or other program which contains a notice placed by the copyright holder or other authorized party saying it may be distributed under the terms of this Lesser General Public License (also called "this License"). Each licensee is addressed as "you".

A "library" means a collection of software functions and/or data prepared so as to be conveniently linked with application programs (which use some of those functions and data) to form executables.

The "Library", below, refers to any such software library or work which has been distributed under these terms. A "work based on the Library" means either the Library or any derivative work under copyright law: that is to say, a work containing the Library or a portion of it, either verbatim or with modifications and/or translated straightforwardly into another language. (Hereinafter, translation is included without limitation in the term "modification".)

"Source code" for a work means the preferred form of the work for making modifications to it. For a library, complete source code means all the source code for all modules it contains, plus any associated interface definition files, plus the scripts used to control compilation and installation of the library.

Activities other than copying, distribution and modification are not covered by this License; they are outside its scope. The act of running a program using the Library is not restricted, and output from such a program is covered only if its contents constitute a work based on the Library (independent of the use of the Library in a tool for writing it). Whether that is true depends on what the Library does and what the program that uses the Library does.

1. You may copy and distribute verbatim copies of the Library's complete source code as you receive it, in any medium, provided that you conspicuously and appropriately publish on each copy an appropriate copyright notice and disclaimer of warranty; keep intact all the notices that refer to this License and to the absence of any warranty; and distribute a copy of this License along with the Library.

You may charge a fee for the physical act of transferring a copy, and you may at your option offer warranty protection in exchange for a fee.

2. You may modify your copy or copies of the Library or any portion of it, thus forming a work based on the Library, and copy and distribute such modifications or work under the terms of Section 1 above, provided that you also meet all of these conditions:

- The modified work must itself be a software library.
- You must cause the files modified to carry prominent notices stating that you changed the files and the date of any change.
- You must cause the whole of the work to be licensed at no charge to all third parties under the terms of this License.
- If a facility in the modified Library refers to a function or a table of data to be supplied by an application program that uses the facility, other than as an argument passed when the facility is invoked, then you must make a good faith effort to ensure that, in the event an application does not supply such function or table, the facility still operates, and performs whatever part of its purpose remains meaningful.

(For example, a function in a library to compute square roots has a purpose that is entirely well-defined independent of the application. Therefore, Subsection 2d requires that any application-supplied function or table used by this function must be optional: if the application does not supply it, the square root function must still compute square roots.)

These requirements apply to the modified work as a whole. If identifiable sections of that work are not derived from the Library, and can be reasonably considered independent and separate works in themselves, then this License, and its terms, do not apply to those sections when you distribute them as separate works. But when you distribute the same sections as part of a whole which is a work based on the Library, the distribution of the whole must be on the terms of this License, whose permissions for other licensees extend to the entire whole, and thus to each and every part regardless of who wrote it.

Thus, it is not the intent of this section to claim rights or contest your rights to work written entirely by you; rather, the intent is to exercise the right to control the distribution of derivative or collective works based on the Library.

In addition, mere aggregation of another work not based on the Library with the Library (or with a work based on the Library) on a volume of a storage or distribution medium does not bring the other work under the scope of this License.

3. You may opt to apply the terms of the ordinary GNU General Public License instead of this License to a given copy of the Library. To do this, you must alter all the notices that refer to this License, so that they refer to the ordinary GNU General Public License, version 2, instead of to this License. (If a newer version than version 2 of the ordinary GNU General Public License has appeared, then you can specify that version instead if you wish.) Do not make any other change in these notices.

Once this change is made in a given copy, it is irreversible for that copy, so the ordinary GNU General Public License applies to all subsequent copies and derivative works made from that copy.

This option is useful when you wish to copy part of the code of the Library into a program that is not a library.

4. You may copy and distribute the Library (or a portion or derivative of it, under Section 2) in object code or executable form under the terms of Sections 1 and 2 above provided that you accompany it with the complete corresponding machine-readable source code, which must be distributed under the terms of Sections 1 and 2 above on a medium customarily used for software interchange.

If distribution of object code is made by offering access to copy from a designated place, then offering equivalent access to copy the source code from the same place satisfies the requirement to distribute the source code, even though third parties are not compelled to copy the source along with the object code.

5. A program that contains no derivative of any portion of the Library, but is designed to work with the Library by being compiled or linked with it, is called a "work that uses the Library". Such a work, in isolation, is not a derivative work of the Library, and therefore falls outside the scope of this License.

However, linking a "work that uses the Library" with the Library creates an executable that is a derivative of the Library (because it contains portions of the Library), rather than a "work that uses the library". The executable is therefore covered by this License. Section 6 states terms for distribution of such executables.

When a "work that uses the Library" uses material from a header file that is part of the Library, the object code for the work may be a derivative work of the Library even though the source code is not. Whether this is true is especially significant if the work can be linked without the Library, or if the work is itself a library. The threshold for this to be true is not precisely defined by law.

If such an object file uses only numerical parameters, data structure layouts and accessors, and small macros and small inline functions (ten lines or less in length), then the use of the object file is unrestricted, regardless of whether it is legally a derivative work. (Executables containing this object code plus portions of the Library will still fall under Section 6.)

Otherwise, if the work is a derivative of the Library, you may distribute the object code for the work under the terms of Section 6. Any executables containing that work also fall under Section 6, whether or not they are linked directly with the Library itself.

6. As an exception to the Sections above, you may also combine or link a "work that uses the Library" with the Library to produce a work containing portions of the Library, and distribute that work under terms of your choice, provided that the terms permit modification of the work for the customer's own use and reverse engineering for debugging such modifications.

You must give prominent notice with each copy of the work that the Library is used in it and that the Library and its use are covered by this License. You must supply a copy of this License. If the work during execution displays copyright notices, you must include the copyright notice for the Library among them, as well as a reference directing the user to the copy of this License. Also, you must do one of these things:

- Accompany the work with the complete corresponding machine-readable source code for the Library including whatever changes were used in the work (which must be distributed under Sections 1 and 2 above); and, if the work is an executable linked with the Library, with the complete machine-readable "work that uses the Library", as object code and/or source code, so that the user can modify the Library and then relink to produce a modified executable containing the modified Library. (It is understood that the user who changes the contents of definitions files in the Library will not necessarily be able to recompile the application to use the modified definitions.)
- Use a suitable shared library mechanism for linking with the Library. A suitable mechanism is one that (1) uses at run time a copy of the library already present on the user's computer system, rather than copying library functions into the executable, and (2) will operate properly with a modified version of the library, if the user installs one, as long as the modified version is interface-compatible with the version that the work was made with.
- Accompany the work with a written offer, valid for at least three years, to give the same user the materials specified in Subsection 6a, above, for a charge no more than the cost of performing this distribution.
- If distribution of the work is made by offering access to copy from a designated place, offer equivalent access to copy the above specified materials from the same place.
- Verify that the user has already received a copy of these materials or that you have already sent this user a copy.

For an executable, the required form of the "work that uses the Library" must include any data and utility programs needed for reproducing the executable from it. However, as a special exception, the materials to be distributed need not include anything that is normally distributed (in either source or binary form) with the major components (compiler, kernel, and so on) of the operating system on which the executable runs, unless that component itself accompanies the executable.

It may happen that this requirement contradicts the license restrictions of other proprietary libraries that do not normally accompany the operating system. Such a contradiction means you cannot use both them and the Library together in an executable that you distribute.

7. You may place library facilities that are a work based on the Library side-by-side in a single library together with other library facilities not covered by this License, and distribute such a combined library, provided that the separate distribution of the work based on the Library and of the other library facilities is otherwise permitted, and provided that you do these two things:

- Accompany the combined library with a copy of the same work based on the Library, uncombined with any other library facilities. This must be distributed under the terms of the Sections above.
- Give prominent notice with the combined library of the fact that part of it is a work based on the Library, and explaining where to find the accompanying uncombined form of the same work.

8. You may not copy, modify, sublicense, link with, or distribute the Library except as expressly provided under this License. Any attempt otherwise to copy, modify, sublicense, link with, or distribute the Library is void, and will automatically terminate your rights under this License. However, parties who have received copies, or rights, from you under this License will not have their licenses terminated so long as such parties remain in full compliance.

9. You are not required to accept this License, since you have not signed it. However, nothing else grants you permission to modify or distribute the Library or its derivative works. These actions are prohibited by law if you do not accept this License. Therefore, by modifying or distributing the Library (or any work based on the Library), you indicate your acceptance of this License to do so, and all its terms and conditions for copying, distributing or modifying the Library or works based on it.

10. Each time you redistribute the Library (or any work based on the Library), the recipient automatically receives a license from the original licensor to copy, distribute, link with or modify the Library subject to these terms and conditions. You may not impose any further restrictions on the recipients' exercise of the rights granted herein. You are not responsible for enforcing compliance by third parties with this License.

11. If, as a consequence of a court judgment or allegation of patent infringement or for any other reason (not limited to patent issues), conditions are imposed on you (whether by court order, agreement or otherwise) that contradict the conditions of this License, they do not excuse you from the conditions of this License. If you cannot distribute so as to satisfy simultaneously your obligations under this License and any other pertinent obligations, then as a consequence you may not distribute the Library at all. For example, if a patent license would not permit royalty-free redistribution of the Library by all those who receive copies directly or indirectly through you, then the only way you could satisfy both is that this License would be to refrain entirely from distribution of the Library.

If any portion of this section is held invalid or unenforceable under any particular circumstance, the balance of the section is intended to apply, and the section as a whole is intended to apply in other circumstances.

It is not the purpose of this section to induce you to infringe any patents or other property right claims or to contest validity of any such claims; this section has the sole purpose of protecting the integrity of the free software distribution system which is implemented by public license practices. Many people have made generous contributions to the wide range of software distributed through that system in reliance on consistent application of that system; it is up to the author/donor to decide if he or she is willing to distribute software through any other system and a licensee cannot impose that choice.

This section is intended to make thoroughly clear what is believed to be a consequence of the rest of this License.

12. If the distribution and/or use of the Library is restricted in certain countries either by patents or by copyrighted interfaces, the original copyright holder who places the Library under this License may add an explicit geographical distribution limitation excluding those countries, so that distribution is permitted only in or among countries not thus excluded. In such case, this License incorporates the limitation as if written in the body of this License.
13. The Free Software Foundation may publish revised and/or new versions of the Lesser General Public License from time to time. Such new versions will be similar in spirit to the present version, but may differ in detail to address new problems or concerns.

Each version is given a distinguishing version number. If the Library specifies a version number of this License which applies to it and "any later version", you have the option of following the terms and conditions either of that version or of any later version published by the Free Software Foundation. If the Library does not specify a license version number, you may choose any version ever published by the Free Software Foundation.

14. If you wish to incorporate parts of the Library into other free programs whose distribution conditions are incompatible with these, write to the author to ask for permission. For software which is copyrighted by the Free Software Foundation, write to the Free Software Foundation; we sometimes make exceptions for this. Our decision will be guided by the two goals of preserving the free status of all derivatives of our free software and of promoting the sharing and reuse of software generally.

NO WARRANTY

15. BECAUSE THE LIBRARY IS LICENSED FREE OF CHARGE, THERE IS NO WARRANTY FOR THE LIBRARY, TO THE EXTENT PERMITTED BY APPLICABLE LAW. EXCEPT WHEN OTHERWISE STATED IN WRITING THE COPYRIGHT HOLDERS AND/OR OTHER PARTIES PROVIDE THE LIBRARY "AS IS" WITHOUT WARRANTY OF ANY KIND, EITHER EXPRESSED OR IMPLIED, INCLUDING, BUT NOT LIMITED TO, THE IMPLIED WARRANTIES OF MERCHANTABILITY AND FITNESS FOR A PARTICULAR PURPOSE. THE ENTIRE RISK AS TO THE QUALITY AND PERFORMANCE OF THE LIBRARY IS WITH YOU. SHOULD THE LIBRARY PROVE DEFECTIVE, YOU ASSUME THE COST OF ALL NECESSARY SERVICING, REPAIR OR CORRECTION.

16. IN NO EVENT UNLESS REQUIRED BY APPLICABLE LAW OR AGREED TO IN WRITING WILL ANY COPYRIGHT HOLDER, OR ANY OTHER PARTY WHO MAY MODIFY AND/OR REDISTRIBUTE THE LIBRARY AS PERMITTED ABOVE, BE LIABLE TO YOU FOR DAMAGES, INCLUDING ANY GENERAL, SPECIAL, INCIDENTAL OR CONSEQUENTIAL DAMAGES ARISING OUT OF THE USE OR INABILITY TO USE THE LIBRARY (INCLUDING BUT NOT LIMITED TO LOSS OF DATA OR DATA BEING RENDERED INACCURATE OR LOSSES SUSTAINED BY YOU OR THIRD PARTIES OR A FAILURE OF THE LIBRARY TO OPERATE WITH ANY OTHER SOFTWARE), EVEN IF SUCH HOLDER OR OTHER PARTY HAS BEEN ADVISED OF THE POSSIBILITY OF SUCH DAMAGES.

END OF TERMS AND CONDITIONS

How to Apply These Terms to Your New Libraries

If you develop a new library, and you want it to be of the greatest possible use to the public, we recommend making it free software that everyone can redistribute and change. You can do so by permitting redistribution under these terms (or, alternatively, under the terms of the ordinary General Public License).

To apply these terms, attach the following notices to the library. It is safest to attach them to the start of each source file to most effectively convey the exclusion of warranty; and each file should have at least the "copyright" line and a pointer to where the full notice is found.

<one line to give the library's name and a brief idea of what it does.>
Copyright (C) <year> <name of author>

This library is free software; you can redistribute it and/or modify it under the terms of the GNU Lesser General Public License as published by the Free Software Foundation; either version 2.1 of the License, or (at your option) any later version.

This library is distributed in the hope that it will be useful, but WITHOUT ANY WARRANTY; without even the implied warranty of MERCHANTABILITY or FITNESS FOR A PARTICULAR PURPOSE. See the GNU Lesser General Public License for more details.

You should have received a copy of the GNU Lesser General Public License along with this library; if not, write to the Free Software Foundation, Inc., 51 Franklin Street, Fifth Floor, Boston, MA 02110-1301 USA.

Also add information on how to contact you by electronic and paper mail.

You should also get your employer (if you work as a programmer) or your school, if any, to sign a "copyright disclaimer" for the library, if necessary. Here is a sample; alter the names:

Yoodyne, Inc, hereby disclaims all copyright interest in the library 'Frob' (a library for tweaking knobs) written by James Random Hacker.

<signature of Ty Coon>, 1 April 1990
Ty Coon, President of Vice

That's all there is to it!

Exhibit C Free Type

The FreeType Project LICENSE

2006-Jan-27

Copyright 1996-2002, 2006 by
David Turner, Robert Wilhelm, and Werner Lemberg

Introduction

The FreeType Project is distributed in several archive packages; some of them may contain, in addition to the FreeType font engine, various tools and contributions which rely on, or relate to, the FreeType Project.

This license applies to all files found in such packages, and which do not fall under their own explicit license. The license affects thus the FreeType font engine, the test programs, documentation and makefiles, at the very least.

This license was inspired by the BSD, Artistic, and IUG (Independent JPEG Group) licenses, which all encourage inclusion and use of free software in commercial and freeware products alike. As a consequence, its main points are that:

- We don't promise that this software works. However, we will be interested in any kind of bug reports. ('as is' distribution)
- You can use this software for whatever you want, in parts or full form, without having to pay us. ('royalty-free' usage)
- You may not pretend that you wrote this software. If you use it, or only parts of it, in a program, you must acknowledge somewhere in your documentation that you have used the FreeType code. ('credits')

We specifically permit and encourage the inclusion of this software, with or without modifications, in commercial products. We disclaim all warranties covering The FreeType Project and assume no liability related to The FreeType Project.

Finally, many people asked us for a preferred form for a credit/disclaimer to use in compliance with this license. We thus encourage you to use the following text:

Portions of this software are copyright© <year> The FreeType Project (www.freetype.org). All rights reserved.

Please replace <year> with the value from the FreeType version you actually use.

Legal Terms

0. Definitions

Throughout this license, the terms 'package', 'FreeType Project', and 'FreeType archive' refer to the set of files originally distributed by the authors (David Turner, Robert Wilhelm, and Werner Lemberg) as the 'FreeType Project', be they named as alpha, beta or final release.

'You' refers to the licensee, or person using the project, where 'using' is a generic term including compiling the project's source code as well as linking it to form a 'program' or 'executable'. This program is referred to as 'a program using the FreeType engine'.

This license applies to all files distributed in the original FreeType Project, including all source code, binaries and documentation, unless otherwise stated in the file in its original, unmodified form as distributed in the original archive. If you are unsure whether or not a particular file is covered by this license, you must contact us to verify this.

The FreeType Project is copyright (C) 1996-2000 by David Turner, Robert Wilhelm, and Werner Lemberg. All rights reserved except as specified below.

1. No Warranty

THE FREETYPE PROJECT IS PROVIDED 'AS IS' WITHOUT WARRANTY OF ANY KIND, EITHER EXPRESS OR IMPLIED, INCLUDING, BUT NOT LIMITED TO, WARRANTIES OF MERCHANTABILITY AND FITNESS FOR A PARTICULAR PURPOSE. IN NO EVENT WILL ANY OF THE AUTHORS OR COPYRIGHT HOLDERS BE LIABLE FOR ANY DAMAGES CAUSED BY THE USE OR THE INABILITY TO USE, OF THE FREETYPE PROJECT.

2. Redistribution

This license grants a worldwide, royalty-free, perpetual and irrevocable right and license to use, execute, perform, compile, display, copy, create derivative works of, distribute and sublicense the FreeType Project (in both source and object code forms) and derivative works thereof for any purpose; and to authorize others to exercise some or all of the rights granted herein, subject to the following conditions:

- Redistribution of source code must retain this license file ('FTL.TXT') unaltered; any additions, deletions or changes to the original files must be clearly indicated in accompanying documentation. The copyright notices of the unaltered, original files must be preserved in all copies of source files.
- Redistribution in binary form must provide a disclaimer that states that the software is based in part of the work of the FreeType Team, in the distribution documentation. We also encourage you to put an URL to the FreeType web page in your documentation, though this isn't mandatory.

These conditions apply to any software derived from or based on the FreeType Project, not just the unmodified files. If you use our work, you must acknowledge us. However, no fee need be paid to us.

3. Advertising

Neither the FreeType authors and contributors nor you shall use the name of the other for commercial, advertising, or promotional purposes without specific prior written permission.

We suggest, but do not require, that you use one or more of the following phrases to refer to this software in your documentation or advertising materials: 'FreeType Project', 'FreeType Engine', 'FreeType library', or 'FreeType Distribution'.

As you have not signed this license, you are not required to accept it. However, as the FreeType Project is copyrighted material, only this license, or another one contracted with the authors, grants you the right to use, distribute, and modify it. Therefore, by using, distributing, or modifying the FreeType Project, you indicate that you understand and accept all the terms of this license.

4. Contacts

There are two mailing lists related to FreeType:

- freetype@nongnu.org
Discusses general use and applications of FreeType, as well as future and wanted additions to the library and distribution. If you are looking for support, start in this list if you haven't found anything to help you in the documentation.
- freetype-devel@nongnu.org
Discusses bugs, as well as engine internals, design issues, specific licenses, porting, etc.

Our home page can be found at

<http://www.freetype.org>

LibJPEG

In plain English:

1. We don't promise that this software works. (But if you find any bugs, please let us know!)
2. You can use this software for whatever you want. You don't have to pay us.
3. You may not pretend that you wrote this software. If you use it in a program, you must acknowledge somewhere in your documentation that you've used the IJG code.

In legalese:

The authors make NO WARRANTY or representation, either express or implied, with respect to this software, its quality, accuracy, merchantability, or fitness for a particular purpose. This software is provided "AS IS", and you, its user, assume the entire risk as to its quality and accuracy.

This software is copyright (C) 1991-1998, Thomas G. Lane.
All Rights Reserved except as specified below.

Permission is hereby granted to use, copy, modify, and distribute this software (or portions thereof) for any purpose, without fee, subject to these conditions:

- (1) If any part of the source code for this software is distributed, then this README file must be included, with this copyright and no-warranty notice unaltered; and any additions, deletions, or changes to the original files must be clearly indicated in accompanying documentation.
- (2) If only executable code is distributed, then the accompanying documentation must state that "this software is based in part on the work of the Independent JPEG Group".
- (3) Permission for use of this software is granted only if the user accepts full responsibility for any undesirable consequences; the authors accept NO LIABILITY for damages of any kind.

These conditions apply to any software derived from or based on the IJG code, not just to the unmodified library. If you use our work, you ought to acknowledge us.

Permission is NOT granted for the use of any IJG author's name or company name in advertising or publicity relating to this software or products derived from it. This software may be referred to only as "the Independent JPEG Group's software".

We specifically permit and encourage the use of this software as the basis of commercial products, provided that all warranty or liability claims are assumed by the product vendor.

Open SSL

OpenSSL License

/*

Copyright (c) 1998-2008 The OpenSSL Project. All rights reserved.

Redistribution and use in source and binary forms, with or without modification, are permitted provided that the following conditions are met:

1. Redistributions of source code must retain the above copyright notice, this list of conditions and the following disclaimer.
2. Redistributions in binary form must reproduce the above copyright notice, this list of conditions and the following disclaimer in the documentation and/or other materials provided with the distribution.
3. All advertising materials mentioning features or use of this software must display the following acknowledgment:
"This product includes software developed by the OpenSSL Project for use in the OpenSSL Toolkit.
(<http://www.openssl.org/>)"
4. The names "OpenSSL Toolkit" and "OpenSSL Project" must not be used to endorse or promote products derived from this software without prior written permission. For written permission, please contact openssl-core@openssl.org.
5. Products derived from this software may not be called "OpenSSL" nor may "OpenSSL" appear in their names without prior written permission of the OpenSSL Project.
6. Redistributions of any form whatsoever must retain the following acknowledgment:
"This product includes software developed by the OpenSSL Project for use in the OpenSSL Toolkit
(<http://www.openssl.org/>)"

THIS SOFTWARE IS PROVIDED BY THE OPENSSL PROJECT "AS IS" AND ANY EXPRESSED OR IMPLIED WARRANTIES, INCLUDING, BUT NOT LIMITED TO, THE IMPLIED WARRANTIES OF MERCHANTABILITY AND FITNESS FOR A PARTICULAR PURPOSE ARE DISCLAIMED. IN NO EVENT SHALL THE OPENSSL PROJECT OR ITS CONTRIBUTORS BE LIABLE FOR ANY DIRECT, INDIRECT, INCIDENTAL, SPECIAL, EXEMPLARY, OR CONSEQUENTIAL DAMAGES (INCLUDING, BUT NOT LIMITED TO, PROCUREMENT OF SUBSTITUTE GOODS OR SERVICES; LOSS OF USE, DATA, OR PROFITS; OR BUSINESS INTERRUPTION) HOWEVER CAUSED AND ON ANY THEORY OF LIABILITY, WHETHER IN CONTRACT, STRICT LIABILITY, OR TORT (INCLUDING NEGLIGENCE OR OTHERWISE) ARISING IN ANY WAY OUT OF THE USE OF THIS SOFTWARE, EVEN IF ADVISED OF THE POSSIBILITY OF SUCH DAMAGE.

This product includes cryptographic software written by Eric Young (eay@cryptsoft.com). This product includes software written by Tim Hudson (tjh@cryptsoft.com).

*/

Original SSLeay License

/* Copyright (C) 1995-1998 Eric Young (eay@cryptsoft.com) All rights reserved.

This package is an SSL implementation written by Eric Young (eay@cryptsoft.com). The implementation was written so as to conform with Netscape's SSL.

This library is free for commercial and non-commercial use as long as the following conditions are adhered to. The following conditions apply to all code found in this distribution, be it the RC4, RSA, lhash, DES, etc., code; not just the SSL code. The SSL documentation included with this distribution is covered by the same copyright terms except that the holder is Tim Hudson (tjh@cryptsoft.com).

Copyright remains Eric Young's, and as such any Copyright notices in the code are not to be removed. If this package is used in a product, Eric Young should be given attribution as the author of the parts of the library used. This can be in the form of a textual message at program startup or in documentation (online or textual) provided with the package.

Redistribution and use in source and binary forms, with or without modification, are permitted provided that the following conditions are met:

1. Redistributions of source code must retain the copyright notice, this list of conditions and the following disclaimer.
2. Redistributions in binary form must reproduce the above copyright notice, this list of conditions and the following disclaimer in the documentation and/or other materials provided with the distribution.
3. All advertising materials mentioning features or use of this software must display the following acknowledgment:
"This product includes cryptographic software written by Eric Young (eay@cryptsoft.com)"
The word "cryptographic" can be left out if the routines from the library being used are not cryptographic related -).
4. If you include any Windows specific code (or a derivative thereof) from the apps directory (application code) you must include an acknowledgment:
"This product includes software written by Tim Hudson (tjh@cryptsoft.com)"

THIS SOFTWARE IS PROVIDED BY ERIC YOUNG "AS IS" AND ANY EXPRESS OR IMPLIED WARRANTIES, INCLUDING, BUT NOT LIMITED TO, THE IMPLIED WARRANTIES OF MERCHANTABILITY AND FITNESS FOR A PARTICULAR PURPOSE ARE DISCLAIMED. IN NO EVENT SHALL THE AUTHOR OR CONTRIBUTORS BE LIABLE FOR ANY DIRECT, INDIRECT, INCIDENTAL, SPECIAL, EXEMPLARY, OR CONSEQUENTIAL DAMAGES (INCLUDING, BUT NOT LIMITED TO, PROCUREMENT OF SUBSTITUTE GOODS OR SERVICES; LOSS OF USE, DATA, OR PROFITS; OR BUSINESS INTERRUPTION) HOWEVER CAUSED AND ON ANY THEORY OF LIABILITY, WHETHER IN CONTRACT, STRICT LIABILITY, OR TORT (INCLUDING NEGLIGENCE OR OTHERWISE) ARISING IN ANY WAY OUT OF THE USE OF THIS SOFTWARE, EVEN IF ADVISED OF THE POSSIBILITY OF SUCH DAMAGE.

The licence and distribution terms for any publicly available version or derivative of this code cannot be changed, i.e. this code cannot simply be copied and put under another distribution licence (including the GNU Public Licence.)

*/

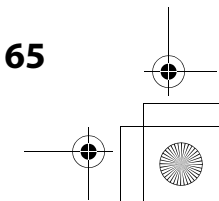
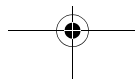
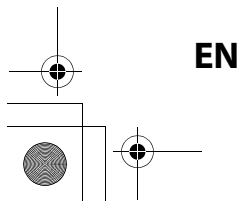
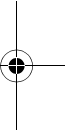
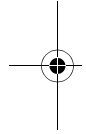
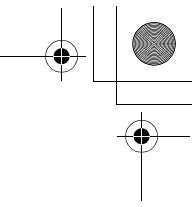
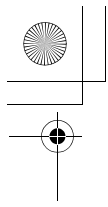

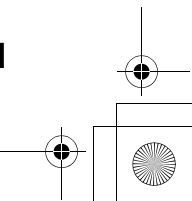
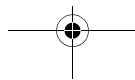
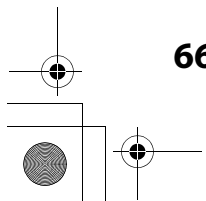
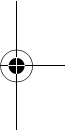
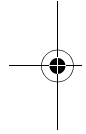
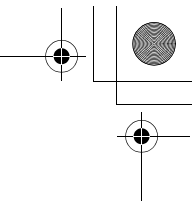
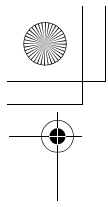

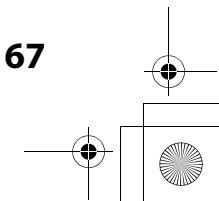
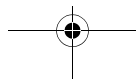
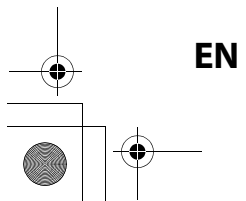
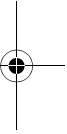
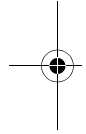
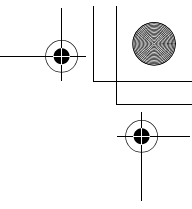
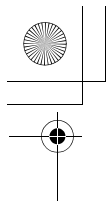

TOSHIBA

1VMN28353 / E5PJ3CD ★★★★★



1VMN28353

Printed in China

Free Manuals Download Website

<http://myh66.com>

<http://usermanuals.us>

<http://www.somanuals.com>

<http://www.4manuals.cc>

<http://www.manual-lib.com>

<http://www.404manual.com>

<http://www.luxmanual.com>

<http://aubethermostatmanual.com>

Golf course search by state

<http://golfingnear.com>

Email search by domain

<http://emailbydomain.com>

Auto manuals search

<http://auto.somanuals.com>

TV manuals search

<http://tv.somanuals.com>