

# TOSHIBA

Leading Innovation >>>

## Blu-ray Disc™/DVD Player User's Guide: BDX2300KC/BDX3300KC

If you need assistance:

- ❖ Toshiba's Support Web site  
[www.toshiba.ca/support](http://www.toshiba.ca/support)
- ❖ Toshiba Customer Support Center  
Please contact our Customer Service Department at: 1-800-268-3404

For more information see "Troubleshooting & Maintenance" on page 42 in this guide.

### Owner's Record

The model number and serial number are on the back and underside of your player. Record these numbers in the spaces below. Refer to these numbers whenever you communicate with your Toshiba dealer about this equipment.

Model name \_\_\_\_\_

Serial number \_\_\_\_\_

# Contents

Introduction .....	8
Symbols used in this manual .....	8
Features .....	9
Blu-ray Disc™/DVD player controls .....	10
Remote control buttons .....	11
Blu-ray Disc™/DVD player connections .....	15
Blu-ray Disc™ playback .....	19
Customizing the function settings.....	32
Security .....	38
Using the connected applications .....	39
Troubleshooting & Maintenance .....	42
Glossary .....	44
Specifications .....	46
License Information .....	47

## SAFETY PRECAUTIONS

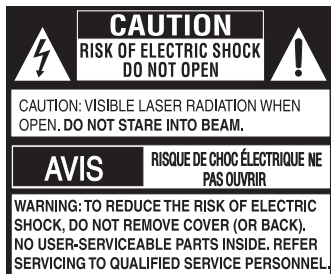

The lightning flash with an arrowhead symbol, within the equilateral triangle, is intended to alert the user to the presence of uninsulated "dangerous voltage" within the product's enclosure that may be of sufficient magnitude to constitute a risk of electric shock to persons.



The exclamation point within the equilateral triangle is intended to alert the user to the presence of important operating and maintenance (servicing) instructions in this User's Guide.

**WARNING:** TO REDUCE THE RISK OF FIRE OR ELECTRIC SHOCK, DO NOT EXPOSE THIS APPLIANCE TO RAIN OR MOISTURE. DANGEROUS HIGH VOLTAGES ARE PRESENT INSIDE THE ENCLOSURE. DO NOT OPEN THE CABINET. REFER SERVICING TO QUALIFIED PERSONNEL ONLY.

TO PREVENT ELECTRIC SHOCK, MATCH WIDE BLADE OF PLUG TO WIDE SLOT OF AC POWER UTLET, THEN FULLY INSERT.

**CAUTION:** This Blu-ray Disc™/DVD player employs a Laser System.

To ensure proper use of this product, please read this User's Guide carefully and retain for future reference. Should the unit require maintenance, contact an authorized service location. Use of controls or adjustments or performance of procedures other than those specified herein may result in hazardous radiation exposure. To prevent direct exposure to laser beam, do not try to open the enclosure. Visible and invisible laser radiation when open and interlocks defeated. **DO NOT STARE INTO BEAM.**



The symbol for Class II (Double Insulation)

### Warnings:

- The mains plug is used as disconnect device and it should remain readily operable during intended use. In order to disconnect the apparatus from the mains completely, the main plug should be disconnected from the mains socket outlet completely.
- The apparatus shall not be exposed to dripping or splashing and that no objects filled with liquid, such as vases, shall be placed on the apparatus.
- Minimum 10 cm (4 inches) distances around the apparatus for sufficient ventilations.
- The ventilation should not be impeded by covering the ventilation openings with items such as newspaper, tablecloths, curtains, etc.
- No naked flame sources such as lighted candles should be placed on the apparatus.
- The use of apparatus in moderate climates.

## IMPORTANT SAFETY INSTRUCTIONS

1. Read these instructions.
2. Keep these instructions.
3. Heed all warnings.
4. Follow all instructions.
5. Do not use this apparatus near water.
6. Clean only with a dry cloth.
7. Do not block any of the ventilation openings. Install in accordance with the manufacturer's instructions.
8. Do not install near any heat sources such as radiators, heat registers, stoves, or other apparatus (including amplifiers) that produce heat.
9. Do not defeat the safety purpose of the polarized or grounding-type plug. A polarized plug has two blades with one wider than the other. A grounding type plug has two blades and a third grounding prong. The wide blade or the third prong is provided for your safety. If the provided plug does not fit into your outlet, consult an electrician for replacement of the obsolete outlet.
10. Protect the power cord from being walked on or pinched particularly at plugs, convenience receptacles, and the point where they exit from the apparatus.
11. Only use attachments/accessories specified by the manufacturer.
12. Use only with the cart, stand, tripod, bracket, or table specified by the manufacturer, or sold with the apparatus. When a cart is used, use caution when moving the cart/apparatus combination to avoid injury from tip-over.
13. Unplug this apparatus during lightning storms or when unused for long periods of time.
14. Refer all servicing to qualified service personnel. Servicing is required when the apparatus has been damaged in any way, such as the power-supply cord or plug is damaged, liquid has been spilled or objects have fallen into the apparatus, the apparatus has been exposed to rain or moisture, does not operate normally, or has been dropped.



## ADDITIONAL SAFETY INSTRUCTIONS

15. Do not overload wall outlets; extension cords, or integral convenience receptacles as this can result in a risk of fire or electric shock.
  16. Never expose the apparatus to dripping or splashing or place items such as vases, aquariums, any other item filled with liquid, or candles on top of the unit.
  17. Keep your fingers well clear of the disc tray as it is closing. Neglecting to do so may cause serious personal injury.
  18. Do not place anything on top of this unit.
  19. Do not place the apparatus on amplifiers or equipment that may produce heat.
  20. Never block or cover the slots or openings in the unit. Never place the unit:
    - on a bed, sofa, rug or similar surface;
    - too close to drapes, curtains, or walls; or
  - in a confined space such as a bookcase, built-in cabinet, or any other place with poor ventilation.
- The slots and openings are provided to protect the unit from overheating and to help maintain reliable operation.
21. Do not use a cracked, deformed, or repaired disc. These discs are easily broken and may cause serious personal injury and apparatus malfunction.
  22. If the apparatus should emit smoke or an unusual odor, immediately disconnect the power cord from the wall outlet. Wait until the smoke or smell stops, then ask your dealer for a check and repair. Neglecting to do so may cause fire.
  23. During thunderstorms, do not touch the connecting cables or the apparatus.
  24. Warning: To prevent spread of fire, keep candles or other open flames away from this product at all times.

### Location of the required label

The rating plate and the safety caution are on the rear of the unit.

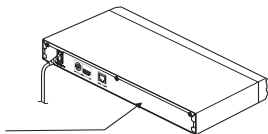

Products that earn the ENERGY STAR prevent green house gas emissions by meeting strict energy efficiency guidelines set by the U.S. Environmental Protection Agency and the U.S. Department of Energy. ENERGY STAR and the ENERGY STAR mark are registered U.S. marks.



### USA Federal Communications Commission Statement FCC Compliance Statement

This device complies with Part 15 of the FCC Rules. Operation is subject to the following two conditions: (1) This device may not cause harmful interference, and (2) This device must accept any interference received, including interference that may cause undesired operation.

#### Interference

*This equipment has been tested and found to comply with the limits for a Class B digital device, pursuant to Part 15 of the FCC Rules. These limits are designed to provide reasonable protection against harmful interference in a residential installation. This equipment generates, uses, and can radiate radio frequency energy and, if not installed and used in accordance with the instructions, may cause harmful interference to radio communications. However, there is no guarantee that interference will not occur in a particular installation. If this equipment does cause harmful interference to radio or television reception, which can be determined by turning the equipment off and on, the user is encouraged to try to correct the interference by one of the following measures:*

- Reorient or relocate the receiving antenna.
- Increase the separation between the equipment and receiver.
- Connect the equipment into an outlet on a circuit different from that to which the receiver is connected.
- Consult the dealer or an experienced radio/TV technician for help.

This Class B digital apparatus complies with Canadian CES-003.

### Wireless Radio

For product available in the USA/Canada market, only channel 1-11 can be operated. Selection of other channels is not possible. The device could automatically discontinue transmission in case of absence of information to transmit, or operational failure. Note that this is not intended to prohibit transmission of control or signaling information or the use of repetitive codes where required by the technology. If this device is going to be operated in 5.15-5.25GHz frequency range, then it is restricted to an indoor environment only.

**Important:** Any changes or modifications not expressly approved by the party responsible for compliance could void the user's authority to operate this equipment. This device and its antenna(s) must not be co-located or operating in conjunction with any other antenna or transmitter.

### FCC Radiation Exposure Statement

*This equipment complies with FCC radiation exposure limits set forth for an uncontrolled environment. This equipment should be installed and operated with minimum distance 20cm between the radiator & your body.*

### Canada Industry Canada Statement

This device complies with RSS-210.

Operation is subject to the following two conditions:

- (1) This device may not cause harmful interference, and
- (2) This device must accept any interference received, including interference that may cause undesired operation of the device. This device and its antenna(s) must not be co-located or operating in conjunction with any other antenna or transmitter.

## Wireless Radio

For product available in the USA/Canada market, only channel 1-11 can be operated. Selection of other channels is not possible. The device could automatically discontinue transmission in case of absence of information to transmit, or operational failure. Note that this is not intended to prohibit transmission of control or signaling information or the use of repetitive codes where required by the technology.

**Important:** Any changes or modifications not expressly approved by the party responsible for compliance could void the user's authority to operate this equipment.

### IMPORTANT NOTE:

IC Radiation Exposure Statement: This equipment complies with IC RSS-102 radiation exposure limits set forth for an uncontrolled environment. This equipment should be installed and operated with minimum distance 20cm between the radiator & your body.

# PRECAUTIONS

## Notes on handling

- When shipping the Blu-ray Disc™/DVD player, the original shipping carton and packing materials come in handy. For maximum protection, repack the unit as it was originally packed at the factory. Take care not to give it a shock or shake when carrying.
- Do not use volatile liquids, such as insect spray, near the Blu-ray Disc™/DVD player. Do not leave rubber or plastic products in contact with the Blu-ray Disc™/DVD player for a long time. They will leave marks on the finish.
- The top and rear panels of the Blu-ray Disc™/DVD player may become warm after a long period of use. This is not a malfunction.
- When the Blu-ray Disc™/DVD player is not in use, be sure to remove the disc and turn off the power.
- If you do not use the Blu-ray Disc™/DVD player for a long period, the unit may not function properly in the future. Turn on and use the Blu-ray Disc™/DVD player occasionally.

## Notes on locating

Place the Blu-ray Disc™/DVD player on a level surface. Do not use it on a shaky or unstable surface such as a wobbling table or inclined stand. The loaded disc may come off the proper position and cause damage to the Blu-ray Disc™/DVD player.

When you place this Blu-ray Disc™/DVD player near a TV, radio, or VCR, the playback picture may become poor and the sound may be distorted. In this case, place the Blu-ray Disc™/DVD player away from the TV, radio, or VCR.

Do not use this player in places which are extremely hot, cold, dusty or humid.

Do not restrict the air flow of this player by placing it somewhere with poor air flow, by covering it with a cloth, or by placing it on bedding or carpeting.

Be sure to remove the disc and unplug the AC power cord from the outlet before carrying the player.

## Notes on cleaning

Use a soft, dry cloth for cleaning.

- For stubborn dirt, soak the cloth in a weak detergent solution, wring well and wipe. Use a dry cloth to wipe it dry. Do not use any type of solvent, such as thinners and benzene, as they may damage the surface of the Blu-ray Disc™/DVD player.
- If you use a chemical saturated cloth to clean the unit, follow that product's instructions.

## Inspection and Maintenance

This Blu-ray Disc™/DVD player is a high technology, precision device. If the optical pick-up lens and disc drive parts become dirty or worn down, the picture quality may be reduced. To avoid reduction in picture quality, it is recommended that regular inspection and maintenance (cleaning or parts replacement) be performed every 1,000 hours of use. For further details, contact your nearest consumer electronics dealer.

## Notes on moisture condensation

**Moisture condensation damages the Blu-ray Disc™/DVD player. Please read the following carefully.**

Moisture condensation occurs, for example, when you pour a cold drink into a glass on a warm day. Drops of water form on the outside of the glass. In the same way, moisture may condense on the optical pick-up lens inside this unit, one of the most crucial internal parts of the Blu-ray Disc™/DVD player.

**Moisture condensation occurs during the following cases.**

When you bring the Blu-ray Disc™/DVD player directly from a cold place to a warm place.

When you use the Blu-ray Disc™/DVD player in a room where you just turned on the heater, or a place where the cold wind from the air conditioner directly hits the unit.

In summer, when you use the Blu-ray Disc™/DVD player in a hot and humid place just after you move the unit from an air conditioned room.

When you use the Blu-ray Disc™/DVD player in a humid place.

**Do not use the Blu-ray Disc™/DVD player when moisture condensation may occur.**

If you use the Blu-ray Disc™/DVD player in such a situation, it may damage discs and internal parts. Remove the disc, connect the power cord of the Blu-ray Disc™/DVD player to the wall outlet, turn on the Blu-ray Disc™/DVD player, and leave it for two or three hours. After two or three hours, the Blu-ray Disc™/DVD player will have warmed up and evaporated any moisture. Keep the Blu-ray Disc™/DVD player connected to the wall outlet and moisture condensation will seldom occur.

## On Safety

Do not handle the AC power cord with wet hands and do not put your fingers or objects into the player.

When connecting or disconnecting the AC power cord, grip the plug and not the cord itself. Pulling the cord may damage it and create a hazard.

When you are not going to use the unit for a long period of time, disconnect the AC power cord.

## On Recycling

This unit's packaging materials are recyclable and can be reused. Please dispose of any materials in accordance with your local recycling regulations.

## NOTES ON DISCS

### On handling discs

Do not touch the playback side of the disc.



Do not attach paper or tape to discs.



Batteries should never be thrown away or incinerated but disposed of in accordance with your local regulations concerning chemical wastes.

### On cleaning discs

Fingerprints and dust on the disc cause picture and sound deterioration. Wipe the disc from the center outwards with a soft cloth. Always keep the disc clean.



If you cannot wipe off the dust with a soft cloth, wipe the disc lightly with a slightly moistened soft cloth and finish with a dry cloth.

Do not use any type of solvent such as thinner, benzene, commercially available cleaners or antistatic spray for vinyl LPs. It may damage the disc.

### On storing discs

Do not store discs in a place subject to direct sunlight or near heat sources.

Do not store discs in places subject to moisture and dust such as a bathroom or near a humidifier.

Store discs vertically in a case. Stacking or placing objects on discs outside of their case may cause warping.

## COPYRIGHT

This guide is copyrighted by Toshiba America Information Systems, Inc. with all rights reserved. Under the copyright laws, this guide cannot be reproduced in any form without the prior written permission of Toshiba. No patent liability is assumed,

however, with respect to the use of the information contained herein.

©2012 by Toshiba America Information Systems, Inc. All rights reserved.

## Trademarks

AVCHD and the AVCHD logo are trademarks of Panasonic Corporation and Sony Corporation.

Blu-ray Disc™, Blu-ray™, BD-Live™ and BONUSVIEW™ and the logos are trademarks of the Blu-ray Disc Association.

CinemaNow is a registered trademark of Best Buy, Inc.

DLNA®, the DLNA Certification Logo and DLNA CERTIFIED™ are trademarks, service marks, or certification marks of the Digital Living Network Alliance.



Manufactured under license from Dolby Laboratories. Dolby, Pro Logic, and the double-D symbol are trademarks of Dolby Laboratories.



Manufactured under license under U.S. Patent Nos: 5,956,674; 5,974,380; 6,226,616; 6,487,535; 7,392,195; 7,272,567; 7,333,929; 7,212,872 & other U.S. and worldwide patents

issued & pending. DTS-HD, the Symbol, & DTS-HD and the Symbol together are registered trademarks & DTS-HD Master Audio | Essential is a trademark of DTS, Inc. Product includes software. © DTS, Inc. All Rights Reserved.

DVD is a trademark of DVD Format/Logo Licensing Corporation.



HDMI, the HDMI logo, and High-Definition Multimedia Interface are trademarks or registered trademarks of HDMI Licensing LLC in the United States and other countries.

Microsoft, Outlook, Windows, and Windows Media are either registered trademarks or trademarks of Microsoft Corporation in the United States and/or other countries.



Windows Media and the Windows logo are trademarks or registered trademarks of Microsoft Corporation in the United States and/or other countries.

Netflix is a registered trademark of Netflix, Inc.



Oracle and Java are registered trademarks of Oracle and/or its affiliates. Other names may be trademarks of their respective owners.

Picasa is a trademark of Google Inc.

The Wi-Fi CERTIFIED Logo is a certification mark of the Wi-Fi Alliance. The Wi-Fi Protected Setup Mark is a mark of the Wi-Fi Alliance.

"x.v.Color" and "x.v.Color" logo are registered trademarks of Sony Corporation.

YouTube is a registered trademark of Google Inc.

All other brand and product names are trademarks or registered trademarks of their respective companies.

## Introduction

### Safety icons

This guide contains safety instructions that must be observed to avoid potential hazards that could result in personal injuries, damage to your equipment, or loss of data. These safety cautions have been classified according to the seriousness of the risk, and icons highlight these instructions as follows:

**▲ DANGER** Indicates an imminently hazardous situation which, if not avoided, will result in death or serious injury.

**▲ WARNING** Indicates a potentially hazardous situation which, if not avoided, could result in death or serious injury.

**▲ CAUTION** Indicates a potentially hazardous situation which, if not avoided, may result in minor or moderate injury.

**CAUTION** Indicates a potentially hazardous situation which, if not avoided, may result in property damage.







**NOTE** Provides important information.

### Package contents

- ❖ Remote Control (SE-R0418) with Batteries (1 set of 2 AAA)
- ❖ Quick Start Guide

### Symbols used in this manual

The following symbols indicate the corresponding operation.

Symbol:	Operation:
	BD-video and BD-RE/BD-R recorded in BDMV format
	DVD-video
	Audio CD/DTS®-CD
	DVD-RW/-R with AVCHD™ files
	BD-RE/-R, DVD-RW/-R and CD-RW/-R with MP3 files
	BD-RE/-R, DVD-RW/-R and CD-RW/-R with WMA files
	BD-RE/-R, DVD-RW/-R and CD-RW/-R with JPEG files



**NOTE**

If any of the symbols listed above are not displayed under the function heading, the operation is applicable to all media.

## Features

**Blu-ray Disc™:** Enjoy Blu-ray Disc™ viewing and storage, capable of storing five times more data than a conventional DVD.

**BD-Java™:** Enjoy the interactive functions such as games or interactive menus, supported Java™ applications.

**BD-Live™:** BD-ROM version 2 Profile 2.0 allows interactive functionality when this player is connected to the Internet, in addition to the BONUSVIEW™ function. The various functions differ depending on the disc type.

**Full high-definition video playback:** Watch movies in the highest picture quality available for your HDTV. This player offers full high-definition video playback up to 1080p resolution for an amazing viewing experience. A highly detailed picture and increased sharpness delivers a more true-to-life picture.

**DVD Upconversion for enhanced picture quality:** Your current DVD will look even better than before thanks to video upconversion. Upconversion will increase the resolution of standard definition DVD to near high definition up to 1080p over an HDMI® connection. The picture will be less jagged and more realistic for a near high-definition experience.

**Enjoy your content on different kinds of media:** Full backwards compatibility with Blu-ray Disc™, DVD and CD ensures that you can continue to enjoy your current audio-video collection. Additionally, you can view JPEG digital pictures or listen to MP3 or Windows Media™ Audio music files.

**PIP:** Some BD-videos have the PIP function which enables you to display the secondary video in the primary video. You can call up the secondary video by pressing **PIP** on the remote whenever the scene contains the secondary video.

**Pop-up menu:** Some BD-video have pop-up menu which is a navigation menu that can be called up and be operated on the TV screen without interrupting the playback. You can call up the pop-up menu by pressing **POP UP/MENU** or **TOP MENU** on the remote. Contents in the pop-up menu vary depending on the disc.

**Playing back AVCHD™ files:** This player supports playback of AVCHD™ format files (new format for high definition video camcorders) recorded on disc. Your high definition personal archive is playable in HD quality.

**x.v.Color®:** This player supports playback of video contents on discs recorded with “x.v.Color®” technology. To watch this video content with the “x.v.Color®”, a TV or other display device supporting both video image reproduction using the “x.v.Color®” standard and capable of manually switching its color setting is required. Please refer to the User’s Guide of your display device for further information.

**Wi-Fi CERTIFIED®** (for model BDX3300KC): The Wi-Fi CERTIFIED® logo is an assurance that Wi-Fi® Alliance has tested a product in numerous configurations and with a diverse sampling of other devices to ensure compatibility with other Wi-Fi CERTIFIED® equipment that operates in the same frequency band.

**Easy and simple connection to your HDTV via HDMI®:** Connect this player to your HDTV with one single HDMI® (High-Definition Multimedia Interface) cable. It is recommended to use a High Speed HDMI® Cable for better compatibility. The high definition video output signal will be transferred to your HDTV without conversion to analog signals, so you will get excellent picture and sound quality.

**HDMI®-CEC (Consumer Electronics Control):** This player supports HDMI®-CEC, which allows integrated system control over HDMI® and is part of the HDMI® standard. This function may not work properly on some devices.

**HDMI® 1080p/24F output (Blu-ray Disc™ only):** This player is equipped with a feature which can provide the smooth movement in the playback of film originated material with the frame rate of 24 frames per second with progressive scan. (Available only when the TV is connected by an HDMI® cable and compatible with 1080p/24F frame input.)

**Copyright protection system:** To play back the digital video images of a Blu-ray Disc™ / DVD via an HDMI® connection, it is necessary that both the player and the TV (or an AV amplifier) support a copyright protection system called HDCP (high bandwidth digital content protection system). HDCP is copy protection technology that comprises data encryption and authentication of the connected AV device. This player supports HDCP. Please read the operating instructions of your TV (or AV amplifier) for more information.

## Blu-ray Disc™/DVD player controls

### Front panel

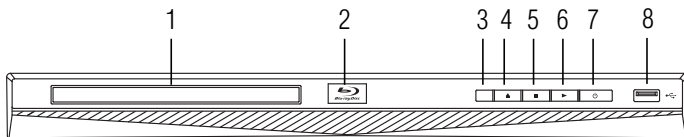

(Sample Illustration) Front panel controls

Item:	Operation:
1	Disc tray
2	Power indicator light
3	Remote sensor
4	Open/Close (▲) button
5	Stop (■) button
6	Play (▶) button
7	Power (⏻) button Press to turn on the player or place it into standby mode. NOTE: To completely turn the player off, you must unplug the AC power cord.
8	USB port Use to connect a USB flash drive/wireless LAN adapter (not included).

### Back panel

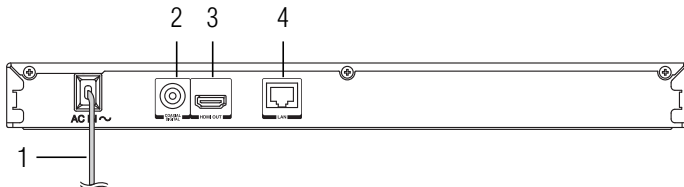

(Sample Illustration) Back panel connections

Item:	Description	Function:
1	AC power cord	Connects to a standard AC outlet to supply power to the player. To completely turn off the player, unplug the AC power cord.
2	Coaxial Digital Audio Out port	Connects an AV receiver/amplifier, Dolby® Digital/DTS® decoder, or other device using a coaxial digital audio cable.
3	HDMI® Out port	Connects to a TV with an HDMI® compatible port via an HDMI® cable. HDMI® connection is required for this player to operate properly. (HDMI® cables available only with certain models). NOTE: Analog connection is not supported.
4	LAN port	Connects network capable external devices.

## Remote control buttons

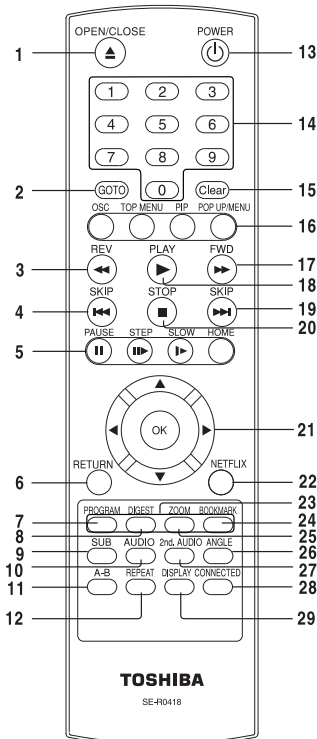

(Sample Illustration) Remote control buttons

Item:	Description:	Operation:
1	OPEN/CLOSE	Press to open or close the disc tray.
2	GOTO	Press to display the search menu.
3	REV	During playback, press to fast reverse the playback.
4	SKIP	During playback, press once to return to the beginning of the current title, chapter, track or file. During playback, press twice to return to the previous title, chapter, track or file. During the JPEG playback, press to return to the previous file.
5	PAUSE	Press to pause playback.
	STEP	Press to advance one frame.
	SLOW	Press to play back the disc slow motion.
	HOME	Press to display HOME menu.
6	RETURN	Press to return to the previous menu.
7	PROGRAM	Press to create program list for DVD/CD disc.
8	DIGEST	Press to display the thumbnail view for JPEG.
9	SUB (Subtitle)	Press to select the subtitle language.
10	AUDIO	Press to select the audio language.
11	A-B	Press to play back a defined section between point A and B repeatedly.
12	REPEAT	Press to toggle between various repeat modes.
13	POWER	Press to turn on the unit, or to turn the unit into the standby mode. (To completely turn off the unit, you must unplug the power cord.)
14	Number buttons	In playback mode, press GOTO, then input the numbers using the 0-9 number buttons to enter a title, chapter, track, time or file number. In menu mode, use the number buttons to enter the parental code password.
15	CLEAR	Press to clear an input error.
16	OSC	Press to display the OSC (On Screen Control) menu.
	TOP MENU	Press to display a top menu.
	PIP	Press to switch picture-in-picture feature on or off (only applicable to BD-video which supports the PIP function).
	POP UP/MENU	During Blu-ray Disc™ playback, press to open a menu that lets you control Blu-ray Disc™ playback. During DVD playback, press to open the DVD menu (if available).
17	FWD	During playback, press to fast forward the playback.
18	PLAY	Press to start playback or resume playback.
19	SKIP	During playback, press to skip to the next title, chapter, track or file. During the JPEG playback, press to go to the next file.

Item:	Description:	Operation:
20	■ STOP	Press to stop playback.
21	▲ / ▼ / ◀ / ▶	Press to select items or settings.
	OK	Press to confirm or select menu items.
22	NETFLIX®	Press to use Netflix service directly. (Make sure your Blu-ray Disc™/DVD player is correctly connected to the Internet and network settings are properly configured.)
23	RED/GREEN/ YELLOW/BLUE	Press to select items on some Blu-ray Disc™ contents. When file list / thumbnail list is shown, press to switch between pages.
24	BOOKMARK	Press to set your favorite bookmark for DVDs.
25	ZOOM	Press to zoom in / out the image for DVD / JPEG discs.
26	ANGLE	Press to select a viewing angle if multiple angles are available on the disc.
27	2nd. AUDIO	In PIP mode, press to turn the audio for the secondary video on or off.
28	CONNECTED	Press to display the CONNECTION menu.
29	DISPLAY	Press to display operating status.

## Installing the batteries

Install the batteries (AAAx2), matching the polarity indicated inside battery compartment of the remote control.

- 1 Open the battery cover.

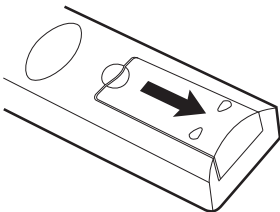

*(Sample Illustration) Remote control - Opening the battery cover*

- 2 Insert batteries.  
Make sure to match the polarity marks (+ / -) on the batteries to the marks indicated in the battery compartment.

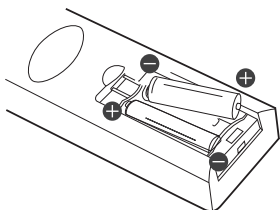

(Sample Illustration) Remote control - inserting the batteries

### 3 Replace the battery cover.

**CAUTION** Always dispose of used batteries in compliance with your local government. Never throw batteries into a fire.

### NOTE

Do not mix different battery types or combine used batteries with new ones. If the remote control does not operate correctly, or if the operating range is reduced, replace both batteries with new ones. If the batteries are dead or if you will not be using the remote control for a long time, remove the batteries to prevent battery acid from leaking into the battery compartment. Battery shall not be exposed to excessive heat such as sunshine, fire or the like. Danger of explosion if battery is incorrectly replaced. Replace only with the same or equivalent type. When discarding batteries, environmental problems must be considered and local rules or laws governing the disposal of these batteries must be strictly followed.

## Using the remote control

Point the remote control at the remote sensor and press the buttons:

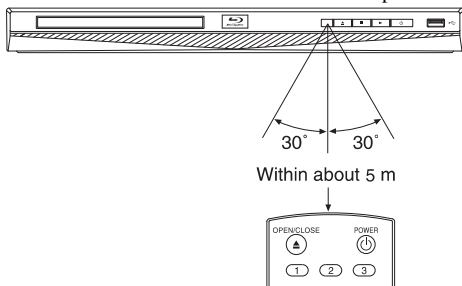

(Sample Illustration) Remote control angle

**Distance:** Approximately 5m from the front of the remote sensor.

**Angle:** About 30° in each direction from the front of the remote sensor.

**CAUTION** Do not expose the remote sensor to a strong light source such as direct sunlight or other illumination. This can damage the sensor resulting in the inability to operate the Blu-ray Disc™/DVD player via the remote control.

**CAUTION**

Do not drop or expose the remote control to electric shock.

Do not expose the remote control to excessively hot or humid places.

Do not spill water or place anything wet on the remote control.

Do not open the remote control.

If the remote control is not going to be used for a long period of time, remove the battery to avoid damage caused by battery leakage corrosion.

**NOTE**

Direct the remote control at the remote sensor of the Blu-ray Disc™/DVD player.

When using the remote control, press the buttons at intervals of approximately 1 second to ensure the correct mode of operation.

## Blu-ray Disc™/DVD player connections

### Connecting to a TV using an HDMI® cable

This connection provides better picture quality and supports up to 1080i/1080p, 1080p/24F resolution.

Connect an HDMI® cable from the HDMI® output jack on the player to the HDMI® input jack on the TV.

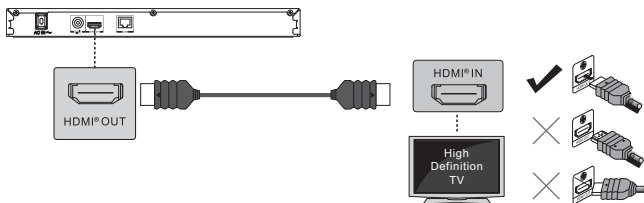

(Sample Illustration) Connecting to a TV - HDMI® cable

**NOTE**

HDMI® connection is required. (HDMI® cable sold separately).

Analog connection is not supported.

Do not tilt the connector when inserting it into the HDMI® jack, and make sure the shapes of the jack and the connector are matched.

When using a non-HDCP compatible TV, the image may not display properly.

An HDMI® cable carries both video and audio signals. If you wish to use TV speakers, you do not need to make an additional audio connection if you are using an HDMI® cable.

### Connecting to a digital amplifier/AV receiver

Route the sound from this player to your AV receiver or amplifier to enhance audio output.

- ❖ Connect a coaxial cable from the Coaxial Digital jack on the player to the Coaxial jack on your AV receiver or amplifier.
- ❖ If your AV receiver or amplifier has an HDMI® jack, you can also connect the HDMI® cable to the HDMI IN jack on your AV receiver or amplifier.

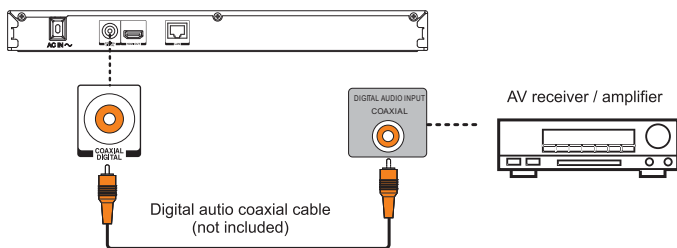

(Sample Illustration) Connecting to a digital amplifier/AV receiver

## Connecting to a network

Your Blu-ray Disc™/DVD player can be connected to your home network:

- ❖ By using a wired network. This provides the best performance, because the attached device and player are connected directly to the network and are not subject to radio frequency interference.
- ❖ By connecting through a wireless LAN adaptor and a wireless access point or router (for BDX2300KC model).
- ❖ By connecting through the built-in wireless device and a wireless access point or router (for BDX3300KC model).

### Connecting via wired router

Connect one end of an Ethernet cable (CAT5 or better with RJ45 connector) to the Ethernet jack on the front of your player, and the other end to a wired hub or broadband router.

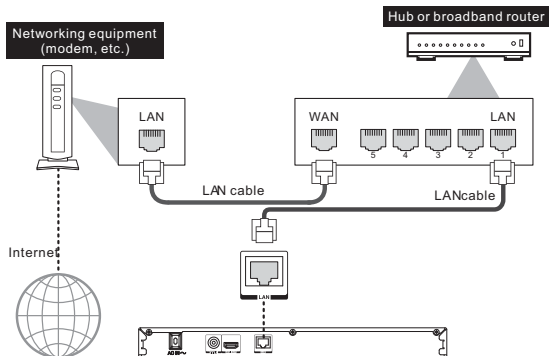

(Sample Illustration) Connecting to a wired router

## NOTE

Do not connect a modular phone cable to the Ethernet jack.

When plugging or unplugging the cable, hold the connector on the end of the cable.

When unplugging, do not pull on the cable. Press down the lock tab, and then pull the connector out of the jack.

Because there are various connection configurations, follow the instructions from your telecommunication carrier or Internet service provider.



**Connecting via wireless access point or router - for BDX2300KC model**

Your Blu-ray Disc™/DVD player can also be connected to a network via a Wireless access point.

**NOTE** USB Wi-Fi® adapter is not included and is required for a wireless connection.  
This unit is compatible with TOSHIBA's USB Wi-Fi® adapter only. Model name: WLM-12NB1.

A wireless AP/IP router is required to create a wireless network connection.

- 1 Connect the wireless LAN adapter to the USB port on the front panel of the Blu-ray Disc™/DVD player, and set the wireless network options.
- 2 After the Wi-Fi® device is inserted into the USB port, press the (▲ / ▼) arrow buttons to select **Network** from the Settings menu, and press the **OK** button to enter.

For detailed information, please refer to the device's User's Guide for WLM-12NB1.

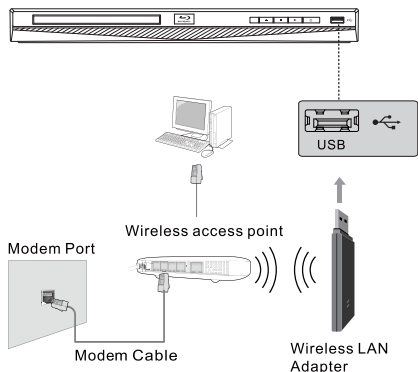

*(Sample Illustration) Connecting to a wireless router*

**Connecting your player to a wireless access point or router - for BDX3300KC model**

Your Blu-ray Disc™/DVD player has an integrated Wi-Fi® device and antenna. No physical connection to the wireless router is necessary.

- 1 Configure your player to access the wireless access point or router.
- 2 The network configuration and connection method may vary depending on the equipment in use and the network environment. Your Blu-ray Disc™/DVD player is equipped with an IEEE 802.11n wireless module, which also supports the 802.11 a/b/g/n standards. For the best wireless performance, we recommend using an IEEE 802.11n certified Wi-Fi® network (access point or wireless router).

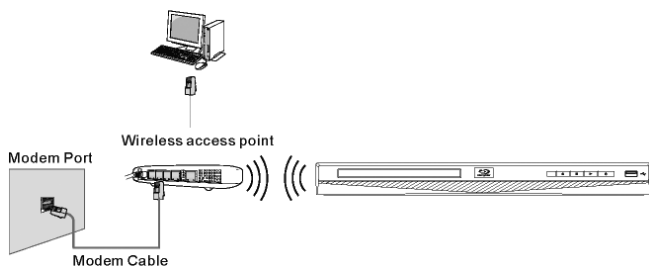

(Sample Illustration) Connecting to a wireless router

## NOTE

You must use a wireless IP sharer that supports IEEE 802.11 a/b/g/n. (n is recommended for stable operation of the wireless network.)

Wireless LAN, in its nature, may cause interference, depending on the use condition (AP performance, distance, obstacle, interference by other radio devices, etc.).

Set the wireless IP sharer to Infrastructure mode. Ad-hoc mode is not supported.

When applying the security key for the AP (wireless IP sharer), only the following is supported.

1. Authentication Mode: WPA2PSK, WPA2PSK
2. Encryption Type: WEP, TKIP, AES

## Connecting a USB flash drive

A USB flash drive provides additional capacity for software upgrades. You can also enjoy playing AVCHD™/MP3/WMA/JPEG and movie files you have stored on the USB flash drive. Insert a USB flash drive into the USB port on the front of Blu-ray Disc™/DVD player.

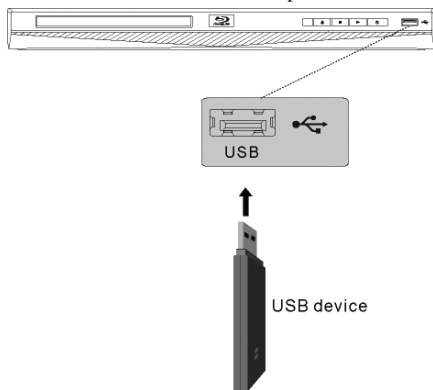

(Sample Illustration) Connecting a flash drive

- NOTE** Connect only a USB flash drive to the USB port on this product.  
If you cannot easily insert the USB flash drive, you may have inserted it incorrectly. Try to turnover the device and then insert again.  
Do not remove the USB flash drive during playback.  
BD-Live™: Access to BD-Live™ requires use of USB flash drive (not included) installed in the USB port. For additional information regarding the access to BD-Live™, see page 37 of the manual.  
TOSHIBA does not guarantee 100% compatibility with all USB flash drives.

- NOTE** If you want to enjoy BD-Live™ bonus content, you should connect a USB flash drive to the USB port, and an Ethernet cable to the Ethernet jack on the back of your player and to an Ethernet jack on a hub or broadband router.

## Blu-ray Disc™ playback

Before you start disc playback, read the following information.





- NOTE** **Cinavia Notice**  
This product uses Cinavia technology to limit the use of unauthorized copies of some commercially-produced film and videos and their soundtracks. When a prohibited use of an unauthorized copy is detected, a message will be displayed and playback or copying will be interrupted.  
More information about Cinavia technology is provided at the Cinavia Online Consumer Information Center at <http://www.cinavia.com>. To request additional information about Cinavia by mail, send a postcard with your mailing address to: Cinavia Consumer Information Center, P.O. Box 86851, San Diego, CA, 92138, USA.



## Disc and file playback

This player is compatible with the following discs/files.

To play back a disc/file, make sure that it meets the requirements for region codes and color systems as described below. You can play discs that have the following logos.

- NOTE** Other disc types are not guaranteed to play back.

<i>Logos:</i>	<i>Playable discs:</i>
	Blu-ray Disc™ BD-ROM (single/dual layer) BD-RE (single/dual layer) (Recorded in BDMV format) BD-R (single/dual layer) (Recorded in BDMV format) (Unclosed discs may not be played back.)
	DVD-ROM
	DVD-RW
	DVD-R

<i>Logos:</i>	<i>Playable discs:</i>
	CD-DA (audio CD)
	CD-RW
	CD-R
-	DTS®-CD
<i>Playable files:</i>	<i>Media:</i>
AVCHD™	DVD-RW/-R
MP3	BD-R/BD-RE, DVD-RW/-R, CD-RW/-R
Windows Media™ Audio	
JPEG	
MPG	
AVI	

This player cannot play back disc content that is protected by Windows Media™ Digital Rights Management (DRM).

## Un-playable discs and files

The following disc types will not play back in this player.

- ❖ CD-ROM
- ❖ CD-I (compact disc-interactive)
- ❖ DVD-RAM
- ❖ VSD (video single disc)
- ❖ DVD-audio
- ❖ HD DVD
- ❖ VIDEO CD
- ❖ Un-finalized disc
- ❖ Blu-ray Disc™/DVD containing DivX® files
- ❖ Blu-ray Disc™/DVD hybrid disc (played back as a BD-video only)
- ❖ Blu-ray Disc™ that contains AVCHD™ files
- ❖ DVD-RW/-R recorded in non compatible recording format
- ❖ Super Audio CD. Only the sound on the CD layer can be heard. The sound on the high-density Super Audio CD layer cannot be heard.
- ❖ Playability of dual discs are not guaranteed
- ❖ Multi session disc
- ❖ Multi border disc

## Region codes

This player has been designed to play back BD-video with region “A” and DVD-video with region “1” or “ALL.” You cannot play back BD-video or DVD-video that are labeled for other regions. Look for the symbols on your BD-video or DVD-video.

If these region symbols do not appear on your BD-video or DVD-video, you cannot play back the disc in this player. The letter or number inside the globe refers to region of the world. A BD-video or DVD-video labeled for a specific region can only be played back in the player with the same region code.



(Sample Illustration) Region Codes

## Color system

BD-video and DVD-video are recorded in different color systems throughout the world. The most common color system is NTSC (which is used primarily in the United States and Canada).

## Disc contents structure

The contents of Blu-ray Disc™/DVD/AVCHD™ are generally divided into titles. Titles may be further subdivided into chapters.

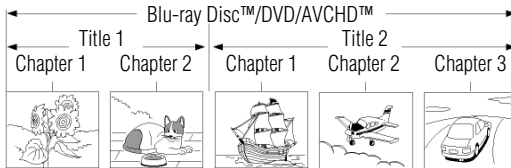

(Sample Illustration) Sample structure of disc contents - chapters and titles

An audio CD is divided into tracks.



(Sample Illustration) Audio CD track structure

Data discs or USB flash drives containing MP3/WMA/JPEG are divided into folders, and the folders are subdivided into files.

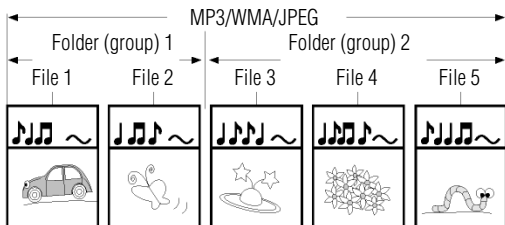

(Sample Illustration) Data disc/USB file structure

## Basic playback

When you wish to view a disc, turn the TV On and select the video input connected to the Blu-ray Disc™/DVD player.

- 1 Press the **POWER** (⏻) button.  
The Blu-ray Disc™/DVD player turns on.
- 2 Press the **OPEN/CLOSE** (⏏) button.  
The disc tray opens.

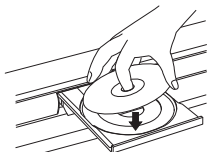

(Sample Illustration) Placing the disc on the disc tray

- 3 Place the disc on the disc tray with the playback side facing down.

**▲ CAUTION** Keep your fingers clear of the disc tray as it is closing. Neglecting to do so may cause serious personal injury.

- 4 Press the **OPEN/CLOSE** (⏏) button to close the disc tray.  
Playback begins.

### NOTE

If you insert a Blu-ray Disc™ or a DVD that contains a top menu, a menu may appear. Press the (▲/▼/◀/▶) arrow buttons to select the title you wish to view, then press the **OK** button to begin playback.

You may need to press the **TOP MENU** or **POP UP/MENU** button to display the pop up menu / top menu / disc menu (depending on the actual Blu-ray disc™ or DVD.)

- 5 Press the **PLAY** (▶) button to begin playback in stop mode.
- 6 Press the **PAUSE** (⏸) button during playback to pause playback in still mode.
- 7 Press the **PLAY** (▶) button to resume normal playback.  
The sound is muted during still mode.
- 8 Press the **STOP** (■) button once to stop playback.
  - ❖ Blu-ray™ discs: The home menu appears.  
Press the **PLAY** (▶) button to begin playback again or press the (▲/▼) arrow buttons to select BD-ROM, and then press the **OK** button to begin playback at the beginning of the disc.

- ❖ DVDs/audio CDs: It will enter the stop mode.

Press the **PLAY** (▶) button to resume normal playback. Depending on the disc type, playback begins where it stopped or at the beginning of the disc.

- 9 During DVD/audio CD playback, if you press the **STOP** (■) button twice, playback stops completely and the home menu appears. Press the **PLAY** (▶) button to begin playback again or press the (▲/▼) arrow buttons to select DVD-ROM/CD, and then press the **OK** button to begin playback at the beginning of the disc.
- 10 Press the **OPEN/CLOSE** (▲) button to remove the disc.
- 11 Remove the disc after the disc tray opens completely.
- 12 Be sure to press the **OPEN/CLOSE** (▲) button to close the disc tray after you remove the disc.
- 13 Press the **POWER** (⏻) button to turn the player Off.

### Automatic power off function

When you leave the unit in stop mode for more than 5 minutes, the screen saver is activated if you set the Screen Saver to On mode. At the end of 25 minutes without any user interaction, the unit automatically switches off.

### Variable speed playback

You can play discs at various speeds, and resume playback from the location you stopped playback.

#### Fast reverse/forward playback

- 1 Press the **Fast reverse playback** (◀◀) buttons or the **Fast forward playback** (▶▶) button during playback.

Each time you press the button, the fast-forward or fast-reverse speed progresses in the following sequence:

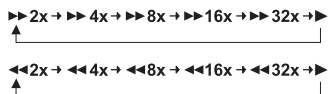

- 2 Press the **PLAY** (▶) button to resume normal playback.

#### NOTE

The Blu-ray Disc™/DVD player mutes sound and subtitles during reverse and forward scan. The playback speed may differ depending on the disc type.

### Frame by frame playback

- 1 Press the **STEP** (▯▶) button during still playback.  
Each time you press this button, the picture advances one frame.
- 2 Press the **PLAY** (▶) button to resume normal playback.

#### NOTE

The sound is muted during frame by frame playback.

### Slow motion playback

- 1 Press the **SLOW** (▯▶) button during playback.  
Each time you press this button, the slow-motion speed progresses in the following sequence:

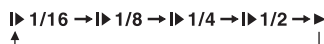

- 2 Press the **PLAY** (▶) button to resume normal playback.

#### NOTE

The sound is muted during slow-motion playback.

## Locating a desired section

Normally, Blu-ray™ Discs and DVDs are divided into titles, and the titles are sub-divided into chapters. Audio CDs are divided into tracks. You can quickly locate any specific title, chapter, or track.

### Locating a title using TOP MENU / POP UP / MENU

- 1 Press the **TOP MENU / POP UP / MENU** button.  
The top / pop up menu appears on the TV screen.
- 2 Press the (▲/▼/◀/▶) arrow buttons to select the title you wish to select.  
If the titles in the top menu are assigned a number, you can directly locate a specific title by pressing its designated number with the number buttons on the remote control.
- 3 Press the **OK** button.  
Playback begins from Chapter 1 of the selected title.

### Locating a specific chapter or track

- 1 Press the **SKIP Reverse** (◀◀) or **SKIP Forward** (▶▶) button repeatedly to access the chapter or track number you wish to select.  
Playback starts from the selected chapter or track.
- 2 Press the **SKIP Reverse** (◀◀) button to start playback from the beginning of the current chapter or track.  
When you press twice in quick succession, playback starts from the beginning of the preceding chapter or track.
- 3 Press the **SKIP Forward** (▶▶) button to locate succeeding chapters or tracks.

**NOTE** Some titles may not display chapter numbers.

## Accessing a specific location directly

### Locating a specific time in a DVD/Blu-ray Disc™

- 1 During playback, press the **GOTO** button and use the (▲/▼) arrow buttons to select **TT** (Title) or **CH** (Chapter). Then press the **OK** button.



(Sample Illustration) Locating a specific time

- 2 Press the (◀/▶) arrow buttons to move the cursor to the Hour, Minute or Second.
  - ❖ The first two numbers represent hours.
  - ❖ The second two numbers represent minutes.
  - ❖ The third two numbers represent seconds.
- 3 Press the (▲/▼) arrow buttons or the corresponding number buttons (0-9) for the time you want, then press the **OK** button to confirm.  
Playback starts from the selected time.

### Locating a specific title in a DVD/Blu-ray Disc™

- 1 During playback, press the **GOTO** button and use the (◀/▶) arrow buttons to move the cursor to **TT** (Title). Then press the **OK** button.



(Sample Illustration) Locating a specific title

- 2 Press the (▲/▼) arrow buttons or the corresponding number buttons (0-9) for the title you want. Then press the **OK** button to confirm.  
Playback starts from the selected title.



### Locating a specific chapter in a DVD/Blu-ray Disc™

- 1 During playback, press **GOTO** button and use the (◀/▶) arrow buttons to move the cursor to the chapter, then press the **OK** button.



(Sample Illustration) Locating a specific chapter

- 2 Press the (▲/▼) arrow buttons or the corresponding number buttons (0-9) for the chapter you want. Then press the **OK** button to confirm.  
Playback starts from the selected chapter.

### Locating a specific time in a CD

- 1 During playback, press the **GOTO** button and use the (▲/▼) arrow buttons to select **TRACK** or **DISC**. Then press the **OK** button.



(Sample Illustration) Locating a specific time—CD

- 2 Press the (◀/▶) arrow buttons to move the cursor to the Hour, Minute or Second.
  - ❖ The first two numbers represent hours.
  - ❖ The second two numbers represent minutes.
  - ❖ The third two numbers represent seconds.
- 3 Press the (▲/▼) arrow buttons or the corresponding number buttons (0-9) for the time you want. Then press the **OK** button to confirm.  
Playback starts from the selected time.

### Locating a specific track in a CD

- 1 During playback, press **GOTO** button and use the (◀/▶) arrow buttons to move the cursor to **TT** (Track). Then press the **OK** button.

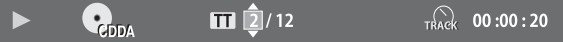

(Sample Illustration) Locating a specific track

- 2 Press the (▲/▼) arrow buttons or the corresponding number buttons (0-9) for the track you want. Then press the **OK** button to confirm.  
Playback starts from the selected track.

## Repeating a title, chapter, track or specific segment

### Repeating a title, chapter or track

Press the **REPEAT** button repeatedly to select the desired repeat mode during playback.



Repeat Title



Repeat Chapter



Repeat All



Repeat Single



Repeat All

(Sample Illustration) Selecting various repeat modes

- NOTE** The repeat setting will be cancelled when you stop playback.  
The chapter, title or track repeat will be cleared when moving to another chapter, title, track / file.  
Chapter and title repeat are not available with some scenes.

### Repeating a specific segment

- 1 Press the **A-B** button at the desired starting point A during playback.
  - 2 Press the **A-B** button at the desired ending point B during playback.  
The Blu-ray Disc™/DVD player automatically returns to point A and starts repeat playback of the selected segment (A-B).
- To resume normal playback press the **A-B** button and the A-B will disappear, meaning normal playback has resumed.

- NOTE** Some discs may not permit A-B repeat operation.  
You can specify a segment only within the current title or track.  
You cannot set the A-B repeat function for a segment that includes multiple camera angles.

### PIP setting

Some Blu-ray™ discs have the PIP function enabling you to display the secondary video in the primary video. You can call up the secondary video by pressing the **PIP** button when the scene contains the secondary video. See the documentation that came with the disc for playback instructions.

- 1 Press the **PIP** button during playback to turn PIP mode On.
- 2 Press the **2nd. AUDIO** button to turn the audio for the video in the PinP window On/Off.

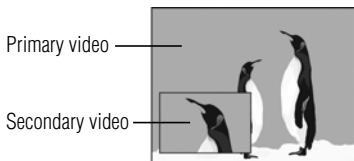

*(Sample Illustration) PIP view function*

- 3 Press the **PIP** button to turn PIP mode Off and resume normal playback.

- NOTE** Not all discs are available for PIP and 2nd Audio. It only applies to Blu-ray™ Discs that support picture-in-picture features and 2nd Audio.

### Camera angle

Some BD-video and DVD-video contain scenes that have been shot simultaneously from various angles.

- 1 Press the **ANGLE** button during playback.  
The selected angle is displayed on the display bar at the top of the TV screen.



*(Sample Illustration) Selecting the desired angle*

The first digit indicates the current viewing angle, and the second digit indicates the total number of viewing angles.

- 2 Press the **ANGLE** button repeatedly to select the desired angle.

## Audio selection

- 1 Press the **AUDIO** button during playback.



*(Sample Illustration) Selecting the desired audio language*

In the example “1/2 English DTS-HD® MA 5.1 CH”:

- ❖ “1” indicates the currently selected audio channel
- ❖ “2” indicates the total number of audio channels
- ❖ “English” indicates the audio language
- ❖ “DTS-HD® MA 5.1 CH” describes the currently selected audio format

- 2 Press **AUDIO** repeatedly to select the desired audio language.

### NOTE

The available options of Audio playback vary from depending on the disc format.

## Subtitle selection

- 1 During playback, press **SUB**.



*(Sample Illustration) Selecting the desired subtitle setting*

- ❖ “1” indicates the currently selected subtitle.
- ❖ “2” indicates the total number of subtitles.
- ❖ “English” indicates the subtitle language.

- 2 Press **SUB** repeatedly to select the desired subtitle language.

The current subtitle setting is displayed.

To turn off the subtitle setting display, press the **SUB** button repeatedly until **Off** is displayed.

## Playing in a favorite order

You can combine your favorite titles, chapters or tracks and play them in the order you determine. You can program up to 15 selections into the memory (Memory playback).

- 1 During playback, press the **PROGRAM** button.

The following display appears.

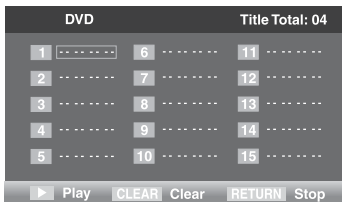

*(Sample Illustration) DVD Program display*

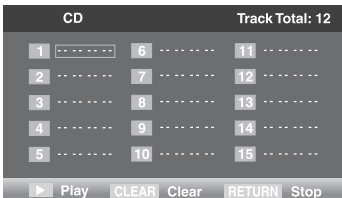

*(Sample Illustration) CD Program display*

- Press the **OK** button and the **TT** (Title) is highlighted. Then press the (**▲/▼**) arrow buttons or the corresponding number buttons to enter the Title (**TT**) (for DVD movie) or Track number (for audio CD).
- Use the (**◀/▶**) arrow buttons to highlight the **CH** (Chapter) and also press the (**▲/▼**) arrow buttons or the corresponding number buttons to enter the Chapter (for DVD movie).



(Sample Illustration) DVD title/chapter number display

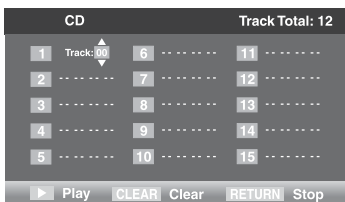

(Sample Illustration) CD track number display

- Press the **PLAY** button to start memory playback.  
To resume normal playback from memory playback
  - Press the **PROGRAM** button.
  - Press the **CLEAR** button repeatedly until all entered programs are cleared.
  - Press the **PLAY** button to resume normal playback.

## NOTE

Some discs may not permit memory playback.

The programmed selections will be cleared when you open the disc tray or turn off the unit.  
If you press the **PROGRAM** button while the display appears on the TV screen, the display disappears.

## Digest playback

- During JPEG playback, press the **DIGEST** button.  
A thumbnail view screen appears.
- Press the **SKIP Reverse** (**◀◀**) or **SKIP Forward** (**▶▶**) button to select the previous/next thumbnail screen.
- Use the (**▲/▼/◀/▶**) arrow buttons to select an image you would like to playback in full screen, and then press the **OK** button.

## Zooming a picture

Press **ZOOM** during normal, slow or still playback.

The center part of the image will be zoomed in or out.

Each time you press the **ZOOM** button, the magnification/minification level changes as follows:

🔍 Zoom 2X → 🔍 Zoom 3X → 🔍 Zoom 4X → 🔍 Zoom 1/2 → 🔍 Zoom 1/3 → 🔍 Zoom 1/4

(Sample Illustration) Zoom levels

Press the (▲/▼/◀/▶) arrow buttons to view a different part of the image. You may move the image from the center position to UP, DOWN, LEFT and RIGHT direction. When you reach the edge of the image, the display will not shift anymore in that direction.

**NOTE**

Some discs may not respond to zoom feature.  
During some scenes, the buttons may not work as described.

**Bookmark**

- 1 During playback, press the **BOOKMARK** button to mark the desired scene. The bookmark number, the current title and chapter, the elapsed time of the current title appears on the screen. You can set up to 12 bookmarks on a DVD.
- 2 Press and hold the **BOOKMARK** button until the bookmark menu appears. Use the (▲/▼/◀/▶) arrow buttons to select one option, and then press the **OK** button to play the favorite bookmark.

To cancel the bookmark:

- 1 Press and hold the **BOOKMARK** button until the bookmark menu appears.
- 2 Press the **Clear** button repeatedly until all bookmarks are cleared.
- 3 Press the **OK** button to resume normal playback.

**OSC (On Screen Control) operation**

- 1 During playback, press the **OSC** button. The OSC menu appears on the screen.
- 2 Press the (▲/▼) arrow buttons to select options, and press the **PLAY** (▶) or **OK** button. Use the (▲/▼) arrow buttons to make adjustment and press **OK**.

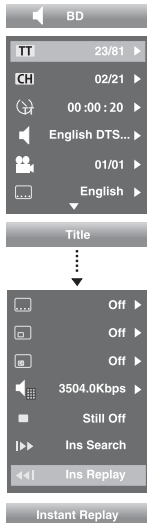
**When playing a BD:**

**Title:** To select the title you want to locate.

**Chapter:** To select the chapter you want to locate.

**Time:** To display the elapsed time or remaining time of current title / chapter.

**Audio:** To select the audio language.

**Angle:** To select the camera angle.

**Subtitle:** To select a subtitle language.

**Subtitle Style:** To select a subtitle style.

**Second Video:** To turn on/ off second video.

**Second Audio:** To turn on/ off second audio.

**Bitrate:** To select a bitrate.

**Still Off:** To pause or normal playback.

**Instant Search:** To fast forward playback.

**Instant Replay:** To fast reverse playback.

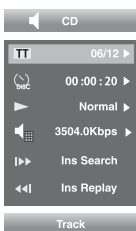
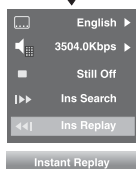

### When playing a DVD:

**Title:** To select the title you want to locate.

**Chapter:** To select the chapter you want to locate.

**Time:** To display the elapsed time or remaining time of current title / chapter.

**Mode:** To select play mode.

**Audio:** To select the audio language.

**Angle:** To select the camera angle.

**Subtitle:** To select a subtitle language.

**Bitrate:** To select a bitrate.

**Still Off:** To pause or normal playback.

**Instant Search:** To fast forward playback.

**Instant Replay:** To fast reverse playback.

### When playing a CD:

**Track:** To select the track you want to locate.

**Time:** To display the elapsed time or remaining time of disc or current track.

**Mode:** To select play mode.

**Bitrate:** To select a bitrate.

**Instant Search:** To fast forward playback.

**Instant Replay:** To fast reverse playback.

- 3 Press the **OSC** button again to exit.

## Displaying on-screen information

Press the **DISPLAY** button:

Your unit displays information about the Disc, such as type of disc, title number, chapter number, elapsed time of the current title, audio format, subtitle language.

Press the **DISPLAY** button again to exit.



(Sample Illustration) BD-video



(Sample Illustration) DVD-video/AVCHD™



(Sample Illustration) CD



(Sample Illustration) MP3/WMA



(Sample Illustration) JPG

## Playing AVCHD™/MP3/WMA/JPEG files

You can play AVCHD™, MP3, WMA or JPEG files that have been recorded on a disc or a Media Server on the Blu-ray Disc™/DVD player.

### Playing files on a data disc

When inserting a data disc containing pictures, music, or video files into your player, icons are added to the menu to indicate that video, music, or picture files are available for playback.

- 1 Press the **OPEN/CLOSE** (▲) button to open the disc tray, and load a disc that contains video/MP3/JPEG files.
- 2 On the **Home** menu, press the (▲/▼) arrow buttons to select **Video**, **Music**, or **Photo**, and then press the **OK** button.  
The Media Center menu appears on the screen.

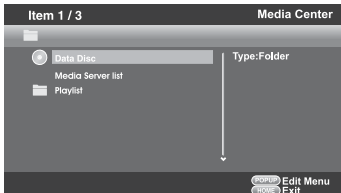

(Sample Illustration) Media Center menu

- 3 Press the (▲/▼) arrow buttons to select **Data Disc** and press **OK**.
- 4 Press the (▲/▼) arrow buttons to select a file (or folder) and press **OK** or **PLAY** to start playback.

### Playing files on a Media Server

- 1 Set the Media Server Search to **Enable**.
- 2 In the **Home** menu, press the (▲/▼) arrow buttons to select **Video**, **Music**, or **Photo**, and then press the **OK** button.
- 3 Press the (▲/▼) arrow buttons to select **Media Server list**, and then press **OK**.
- 4 Press the (▲/▼) arrow buttons to select **Video**, **Music** or **Photo**, and press **OK**.  
It should match the selection in the **HOME** menu. (If you selected **Video** in **HOME** menu, you also should select **Video** here.)
- 5 Press the (▲/▼/◀/▶) arrow buttons to select a file (or folder), and press the **OK** or **PLAY** button to start playback.

## NOTE

Make sure your player is properly connected to the network before using it. Furthermore, you need at least one Media Server in the network to see and/or hear contents.

Do not remove the LAN connector during playback.

Not all media formats are supported.

## Using a USB flash drive

You can play AVCHD™, MP3, WMA or JPEG files that have been stored on USB flash drives on the Blu-ray Disc™/DVD player.

### Operating a USB flash drive

- 1 Insert a USB flash drive into the USB port of the Blu-ray Disc™/DVD player until it clicks.
- 2 In the **Home** menu, press the (▲/▼) arrow buttons to select **Video**, **Music**, or **Photo**, and then press the (▶) arrow button or the **OK** button.  
The Media Center menu appears on the screen
- 3 Press the (▲/▼) arrow buttons to select **USB1**, and press **OK**.
- 4 Press the (▲/▼) arrow buttons to select a file (or folder), and press the **OK** or **PLAY** button to start playback.

For additional operations, please follow the instructions in “Playing AVCHD™/MP3/WMA/JPEG files” on page 31.

To remove the USB flash drive, gently pull the drive out of the player slowly, while in stop mode.

---

#### **NOTE**

If you cannot easily insert the USB flash drive, you may have inserted it incorrectly. Try to turnover the device and then insert again.  
Do not remove the USB flash drive during playback.

---

## Customizing the function settings

You can change the default settings to customize performance to your preference.

### Performing Easy Setup

If it is the first time for the player to start up or users restore all settings to factory defaults, the system will prompt you to perform Easy Setup.

Follow the on-screen instructions to customize the following settings to your preference:

- ❖ **OSD Language:** (English/French/Spanish)
- ❖ **Resolution:** (Auto/480i/480p/720p/1080i/1080p)
- ❖ **TV Screen:** (16:9 Full / 16:9 Normal / 4:3 Pan & Scan / 4:3 Letterbox)

After setting, press **OK** to confirm and exit.

### General operations

- 1 Press the **HOME** button in stop mode to display the **HOME** menu. Then use the (▲/▼) arrow buttons to select **Setting**.
- 2 Press the (▶) arrow button, and then the (▲/▼) arrow buttons to select the setting options.
- 3 Press the **OK** button.
- 4 Press the (◀) arrow button or the **RETURN** button to return to the previous menu.



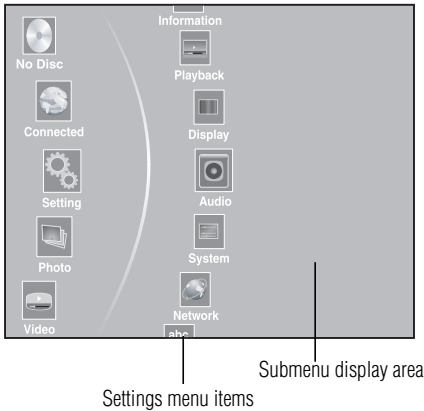

(Sample Illustration) General operations settings

## Information

This menu displays the following information:

- ❖ Software version
- ❖ MAC Address
- ❖ Netflix® ESN

- 1 In the main **Settings** menu, press the (▲/▼) arrow buttons to select **Information** to display the software version, MAC Address and Netflix® ESN.
- 2 Press the (◀) arrow button or the **RETURN** button to return to the previous menu.

## Playback

- 1 In the main **Settings** menu, press the (▲/▼) arrow buttons to select **Playback**, and then press the (▶) arrow button or the **OK** button to confirm.
- 2 Press the (▲/▼) arrow buttons to select an option, and then press **OK**.
- 3 Use the (▲/▼) arrow buttons to select On/Off, and then press **OK**.
- 4 Press the (◀) arrow button to go to the previous menu.

## Angle Mark

To turn on/off the angle mark.

## PIP Mark

To turn on/off the PIP mark.

## Secondary Audio

To turn on/off secondary audio.

## Last Memory

To turn on/off the last memory.

## Display settings

- 1 In the main **Settings** menu, press the (▲/▼) arrow buttons to select **Display**, and then press the (▶) arrow button or **OK** button to confirm.
- 2 Press the (▲/▼) arrow buttons to select an option, and then press the **OK** button.
- 3 Use the (▲/▼) arrow buttons to select the desired option, and then press the **OK** button to confirm your selection.
- 4 Press the (◀) arrow button to return to the previous menu.

## TV Screen

**16:9 Full**, **16:9 Normal**, **4:3 Pan & Scan** and **4:3 Letterbox** are available for your choice.

## Resolution

You can define the video output resolution in this option.

Resolution:	TV Type:
Auto	If your TV is a high-definition TV (HDTV) connected to the HDMI® jack on your player and you want your player to set the output resolution based on information exchanged between the TV and your player over the HDMI® cable.
480i	If your TV is a standard-definition TV (SDTV) capable of 480i only.
480p	If your TV is an enhanced-definition TV (EDTV) capable of 480p only.
720p	If your TV is a high-definition TV (HDTV) capable of 720p only.
1080i	If your TV is a high-definition TV (HDTV) capable of 1080i only.
1080p	If the TV is a high-definition TV (HDTV) capable of 1080p (any frame rate) connected to the HDMI® jack on your player.

### NOTE

Selecting a resolution the TV does not support could result in an unstable picture or loss of the picture. See the documentation that came with the TV to find the resolutions the TV supports.

Only the HDMI® output on your player supports 1080p video output at any frame rate.

## Color Space

To select the RGB, YCbCr, YCbCr422, or Full RGB to match your TV for perfect display effect.

### HDMI® Deep color

This option decides whether to turn off the Deep Color (color depth) setting for video signals output from the HDMI OUT jack.

Connecting the player and a TV that supports HDMI® Deep Color allows more accurate color reproduction than when connecting it to a TV that does not support HDMI® Deep Color. It is recommended to set this option Off if the picture is unstable or colors appear unnatural.

### HDMI® 1080/24p

Movies are recorded on film at a rate of 24 pictures (frames) per second. Many of the movies on Blu-ray™ discs are placed on the discs at this frame rate. However, not all TVs can display 24 progressive frames/second of video. If the TV cannot display this frame rate, you need to turn off HDMI® 1080/24p.

## Video Adjust

**Brightness:** Adjust the brightness of the picture.

**Contrast:** Adjust the contrast of the picture. The black portions of the picture become richer in darkness and the white become brighter.

**Hue:** Adjust the hue of the picture.

**Saturation:** Adjust the amount of color in the picture.

### Sharpness

Adjust the sharpness levels (Low, Middle or High) to improve detail in the picture.

## Audio setting

The settings in the Audio menu will configure the Blu-ray Disc™/DVD player's digital audio outputs (HDMI® or Coaxial).

- 1 In the main **Settings** menu, press the (▲/▼) arrow buttons to select **Audio**, and then press the **OK** button.
- 2 Press the (▲/▼) arrow buttons to select an option, and then press the **OK** button.
- 3 Use the (▲/▼) arrow buttons to select the desired audio setting, and then press the **OK** button to confirm.
- 4 Press the (◀) arrow button to return to the previous menu.

## SPDIF

When you connect an audio system to the COAXIAL DIGITAL output jack (see “Connecting to a digital amplifier/AV receiver” on page 15) the options are:

- ❖ **Bitstream**: Selects Bitstream output if your receiver SPDIF (Coax) IN supports Dolby® or DTS® or PCM audio signal.
- ❖ **PCM**: Selects PCM output if your receiver SPDIF (Coax) IN only supports PCM stereo audio signal.
- ❖ **Re-encode**: Selects Re-encode output if your receiver SPDIF (Coax) IN supports Dolby® or DTS® and you want to hear both PIP audio and the movie audio on Blu-ray™ video.
- ❖ **Off**: No audio will be output via COAXIAL DIGITAL output jack.

## HDMI®

When you connect an HDMI® device to the HDMI OUT jack (see “Connecting to a digital amplifier/AV receiver” on page 15). The available options are:

- ❖ **Bitstream**: Selects Bitstream output if your receiver HDMI IN supports Dolby® or DTS® or PCM audio signal.
- ❖ **PCM**: Selects PCM output if your receiver HDMI IN only supports PCM audio signal.
- ❖ **Re-encode**: Selects Re-encode if your receiver's HDMI IN supports Dolby® or DTS® and you want to hear both PIP audio and movie audio on Blu-ray™ video.
- ❖ **Off**: No audio will be output via HDMI OUT jack.

## Down-Samp

If you don't have a surround sound receiver connected to the Blu-ray Disc™/DVD player, you should leave the PCM downsampling to 48 kHz, and proceed to the next setup menu item. If you have a surround sound receiver connected to the Blu-ray Disc™/DVD player, and you have connected to the surround receiver via the Blu-ray Disc™/DVD player's HDMI® output, this setting has no effect on the audio going to the HDMI® output of the player. Leave the PCM downsampling to 48 kHz, and proceed to the next setup menu item.

**NOTE** Incorrectly setting the digital audio output's Down-Sample rate too high may result in unpredictable audio playback.

## Dolby® DRC (Dynamic Range Control)

Dynamic Range Control means that you can allow the Blu-ray Disc™/DVD player to make the loud parts of a movie's audio track quieter than they would be in the theatre, without making the dialog of the actors any quieter.

This would be useful, for instance, when you want to watch a movie in the evening when others might be sleeping.

When Dynamic Range Control is set to Off, movie soundtracks are played with the standard dynamic range. When movie soundtracks are played at low volume or from smaller speakers, you can set Dynamic Range Control to On. Your player applies appropriate compression to make low-level content more intelligible and prevent dramatic passages from getting too loud.

Selecting the “Auto” option turns on the Dynamic Range Control for all Blu-ray Disc™ movie soundtracks except Dolby® TrueHD. If you have selected a Dolby® TrueHD track on the Blu-ray Disc™, the “auto” selection tells the Blu-ray Disc™/DVD player to only turn on dynamic range control if information embedded in the Dolby® TrueHD sound track tells it to do so.

## Stereo Down Mix

Select whether to downmix the multi-channel audio into fewer channels.

- ❖ **Stereo**—Downmixes the multi-channel audio into two channel stereo. Choose when the Blu-ray Disc™/DVD player is connected to equipment that does not support virtual surround function such as Dolby® Pro Logic.
- ❖ **Surround Encoded (LtRt)**—Downmixes the multichannel audio into surround compatible stereo. Choose when the Blu-ray Disc™/DVD player is connected to equipment that supports virtual surround function such as Dolby® Pro Logic.

## System setting

- 1 In the main **Settings** menu, press the (▶) arrow button, then use the (▲/▼) arrow buttons to select **System**, and then press the **OK** button.
- 2 Press the (▲/▼) arrow buttons to select an option, and then press the **OK** button.
- 3 Use the (▲/▼) arrow buttons to select the desired setting, and then press the **OK** button to confirm.
- 4 Press the (◀) arrow button to return to the previous menu.

## Screen saver

This Blu-ray Disc™/DVD player has a screen saver feature for when your player is inactive. You can set it to **On** or **Off**.

If you set the Screen Saver to **On** mode, the screen saver of the unit automatically appears when you leave the unit in stop mode for more than 5 minutes.

## Disc auto play

If **On** is selected, a Blu-ray Disc™ will load data and play back automatically when you insert it. If **Off** is selected, when you insert a Blu-ray Disc™, it will be displayed on the Settings menu.

## CEC

This option is used to allow the TV remote control to control certain functions of the Blu-ray Disc™/DVD player, and the Blu-ray Disc™/DVD player to control certain functions of the TV.

- ❖ **On**: Allow mutual control of devices through HDMI®.
- ❖ **Off**: Do not allow CEC control.

## NOTE

Not all TVs are compatible with your Blu-ray Disc™/DVD player.  
The default setting is **Off**. Select **On** if CEC control is necessary.

## Load Default:

Press the **OK** button to pop up a dialog box, choose **OK** in the box, and then press **OK** to confirm.

To apply the deactivation, please unplug the player after operating deactivation.

## Deactivate Setting

Action:	Response:
Deactivate all connected applications	Deactivates all connected applications
Deactivate Netflix®	Deactivates the connected Netflix® application
Deactivate YouTube®	Deactivates the connected YouTube® application
Deactivate CinemaNow®	Deactivates the connected CinemaNow® application
Deactivate Picasa™	Deactivates the connected Picasa™ application

## Upgrade

This option allows to update your product software via a Disc, USB storage or Network.

## External Memory

BUDA Information: To display the external memory information.

## Network connection setting

- 1 In the main **Settings** menu, press the (▲/▼) arrow buttons to select **Network**, and then press the **OK** button.
- 2 Press the (▲/▼) arrow buttons to select an option, and then press the **OK** button.
- 3 Press the (◀) arrow button to go to the previous menu.

### Internet Connection

To enable/disable the Internet connection.

### Interface

To select the Ethernet or Wireless.

### Connection Test

Selecting the Connection Test will cause the player to attempt to communicate with your home network, and if successful, with a known Internet address. If both attempts are successful, your network connection should be good. If the player can successfully connect to your home network, but not to the known Internet address, your Internet service may be “down”, or your security firewall may be blocking access of the player to the Internet.

### IP Setting

To select Auto or Manual to set IP.

For step by step instruction, see “Connecting to a network” on page 16.

### BD-Live™ Connection

- ❖ Permitted - Always allows BD-Live™ network access.
- ❖ Partial Permitted - Allows Internet access with valid BD-Live™ network access approval.
- ❖ Prohibited - Never allows BD-Live™ Internet access.

Some (but not all) Blu-ray™ Discs contain additional features that are made available to players that are connected to the Internet, and have additional memory added. These additional features may include things like:

- ❖ the ability to download new movie trailers
- ❖ additional ‘commentary’ by actors and directors
- ❖ multi-person game play and chat

In order to access BD-Live™ functions, the player must be properly configured for BD-Live™ Internet access, and it must be equipped with additional memory.

---

#### NOTE

BD-Live™ requires connection of a USB flash drive of at least 1 GB (sold separately) to USB port. For models without built-in Wi-Fi®, BD-Live™ is only supported via Ethernet so when using single USB port for Internet access, BD-Live™ will not be available. Performance of interactive features may vary due to disc design or content, and may also require an always-on broadband Internet connection. Firmware update may be required for some interactive features. Some features may require additional bandwidth. Some features may not be available in all geographic locations and are subject to third party compatibility.

---

#### NOTE

Depending on your connection environment, it may take time to connect to the Internet or the Internet may not be connected.

When BD-Live™ functions are used and the unit is connected to the Internet, you may be charged for this communication.

Do not remove the USB flash drive when using the BD-Live™ function.

---

### Information

To display the Network Information.

### External control setting

To set the Device Name, User Name, Password or Port Number.

### Media Server Search

Media Server Search function enables you to create an interoperability network with other devices for resource sharing based on a network.

### Language settings

- 1 In the main **Settings** menu, press the (▲ / ▼) arrow buttons to select **Language**, and then press the **OK** button.
- 2 Press the (▲ / ▼) arrow buttons to select **OSD**, **Menu**, **Audio**, or **Subtitle**, and then press the **OK** button.
- 3 Use the (▲ / ▼) arrow buttons to select the preferred language, and then press the **OK** button to confirm.
- 4 Press the (◀) arrow button to return to the previous menu.

### OSD

This option enables you to select the on-screen menu language.

### Menu

This option lets you to select the disc menu language.

---

**NOTE** Not all languages are available on all discs.  
Most discs only have one menu language.

---

### Audio

From this option, you can choose the audio language of your preference.

---

**NOTE** Not all languages are available on all discs.  
Some discs do not let you select the audio language using your player's menu. Instead, you have to select the audio language from the disc setup menu (the menu that appears after you insert the disc).

---

### Subtitle

You can customize your preferred subtitle language in this option.

---

**NOTE** Not all languages are available on all discs.  
Some discs do not let you select the subtitle language using your player's menu. Instead, you have to select the subtitle language from the disc setup menu (the menu that appears after you insert the disc).  
You can also select the subtitle language from the subtitle menu in the on-screen menu.

---

## Security

- 1 In the main **Settings** menu, press the (▲ / ▼) arrow buttons to select **Security**, and then press the **OK** button.
- 2 Press the (▲ / ▼) arrow buttons to select **Password**, **Country Code** or **Parental Control**, and then press the **OK** button.
- 3 Enter your password by pressing number buttons. The default password is 0000.
- 4 Press the (◀) arrow button to return to the previous menu.

### Password

A new password can be set to replace the default password.

- 1 Enter the current password (a 4-digit number).  
The **New password** screen appears.
- 2 Enter a 4-digit number for the new password, and then enter it again to confirm.  
If you forget the password, you can erase your current password by pressing number button **0** on the remote control four times, then press **OK** button to confirm the setting. PASSWORD: 0000

### Country Code

Enter the password (a 4-digit number) for selecting the country code (United States or Canada).

### Parental control

- 1 Enter a 4-digit number for the parental control.
- 2 Press the (▲/▼) arrow buttons to select the rating level you want to block, and then press **OK**.

The selected rating and all higher ratings will be blocked. You can select:

- ❖ Off
  - ❖ **1 [Kid Safe]** — Suitable for all children.
  - ❖ **2 [G]** — General audiences.
  - ❖ **3 [PG]** — Parental guidance suggested.
  - ❖ **4 [PG-13]** — Not suitable for anyone under 13.
  - ❖ **5 [PG-R]** — Parental guidance recommended.
  - ❖ **6 [R]** — Not suitable for anyone under 17 unless supervised by a parent or adult guardian.
  - ❖ **7 [NC-17]** — Not suitable for anyone under 17.
  - ❖ **8 [Adult]** — All Blu-ray™ Discs and DVDs can be played.
- 3 Press the (◀) arrow button to go to the previous menu.

## Using the connected applications

### Watching movies with CinemaNow®

This Blu-ray Disc™/DVD player enables you to use the following services provided by CinemaNow®.

- 1 In the **Home** menu, press the (▲/▼) arrow buttons to select **Connected**.
- 2 Press the (▶) arrow button, and then press the (▲/▼) arrow buttons to select **Video**.
- 3 Use the (▲/▼/◀/▶) arrow buttons to select **CinemaNow**, and then press the **OK** button to enter the CinemaNow® main menu.
  - ❖ **Movies**: Display movies
  - ❖ **TV Shows**: Display TV Shows.
  - ❖ **Find**: Search for a desired movie or TV show by entering it manually.
  - ❖ **My Library**: Display a title that you bought or rented.
  - ❖ **My Favorites** : Display a title that has been added to My Favorites.
  - ❖ **Configure** : Activate or deactivate the Blu-ray Disc™ Player.
  - ❖ **Help** : Get customer service contact information and check the current software version.
- 4 If you don't have a CinemaNow® account yet, visit [www.cinemanow.com/bbactivate](http://www.cinemanow.com/bbactivate) to create your account.
- 5 Use the (▲/▼/◀/▶) to select the **Settings**, then press **OK**.
- 6 Press the **Activate**.
- 7 Use the number buttons on the remote control to enter the activation code that is created by the web site, then use (▼) to highlight **Activate**, and press **OK** to confirm.  
When the Blu-ray Disc™ Player is activated, you will move to the Home page.
- 8 Press the (▲/▼) to select the **Movies** or **TV Shows**, then press **OK**.
- 9 Press the (▲/▼/◀/▶) to select the desired title, then press **OK**.
- 10 Press the (▲/▼) to select the **Rent** or **Buy**, then press **OK**.
- 11 Press the (◀/▶) to select the **Submit Order**, then press **OK**. If you want to play any of the titles that your bought, simply click **Play Now**.
- 12 Press the (◀) to go to the previous menu.

## Watching movies with Netflix®

To use Netflix® service, connect this player to your network, and create the network settings if they are not yet finished.

### Launching Netflix® movie

- 1 In the **Home** menu, press the (▲/▼) arrow buttons to select **Connected**.
- 2 Press the (▶) arrow button, and then press the (▲/▼) arrow buttons to select **Video**.
- 3 Use the (▲/▼/◀/▶) arrow buttons to select **Netflix**, and then press the **OK** button to enter the Netflix® menu.

### Creating Netflix® account

If you are not a Netflix® member:

Select **no**. Read the instructions displayed on the TV screen, and visit <http://www.netflix.com/toshiba> from your PC. Sign up to create your account, then select “I’m now a member”.

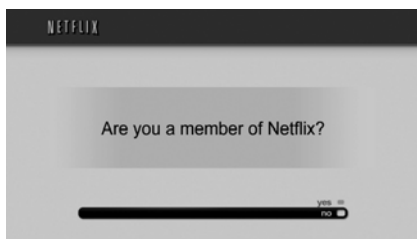

(Sample Illustration) Netflix® member - no

- 4 If you are a Netflix® member, select **yes**.
- 5 Enter a valid email address and password.

### Preparing Instant Queue

To play streaming video via Netflix® service, Netflix® player needs to be activated. Read the instructions displayed on the TV screen. Sign in to your Netflix® account with your email address and password. Now you can view Netflix® streaming video. After having activated Netflix® player and prepared Instant Queue, movies and TV episodes in your Instant Queue appear on the TV screen. Select your desired one using the remote control of the player. You can control Netflix® streaming video with the following keys of the remote control of this player:

Logos:	Playable discs:
▶	Starts playing movie. Pauses playback while in PLAY mode.
■	Stops playing and return to a list of movie titles.
	Pauses movie playback. Starts playing while in PAUSE mode.
▶	Pauses playing and opens a list of scenes. Pressing further proceeds to the next scene.
◀	Pauses playing and opens a list of scenes. Pressing further proceeds to the previous scene.
▲	Stops playing and returns to a list of movie titles.
▶▶	Pauses playing and opens a list of scenes. Fast forward play starts.



---

Logos:	Playable discs:
◀◀	Pauses playing and opens a list of scenes. Fast reverse play starts.
HOME Menu	Stops playing and returns to the Home Menu.
OK	Pauses playing of Track play screen while in PLAY mode. Starts playing the movie in case of during Track play screen.

---

**NOTE** Resolution of video streamed from Netflix® varies depending on communication speed or bitrate of each content, etc.

---

## Watching movies with YouTube®

- 1 In the **Home** menu, press the (▲/▼) arrow buttons to select **Connected**.
- 2 Press the (▶) arrow button, and then press the (▲/▼) arrow buttons to select **Video**.
- 3 Use the (▲/▼/◀/▶) arrow buttons to select **YouTube**, and then press the **OK** button to confirm.
- 4 Please enjoy any contents.

## Browsing photos with Picasa™

### Signing in with your account

To display photos in your web album on the screen, you need to sign in with your Picasa™ account.

- 1 In the **Home** menu, press the (▲/▼) arrow buttons to select **Connected**.
- 2 Press the (▶) arrow button, and then press the (▲/▼) arrow buttons to select **Photo**.
- 3 Press the (▶) arrow button to select **Picasa**, and then press the **OK** button to confirm.
- 4 Enter your user name using the virtual keyboard, and press the **OK** button while [OK] is selected on the screen.
- 5 Enter the password using the virtual keyboard, and press the **OK** button while [OK] is selected on the screen.

Your web album is displayed on the screen.

### Creating a new Picasa™ account on your PC

Visit <http://picasa.google.com/> to create a new account.

---

## Troubleshooting & Maintenance

---

Problem:	Solution:
No power	Check if the AC cord is properly connected. Unplug the AC cord once, and wait for approximately 5-10 seconds and then plug it in again.
No sound or picture	Check if the connected TV is turned on. Check if the connections are made securely and correctly. Check whether the connected TV or other device supports HDCP. (This unit will not output a video signal unless the other device supports HDCP.) Check whether the output format of this unit (HDMI® FORMAT) matches the supported input format of other connected device.
Distorted picture	Sometimes a small amount of picture distortion may appear. This is not a malfunction. Connect this unit directly to the TV.
Completely distorted picture or black /white picture with Blu-ray Disc™/DVD	Make sure the disc is compatible with this unit.
No sound or distorted sound	Adjust the volume. Check if speakers are connected correctly. Check the HDMI® connections. Check the settings in the Audio menu.
Picture freezes momentarily during playback	Check the disc for fingerprints/scratches and clean with a soft cloth wiping from center to edge. Clean the disc.
Disc cannot be played back	Clean the disc. Ensure the disc label is facing up. Check if the disc is defective by trying another disc. Cancel the ratings control or change the control level. Insert a correct disc that can be played back on this unit.
No return to start-up screen when disc is removed	Reset this unit by turning it off, then on again.
The unit does not respond to the remote control	Aim the remote control directly at infrared sensor window on the front panel. Reduce the distance to infrared sensor window. Replace the batteries in the remote control. Re-insert the batteries with their polarities (+ / - signs) as indicated.
Buttons do not work or the unit stops responding	To completely reset the unit, unplug the AC cord from the AC outlet for approximately 5-10 seconds.
The unit does not respond to some operating commands during playback	Operations may not be permitted by the disc. Refer to the instructions of the disc.
The unit cannot read Blu-ray Disc™/DVD/CD	Dew condensation may form inside the unit. Do not use this unit for at least a few hours until its inside gets dry. Wipe the dirt off the disc or replace the disc.

---

Problem:	Solution:
Angle does not switch	The angle cannot be switched for Blu-ray Disc™/DVD which do not contain multiple angles. In some cases multiple angles are only recorded for specific scenes.
Playback does not start when the title is selected	Check the settings in the Parental menu.
The password for rating level has been forgotten	If you forget your password, you need to go to the Security setup menu to reset and input a new password. For more information, see “Security” on page 38).
Cannot connect to the network	Check that the LAN cable connection is properly made. Turn on the modem or broadband router. Check that the broadband router and/or modem is correctly connected. Check the Network Connection Setting.
Cannot connect to the network while my PC is connected to the network	Check the content of your Internet service contract to see if your Internet service provider prevents multiple terminals connecting at the same time.
Cannot use the BD-Live™ function	Use a USB flash drive with enough space.

**NOTE** Some functions are not available in specific modes, but this is not a malfunction. Read the description in this manual for details on correct operations.  
Some functions are prohibited on some discs.

## Maintenance

### Servicing

Please refer to relevant topics in “Troubleshooting & Maintenance” on page 41 before returning the product.

If this unit becomes inoperative, do not try to correct the problem by yourself. There are no user-serviceable parts inside. Turn off, unplug the power plug, and please call our helpline to locate an Authorized Service Center.

### Cleaning the cabinet

Never use a solvent, thinner, benzene or alcohol to clean the unit. Do not spray insecticide liquid near the unit. Such chemicals may discolor the surface or damage the unit.

### Cleaning discs

When a disc becomes dirty, clean it with a cleaning cloth. Wipe the disc from the center to out. Do not wipe in a circular motion.

Do not use solvents such as benzene, thinner, commercially available cleaners, detergent, abrasive cleaning agents or antistatic spray intended for analog records.

### Cleaning the disc lens

If this unit still does not perform properly although you refer to the relevant sections and to “Troubleshooting” in this manual, the laser optical pickup unit may be dirty. Consult your dealer or an Authorized Service Center for inspection and cleaning of the laser optical pickup unit.

### Disc handling

Handle the discs so that fingerprints and dust do not adhere to the surfaces of the discs.

Always store the disc in its protective case when it is not used.

Note that discs with special shapes (heart-shaped discs, octagonal discs, etc.) cannot be played back on this unit. Do not attempt to playback such discs, as they may damage the unit.

**IR signal check**

If the remote control is not working properly, you can use a digital camera (including a cellular phone with built-in camera) to see if it is sending out an infrared signal.

**Glossary****Analog Audio**

An electrical signal that directly represents sound. Compare this to digital audio which can be an electrical signal, but is an indirect representation of sound.

**Aspect Ratio**

The width of a TV screen relative to its height. Conventional TVs are 4:3 (in other words, the TV screen is almost square); widescreen models are 16:9 (the TV screen is almost twice as wide as it is high).

**AVCHD™**

AVCHD™ is a new format for high definition video camcorders which can record and play high-resolution HD images.

**BD-Java™**

With some Blu-ray Disc™ which support Java™ applications, you can enjoy the interactive functions such as games or interactive menus.

**BD-Live™**

BD-Live™ is a BD-video (BD-ROM version 2 Profile 2.0/Profile 1.1) which contains new functions (e.g. Internet connection), in addition to the BONUSVIEW™ function.

**Blu-ray Disc™ (BD)**

Blu-ray Disc™ is a next generation optical video disc which is capable of storing much more data than a conventional DVD is. The large capacity makes it possible to benefit from the features such as high-definition videos, multichannel surround sounds, interactive menus and so on.

**Chapter**

Just as a book is split up into several chapters, a title on a BD-video or DVD-video is usually divided into chapters.

**Component Video Output**

Each signal of luminance (Y) and component (PB/CB, PR/CR) is independent to output so that you can experience picture Color as it is. Also, due to compatibility with progressive video (525p/480p), you can experience higher-density picture than that in interlace (525i/480i).

**Digital Audio**

An indirect representation of sound by numbers. During recording, the sound is measured at discrete intervals (44,100 times a second for CD audio) by an analog-to-digital converter, generating a stream of numbers. On playback, a digital-to-analog converter generates an analog signal based on these numbers.

**DNS Server**

A server which translates Internet domain names into IP addresses.

**Dolby® Digital**

The system to compress digital sound developed by Dolby® Laboratories. It offers you sound of stereo (2ch) or multi-channel audio.

**Dolby® Digital Plus**

Dolby® Digital Plus is the next generation digital audio compression technology developed as an extension to Dolby® Digital. Blu-ray Disc™ supports 7.1 multi-channel surround sound output.

**Dolby® TrueHD**

Dolby® TrueHD is a lossless coding technology developed for next generation optical discs. Blu-ray Disc™ supports 7.1 multi-channel surround sound output.

**DTS®**

DTS® is a multi-channel surround sound system. By connecting to DTS® decoder, you can enjoy movie dynamic and realistic sound like movie theater. DTS® surround sound technologies were developed by DTS®, Inc.

**DTS-HD®**

DTS-HD® is a lossless coding technology developed as an extension of the original DTS® Coherent Acoustics format. Blu-ray Disc™ supports 7.1 multi-channel surround sound output.

**Gateway**

IP Address of the electronic devices (such as router) which provide Internet access.

**HDMI® (High-Definition Multimedia Interface)**

A digital interface between audio and video source. It can transmit component video, audio, and control signal with one cable connection.

**Hub**

A device used for connecting multiple devices to the network.

**IP Address**

A set of numbers which are assigned to devices participating in a computer network.

**JPEG (Joint Photographic Experts Group)**

JPEG is a method of compressing still picture files. You can copy JPEG files on BD-RE/-R, DVD-RW/-R or CDRW/-R from a computer and play back the files in this unit.

**LAN (Local Area Network)**

A group of computer networks covering a small area like a company, school or home.

**Local Storage**

A storage area of sub contents for playing virtual packages on BD-video.

**MP3 (MPEG audio layer 3)**

MP3 is a method of compressing files. You can copy MP3 files on BD-RE/-R, DVD-RW/-R or CD-RW/-R from the computer and play back the files on this unit.

**PCM (Pulse Code Modulation)**

The most common system of encoding digital audio, found on CD and DAT. Excellent quality that requires a lot of data compared to formats such as Dolby® Digital and MPEG audio. For compatibility with digital audio recorders (CD, MD and DAT) and AV amplifiers with digital inputs, this unit can convert Dolby® Digital, DTS®, and MPEG audio to PCM.

**Proxy Server**

Proxy server is a server which acts as an intermediary between a workstation user and the Internet to ensure security.

**Region Code**

Regions associate discs and players with particular areas of the world. This unit will only play back discs that have compatible region codes. You can find the region code of your unit by looking on the rear panel. Some discs are compatible with more than one region (or all regions).

**Router**

A networking device which distinguishes the IP address assigned to each device and routing and forwarding information in the computer network.

**Sampling Frequency**

The rate which sound is measured by a specified interval to turn into digital audio data. The numbers of sampling in one second defines as sampling frequency. The higher the rate, the better the sound quality.

**Subnet Mask**

A mask which is used to determine what subnet an IP address belongs to.

**Title**

A collection of chapters on BD-video or DVD-video.

**Track**

Audio CD use tracks to divide up the content of a disc. The BD-video or DVD-video equivalent is called a chapter. See also “Chapter”.

**Virtual Package**

The function which copies data to other media (local storage) from the Internet and play the secondary video, secondary audio and the subtitle at the same time. The method of the playback varies depending on discs.

**Windows Media™ Audio**

Windows Media™ Audio is the audio compressing technology developed by Microsoft®. You can copy Windows Media™ Audio files on BD-RE/-R, DVD-RW/-R or CD-RW/-R from a computer and play them back on this unit.

**x.v.Color®**

“x.v.Color®” is a promotion name given to the products that have the capability to realize a wide color space based on the xvYCC specifications and is a trademark of Sony Corporation.

**Specifications**

General:	
Signal system	NTSC color
Power requirements	120V AC, 60Hz
Power consumption	12W
Dimensions (width x height x depth)	360 x 36 x 186mm
Weight	1.0 kg
Operating temperature	41°F (5°C) to 95°F (35°C)
Operating humidity	Less than 80% (no condensation)
HDMI® output HDMI® jack x 1	Video: 480i, 480p, 720p 1080i, 1080p, 1080p/24F / Audio
Audio output (Coaxial digital) RCA jack x 1	0.5Vp-p (75Ω)
USB terminal x 1	5V $\overline{\text{---}}$ 500mA
LAN terminal	100BASE-T

**NOTE**

The specifications and design of this product are subject to change without notice.

**Disclaimer**

1080p capable display required for viewing in 1080p. Viewing HD content and up-converting DVD content may require an HDCP capable input on your display device. While up-converting DVD video content may result in a picture that appears to be near HD quality, results may vary depending on content, display and settings. Feature performance may vary and may also require an always-on broadband Internet connection. Firmware update and additional bandwidth may be required. BD-Live™ requires connection of a USB flash drive of at least 1 GB (sold separately) to USB port. Performance of interactive features may vary due to disc design or content, and may also require an always-on broadband Internet connection. Firmware update may be required for some interactive features. Some features may require additional bandwidth. Third party Internet services are not provided by Toshiba, may change or be discontinued at any time and may be

subject to third party restrictions. Toshiba makes no representations or warranties about these services, which may require the creation of a user account through a computer with Internet access. Third party Internet service users may incur one-time and/or recurring charges. For Dolby® TrueHD and DTS-HD® Master Audio | Essential™ playback, content encoded in Dolby® TrueHD and DTS-HD® Master Audio | Essential™ format required. Viewing 1080p/24 fps output requires 1080p/24 fps encoded content and an HD display capable of accepting a 1080p/24Hz signal. Supported file types: JPEG, MP3, WMA, and AVCHD. Some recordable media, cards or files may not be supported. Product specifications, information and availability are all subject to change without notice.

## License Information

### END USER LICENSE AGREEMENT

This End User License Agreement (“EULA”) is a legal agreement between you and Toshiba Corporation (“Toshiba”) with regard to the copyrighted Software provided with this EULA. Use of any software and related documentation (“Software”) provided with a Toshiba Blu-ray Disc™/DVD player, or made available by downloading or otherwise to you by Toshiba in whatever form or media, will constitute your acceptance of these terms, unless separate terms are provided by the software supplier or Toshiba in the documentation accompanying the Toshiba Blu-ray Disc™/DVD player or otherwise, in which case certain additional or different terms may apply. If you do not agree with the terms of this EULA, do not use, download, install or copy the Software. If you wish to return a complete Blu-ray Disc™/DVD player system (hardware and software), contact the retailer where you purchased the Blu-ray Disc™/DVD player, and comply with the retailer’s standard return policies and procedures.

#### Article 1 Definition

The Software means all programs contained in the Toshiba Blu-ray Disc™/DVD player. The copyright of the Software belongs to Toshiba and/or its suppliers, including BSQUARE Corporation and/or its suppliers. The Software is protected by copyright laws, Universal Copyright Convention, and other laws and conventions related to intellectual property rights. The content of the Software and manual is subject to change by Toshiba without notice.

#### Article 2 License Grant and Use Conditions

Toshiba grants to you a personal, non-transferable and non-exclusive right to use the copy of the Software in accordance with this EULA. You may permanently transfer all of your rights under this EULA, provided you transfer complete Blu-ray Disc™/DVD player together with all of the Software, you retain no copies, and the recipient agrees to the terms of this EULA. If the Software is an upgrade version, any transfer must include all prior versions of the Software. For maintenance purposes, you may update the version of the Software only for the Blu-ray Disc™/DVD player that is owned by you.

#### Article 3 Prohibited Uses

Unless otherwise expressly provided in this EULA or the product manual accompanying the Toshiba Blu-ray Disc™/DVD player:

- 3.1. You may not copy the Software, in whole or in part, without express written permission by Toshiba and/or its suppliers.
- 3.2. You may not assign, resell, distribute or sublicense the Software or a copy of the Software.
- 3.3. You may not create, assign, resell, or sublicense secondary works of the Software without permission.
- 3.4. You may not modify, analyze, reverse engineer, decompile or disassemble any part of the Software.
- 3.5. You may not combine or incorporate the Software with or into any other application.
- 3.6. You may not print the Software.

#### Article 4 Disclaimer

4.1. THE HARDWARE PRODUCT LIMITED WARRANTY IS SET FORTH IN THE DOCUMENTATION ACCOMPANYING THE HARDWARE PRODUCT.

4.2. THE SOFTWARE IS PROVIDED “AS-IS” AND “AS AVAILABLE,” WITHOUT WARRANTIES OF ANY KIND.

ALL WARRANTIES AND CONDITIONS, EXPRESS OR IMPLIED, CONTRACTUAL OR STATUTORY, INCLUDING BUT NOT LIMITED TO, ANY IMPLIED WARRANTIES OF MERCHANTABILITY OR

FITNESS FOR A PARTICULAR PURPOSE, TITLE OR NON-INFRINGEMENT ARE HEREBY WAIVED BY YOU AND DISCLAIMED BY TOSHIBA. THIS EULA REPRESENTS THE SOLE AND EXCLUSIVE OBLIGATION OF TOSHIBA AND ITS SUPPLIERS WITH RESPECT TO THE SOFTWARE.

#### Article 5 Limitation of Liability

TO THE MAXIMUM EXTENT NOT PROHIBITED BY APPLICABLE LAW, IN NO EVENT SHALL TOSHIBA AND/OR ITS SUPPLIERS BE LIABLE FOR PERSONAL INJURY, OR ANY INCIDENTAL, SPECIAL, INDIRECT, PUNITIVE OR CONSEQUENTIAL DAMAGES WHATSOEVER, INCLUDING, WITHOUT LIMITATION, DAMAGES FOR LOSS OF PROFITS, LOSS OF DATA, BUSINESS INTERRUPTION, OR ANY OTHER COMMERCIAL DAMAGES OR LOSSES, ARISING OUT OF OR RELATED TO YOUR USE OR INABILITY TO USE THE SOFTWARE, HOWEVER CAUSED, REGARDLESS OF THE THEORY OF LIABILITY (CONTRACT, TORT, OR OTHERWISE) AND EVEN IF TOSHIBA AND/OR ITS SUPPLIERS HAS BEEN ADVISED OF THE POSSIBILITY OF SUCH DAMAGES. SOME JURISDICTIONS DO NOT ALLOW THE LIMITATION OF LIABILITY FOR PERSONAL INJURY, OR FOR INCIDENTAL OR CONSEQUENTIAL DAMAGES; THEREFORE, THE ABOVE LIMITATIONS MAY NOT APPLY TO YOU UNDER SUCH CIRCUMSTANCES. THE AGGREGATE LIABILITY OF TOSHIBA AND ITS SUPPLIERS IN CONNECTION WITH THE SOFTWARE, REGARDLESS OF THE FORM OF ANY LEGAL ACTION OR PROCEEDING, SHALL BE LIMITED TO DIRECT DAMAGES NOT TO EXCEED THE AMOUNT PAID FOR THE TOSHIBA BLU-RAY PLAYER.

#### Article 6 Export Control

Any export, directly or indirectly, of the Software in contravention of the United States Export Administration Regulations, or any other applicable law, regulation, or order, is prohibited.

#### Article 7 Termination of License

In the event that you fail to comply with any of the terms and conditions contained herein, Toshiba shall have the right to immediately terminate this Agreement without any notification to you. Upon termination of this Agreement, you shall cease all use of the Software and destroy all copies, in whole and/or in part.

#### Article 8 Governing Law

This EULA is governed by the laws of Japan, without references to the conflict of laws principles. Any and all disputes arising hereunder shall be resolved exclusively by the Tokyo District Court, Japan, and you hereby consent to the exclusive jurisdiction of such court.

#### Article 9 Severability

If any provision of this EULA shall be held to be invalid, illegal or unenforceable, the validity, legality and enforceability of the remaining provisions hereof shall not in any way be affected or impaired.

(C) 2001-2010 Toshiba Corporation

The Software contains Macromedia® [Flash®] [Flash Lite™] technology of Adobe Systems Incorporated.

Copyright© 1995-2007 Adobe Systems Incorporated. All rights reserved. Macromedia, Flash, Macromedia Flash, [and Macromedia Flash Lite] are trademarks or registered trademarks of Adobe Systems Incorporated in the United States and other countries.

License information on the software used in the TOSHIBA Blu-ray Disc™/DVD player

This document is statement purpose only. Not concerned with operation of this product.

The software pre-installed in the TOSHIBA Blu-ray Disc™/DVD player consists of multiple, independent software components. Each software component is copyrighted by TOSHIBA or a third party.

The TOSHIBA Blu-ray Disc™/DVD player uses software components that are distributed as freeware under a third-party end-user license agreement or copyright notice (hereinafter referred to as a "EULA"). Some EULAs require that the source code of the applicable component be disclosed as the condition for distributing the software component in executable format. You can check the software components subject to such EULA requirements on the following phone number:

Phone number: 888-592-0944

TOSHIBA provides a limited warranty for the TOSHIBA Blu-ray Disc™/DVD player you have purchased under conditions set forth by TOSHIBA.



However, some of the software components distributed under an EULA are made available for use by the user on the assumption that they are not copyrighted or warranted by TOSHIBA or any third party. These software components are licensed to the user free of charge and therefore not covered by any warranty within the scope of the applicable laws. These software components are not subject to any copyrights or other third-party rights and are provided in “as is” condition without any warranty, whether express or implied. “Warranty” here includes, but not limited to, an implied warranty for marketability or fitness for specific uses. All risks associated with the quality or performance of these software components are assumed by the user. TOSHIBA shall not be liable whatsoever for any cost of repair or correction or other incidental expense incurred in connection with a defect found in any of these software components. Unless specified under the applicable laws or in a written agreement, a party who changes or redistributes the software with consent from the copyright holders or based on the aforementioned licenses shall not be held liable whatsoever for any loss arising from the use of or inability to use such software components. The same applies even when the copyright holders or relevant third parties have been informed of the possibility of such loss. “Loss” here includes normal, special, incidental and indirect loss (including, but not limited to, the loss of data or its accuracy; loss incurred by the user or any third party; and interface incompatibility with other software). Please read each EULA for details on the use conditions and items that must be observed regarding these software components. The table below lists the software components preinstalled in the TOSHIBA Blu-ray Disc™/DVD player, which are subject to EULAs. The user should read the applicable EULAs carefully before using these software components. The EULAs are exhibited in their original text (English) as exactly written by the respective parties other than TOSHIBA.

The Open-Source Software included in the Blu-ray Disc™/DVD player is described in the table below. To view the Open-Source agreements, please type in <http://oss.bd.toshiba.com/version1> into your browser and click on the corresponding Open-Source Software License link provided. Additionally, the licenses can be viewed by typing in the URL addresses listed in the *License* column.

<i>OSS name</i>	<i>OSS version</i>	<i>OSS project URL</i>	<i>License</i>
<b>Linux kernel</b>	2.6.35	<a href="http://www.kernel.org">http://www.kernel.org</a>	<a href="http://oss.bd.toshiba.com/version1/GPLv2.pdf">http://oss.bd.toshiba.com/version1/GPLv2.pdf</a>
<b>gcc libgcc</b>	4.5.1	<a href="http://gcc.gnu.org/">http://gcc.gnu.org/</a>	<a href="http://oss.bd.toshiba.com/version1/GPLv3.pdf">http://oss.bd.toshiba.com/version1/GPLv3.pdf</a>
<b>gcc libstdc++</b>	4.5.1	<a href="http://gcc.gnu.org/">http://gcc.gnu.org/</a>	<a href="http://oss.bd.toshiba.com/version1/GPLv3.pdf">http://oss.bd.toshiba.com/version1/GPLv3.pdf</a>
<b>glibc</b>	2.12.1	<a href="http://www.gnu.org/software/libc/">http://www.gnu.org/software/libc/</a>	<a href="http://oss.bd.toshiba.com/version1/LGPLv2.1.pdf">http://oss.bd.toshiba.com/version1/LGPLv2.1.pdf</a>
<b>glibc (other licenses)</b>	2.12.1	<a href="http://www.gnu.org/software/libc/">http://www.gnu.org/software/libc/</a>	<a href="http://oss.bd.toshiba.com/version1/glibc_2.9.pdf">http://oss.bd.toshiba.com/version1/glibc_2.9.pdf</a>
<b>SquashFS</b>	3.4	<a href="http://squashfs.sourceforge.net/">http://squashfs.sourceforge.net/</a>	<a href="http://oss.bd.toshiba.com/version1/GPLv2.pdf">http://oss.bd.toshiba.com/version1/GPLv2.pdf</a>
<b>SquashFS</b>	4.1	<a href="http://squashfs.sourceforge.net/">http://squashfs.sourceforge.net/</a>	<a href="http://oss.bd.toshiba.com/version1/GPLv2.pdf">http://oss.bd.toshiba.com/version1/GPLv2.pdf</a>
<b>iputils</b>	s20101006	<a href="http://www.skbuff.net/iputils/">http://www.skbuff.net/iputils/</a>	<a href="http://oss.bd.toshiba.com/version1/GPLv2.pdf">http://oss.bd.toshiba.com/version1/GPLv2.pdf</a>
<b>udhcp</b>	0.9.8cvs20050303-3	<a href="http://udhcp.sourceforge.com/downloads/0.9.8cvs20050303-3/">http://udhcp.sourceforge.com/downloads/0.9.8cvs20050303-3/</a>	<a href="http://oss.bd.toshiba.com/version1/GPLv2.pdf">http://oss.bd.toshiba.com/version1/GPLv2.pdf</a>
<b>net-tools</b>	1.60	<a href="http://www.linuxfromscratch.org/blfs/view/6.3/basicnet/net-tools.html">http://www.linuxfromscratch.org/blfs/view/6.3/basicnet/net-tools.html</a>	<a href="http://oss.bd.toshiba.com/version1/GPLv2.pdf">http://oss.bd.toshiba.com/version1/GPLv2.pdf</a>

<i>OSS name</i>	<i>OSS version</i>	<i>OSS project URL</i>	<i>License</i>
<b>sysvinit</b>	2.88dsf	<a href="http://savannah.nongnu.org/projects/sysvinit">http://savannah.nongnu.org/projects/sysvinit</a>	<a href="http://oss.bd.toshiba.com/version1/GPLv2.pdf">http://oss.bd.toshiba.com/version1/GPLv2.pdf</a>
<b>module-init-tools</b>	3.12	<a href="https://modules.wiki.kernel.org/index.php/Main_Page">https://modules.wiki.kernel.org/index.php/Main_Page</a>	<a href="http://oss.bd.toshiba.com/version1/GPLv2.pdf">http://oss.bd.toshiba.com/version1/GPLv2.pdf</a>
<b>util-linux-ng</b>	2.18	<a href="http://userweb.kernel.org/~kzak/util-linux-ng/">http://userweb.kernel.org/~kzak/util-linux-ng/</a>	<a href="http://oss.bd.toshiba.com/version1/GPLv2.pdf">http://oss.bd.toshiba.com/version1/GPLv2.pdf</a>
<b>procps (ps, top)</b>	3.2.8	<a href="http://procps.sourceforge.net/index.html">http://procps.sourceforge.net/index.html</a>	<a href="http://oss.bd.toshiba.com/version1/LGPLv2.1.pdf">http://oss.bd.toshiba.com/version1/LGPLv2.1.pdf</a>
<b>psmisc</b>	22.13	<a href="http://psmisc.sourceforge.net/">http://psmisc.sourceforge.net/</a>	<a href="http://oss.bd.toshiba.com/version1/GPLv2.pdf">http://oss.bd.toshiba.com/version1/GPLv2.pdf</a>
<b>coreutils</b>	6.9	<a href="http://www.gnu.org/software/coreutils/">http://www.gnu.org/software/coreutils/</a>	<a href="http://oss.bd.toshiba.com/version1/GPLv2.pdf">http://oss.bd.toshiba.com/version1/GPLv2.pdf</a>
<b>gawk</b>	3.1.5	<a href="http://www.gnu.org/software/gawk/">http://www.gnu.org/software/gawk/</a>	<a href="http://oss.bd.toshiba.com/version1/GPLv2.pdf">http://oss.bd.toshiba.com/version1/GPLv2.pdf</a>
<b>grep</b>	2.5.1a	<a href="http://www.gnu.org/software/grep/">http://www.gnu.org/software/grep/</a>	<a href="http://oss.bd.toshiba.com/version1/GPLv2.pdf">http://oss.bd.toshiba.com/version1/GPLv2.pdf</a>
<b>findutils</b>	4.2.31	<a href="http://www.gnu.org/software/findutils/">http://www.gnu.org/software/findutils/</a>	<a href="http://oss.bd.toshiba.com/version1/GPLv2.pdf">http://oss.bd.toshiba.com/version1/GPLv2.pdf</a>
<b>bash</b>	3.2.48	<a href="http://www.gnu.org/software/bash/">http://www.gnu.org/software/bash/</a>	<a href="http://oss.bd.toshiba.com/version1/GPLv2.pdf">http://oss.bd.toshiba.com/version1/GPLv2.pdf</a>
<b>tar</b>	1.17	<a href="http://www.gnu.org/software/tar/">http://www.gnu.org/software/tar/</a>	<a href="http://oss.bd.toshiba.com/version1/GPLv2.pdf">http://oss.bd.toshiba.com/version1/GPLv2.pdf</a>
<b>sed</b>	4.1.5	<a href="http://www.gnu.org/software/sed/">http://www.gnu.org/software/sed/</a>	<a href="http://oss.bd.toshiba.com/version1/GPLv2.pdf">http://oss.bd.toshiba.com/version1/GPLv2.pdf</a>
<b>gzip</b>	1.3.12	<a href="http://www.gnu.org/software/gzip/">http://www.gnu.org/software/gzip/</a>	<a href="http://oss.bd.toshiba.com/version1/GPLv2.pdf">http://oss.bd.toshiba.com/version1/GPLv2.pdf</a>
<b>inetutils</b>	1.4.2	<a href="http://www.gnu.org/software/inetutils/">http://www.gnu.org/software/inetutils/</a>	<a href="http://oss.bd.toshiba.com/version1/GPLv2.pdf">http://oss.bd.toshiba.com/version1/GPLv2.pdf</a>
<b>ncurses</b>	5.7	<a href="http://www.gnu.org/software/ncurses/">http://www.gnu.org/software/ncurses/</a>	<a href="http://oss.bd.toshiba.com/version1/ncurses.pdf">http://oss.bd.toshiba.com/version1/ncurses.pdf</a>
<b>gdb (gdbserver)</b>	6.6	<a href="http://www.gnu.org/software/gdb/">http://www.gnu.org/software/gdb/</a>	<a href="http://oss.bd.toshiba.com/version1/GPLv2.pdf">http://oss.bd.toshiba.com/version1/GPLv2.pdf</a>
<b>Das U-Boot</b>	2009.08	<a href="http://www.denx.de/wiki/U-Boot/WebHome">http://www.denx.de/wiki/U-Boot/WebHome</a>	<a href="http://oss.bd.toshiba.com/version1/GPLv2.pdf">http://oss.bd.toshiba.com/version1/GPLv2.pdf</a>
<b>International Components for Unicode</b>	3.2.0	<a href="http://www.icu-project.org/index.html">http://www.icu-project.org/index.html</a>	<a href="http://oss.bd.toshiba.com/version1/ICU.pdf">http://oss.bd.toshiba.com/version1/ICU.pdf</a>
<b>OpenSSL</b>	0.9.8n	<a href="http://www.openssl.org/">http://www.openssl.org/</a>	<a href="http://oss.bd.toshiba.com/version1/OpenSSL.pdf">http://oss.bd.toshiba.com/version1/OpenSSL.pdf</a>
<b>zlib</b>	1.2.3	<a href="http://www.zlib.net/">http://www.zlib.net/</a>	<a href="http://oss.bd.toshiba.com/version1/zlib.pdf">http://oss.bd.toshiba.com/version1/zlib.pdf</a>

<i>OSS name</i>	<i>OSS version</i>	<i>OSS project URL</i>	<i>License</i>
<b>FreeType</b>	2.3.9	<a href="http://www.freetype.org/">http://www.freetype.org/</a>	<a href="http://oss.bd.toshiba.com/version1/FreeType.txt">http://oss.bd.toshiba.com/version1/FreeType.txt</a>
<b>Expat</b>	2.0.1	<a href="http://expat.sourceforge.net/">http://expat.sourceforge.net/</a>	<a href="http://oss.bd.toshiba.com/version1/Expat.pdf">http://oss.bd.toshiba.com/version1/Expat.pdf</a>
<b>libcurl</b>	7.19.6	<a href="http://curl.haxx.se/">http://curl.haxx.se/</a>	<a href="http://oss.bd.toshiba.com/version1/cURL.pdf">http://oss.bd.toshiba.com/version1/cURL.pdf</a>
<b>libjpeg</b>	jpeg-7	<a href="http://www.ijg.org/">http://www.ijg.org/</a>	<a href="http://oss.bd.toshiba.com/version1/libjpeg.pdf">http://oss.bd.toshiba.com/version1/libjpeg.pdf</a>
<b>c-ares</b>	1.4.0	<a href="http://c-ares.haxx.se/">http://c-ares.haxx.se/</a>	<a href="http://oss.bd.toshiba.com/version1/c-ares.pdf">http://oss.bd.toshiba.com/version1/c-ares.pdf</a>
<b>mtt-utils</b>	1	<a href="http://www.linux-mtd.infradead.org/index.html">http://www.linux-mtd.infradead.org/index.html</a>	<a href="http://oss.bd.toshiba.com/version1/GPLv2.pdf">http://oss.bd.toshiba.com/version1/GPLv2.pdf</a>
<b>WPA Supplicant</b>	0.5.10	<a href="http://hostap.epitest.fi/wpa_supplicant/">http://hostap.epitest.fi/wpa_supplicant/</a>	<a href="http://oss.bd.toshiba.com/version1/WPA_Supplicant.pdf">http://oss.bd.toshiba.com/version1/WPA_Supplicant.pdf</a>
<b>WPA Supplicant (WPS)</b>	0.6.7	<a href="http://hostap.epitest.fi/wpa_supplicant/">http://hostap.epitest.fi/wpa_supplicant/</a>	<a href="http://oss.bd.toshiba.com/version1/WPA_Supplicant.pdf">http://oss.bd.toshiba.com/version1/WPA_Supplicant.pdf</a>
<b>Wireless Tools</b>	29	<a href="http://www.hpl.hp.com/personal/Jean_Tourrilhes/Linux/Tools.html">http://www.hpl.hp.com/personal/Jean_Tourrilhes/Linux/Tools.html</a>	<a href="http://oss.bd.toshiba.com/version1/GPLv2.pdf">http://oss.bd.toshiba.com/version1/GPLv2.pdf</a>
<b>DirectFB</b>	1.2.7	<a href="http://www.directfb.org">http://www.directfb.org</a>	<a href="http://oss.bd.toshiba.com/version1/LGPLv2.1.pdf">http://oss.bd.toshiba.com/version1/LGPLv2.1.pdf</a>
<b>Fusion</b>	8.2.0	<a href="http://www.directfb.org">http://www.directfb.org</a>	<a href="http://oss.bd.toshiba.com/version1/GPLv2.pdf">http://oss.bd.toshiba.com/version1/GPLv2.pdf</a>
<b>SaWMan</b>	1.4.0	<a href="http://www.directfb.org">http://www.directfb.org</a>	<a href="http://oss.bd.toshiba.com/version1/LGPLv2.1.pdf">http://oss.bd.toshiba.com/version1/LGPLv2.1.pdf</a>
<b>libpng</b>	1.2.35	<a href="http://www.libpng.org/pub/png/libpng.html">http://www.libpng.org/pub/png/libpng.html</a>	<a href="http://oss.bd.toshiba.com/version1/libpng.txt">http://oss.bd.toshiba.com/version1/libpng.txt</a>
<b>Qt</b>	4.6.2	<a href="http://qt.nokia.com/products">http://qt.nokia.com/products</a>	<a href="http://oss.bd.toshiba.com/version1/LGPLv2.1.pdf">http://oss.bd.toshiba.com/version1/LGPLv2.1.pdf</a>
<b>libxml2</b>	2.7.6	<a href="http://xmlsoft.org/">http://xmlsoft.org/</a>	<a href="http://oss.bd.toshiba.com/version1/libxml.pdf">http://oss.bd.toshiba.com/version1/libxml.pdf</a>
<b>xmlrpc-c</b>	1.06.38	<a href="http://xmlrpc-c.sourceforge.net/">http://xmlrpc-c.sourceforge.net/</a>	<a href="http://oss.bd.toshiba.com/version1/XMLrpc.pdf">http://oss.bd.toshiba.com/version1/XMLrpc.pdf</a>
<b>tinyxml</b>	2.5.3	<a href="http://sourceforge.net/projects/tinyxml/">http://sourceforge.net/projects/tinyxml/</a>	<a href="http://oss.bd.toshiba.com/version1/tinyxml.pdf">http://oss.bd.toshiba.com/version1/tinyxml.pdf</a>
<b>gSOAP</b>	2.7.12	<a href="http://www.cs.fsu.edu/~englen/soap.html">http://www.cs.fsu.edu/~englen/soap.html</a>	<a href="http://oss.bd.toshiba.com/version1/gSOAP.pdf">http://oss.bd.toshiba.com/version1/gSOAP.pdf</a>
<b>SQLite</b>	3.6.22	<a href="http://www.sqlite.org/">http://www.sqlite.org/</a>	<a href="http://oss.bd.toshiba.com/version1/SQLite.pdf">http://oss.bd.toshiba.com/version1/SQLite.pdf</a>
<b>David M. Gay's dtoa and strtod</b>		<a href="http://netlib2.cs.utk.edu/fp/dtoa.c">http://netlib2.cs.utk.edu/fp/dtoa.c</a>	<a href="http://oss.bd.toshiba.com/version1/DMG.pdf">http://oss.bd.toshiba.com/version1/DMG.pdf</a>

<i>OSS name</i>	<i>OSS version</i>	<i>OSS project URL</i>	<i>License</i>
<b>Bison generated parser</b>	2.3	<a href="http://www.gnu.org/software/bison/">http://www.gnu.org/software/bison/</a>	<a href="http://oss.bd.toshiba.com/version1/bison.pdf">http://oss.bd.toshiba.com/version1/bison.pdf</a>
<b>Doug Lea's malloc</b>		<a href="ftp://g.oswego.edu/pub/misc/malloc.c">ftp://g.oswego.edu/pub/misc/malloc.c</a> <a href="http://gee.cs.oswego.edu/dl/html/malloc.html">http://gee.cs.oswego.edu/dl/html/malloc.html</a>	<a href="http://oss.bd.toshiba.com/version1/dmalloc.pdf">http://oss.bd.toshiba.com/version1/dmalloc.pdf</a>
<b>EMX sprintf and scanf</b>			<a href="http://oss.bd.toshiba.com/version1/EMX.pdf">http://oss.bd.toshiba.com/version1/EMX.pdf</a>
<b>JSON_Parser</b>	1.0	<a href="http://www.json.org/">http://www.json.org/</a>	<a href="http://oss.bd.toshiba.com/version1/JSON.pdf">http://oss.bd.toshiba.com/version1/JSON.pdf</a>
<b>Lua interpreter</b>	5.1.3	<a href="http://www.lua.org/license.html#5">http://www.lua.org/license.html#5</a>	<a href="http://oss.bd.toshiba.com/version1/Lua.pdf">http://oss.bd.toshiba.com/version1/Lua.pdf</a>
<b>zziplib</b>	0.13.58	<a href="http://zziplib.sourceforge.net/">http://zziplib.sourceforge.net/</a>	<a href="http://oss.bd.toshiba.com/version1/Zziplib.pdf">http://oss.bd.toshiba.com/version1/Zziplib.pdf</a>
<b>libavformat</b>	52.31.0	<a href="http://ffmpeg.org/">http://ffmpeg.org/</a>	<a href="http://oss.bd.toshiba.com/version1/LGPLv2.1.pdf">http://oss.bd.toshiba.com/version1/LGPLv2.1.pdf</a>
<b>libavutil</b>	49.15.0	<a href="http://ffmpeg.org/">http://ffmpeg.org/</a>	<a href="http://oss.bd.toshiba.com/version1/LGPLv2.1.pdf">http://oss.bd.toshiba.com/version1/LGPLv2.1.pdf</a>
<b>libavcodec</b>	52.20.0	<a href="http://ffmpeg.org/">http://ffmpeg.org/</a>	<a href="http://oss.bd.toshiba.com/version1/LGPLv2.1.pdf">http://oss.bd.toshiba.com/version1/LGPLv2.1.pdf</a>

### **bison\_parser**

The distribution terms for Bison-generated parsers permit using the parsers in nonfree programs. Before Bison version 2.2, these extra permissions applied only when Bison was generating LALR(1) parsers in C. And before Bison version 1.24, Bison-generated parsers could be used only in programs that were free software.

The other GNU programming tools, such as the GNU C compiler, have never had such a requirement. They could always be used for nonfree software. The reason Bison was different was not due to a special policy decision; it resulted from applying the usual General Public License to all of the Bison source code.

The output of the Bison utility the Bison parser file contains a verbatim copy of a sizable piece of Bison, which is the code for the parser's implementation. (The actions from your grammar are inserted into this implementation at one point, but most of the rest of the implementation is not changed.) When we applied the GPL terms to the skeleton code for the parser's implementation, the effect was to restrict the use of Bison output to free software. We didn't change the terms because of sympathy for people who want to make software proprietary. Software should be free. But we concluded that limiting Bison's use to free software was doing little to encourage people to make other software free. So we decided to make the practical conditions for using Bison match the practical conditions for using the other GNU tools.

This exception applies when Bison is generating code for a parser. You can tell whether the exception applies to a Bison output file by inspecting the file for text beginning with "As a special exception...."

The text spells out the exact terms of the exception.

### **c-ares**

Copyright 1998 by the Massachusetts Institute of Technology.

Permission to use, copy, modify, and distribute this software and its documentation for any purpose and without fee is hereby granted, provided that the above copyright notice appear in all copies and that both that copyright notice and this permission notice appear in supporting documentation, and that the name of M.I.T. not be used in advertising or publicity pertaining to distribution of the software without specific, written prior permission. M.I.T. makes no representations about the suitability of this software for any purpose. It is provided "as is" without express or implied warranty.

## **cURL**

### **COPYRIGHT AND PERMISSION NOTICE**

Copyright (c) 1996 - 2011, Daniel Stenberg, <daniel@haxx.se>.

All rights reserved.

Permission to use, copy, modify, and distribute this software for any purpose with or without fee is hereby granted, provided that the above copyright notice and this permission notice appear in all copies.

THE SOFTWARE IS PROVIDED "AS IS", WITHOUT WARRANTY OF ANY KIND, EXPRESS OR IMPLIED, INCLUDING BUT NOT LIMITED TO THE WARRANTIES OF MERCHANTABILITY, FITNESS FOR A PARTICULAR PURPOSE AND NONINFRINGEMENT OF THIRD PARTY RIGHTS. IN NO EVENT SHALL THE AUTHORS OR COPYRIGHT HOLDERS BE LIABLE FOR ANY CLAIM, DAMAGES OR OTHER LIABILITY, WHETHER IN AN ACTION OF CONTRACT, TORT OR OTHERWISE, ARISING FROM, OUT OF OR IN CONNECTION WITH THE SOFTWARE OR THE USE OR OTHER DEALINGS IN THE SOFTWARE.

Except as contained in this notice, the name of a copyright holder shall not be used in advertising or otherwise to promote the sale, use or other dealings in this Software without prior written authorization of the copyright holder.

## **dmalloc**

This is a version (aka dmalloc) of malloc/free/realloc written by Doug Lea and released to the public domain, as explained at <http://creativecommons.org/licenses/publicdomain>. Send questions, comments, complaints, performance data, etc to dl@cs.oswego.edu

## **DMG's dtoa and strtod**

The author of this software is David M. Gay.

Copyright (c) 1991, 2000, 2001 by Lucent Technologies.

Permission to use, copy, modify, and distribute this software for any purpose without fee is hereby granted, provided that this entire notice is included in all copies of any software which is or includes a copy or modification of this software and in all copies of the supporting documentation for such software.

THIS SOFTWARE IS BEING PROVIDED "AS IS", WITHOUT ANY EXPRESS OR IMPLIED WARRANTY. IN PARTICULAR, NEITHER THE AUTHOR NOR LUCENT MAKES ANY REPRESENTATION OR WARRANTY OF ANY KIND CONCERNING THE MERCHANTABILITY OF THIS SOFTWARE OR ITS FITNESS FOR ANY PARTICULAR PURPOSE.

## **EMX\_sprintf\_sscanf**

The emx libraries are not distributed under the GPL. Linking an application with the emx libraries does not cause the executable to be covered by the GNU General Public License. You are allowed to change and copy the emx library sources if you keep the copyright message intact. If you improve the emx libraries, please send your enhancements to the emx author (you should copyright your enhancements similar to the existing emx libraries).

## Expat

Copyright (c) 1998, 1999, 2000 Thai Open Source Software Center Ltd

Permission is hereby granted, free of charge, to any person obtaining a copy of this software and associated documentation files (the "Software"), to deal in the Software without restriction, including without limitation the rights to use, copy, modify, merge, publish, distribute, sublicense, and/or sell copies of the Software, and to permit persons to whom the Software is furnished to do so, subject to the following conditions: The above copyright notice and this permission notice shall be included in all copies or substantial portions of the Software. THE SOFTWARE IS PROVIDED "AS IS", WITHOUT WARRANTY OF ANY KIND, EXPRESS OR IMPLIED, INCLUDING BUT NOT LIMITED TO THE WARRANTIES OF MERCHANTABILITY, FITNESS FOR A PARTICULAR PURPOSE AND NONINFRINGEMENT. IN NO EVENT SHALL THE AUTHORS OR COPYRIGHT HOLDERS BE LIABLE FOR ANY CLAIM, DAMAGES OR OTHER LIABILITY, WHETHER IN AN ACTION OF CONTRACT, TORT OR OTHERWISE, ARISING FROM, OUT OF OR IN CONNECTION WITH THE SOFTWARE OR THE USE OR OTHER DEALINGS IN THE SOFTWARE.

## The FreeType Project LICENSE

2006-Jan-27

Copyright 1996-2002, 2006 by

David Turner, Robert Wilhelm, and Werner Lemberg

### Introduction

The FreeType Project is distributed in several archive packages; some of them may contain, in addition to the FreeType font engine, various tools and contributions which rely on, or relate to, the FreeType Project.

This license applies to all files found in such packages, and which do not fall under their own explicit license. The license affects thus the FreeType font engine, the test programs, documentation and makefiles, at the very least.

This license was inspired by the BSD, Artistic, and IJG (Independent JPEG Group) licenses, which all encourage inclusion and use of free software in commercial and freeware products alike. As a consequence, its main points are that:

- We don't promise that this software works. However, we will be interested in any kind of bug reports. ('as is' distribution)
- You can use this software for whatever you want, in parts or full form, without having to pay us. ('royalty-free' usage)
- You may not pretend that you wrote this software. If you use it, or only parts of it, in a program, you must acknowledge somewhere in your documentation that you have used the FreeType code. ('credits')

We specifically permit and encourage the inclusion of this software, with or without modifications, in commercial products. We disclaim all warranties covering The FreeType Project and assume no liability related to The FreeType Project.

Finally, many people asked us for a preferred form for a credit/disclaimer to use in compliance with this license. We thus encourage you to use the following text:

Portions of this software are copyright <year> The FreeType Project ([www.freetype.org](http://www.freetype.org)). All rights reserved.

Please replace <year> with the value from the FreeType version you actually use.

## Legal Terms

### 0. Definitions

Throughout this license, the terms 'package', 'FreeType Project', and 'FreeType archive' refer to the set of files originally distributed by the authors (David Turner, Robert Wilhelm, and Werner Lemberg) as the 'FreeType Project', be they named as alpha, beta or final release.

'You' refers to the licensee, or person using the project, where 'using' is a generic term including compiling the project's source code as well as linking it to form a 'program' or 'executable'. This program is referred to as 'a program using the FreeType engine'.

This license applies to all files distributed in the original FreeType Project, including all source code, binaries and documentation, unless otherwise stated in the file in its original, unmodified form as distributed in the original archive. If you are unsure whether or not a particular file is covered by this license, you must contact us to verify this.

The FreeType Project is copyright (C) 1996-2000 by David Turner, Robert Wilhelm, and Werner Lemberg. All rights reserved except as specified below.

#### 1. No Warranty

THE FREETYPE PROJECT IS PROVIDED 'AS IS' WITHOUT WARRANTY OF ANY KIND, EITHER EXPRESS OR IMPLIED, INCLUDING, BUT NOT LIMITED TO, WARRANTIES OF MERCHANTABILITY AND FITNESS FOR A PARTICULAR PURPOSE. IN NO EVENT WILL ANY OF THE AUTHORS OR COPYRIGHT HOLDERS BE LIABLE FOR ANY DAMAGES CAUSED BY THE USE OR THE INABILITY TO USE, OF THE FREETYPE PROJECT.

#### 2. Redistribution

This license grants a worldwide, royalty-free, perpetual and irrevocable right and license to use, execute, perform, compile, display, copy, create derivative works of, distribute and sublicense the FreeType Project (in both source and object code forms) and derivative works thereof for any purpose; and to authorize others to exercise some or all of the rights granted herein, subject to the following conditions:

- Redistribution of source code must retain this license file ('FTL.TXT') unaltered; any additions, deletions or changes to the original files must be clearly indicated in accompanying documentation. The copyright notices of the unaltered, original files must be preserved in all copies of source files.
- Redistribution in binary form must provide a disclaimer that states that the software is based in part of the work of the FreeType Team, in the distribution documentation. We also encourage you to put an URL to the FreeType web page in your documentation, though this isn't mandatory. These conditions apply to any software derived from or based on the FreeType Project, not just the unmodified files. If you use our work, you must acknowledge us. However, no fee need be paid to us.

#### 3. Advertising

Neither the FreeType authors and contributors nor you shall use the name of the other for commercial, advertising, or promotional purposes without specific prior written permission. We suggest, but do not require, that you use one or more of the following phrases to refer to this software in your documentation or advertising materials: 'FreeType Project', 'FreeType Engine', 'FreeType library', or 'FreeType Distribution'.

As you have not signed this license, you are not required to accept it. However, as the FreeType Project is copyrighted material, only this license, or another one contracted with the authors, grants you the right to use, distribute, and modify it. Therefore, by using, distributing, or modifying the FreeType Project, you indicate that you understand and accept all the terms of this license.

## Contacts

There are two mailing lists related to FreeType:

- [freetype@nongnu.org](mailto:freetype@nongnu.org) Discusses general use and applications of FreeType, as well as future and wanted additions to the library and distribution. If you are looking for support, start in this list if you haven't found anything to help you in the documentation.
- [freetype-devel@nongnu.org](mailto:freetype-devel@nongnu.org) Discusses bugs, as well as engine internals, design issues, specific licenses, porting, etc. Our home page can be found at <http://www.freetype.org>

This file contains the copying permission notices for various files in the GNU C Library distribution that have copyright owners other than the Free Software Foundation. These notices all require that a copy of the notice be included in the accompanying documentation and be distributed with binary distributions of the code, so be sure to include this file along with any binary distributions derived from the GNU C Library.

All code incorporated from 4.4 BSD is distributed under the following license:

Copyright (C) 1991 Regents of the University of California.  
All rights reserved.

Redistribution and use in source and binary forms, with or without modification, are permitted provided that the following conditions are met:

1. Redistributions of source code must retain the above copyright notice, this list of conditions and the following disclaimer.
2. Redistributions in binary form must reproduce the above copyright notice, this list of conditions and the following disclaimer in the documentation and/or other materials provided with the distribution.
3. This condition was removed.
4. Neither the name of the University nor the names of its contributors may be used to endorse or promote products derived from this software without specific prior written permission.

THIS SOFTWARE IS PROVIDED BY THE REGENTS AND CONTRIBUTORS ``AS IS" AND ANY EXPRESS OR IMPLIED WARRANTIES, INCLUDING, BUT NOT LIMITED TO, THE IMPLIED WARRANTIES OF MERCHANTABILITY AND FITNESS FOR A PARTICULAR PURPOSE ARE DISCLAIMED. IN NO EVENT SHALL THE REGENTS OR CONTRIBUTORS BE LIABLE FOR ANY DIRECT, INDIRECT, INCIDENTAL, SPECIAL, EXEMPLARY, OR CONSEQUENTIAL DAMAGES (INCLUDING, BUT NOT LIMITED TO, PROCUREMENT OF SUBSTITUTE GOODS OR SERVICES; LOSS OF USE, DATA, OR PROFITS; OR BUSINESS INTERRUPTION) HOWEVER CAUSED AND ON ANY THEORY OF LIABILITY, WHETHER IN CONTRACT, STRICT LIABILITY, OR TORT (INCLUDING NEGLIGENCE OR OTHERWISE) ARISING IN ANY WAY OUT OF THE USE OF THIS SOFTWARE, EVEN IF ADVISED OF THE POSSIBILITY OF SUCH DAMAGE.

The DNS resolver code, taken from BIND 4.9.5, is copyrighted both by UC Berkeley and by Digital Equipment Corporation. The DEC portions are under the following license:

Portions Copyright (C) 1993 by Digital Equipment Corporation.

Permission to use, copy, modify, and distribute this software for any purpose with or without fee is hereby granted, provided that the above copyright notice and this permission notice appear in all copies, and that the name of Digital Equipment Corporation not be used in advertising or publicity pertaining to distribution of the document or software without specific, written prior permission.

THE SOFTWARE IS PROVIDED ``AS IS" AND DIGITAL EQUIPMENT CORP. DISCLAIMS ALL WARRANTIES WITH REGARD TO THIS SOFTWARE, INCLUDING ALL IMPLIED WARRANTIES OF MERCHANTABILITY AND FITNESS. IN NO EVENT SHALL DIGITAL EQUIPMENT CORPORATION BE LIABLE FOR ANY SPECIAL, DIRECT, INDIRECT, OR



CONSEQUENTIAL DAMAGES OR ANY DAMAGES WHATSOEVER RESULTING FROM LOSS OF USE, DATA OR PROFITS, WHETHER IN AN ACTION OF CONTRACT, NEGLIGENCE OR OTHER TORTIOUS ACTION, ARISING OUT OF OR IN CONNECTION WITH THE USE OR PERFORMANCE OF THIS SOFTWARE.

The Sun RPC support (from rpcsrc-4.0) is covered by the following license:

Copyright (C) 1984, Sun Microsystems, Inc.

Sun RPC is a product of Sun Microsystems, Inc. and is provided for unrestricted use provided that this legend is included on all tape media and as a part of the software program in whole or part. Users may copy or modify Sun RPC without charge, but are not authorized to license or distribute it to anyone else except as part of a product or program developed by the user.

SUN RPC IS PROVIDED AS IS WITH NO WARRANTIES OF ANY KIND INCLUDING THE WARRANTIES OF DESIGN, MERCHANTABILITY AND FITNESS FOR A PARTICULAR PURPOSE, OR ARISING FROM A COURSE OF DEALING, USAGE OR TRADE PRACTICE.

Sun RPC is provided with no support and without any obligation on the part of Sun Microsystems, Inc. to assist in its use, correction, modification or enhancement.

SUN MICROSYSTEMS, INC. SHALL HAVE NO LIABILITY WITH RESPECT TO THE INFRINGEMENT OF COPYRIGHTS, TRADE SECRETS OR ANY PATENTS BY SUN RPC OR ANY PART THEREOF.

In no event will Sun Microsystems, Inc. be liable for any lost revenue or profits or other special, indirect and consequential damages, even if Sun has been advised of the possibility of such damages.

The following CMU license covers some of the support code for Mach, derived from Mach 3.0:

Mach Operating System  
Copyright (C) 1991,1990,1989 Carnegie Mellon University  
All Rights Reserved.

Permission to use, copy, modify and distribute this software and its documentation is hereby granted, provided that both the copyright notice and this permission notice appear in all copies of the software, derivative works or modified versions, and any portions thereof, and that both notices appear in supporting documentation.

CARNEGIE MELLON ALLOWS FREE USE OF THIS SOFTWARE IN ITS ``AS IS'' CONDITION. CARNEGIE MELLON DISCLAIMS ANY LIABILITY OF ANY KIND FOR ANY DAMAGES WHATSOEVER RESULTING FROM THE USE OF THIS SOFTWARE.

Carnegie Mellon requests users of this software to return to

Software Distribution Coordinator  
School of Computer Science  
Carnegie Mellon University  
Pittsburgh PA 15213-3890

or Software.Distribution@CS.CMU.EDU any improvements or extensions that they make and grant Carnegie Mellon the rights to redistribute these changes.

The file `if_ppp.h` is under the following CMU license:

Redistribution and use in source and binary forms, with or without modification, are permitted provided that the following conditions are met:

1. Redistributions of source code must retain the above copyright notice, this list of conditions and the following disclaimer.
2. Redistributions in binary form must reproduce the above copyright notice, this list of conditions and the following disclaimer in the documentation and/or other materials provided with the distribution.
3. Neither the name of the University nor the names of its contributors may be used to endorse or promote products derived from this software without specific prior written permission.

THIS SOFTWARE IS PROVIDED BY CARNEGIE MELLON UNIVERSITY AND CONTRIBUTORS ``AS IS" AND ANY EXPRESS OR IMPLIED WARRANTIES, INCLUDING, BUT NOT LIMITED TO, THE IMPLIED WARRANTIES OF MERCHANTABILITY AND FITNESS FOR A PARTICULAR PURPOSE ARE DISCLAIMED.

IN NO EVENT SHALL THE UNIVERSITY OR CONTRIBUTORS BE LIABLE FOR ANY DIRECT, INDIRECT, INCIDENTAL, SPECIAL, EXEMPLARY, OR CONSEQUENTIAL DAMAGES (INCLUDING, BUT NOT LIMITED TO, PROCUREMENT OF SUBSTITUTE GOODS OR SERVICES; LOSS OF USE, DATA, OR PROFITS; OR BUSINESS INTERRUPTION) HOWEVER CAUSED AND ON ANY THEORY OF LIABILITY, WHETHER IN CONTRACT, STRICT LIABILITY, OR TORT (INCLUDING NEGLIGENCE OR OTHERWISE) ARISING IN ANY WAY OUT OF THE USE OF THIS SOFTWARE, EVEN IF ADVISED OF THE POSSIBILITY OF SUCH DAMAGE.

The following license covers the files from Intel's "Highly Optimized Mathematical Functions for Itanium" collection:

Intel License Agreement

Copyright (c) 2000, Intel Corporation

All rights reserved.

Redistribution and use in source and binary forms, with or without modification, are permitted provided that the following conditions are met:

Redistributions of source code must retain the above copyright notice, this list of conditions and the following disclaimer.

Redistributions in binary form must reproduce the above copyright notice, this list of conditions and the following disclaimer in the documentation and/or other materials provided with the distribution.

The name of Intel Corporation may not be used to endorse or promote products derived from this software without specific prior written permission.

THIS SOFTWARE IS PROVIDED BY THE COPYRIGHT HOLDERS AND CONTRIBUTORS

"AS IS" AND ANY EXPRESS OR IMPLIED WARRANTIES, INCLUDING, BUT NOT LIMITED TO, THE IMPLIED WARRANTIES OF MERCHANTABILITY AND FITNESS FOR A PARTICULAR PURPOSE ARE DISCLAIMED. IN NO EVENT SHALL INTEL OR CONTRIBUTORS BE LIABLE FOR ANY DIRECT, INDIRECT, INCIDENTAL, SPECIAL, EXEMPLARY, OR CONSEQUENTIAL DAMAGES (INCLUDING, BUT NOT LIMITED TO,

PROCUREMENT OF SUBSTITUTE GOODS OR SERVICES; LOSS OF USE, DATA, OR PROFITS; OR BUSINESS INTERRUPTION) HOWEVER CAUSED AND ON ANY THEORY OF LIABILITY, WHETHER IN CONTRACT, STRICT LIABILITY, OR TORT (INCLUDING NEGLIGENCE OR OTHERWISE) ARISING IN ANY WAY OUT OF THE USE OF THIS SOFTWARE, EVEN IF ADVISED OF THE POSSIBILITY OF SUCH DAMAGE.

### **Glibc2.9\_License**

The files `inet/getnameinfo.c` and `sysdeps/posix/getaddrinfo.c` are copyright (C) by Craig Metz and are distributed under the following license:

The Inner Net License, Version 2.00

The author(s) grant permission for redistribution and use in source and binary forms, with or without modification, of the software and documentation provided that the following conditions are met:

0. If you receive a version of the software that is specifically labelled as not being for redistribution (check the version message and/or README), you are not permitted to redistribute that version of the software in any way or form.
1. All terms of the all other applicable copyrights and licenses must be followed.
2. Redistributions of source code must retain the authors' copyright notice(s), this list of conditions, and the following disclaimer.
3. Redistributions in binary form must reproduce the authors' copyright notice(s), this list of conditions, and the following disclaimer in the documentation and/or other materials provided with the distribution.
4. The copyright holder has authorized the removal of this clause.
5. Neither the name(s) of the author(s) nor the names of its contributors may be used to endorse or promote products derived from this software without specific prior written permission.

THIS SOFTWARE IS PROVIDED BY ITS AUTHORS AND CONTRIBUTORS ``AS IS" AND ANY EXPRESS OR IMPLIED WARRANTIES, INCLUDING, BUT NOT LIMITED TO, THE IMPLIED WARRANTIES OF MERCHANTABILITY AND FITNESS FOR A PARTICULAR PURPOSE ARE DISCLAIMED. IN NO EVENT SHALL THE AUTHORS OR CONTRIBUTORS BE LIABLE FOR ANY DIRECT, INDIRECT, INCIDENTAL, SPECIAL, EXEMPLARY, OR CONSEQUENTIAL DAMAGES (INCLUDING, BUT NOT LIMITED TO, PROCUREMENT OF SUBSTITUTE GOODS OR SERVICES; LOSS OF USE, DATA, OR PROFITS; OR BUSINESS INTERRUPTION) HOWEVER CAUSED AND ON ANY THEORY OF LIABILITY, WHETHER IN CONTRACT, STRICT LIABILITY, OR TORT (INCLUDING NEGLIGENCE OR OTHERWISE) ARISING IN ANY WAY OUT OF THE USE OF THIS SOFTWARE, EVEN IF ADVISED OF THE POSSIBILITY OF SUCH DAMAGE.

If these license terms cause you a real problem, contact the author.

### **GPLv2**

GNU GENERAL PUBLIC LICENSE

Version 2, June 1991

Copyright © 1989, 1991 Free Software Foundation, Inc.

51 Franklin Street, Fifth Floor, Boston, MA 02110-1301, USA

Everyone is permitted to copy and distribute verbatim copies of this license document, but changing it is not allowed.

#### **Preamble**

The licenses for most software are designed to take away your freedom to share and change it. By contrast, the GNU General Public License is intended to guarantee your freedom to share and change free software—to make sure the software is free for all its users. This General Public License applies to most of the Free Software Foundation's software and to any other program

whose authors commit to using it. (Some other Free Software Foundation software is covered by the GNU Library General Public License instead.) You can apply it to your programs, too. When we speak of free software, we are referring to freedom, not price. Our General Public Licenses are designed to make sure that you have the freedom to distribute copies of free software (and charge for this service if you wish), that you receive source code or can get it if you want it, that you can change the software or use pieces of it in new free programs; and that you know you can do these things.

To protect your rights, we need to make restrictions that forbid anyone to deny you these rights or to ask you to surrender the rights. These restrictions translate to certain responsibilities for you if you distribute copies of the software, or if you modify it.

For example, if you distribute copies of such a program, whether gratis or for a fee, you must give the recipients all the rights that you have. You must make sure that they, too, receive or can get the source code.

And you must show them these terms so they know their rights. We protect your rights with two steps: (1) copyright the software, and (2) offer you this license which gives you legal permission to copy, distribute and/or modify the software.

Also, for each author's protection and ours, we want to make certain that everyone understands that there is no warranty for this free software. If the software is modified by someone else and passed on, we want its recipients to know that what they have is not the original, so that any problems introduced by others will not reflect on the original authors' reputations.

Finally, any free program is threatened constantly by software patents. We wish to avoid the danger that redistributors of a free program will individually obtain patent licenses, in effect making the program proprietary. To prevent this, we have made it clear that any patent must be licensed for everyone's free use or not licensed at all. The precise terms and conditions for copying, distribution and modification follow.

#### **TERMS AND CONDITIONS FOR COPYING, DISTRIBUTION AND MODIFICATION**

0. This License applies to any program or other work which contains a notice placed by the copyright holder saying it may be distributed under the terms of this General Public License. The "Program", below, refers to any such program or work, and a "work based on the Program" means either the Program or any derivative work under copyright law: that is to say, a work containing the Program or a portion of it, either verbatim or with modifications and/or translated into another language. (Hereinafter, translation is included without limitation in the term "modification".) Each licensee is addressed as "you".

Activities other than copying, distribution and modification are not covered by this License; they are outside its scope. The act of running the Program is not restricted, and the output from the Program is covered only if its contents constitute a work based on the Program (independent of having been made by running the Program). Whether that is true depends on what the Program does.

1. You may copy and distribute verbatim copies of the Program's source code as you receive it, in any medium, provided that you conspicuously and appropriately publish on each copy an appropriate copyright notice and disclaimer of warranty; keep intact all the notices that refer to this License and to the absence of any warranty; and give any other recipients of the Program a copy of this License along with the Program. You may charge a fee for the physical act of transferring a copy, and you may at your option offer warranty protection in exchange for a fee.

2. You may modify your copy or copies of the Program or any portion of it, thus forming a work based on the Program, and copy and distribute such modifications or work under the terms of Section 1 above, provided that you also meet all of these conditions:

a. You must cause the modified files to carry prominent notices stating that you changed the files and the date of any change.

b. You must cause any work that you distribute or publish, that in whole or in part contains or is derived from the Program or any part thereof, to be licensed as a whole at no charge to all third parties under the terms of this License.

c. If the modified program normally reads commands interactively when run, you must cause it, when started running for such interactive use in the most ordinary way, to print or display an announcement including an appropriate copyright notice and a notice that there is no warranty (or else, saying that you provide a warranty) and that users may redistribute the program under

these conditions, and telling the user how to view a copy of this License. (Exception: if the Program itself is interactive but does not normally print such an announcement, your work based on the Program is not required to print an announcement.)

These requirements apply to the modified work as a whole. If identifiable sections of that work are not derived from the Program, and can be reasonably considered independent and separate works in themselves, then this License, and its terms, do not apply to those sections when you distribute them as separate works. But when you distribute the same sections as part of a whole which is a work based on the Program, the distribution of the whole must be on the terms of this License, whose permissions for other licensees extend to the entire whole, and thus to each and every part regardless of who wrote it. Thus, it is not the intent of this section to claim rights or contest your rights to work written entirely by you; rather, the intent is to exercise the right to control the distribution of derivative or collective works based on the Program.

In addition, mere aggregation of another work not based on the Program with the Program (or with a work based on the Program) on a volume of a storage or distribution medium does not bring the other work under the scope of this License.

3. You may copy and distribute the Program (or a work based on it, under Section 2) in object code or executable form under the terms of Sections 1 and 2 above provided that you also do one of the following:

a. Accompany it with the complete corresponding machine-readable source code, which must be distributed under the terms of Sections 1 and 2 above on a medium customarily used for software interchange; or,

b. Accompany it with a written offer, valid for at least three years, to give any third party, for a charge no more than your cost of physically performing source distribution, a complete machine-readable copy of the corresponding source code, to be distributed under the terms of Sections 1 and 2 above on a medium customarily used for software interchange; or,

c. Accompany it with the information you received as to the offer to distribute corresponding source code. (This alternative is allowed only for noncommercial distribution and only if you received the program in object code or executable form with such an offer, in accord with Subsection b above.) The source code for a work means the preferred form of the work for making modifications to it. For an executable work, complete source code means all the source code for all modules it contains, plus any associated interface definition files, plus the scripts used to control compilation and installation of the executable. However, as a special exception, the source code distributed need not include anything that is normally distributed (in either source or binary form) with the major components (compiler, kernel, and so on) of the operating system on which the executable runs, unless that component itself accompanies the executable. If distribution of executable or object code is made by offering access to copy from a designated place, then offering equivalent access to copy the source code from the same place counts as distribution of the source code, even though third parties are not compelled to copy the source along with the object code.

4. You may not copy, modify, sublicense, or distribute the Program except as expressly provided under this License. Any attempt otherwise to copy, modify, sublicense or distribute the Program is void, and will automatically terminate your rights under this License. However, parties who have received copies, or rights, from you under this License will not have their licenses terminated so long as such parties remain in full compliance.

5. You are not required to accept this License, since you have not signed it. However, nothing else grants you permission to modify or distribute the Program or its derivative works. These actions are prohibited by law if you do not accept this License. Therefore, by modifying or distributing the Program (or any work based on the Program), you indicate your acceptance of this License to do so, and all its terms and conditions for copying, distributing or modifying the Program or works based on it.

6. Each time you redistribute the Program (or any work based on the Program), the recipient automatically receives a license from the original licensor to copy, distribute or modify the Program subject to these terms and conditions. You may not impose any further restrictions on the recipients' exercise of the rights granted herein. You are not responsible for enforcing compliance by third parties to this License.

7. If, as a consequence of a court judgment or allegation of patent infringement or for any other reason (not limited to patent issues), conditions are imposed on you (whether by court order, agreement or otherwise) that contradict the conditions of this License, they do not excuse you from the conditions of this License. If you cannot distribute so as to satisfy simultaneously your obligations under this License and any other pertinent obligations, then as a consequence you may not distribute the Program at all. For example, if a patent license would not permit royalty-free redistribution of the Program by all those who receive copies directly or indirectly through you, then the only way you could satisfy both it and this License would be to refrain entirely from distribution of the Program.

If any portion of this section is held invalid or unenforceable under any particular circumstance, the balance of the section is intended to apply and the section as a whole is intended to apply in other circumstances.

It is not the purpose of this section to induce you to infringe any patents or other property right claims or to contest validity of any such claims; this section has the sole purpose of protecting the integrity of the free software distribution system, which is implemented by public license practices. Many people have made generous contributions to the wide range of software distributed through that system in reliance on consistent application of that system; it is up to the author/donor to decide if he or she is willing to distribute software through any other system and a licensee cannot impose that choice.

This section is intended to make thoroughly clear what is believed to be a consequence of the rest of this License.

8. If the distribution and/or use of the Program is restricted in certain countries either by patents or by copyrighted interfaces, the original copyright holder who places the Program under this License may add an explicit geographical distribution limitation excluding those countries, so that distribution is permitted only in or among countries not thus excluded. In such case, this License incorporates the limitation as if written in the body of this License.

9. The Free Software Foundation may publish revised and/or new versions of the General Public License from time to time. Such new versions will be similar in spirit to the present version, but may differ in detail to address new problems or concerns.

Each version is given a distinguishing version number. If the Program specifies a version number of this License which applies to it and “any later version”, you have the option of following the terms and conditions either of that version or of any later version published by the Free Software Foundation. If the Program does not specify a version number of this License, you may choose any version ever published by the Free Software Foundation.

10. If you wish to incorporate parts of the Program into other free programs whose distribution conditions are different, write to the author to ask for permission. For software which is copyrighted by the Free Software Foundation, write to the Free Software Foundation; we sometimes make exceptions for this. Our decision will be guided by the two goals of preserving the free status of all derivatives of our free software and of promoting the sharing and reuse of software generally.

## **NO WARRANTY**

11. BECAUSE THE PROGRAM IS LICENSED FREE OF CHARGE, THERE IS NO WARRANTY FOR THE PROGRAM, TO THE EXTENT PERMITTED BY APPLICABLE LAW. EXCEPT WHEN OTHERWISE STATED IN WRITING THE COPYRIGHT HOLDERS AND/OR OTHER PARTIES PROVIDE THE PROGRAM “AS IS” WITHOUT WARRANTY OF ANY KIND, EITHER EXPRESSED OR IMPLIED, INCLUDING, BUT NOT LIMITED TO, THE IMPLIED WARRANTIES OF MERCHANTABILITY AND FITNESS FOR A PARTICULAR PURPOSE. THE ENTIRE RISK AS TO THE QUALITY AND PERFORMANCE OF THE PROGRAM IS WITH YOU. SHOULD THE PROGRAM PROVE DEFECTIVE, YOU ASSUME THE COST OF ALL NECESSARY SERVICING, REPAIR OR CORRECTION.

12. IN NO EVENT UNLESS REQUIRED BY APPLICABLE LAW OR AGREED TO IN WRITING WILL ANY COPYRIGHT HOLDER, OR ANY OTHER PARTY WHO MAY MODIFY AND/OR REDISTRIBUTE THE PROGRAM AS PERMITTED ABOVE, BE LIABLE TO YOU FOR DAMAGES, INCLUDING ANY GENERAL, SPECIAL, INCIDENTAL OR CONSEQUENTIAL DAMAGES ARISING OUT OF THE USE OR

INABILITY TO USE THE PROGRAM (INCLUDING BUT NOT LIMITED TO LOSS OF DATA OR DATA BEING RENDERED INACCURATE OR LOSSES SUSTAINED BY YOU OR THIRD PARTIES OR A FAILURE OF THE PROGRAM TO OPERATE WITH ANY OTHER PROGRAMS), EVEN IF SUCH HOLDER OR OTHER PARTY HAS BEEN ADVISED OF THE POSSIBILITY OF SUCH DAMAGES.

END OF TERMS AND CONDITIONS

Appendix: How to Apply These Terms to Your New Programs

If you develop a new program, and you want it to be of the greatest possible use to the public, the best way to achieve this is to make it free software which everyone can redistribute and change under these terms. To do so, attach the following notices to the program. It is safest to attach them to the start of each source file to most effectively convey the exclusion of warranty; and each file should have at least the “copyright” line and a pointer to where the full notice is found.

*one line to give the program's name and a brief idea of what it does.*

Copyright (C) yyyy name of author

This program is free software; you can redistribute it and/or modify it under the terms of the GNU General Public License as published by the Free Software Foundation; either version 2 of the License, or (at your option) any later version.

This program is distributed in the hope that it will be useful, but WITHOUT ANY WARRANTY; without even the implied warranty of MERCHANTABILITY or FITNESS FOR A PARTICULAR PURPOSE. See the GNU General Public License for more details.

You should have received a copy of the GNU General Public License along with this program; if not, write to the Free Software Foundation, Inc., 51 Franklin Street, Fifth Floor, Boston, MA 02110-1301, USA.

Also add information on how to contact you by electronic and paper mail.

If the program is interactive, make it output a short notice like this when it starts in an interactive mode:

Gnomovision version 69, Copyright (C) 19yy name of author

Gnomovision comes with ABSOLUTELY NO WARRANTY; for details type `show w'.

This is free software, and you are welcome to redistribute it

under certain conditions; type `show c' for details.

The hypothetical commands `show w' and `show c' should show the appropriate parts of the General Public

License. Of course, the commands you use may be called something other than `show w' and `show c'; they

could even be mouse-clicks or menu items—whatever suits your program.

You should also get your employer (if you work as a programmer) or your school, if any, to sign a “copyright

disclaimer” for the program, if necessary. Here is a sample; alter the names:

Yoyodyne, Inc., hereby disclaims all copyright interest in the program  
`Gnomovision' (which makes passes at compilers) written by James Hacker.

*signature of Ty Coon, 1 April 1989*

Ty Coon, President of Vice

This General Public License does not permit incorporating your program into proprietary programs. If your program is a subroutine library, you may consider it more useful to permit linking proprietary applications with the library. If this is what you want to do, use the GNU Library General Public License instead of this License.

**GPLv3****GNU GENERAL PUBLIC LICENSE**

Version 3, 29 June 2007

Copyright © 2007 Free Software Foundation, Inc. <<http://fsf.org/>>

Everyone is permitted to copy and distribute verbatim copies of this license document, but changing it is not allowed.

**Preamble**

The GNU General Public License is a free, copyleft license for software and other kinds of works.

The licenses for most software and other practical works are designed to take away your freedom to share and change the works. By contrast, the GNU General Public License is intended to guarantee your freedom to share and change all versions of a program--to make sure it remains free software for all its users. We, the Free Software Foundation, use the GNU General Public License for most of our software; it applies also to any other work released this way by its authors. You can apply it to your programs, too. When we speak of free software, we are referring to freedom, not price. Our General Public Licenses are designed to make sure that you have the freedom to distribute copies of free software (and charge for them if you wish), that you receive source code or can get it if you want it, that you can change the software or use pieces of it in new free programs, and that you know you can do these things.

To protect your rights, we need to prevent others from denying you these rights or asking you to surrender the rights. Therefore, you have certain responsibilities if you distribute copies of the software, or if you modify it: responsibilities to respect the freedom of others. For example, if you distribute copies of such a program, whether gratis or for a fee, you must pass on to the recipients the same freedoms that you received. You must make sure that they, too, receive or can get the source code. And you must show them these terms so they know their rights. Developers that use the GNU GPL protect your rights with two steps: (1) assert copyright on the software, and (2) offer you this License giving you legal permission to copy, distribute and/or modify it. For the developers' and authors' protection, the GPL clearly explains that there is no warranty for this free software. For both users' and authors' sake, the GPL requires that modified versions be marked as changed, so that their problems will not be attributed erroneously to authors of previous versions.

Some devices are designed to deny users access to install or run modified versions of the software inside them, although the manufacturer can do so. This is fundamentally incompatible with the aim of protecting users' freedom to change the software. The systematic pattern of such abuse occurs in the area of products for individuals to use, which is precisely where it is most unacceptable. Therefore, we have designed this version of the GPL to prohibit the practice for those products. If such problems arise substantially in other domains, we stand ready to extend this provision to those domains in future versions of the GPL, as needed to protect the freedom of users.

Finally, every program is threatened constantly by software patents. States should not allow patents to restrict development and use of software on general-purpose computers, but in those that do, we wish to avoid the special danger that patents applied to a free program could make it effectively proprietary. To prevent this, the GPL assures that patents cannot be used to render the program non-free. The precise terms and conditions for copying, distribution and modification follow.

**TERMS AND CONDITIONS****0. Definitions.**

“This License” refers to version 3 of the GNU General Public License.

“Copyright” also means copyright-like laws that apply to other kinds of works, such as semiconductor masks.

“The Program” refers to any copyrightable work licensed under this License. Each licensee is addressed as “you”. “Licensees” and “recipients” may be individuals or organizations.



To “modify” a work means to copy from or adapt all or part of the work in a fashion requiring copyright permission, other than the making of an exact copy. The resulting work is called a “modified version” of the earlier work or a work “based on” the earlier work.

A “covered work” means either the unmodified Program or a work based on the Program.

To “propagate” a work means to do anything with it that, without permission, would make you directly or secondarily liable for infringement under applicable copyright law, except executing it on a computer or modifying a private copy. Propagation includes copying, distribution (with or without modification), making available to the public, and in some countries other activities as well.

To “convey” a work means any kind of propagation that enables other parties to make or receive copies. Mere interaction with a user through a computer network, with no transfer of a copy, is not conveying. An interactive user interface displays “Appropriate Legal Notices” to the extent that it includes a convenient and prominently visible feature that (1) displays an appropriate copyright notice, and (2) tells the user that there is no warranty for the work (except to the extent that warranties are provided), that licensees may convey the work under this License, and how to view a copy of this License. If the interface presents a list of user commands or options, such as a menu, a prominent item in the list meets this criterion.

### **1. Source Code.**

The “source code” for a work means the preferred form of the work for making modifications to it. “Object code” means any non-source form of a work.

A “Standard Interface” means an interface that either is an official standard defined by a recognized standards body, or, in the case of interfaces specified for a particular programming language, one that is widely used among developers working in that language.

The “System Libraries” of an executable work include anything, other than the work as a whole, that (a) is included in the normal form of packaging a Major Component, but which is not part of that Major Component,

and (b) serves only to enable use of the work with that Major Component, or to implement a Standard Interface for which an implementation is available to the public in source code form. A “Major Component”, in this context, means a major essential component (kernel, window system, and so on) of the specific operating system (if any) on which the executable work runs, or a compiler used to produce the work, or an object code interpreter used to run it.

The “Corresponding Source” for a work in object code form means all the source code needed to generate, install, and (for an executable work) run the object code and to modify the work, including scripts to control those activities. However, it does not include the work’s System Libraries, or general-purpose tools or generally available free programs which are used unmodified in performing those activities but which are not part of the work. For example, Corresponding Source includes interface definition files associated with source files for the work, and the source code for shared libraries and dynamically linked subprograms that the work is specifically designed to require, such as by intimate data communication or control flow between those subprograms and other parts of the work.

The Corresponding Source need not include anything that users can regenerate automatically from other parts of the Corresponding Source.

The Corresponding Source for a work in source code form is that same work.

### **2. Basic Permissions.**

All rights granted under this License are granted for the term of copyright on the Program, and are irrevocable provided the stated conditions are met. This License explicitly affirms your unlimited permission to run the unmodified Program. The output from running a covered work is covered by this License only if the output, given its content, constitutes a covered work. This License acknowledges your rights of fair use or other equivalent, as provided by copyright law. You may make, run and propagate covered works that you do not convey, without conditions so long as your license otherwise remains in force. You may convey covered works to others for the sole purpose of having them make modifications exclusively for you, or provide you with facilities for running those works, provided that you comply with the terms of this License in conveying all material for which you do not control copyright. Those thus making or running the covered works for you must do so

exclusively on your behalf, under your direction and control, on terms that prohibit them from making any copies of your copyrighted material outside their relationship with you. Conveying under any other circumstances is permitted solely under the conditions stated below. Sublicensing is not allowed; section 10 makes it unnecessary.

### **3. Protecting Users' Legal Rights From Anti-Circumvention Law.**

No covered work shall be deemed part of an effective technological measure under any applicable law fulfilling obligations under article 11 of the WIPO copyright treaty adopted on 20 December 1996, or similar laws prohibiting or restricting circumvention of such measures. When you convey a covered work, you waive any legal power to forbid circumvention of technological measures to the extent such circumvention is effected by exercising rights under this License with respect to the covered work, and you disclaim any intention to limit operation or modification of the work as a means of enforcing, against the work's users, your or third parties' legal rights to forbid circumvention of technological measures.

### **4. Conveying Verbatim Copies.**

You may convey verbatim copies of the Program's source code as you receive it, in any medium, provided that you conspicuously and appropriately publish on each copy an appropriate copyright notice; keep intact all notices stating that this License and any non-permissive terms added in accord with section 7 apply to the code; keep intact all notices of the absence of any warranty; and give all recipients a copy of this License along with the Program.

You may charge any price or no price for each copy that you convey, and you may offer support or warranty protection for a fee.

### **5. Conveying Modified Source Versions.**

You may convey a work based on the Program, or the modifications to produce it from the Program, in the form of source code under the terms of section 4, provided that you also meet all of these conditions:

- a) The work must carry prominent notices stating that you modified it, and giving a relevant date.
- b) The work must carry prominent notices stating that it is released under this License and any conditions added under section 7. This requirement modifies the requirement in section 4 to "keep intact all notices".
- c) You must license the entire work, as a whole, under this License to anyone who comes into possession of a copy. This License will therefore apply, along with any applicable section 7 additional terms, to the whole of the work, and all its parts, regardless of how they are packaged. This License gives no permission to license the work in any other way, but it does not invalidate such permission if you have separately received it.
- d) If the work has interactive user interfaces, each must display Appropriate Legal Notices; however, if the Program has interactive interfaces that do not display Appropriate Legal Notices, your work need not make them do so.

A compilation of a covered work with other separate and independent works, which are not by their nature extensions of the covered work, and which are not combined with it such as to form a larger program, in or on

a volume of a storage or distribution medium, is called an "aggregate" if the compilation and its resulting copyright are not used to limit the access or legal rights of the compilation's users beyond what the individual works permit. Inclusion of a covered work in an aggregate does not cause this License to apply to the other parts of the aggregate.

### **6. Conveying Non-Source Forms.**

You may convey a covered work in object code form under the terms of sections 4 and 5, provided that you

also convey the machine-readable Corresponding Source under the terms of this License, in one of these ways:

a) Convey the object code in, or embodied in, a physical product (including a physical distribution medium), accompanied by the Corresponding Source fixed on a durable physical medium customarily used for software interchange.

- b) Convey the object code in, or embodied in, a physical product (including a physical distribution medium), accompanied by a written offer, valid for at least three years and valid for as long as you offer spare parts or customer support for that product model, to give anyone who possesses the object code either (1) a copy of the Corresponding Source for all the software in the product that is covered by this License, on a durable physical medium customarily used for software interchange, for a price no more than your reasonable cost of physically performing this conveying of source, or (2) access to copy the Corresponding Source from a network server at no charge.
- c) Convey individual copies of the object code with a copy of the written offer to provide the Corresponding Source. This alternative is allowed only occasionally and noncommercially, and only if you received the object code with such an offer, in accord with subsection 6b.
- d) Convey the object code by offering access from a designated place (gratis or for a charge), and offer equivalent access to the Corresponding Source in the same way through the same place at no further charge. You need not require recipients to copy the Corresponding Source along with the object code. If the place to copy the object code is a network server, the Corresponding Source may be on a different server (operated by you or a third party) that supports equivalent copying facilities, provided you maintain clear directions next to the object code saying where to find the Corresponding Source. Regardless of what server hosts the Corresponding Source, you remain obligated to ensure that it is available for as long as needed to satisfy these requirements.
- e) Convey the object code using peer-to-peer transmission, provided you inform other peers where the object code and Corresponding Source of the work are being offered to the general public at no charge under subsection 6d. A separable portion of the object code, whose source code is excluded from the Corresponding Source as a System Library, need not be included in conveying the object code work.

A “User Product” is either (1) a “consumer product”, which means any tangible personal property which is normally used for personal, family, or household purposes, or (2) anything designed or sold for incorporation into a dwelling. In determining whether a product is a consumer product, doubtful cases shall be resolved in favor of coverage. For a particular product received by a particular user, “normally used” refers to a typical or common use of that class of product, regardless of the status of the particular user or of the way in which the particular user actually uses, or expects or is expected to use, the product. A product is a consumer product regardless of whether the product has substantial commercial, industrial or non-consumer uses, unless such uses represent the only significant mode of use of the product.

“Installation Information” for a User Product means any methods, procedures, authorization keys, or other information required to install and execute modified versions of a covered work in that User Product from a modified version of its Corresponding Source. The information must suffice to ensure that the continued functioning of the modified object code is in no case prevented or interfered with solely because modification has been made.

If you convey an object code work under this section in, or with, or specifically for use in, a User Product, and

the conveying occurs as part of a transaction in which the right of possession and use of the User Product is transferred to the recipient in perpetuity or for a fixed term (regardless of how the transaction is characterized), the Corresponding Source conveyed under this section must be accompanied by the Installation Information. But this requirement does not apply if neither you nor any third party retains the ability to install modified object code on the User Product (for example, the work has been installed in ROM).

The requirement to provide Installation Information does not include a requirement to continue to provide support service, warranty, or updates for a work that has been modified or installed by the recipient, or for the User Product in which it has been modified or installed. Access to a network may be denied when the modification itself materially and adversely affects the operation of the network or violates the rules and protocols for communication across the network. Corresponding Source conveyed, and Installation Information provided, in accord with this section must be in a format that is publicly documented (and with an implementation available to the public in source code form), and must require no special password or key for unpacking, reading or copying.

## 7. Additional Terms.

“Additional permissions” are terms that supplement the terms of this License by making exceptions from one or more of its conditions. Additional permissions that are applicable to the entire Program shall be treated as though they were included in this License, to the extent that they are valid under applicable law. If additional permissions apply only to part of the Program, that part may be used separately under those permissions, but the entire Program remains governed by this License without regard to the additional permissions.

When you convey a copy of a covered work, you may at your option remove any additional permissions from that copy, or from any part of it. (Additional permissions may be written to require their own removal in certain cases when you modify the work.) You may place additional permissions on material, added by you to a covered work, for which you have or can give appropriate copyright permission.

Notwithstanding any other provision of this License, for material you add to a covered work, you may (if authorized by the copyright holders of that material) supplement the terms of this License with terms:

- a) Disclaiming warranty or limiting liability differently from the terms of sections 15 and 16 of this License; or
- b) Requiring preservation of specified reasonable legal notices or author attributions in that material or in the Appropriate Legal Notices displayed by works containing it; or
- c) Prohibiting misrepresentation of the origin of that material, or requiring that modified versions of such material be marked in reasonable ways as different from the original version; or
- d) Limiting the use for publicity purposes of names of licensors or authors of the material; or
- e) Declining to grant rights under trademark law for use of some trade names, trademarks, or service marks; or
- f) Requiring indemnification of licensors and authors of that material by anyone who conveys the material (or modified versions of it) with contractual assumptions of liability to the recipient, for any liability that these contractual assumptions directly impose on those licensors and authors.

All other non-permissive additional terms are considered “further restrictions” within the meaning of section

10. If the Program as you received it, or any part of it, contains a notice stating that it is governed by this License along with a term that is a further restriction, you may remove that term. If a license document contains a further restriction but permits relicensing or conveying under this License, you may add to a covered work material governed by the terms of that license document, provided that the further restriction does not survive such relicensing or conveying. If you add terms to a covered work in accord with this section, you must place, in the relevant source files, a statement of the additional terms that apply to those files, or a notice indicating where to find the applicable terms.

Additional terms, permissive or non-permissive, may be stated in the form of a separately written license, or stated as exceptions; the above requirements apply either way.

## 8. Termination.

You may not propagate or modify a covered work except as expressly provided under this License. Any attempt otherwise to propagate or modify it is void, and will automatically terminate your rights under this License (including any patent licenses granted under the third paragraph of section 11).

However, if you cease all violation of this License, then your license from a particular copyright holder is reinstated (a) provisionally, unless and until the copyright holder explicitly and finally terminates your license,

and (b) permanently, if the copyright holder fails to notify you of the violation by some reasonable means prior to 60 days after the cessation.

Moreover, your license from a particular copyright holder is reinstated permanently if the copyright holder notifies you of the violation by some reasonable means, this is the first time you have received notice of violation of this License (for any work) from that copyright holder, and you cure the violation prior to 30 days

after your receipt of the notice. Termination of your rights under this section does not terminate the licenses of parties who have received copies or rights from you under this License. If your rights have been terminated and not permanently reinstated, you do not qualify to receive new licenses for the same material under section 10.

### **9. Acceptance Not Required for Having Copies.**

You are not required to accept this License in order to receive or run a copy of the Program. Ancillary propagation of a covered work occurring solely as a consequence of using peer-to-peer transmission to receive a copy likewise does not require acceptance. However, nothing other than this License grants you permission to propagate or modify any covered work. These actions infringe copyright if you do not accept this License. Therefore, by modifying or propagating a covered work, you indicate your acceptance of this License to do so.

### **10. Automatic Licensing of Downstream Recipients.**

Each time you convey a covered work, the recipient automatically receives a license from the original licensors, to run, modify and propagate that work, subject to this License. You are not responsible for enforcing compliance by third parties with this License.

An “entity transaction” is a transaction transferring control of an organization, or substantially all assets of one, or subdividing an organization, or merging organizations. If propagation of a covered work results from an entity transaction, each party to that transaction who receives a copy of the work also receives whatever licenses to the work the party's predecessor in interest had or could give under the previous paragraph, plus a right to possession of the Corresponding Source of the work from the predecessor in interest, if the predecessor has it or can get it with reasonable efforts.

You may not impose any further restrictions on the exercise of the rights granted or affirmed under this License. For example, you may not impose a license fee, royalty, or other charge for exercise of rights granted under this License, and you may not initiate litigation (including a cross-claim or counterclaim in a lawsuit) alleging that any patent claim is infringed by making, using, selling, offering for sale, or importing the Program or any portion of it.

### **11. Patents.**

A “contributor” is a copyright holder who authorizes use under this License of the Program or a work on which the Program is based. The work thus licensed is called the contributor's “contributor version”.

A contributor's “essential patent claims” are all patent claims owned or controlled by the contributor, whether already acquired or hereafter acquired, that would be infringed by some manner, permitted by this License, of making, using, or selling its contributor version, but do not include claims that would be infringed only as a consequence of further modification of the contributor version. For purposes of this definition, “control” includes the right to grant patent sublicenses in a manner consistent with the requirements of this License.

Each contributor grants you a non-exclusive, worldwide, royalty-free patent license under the contributor's essential patent claims, to make, use, sell, offer for sale, import and otherwise run, modify and propagate the contents of its contributor version.

In the following three paragraphs, a “patent license” is any express agreement or commitment, however denominated, not to enforce a patent (such as an express permission to practice a patent or covenant not to sue for patent infringement). To “grant” such a patent license to a party means to make such an agreement or commitment not to enforce a patent against the party.

If you convey a covered work, knowingly relying on a patent license, and the Corresponding Source of the work is not available for anyone to copy, free of charge and under the terms of this License, through a publicly available network server or other readily accessible means, then you must either (1) cause the Corresponding Source to be so available, or (2) arrange to deprive yourself of the benefit of the patent license for this particular work, or (3) arrange, in a manner consistent with the requirements of this License, to extend the patent license to downstream recipients. “Knowingly relying” means you have actual knowledge that, but for the patent license, your conveying the covered work in a country, or your recipient's use of the covered work in a country, would infringe one or more identifiable patents in that country that you have reason to believe are valid.

If, pursuant to or in connection with a single transaction or arrangement, you convey, or propagate by procuring conveyance of, a covered work, and grant a patent license to some of the parties receiving the covered work authorizing them to use, propagate, modify or convey a specific copy of the covered work, then the patent license you grant is automatically extended to all recipients of the covered work and works based on it.

A patent license is “discriminatory” if it does not include within the scope of its coverage, prohibits the exercise of, or is conditioned on the non-exercise of one or more of the rights that are specifically granted under this License. You may not convey a covered work if you are a party to an arrangement with a third party that is in the business of distributing software, under which you make payment to the third party based on the extent of your activity of conveying the work, and under which the third party grants, to any of the parties who would receive the covered work from you, a discriminatory patent license (a) in connection with copies of the covered work conveyed by you (or copies made from those copies), or (b) primarily for and in connection with specific products or compilations that contain the covered work, unless you entered into that arrangement, or that patent license was granted, prior to 28 March 2007.

Nothing in this License shall be construed as excluding or limiting any implied license or other defenses to infringement that may otherwise be available to you under applicable patent law.

#### **12. No Surrender of Others' Freedom.**

If conditions are imposed on you (whether by court order, agreement or otherwise) that contradict the conditions of this License, they do not excuse you from the conditions of this License. If you cannot convey a covered work so as to satisfy simultaneously your obligations under this License and any other pertinent obligations, then as a consequence you may not convey it at all. For example, if you agree to terms that obligate you to collect a royalty for further conveying from those to whom you convey the Program, the only way you could satisfy both those terms and this License would be to refrain entirely from conveying the Program.

#### **13. Use with the GNU Affero General Public License.**

Notwithstanding any other provision of this License, you have permission to link or combine any covered

work with a work licensed under version 3 of the GNU Affero General Public License into a single combined

work, and to convey the resulting work. The terms of this License will continue to apply to the part which is

the covered work, but the special requirements of the GNU Affero General Public License, section 13,

concerning interaction through a network will apply to the combination as such.

#### **14. Revised Versions of this License.**

The Free Software Foundation may publish revised and/or new versions of the GNU General Public License from time to time. Such new versions will be similar in spirit to the present version, but may differ in detail to

address new problems or concerns. Each version is given a distinguishing version number. If the Program specifies that a certain numbered version of the GNU General Public License “or any later version” applies to it, you have the option of following the terms and conditions either of that numbered version or of any later version published by the Free Software Foundation. If the Program does not specify a version number of the GNU General Public License, you may choose any version ever published by the Free Software Foundation.

If the Program specifies that a proxy can decide which future versions of the GNU General Public License can be used, that proxy's public statement of acceptance of a version permanently authorizes you to choose that version for the Program.

Later license versions may give you additional or different permissions. However, no additional obligations are

imposed on any author or copyright holder as a result of your choosing to follow a later version.

#### **15. Disclaimer of Warranty.**

THERE IS NO WARRANTY FOR THE PROGRAM, TO THE EXTENT PERMITTED BY APPLICABLE LAW. EXCEPT WHEN OTHERWISE STATED IN WRITING THE COPYRIGHT HOLDERS AND/OR OTHER PARTIES PROVIDE THE PROGRAM “AS IS”

WITHOUT WARRANTY OF ANY KIND, EITHER EXPRESSED OR IMPLIED, INCLUDING, BUT NOT LIMITED TO, THE IMPLIED WARRANTIES OF MERCHANTABILITY AND FITNESS FOR A PARTICULAR PURPOSE. THE ENTIRE RISK AS TO THE QUALITY AND PERFORMANCE OF THE PROGRAM IS WITH YOU. SHOULD THE PROGRAM PROVE DEFECTIVE, YOU ASSUME THE COST OF ALL NECESSARY SERVICING, REPAIR OR CORRECTION.

#### **16. Limitation of Liability.**

IN NO EVENT UNLESS REQUIRED BY APPLICABLE LAW OR AGREED TO IN WRITING WILL ANY

COPYRIGHT HOLDER, OR ANY OTHER PARTY WHO MODIFIES AND/OR CONVEYS THE PROGRAM AS PERMITTED ABOVE, BE LIABLE TO YOU FOR DAMAGES, INCLUDING ANY GENERAL, SPECIAL, INCIDENTAL OR CONSEQUENTIAL DAMAGES ARISING OUT OF THE USE OR INABILITY TO USE THE PROGRAM (INCLUDING BUT NOT LIMITED TO LOSS OF DATA OR DATA BEING RENDERED INACCURATE OR LOSSES SUSTAINED BY YOU OR THIRD PARTIES OR A FAILURE OF THE PROGRAM TO OPERATE WITH ANY OTHER PROGRAMS), EVEN IF SUCH HOLDER OR OTHER PARTY HAS BEEN ADVISED OF THE POSSIBILITY OF SUCH DAMAGES.

#### **17. Interpretation of Sections 15 and 16.**

If the disclaimer of warranty and limitation of liability provided above cannot be given local legal effect according to their terms, reviewing courts shall apply local law that most closely approximates an absolute waiver of all civil liability in connection with the Program, unless a warranty or assumption of liability accompanies a copy of the Program in return for a fee.

END OF TERMS AND CONDITIONS

#### **How to Apply These Terms to Your New Programs**

If you develop a new program, and you want it to be of the greatest possible use to the public, the best way to achieve this is to make it free software which everyone can redistribute and change under these terms.

To do so, attach the following notices to the program. It is safest to attach them to the start of each source file to most effectively state the exclusion of warranty; and each file should have at least the "copyright" line and a pointer to where the full notice is found.

<one line to give the program's name and a brief idea of what it does.>  
Copyright (C) <year> <name of author>

This program is free software: you can redistribute it and/or modify it under the terms of the GNU General Public License as published by the Free Software Foundation, either version 3 of the License, or (at your option) any later version.

This program is distributed in the hope that it will be useful, but WITHOUT ANY WARRANTY; without even the implied warranty of MERCHANTABILITY or FITNESS FOR A PARTICULAR PURPOSE. See the GNU General Public License for more details.

You should have received a copy of the GNU General Public License along with this program. If not, see <<http://www.gnu.org/licenses/>>.

Also add information on how to contact you by electronic and paper mail.

If the program does terminal interaction, make it output a short notice like this when it starts in an interactive

mode:

<program> Copyright (C) <year> <name of author>

This program comes with ABSOLUTELY NO WARRANTY; for details type `show w'.

This is free software, and you are welcome to redistribute it under certain conditions; type `show c' for details.

The hypothetical commands ``show w`` and ``show c`` should show the appropriate parts of the General Public License. Of course, your program's commands might be different; for a GUI interface, you would use an "about box".

You should also get your employer (if you work as a programmer) or school, if any, to sign a "copyright disclaimer" for the program, if necessary. For more information on this, and how to apply and follow the GNU

GPL, see <http://www.gnu.org/licenses/>.

The GNU General Public License does not permit incorporating your program into proprietary programs. If your program is a subroutine library, you may consider it more useful to permit linking proprietary applications

with the library. If this is what you want to do, use the GNU Lesser General Public License instead of this License. But first, please read <http://www.gnu.org/philosophy/why-not-lgpl.html>.

### **gSOAP.**

The following notice is applicable to the CinemaNow® SDK. Company is required to include such notice in the documentation for any Embedded Products it distributes.

Part of the software embedded in this product is gSOAP software.

Portions created by gSOAP are Copyright (C) 2001-2004 Robert A. van Engelen, Genivia Inc. All Rights

Reserved.

THE SOFTWARE IN THIS PRODUCT WAS IN PART PROVIDED BY GENIVIA INC AND ANY EXPRESS OR IMPLIED WARRANTIES, INCLUDING, BUT NOT LIMITED TO, THE IMPLIED WARRANTIES OF MERCHANTABILITY AND FITNESS FOR A PARTICULAR PURPOSE ARE DISCLAIMED. IN NO EVENT SHALL THE AUTHOR BE LIABLE FOR ANY DIRECT, INDIRECT, INCIDENTAL, SPECIAL, EXEMPLARY, OR CONSEQUENTIAL DAMAGES (INCLUDING, BUT NOT LIMITED TO, PROCUREMENT OF SUBSTITUTE GOODS OR SERVICES; LOSS OF USE, DATA, OR PROFITS; OR BUSINESS INTERRUPTION) HOWEVER CAUSED AND ON ANY THEORY OF LIABILITY, WHETHER IN CONTRACT, STRICT LIABILITY, OR TORT (INCLUDING NEGLIGENCE OR OTHERWISE) ARISING IN ANY WAY OUT OF THE USE OF THIS SOFTWARE, EVEN IF ADVISED OF THE POSSIBILITY OF SUCH DAMAGE.

### **ICU License - ICU 1.8.1 and later**

#### **COPYRIGHT AND PERMISSION NOTICE**

Copyright (c) 1995-2011 International Business Machines Corporation and others

All rights reserved.

Permission is hereby granted, free of charge, to any person obtaining a copy of this software and associated documentation files (the "Software"), to deal in the Software without restriction, including without limitation the rights to use, copy, modify, merge, publish, distribute, and/or sell copies of the Software, and to permit persons to whom the Software is furnished to do so, provided that the above copyright notice(s) and this permission notice appear in all copies of the Software and that both the above copyright notice(s) and this permission notice appear in supporting documentation.

THE SOFTWARE IS PROVIDED "AS IS", WITHOUT WARRANTY OF ANY KIND, EXPRESS OR IMPLIED, INCLUDING BUT NOT LIMITED TO THE WARRANTIES OF MERCHANTABILITY, FITNESS FOR A PARTICULAR PURPOSE AND NONINFRINGEMENT OF THIRD PARTY RIGHTS. IN NO EVENT SHALL THE COPYRIGHT HOLDER OR HOLDERS INCLUDED IN THIS NOTICE BE LIABLE FOR ANY CLAIM, OR ANY SPECIAL INDIRECT OR CONSEQUENTIAL DAMAGES, OR ANY DAMAGES WHATSOEVER RESULTING FROM LOSS OF USE, DATA OR PROFITS, WHETHER IN AN ACTION OF CONTRACT, NEGLIGENCE OR OTHER TORTIOUS ACTION, ARISING OUT OF OR IN CONNECTION WITH THE USE OR PERFORMANCE OF THIS SOFTWARE.



Except as contained in this notice, the name of a copyright holder shall not be used in advertising or otherwise to promote the sale, use or other dealings in this Software without prior written authorization of the copyright holder.

All trademarks and registered trademarks mentioned herein are the property of their respective owners.

### **IJG license**

Description

In plain English:

1. We don't promise that this software works. (But if you find any bugs, please let us know!)
2. You can use this software for whatever you want. You don't have to pay us.
3. You may not pretend that you wrote this software. If you use it in a program, you must acknowledge somewhere in your documentation that you've used the IJG code.

In legalese:

The authors make NO WARRANTY or representation, either express or implied, with respect to this software,

its quality, accuracy, merchantability, or fitness for a particular purpose. This software is provided "AS IS", and you, its user, assume the entire risk as to its quality and accuracy. This software is copyright (C) 1991-2010, Thomas G. Lane, Guido Vollbeding. All Rights Reserved except as specified below.

Permission is hereby granted to use, copy, modify, and distribute this software (or portions thereof) for any purpose, without fee, subject to these

### **Conditions**

(1) If any part of the source code for this software is distributed, then this README file must be included, with this copyright and no-warranty notice unaltered; and any additions, deletions, or changes to the original files must be clearly indicated in accompanying documentation. (2) If only executable code is distributed, then the accompanying documentation must state that "this software is based in part on the work of the Independent JPEG Group". (3) Permission for use of this software is granted only if the user accepts full responsibility for any undesirable consequences; the authors accept NO LIABILITY for damages of any kind.

These conditions apply to any software derived from or based on the IJG code, not just to the unmodified library. If you use our work, you ought to acknowledge us.

Permission is NOT granted for the use of any IJG author's name or company name in advertising or publicity relating to this software or products derived from it. This software may be referred to only as "the Independent JPEG Group's software".

We specifically permit and encourage the use of this software as the basis of commercial products, provided that all warranty or liability claims are assumed by the product vendor. ansi2knr.c is included in this distribution by permission of L. Peter Deutsch, sole proprietor of its copyright holder, Aladdin Enterprises of Menlo Park, CA. ansi2knr.c is NOT covered by the above copyright and conditions, but instead by the usual distribution terms of the Free Software Foundation; principally, that you must include source code if you redistribute it. (See the file ansi2knr.c for full details.) However, since ansi2knr.c is not needed as part of any program generated from the IJG code, this does not limit you more than the foregoing paragraphs do.

The Unix configuration script "configure" was produced with GNU Autoconf. It is copyright by the Free Software Foundation but is freely distributable. The same holds for its supporting scripts (config.guess, config.sub, ltmain.sh). Another support script, install-sh, is copyright by X Consortium but is also freely distributable.

The IJG distribution formerly included code to read and write GIF files. To avoid entanglement with the Unisys LZW patent, GIF reading support has been removed altogether, and the GIF writer has been simplified to produce "uncompressed GIFs". This technique does not use the LZW algorithm; the resulting GIF files are larger than usual, but are readable by all standard GIF decoders.

We are required to state that "The Graphics Interchange Format(c) is the Copyright property of CompuServe Incorporated. GIF(sm) is a Service Mark property of CompuServe Incorporated."

### **JSON\_Parser**

Permission is hereby granted, free of charge, to any person obtaining a copy of this software and associated documentation files (the "Software"), to deal in the Software without restriction, including without limitation the rights to use, copy, modify, merge, publish, distribute, sublicense, and/or sell copies of the Software, and to permit persons to whom the Software is furnished to do so, subject to the following conditions:

The above copyright notice and this permission notice shall be included in all copies or substantial portions of the Software. The Software shall be used for Good, not Evil.  
 THE SOFTWARE IS PROVIDED "AS IS", WITHOUT WARRANTY OF ANY KIND, EXPRESS OR IMPLIED, INCLUDING BUT NOT LIMITED TO THE WARRANTIES OF MERCHANTABILITY, FITNESS FOR A PARTICULAR PURPOSE AND NONINFRINGEMENT. IN NO EVENT SHALL THE AUTHORS OR COPYRIGHT HOLDERS BE LIABLE FOR ANY CLAIM, DAMAGES OR OTHER LIABILITY, WHETHER IN AN ACTION OF CONTRACT, TORT OR OTHERWISE, ARISING FROM, OUT OF OR IN CONNECTION WITH THE SOFTWARE OR THE USE OR OTHER DEALINGS IN THE SOFTWARE.

### **LGPLv2.1**

#### **GNU LESSER GENERAL PUBLIC LICENSE**

Version 2.1, February 1999

Copyright (C) 1991, 1999 Free Software Foundation, Inc.

51 Franklin Street, Fifth Floor, Boston, MA 02110-1301 USA

Everyone is permitted to copy and distribute verbatim copies of this license document, but changing it is not allowed.

[This is the first released version of the Lesser GPL. It also counts as the successor of the GNU Library Public License, version 2, hence the version number 2.1.]

#### **Preamble**

The licenses for most software are designed to take away your freedom to share and change it. By contrast, the GNU General Public Licenses are intended to guarantee your freedom to share and change free software--to make sure the software is free for all its users.

This license, the Lesser General Public License, applies to some specially designated software packages--typically libraries--of the Free Software Foundation and other authors who decide to use it. You can use it too, but we suggest you first think carefully about whether this license or the ordinary General Public License is the better strategy to use in any particular case, based on the explanations below.

When we speak of free software, we are referring to freedom of use, not price. Our General Public Licenses are designed to make sure that you have the freedom to distribute copies of free software (and charge for this service if you wish); that you receive source code or can get it if you want it; that you can change the software and use pieces of it in new free programs; and that you are informed that you can do these things.

To protect your rights, we need to make restrictions that forbid distributors to deny you these rights or to ask you to surrender these rights. These restrictions translate to certain responsibilities for you if you distribute copies of the library or if you modify it.

For example, if you distribute copies of the library, whether gratis or for a fee, you must give the recipients all

the rights that we gave you. You must make sure that they, too, receive or can get the source code. If you link other code with the library, you must provide complete object files to the recipients, so that they can relink them with the library after making changes to the library and recompiling it. And you must show them these terms so they know their rights.

We protect your rights with a two-step method: (1) we copyright the library, and (2) we offer you this license, which gives you legal permission to copy, distribute and/or modify the library.

To protect each distributor, we want to make it very clear that there is no warranty for the free library. Also, if the library is modified by someone else and passed on, the recipients should

know that what they have is not the original version, so that the original author's reputation will not be affected by problems that might be introduced by others.

Finally, software patents pose a constant threat to the existence of any free program. We wish to make sure that a company cannot effectively restrict the users of a free program by obtaining a restrictive license from a patent holder. Therefore, we insist that any patent license obtained for a version of the library must be consistent with the full freedom of use specified in this license.

Most GNU software, including some libraries, is covered by the ordinary GNU General Public License. This license, the GNU Lesser General Public License, applies to certain designated libraries, and is quite different from the ordinary General Public License. We use this license for certain libraries in order to permit linking those libraries into non-free programs.

When a program is linked with a library, whether statically or using a shared library, the combination of the two is legally speaking a combined work, a derivative of the original library.

The ordinary General Public License therefore permits such linking only if the entire combination fits its criteria of freedom. The Lesser General Public License permits more lax criteria for linking other code with the library.

We call this license the "Lesser" General Public License because it does Less to protect the user's freedom than the ordinary General Public License. It also provides other free software developers Less of an advantage over competing non-free programs. These disadvantages are the reason we use the ordinary General Public License for many libraries. However, the Lesser license provides advantages in certain special circumstances.

For example, on rare occasions, there may be a special need to encourage the widest possible use of a certain library, so that it becomes a de-facto standard. To achieve this, non-free programs must be allowed to use the library. A more frequent case is that a free library does the same job as widely used non-free libraries. In this case, there is little to gain by limiting the free library to free software only, so we use the Lesser General Public License.

In other cases, permission to use a particular library in non-free programs enables a greater number of people to use a large body of free software. For example, permission to use the GNU C Library in non-free programs enables many more people to use the whole GNU operating system, as well as its variant, the GNU/Linux operating system.

Although the Lesser General Public License is Less protective of the users' freedom, it does ensure that the user of a program that is linked with the Library has the freedom and the wherewithal to run that program using a modified version of the Library.

The precise terms and conditions for copying, distribution and modification follow. Pay close attention to the difference between a "work based on the library" and a "work that uses the library". The former contains code derived from the library, whereas the latter must be combined with the library in order to run.

## **TERMS AND CONDITIONS FOR COPYING, DISTRIBUTION AND MODIFICATION**

0. This License Agreement applies to any software library or other program which contains a notice placed by

the copyright holder or other authorized party saying it may be distributed under the terms of this Lesser General Public License (also called "this License"). Each licensee is addressed as "you". A "library" means a collection of software functions and/or data prepared so as to be conveniently linked with application programs (which use some of those functions and data) to form executables.

The "Library", below, refers to any such software library or work which has been distributed under these terms. A "work based on the Library" means either the Library or any derivative work under copyright law: that is to say, a work containing the Library or a portion of it, either verbatim or with modifications and/or translated straightforwardly into another language. (Hereinafter, translation is included without limitation in the term "modification".)

"Source code" for a work means the preferred form of the work for making modifications to it. For a library, complete source code means all the source code for all modules it contains, plus any associated interface definition files, plus the scripts used to control compilation and installation of the library.

Activities other than copying, distribution and modification are not covered by this License; they are outside its scope. The act of running a program using the Library is not restricted, and output

from such a program is covered only if its contents constitute a work based on the Library (independent of the use of the Library in a tool for writing it). Whether that is true depends on what the Library does and what the program that uses the Library does.

1. You may copy and distribute verbatim copies of the Library's complete source code as you receive it, in any medium, provided that you conspicuously and appropriately publish on each copy an appropriate copyright notice and disclaimer of warranty; keep intact all the notices that refer to this License and to the absence of any warranty; and distribute a copy of this License along with the Library.

You may charge a fee for the physical act of transferring a copy, and you may at your option offer warranty protection in exchange for a fee.

2. You may modify your copy or copies of the Library or any portion of it, thus forming a work based on the Library, and copy and distribute such modifications or work under the terms of Section 1 above, provided that you also meet all of these conditions:

a) The modified work must itself be a software library.

b) You must cause the files modified to carry prominent notices stating that you changed the files and the date of any change.

c) You must cause the whole of the work to be licensed at no charge to all third parties under the terms of this License.

d) If a facility in the modified Library refers to a function or a table of data to be supplied by an application program that uses the facility, other than as an argument passed when the facility is invoked, then you must make a good faith effort to ensure that, in the event an application does not supply such function or table, the facility still operates, and performs whatever part of its purpose remains meaningful.

(For example, a function in a library to compute square roots has a purpose that is entirely well-defined independent of the application. Therefore, Subsection 2d requires that any application-supplied function or table used by this function must be optional: if the application does not supply it, the square root function must still compute square roots.)

These requirements apply to the modified work as a whole. If identifiable sections of that work are not derived from the Library, and can be reasonably considered independent and separate works in themselves, then this License, and its terms, do not apply to those sections when you distribute them as separate works. But when you distribute the same sections as part of a whole which is a work based on the Library, the distribution of the whole must be on the terms of this License, whose permissions for other licensees extend to the entire whole, and thus to each and every part regardless of who wrote it.

Thus, it is not the intent of this section to claim rights or contest your rights to work written entirely by you; rather, the intent is to exercise the right to control the distribution of derivative or collective works based on the Library.

In addition, mere aggregation of another work not based on the Library with the Library (or with a work based

on the Library) on a volume of a storage or distribution medium does not bring the other work under the scope of this License.

3. You may opt to apply the terms of the ordinary GNU General Public License instead of this License to a given copy of the Library. To do this, you must alter all the notices that refer to this License, so that they refer to the ordinary GNU General Public License, version 2, instead of to this License. (If a newer version than version 2 of the ordinary GNU General Public License has appeared, then you can specify that version instead if you wish.) Do not make any other change in these notices.

Once this change is made in a given copy, it is irreversible for that copy, so the ordinary GNU General Public License applies to all subsequent copies and derivative works made from that copy.

This option is useful when you wish to copy part of the code of the Library into a program that is not a library.

4. You may copy and distribute the Library (or a portion or derivative of it, under Section 2) in object code or executable form under the terms of Sections 1 and 2 above provided that you accompany it with the complete corresponding machine-readable source code, which must be

distributed under the terms of Sections 1 and 2 above on a medium customarily used for software interchange.

If distribution of object code is made by offering access to copy from a designated place, then offering equivalent access to copy the source code from the same place satisfies the requirement to distribute the source code, even though third parties are not compelled to copy the source along with the object code.

5. A program that contains no derivative of any portion of the Library, but is designed to work with the Library by being compiled or linked with it, is called a "work that uses the Library". Such a work, in isolation, is not a

derivative work of the Library, and therefore falls outside the scope of this License.

However, linking a "work that uses the Library" with the Library creates an executable that is a derivative of the Library (because it contains portions of the Library), rather than a "work that uses the library". The executable is therefore covered by this License. Section 6 states terms for distribution of such executables.

When a "work that uses the Library" uses material from a header file that is part of the Library, the object code for the work may be a derivative work of the Library even though the source code is not. Whether this is true is especially significant if the work can be linked without the Library, or if the work is itself a library.

The threshold for this to be true is not precisely defined by law.

If such an object file uses only numerical parameters, data structure layouts and accessors, and small macros and small inline functions (ten lines or less in length), then the use of the object file is unrestricted, regardless of whether it is legally a derivative work. (Executables containing this object code plus portions of the Library will still fall under Section 6.)

Otherwise, if the work is a derivative of the Library, you may distribute the object code for the work under the terms of Section 6. Any executables containing that work also fall under Section 6, whether or not they are linked directly with the Library itself.

6. As an exception to the Sections above, you may also combine or link a "work that uses the Library" with the Library to produce a work containing portions of the Library, and distribute that work under terms of your choice, provided that the terms permit modification of the work for the customer's own use and reverse engineering for debugging such modifications.

You must give prominent notice with each copy of the work that the Library is used in it and that the Library and its use are covered by this License. You must supply a copy of this License. If the work during execution displays copyright notices, you must include the copyright notice for the Library among them, as well as a reference directing the user to the copy of this License. Also, you must do one of these things:

a) Accompany the work with the complete corresponding machine-readable source code for the Library including whatever changes were used in the work (which must be distributed under Sections 1 and 2 above); and, if the work is an executable linked with the Library, with the complete machine-readable "work that uses the Library", as object code and/or source code, so that the user can modify the Library and then relink to produce a modified executable containing the modified Library. (It is understood that the user who changes the contents of definitions files in the Library will not necessarily be able to recompile the application to use the modified definitions.)

b) Use a suitable shared library mechanism for linking with the Library. A suitable mechanism is one that (1) uses at run time a copy of the library already present on the user's computer system, rather than copying library functions into the executable, and (2) will operate properly with a modified version of the library, if the user installs one, as long as the modified version is interface-compatible with the version that the work was made with.

c) Accompany the work with a written offer, valid for at least three years, to give the same user the materials specified in Subsection 6a, above, for a charge no more than the cost of performing this distribution.

d) If distribution of the work is made by offering access to copy from a designated place, offer equivalent access to copy the above specified materials from the same place.

e) Verify that the user has already received a copy of these materials or that you have already sent this user a copy.

For an executable, the required form of the "work that uses the Library" must include any data and utility programs needed for reproducing the executable from it. However, as a special exception, the materials to be distributed need not include anything that is normally distributed (in either source or binary form) with the major components (compiler, kernel, and so on) of the operating system on which the executable runs, unless that component itself accompanies the executable.

It may happen that this requirement contradicts the license restrictions of other proprietary libraries that do not normally accompany the operating system. Such a contradiction means you cannot use both them and the Library together in an executable that you distribute.

7. You may place library facilities that are a work based on the Library side-by-side in a single library together with other library facilities not covered by this License, and distribute such a combined library, provided that the separate distribution of the work based on the Library and of the other library facilities is otherwise permitted, and provided that you do these two things:

a) Accompany the combined library with a copy of the same work based on the Library, uncombined with any other library facilities. This must be distributed under the terms of the Sections above.

b) Give prominent notice with the combined library of the fact that part of it is a work based on the Library, and explaining where to find the accompanying uncombined form of the same work.

8. You may not copy, modify, sublicense, link with, or distribute the Library except as expressly provided under this License. Any attempt otherwise to copy, modify, sublicense, link with, or distribute the Library is void, and will automatically terminate your rights under this License.

However, parties who have received copies, or rights, from you under this License will not have their licenses terminated so long as such parties remain in full compliance.

9. You are not required to accept this License, since you have not signed it. However, nothing else grants you permission to modify or distribute the Library or its derivative works. These actions are prohibited by law if you do not accept this License. Therefore, by modifying or distributing the Library (or any work based on the Library), you indicate your acceptance of this License to do so, and all its terms and conditions for copying, distributing or modifying the Library or works based on it.

10. Each time you redistribute the Library (or any work based on the Library), the recipient automatically receives a license from the original licensor to copy, distribute, link with or modify the Library subject to these terms and conditions. You may not impose any further restrictions on the recipients' exercise of the rights granted herein. You are not responsible for enforcing compliance by third parties with this License.

11. If, as a consequence of a court judgment or allegation of patent infringement or for any other reason (not limited to patent issues), conditions are imposed on you (whether by court order, agreement or otherwise) that contradict the conditions of this License, they do not excuse you from the conditions of this License. If you cannot distribute so as to satisfy simultaneously your obligations under this License and any other pertinent obligations, then as a consequence you may not distribute the Library at all. For example, if a patent license would not permit royalty-free redistribution of the Library by all those who receive copies directly or indirectly through you, then the only way you could satisfy both it and this License would be to refrain entirely from distribution of the Library.

If any portion of this section is held invalid or unenforceable under any particular circumstance, the balance of the section is intended to apply, and the section as a whole is intended to apply in other circumstances.

It is not the purpose of this section to induce you to infringe any patents or other property right claims or to contest validity of any such claims; this section has the sole purpose of protecting the integrity of the free software distribution system which is implemented by public license practices. Many people have made generous contributions to the wide range of software distributed through that system in reliance on consistent application of that system; it is up to the author/donor to decide if he or she is willing to distribute software through any other system and a licensee cannot impose that choice. This section is intended to make thoroughly clear what is believed to be a consequence of the rest of this License.

12. If the distribution and/or use of the Library is restricted in certain countries either by patents or by copyrighted interfaces, the original copyright holder who places the Library under this

License may add an explicit geographical distribution limitation excluding those countries, so that distribution is permitted only in or among countries not thus excluded. In such case, this License incorporates the limitation as if written in the body of this License.

13. The Free Software Foundation may publish revised and/or new versions of the Lesser General Public License from time to time. Such new versions will be similar in spirit to the present version, but may differ in detail to address new problems or concerns. Each version is given a distinguishing version number. If the Library specifies a version number of this License which applies to it and "any later version", you have the option of following the terms and conditions either of that version or of any later version published by the Free Software Foundation. If the Library does not specify a license version number, you may choose any version ever published by the Free Software Foundation.

14. If you wish to incorporate parts of the Library into other free programs whose distribution conditions are incompatible with these, write to the author to ask for permission. For software which is copyrighted by the Free Software Foundation, write to the Free Software Foundation; we sometimes make exceptions for this. Our decision will be guided by the two goals of preserving the free status of all derivatives of our free software and of promoting the sharing and reuse of software generally.

## **NO WARRANTY**

15. BECAUSE THE LIBRARY IS LICENSED FREE OF CHARGE, THERE IS NO WARRANTY FOR THE LIBRARY, TO THE EXTENT PERMITTED BY APPLICABLE LAW. EXCEPT WHEN OTHERWISE STATED IN WRITING THE COPYRIGHT HOLDERS AND/OR OTHER PARTIES PROVIDE THE LIBRARY "AS IS" WITHOUT WARRANTY OF ANY KIND, EITHER EXPRESSED OR IMPLIED, INCLUDING, BUT NOT LIMITED TO, THE IMPLIED WARRANTIES OF MERCHANTABILITY AND FITNESS FOR A PARTICULAR PURPOSE. THE ENTIRE RISK AS TO THE QUALITY AND PERFORMANCE OF THE LIBRARY IS WITH YOU. SHOULD THE LIBRARY PROVE DEFECTIVE, YOU ASSUME THE COST OF ALL NECESSARY SERVICING, REPAIR OR CORRECTION.

16. IN NO EVENT UNLESS REQUIRED BY APPLICABLE LAW OR AGREED TO IN WRITING WILL ANY COPYRIGHT HOLDER, OR ANY OTHER PARTY WHO MAY MODIFY AND/OR REDISTRIBUTE THE LIBRARY AS PERMITTED ABOVE, BE LIABLE TO YOU FOR DAMAGES, INCLUDING ANY GENERAL, SPECIAL, INCIDENTAL OR CONSEQUENTIAL DAMAGES ARISING OUT OF THE USE OR INABILITY TO USE THE LIBRARY (INCLUDING BUT NOT LIMITED TO LOSS OF DATA OR DATA BEING RENDERED INACCURATE OR LOSSES SUSTAINED BY YOU OR THIRD PARTIES OR A FAILURE OF THE LIBRARY TO OPERATE WITH ANY OTHER SOFTWARE), EVEN IF SUCH HOLDER OR OTHER PARTY HAS BEEN ADVISED OF THE POSSIBILITY OF SUCH DAMAGES.

## **END OF TERMS AND CONDITIONS**

### **How to Apply These Terms to Your New Libraries**

If you develop a new library, and you want it to be of the greatest possible use to the public, we recommend making it free software that everyone can redistribute and change. You can do so by permitting redistribution under these terms (or, alternatively, under the terms of the ordinary General Public License).

To apply these terms, attach the following notices to the library. It is safest to attach them to the start of each source file to most effectively convey the exclusion of warranty; and each file should have at least the "copyright" line and a pointer to where the full notice is found.

*one line to give the library's name and an idea of what it does.*

Copyright (C) year name of author

This library is free software; you can redistribute it and/or modify it under the terms of the GNU Lesser General Public License as published by the Free Software Foundation; either version 2.1 of the License, or (at your option) any later version.

This library is distributed in the hope that it will be useful, but WITHOUT ANY WARRANTY; without even the implied warranty of MERCHANTABILITY or FITNESS FOR A PARTICULAR PURPOSE. See the GNU Lesser General Public License for more details.

You should have received a copy of the GNU Lesser General Public License along with this library; if not, write to the Free Software Foundation, Inc., 51 Franklin Street, Fifth Floor, Boston, MA 02110-1301 USA Also add information on how to contact you by electronic and paper mail.

You should also get your employer (if you work as a programmer) or your school, if any, to sign a "copyright disclaimer" for the library, if necessary. Here is a sample; alter the names: Yoyodyne, Inc., hereby disclaims all copyright interest in the library `Frob' (a library for tweaking knobs) written by James Random Hacker.

*signature of Ty Coon, 1 April 1990*

Ty Coon, President of Vice

That's all there is to it!

### **libjpeg-7**

1. We don't promise that this software works. (But if you find any bugs, please let us know!)
2. You can use this software for whatever you want. You don't have to pay us.
3. You may not pretend that you wrote this software. If you use it in a program, you must acknowledge somewhere in your documentation that you've used the IJG code.

In legalese:

The authors make NO WARRANTY or representation, either express or implied, with respect to this software, its quality, accuracy, merchantability, or fitness for a particular purpose. This software is provided "AS IS", and you, its user, assume the entire risk as to its quality and accuracy. This software is copyright (C) 1991-1998, Thomas G. Lane. All Rights Reserved except as specified below. Permission is hereby granted to use, copy, modify, and distribute this software (or portions thereof) for any purpose, without fee, subject to these conditions:

(1) If any part of the source code for this software is distributed, then this README file must be included, with

this copyright and no-warranty notice unaltered; and any additions, deletions, or changes to the original files must be clearly indicated in accompanying documentation.

(2) If only executable code is distributed, then the accompanying documentation must state that "this software is based in part on the work of the Independent JPEG Group".

(3) Permission for use of this software is granted only if the user accepts full responsibility for any undesirable consequences; the authors accept NO LIABILITY for damages of any kind. These conditions apply to any software derived from or based on the IJG code, not just to the unmodified library. If you use our work, you ought to acknowledge us. Permission is NOT granted for the use of any IJG author's name or company name in advertising or publicity relating to this software or products derived from it. This software may be referred to only as "the Independent JPEG Group's software".

We specifically permit and encourage the use of this software as the basis of commercial products, provided that all warranty or liability claims are assumed by the product vendor. ansi2knr.c is included in this distribution by permission of L.

Peter Deutsch, sole proprietor of its copyright holder, Aladdin Enterprises of Menlo Park, CA. ansi2knr.c is NOT covered by the above copyright and conditions, but instead by the usual distribution terms of the Free Software Foundation; principally, that you must include source code if you redistribute it. (See the file ansi2knr.c for full details.) However, since ansi2knr.c is not needed as part of any program generated from the IJG code, this does not limit you more than the foregoing paragraphs do.

The Unix configuration script "configure" was produced with GNU Autoconf. It is copyright by the Free Software Foundation but is freely distributable. The same holds for its supporting scripts (config.guess, config.sub, ltconfig, ltmain.sh). Another support script, install-sh, is copyright by X Consortium. but is also freely distributable.



The IJG distribution formerly included code to read and write GIF files. To avoid entanglement with the Unisys LZW patent, GIF reading support has been removed altogether, and the GIF writer has been simplified to produce uncompressed GIFs. This technique does not use the LZW algorithm; the resulting GIF files are larger than usual, but are readable by all standard GIF decoders.

We are required to state that "The Graphics Interchange Format(c) is the Copyright property of CompuServe Incorporated. GIF(sm) is a Service Mark property of CompuServe Incorporated."

## **libpng**

This copy of the libpng notices is provided for your convenience. In case of any discrepancy between this copy and the notices in the file png.h that is included in the libpng distribution, the latter shall prevail.

**COPYRIGHT NOTICE, DISCLAIMER, and LICENSE:**

If you modify libpng you may insert additional notices immediately following this sentence.

This code is released under the libpng license.

libpng versions 1.2.6, August 15, 2004, through 1.5.7, December 15, 2011, are Copyright (c) 2004, 2006-2011 Glenn Randers-Pehrson, and are distributed according to the same disclaimer and license as libpng-1.2.5 with the following individual added to the list of Contributing Authors

Cosmin Truta

libpng versions 1.0.7, July 1, 2000, through 1.2.5 - October 3, 2002, are Copyright (c) 2000-2002 Glenn Randers-Pehrson, and are distributed according to the same disclaimer and license as libpng-1.0.6 with the following individuals added to the list of Contributing Authors

Simon-Pierre Cadieux  
Eric S. Raymond  
Gilles Vollant

and with the following additions to the disclaimer:

There is no warranty against interference with your enjoyment of the library or against infringement. There is no warranty that our efforts or the library will fulfill any of your particular purposes or needs. This library is provided with all faults, and the entire risk of satisfactory quality, performance, accuracy, and effort is with the user.

libpng versions 0.97, January 1998, through 1.0.6, March 20, 2000, are Copyright (c) 1998, 1999 Glenn Randers-Pehrson, and are distributed according to the same disclaimer and license as libpng-0.96, with the following individuals added to the list of Contributing Authors:

Tom Lane  
Glenn Randers-Pehrson  
Willem van Schaik

libpng versions 0.89, June 1996, through 0.96, May 1997, are Copyright (c) 1996, 1997 Andreas Dilger Distributed according to the same disclaimer and license as libpng-0.88, with the following individuals added to the list of Contributing Authors:

John Bowler  
Kevin Bracey

Sam Bushell  
Magnus Holmgren  
Greg Roelofs  
Tom Tanner

libpng versions 0.5, May 1995, through 0.88, January 1996, are Copyright (c) 1995, 1996 Guy Eric Schalnat, Group 42, Inc.

For the purposes of this copyright and license, "Contributing Authors" is defined as the following set of individuals:

Andreas Dilger  
Dave Martindale  
Guy Eric Schalnat  
Paul Schmidt  
Tim Wegner

The PNG Reference Library is supplied "AS IS". The Contributing Authors and Group 42, Inc. disclaim all warranties, expressed or implied, including, without limitation, the warranties of merchantability and of fitness for any purpose. The Contributing Authors and Group 42, Inc. assume no liability for direct, indirect, incidental, special, exemplary, or consequential damages, which may result from the use of the PNG Reference Library, even if advised of the possibility of such damage.

Permission is hereby granted to use, copy, modify, and distribute this source code, or portions hereof, for any purpose, without fee, subject to the following restrictions:

1. The origin of this source code must not be misrepresented.
2. Altered versions must be plainly marked as such and must not be misrepresented as being the original source.
3. This Copyright notice may not be removed or altered from any source or altered source distribution.

The Contributing Authors and Group 42, Inc. specifically permit, without fee, and encourage the use of this source code as a component to supporting the PNG file format in commercial products. If you use this source code in a product, acknowledgment is not required but would be appreciated.

A "png\_get\_copyright" function is available, for convenient use in "about" boxes and the like:

```
printf("%s",png_get_copyright(NULL));
```

Also, the PNG logo (in PNG format, of course) is supplied in the files "pngbar.png" and "pngbar.jpg (88x31) and "pngnow.png" (98x31).

Libpng is OSI Certified Open Source Software. OSI Certified Open Source is a certification mark of the Open Source Initiative.

Glenn Randers-Pehrson  
glennrp at users.sourceforge.net  
December 15, 2011

### **libxml(MIT License)**

Open Source Initiative OSI - The MIT License (MIT):Licensing

The MIT License (MIT)

Copyright (c) <year> <copyright holders>

Permission is hereby granted, free of charge, to any person obtaining a copy of this software and associated documentation files (the "Software"), to deal in the Software without restriction, including without limitation the rights to use, copy, modify, merge, publish, distribute, sublicense, and/or sell copies of the Software, and to permit persons to whom the Software is furnished to do so, subject to the following conditions:

The above copyright notice and this permission notice shall be included in all copies or substantial portions of the Software.

THE SOFTWARE IS PROVIDED "AS IS", WITHOUT WARRANTY OF ANY KIND, EXPRESS OR IMPLIED, INCLUDING BUT NOT LIMITED TO THE WARRANTIES OF MERCHANTABILITY, FITNESS FOR A PARTICULAR PURPOSE AND NONINFRINGEMENT. IN NO EVENT SHALL THE AUTHORS OR COPYRIGHT HOLDERS BE LIABLE FOR ANY CLAIM, DAMAGES OR OTHER LIABILITY, WHETHER IN AN ACTION OF CONTRACT, TORT OR OTHERWISE, ARISING FROM, OUT OF OR IN CONNECTION WITH THE SOFTWARE OR THE USE OR OTHER DEALINGS IN THE SOFTWARE.

## **Lua**

Copyright © 1994–2011 Lua.org, PUC-Rio.

Permission is hereby granted, free of charge, to any person obtaining a copy of this software and associated documentation files (the "Software"), to deal in the Software without restriction, including without limitation the rights to use, copy, modify, merge, publish, distribute, sublicense, and/or sell copies of the Software, and to permit persons to whom the Software is furnished to do so, subject to the following conditions:

The above copyright notice and this permission notice shall be included in all copies or substantial portions of the Software.

THE SOFTWARE IS PROVIDED "AS IS", WITHOUT WARRANTY OF ANY KIND, EXPRESS OR IMPLIED, INCLUDING BUT NOT LIMITED TO THE WARRANTIES OF MERCHANTABILITY, FITNESS FOR A PARTICULAR PURPOSE AND NONINFRINGEMENT. IN NO EVENT SHALL THE AUTHORS OR COPYRIGHT HOLDERS BE LIABLE FOR ANY CLAIM, DAMAGES OR OTHER LIABILITY, WHETHER IN AN ACTION OF CONTRACT, TORT OR OTHERWISE, ARISING FROM, OUT OF OR IN CONNECTION WITH THE SOFTWARE OR THE USE OR OTHER DEALINGS IN THE SOFTWARE.

## **comments:**

Copyright (C) 2000 Free Software Foundation, Inc.

Permission is granted to copy, distribute and/or modify this document under the terms of the GNU Free Documentation License, Version 1.1 or any later version published by the Free Software Foundation; with no Invariant Sections, with no Front-Cover Texts, and with no Back-Cover Texts. A copy of the license is included in the file COPYING.

name: ncurses

short-description: Displays and updates text on text-only terminals.

full-description: The ncurses (new curses) lib is a free software emulation of curses in System V Release 4.0 and more. It uses terminfo format, supports pads and color and multiple highlights and forms characters and function-key mapping, and has all the other SYSV-curses enhancements over BSD curses. It should port easily to any ANSI/POSIX-conforming UNIX-like system.

The distribution includes the lib and support utilities, including a terminfo compiler tic, a decompiler infocmp, clear, tput, tset, and a termcap conversion tool captinfo.

category: development

license: MIT

maintainer: TE Dickey <dickey@herndon4.his.com>

interface: Library, command line

updated: 22 Oct 2000

keywords: development, command line, text mode, text

programs:

GNU: yes

web-page: <http://dickey.his.com/ncurses/ncurses.html>

support:

doc: User manual included

developers: Zeyd Ben-Halim <zmbenhal@netcom.com>, Eric Raymond, Thomas Dickey <dickey@clark.net>, Jurgen Pfeifer <juergen.pfeiffer@gmx.net>

contributors: Alexander V. Lukyanov <lav@yars.free.net>

sponsors:

source: <ftp://ftp.gnu.org/pub/gnu/ncurses/ncurses-5.2.tar.gz>

debian: <http://www.debian.org/Packages/stable/base/ncurses-base.html>

redhat: <http://www.redhat.com/swr/alpha/ncurses-4.2-25.alpha.html>

repository:

related: screen, lynx, termcap

source-language:

supported-languages: C, C++, Ada95

use-requirements:

build-prerequisites: awk, sed, make

weak-prerequisites: C++ compiler, Ada95 compiler

source-prerequisites:

version: 5.2 released 21 Oct 2000

announce-list:

announce-news:

help-list: bug-ncurses@gnu.org

help-news:

dev-list: bug-ncurses@gnu.org

dev-news:

bug-list: bug-ncurses@gnu.org

## OpenSSL

### LICENSE ISSUES

The OpenSSL toolkit stays under a dual license, i.e. both the conditions of the OpenSSL License and the original SSLeay license apply to the toolkit. See below for the actual license texts. Actually both licenses are BSD-style Open Source licenses. In case of any license issues related to OpenSSL please contact openssl-core@openssl.org.

### OpenSSL License

Copyright (c) 1998-2011 The OpenSSL Project. All rights reserved.

Redistribution and use in source and binary forms, with or without modification, are permitted provided that the following conditions are met:

1. Redistributions of source code must retain the above copyright notice, this list of conditions and the following disclaimer.

2. Redistributions in binary form must reproduce the above copyright notice, this list of conditions and the following disclaimer in the documentation and/or other materials provided with the distribution.

3. All advertising materials mentioning features or use of this software must display the following acknowledgment:

"This product includes software developed by the OpenSSL Project for use in the OpenSSL Toolkit. (<http://www.openssl.org/>)"

4. The names "OpenSSL Toolkit" and "OpenSSL Project" must not be used to endorse or promote products derived from this software without prior written permission. For written permission, please contact openssl-core@openssl.org.

5. Products derived from this software may not be called "OpenSSL" nor may "OpenSSL" appear in their names without prior written permission of the OpenSSL Project.

6. Redistributions of any form whatsoever must retain the following acknowledgment:

"This product includes software developed by the OpenSSL Project for use in the OpenSSL Toolkit (<http://www.openssl.org/>)"

THIS SOFTWARE IS PROVIDED BY THE OpenSSL PROJECT ``AS IS'' AND ANY EXPRESSED OR IMPLIED WARRANTIES, INCLUDING, BUT NOT LIMITED TO, THE IMPLIED WARRANTIES OF MERCHANTABILITY AND FITNESS FOR A PARTICULAR PURPOSE ARE DISCLAIMED. IN NO EVENT SHALL THE OpenSSL PROJECT OR ITS CONTRIBUTORS BE LIABLE FOR ANY DIRECT, INDIRECT, INCIDENTAL, SPECIAL, EXEMPLARY, OR CONSEQUENTIAL DAMAGES (INCLUDING, BUT NOT LIMITED TO, PROCUREMENT OF SUBSTITUTE GOODS OR SERVICES; LOSS OF USE, DATA, OR PROFITS; OR BUSINESS INTERRUPTION) HOWEVER CAUSED AND ON ANY THEORY OF LIABILITY, WHETHER IN CONTRACT, STRICT LIABILITY, OR TORT (INCLUDING

NEGLIGENCE OR OTHERWISE) ARISING IN ANY WAY OUT OF THE USE OF THIS SOFTWARE, EVEN IF ADVISED OF THE POSSIBILITY OF SUCH DAMAGE.

This product includes cryptographic software written by Eric Young (eay@cryptsoft.com). This product includes software written by Tim Hudson (tjh@cryptsoft.com).

Original SSLeay License

Copyright (C) 1995-1998 Eric Young (eay@cryptsoft.com)

All rights reserved.

This package is an SSL implementation written by Eric Young (eay@cryptsoft.com).

The implementation was written so as to conform with Netscapes SSL.

This library is free for commercial and non-commercial use as long as the following conditions are aheared to. The following conditions apply to all code found in this distribution, be it the RC4, RSA, lhash, DES, etc., code; not just the SSL code. The SSL documentation included with this distribution is covered by the same copyright terms except that the holder is Tim Hudson (tjh@cryptsoft.com).

Copyright remains Eric Young's, and as such any Copyright notices in the code are not to be removed. If this package is used in a product, Eric Young should be given attribution as the author of the parts of the library used. This can be in the form of a textual message at program startup or in documentation (online or textual) provided with the package.

Redistribution and use in source and binary forms, with or without modification, are permitted provided that the following conditions are met:

1. Redistributions of source code must retain the copyright notice, this list of conditions and the following disclaimer.
2. Redistributions in binary form must reproduce the above copyright notice, this list of conditions and the following disclaimer in the documentation and/or other materials provided with the distribution.
3. All advertising materials mentioning features or use of this software must display the following acknowledgement:  
"This product includes cryptographic software written by Eric Young (eay@cryptsoft.com)"  
The word 'cryptographic' can be left out if the rouines from the library being used are not cryptographic related.
4. If you include any Windows specific code (or a derivative thereof) from the apps directory (application code) you must include an acknowledgement:  
"This product includes software written by Tim Hudson (tjh@cryptsoft.com)"

THIS SOFTWARE IS PROVIDED BY ERIC YOUNG ``AS IS" AND ANY EXPRESS OR IMPLIED WARRANTIES, INCLUDING, BUT NOT LIMITED TO, THE IMPLIED WARRANTIES OF MERCHANTABILITY AND FITNESS FOR A PARTICULAR PURPOSE ARE DISCLAIMED. IN NO EVENT SHALL THE AUTHOR OR CONTRIBUTORS BE LIABLE FOR ANY DIRECT, INDIRECT, INCIDENTAL, SPECIAL, EXEMPLARY, OR CONSEQUENTIAL DAMAGES (INCLUDING, BUT NOT LIMITED TO, PROCUREMENT OF SUBSTITUTE GOODS OR SERVICES; LOSS OF USE, DATA, OR PROFITS; OR BUSINESS INTERRUPTION) HOWEVER CAUSED AND ON ANY THEORY OF LIABILITY, WHETHER IN CONTRACT, STRICT LIABILITY, OR TORT (INCLUDING NEGLIGENCE OR OTHERWISE) ARISING IN ANY WAY OUT OF THE USE OF THIS SOFTWARE, EVEN IF ADVISED OF THE POSSIBILITY OF SUCH DAMAGE.

The licence and distribution terms for any publically available version or derivative of this code cannot be changed. i.e. this code cannot simply be copied and put under another distribution licence [including the GNU Public Licence.]

## SQLite Copyright

All of the deliverable code in SQLite has been dedicated to the public domain by the authors. All code authors, and representatives of the companies they work for, have signed affidavits dedicating their contributions to the public domain and originals of those signed affidavits are stored in a firesafe at the main offices of Hwaci. Anyone is free to copy, modify, publish, use, compile, sell, or distribute the original SQLite code, either in source code form or as a compiled binary, for any purpose, commercial or non-commercial, and by any means.

The previous paragraph applies to the deliverable code in SQLite - those parts of the SQLite library that you actually bundle and ship with a larger application. Portions of the documentation and some code used as part of the build process might fall under other licenses. The details here are unclear. We do not worry about the licensing of the documentation and build code so much because none of these things are part of the core deliverable SQLite library.

All of the deliverable code in SQLite has been written from scratch. No code has been taken from other projects or from the open internet. Every line of code can be traced back to its original author, and all of those authors have public domain dedications on file. So the SQLite code base is clean and is uncontaminated with licensed code from other projects.

### **TinyXML**

TinyXML is released under the zlib license:

This software is provided 'as-is', without any express or implied warranty. In no event will the authors be held liable for any damages arising from the use of this software.

Permission is granted to anyone to use this software for any purpose, including commercial applications, and to alter it and redistribute it freely, subject to the following restrictions:

1. The origin of this software must not be misrepresented; you must not claim that you wrote the original software. If you use this software in a product, an acknowledgment in the product documentation would be appreciated but is not required.
2. Altered source versions must be plainly marked as such, and must not be misrepresented as being the original software.
3. This notice may not be removed or altered from any source distribution.

### **WPA Supplicant**

Copyright (c) 2003-2011, Jouni Malinen <j@w1.fi> and contributors

All Rights Reserved.

This program is dual-licensed under both the GPL version 2 and BSD license. Either license may be used at your option.

### **XML-RPC For C/C++ License**

Copyright (C) 2001 by First Peer, Inc. All rights reserved.

Copyright (C) 2001 by Eric Kidd. All rights reserved.

Redistribution and use in source and binary forms, with or without modification, are permitted provided that the following conditions are met:

1. Redistributions of source code must retain the above copyright notice, this list of conditions and the following disclaimer.
2. Redistributions in binary form must reproduce the above copyright notice, this list of conditions and the following disclaimer in the documentation and/or other materials provided with the distribution.
3. The name of the author may not be used to endorse or promote products derived from this software without specific prior written permission.

THIS SOFTWARE IS PROVIDED BY THE AUTHOR AND CONTRIBUTORS ``AS IS'' AND ANY EXPRESS OR IMPLIED WARRANTIES, INCLUDING, BUT NOT LIMITED TO, THE IMPLIED WARRANTIES OF MERCHANTABILITY AND FITNESS FOR A PARTICULAR PURPOSE ARE DISCLAIMED. IN NO EVENT SHALL THE AUTHOR OR

CONTRIBUTORS BE LIABLE FOR ANY DIRECT, INDIRECT, INCIDENTAL, SPECIAL, EXEMPLARY, OR CONSEQUENTIAL DAMAGES (INCLUDING, BUT NOT LIMITED TO, PROCUREMENT OF SUBSTITUTE GOODS OR SERVICES; LOSS OF USE, DATA, OR PROFITS; OR BUSINESS INTERRUPTION) HOWEVER CAUSED AND ON ANY THEORY OF LIABILITY, WHETHER IN CONTRACT, STRICT LIABILITY, OR TORT (INCLUDING NEGLIGENCE OR OTHERWISE) ARISING IN ANY WAY OUT OF THE USE OF THIS SOFTWARE, EVEN IF ADVISED OF THE POSSIBILITY OF SUCH DAMAGE.

### **zlib License**

zlib.h -- interface of the 'zlib' general purpose compression library version 1.2.2, October 3rd, 2004

Copyright (C) 1995-2004 Jean-loup Gailly and Mark Adler

This software is provided 'as-is', without any express or implied warranty. In no event will the authors be held liable for any damages arising from the use of this software.

Permission is granted to anyone to use this software for any purpose, including commercial applications, and to alter it and redistribute it freely, subject to the following restrictions:

1. The origin of this software must not be misrepresented; you must not claim that you wrote the original software. If you use this software in a product, an acknowledgment in the product documentation would be appreciated but is not required.
2. Altered source versions must be plainly marked as such, and must not be misrepresented as being the original software.
3. This notice may not be removed or altered from any source distribution.

Jean-loup Gailly [jloup@gzip.org](mailto:jloup@gzip.org)

Mark Adler [madler@alumni.caltech.edu](mailto:madler@alumni.caltech.edu)

### **zziplib**

The zziplib library is intentionally lightweight, it offers the ability to easily extract data from files archived in a single zip file. Applications can bundle files into a single zip archive and access them. The implementation is based only on the (free) subset of compression with the zlib algorithm which is actually used by the zip/unzip tools.

The library allows reading zip archives in a number of ways,

archive mode:

reading the zip directory and extracting files from it. This is the traditional mode as seen with unzip-utilities. Some extra unzip-utiles for transparent/magic mode are shipped as well.

replacement mode:

Use ZZIP\_FILE / ZZIP\_DIR pointers provided by zziplib and put them to work with routines originally developed to work with real directories and file handles. The API calls do follow traditional synopsis from posix/stdio.

transparent mode:

Use replacement handles and allow the open()-calls to automatically detect when a file is contained in a zip archive or when it is a real file in the file system. A filepath can be partly in a real filesystem and partly within the zip archive when one is seen.

ext magic

Use the same filepath to access either a zipped or real file - it looks for a real file and there is none then every subdirectory of the path is checked, a ".zip" extension appended, and the zipped file transparently opened. This can speed up dat-file development dramatically.

io/xor magic

The access to the filesystem can be hooked up - examples are given for xor obfuscation which is great for game artwork and AI data. A small intro for SDLrwops usage is given as well.





## Free Manuals Download Website

<http://myh66.com>

<http://usermanuals.us>

<http://www.somanuals.com>

<http://www.4manuals.cc>

<http://www.manual-lib.com>

<http://www.404manual.com>

<http://www.luxmanual.com>

<http://aubethermostatmanual.com>

Golf course search by state

<http://golfingnear.com>

Email search by domain

<http://emailbydomain.com>

Auto manuals search

<http://auto.somanuals.com>

TV manuals search

<http://tv.somanuals.com>