

TOSHIBA

Leading Innovation >>>

Blu-ray Disc™/DVD Player User's Guide: BDX4300KU/BDX5300KU

If you need assistance:

- ❖ Toshiba's Support Web site
support.toshiba.com
- ❖ Toshiba Customer Support Center
Calling within the United States 888-592-0944
Calling from outside the United States 949-583-3305

For more information see "Troubleshooting & Maintenance" on page 43 in this guide.

Owner's Record

The model number and serial number are on the back of your player. Record these numbers in the spaces below. Refer to these numbers whenever you communicate with your Toshiba dealer about this equipment.

Model name _____

Serial number _____

Contents

Introduction	8
Symbols used in this manual	8
Features	9
Blu-ray Disc™/DVD player controls	10
Remote control buttons	12
Blu-ray Disc™/DVD player connections	16
Blu-ray Disc™ playback	19
Customizing the function settings.....	32
Security	39
Using the connected applications	40
Troubleshooting & Maintenance	43
Glossary	45
Specifications	47
License Information	48

SAFETY PRECAUTIONS

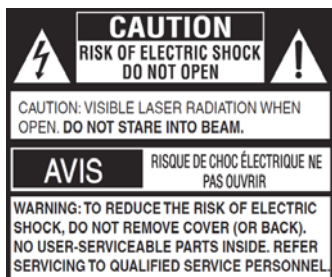

The lightning flash with an arrowhead symbol, within the equilateral triangle, is intended to alert the user to the presence of uninsulated "dangerous voltage" within the product's enclosure that may be of sufficient magnitude to constitute a risk of electric shock to persons.



The exclamation point within the equilateral triangle is intended to alert the user to the presence of important operating and maintenance (servicing) instructions in this User's Guide.

WARNING: TO REDUCE THE RISK OF FIRE OR ELECTRIC SHOCK, DO NOT EXPOSE THIS APPLIANCE TO RAIN OR MOISTURE. DANGEROUS HIGH VOLTAGES ARE PRESENT INSIDE THE ENCLOSURE. DO NOT OPEN THE CABINET. REFER SERVICING TO QUALIFIED PERSONNEL ONLY.

TO PREVENT ELECTRIC SHOCK, MATCH WIDE BLADE OF PLUG TO WIDE SLOT OF AC POWER UTLET, THEN FULLY INSERT.

CAUTION: This Blu-ray Disc™/DVD player employs a Laser System.

To ensure proper use of this product, please read this User's Guide carefully and retain for future reference. Should the unit require maintenance, contact an authorized service location. Use of controls or adjustments or performance of procedures other than those specified herein may result in hazardous radiation exposure. To prevent direct exposure to laser beam, do not try to open the enclosure. Visible and invisible laser radiation when open and interlocks defeated. **DO NOT STARE INTO BEAM.**



The symbol for Class II (Double Insulation)

Warnings:

- The mains plug is used as disconnect device and it should be located in such a manner that it can be easily unplugged in case the product requires service. In order to disconnect the

apparatus from the mains completely, the main plug should be unplugged from the mains socket outlet.

- The apparatus shall not be exposed to dripping or splashing and that no objects filled with liquid, such as vases, shall be placed on the apparatus.
- Always leave a space of at least 4 (four) inches around the apparatus. The slots and openings are provided to protect the apparatus from overheating and to help maintain reliable operation.
- Never block or cover the slots or openings in the apparatus by covering the ventilation openings with items such as newspaper, tablecloths, curtains, etc.

Warning: To prevent the spread of fire, keep candles or other open flames away from this product at all times.

- Keep the product away from direct sunlight, extreme cold, or heat sources such as a heater. This may reduce the life of the product.

IMPORTANT SAFETY INSTRUCTIONS

1. Read these instructions.
2. Keep these instructions.
3. Heed all warnings.
4. Follow all instructions.
5. Do not use this apparatus near water.
6. Clean only with a dry cloth.
7. Do not block any of the ventilation openings. Install in accordance with the manufacturer's instructions.
8. Do not install near any heat sources such as radiators, heat registers, stoves, or other apparatus (including amplifiers) that produce heat.
9. Do not defeat the safety purpose of the polarized or grounding-type plug. A polarized plug has two blades with one wider than the other. A grounding type plug has two blades and a third grounding prong. The wide blade or the third prong is provided for your safety. If the provided plug does not fit into your outlet, consult an electrician for replacement of the obsolete outlet.
10. Protect the power cord from being walked on or pinched particularly at plugs, convenience receptacles, and the point where they exit from the apparatus.
11. Only use attachments/accessories specified by the manufacturer.
12. Use only with the cart, stand, tripod, bracket, or table specified by the manufacturer, or sold with the apparatus. When a cart is used, use caution when moving the cart/apparatus combination to avoid injury from tip-over.
13. Unplug this apparatus during lightning storms or when unused for long periods of time.
14. Refer all servicing to qualified service personnel. Servicing is required when the apparatus has been damaged in any way, such as the power-supply cord or plug is damaged, liquid has been spilled or objects have fallen into the apparatus, the apparatus has been exposed to rain or moisture, does not operate normally, or has been dropped.



ADDITIONAL SAFETY INSTRUCTIONS

15. Do not overload wall outlets; extension cords, or integral convenience receptacles as this can result in a risk of fire or electric shock.
16. Never expose the apparatus to dripping or splashing or place items such as vases, aquariums, any other item filled with liquid, or candles on top of the unit.
17. Keep your fingers well clear of the disc tray as it is closing. Neglecting to do so may cause serious personal injury.
18. Do not place anything on top of this unit.
19. Do not place the apparatus on amplifiers or equipment that may produce heat.
20. Never block or cover the slots or openings in the unit. Never place the unit:
 - on a bed, sofa, rug or similar surface;
 - too close to drapes, curtains, or walls; or
 - in a confined space such as a bookcase, built-in cabinet, or any other place with poor ventilation.
21. Do not use a cracked, deformed, or repaired disc. These discs are easily broken and may cause serious personal injury and apparatus malfunction.
22. If the apparatus should emit smoke or an unusual odor, immediately disconnect the power cord from the wall outlet. Wait until the smoke or smell stops, then ask your dealer for a check and repair. Neglecting to do so may cause fire.
23. During thunderstorms, do not touch the connecting cables or the apparatus.
24. Warning: To prevent spread of fire, keep candles or other open flames away from this product at all times.

Location of the required label

The rating plate and the safety caution are on the rear of the unit.

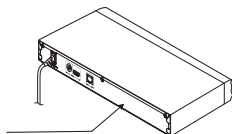

Disclaimer

I. HEALTH/SAFETY-RELATED IMPORTANT SAFETY INFORMATION CONCERNING 3D VIEWING

- If you or any viewer experiences the following symptoms or any other discomfort from viewing 3D video images, stop viewing and contact your health care provider: **Convulsions, Eye or muscle twitching, Loss of awareness, Altered vision, Involuntary movements, Disorientation, Eye Strain, Nausea/Vomiting, Dizziness, Headaches, or Fatigue.**
- If you feel eye fatigue or other discomfort from viewing 3D video images, stop viewing and take a rest until the condition is eliminated.
- Due to the possible impact on vision development, viewers of 3D video images should be age 6 or above. Children and teenagers may be more susceptible to health issues associated with viewing in 3D and should be closely supervised to avoid prolonged viewing without rest.
- Avoid use of the 3D function when under the influence of alcohol.
- Watching the screen while sitting too close for an extended period of time may cause eye strain. Consult your display manual to determine the ideal viewing distance.

Products that earn the ENERGY STAR prevent green house gas emissions by meeting strict energy efficiency guidelines set by the U.S. Environmental Protection Agency and the U.S. Department of Energy. ENERGY STAR and the ENERGY STAR mark are registered U.S. marks.



- Viewing in 3D may cause dizziness and/or disorientation for some viewers. Therefore, to avoid injury do not place your player or display near open stairwells, balconies, or wires and do not sit near objects that could be broken if accidentally hit.
- Carefully read instructions provided with your display and/or 3D glasses before 3D viewing.

II. PERFORMANCE RELATED

- This product is designed to playback Blu-ray™ Discs that comply with the 3D specifications of Blu-ray Disc™ Association. It is not compatible with other 3D specifications.
- 3D capable display, 3D eyewear and High Speed HDMI® cable (all sold separately) required for playback and viewing 3D content.
- If you route your signal through an AV receiver or other video distribution device they must be 3D capable to support 3D viewing. Viewing HD content and up-converting DVD content may require an HDCP capable input on your display device.
- Because the Blu-ray™ format and 3D specifications use new technologies, certain disc, content, connection and other compatibility and/or performance issues are possible. If you experience such issues, please refer to www.support.toshiba.com for information on the availability of firmware updates that may resolve your problem, or contact Toshiba Customer Solutions.

USA Federal Communications Commission Statement FCC Compliance Statement

This device complies with Part 15 of the FCC Rules. Operation is subject to the following two conditions: (1) This device may not cause harmful interference, and (2) This device must accept any interference received, including interference that may cause undesired operation.

Interference

This equipment has been tested and found to comply with the limits for a Class B digital device, pursuant to Part 15 of the FCC Rules. These limits are designed to provide reasonable protection against harmful interference in a residential installation. This equipment generates, uses, and can radiate radio frequency energy and, if not installed and used in accordance with the instructions, may cause harmful interference to radio communications. However, there is no guarantee that interference will not occur in a particular installation. If this equipment does cause harmful interference to radio or television reception, which can be determined by turning the equipment off and on, the user is encouraged to try to correct the interference by one of the following measures:

- Reorient or relocate the receiving antenna.
- Increase the separation between the equipment and receiver.
- Connect the equipment into an outlet on a circuit different from that to which the receiver is connected.
- Consult the dealer or an experienced radio/TV technician for help.

Wireless Radio

For product available in the USA/Canada market, only channel 1-11 can be operated. Selection of other channels is not possible. The device could automatically discontinue transmission in case of absence of information to transmit, or operational failure. Note that this is not intended to prohibit transmission of control or signaling information or the use of repetitive codes where required by the technology. If this device is going to be operated in 5.15-5.25GHz frequency range, then it is restricted to an indoor environment only.

PRECAUTIONS

Notes on handling

- When shipping the Blu-ray Disc™/DVD player, the original shipping carton and packing materials come in handy. For maximum protection, repack the unit as it was originally packed at the factory. Take care not to give it a shock or shake when carrying.
- Do not use volatile liquids, such as insect spray, near the Blu-ray Disc™/DVD player. Do not leave rubber or plastic products in contact with the Blu-ray Disc™/DVD player for a long time. They will leave marks on the finish.
- The top and rear panels of the Blu-ray Disc™/DVD player may become warm after a long period of use. This is not a malfunction.
- When the Blu-ray Disc™/DVD player is not in use, be sure to remove the disc and turn off the power.
- If you do not use the Blu-ray Disc™/DVD player for a long period, the unit may not function properly in the future. Turn on and use the Blu-ray Disc™/DVD player occasionally.

Important: Any changes or modifications not expressly approved by the party responsible for compliance could void the user's authority to operate this equipment. This device and its antenna(s) must not be co-located or operating in conjunction with any other antenna or transmitter.

FCC Radiation Exposure Statement

This equipment complies with FCC radiation exposure limits set forth for an uncontrolled environment. This equipment should be installed and operated with minimum distance 20cm between the radiator & your body.

Canada Industry Canada Statement

This device complies with RSS-210.

Operation is subject to the following two conditions:

- (1) This device may not cause harmful interference, and
- (2) This device must accept any interference received, including interference that may cause undesired operation of the device. This device and its antenna(s) must not be co-located or operating in conjunction with any other antenna or transmitter.

Wireless Radio

For product available in the USA/Canada market, only channel 1-11 can be operated. Selection of other channels is not possible. The device could automatically discontinue transmission in case of absence of information to transmit, or operational failure. Note that this is not intended to prohibit transmission of control or signaling information or the use of repetitive codes where required by the technology.

Important: Any changes or modifications not expressly approved by the party responsible for compliance could void the user's authority to operate this equipment.

IMPORTANT NOTE:

IC Radiation Exposure Statement: This equipment complies with IC RSS-102 radiation exposure limits set forth for an uncontrolled environment. This equipment should be installed and operated with minimum distance 20cm between the radiator & your body.

Notes on locating

Place the Blu-ray Disc™/DVD player on a level surface. Do not use it on a shaky or unstable surface such as a wobbling table or inclined stand. The loaded disc may come off the proper position and cause damage to the Blu-ray Disc™/DVD player.

When you place this Blu-ray Disc™/DVD player near a TV, radio, or VCR, the playback picture may become poor and the sound may be distorted. In this case, place the Blu-ray Disc™/DVD player away from the TV, radio, or VCR.

Do not use this player in places which are extremely hot, cold, dusty or humid.

Do not restrict the air flow of this player by placing it somewhere with poor air flow, by covering it with a cloth, or by placing it on bedding or carpeting.

Be sure to remove the disc and unplug the AC power cord from the outlet before carrying the player.

Notes on cleaning

Use a soft, dry cloth for cleaning.

- For stubborn dirt, soak the cloth in a weak detergent solution, wring well and wipe. Use a dry cloth to wipe it dry. Do not use any type of solvent, such as thinners and benzene, as they may damage the surface of the Blu-ray Disc™/DVD player.
- If you use a chemical saturated cloth to clean the unit, follow that product's instructions.

Inspection and Maintenance

This Blu-ray Disc™/DVD player is a high technology, precision device. If the optical pick-up lens and disc drive parts become dirty or worn down, the picture quality may be reduced. To avoid reduction in picture quality, it is recommended that regular inspection and maintenance (cleaning or parts replacement) be performed every 1,000 hours of use. For further details, contact your nearest consumer electronics dealer.

Notes on moisture condensation

Moisture condensation damages the Blu-ray Disc™/DVD player. Please read the following carefully.

Moisture condensation occurs, for example, when you pour a cold drink into a glass on a warm day. Drops of water form on the outside of the glass. In the same way, moisture may condense on the optical pick-up lens inside this unit, one of the most crucial internal parts of the Blu-ray Disc™/DVD player.

Moisture condensation occurs during the following cases.

When you bring the Blu-ray Disc™/DVD player directly from a cold place to a warm place.

When you use the Blu-ray Disc™/DVD player in a room where you just turned on the heater, or a place where the cold wind from the air conditioner directly hits the unit.

In summer, when you use the Blu-ray Disc™/DVD player in a hot and humid place just after you move the unit from an air conditioned room.

When you use the Blu-ray Disc™/DVD player in a humid place.

Do not use the Blu-ray Disc™/DVD player when moisture condensation may occur.

If you use the Blu-ray Disc™/DVD player in such a situation, it may damage discs and internal parts. Remove the disc, connect the power cord of the Blu-ray Disc™/DVD player to the wall outlet, turn on the Blu-ray Disc™/DVD player, and leave it for two or three hours. After two or three hours, the Blu-ray Disc™/DVD player will have warmed up and evaporated any moisture. Keep the Blu-ray Disc™/DVD player connected to the wall outlet and moisture condensation will seldom occur.

On Safety

Do not handle the AC power cord with wet hands and do not put your fingers or objects into the player.

When connecting or disconnecting the AC power cord, grip the plug and not the cord itself. Pulling the cord may damage it and create a hazard.

When you are not going to use the unit for a long period of time, disconnect the AC power cord.

On Recycling

This unit's packaging materials are recyclable and can be reused. Please dispose of any materials in accordance with your local recycling regulations.

Batteries should never be thrown away or incinerated but disposed of in accordance with your local regulations concerning chemical wastes.

NOTES ON DISCS

On handling discs

Do not touch the playback side of the disc.



Do not attach paper or tape to discs.



On cleaning discs

Fingerprints and dust on the disc cause picture and sound deterioration. Wipe the disc from the center outwards with a soft cloth. Always keep the disc clean.



If you cannot wipe off the dust with a soft cloth, wipe the disc lightly with a slightly moistened soft cloth and finish with a dry cloth.

Do not use any type of solvent such as thinner, benzene, commercially available cleaners or antistatic spray for vinyl LPs. It may damage the disc.

On storing discs

Do not store discs in a place subject to direct sunlight or near heat sources.

Do not store discs in places subject to moisture and dust such as a bathroom or near a humidifier.

Store discs vertically in a case. Stacking or placing objects on discs outside of their case may cause warping.

COPYRIGHT

This guide is copyrighted by Toshiba America Information Systems, Inc. with all rights reserved. Under the copyright laws, this guide cannot be reproduced in any form without the prior written permission of Toshiba. No patent liability is assumed,

however, with respect to the use of the information contained herein.

©2012 by Toshiba America Information Systems, Inc. All rights reserved.

Trademarks

AVCHD and the AVCHD logo are trademarks of Panasonic Corporation and Sony Corporation.

Blu-ray Disc™, Blu-ray™, Blu-ray 3D™, BD-Live™ and BONUSVIEW™ and the logos are trademarks of the Blu-ray Disc Association.

CinemaNow is a registered trademark of Best Buy, Inc.

DLNA®, the DLNA Certification Logo and DLNA CERTIFIED™ are trademarks, service marks, or certification marks of the Digital Living Network Alliance.



Manufactured under license from Dolby Laboratories. Dolby, Pro Logic, and the double-D symbol are trademarks of Dolby Laboratories.



Manufactured under license under U.S. Patent Nos: 5,956,674; 5,974,380; 6,226,616; 6,487,535; 7,392,195; 7,272,567; 7,333,929; 7,212,872 & other U.S. and worldwide patents issued & pending. DTS-HD, the Symbol, & DTS-HD and the Symbol together are registered trademarks & DTS-HD Master Audio | Essential is a trademark of DTS, Inc. Product includes software. © DTS, Inc. All Rights Reserved.

DVD is a trademark of DVD Format/Logo Licensing Corporation.



HDMI, the HDMI logo, and High-Definition Multimedia Interface are trademarks or registered trademarks of HDMI Licensing LLC in the United States and other countries.

Hulu Plus is a trademark of Hulu, LLC.

Microsoft, Outlook, Windows, and Windows Media are either registered trademarks or trademarks of Microsoft Corporation in the United States and/or other countries.



Windows Media and the Windows logo are trademarks or registered trademarks of Microsoft Corporation in the United States and/or other countries.

Netflix is a registered trademark of Netflix, Inc.



Oracle and Java are registered trademarks of Oracle and/or its affiliates. Other names may be trademarks of their respective owners.

Pandora is a registered trademark of Pandora Media, Inc.

Picasa is a trademark of Google, Inc.

VUDU is a registered trademark of VUDU, Inc.

The Wi-Fi CERTIFIED Logo is a certification mark of the Wi-Fi Alliance. The Wi-Fi Protected Setup Mark is a mark of the Wi-Fi Alliance.

"x.v.Color" and "x.v.Color" logo are trademarks of Sony Corporation.

YouTube is a registered trademark of Google Inc.

All other brand and product names are trademarks or registered trademarks of their respective companies.

Introduction

Safety icons

This guide contains safety instructions that must be observed to avoid potential hazards that could result in personal injuries, damage to your equipment, or loss of data. These safety cautions have been classified according to the seriousness of the risk, and icons highlight these instructions as follows:

▲ DANGER Indicates an imminently hazardous situation which, if not avoided, will result in death or serious injury.

▲ WARNING Indicates a potentially hazardous situation which, if not avoided, could result in death or serious injury.

▲ CAUTION Indicates a potentially hazardous situation which, if not avoided, may result in minor or moderate injury.

CAUTION Indicates a potentially hazardous situation which, if not avoided, may result in property damage.







NOTE Provides important information.

Package contents

- ❖ Remote Control (SE-R0418) with Batteries (1 set of 2 AAA)
- ❖ User's Guide (this manual)
- ❖ Quick Start Guide

Symbols used in this manual

The following symbols indicate the corresponding operation.

<i>Symbol:</i>	<i>Operation:</i>
	Blu-ray™ Video and BD-RE/BD-R recorded in BDMV format
	DVD-video
	Audio CD/DTS®-CD
	DVD-RW/-R with AVCHD™ files
	BD-R/BD-RE, DVD-RW/-R and CD-RW/-R with MP3 files
	BD-R/BD-RE, DVD-RW/-R and CD-RW/-R with WMA files
	BD-R/BD-RE, DVD-RW/-R and CD-RW/-R with JPEG files

NOTE

If any of the symbols listed above are not displayed under the function heading, the operation is applicable to all media.

Features

Blu-ray Disc™: Enjoy Blu-ray Disc™ viewing and storage, capable of storing five times more data than a conventional DVD.

Blu-ray 3D™ Feature: This product can play 3D content, using an HDMI® cable. To implement the 3D effect, connect a 3D device (3D-compliant AV receiver, 3D-compliant TV) to the product using an HDMI® cable, and play the 3D content while wearing 3D vision glasses.

BD-Java™: Enjoy the interactive functions such as games or interactive menus, supported Java™ applications.

BD-Live™: BD-ROM version 2 Profile 2.0 allows interactive functionality when this player is connected to the Internet, in addition to the BONUSVIEW™ function. The various functions differ depending on the disc type.

Full high-definition video playback: Watch movies in the highest picture quality available for your HDTV. This player offers full high-definition video playback up to 1080p resolution for an amazing viewing experience. A highly detailed picture and increased sharpness delivers a more true-to-life picture.

DVD Upconversion for enhanced picture quality: Your current DVD will look even better than before thanks to video upconversion. Upconversion will increase the resolution of standard definition DVD to near high definition up to 1080p over an HDMI® connection. The picture will be less jagged and more realistic for a near high-definition experience.

Enjoy your content on different kinds of media: Full backwards compatibility with Blu-ray Disc™, DVD and CD ensures that you can continue to enjoy your current audio-video collection. Additionally, you can view JPEG digital pictures or listen to MP3 or Windows Media™ Audio music files.

PIP: Some Blu-ray™ Videos have the PIP function which enables you to display the secondary video in the primary video. You can call up the secondary video by pressing **PIP** on the remote whenever the scene contains the secondary video.

Pop-up menu: Some Blu-ray™ Video have pop-up menu which is a navigation menu that can be called up and be operated on the TV screen without interrupting the playback. You can call up the pop-up menu by pressing **POP UP** or **TOP MENU** on the remote. Contents in the pop-up menu vary depending on the disc.

Playing back AVCHD™ files: This player supports playback of AVCHD™ format files (new format for high definition video camcorders) recorded on disc. Your high definition personal archive is playable in HD quality.

x.v.Color™: This player supports playback of video contents on discs recorded with “x.v.Color®” technology. To watch this video content with the “x.v.Color®”, a TV or other display device supporting both video image reproduction using the “x.v.Color®” standard and capable of manually switching its color setting is required. Refer to the User’s Guide of your display device for further information.

Wi-Fi CERTIFIED® (for model BDX5300KU only): The Wi-Fi CERTIFIED® logo is an assurance that Wi-Fi® Alliance has tested a product in numerous configurations and with a diverse sampling of other devices to ensure compatibility with other Wi-Fi CERTIFIED® equipment that operates in the same frequency band.

Easy and simple connection to your HDTV via HDMI®: Connect this player to your HDTV with one single HDMI® (High-Definition Multimedia Interface) cable. It is recommended to use a High Speed HDMI® Cable for better compatibility. The high definition video output signal will be transferred to your HDTV without conversion to analog signals, so you will get excellent picture and sound quality.

HDMI®-CEC (Consumer Electronics Control): This player supports HDMI®-CEC, which allows integrated system control over HDMI® and is part of the HDMI® standard. This function may not work properly on some devices.

HDMI® 1080p/24F output (Blu-ray Disc™ only): This player is equipped with a feature which can provide the smooth movement in the playback of film originated material with the frame rate of 24 frames per second with progressive scan. (Available only when the TV is connected by an HDMI® cable and compatible with 1080p/24F frame input.)

Copyright protection system: To play back the digital video images of a Blu-ray Disc™/DVD via an HDMI® connection, it is necessary that both the player and the TV (or an AV amplifier) support a copyright protection system called HDCP (high bandwidth digital content protection system). HDCP is copy protection technology that comprises data encryption and authentication of the connected AV device. This player supports HDCP. Refer the operating instructions of your TV (or AV amplifier) for more information.

Blu-ray Disc™/DVD player controls

Front panel

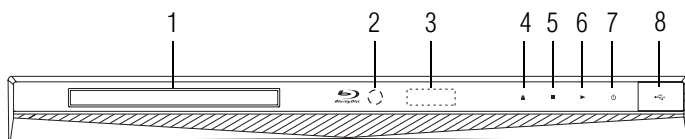

(Sample Illustration) Front panel controls

Item:	Operation:
1	Disc tray
2	Remote sensor
3	Display
4	Open/Close (▲) indicator. When the unit is on, the indicator glows white. Tap the indicator to open or close the disc tray.
5	Stop (■) indicator. When the unit is on, the indicator glows white. Tap the indicator to stop playback.
6	Play (▶) indicator. When the unit is on, the indicator glows white. Tap the indicator to start playback.
7	Power (⏻) On the remote control, press the POWER button to turn on the player (or place it into standby mode). NOTE: To completely turn the player off, you must unplug the AC power cord.
8	USB port cover and USB port Open the USB port cover to connect a USB flash drive/wireless LAN adapter (not included).

NOTE

These indicators are located in the sensor field.

When this unit is off, these indicators dim. If your finger is close to the sensor field, the indicators will light up.

Power on the Unit

- 1 Connect the power cord to a standard AC outlet to supply power to the unit. The ON/STANDBY indicators glow red and then white. The OPEN/CLOSE, STOP, and PLAY indicators also glow white and "OFF" appears on the display.
- 2 After approximately 10 seconds, only the ON/STANDBY indicator remains in white and the unit is in standby mode.
- 3 Touch the ON/STANDBY button to turn on the unit and it will display "ON" on the front panel.

Back panel

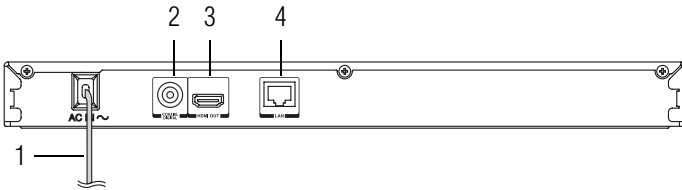

(Sample Illustration) Back panel connections

Item:	Description	Function:
1	AC power cord	Connects to a standard AC outlet to supply power to the player. To completely turn off the player, unplug the AC power cord.
2	Coaxial Digital Audio Out port	Connects an AV receiver/amplifier, Dolby® Digital/DTS® decoder, or other device using a coaxial digital audio cable.
3	HDMI® Out port	Connects to a TV with an HDMI® compatible port via an HDMI® cable. HDMI® connection is required for this player to operate properly. (HDMI® cable sold separately). NOTE: Analog connection is not supported.
4	LAN port	Connects network capable external devices.

Remote control buttons

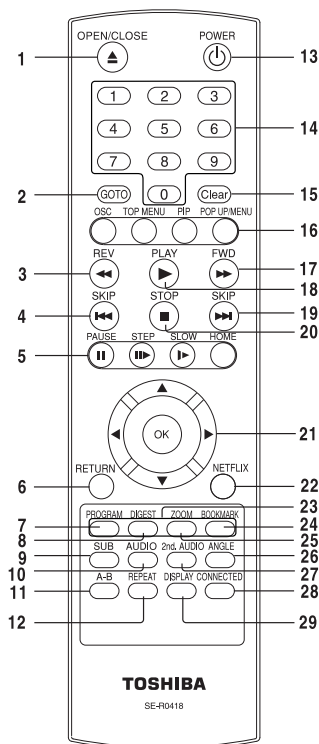

(Sample Illustration) Remote control buttons

Item:	Description:	Operation:
1	OPEN/CLOSE	Press to open or close the disc tray.
2	GOTO	Press to display the search menu.
3	REV	During playback, press to fast reverse the playback.
4	SKIP	During playback, press once to return to the beginning of the current title, chapter, track or file. During playback, press twice to return to the previous title, chapter, track or file. During the JPEG playback, press to return to the previous file.

<i>Item:</i>	<i>Description:</i>	<i>Operation:</i>
5	PAUSE	Press to pause playback.
	STEP	Press to advance one frame.
	SLOW	Press to play back in the disc slow motion.
	HOME	Press to display HOME menu.
6	RETURN	Press to return to the previous menu.
7	PROGRAM	Press to create program list for DVD/CD disc.
8	DIGEST	Press to display the thumbnail view for JPEG.
9	SUB (Subtitle)	Press to select the subtitle language.
10	AUDIO	Press to select the audio language.
11	A-B	Press to play back a defined section between point A and B repeatedly.
12	REPEAT	Press to toggle between various repeat modes.
13	POWER	Press to turn on the unit, or to turn the unit into the standby mode. (To completely turn off the unit, you must unplug the power cord.)
14	Number buttons	In playback mode, press GOTO, then input the numbers using the 0-9 number buttons to enter a title, chapter, track, time or file number. In menu mode, use the number buttons to enter the parental code password.
15	CLEAR	Press to clear an input error.
16	OSC	Press to display the OSC (On Screen Control) menu.
	TOP MENU	Press to display a top menu.
	PIP	Press to switch picture-in-picture feature on or off (only applicable to Blu-ray™ Video which supports the PIP function).
	POP UP/MENU	During Blu-ray Disc™ playback, press to open a menu that lets you control Blu-ray Disc™ playback. During DVD playback, press to open the DVD menu (if available).
17	FWD	During playback, press to fast forward the playback.
18	PLAY	Press to start playback or resume playback.
19	SKIP	During playback, press to skip to the next title, chapter, track or file. During the JPEG playback, press to go to the next file.
20	STOP	Press to stop playback.
21		Press to select items or settings.
	OK	Press to confirm or select menu items.
22	NETFLIX®	Press to use Netflix service directly. (Make sure your Blu-ray Disc™/DVD player is correctly connected to the Internet and network settings are properly configured.)
23	RED/GREEN/ YELLOW/BLUE	Press to select items on some Blu-ray Disc™ contents. When file list/thumbnail list is shown, press to switch between pages.

Item:	Description:	Operation:
24	BOOKMARK	Press to set your favorite bookmark for DVDs.
25	ZOOM	Press to zoom the image In/Out for DVD/JPEG discs.
26	ANGLE	Press to select a viewing angle if multiple angles are available on the disc.
27	2nd. AUDIO	In PIP mode, press to turn the audio for the secondary video On/Off.
28	CONNECTED	Press to display the CONNECTION menu.
29	DISPLAY	Press to display operating status.

Installing the batteries

Install the batteries (AAAx2), matching the polarity indicated inside battery compartment of the remote control.

- 1 Open the battery cover.

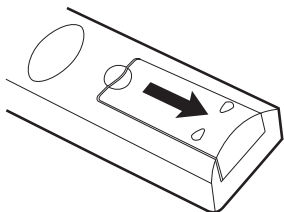

(Sample Illustration) Remote control - Opening the battery cover

- 2 Insert batteries.

Make sure to match the polarity marks (+ / -) on the batteries to the marks indicated in the battery compartment.

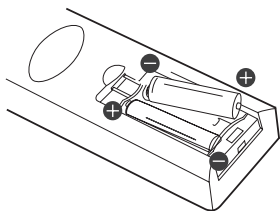

(Sample Illustration) Remote control - inserting the batteries

- 3 Replace the battery cover.

CAUTION

Always dispose of used batteries in compliance with your local government.
Never throw batteries into a fire.

NOTE

Do not mix different battery types or combine used batteries with new ones.

If the remote control does not operate correctly, or if the operating range is reduced, replace both batteries with new ones.

If the batteries are dead or if you will not be using the remote control for a long time, remove the batteries to prevent battery acid from leaking into the battery compartment.

Battery shall not be exposed to excessive heat such as sunshine, fire or the like.

Danger of explosion if battery is incorrectly replaced. Replace only with the same or equivalent type.

When discarding batteries, environmental problems must be considered and local rules or laws governing the disposal of these batteries must be strictly followed.

Using the remote control

Point the remote control at the remote sensor and press the buttons:

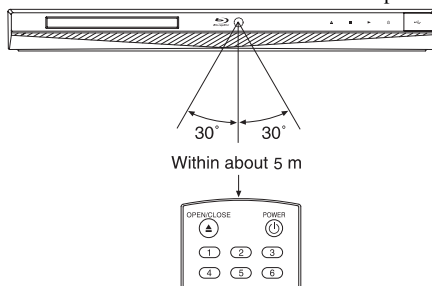

(Sample Illustration) Remote control angle

Distance: Approximately 5m from the front of the remote sensor.

Angle: About 30° in each direction from the front of the remote sensor.

CAUTION

Do not expose the remote sensor to a strong light source such as direct sunlight or other illumination. This can damage the sensor resulting in the inability to operate the Blu-ray Disc™/DVD player via the remote control.

CAUTION

Do not drop or expose the remote control to electric shock.

Do not expose the remote control excessively hot or humid places.

Do not spill water or place anything wet on the remote control.

Do not open the remote control.

If the remote control is not going to be used for a long period of time, remove the battery to avoid damage caused by battery leakage corrosion.

NOTE

Direct the remote control at the remote sensor of the Blu-ray Disc™/DVD player.

When using the remote control, press the buttons at intervals of approximately 1 second to ensure the correct mode of operation.

Blu-ray Disc™/DVD player connections

Connecting to a TV using an HDMI® cable

This connection provides better picture quality and supports up to 1080i/1080p, 1080p/24F resolution.

Connect an HDMI® cable from the HDMI® output jack on the player to the HDMI® input jack on the TV.

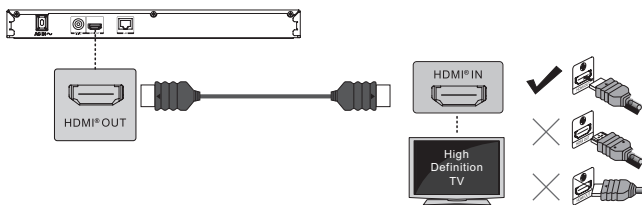

(Sample Illustration) Connecting to a TV - HDMI® cable

NOTE

To enjoy viewing 3D content, an HDMI® connection with a High Speed HDMI® cable is required. (HDMI® cable sold separately).

Analog connection is not supported.

Do not tilt the connector when inserting it into the HDMI® jack, and make sure the shapes of the jack and the connector are matched.

When using a non-HDCP compatible TV, the image may not display properly.

An HDMI® cable carries both video and audio signals. If you wish to use TV speakers, you do not need to make an additional audio connection if you are using an HDMI® cable.

Connecting to a digital amplifier/AV receiver

Route the sound from this player to other device to enhance audio output.

- ❖ Connect a coaxial cable from the Coaxial Digital jack on the player to the Coaxial jack on the device.
- ❖ If your AV receiver or amplifier has an HDMI® jack, you can also connect the HDMI® cable to the HDMI IN jack on your AV receiver or amplifier.

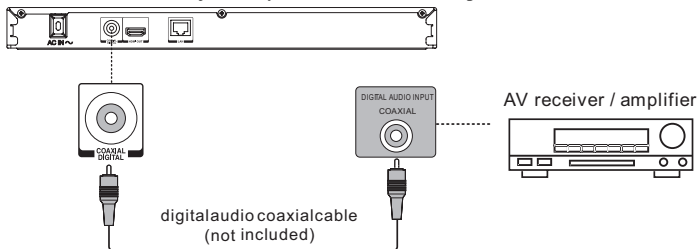

(Sample Illustration) Connecting to a digital amplifier/AV receiver

Connecting to a network

Your Blu-ray Disc™/DVD player can be connected to your home network:

- ❖ By using a wired network. This provides the best performance, because the attached device and player are connect directly to the network and are not subject to radio frequency interference.
- ❖ By connecting through a wireless LAN adaptor and a wireless access point or router (for BDY4300KU model).
- ❖ By connecting through the built-in wireless device and a wireless access point or router (for BDY5300KU model).

Connecting via wired router

Connect one end of an Ethernet cable (CAT5 or better with RJ45 connector) to the Ethernet jack on the front of your player, and the other end to a wired hub or broadband router.

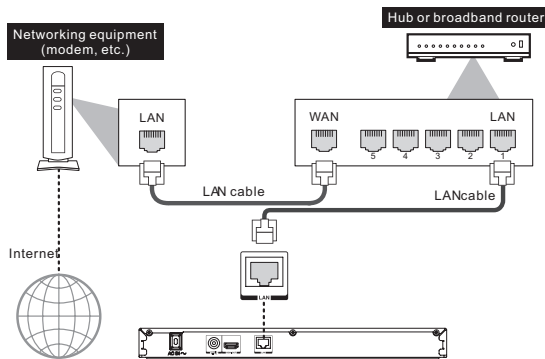

(Sample Illustration) Connecting to a wired router

NOTE

Do not connect a modular phone cable to the Ethernet jack.

When plugging or unplugging the cable, hold the connector on the end of the cable.

When unplugging, do not pull on the cable. Press down the lock tab, and then pull the connector out of the jack.

Because there are various connection configurations, follow the instructions from your telecommunication carrier or Internet service provider.

Connecting via wireless access point or router - for BDY4300KU model

Your Blu-ray Disc™/DVD player can also be connected to a network via Wireless access point.

NOTE

USB Wi-Fi® adapter is not included and is required for a wireless connection.

This unit is compatible with TOSHIBA's USB Wi-Fi® adapter only. Model name: WLM-12NB1.

A wireless AP/IP router is required to create a wireless network connection.

- 1 Connect the wireless LAN adapter to the USB port on the front panel of the Blu-ray Disc™/DVD player, and set the wireless network options.
- 2 After the Wi-Fi® device is inserted into the USB port, press the (▲/▼) arrow buttons to select **Network** from the Settings menu, and press the **OK** button to enter.

For detailed information, refer to the device's User's Guide for WLM-12NB1.

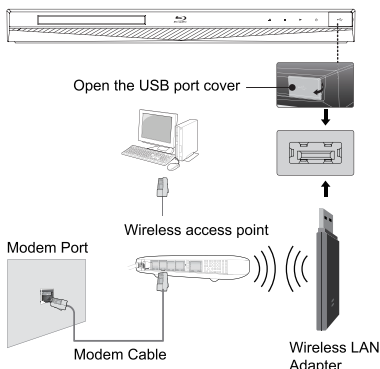

(Sample Illustration) Connecting to a wireless router

Connecting your player to a wireless access point or router - for BDX5300KU model

Your Blu-ray Disc™/DVD player has an integrated Wi-Fi® device and antenna. No physical connection to the wireless router is necessary.

- 1 Configure your player to access the wireless access point or router.
- 2 The network configuration and connection method may vary depending on the equipment in use and the network environment. Your Blu-ray Disc™/DVD player is equipped with an IEEE 802.11n wireless module, which also supports the 802.11 a/b/g/n standards. For the best wireless performance, we recommend using an IEEE 802.11n certified Wi-Fi® network (access point or wireless router).

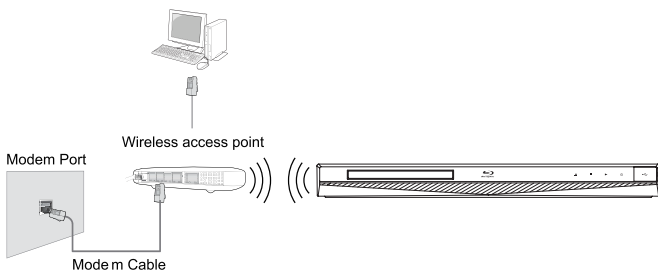

(Sample Illustration) Connecting to a wireless router

NOTE

You must use a wireless IP sharer that supports IEEE 802.11 a/b/g/n. (n is recommended for stable operation of the wireless network.)

Wireless LAN, in its nature, may cause interference, depending on the use condition (AP performance, distance, obstacle, interference by other radio devices, etc.).

Set the wireless IP sharer to Infrastructure mode. Ad-hoc mode is not supported.

When applying the security key for the AP (wireless IP sharer), only the following is supported.

1. Authentication Mode: WPAPSK, WPA2PSK
2. Encryption Type: WEP, TKIP, AES

Connecting a USB flash drive

A USB flash drive provides additional capacity for software upgrades. You can also enjoy playing AVCHD™/MP3/WMA/JPEG and movie files you have stored on the USB flash drive. Insert a USB flash drive into the USB port on the front of Blu-ray Disc™/DVD player.

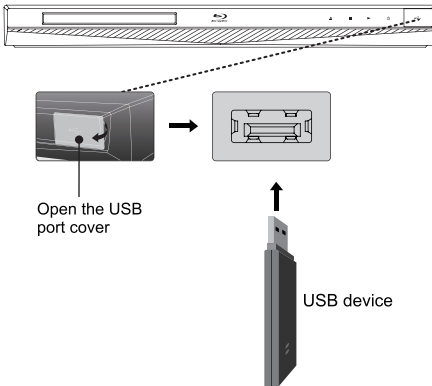

(Sample Illustration) Connecting a flash drive

NOTE

Connect only a USB flash drive to the USB port on this product.

If you cannot easily insert the USB flash drive, you may have inserted it incorrectly. Try to turnover the device and then insert again.

Do not remove the USB flash drive during playback.

BD-Live™: Access to BD-Live™ requires use of USB flash drive (not included) installed in the USB port. For additional information regarding the access to BD-Live™, see page 38 of the manual.

TOSHIBA does not guarantee 100% compatibility with all USB flash drives.

NOTE

If you want to enjoy BD-Live™ bonus content, you should connect a USB flash drive to the USB port, and an Ethernet cable to the Ethernet jack on the back of your player and to an Ethernet jack on a hub or broadband router.

Blu-ray Disc™ playback

Before you start disc playback, read the following information.

NOTE**Cinavia Notice**

This product uses Cinavia technology to limit the use of unauthorized copies of some commercially-produced film and videos and their soundtracks. When a prohibited use of an unauthorized copy is detected, a message will be displayed and playback or copying will be interrupted.

More information about Cinavia technology is provided at the Cinavia Online Consumer Information Center at <http://www.cinavia.com>. To request additional information about Cinavia by mail, send a postcard with your mailing address to: Cinavia Consumer Information Center, P.O. Box 86851, San Diego, CA, 92138, USA.









Disc and file playback

This player is compatible with the following discs/files.

To play back a disc/file, make sure that it meets the requirements for region codes and color systems as described below. You can play discs that have the following logos.

NOTE

Other disc types are not guaranteed to play back.

<i>Logos:</i>	<i>Playable discs:</i>
	Blu-ray Disc™ BD-ROM (single/dual layer) BD-RE (single/dual layer) (Recorded in BDMV format) BD-R (single/dual layer) (Recorded in BDMV format) (Unclosed discs may not be played back.)
	DVD-ROM
	DVD-RW
	DVD-R
	CD-DA (audio CD)
 	CD-RW
 	CD-R
-	DTS®-CD
<i>Playable files:</i>	<i>Media:</i>
AVCHD™	DVD-RW/-R
MP3	BD-R/BD-RE, DVD-RW/-R, CD-RW/-R
Windows Media™ Audio	
JPEG	
MPG	
AVI	

This player cannot play back disc content that is protected by Windows Media™ Digital Rights Management (DRM).

Un-playable discs and files

The following disc types will not play back in this player.

- ❖ CD-ROM
- ❖ CD-I (compact disc-interactive)
- ❖ DVD-RAM
- ❖ VSD (video single disc)
- ❖ DVD-audio
- ❖ HD DVD
- ❖ VIDEO CD
- ❖ Un-finalized disc
- ❖ Blu-ray Disc™/DVD containing DivX® files
- ❖ Blu-ray Disc™/DVD hybrid disc (played back as a Blu-ray™ Video only)
- ❖ Blu-ray Disc™ that contains AVCHD™ files
- ❖ DVD-RW/-R recorded in non compatible recording format
- ❖ Super Audio CD. Only the sound on the CD layer can be heard. The sound on the high-density Super Audio CD layer cannot be heard.
- ❖ Playability of dual discs are not guaranteed
- ❖ Multi session disc
- ❖ Multi border disc

Region codes

This player has been designed to play back Blu-ray™ Video with region “A” and DVD-video with region “1” or “ALL.” You cannot play back Blu-ray™ Video or DVD-video that are labeled for other regions. Look for the symbols on your Blu-ray™ Video or DVD-video.

If these region symbols do not appear on your Blu-ray™ Video or DVD-video, you cannot play back the disc in this player. The letter or number inside the globe refers to region of the world. A Blu-ray™ Video or DVD-video labeled for a specific region can only be played back in the player with the same region code.



BD-video



DVD-video

(Sample Illustration) Region Codes

Color system

Blu-ray™ Video and DVD-video are recorded in different color systems throughout the world. The most common color system is NTSC (which is used primarily in the United States and Canada).

Disc contents structure

The contents of Blu-ray Disc™/DVD/AVCHD™ are generally divided into titles. Titles may be further subdivided into chapters.

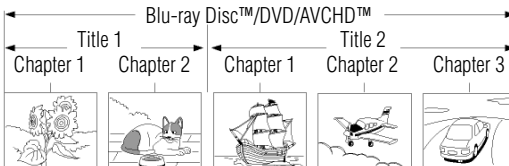

(Sample Illustration) Sample structure of disc contents - chapters and titles

An audio CD is divided into tracks.



(Sample Illustration) Audio CD track structure

Data discs or USB flash drives containing MP3/WMA/JPEG are divided into folders, and the folders are subdivided into files.

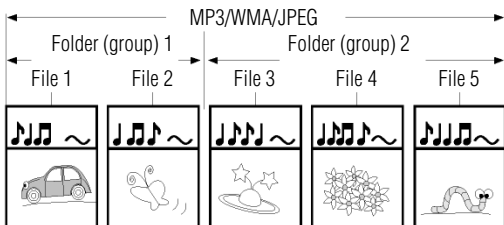

(Sample Illustration) Data disc/USB file structure

Basic playback

When you wish to view a disc, turn the TV On and select the video input connected to the Blu-ray Disc™/DVD player.

- 1 Press the **POWER** (⏻) button.
The Blu-ray Disc™/DVD player turns on.
- 2 Press the **OPEN/CLOSE** (⏮) button.
The disc tray opens.

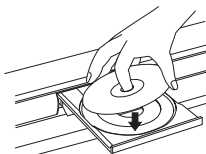

(Sample Illustration) Placing the disc on the disc tray

- 3 Place the disc on the disc tray with the playback side facing down.

CAUTION Keep your fingers clear of the disc tray as it is closing. Neglecting to do so may cause serious personal injury.

- 4 Tap the **OPEN/CLOSE** (⏮) indicator on the front panel to close the disc tray.
Playback begins.

NOTE If you insert a Blu-ray Disc™ or a DVD that contains a top menu, a menu may appear. Press the (▲/▼/◀/▶) arrow buttons to select the title you wish to view, then press the **OK** button to begin playback.

You may need to press the **TOP MENU** or **POP UP/MENU** button to display the pop up menu / top menu / disc menu (depending on the actual Blu-ray disc™ or DVD.)

- 5 Tap the **PLAY** (▶) indicator on the front panel to begin playback in stop mode.

- 6 Press the **PAUSE** (⏸) button on the remote control during playback to pause playback in still mode.
- 7 Press the **PLAY** (▶) button on the remote control to resume normal playback.
The sound is muted during still mode.
- 8 Press the **STOP** (■) button on the remote control once to stop playback.
 - ❖ Blu-ray™ discs: The home menu appears.
Press the **PLAY** (▶) button to begin playback again or press the (▲/▼) arrow buttons to select BD-ROM, and then press the **OK** button to begin playback at the beginning of the disc.
 - ❖ DVDs/audio CDs: It will enter the stop mode.
Press the **PLAY** (▶) button to resume normal playback. Depending on the disc type, playback begins where it stopped or at the beginning of the disc.
- 9 During DVD/audio CD playback, if you press the **STOP** (■) button twice, playback stops completely and the home menu appears. Press the **PLAY** (▶) button to begin playback again or press the (▲/▼) arrow buttons to select DVD-ROM/CD, and then press the **OK** button to begin playback at the beginning of the disc.
- 10 Press the **OPEN/CLOSE** (⏏) button on the remote control to remove the disc.
- 11 Remove the disc after the disc tray opens completely.
- 12 Be sure to press the **OPEN/CLOSE** (⏏) button to close the disc tray after you remove the disc.
- 13 Press the **POWER** (⏻) button to turn the player Off.

Automatic power off function

When you leave the unit in stop mode for more than 5 minutes, the screen saver is activated if you set the Screen Saver to On mode. At the end of 25 minutes without any user interaction, the unit automatically switches off.

Variable speed playback

You can play discs at various speeds, and resume playback from the location you stopped playback.

Fast reverse/forward playback

- 1 Press the **Fast reverse playback** (◀◀) buttons or the **Fast forward playback** (▶▶) button during playback.

Each time you press the button, the fast-forward or fast-reverse speed progresses in the following sequence:

▶▶ 2x → ▶▶ 4x → ▶▶ 8x → ▶▶ 16x → ▶▶ 32x →
↑
◀◀ 2x → ◀◀ 4x → ◀◀ 8x → ◀◀ 16x → ◀◀ 32x →
↑

- 2 Press the **PLAY** (▶) button to resume normal playback.

NOTE

The Blu-ray Disc™/DVD player mutes sound and subtitles during reverse and forward scan. The playback speed may differ depending on the disc type.

Frame by frame playback

- 1 Press the **STEP** (⏮) button during still playback.
Each time you press this button, the picture advances one frame.
- 2 Press the **PLAY** (▶) button to resume normal playback.

NOTE

The sound is muted during frame by frame playback.

Slow motion playback

- 1 Press the **SLOW** (▶▶) button during playback.
Each time you press this button, the slow-motion speed progresses in the following sequence:

▶▶ 1/16 → ▶▶ 1/8 → ▶▶ 1/4 → ▶▶ 1/2 →
↑
└──┘

- 2 Press the **PLAY** (▶) button to resume normal playback.

NOTE The sound is muted during slow-motion playback.

Locating a desired section

Normally, Blu-ray™ Discs and DVDs are divided into titles, and the titles are sub-divided into chapters. Audio CDs are divided into tracks. You can quickly locate any specific title, chapter, or track.

Locating a title using TOP MENU/POP UP/MENU

- 1 Press the **TOP MENU/POP UP/MENU** button.
The top / pop up menu appears on the TV screen.
- 2 Press the (▲ / ▼ / ◀ / ▶) arrow buttons to select the title you wish to select.
If the titles in the top menu are assigned a number, you can directly locate a specific title by pressing its designated number with the number buttons on the remote control.
- 3 Press the **OK** button.
Playback begins from Chapter 1 of the selected title.

Locating a specific chapter or track

- 1 Press the **SKIP LEFT** (◀◀) or **SKIP RIGHT** (▶▶) button repeatedly to access the chapter or track number you wish to select.
Playback starts from the selected chapter or track.
- 2 Press the **SKIP LEFT** (◀◀) button to start playback from the beginning of the current chapter or track.
When you press twice in quick succession, playback starts from the beginning of the preceding chapter or track.
- 3 Press the **SKIP RIGHT** (▶▶) button to locate succeeding chapters or tracks.

NOTE Some titles may not display chapter numbers.

Accessing a specific location directly

Locating a specific time in a DVD

- 1 During playback, press the **GOTO** button and use the (▲ / ▼) arrow buttons to select **TT** (Title) or **CH** (Chapter). Then press the **OK** button.



(Sample Illustration) Locating a specific time

- 2 Press the (◀ / ▶) arrow buttons to move the cursor to the Hour, Minute or Second.
 - ❖ The first two numbers represent hours.
 - ❖ The second two numbers represent minutes.
 - ❖ The third two numbers represent seconds.
- 3 Press the (▲ / ▼) arrow buttons or the corresponding number buttons (0-9) for the time you want, then press the **OK** button to confirm.
Playback starts from the selected time.

Locating a specific title

- 1 During playback, press the **GOTO** button and use the (◀/▶) arrow buttons to move the cursor to **TT** (Title). Then press the **OK** button.



(Sample Illustration) Locating a specific title

- 2 Press the (▲/▼) arrow buttons or the corresponding number buttons (0-9) for the title you want. Then press the **OK** button to confirm.
Playback starts from the selected title.

Locating a specific chapter

- 1 During playback, press **GOTO** button and use the (◀/▶) arrow buttons to move the cursor to the chapter, then press the **OK** button.



(Sample Illustration) Locating a specific chapter

- 2 Press the (▲/▼) arrow buttons or the corresponding number buttons (0-9) for the chapter you want. Then press the **OK** button to confirm.
Playback starts from the selected chapter.

Locating a specific time in a CD

- 1 During playback, press the **GOTO** button and use the (▲/▼) arrow buttons to select **TRACK** or **DISC**. Then press the **OK** button.

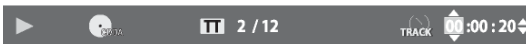

(Sample Illustration) Locating a specific time—CD

- 2 Press the (◀/▶) arrow buttons to move the cursor to the Hour, Minute or Second.
 - ❖ The first two numbers represent hours.
 - ❖ The second two numbers represent minutes.
 - ❖ The third two numbers represent seconds.
- 3 Press the (▲/▼) arrow buttons or the corresponding number buttons (0-9) for the time you want. Then press the **OK** button to confirm.
Playback starts from the selected time.

Locating a specific track

- 1 During playback, press **GOTO** button and use the (◀/▶) arrow buttons to move the cursor to **TT** (Track). Then press the **OK** button.



(Sample Illustration) Locating a specific track

- 2 Press the (▲/▼) arrow buttons or the corresponding number buttons (0-9) for the track you want. Then press the **OK** button to confirm.
Playback starts from the selected track.

Repeating a title, chapter, track or specific segment

Repeating a title, chapter or track

Press the **REPEAT** button repeatedly to select the desired repeat mode during playback.



(Sample Illustration) Selecting various repeat modes

NOTE The repeat setting will be cancelled when you stop playback.
The chapter, title or track repeat will be cleared when moving to another chapter, title, track/file.
Chapter and title repeat are not available with some scenes.

Repeating a specific segment

- 1 Press the **A-B** button at the desired starting point A during playback.
- 2 Press the **A-B** button at the desired ending point B during playback.

The Blu-ray Disc™/DVD player automatically returns to point A and starts repeat playback of the selected segment (A-B).

To resume normal playback press the **A-B** button and the A-B will disappear, meaning normal playback has resumed.

NOTE Some discs may not permit A-B repeat operation.
You can specify a segment only within the current title or track.
You cannot set the A-B repeat function for a segment that includes multiple camera angles.

PIP setting

Some Blu-ray™ discs have the PIP function enabling you to display the secondary video in the primary video. You can call up the secondary video by pressing the **PIP** button when the scene contains the secondary video. See the documentation that came with the disc for playback instructions.

- 1 Press the **PIP** button during playback to turn PIP mode On.
- 2 Press the **2nd. AUDIO** button to turn the audio for the video in the PinP window On/Off.

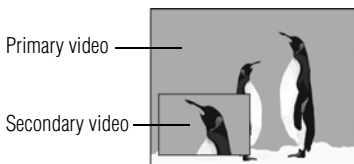

(Sample Illustration) PIP view function

- 3 Press the **PIP** button to turn PIP mode Off and resume normal playback.

NOTE Not all discs are available for PIP and 2nd Audio. It only applies to Blu-ray™ Discs that support picture-in-picture features and 2nd Audio.

Camera angle

Some Blu-ray™ Video and DVD-video contain scenes that have been shot simultaneously from various angles.

- 1 Press the **ANGLE** button during playback.
The selected angle is displayed on the display bar at the top of the TV screen.



Angle 1/3

(Sample Illustration) Selecting the desired angle

The first digit indicates the current viewing angle, and the second digit indicates the total number of viewing angles.

- 2 Press the **ANGLE** button repeatedly to select the desired angle.

Audio selection

- 1 Press the **AUDIO** button during playback.



1/2 English DTS-HD MA 5.1 CH

(Sample Illustration) Selecting the desired audio language

In the example “1/2 English DTS-HD® MA 5.1 CH”:

- ❖ “1” indicates the currently selected audio channel
- ❖ “2” indicates the total number of audio channels
- ❖ “English” indicates the audio language
- ❖ “DTS-HD® MA 5.1 CH” describes the currently selected audio format

- 2 Press **AUDIO** repeatedly to select the desired audio language.

NOTE The available options of Audio playback vary from depending on the disc format.

Subtitle selection

- 1 During playback, press **SUB**.



1 / 2 English

(Sample Illustration) Selecting the desired subtitle setting

- ❖ “1” indicates the currently selected subtitle.
- ❖ “2” indicates the total number of subtitles.
- ❖ “English” indicates the subtitle language.

- 2 Press **SUB** repeatedly to select the desired subtitle language.

The current subtitle setting is displayed.

To turn off the subtitle setting display, press the **SUB** button repeatedly until **Off** is displayed.

Playing in a favorite order

You can combine your favorite titles, chapters or tracks and play them in the order you determine. You can program up to 15 selections into the memory (Memory playback).

- 1 During playback, press the **PROGRAM** button.

The following display appears.



(Sample Illustration) DVD Program display

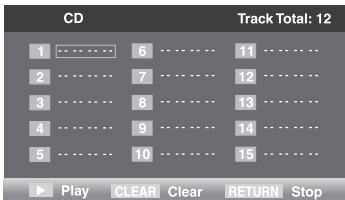

(Sample Illustration) CD Program display

- 2 Press the **OK** button and the TT (Title) is highlighted. Then press the ($\blacktriangle/\blacktriangledown$) arrow buttons or the corresponding number buttons to enter the Title (TT) (for DVD movie) or Track number (for audio CD).
- 3 Use the ($\blacktriangleleft/\blacktriangleright$) arrow buttons to highlight the CH (Chapter) and also press the ($\blacktriangle/\blacktriangledown$) arrow buttons or the corresponding number buttons to enter the Chapter (for DVD movie).

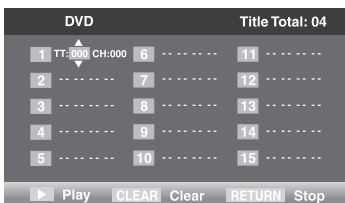

(Sample Illustration) DVD track number display

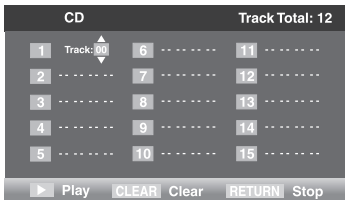

(Sample Illustration) CD track number display

- 4 Press the **PLAY** button to start memory playback.
To resume normal playback from memory playback
 - 1 Press the **PROGRAM** button.
 - 2 Press the **CLEAR** button repeatedly until all entered programs are cleared.
 - 3 Press the **PLAY** button to resume normal playback.

- NOTE** Some discs may not permit memory playback. The programmed selections will be cleared when you open the disc tray or turn off the unit. If you press the PROGRAM button while the display appears on the TV screen, the display disappears.

Digest playback

- 1 During JPEG playback, press the **DIGEST** button. A thumbnail view screen appears.
- 2 Press the (◀◀/▶▶) arrow buttons to select previous/next thumbnail screen.
- 3 Use the (▲/▼/◀/▶) arrow buttons to select an image you would like to playback in full screen, and then press the **OK** button.

Zooming a picture

Press ZOOM during normal, slow or still playback.

The center part of the image will be zoomed in or out.

Each time you press the ZOOM button, the magnification/minification level changes as follows:

🔍 Zoom 2X → 🔍 Zoom 3X → 🔍 Zoom 4X → 🔍 Zoom 1/2X → 🔍 Zoom 1/3X → 🔍 Zoom 1/4X

(Sample Illustration) Zoom levels

Press the (▲/▼/◀/▶) arrow buttons to view a different part of the image.

You may move the image from the center position to UP, DOWN, LEFT and RIGHT direction.

When you reach the edge of the image, the display will not shift anymore in that direction.

- NOTE** Some discs may not respond to zoom feature. During some scenes, the buttons may not work as described.

Bookmark

- 1 During playback, press the **BOOKMARK** button to mark the desired scene. The bookmark number, the current title and chapter, the elapsed time of the current title appears on the screen. You can set up to 12 bookmarks on a DVD.
- 2 Press and hold the **BOOKMARK** button until the bookmark menu appears. Use the (▲/▼/◀/▶) arrow buttons to select one option, and then press the **OK** button to play the favorite bookmark.

To cancel the bookmark:

- 1 Press and hold the **BOOKMARK** button until the bookmark menu appears.
- 2 Press the **Clear** button repeatedly until all bookmarks are cleared.
- 3 Press the **OK** button to resume normal playback.

OSC (On Screen Control) operation

- 1 During playback, press the **OSC** button. The OSC menu appears on the screen.
- 2 Press the (▲/▼) arrow buttons to select options, and press the (▶) button or **OK**. Use the (▲/▼) arrow buttons to make adjustment and press **OK**.

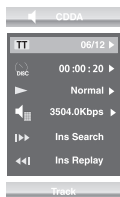
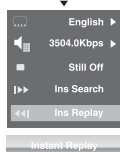
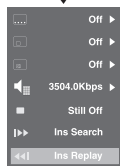
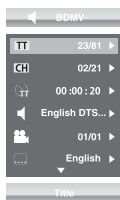

When playing a BD:

Title: To select the title you want to locate.

Chapter: To select the chapter you want to locate.

Time: To display the elapsed time or remaining time of current title/chapter.

Audio: To select the audio language.

Angle: To select the camera angle.

Subtitle: To select a subtitle language.

Subtitle Style: To select a subtitle style.

Second Video: To turn On/Off second video.

Second Audio: To turn On/Off second audio.

Bitrate: To select a bitrate.

Still Off: To pause or normal playback.

Instant Search: To fast forward playback.

Instant Replay: To fast reverse playback.

When playing a DVD:

Title: To select the title you want to locate.

Chapter: To select the chapter you want to locate.

Time: To display the elapsed time or remaining time of current title/chapter.

Mode: To select play mode.

Audio: To select the audio language.

Angle: To select the camera angle.

Subtitle: To select a subtitle language.

Bitrate: To select a bitrate.

Still Off: To pause or normal playback.

Instant Search: To fast forward playback.

Instant Replay: To fast reverse playback.

When playing a CD:

Track: To select the track you want to locate.

Time: To display the elapsed time or remaining time of disc or current track.

Mode: To select play mode.

Bitrate: To select a bitrate.

Instant Search: To fast forward playback.

Instant Replay: To fast reverse playback.

3 Press the **OSC** button again to exit.

Displaying on-screen information

Press the **DISPLAY** button:

Your unit displays information about the Disc, such as type of disc, title number, chapter number, elapsed time of the current title, audio format, subtitle language.

Press the **DISPLAY** button again to exit.

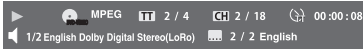
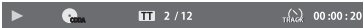
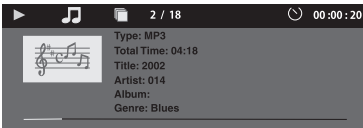
*(Sample Illustration) Blu-ray™ Video**(Sample Illustration) DVD-video/AVCHD™**(Sample Illustration) CD**(Sample Illustration) MP3/WMA**(Sample Illustration) JPG*

Playing AVCHD™/MP3/WMA/JPEG files

You can play AVCHD™, MP3, WMA or JPEG files that have been recorded on a disc or a Media Server on the Blu-ray Disc™/DVD player.

Playing files on a data disc

When inserting a data disc containing pictures, music, or video files into your player, icons are added to the menu to indicate that video, music, or picture files are available for playback.

- 1 Press the **OPEN/CLOSE** (▲) button on the remote control to open the disc tray, and load a disc that contains video/MP3/JPEG files.
- 2 On the **Home** menu, press the (▲ / ▼) arrow buttons to select **Video**, **Music**, or **Photo**, and then press the **OK** button.

The Media Center menu appears on the screen.

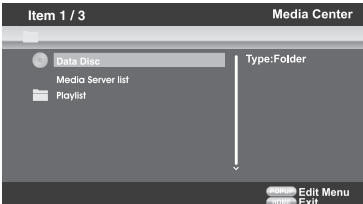
*(Sample Illustration) Media Center menu*

- 3 Press the (▲ / ▼) arrow buttons to select **Data Disc** and press **OK**.
- 4 Press the (▲ / ▼) arrow buttons to select a file (or folder) and press **OK** or **PLAY** to start playback.

Playing files on a Media Server

- 1 Set the Media Server Search to **Enable**.
- 2 In the **Home** menu, press the (▲ / ▼) arrow buttons to select **Video**, **Music**, or **Photo**, and then press the **OK** button.

- 3 Press the (▲/▼) arrow buttons to select **Media Server list**, and then press **OK**.
- 4 Press the (▲/▼) arrow buttons to select **Video**, **Music** or **Photo**, and press **OK**. It should match the selection in the **HOME** menu. (If you selected **Video** in **HOME** menu, you also should select **Video** here.)
- 5 Press the (▲/▼/◀/▶) arrow buttons to select a file (or folder), and press **OK** or **PLAY** to start playback.

NOTE Make sure your player is properly connected to the network before using it. Furthermore, you need at least one Media Server in the network to see and/or hear contents.
Do not remove the LAN connector during playback.
Not all media formats are supported.

Using a USB flash drive

You can play AVCHD™, MP3, WMA or JPEG files that have been stored on USB flash drives on the Blu-ray Disc™/DVD player.

Operating a USB flash drive

- 1 Insert a USB flash drive into the USB port of the Blu-ray Disc™/DVD player until it clicks.
- 2 In the **Home** menu, press the (▲/▼) arrow buttons to select **Video**, **Music**, or **Photo**, and then press the (▶) arrow button or the **OK** button.
The Media Center menu appears on the screen
- 3 Press the (▲/▼) arrow buttons to select **USB1**, and press **OK**.
- 4 Press the (▲/▼) arrow buttons to select a file (or folder), and press the **OK** or **PLAY** button to start playback.

For additional operations, follow the instructions in “Playing AVCHD™/MP3/WMA/JPEG files” on page 31.

To remove the USB flash drive, gently pull the drive out of the player slowly, while in stop mode.

NOTE If you cannot easily insert the USB flash drive, you may have inserted it incorrectly. Try to turnover the device and then insert again.
Do not remove the USB flash drive during playback.

Customizing the function settings

You can change the default settings to customize performance to your preference.

Performing Easy Setup

If it is the first time for the player to start up or users restore all settings to factory defaults, the system will prompt you to perform Easy Setup.

Follow the on-screen instructions to customize the following settings to your preference:

- ❖ **OSD Language:** (English/French/Spanish)
- ❖ **Resolution:** (Auto/480i/480p/720p/1080i/1080p)
- ❖ **TV Screen:** (16:9 Full / 16:9 Normal / 4:3 Pan & Scan / 4:3 Letterbox)

After setting, press **OK** to confirm and exit.

General operations

- 1 Press the **HOME** button in stop mode to display the **HOME** menu. Then use the (▲/▼) arrow buttons to select **Setting**.
- 2 Press the (▶) arrow button, and then the (▲/▼) arrow buttons to select the setting options.
- 3 Press the **OK** button.
- 4 Press the (◀) arrow button or the **RETURN** button to return to the previous menu.

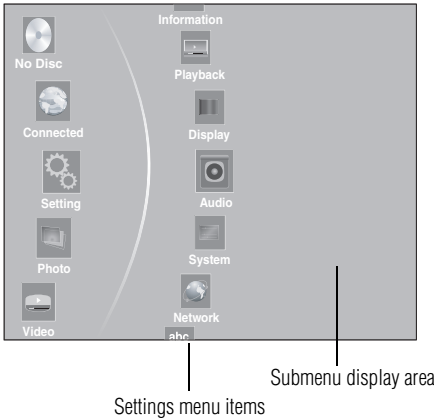

(Sample Illustration) General operations settings

Information

This menu displays the following information:

- ❖ Software version
- ❖ MAC Address
- ❖ Netflix® ESN

- 1 In the main **Settings** menu, press the (▲ / ▼) arrow buttons to select **Information** to display the software version, MAC Address and Netflix® ESN.
- 2 Press the (◀) arrow button or the **RETURN** button to return to the previous menu.

Playback

- 1 In the main **Settings** menu, press the (▲ / ▼) arrow buttons to select **Playback**, and then press the (▶) arrow button or the **OK** button to confirm.
- 2 Press the (▲ / ▼) arrow buttons to select an option, and then press **OK**.
- 3 Use the (▲ / ▼) arrow buttons to select **On/Off**, and then press the **OK** button.
- 4 Press the (◀) arrow button to return to the previous menu.

Angle Mark

To turn On/Off the angle mark.

PIP Mark

To turn On/Off the PIP mark.

Secondary Audio

To turn On/Off secondary audio.

Last Memory

To turn On/Off the last memory.

Display settings

- 1 In the main **Settings** menu, press the (▲ / ▼) arrow buttons to select **Display**, and then press the (▶) arrow button or **OK** button to confirm.
- 2 Press the (▲ / ▼) arrow buttons to select an option, and then press the **OK** button.
- 3 Use the (▲ / ▼) arrow buttons to select the desired option, and then press the **OK** button to confirm your selection.
- 4 Press the (◀) arrow button to return to the previous menu.

TV Screen

16:9 Full, 16:9 Normal, 4:3 Pan & Scan and 4:3 Letterbox are available for your choice.

Resolution

You can define the video output resolution in this option.

<i>Resolution:</i>	<i>TV Type:</i>
Auto	If your TV is a high-definition TV(HDTV) connected to the HDMI® jack on your player and you want your player to set the output resolution based on information exchanged between the TV and your player over the HDMI® cable.
480i	If your TV is a standard-definition TV (SDTV) capable of 480i only.
480p	If your TV is an enhanced-definition TV (EDTV) capable of 480p only.
720p	If your TV is a high-definition TV (HDTV) capable of 720p only.
1080i	If your TV is a high-definition TV (HDTV) capable of 1080i only.
1080p	If the TV is a high-definition TV (HDTV) capable of 1080p (any frame rate) connected to the HDMI® jack on your player.

NOTE

Selecting a resolution the TV does not support could result in an unstable picture or loss of the picture. See the documentation that came with the TV to find the resolutions the TV supports.

Only the HDMI® output on your player supports 1080p video output at any frame rate.

Color Space

To select the RGB, YCbCr, YCbCr422, or Full RGB to match your TV for perfect display effect.

HDMI® Deep color

This option decides whether to turn off the Deep Color (color depth) setting for video signals output from the HDMI OUT jack.

Connecting the player and a TV that supports HDMI® Deep Color allows more accurate color reproduction than when connecting to a TV that does not support HDMI® Deep Color. It is recommended to set this option to **Off** if the picture is unstable or colors appear unnatural.

HDMI® 1080/24p

Movies are recorded on film at a rate of 24 pictures (frames) per second. Many of the movies on Blu-ray™ discs are placed on the discs at this frame rate. However, not all TVs can display 24 progressive frames/second of video. If the TV cannot display this frame rate, you need to turn off HDMI® 1080/24p.

Blu-ray 3D Mode

Select whether to play a Blu-ray Disc™ with 3D contents in 3D Mode.

Auto: The 3D Blu-ray disc™ is played in 3D mode if your product detects a TV that supports it. It is played in 2D mode if your product detects a TV which can not support it.

Off: The 3D Blu-ray disc™ is played in 2D mode at all times.

Select this option to view a picture without 3D effect or when a TV cannot support 3D Blu-ray™ Discs.

NOTE

If you or any viewer experiences the following symptoms or any other discomfort from viewing 3D video images, stop viewing and contact your health care provider: Convulsions, Eye or muscle twitching, Loss of awareness, Altered vision, Involuntary movements, Disorientation, Eye Strain, Nausea/Vomiting, Dizziness, Headaches, or Fatigue.

Carefully read instructions provided with your display and/or 3D glasses before 3D viewing.

If you want to enjoy a 3D content, connect a 3D device (3D compliant AV receiver or TV) to the product and wear a 3D glass before playing the 3D content.

While watching the 3D video, all analogue component and composite signals are blocked automatically.

All 3D signals are output only, using an HDMI® cable through the HDMI OUT port.

As the video resolution in 3D play mode is fixed according to the resolution of the original 3D video, you cannot change the resolution to your preference.

You must use a high-speed HDMI® cable for proper output of the 3D signal.

You cannot use this product for switching a 2D content to 3D.

Video Adjust

Brightness: Adjust the brightness of the picture.

Contrast: Adjust the contrast of the picture. The black portions of the picture become richer in darkness and the white become brighter.

Hue: Adjust the hue of the picture.

Saturation: Adjust the amount of color in the picture.

Sharpness

Adjust the sharpness levels (Low, Middle or High) to improve detail in the picture.

Audio setting

The settings in the Audio menu will configure the Blu-ray Disc™/DVD player's digital audio outputs (HDMI® or Coaxial).

- 1 In the main **Settings** menu, press the (▲ / ▼) arrow buttons to select **Audio**, and then press the **OK** button.
- 2 Press the (▲ / ▼) arrow buttons to select an option, and then press the **OK** button.
- 3 Use the (▲ / ▼) arrow buttons to select the desired audio setting, and then press the **OK** button to confirm.
- 4 Press the (◀) arrow button to return to the previous menu.

SPDIF

When you connect an audio system to the COAXIAL DIGITAL output jack (see “Connecting to a digital amplifier/AV receiver” on page 16) the options are:

- ❖ **Bitstream:** Selects Bitstream output if your receiver SPDIF (Coax) IN supports Dolby® or DTS® or PCM audio signal.
- ❖ **PCM:** Selects PCM output if your receiver SPDIF (Coax) IN only supports PCM stereo audio signal.
- ❖ **Re-encode:** Selects Re-encode output if your receiver SPDIF (Coax) IN supports Dolby® or DTS® and you want to hear both PIP audio and the movie audio on Blu-ray™ video.
- ❖ **Off:** No audio will be output via COAXIAL DIGITAL output jack.

HDMI®

When you connected an HDMI® device to the HDMI OUT jack (see “Connecting to a digital amplifier/AV receiver” on page 16). The available options are:

- ❖ **Bitstream:** Selects Bitstream output if your receiver HDMI IN supports Dolby® or DTS® or PCM audio signal.
- ❖ **PCM:** Selects PCM output if your receiver HDMI IN only supports PCM audio signal.

- ❖ **Re-encode:** Selects Re-encode if your receiver's HDMI IN supports Dolby® or DTS® and you want to hear both PIP audio and movie audio on Blu-ray™ video.
- ❖ **Off:** No audio will be output via HDMI OUT jack.

Down-Samp

If you don't have a surround sound receiver connected to the Blu-ray Disc™/DVD player, you should leave the PCM downsampling to 48 kHz, and proceed to the next setup menu item.

If you have a surround sound receiver connected to the Blu-ray Disc™/DVD player, and you have connected to the surround receiver via the Blu-ray Disc™/DVD player's HDMI® output, this setting has no effect on the audio going to the HDMI® output of the player. Leave the PCM downsampling to 48 kHz, and proceed to the next setup menu item.

NOTE Incorrectly setting the digital audio output's Down-Samp rate too high may result in unpredictable audio playback.

Dolby® DRC (Dynamic Range Control)

Dynamic Range Control means that you can allow the Blu-ray Disc™/DVD player to make the loud parts of a movie's audio track quieter than they would be in the theatre, without making the dialog of the actors any quieter.

This would be useful, for instance, when you want to watch a movie in the evening when others might be sleeping.

When Dynamic Range Control is set to Off, movie soundtracks are played with the standard dynamic range. When movie soundtracks are played at low volume or from smaller speakers, you can set Dynamic Range Control to On. Your player applies appropriate compression to make low-level content more intelligible and prevent dramatic passages from getting too loud.

Selecting the "Auto" option turns on the Dynamic Range Control for all Blu-ray Disc™ movie soundtracks except Dolby® TrueHD. If you have selected a Dolby® TrueHD track on the Blu-ray Disc™, the "auto" selection tells the Blu-ray Disc™/DVD player to only turn on dynamic range control if information embedded in the Dolby® TrueHD soundtrack tells it to do so.

Stereo Down Mix

Select whether to downmix the multi-channel audio into fewer channels.

- ❖ **Stereo**—Downmixes the multi-channel audio into two channel stereo. Choose when the Blu-ray Disc™/DVD player is connected to equipment that does not support virtual surround function such as Dolby® Pro Logic.
- ❖ **Surround Encoded (LtRt)**—Downmixes the multichannel audio into surround compatible stereo. Choose when the Blu-ray Disc™/DVD player is connected to equipment that supports virtual surround function such as Dolby® Pro Logic.

System setting

- 1 In the main **Settings** menu, press the (▶) arrow button, then use the (▲ / ▼) arrow buttons to select **System**, and then press the **OK** button.
- 2 Press the (▲ / ▼) arrow buttons to select an option, and then press the **OK** button.
- 3 Use the (▲ / ▼) arrow buttons to select the desired setting, and then press the **OK** button to confirm.
- 4 Press the (◀) arrow button to return to the previous menu.

Screen saver

This Blu-ray Disc™/DVD player has a screen saver feature for when your player is inactive. You can set it to **On/Off**.

If you set the Screen Saver to On mode, the screen saver of the unit automatically appears when you leave the unit in stop mode for more than 5 minutes.

Disc auto play

If **On** is selected, a Blu-ray Disc™ will load data and play back automatically when you insert it. If **Off** is selected, when you insert a Blu-ray Disc™, it will be displayed on the Settings menu.

CEC

This option is used to allow the TV remote control to control certain functions of the Blu-ray Disc™/DVD player, and the Blu-ray Disc™/DVD player to control certain functions of the TV.

- ❖ **On:** Allow mutual control of devices through HDMI®.
- ❖ **Off:** Do not allow CEC control.

NOTE

Not all TVs are compatible with your Blu-ray Disc™/DVD player.
The default setting is Off. Select On if CEC control is necessary.

Load Default:

Press the **OK** button to display a pop up dialog box, select **OK** in the box, and then press the **OK** button to confirm.

To apply the deactivation, unplug the player after operating deactivation.

Deactivate Setting

<i>Action:</i>	<i>Response:</i>
Deactivate all connected applications	Deactivates all connected applications
Deactivate Netflix®	Deactivates the connected Netflix® application
Deactivate YouTube®	Deactivates the connected YouTube® application
Deactivate VUDU™	Deactivates the connected VUDU™ application
Deactivate Pandora®	Deactivates the connected Pandora® application
Deactivate Picasa™	Deactivates the connected Picasa™ application
Deactivate CinemaNow®	Deactivates the connected CinemaNow® application
Deactivate Hulu Plus™	Deactivates the connected Hulu Plus™ application

Upgrade

This option allows to update your product software via a Disc, USB storage or Network.

External Memory

BUDA Information: To display the external memory information.

Network connection setting

- 1 In the main **Settings** menu, press the (▲ / ▼) arrow buttons to select **Network**, and then press the **OK** button.
- 2 Press the (▲ / ▼) arrow buttons to select an option, and then press the **OK** button.
- 3 Press the (◀) arrow button to go to the previous menu.

Internet Connection

To enable/disable the Internet connection.

Interface

To select the Ethernet or Wireless.

Connection Test

Selecting the Connection Test will cause the player to attempt to communicate with your home network, and if successful, with a known Internet address. If both attempts are successful, your network connection should be good. If the player can successfully connect to your home network, but not to the known Internet address, your Internet service may be “down”, or your security firewall may be blocking access of the player to the Internet.

IP Setting

To select Auto or Manual to set IP.

For step by step instruction, see “Connecting to a network” on page 17.

BD-Live™ Connection

- ❖ Permitted - Always allows BD-Live™ network access.
- ❖ Partial Permitted - Allows Internet access with valid BD-Live™ network access approval.
- ❖ Prohibited - Never allows BD-Live™ Internet access.

Some (but not all) Blu-ray™ Discs contain additional features that are made available to players that are connected to the Internet, and have additional memory added. These additional features may include things like:

- ❖ the ability to download new movie trailers
- ❖ additional 'commentary' by actors and directors
- ❖ multi-person game play and chat

In order to access BD-Live™ functions, the player must be properly configured for BD-Live™ Internet access, and it must be equipped with additional memory.

NOTE

BD-Live™ requires connection of a USB flash drive of at least 1 GB (sold separately) to USB port. For models without built-in Wi-Fi®, BD-Live™ is only supported via Ethernet so when using single USB port for Internet access, BD-Live™ will not be available. Performance of interactive features may vary due to disc design or content, and may also require an always-on broadband Internet connection. Firmware update may be required for some interactive features. Some features may require additional bandwidth. Internet services are available only in the United States.

NOTE

Depending on your connection environment, it may take time to connect to the Internet or the Internet may not be connected.

When BD-Live™ functions are used and the unit is connected to the Internet, you may be charged for this communication.

Do not remove the USB flash drive when using the BD-Live™ function.

Information

To display the Network Information.

For detailed information, visit <http://us.toshiba.com/tvapps2012>.

External control setting

To set the Device Name, User Name, Password or Port Number. For detail informations, visit the following web site:

<http://us.toshiba.com/tvapps2012>

Media Sever Search

Media Sever Search function enables you to create an interoperability network with other devices for resource sharing based on a network.

Language settings

- 1 In the main **Settings** menu, press the (▲ / ▼) arrow buttons to select **Language**, and then press the **OK** button.
- 2 Press the (▲ / ▼) arrow buttons to select **OSD**, **Menu**, **Audio**, or **Subtitle**, and then press the **OK** button.
- 3 Use the (▲ / ▼) arrow buttons to select the preferred language, and then press the **OK** button to confirm.
- 4 Press the (◀) arrow button to return to the previous menu.

OSD

This option enables you to select the on-screen menu language.

Menu

This option lets you to select the disc menu language.

- NOTE** Not all languages are available on all discs.
Most discs only have one menu language.

Audio

From this option, you can choose the audio language of your preference.

- NOTE** Not all languages are available on all discs.
Some discs do not let you select the audio language using your player's menu. Instead, you have to select the audio language from the disc setup menu (the menu that appears after you insert the disc).

Subtitle

You can customize your preferred subtitle language in this option.

- NOTE** Not all languages are available on all discs.
Some discs do not let you select the subtitle language using your player's menu. Instead, you have to select the subtitle language from the disc setup menu (the menu that appears after you insert the disc).
You can also select the subtitle language from the subtitle menu in the on-screen menu.

Security

- 1 In the main **Settings** menu, press the (▲ / ▼) arrow buttons to select **Security**, and then press the **OK** button.
- 2 Press the (▲ / ▼) arrow buttons to select **Password**, **Country Code** or **Parental Control**, and then press the **OK** button.
- 3 Enter your password by pressing number buttons. The default password is 0000.
- 4 Press the (◀) arrow button to return to the previous menu.

Password

A new password can be set to replace the default password.

- 1 Enter the current password (a 4-digit number).
The **New password** screen appears.
- 2 Enter a 4-digit number for the new password, and then enter it again to confirm.

If you forget the password, you can erase your current password by pressing number button **0** on the remote control four times, then press **OK** button to confirm the setting. **PASSWORD: 0000**

Country Code

Enter the password (a 4-digit number) for selecting the country code (United States or Canada).

Parental control

- 1 Enter a 4-digit number for the parental control.
- 2 Press the (▲ / ▼) arrow buttons to select the rating level you want to block, and then press **OK**.

The selected rating and all higher ratings will be blocked. You can select:

- ❖ Off
- ❖ **1 [Kid Safe]** — Suitable for all children.
- ❖ **2 [G]** — General audiences.
- ❖ **3 [PG]** — Parental guidance suggested.
- ❖ **4 [PG-13]** — Not suitable for anyone under 13.
- ❖ **5 [PG-R]** — Parental guidance recommended.
- ❖ **6 [R]** — Not suitable for anyone under 17 unless supervised by a parent or adult guardian.

- ❖ 7 [NC-17] — Not suitable for anyone under 17.
 - ❖ 8 [Adult] — All Blu-ray™ Discs and DVDs can be played.
- 3 Press the (◀) arrow button to go to the previous menu.

Using the connected applications

Watching movies with CinemaNow®

This Blu-ray Disc™/DVD player enables you to use the following services provided by CinemaNow®.

- 1 In the **Home** menu, press the (▲ / ▼) arrow buttons to select **Connected**.
- 2 Press the (▶) arrow button, and then press the (▲ / ▼) arrow buttons to select **Video**.
- 3 Use the (▲ / ▼ / ◀ / ▶) arrow buttons to select **CinemaNow**, and then press the **OK** button to enter the CinemaNow® main menu.
 - ❖ **Store:**
 - ❖ **Search:**
 - ❖ **My Wish List:**
 - ❖ **My Library:**
 - ❖ **Settings:**
 - ❖ **Parental Controls:**
 - ❖ **Help:**
 - ❖ **Exit:**
- 4 If you don't have a CinemaNow® account yet, visit www.cinemanow.com/bbactivate to create your account.
- 5 Press the (▲ / ▼ / ◀ / ▶) arrow buttons to select **ENDUSER LICENSE AGREEMENT** and then press the **OK** button.
- 6 Press **Accept**.

The activation code is displayed on the TV screen.
- 7 Visit cinemanow.com/start and enter user name and password.

When the Blu-ray Disc™/DVD player is activated, you will move to the Home page.
- 8 Press the (▲ / ▼) arrow buttons to select **Store**, and then press the **OK** button.
- 9 Press the (▲ / ▼ / ◀ / ▶) arrow buttons to select the desired title, and then press the **OK** button.
- 10 Press the (▲ / ▼) arrow buttons to select **Rent** or **Buy**, and then press the **OK** button.
- 11 Press the (◀ / ▶) arrow buttons to select **Submit Order**, and then press the **OK** button. If you wish to play any of the titles that were purchased, click **Play Now**.
- 12 Press the (◀) arrow button to go to the previous menu.

Watching movies with Netflix®

To use Netflix® service, connect this player to your network, and create the network settings if they are not yet finished.

Launching Netflix® movie

- 1 In the **Home** menu, press the (▲ / ▼) arrow buttons to select **Connected**.
- 2 Press the (▶) arrow button, and then press the (▲ / ▼) arrow buttons to select **Video**.
- 3 Use the (▲ / ▼ / ◀ / ▶) arrow buttons to select **Netflix**, and then press the **OK** button to enter the Netflix® menu.

Creating Netflix® account

If you are not a Netflix® member:

Select **no**. Read the instructions displayed on the TV screen, and visit

<http://www.netflix.com/toshiba> from your PC. Sign up to create your account, then select "I'm now a member".

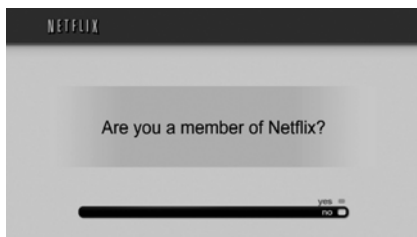

(Sample Illustration) Netflix® member - no

- 4 If you are a Netflix® member, select **yes**.
- 5 Enter a valid email address and password.

Preparing Instant Queue

To play streaming video via Netflix® service, Netflix® player needs to be activated. Read the instructions displayed on the TV screen. Sign in to your Netflix® account with your email address and password. Now you can view Netflix® streaming video. After having activated Netflix® player and prepared Instant Queue, movies and TV episodes in your Instant Queue appear on the TV screen. Select the desired one using the remote control of the player. You can control Netflix® streaming video with the following keys of the remote control of this player:

Logos:	Playable discs:
▶	Starts playing movie. Pauses playback while in PLAY mode.
■	Stops playing and return to a list of movie titles.
	Pauses movie playback. Starts playing while in PAUSE mode.
▶	Pauses playing and opens a list of scenes. Pressing further proceeds to the next scene.
◀	Pauses playing and opens a list of scenes. Pressing further proceeds to the previous scene.
▲	Stops playing and returns to a list of movie titles.
▶▶	Pauses playing and opens a list of scenes. Fast forward play starts.
◀◀	Pauses playing and opens a list of scenes. Fast reverse play starts.
HOME Menu	Stops playing and returns to the Home Menu.
OK	Pauses playing of Track play screen while in PLAY mode. Starts playing the movie in case of during Track play screen.

NOTE Resolution of video streamed from Netflix® varies depending on communication speed or bitrate of each content, etc.

Watching movies with YouTube®

- 1 In the **Home** menu, press the (▲/▼) arrow buttons to select **Connected**.
- 2 Press the (▶) arrow button, and then press the (▲/▼) arrow buttons to select **Video**.
- 3 Use the (▲/▼/◀/▶) arrow buttons to select **YouTube**, and then press the **OK** button to confirm.

- 4 Please enjoy any contents.

Watching movies with VUDU™

Creating a VUDU™ account on your player

- 1 In the **Home** menu, press the (▲/▼) arrow buttons to select **Connected**.
- 2 Press the (▶) arrow button, and then press the (▲/▼) arrow buttons to select **Video**.
- 3 Use the (▲/▼/◀/▶) arrow buttons to select **Vudu HD Movies**, and then press the **OK** button to confirm.
Or press the (▲/▼) arrow buttons to select **Others**, and use the (▶) arrow button to select **Vudu Apps**, and then press **OK** to confirm.
- 4 Follow the instructions to create an account, it will ask for an email address.
- 5 Enter YOUR email address using the keyboard that appears on the screen.
VUDU™ will then display a message on the TV “Sending you an email”.

Creating a VUDU™ account on your PC

- 1 VUDU™ will send you an email with a hyper-link; click on the link.
- 2 In the VUDU™ page that comes up on your PC’s browser after clicking the link, enter the e-mail and password of the owner of the account.
VUDU™ will then display a message “Enabling your device to view movies. The email message on your TV screen will disappear when done”.
- 3 On your TV, you can now navigate to a VUDU™ movie, and ‘buy’ or ‘rent’ it.

Watching Movies with Hulu Plus™

Log in to Hulu Plus with your account:

- 1 In the **Home Menu**, press the (▲/▼) arrow buttons to select **Connected**.
- 2 Press the (▲/▼) arrow buttons to select **Video**, use the (▲/▼/◀/▶) arrow buttons to select **Hulu Plus**, and then press the **OK** button to confirm.
A message is displayed “Are you already a Hulu Plus subscriber?” on the screen.
- 3 Use the (▲/▼) arrow buttons to select **Yes**, and then press the **OK** button to confirm.
- 4 Log in to Hulu Plus and enter your email address and password using the virtual keyboard. then use the (▲/▼/◀/▶) arrow buttons to move the cursor to **Login** and press the **OK** button to confirm.

Creating a new Hulu Plus account on your PC

Go to www.hulu.com/activate and enter your activation code to create a new account.

Listening to music with Pandora®

Using an existing Pandora® account

- 1 In the **Home** menu, press the (▲/▼) arrow buttons to select **Connected**.
- 2 Press the (▶) arrow button, and then press the (▲/▼) arrow buttons to select **Music**.
- 3 Press the (▶) arrow button to select **Pandora**, and then press the **OK** button to confirm.
- 4 Select **I have a Pandora account** from the option list.
- 5 Sign in with your account.

Creating a new account on the Blu-ray Disc™/DVD player

- 1 In the main Home menu, press the (▲/▼) arrow buttons to select **Connected**.
- 2 Press the (▶) arrow button, then press the (▲/▼) arrow buttons to highlight **Pandora**, and then press the **OK** button to confirm.
- 3 Select **I am new to Pandora** from the option list.
You will be given an activation code.
- 4 Use this activation code to generate a new account and link it to the Blu-ray Disc™/DVD player using a PC.

Creating a new Pandora® account on your PC

Visit <http://www.pandora.com/> to create a new account.

Browsing photos with Picasa™

Signing in with your account

To display photos in your web album on the screen, you need to sign in with your Picasa™ account.

- 1 In the **Home** menu, press the (▲ / ▼) arrow buttons to select **Connected**.
- 2 Press the (▶) arrow button, and then press the (▲ / ▼) arrow buttons to select **Photo**.
- 3 Press the (▶) arrow button to select **Picasa**, and then press the **OK** button to confirm.
- 4 Enter your user name using the virtual keyboard, and press the **OK** button while [OK] is selected on the screen.
- 5 Enter the password using the virtual keyboard, and press the **OK** button while [OK] is selected on the screen.

Your web album is displayed on the screen.

Creating a new Picasa™ account on your PC

Visit <http://picasa.google.com/> to create a new account.

Troubleshooting & Maintenance

<i>Problem:</i>	<i>Solution:</i>
No power	Check if the AC cord is properly connected. Unplug the AC cord once, and wait for approximately 5-10 seconds and then plug it in again.
No sound or picture	Check if the connected TV is turned on. Check if the connections are made securely and correctly. Check whether the connected TV or other device supports HDCP. (This unit will not output a video signal unless the other device supports HDCP) Check whether the output format of this unit (HDMI® FORMAT) matches the supported input format of other connected device.
Distorted picture	Sometimes a small amount of picture distortion may appear. This is not a malfunction. Connect this unit directly to the TV.
Completely distorted picture or black /white picture with Blu-ray Disc™/DVD	Make sure the disc is compatible with this unit.
No sound or distorted sound	Adjust the volume. Check if speakers are connected correctly. Check the HDMI® connections. Check the settings in the Audio menu.
Picture freezes momentarily during playback	Check the disc for fingerprints/scratches and clean with a soft cloth wiping from center to edge. Clean the disc.
Disc cannot be played back	Clean the disc. Ensure the disc label is facing up. Check if the disc is defective by trying another disc. Cancel the ratings control or change the control level. Insert a correct disc that can be played back on this unit.
No return to start-up screen when disc is removed	Reset this unit by turning it off, then on again.

<i>Problem:</i>	<i>Solution:</i>
The unit does not respond to the remote control	Aim the remote control directly at infrared sensor window on the front panel. Reduce the distance to infrared sensor window. Replace the batteries in the remote control. Re-insert the batteries with their polarities (+ / - signs) as indicated.
Buttons do not work or the unit stops responding	To completely reset the unit, unplug the AC cord from the AC outlet for approximately 5-10 seconds.
The unit does not respond to some operating commands during playback	Operations may not be permitted by the disc. Refer to the instructions of the disc.
The unit cannot read Blu-ray Disc™/DVD/CD	Dew condensation may form inside the unit. Do not use this unit for at least a few hours until its inside gets dry. Wipe the dirt off the disc or replace the disc.
Angle does not switch	The angle cannot be switched for Blu-ray Disc™/DVD which do not contain multiple angles. In some cases multiple angles are only recorded for specific scenes.
Playback does not start when the title is selected	Check the settings in the Parental menu.
The password for rating level has been forgotten	If you forget your password, you need to go to the Security setup menu to reset and input a new password. For more information, see "Security" on page 39).
Cannot connect to the network	Check that the LAN cable connection is properly made. Turn on the modem or broadband router. Check that the broadband router and/or modem is correctly connected. Check the Network Connection Setting.
Cannot connect to the network while my PC is connected to the network	Check the content of your Internet service contract to see if your Internet service provider prevents multiple terminals connecting at the same time.
Cannot use the BD-Live™ function	Use a USB flash drive with enough space.

NOTE

Some functions are not available in specific modes, but this is not a malfunction. Read the description in this manual for details on correct operations.

Some functions are prohibited on some discs.

Maintenance**Servicing**

Please refer to relevant topics in "Troubleshooting & Maintenance" on page 43 before returning the product.

If this unit becomes inoperative, do not try to correct the problem by yourself. There are no user-serviceable parts inside. Turn off, unplug the power plug, and please call our helpline to locate an Authorized Service Center.

Cleaning the cabinet

Never use a solvent, thinner, benzene or alcohol to clean the unit. Do not spray insecticide liquid near the unit. Such chemicals may discolor the surface or damage the unit.

Cleaning discs

When a disc becomes dirty, clean it with a cleaning cloth. Wipe the disc from the center to out. Do not wipe in a circular motion.

Do not use solvents such as benzine, thinner, commercially available cleaners, detergent, abrasive cleaning agents or antistatic spray intended for analog records.

Cleaning the disc lens

If this unit still does not perform properly although you refer to the relevant sections and to “Troubleshooting” in this manual, the laser optical pickup unit may be dirty. Consult your dealer or an Authorized Service Center for inspection and cleaning of the laser optical pickup unit.

Disc handling

Handle the discs so that fingerprints and dust do not adhere to the surfaces of the discs.

Always store the disc in its protective case when it is not used.

Note that discs with special shapes (heart-shaped discs, octagonal discs, etc.) cannot be played back on this unit. Do not attempt to playback such discs, as they may damage the unit.

IR signal check

If the remote control is not working properly, you can use a digital camera (including a cellular phone with built-in camera) to see if it is sending out an infrared signal.

Glossary

Analog Audio

An electrical signal that directly represents sound. Compare this to digital audio which can be an electrical signal, but is an indirect representation of sound.

Aspect Ratio

The width of a TV screen relative to its height. Conventional TVs are 4:3 (in other words, the TV screen is almost square); widescreen models are 16:9 (the TV screen is almost twice as wide as it is high).

AVCHD™

AVCHD™ is a new format for high definition video camcorders which can record and play high-resolution HD images.

BD-Java™

With some Blu-ray Disc™ which support Java™ applications, you can enjoy the interactive functions such as games or interactive menus.

BD-Live™

BD-Live™ is a Blu-ray™ Video (BD-ROM version 2 Profile 2.0/Profile 1.1) which contains new functions (e.g. Internet connection), in addition to the BONUSVIEW™ function.

Blu-ray Disc™ (BD)

Blu-ray Disc™ is a next generation optical video disc which is capable of storing much more data than a conventional DVD is. The large capacity makes it possible to benefit from the features such as high-definition videos, multichannel surround sounds, interactive menus and so on.

Blu-ray 3D™

Blu-ray 3D™ is a Blu-ray™ Video (BD-ROM version 3 Profile 5.0) which contains 3D view functions, in addition to the BD-Live™/BONUSVIEW™ function.

Chapter

Just as a book is split up into several chapters, a title on a Blu-ray™ Video or DVD-video is usually divided into chapters.

Component Video Output

Each signal of luminance (Y) and component (PB/CB, PR/CR) is independent to output so that you can experience picture Color as it is. Also, due to compatibility with progressive video (525p/480p), you can experience higher-density picture than that in interlace (525i/480i).

Digital Audio

An indirect representation of sound by numbers. During recording, the sound is measured at discrete intervals (44,100 times a second for CD audio) by an analog-to-digital converter,

generating a stream of numbers. On playback, a digital-to-analog converter generates an analog signal based on these numbers.

DNS Server

A server which translates Internet domain names into IP addresses.

Dolby® Digital

The system to compress digital sound developed by Dolby® Laboratories. It offers you sound of stereo (2ch) or multi-channel audio.

Dolby® Digital Plus

Dolby® Digital Plus is the next generation digital audio compression technology developed as an extension to Dolby® Digital. Blu-ray Disc™ supports 7.1 multi-channel surround sound output.

Dolby® TrueHD

Dolby® TrueHD is a lossless coding technology developed for next generation optical discs. Blu-ray Disc™ supports 7.1 multi-channel surround sound output.

DTS®

DTS® is a multi-channel surround sound system. By connecting to DTS® decoder, you can enjoy movie dynamic and realistic sound like movie theater. DTS® surround sound technologies were developed by DTS®, Inc.

DTS-HD®

DTS-HD® is a lossless coding technology developed as an extension of the original DTS® Coherent Acoustics format. Blu-ray Disc™ supports 7.1 multi-channel surround sound output.

Gateway

IP Address of the electronic devices (such as router) which provide Internet access.

HDMI® (High-Definition Multimedia Interface)

A digital interface between audio and video source. It can transmit component video, audio, and control signal with one cable connection.

Hub

A device used for connecting multiple device to the network.

IP Address

A set of numbers which are assigned to devices participating in a computer network.

JPEG (Joint Photographic Experts Group)

JPEG is a method of compressing still picture files. You can copy JPEG files on BD-R/BD-RE, DVD-RW/-R or CDRW/-R from a computer and play back the files in this unit.

LAN (Local Area Network)

A group of computer networks covering a small area like a company, school or home.

Local Storage

A storage area of sub contents for playing virtual packages on Blu-ray™ Video.

MP3 (MPEG audio layer 3)

MP3 is a method of compressing files. You can copy MP3 files on BD-R/BD-RE, DVD-RW/-R or CD-RW/-R from the computer and play back the files on this unit.

PCM (Pulse Code Modulation)

The most common system of encoding digital audio, found on CD and DAT. Excellent quality that requires a lot of data compared to formats such as Dolby® Digital and MPEG audio. For compatibility with digital audio recorders (CD, MD and DAT) and AV amplifiers with digital inputs, this unit can convert Dolby® Digital, DTS®, and MPEG audio to PCM.

Proxy Server

Proxy server is a server which acts as an intermediary between a workstation user and the Internet to ensure security.

Region Code

Regions associate discs and players with particular areas of the world. This unit will only play back discs that have compatible region codes. You can find the region code of your unit by looking on the rear panel. Some discs are compatible with more than one region (or all regions).

Router

A networking device which distinguishes the IP address assigned to each device and routing and forwarding information in the computer network.

Sampling Frequency

The rate which sound is measured by a specified interval to turn into digital audio data. The numbers of sampling in one second defines as sampling frequency. The higher the rate, the better the sound quality.

Subnet Mask

A mask which is used to determine what subnet an IP address belongs to.

Title

A collection of chapters on Blu-ray™ Video or DVD-video.

Track

Audio CD use tracks to divide up the content of a disc. The Blu-ray™ Video or DVD-video equivalent is called a chapter. See also “Chapter”.

Virtual Package

The function which copies data to other media (local storage) from the Internet and play the secondary video, secondary audio and the subtitle at the same time. The method of the playback varies depending on discs.

Windows Media™ Audio

Windows Media™ Audio is the audio compressing technology developed by Microsoft®. You can copy Windows Media™ Audio files on BD-R/BD-RE, DVD-RW/-R or CD-RW/-R from a computer and play them back on this unit.

x.v.Color®

“x.v.Color®” is a promotion name given to the products that have the capability to realize a wide color space based on the xvYCC specifications and is a trademark of Sony Corporation.

Specifications

<i>General:</i>	
Signal system	NTSC color
Power requirements	120V AC, 60Hz
Power consumption	12W
Dimensions (width x height x depth)	430 x 36 x 186mm
Weight	1.0 kg
Operating temperature	41°F (5°C) to 95°F (35°C)
Operating humidity	Less than 80% (no condensation)
HDMI® output HDMI® jack x 1	Video: 480i, 480p, 720p 1080i, 1080p, 1080p/24F/Audio
Audio output (Coaxial digital) RCA jack x 1	0.5Vp-p (75Ω)
USB terminal x 1	5V $\overline{\text{---}}$ 500mA
LAN terminal	100BASE-T

NOTE

The specifications and design of this product are subject to change without notice.

Disclaimer

1080p capable display required for viewing in 1080p. Viewing HD content and up-converting DVD content may require an HDCP capable input on your display device. While up-converting DVD video content may result in a picture that appears to be near HD quality, results may vary depending on content, display and settings. Feature performance may vary and may also require an always-on broadband Internet connection. Firmware update and additional bandwidth may be required. BD-Live™ requires connection of a USB flash drive of at least 1 GB (sold separately) to USB port. Performance of interactive features may vary due to disc design or content, and may also require an always-on broadband Internet connection. Firmware update may be required for some interactive features. Some features may require additional bandwidth. Third party Internet services are not provided by Toshiba, may change or be discontinued at any time and may be subject to third party restrictions. Toshiba makes no representations or warranties about these services, which may require the creation of a user account through a computer with Internet access. Third party Internet service users may incur one-time and/or recurring charges. For Dolby® TrueHD and DTS-HD® Master Audio | Essential™ playback, content encoded in Dolby® TrueHD and DTS-HD® Master Audio | Essential™ format required. Viewing 1080p/24 fps output requires 1080p/24 fps encoded content and an HD display capable of accepting a 1080p/24Hz signal. Supported file types: JPEG, MP3, WMA, and AVCHD. Some recordable media, cards or files may not be supported. Product specifications, information and availability are all subject to change without notice.

License Information

END USER LICENSE AGREEMENT

This End User License Agreement (“EULA”) is a legal agreement between you and Toshiba Corporation (“Toshiba”) with regard to the copyrighted Software provided with this EULA. Use of any software and related documentation (“Software”) provided with a Toshiba Blu-ray Disc™/DVD player, or made available by downloading or otherwise to you by Toshiba in whatever form or media, will constitute your acceptance of these terms, unless separate terms are provided by the software supplier or Toshiba in the documentation accompanying the Toshiba Blu-ray Disc™/DVD player or otherwise, in which case certain additional or different terms may apply. If you do not agree with the terms of this EULA, do not use, download, install or copy the Software. If you wish to return a complete Blu-ray Disc™/DVD player system (hardware and software), contact the retailer where you purchased the Blu-ray Disc™/DVD player, and comply with the retailer’s standard return policies and procedures.

Article 1 Definition

The Software means all programs contained in the Toshiba Blu-ray Disc™/DVD player. The copyright of the Software belongs to Toshiba and/or its suppliers, including BSQUARE Corporation and/or its suppliers. The Software is protected by copyright laws, Universal Copyright Convention, and other laws and conventions related to intellectual property rights. The content of the Software and manual is subject to change by Toshiba without notice.

Article 2 License Grant and Use Conditions

Toshiba grants to you a personal, non-transferable and non-exclusive right to use the copy of the Software in accordance with this EULA. You may permanently transfer all of your rights under this EULA, provided you transfer complete Blu-ray Disc™/DVD player together with all of the Software, you retain no copies, and the recipient agrees to the terms of this EULA. If the Software is an upgrade version, any transfer must include all prior versions of the Software. For maintenance purposes, you may update the version of the Software only for the Blu-ray Disc™/DVD player that is owned by you.

Article 3 Prohibited Uses

Unless otherwise expressly provided in this EULA or the product manual accompanying the Toshiba Blu-ray Disc™/DVD player:

- 3.1. You may not copy the Software, in whole or in part, without express written permission by Toshiba and/or its suppliers.
- 3.2. You may not assign, resell, distribute or sublicense the Software or a copy of the Software.
- 3.3. You may not create, assign, resell, or sublicense secondary works of the Software without permission.

- 3.4. You may not modify, analyze, reverse engineer, decompile or disassemble any part of the Software.
- 3.5. You may not combine or incorporate the Software with or into any other application.
- 3.6. You may not print the Software.

Article 4 Disclaimer

4.1. THE HARDWARE PRODUCT LIMITED WARRANTY IS SET FORTH IN THE DOCUMENTATION ACCOMPANYING THE HARDWARE PRODUCT.

4.2. THE SOFTWARE IS PROVIDED "AS-IS" AND "ASAVAILABLE," WITHOUT WARRANTIES OF ANY KIND.

ALL WARRANTIES AND CONDITIONS, EXPRESS OR IMPLIED, CONTRACTUAL OR STATUTORY, INCLUDING BUT NOT LIMITED TO, ANY IMPLIED WARRANTIES OF MERCHANTABILITY OR FITNESS FOR A PARTICULAR PURPOSE, TITLE OR NON-INFRINGEMENT ARE HEREBY WAIVED BY YOU AND DISCLAIMED BY TOSHIBA. THIS EULA REPRESENTS THE SOLE AND EXCLUSIVE OBLIGATION OF TOSHIBA AND ITS SUPPLIERS WITH RESPECT TO THE SOFTWARE.

Article 5 Limitation of Liability

TO THE MAXIMUM EXTENT NOT PROHIBITED BY APPLICABLE LAW, IN NO EVENT SHALL TOSHIBA AND/OR ITS SUPPLIERS BE LIABLE FOR PERSONAL INJURY, OR ANY INCIDENTAL, SPECIAL, INDIRECT, PUNITIVE OR CONSEQUENTIAL DAMAGES WHATSOEVER, INCLUDING, WITHOUT LIMITATION, DAMAGES FOR LOSS OF PROFITS, LOSS OF DATA, BUSINESS INTERRUPTION, OR ANY OTHER COMMERCIAL DAMAGES OR LOSSES, ARISING OUT OF OR RELATED TO YOUR USE OR INABILITY TO USE THE SOFTWARE, HOWEVER CAUSED, REGARDLESS OF THE THEORY OF LIABILITY (CONTRACT, TORT, OR OTHERWISE) AND EVEN IF TOSHIBA AND/OR ITS SUPPLIERS HAS BEEN ADVISED OF THE POSSIBILITY OF SUCH DAMAGES. SOME JURISDICTIONS DO NOT ALLOW THE LIMITATION OF LIABILITY FOR PERSONAL INJURY, OR FOR INCIDENTAL OR CONSEQUENTIAL DAMAGES; THEREFORE, THE ABOVE LIMITATIONS MAY NOT APPLY TO YOU UNDER SUCH CIRCUMSTANCES. THE AGGREGATE LIABILITY OF TOSHIBA AND ITS SUPPLIERS IN CONNECTION WITH THE SOFTWARE, REGARDLESS OF THE FORM OF ANY LEGAL ACTION OR PROCEEDING, SHALL BE LIMITED TO DIRECT DAMAGES NOT TO EXCEED THE AMOUNT PAID FOR THE TOSHIBA BLU-RAY PLAYER.

Article 6 Export Control

Any export, directly or indirectly, of the Software in contravention of the United States Export Administration Regulations, or any other applicable law, regulation, or order, is prohibited.

Article 7 Termination of License

In the event that you fail to comply with any of the terms and conditions contained herein, Toshiba shall have the right to immediately terminate this Agreement without any notification to you. Upon termination of this Agreement, you shall cease all use of the Software and destroy all copies, in whole and/or in part.

Article 8 Governing Law

This EULA is governed by the laws of Japan, without references to the conflict of laws principles. Any and all disputes arising hereunder shall be resolved exclusively by the Tokyo District Court, Japan, and you hereby consent to the exclusive jurisdiction of such court.

Article 9 Severability

If any provision of this EULA shall be held to be invalid, illegal or unenforceable, the validity, legality and enforceability of the remaining provisions hereof shall not in any way be affected or impaired.

(C) 2001-2010 Toshiba Corporation

The Software contains Macromedia® [Flash®] [Flash Lite™] technology of Adobe Systems Incorporated.

Copyright© 1995-2007 Adobe Systems Incorporated. All rights reserved. Macromedia, Flash, Macromedia Flash, [and Macromedia Flash Lite] are trademarks or registered trademarks of Adobe Systems Incorporated in the United States and other countries.

License information on the software used in the TOSHIBA Blu-ray Disc™/DVD player

This document is statement purpose only. Not concerned with operation of this product.

The software pre-installed in the TOSHIBA Blu-ray Disc™/DVD player consists of multiple, independent software components. Each software component is copyrighted by TOSHIBA or a third party.

The TOSHIBA Blu-ray Disc™/DVD player uses software components that are distributed as freeware under a third-party end-user license agreement or copyright notice (hereinafter referred to as a “EULA”). Some EULAs require that the source code of the applicable component be disclosed as the condition for distributing the software component in executable format. You can check the software components subject to such EULA requirements on the following phone number:

Phone number: 888-592-0944

TOSHIBA provides a limited warranty for the TOSHIBA Blu-ray Disc™/DVD player you have purchased under conditions set forth by TOSHIBA.

However, some of the software components distributed under an EULA are made available for use by the user on the assumption that they are not copyrighted or warranted by TOSHIBA or any third party. These software components are licensed to the user free of charge and therefore not covered by any warranty within the scope of the applicable laws. These software components are not subject to any copyrights or other third-party rights and are provided in “as is” condition without any warranty, whether express or implied. “Warranty” here includes, but not limited to, an implied warranty for marketability or fitness for specific uses. All risks associated with the quality or performance of these software components are assumed by the user. TOSHIBA shall not be liable whatsoever for any cost of repair or correction or other incidental expense incurred in connection with a defect found in any of these software components. Unless specified under the applicable laws or in a written agreement, a party who changes or redistributes the software with consent from the copyright holders or based on the aforementioned licenses shall not be held liable whatsoever for any loss arising from the use of or inability to use such software components. The same applies even when the copyright holders or relevant third parties have been informed of the possibility of such loss. “Loss” here includes normal, special, incidental and indirect loss (including, but not limited to, the loss of data or its accuracy; loss incurred by the user or any third party; and interface incompatibility with other software). Please read each EULA for details on the use conditions and items that must be observed regarding these software components.

The table below lists the software components preinstalled in the TOSHIBA Blu-ray Disc™/DVD player, which are subject to EULAs. The user should read the applicable EULAs carefully before using these software components. The EULAs are exhibited in their original text (English) as exactly written by the respective parties other than TOSHIBA.

For the Open-Source Software Included in the Blu-ray Disc™/DVD player, type <http://opensource.toshiba.com/version1> in your browser and click on the corresponding Open-Source Software License link.

The Open-Source Software included in the Blu-ray Disc™/DVD player is described in the table below. To view the Open-Source agreements, please type in <http://oss.bd.toshiba.com/version1> into your browser and click on the corresponding Open-Source Software License link provided. Additionally, the licenses can be viewed by typing in the URL addresses listed in the *License* column.

<i>OSS name</i>	<i>OSS version</i>	<i>OSS project URL</i>	<i>License</i>
Linux kernel	2.6.35	http://www.kernel.org	http://oss.bd.toshiba.com/version1/GPLv2.pdf
gcc libgcc	4.5.1	http://gcc.gnu.org/	http://oss.bd.toshiba.com/version1/GPLv3.pdf
gcc libstdc++	4.5.1	http://gcc.gnu.org/	http://oss.bd.toshiba.com/version1/GPLv3.pdf
glibc	2.12.1	http://www.gnu.org/software/libc/	http://oss.bd.toshiba.com/version1/LGPLv2.1.pdf
glibc (other licenses)	2.12.1	http://www.gnu.org/software/libc/	http://oss.bd.toshiba.com/version1/glibc_2.9.pdf

<i>OSS name</i>	<i>OSS version</i>	<i>OSS project URL</i>	<i>License</i>
SquashFS	3.4	http://squashfs.sourceforge.net/	http://oss.bd.toshiba.com/version1/GPLv2.pdf
SquashFS	4.1	http://squashfs.sourceforge.net/	http://oss.bd.toshiba.com/version1/GPLv2.pdf
iputils	s20101006	http://www.skbuff.net/iputils/	http://oss.bd.toshiba.com/version1/GPLv2.pdf
udhcp	0.9.8cvs20050303-3	http://udhcp.sourceforge.com/downloads/0.9.8cvs20050303-3/	http://oss.bd.toshiba.com/version1/GPLv2.pdf
net-tools	1.60	http://www.linuxfromscratch.org/blfs/view/6.3/basicnet/net-tools.html	http://oss.bd.toshiba.com/version1/GPLv2.pdf
sysvinit	2.88dsf	http://savannah.nongnu.org/projects/sysvinit	http://oss.bd.toshiba.com/version1/GPLv2.pdf
module-init-tools	3.12	https://modules.wiki.kernel.org/index.php/Main_Page	http://oss.bd.toshiba.com/version1/GPLv2.pdf
util-linux-ng	2.18	http://userweb.kernel.org/~kzak/util-linux-ng/	http://oss.bd.toshiba.com/version1/GPLv2.pdf
procps (ps, top)	3.2.8	http://procps.sourceforge.net/index.html	http://oss.bd.toshiba.com/version1/LGPLv2.1.pdf
psmisc	22.13	http://psmisc.sourceforge.net/	http://oss.bd.toshiba.com/version1/GPLv2.pdf
coreutils	6.9	http://www.gnu.org/software/coreutils/	http://oss.bd.toshiba.com/version1/GPLv2.pdf
gawk	3.1.5	http://www.gnu.org/software/gawk/	http://oss.bd.toshiba.com/version1/GPLv2.pdf
grep	2.5.1a	http://www.gnu.org/software/grep/	http://oss.bd.toshiba.com/version1/GPLv2.pdf
findutils	4.2.31	http://www.gnu.org/software/findutils/	http://oss.bd.toshiba.com/version1/GPLv2.pdf
bash	3.2.48	http://www.gnu.org/software/bash/	http://oss.bd.toshiba.com/version1/GPLv2.pdf
tar	1.17	http://www.gnu.org/software/tar/	http://oss.bd.toshiba.com/version1/GPLv2.pdf
sed	4.1.5	http://www.gnu.org/software/sed/	http://oss.bd.toshiba.com/version1/GPLv2.pdf
gzip	1.3.12	http://www.gnu.org/software/gzip/	http://oss.bd.toshiba.com/version1/GPLv2.pdf
inetutils	1.4.2	http://www.gnu.org/software/inetutils/	http://oss.bd.toshiba.com/version1/GPLv2.pdf
ncurses	5.7	http://www.gnu.org/software/ncurses/	http://oss.bd.toshiba.com/version1/ncurses.pdf

<i>OSS name</i>	<i>OSS version</i>	<i>OSS project URL</i>	<i>License</i>
gdb (gdbserver)	6.6	http://www.gnu.org/software/gdb/	http://oss.bd.toshiba.com/version1/GPLv2.pdf
Das U-Boot	2009.08	http://www.denx.de/wiki/U-Boot/WebHome	http://oss.bd.toshiba.com/version1/GPLv2.pdf
International Components for Unicode	3.2.0	http://www.icu-project.org/index.html	http://oss.bd.toshiba.com/version1/ICU.pdf
OpenSSL	0.9.8n	http://www.openssl.org/	http://oss.bd.toshiba.com/version1/OpenSSL.pdf
zlib	1.2.3	http://www.zlib.net/	http://oss.bd.toshiba.com/version1/zlib.pdf
FreeType	2.3.9	http://www.freetype.org/	http://oss.bd.toshiba.com/version1/FreeType.txt
Expat	2.0.1	http://expat.sourceforge.net/	http://oss.bd.toshiba.com/version1/Expat.pdf
libcurl	7.19.6	http://curl.haxx.se/	http://oss.bd.toshiba.com/version1/cURL.pdf
libjpeg	jpeg-7	http://www.ijg.org/	http://oss.bd.toshiba.com/version1/libjpeg.pdf
c-ares	1.4.0	http://c-ares.haxx.se/	http://oss.bd.toshiba.com/version1/c-ares.pdf
mtd-utils	1	http://www.linux-mtd.infradead.org/index.html	http://oss.bd.toshiba.com/version1/GPLv2.pdf
WPA Supplicant	0.5.10	http://hostap.epitest.fi/wpa_supplicant/	http://oss.bd.toshiba.com/version1/WPA_Supplicant.pdf
WPA Supplicant (WPS)	0.6.7	http://hostap.epitest.fi/wpa_supplicant/	http://oss.bd.toshiba.com/version1/WPA_Supplicant.pdf
Wireless Tools	29	http://www.hpl.hp.com/personal/Jean_Tourrilhes/Linux/Tools.html	http://oss.bd.toshiba.com/version1/GPLv2.pdf
DirectFB	1.2.7	http://www.directfb.org	http://oss.bd.toshiba.com/version1/LGPLv2.1.pdf
Fusion	8.2.0	http://www.directfb.org	http://oss.bd.toshiba.com/version1/GPLv2.pdf
SaWMan	1.4.0	http://www.directfb.org	http://oss.bd.toshiba.com/version1/LGPLv2.1.pdf
libpng	1.2.35	http://www.libpng.org/pub/png/libpng.html	http://oss.bd.toshiba.com/version1/libpng.txt
Qt	4.6.2	http://qt.nokia.com/products	http://oss.bd.toshiba.com/version1/LGPLv2.1.pdf

<i>OSS name</i>	<i>OSS version</i>	<i>OSS project URL</i>	<i>License</i>
libxml2	2.7.6	http://xmlsoft.org/	http://oss.bd.toshiba.com/version1/libxml.pdf
xmlrpc-c	1.06.38	http://xmlrpc-c.sourceforge.net/	http://oss.bd.toshiba.com/version1/XMLrpc.pdf
tinymce	2.5.3	http://sourceforge.net/projects/tinymce/	http://oss.bd.toshiba.com/version1/tinymce.pdf
gSOAP	2.7.12	http://www.cs.fsu.edu/~englen/soap.html	http://oss.bd.toshiba.com/version1/gSOAP.pdf
SQLite	3.6.22	http://www.sqlite.org/	http://oss.bd.toshiba.com/version1/SQLite.pdf
David M. Gay's dtoa and strtod		http://netlib2.cs.utk.edu/ftp/dtoa.c	http://oss.bd.toshiba.com/version1/DMG.pdf
Bison generated parser	2.3	http://www.gnu.org/software/bison/	http://oss.bd.toshiba.com/version1/bison.pdf
Doug Lea's malloc		ftp://g.oswego.edu/pub/misc/malloc.c http://gee.cs.oswego.edu/dl/html/malloc.html	http://oss.bd.toshiba.com/version1/dmalloc.pdf
EMX sprintf and scanf			http://oss.bd.toshiba.com/version1/EMX.pdf
JSON_Parser	1.0	http://www.json.org/	http://oss.bd.toshiba.com/version1/JSON.pdf
Lua interpreter	5.1.3	http://www.lua.org/license.html#5	http://oss.bd.toshiba.com/version1/Lua.pdf
zziplib	0.13.58	http://zziplib.sourceforge.net/	http://oss.bd.toshiba.com/version1/Zziplib.pdf
libavformat	52.31.0	http://ffmpeg.org/	http://oss.bd.toshiba.com/version1/LGPLv2.1.pdf
libavutil	49.15.0	http://ffmpeg.org/	http://oss.bd.toshiba.com/version1/LGPLv2.1.pdf
libavcodec	52.20.0	http://ffmpeg.org/	http://oss.bd.toshiba.com/version1/LGPLv2.1.pdf



Please Do The Following Before Returning This Product To The Store.

If you are experiencing a technical problem or have questions regarding operation, authorized service centers, warranty or parts, please contact our Customer Support Center at:

(888) 592-0944 **(From inside the United States)**

(949) 583-3305 **(From outside the United States)**

Many questions regarding parts, service, and warranties can be answered by visiting the Customer Support Section of our website:

support.toshiba.com

THANK YOU

TOSHIBA
Leading Innovation >>>

GMA501042011
01/12



Free Manuals Download Website

<http://myh66.com>

<http://usermanuals.us>

<http://www.somanuals.com>

<http://www.4manuals.cc>

<http://www.manual-lib.com>

<http://www.404manual.com>

<http://www.luxmanual.com>

<http://aubethermostatmanual.com>

Golf course search by state

<http://golfingnear.com>

Email search by domain

<http://emailbydomain.com>

Auto manuals search

<http://auto.somanuals.com>

TV manuals search

<http://tv.somanuals.com>