

© 2008 Toshiba Information Systems UK Limited. Toshiba and the Toshiba logo are trademarks of Toshiba Corporation in Japan and other countries.

Other trademarks and trade names may be used here to refer to the product. Toshiba disclaims proprietary interest in the marks and names of others.

G810-EN

TOSHIBA
Leading Innovation >>>

PORTÉGÉ
G810



User guide

G810

Table of contents

Preface 5

Toshiba Corporation 6

EU Warranty 9

Licenses 10

Declaration of conformity 12

Health and safety 13

General 13

Operating environment 14

Electronic devices 15

Battery safety 15

AC charger safety 16

Emergency calls 17

European RF Exposure Information 17

Care and maintenance 19

General 19

Battery care and maintenance 21

Restarting your Toshiba phone 22

Resetting your Toshiba phone 22

Reinitialising your Toshiba phone 23

Getting started 24

Unpacking 24

Phone layout and functions 25

Today screen 28

Start menu 29

Common status icons 30

Installing the SIM card and battery 33

Installing a microSD card 35

Removing and reinserting the stylus 36

Using the stylus 36

Charging the battery 37

Switching the power on and off 38

Keypad lock 39

Auto Configurator 39

TOSHIBA User Interface 40

Table of contents

Call functions 45

- Making a call 45
- Speed Dial 47
- Receiving a call 48
- Ending a call 48
- In-call options 49
- Video telephony 51
- Call History 52

Messaging 54

- Text messages 54
- MMS messages 56
- E-mail 60
- General messaging options 65

Text input 67

- Input methods 67
- Block Recognizer 67
- Keyboard 68
- Letter Recognizer 68
- Input Options 69
- Transcriber 69
- Drawing and writing on the screen 75
- Full Screen Keyboard 76

Table of contents

Applications and multimedia 77

Office Mobile 78
Calendar 79
Contacts 82
Internet Explorer 86
Games 89
TOSHIBA User Interface 90
ActiveSync 90
A-GPS 92
AutoInstall 92
BlackList 93
Calculator 94
Camera 95
Certificate Enrollment 97
File Explorer 97
FM Radio 97
Getting Started 99
Home 99
Image Editor 100
Image To Text 100
JBlend 102
Messenger 103

Notes 104
PicseL Viewer 105
Pictures & Videos 106
Search 107
SIM Toolkit 108
Streaming Player 108
Tasks 109
Windows Live 110
Windows Media 111

Connectivity 115

Wireless Manager 115
Bluetooth 116
Beam 119
Cell Broadcast 119
Internet connections 120
CSD Line 125
Domain Enroll 125
Internet Sharing 126
Network Mode 126
USB to PC 127
Wi-Fi 127

Table of contents

Settings 129

- Volume control 129
- Reassigning button functions 129
- Security settings 130
- Customising the Start menu 132
- Owner Information 133
- Phone settings 133
- Video Phone settings 138
- Sounds & Notifications 140
- Customising the Today screen 141
- About 142
- Backlight settings 143
- Certificates 143
- Clock & Alarms 144
- Customer Feedback 145
- Encryption 145
- Error Reporting 146
- External GPS 146
- Headset Volume Limiter 147
- Memory management settings 147
- Managed Programs 147
- Power settings 148

- Regional Settings 148
- Remove Programs 149
- Screen settings 149
- Spb Mobile Shell for Toshiba 150
- System Information 151
- Task Manager 152
- Windows Update 153

Specifications 154

Troubleshooting 157

Purchase record 161

Menu tree 162

End User License Agreements (EULAs) 164

Index 173

Preface

To use your Toshiba phone, you must have service from a wireless service provider. Many of the features in your Toshiba phone depend on features in the wireless network to function. These network services may not be available on all networks, or you may have to make specific arrangements with your service provider before you can utilise network services. Your service provider may need to give you additional instructions for their use and explain what charges will apply. Some networks may have limitations that affect how you can use network services. For instance, some networks may not support all language-dependent characters and services.

Please note that the **Messenger** and **Windows Live** applications described in this user manual may not be available on your Toshiba phone because support for these applications is dependent on your network service provider.

The availability of particular products may vary by region.

Due to the continual development of our products, Toshiba reserves the right to modify this document at any time without prior notice.

Toshiba Corporation



IMPORTANT: PLEASE READ THE FOLLOWING BEFORE USING YOUR MOBILE PHONE AS ATTEMPTING TO USE ANY SOFTWARE ON THE SUPPLIED PHONE CONSTITUTES YOUR ACCEPTANCE OF THESE EULA TERMS. IF YOU REJECT OR DO NOT AGREE WITH ALL THE TERMS OF THIS EULA, PLEASE DO NOT ATTEMPT TO ACCESS OR USE THE SUPPLIED SOFTWARE.

End User License Agreement

This End User License Agreement ("EULA") is a legal agreement between you (as the user) and TOSHIBA CORPORATION ("Toshiba") with regard to the copyrighted software installed in a Toshiba 3G mobile phone supplied to you (the "Phone").

Use or employment of any software installed in the Phone and related documentations (the "Software") will constitute your acceptance of these terms, unless separate terms are provided by the Software supplier on the Phone, in which case certain additional or different terms may apply. If you do not agree with the terms of this EULA, do not use or employ the Software.

- 1. License Grant.** Toshiba grants to you a personal, non-transferable and non-exclusive right to use the Software as set out in this EULA. Modifying, adapting, translating, renting, copying, making available, transferring or assigning all or part of the Software, or any rights granted hereunder, to any other persons, and removing any proprietary notices, labels or marks from the Software is strictly prohibited, except as expressly permitted in this EULA. Furthermore, you hereby agree not to create derivative works based on the Software.
- 2. Copyright.** The Software is licensed, not sold. You acknowledge that no title to the intellectual property in the Software is or will be transferred to you. You further acknowledge that title and full ownership rights to the Software will remain the exclusive property of Toshiba, Toshiba's affiliates, and/or their suppliers, and you will not acquire any rights to the Software, except as expressly set out in this EULA. You may keep a backup copy of the Software only so far as necessary for its lawful use. All copies of the Software must contain the same proprietary notices as contained in the Software and are subject to the terms of this EULA. All rights not expressly granted under this EULA are reserved

Toshiba Corporation

to Toshiba, Toshiba's affiliates and/or their suppliers.

3. **Reverse Engineering.** You agree that you will not attempt, and if you are a business organisation, you will use your best efforts to prevent your employees, workers and contractors from attempting, to reverse engineer, decompile, modify, translate or disassemble the Software in whole or in part except to the extent that such actions cannot be excluded by mandatory applicable law and only if those actions are taken in accordance with such applicable law. Any failure to comply with the above or any other terms and conditions contained herein will result in the automatic termination of this license and the reversion of the rights granted hereunder to Toshiba.
4. **LIMITED WARRANTY.** Only during the warranty period for the Phone, Toshiba, Toshiba's affiliates, its suppliers or its authorised service company will repair or replace, at Toshiba's sole discretion, defective Software unless such defect results from acts or incidences beyond the reasonable control of Toshiba. EXCEPT AS PROVIDED IN THIS EULA:
(A) TOSHIBA, TOSHIBA'S AFFILIATES, AND THEIR SUPPLIERS DISCLAIM ALL

WARRANTIES, CONDITIONS OR OTHER TERMS (WHETHER EXPRESS OR IMPLIED), INCLUDING BUT NOT LIMITED TO WARRANTIES, CONDITIONS AND TERMS OF SATISFACTORY QUALITY, MERCHANTABILITY, FITNESS FOR A PARTICULAR PURPOSE AND NON-INFRINGEMENT OF THIRD-PARTY RIGHTS; AND (B) THE ENTIRE RISK AS TO THE QUALITY AND PERFORMANCE OF THE SOFTWARE IS WITH YOU. YOU ACCEPT THAT SOFTWARE MAY NOT MEET YOUR REQUIREMENTS AND NO WARRANTY CAN BE GIVEN THAT OPERATION OF THE SOFTWARE WILL BE UNINTERRUPTED OR ERROR-FREE.

5. **LIMITATION OF LIABILITY.** TO THE FULLEST EXTENT LEGALLY PERMITTED, IN NO EVENT SHALL TOSHIBA, TOSHIBA'S AFFILIATES OR THEIR SUPPLIERS BE LIABLE TO YOU FOR ANY DAMAGES FOR (A) LOST BUSINESS OR REVENUE, BUSINESS INTERRUPTION, LOSS OF BUSINESS DATA; OR (B) CONSEQUENTIAL, SPECIAL, INCIDENTAL OR INDIRECT DAMAGES OF ANY KIND (WHETHER UNDER CONTRACT, TORT OR OTHERWISE) ARISING OUT OF: (I) THE USE

Toshiba Corporation

OR INABILITY TO USE THE SOFTWARE, EVEN IF TOSHIBA, TOSHIBA'S AFFILIATES OR THEIR SUPPLIER HAS BEEN ADVISED OF THE POSSIBILITY OF SUCH DAMAGES; OR (II) ANY CLAIM BY A THIRD PARTY. SAVE AS SET OUT IN THIS SECTION, TOSHIBA'S ENTIRE LIABILITY UNDER THIS EULA SHALL NOT EXCEED THE PRICE PAID FOR THE SOFTWARE, IF ANY. THE ABOVE DISCLAIMER AND LIMITATION DOES NOT EXCLUDE OR LIMIT (A) LIABILITY FOR DEATH OR PERSONAL INJURY CAUSED BY NEGLIGENCE; OR (B) ANY MANDATORY LEGAL RIGHT OR LIABILITY TO THE EXTENT THAT IT CANNOT BE LAWFULLY EXCLUDED OR LIMITED UNDER APPLICABLE LAW. PLEASE MAKE AND RETAIN A COPY OF ALL DATA YOU HAVE INSERTED INTO YOUR PRODUCT, FOR EXAMPLE NAMES, ADDRESSES, PHONE NUMBERS, PICTURES, RINGTONES ETC, BEFORE SUBMITTING YOUR PRODUCT FOR A WARRANTY SERVICE, AS SUCH DATA MAY BE DELETED OR ERASED AS PART OF THE REPAIR OR SERVICE PROCESS.

6. **Laws.** This EULA will be governed by the laws of England and Wales. All disputes arising out of this EULA shall be subject to the exclusive jurisdiction of the English Courts.
7. **Export Laws.** Any use, duplication or employment of the Software involves products and/or technical data that may be controlled under the export laws of applicable countries or region, and may be subject to the approval of the applicable governmental authorities prior to export. Any export, directly or indirectly, in contravention of the export laws of applicable countries or region is prohibited.
8. **Third Party Beneficiary.** You agree that certain suppliers of the Software to Toshiba have a right as a third party beneficiary to enforce the terms of this EULA against you as a user.
9. **Transfers.** The Software may be transferred only as installed on the Phone to a lawful third party user, where that party accepts the terms of this EULA, which will continue to apply.
10. IF YOU ARE DEALING AS A CONSUMER IN THE UK AND THE SOFTWARE QUALIFIES AS 'GOODS', YOUR STATUTORY RIGHTS UNDER APPLICABLE LAW ARE NOT AFFECTED.

Toshiba Corporation

EU Warranty

Your Toshiba phone, battery and AC charger contain no user serviceable parts. For further information on service, please contact your retailer or service provider.

Licenses

Licensed by QUALCOMM Incorporated under one or more of the following United States Patents and/or their counterparts in other nations:

4,901,307 5,504,773 5,109,390 5,535,239
5,267,262 5,600,754 5,416,797 5,778,338
5,490,165 5,101,501 5,511,073 5,267,261
5,568,483 5,414,796 5,659,569 5,056,109
5,506,865 5,228,054 5,544,196 5,337,338
5,657,420 5,710,784

Microsoft, Windows, Windows Mobile, Windows Live, Hotmail, Windows Media, ActiveSync, Internet Explorer, Outlook, Excel, PowerPoint and Word are either registered trademarks or trademarks of Microsoft Corporation in the United States and/or other countries.

ArcSoft and the ArcSoft logo are registered trademarks of ArcSoft, Inc.



The Bluetooth™ word mark and logos are trademarks owned by Bluetooth SIG, Inc.



Java™ and all Java-based marks are trademarks or registered trademarks of Sun Microsystems, Inc.



microSD™ and the microSD™ logo are trademarks.



Licenses

Picseel, Picseel Powered, Picseel Viewer, Picseel File Viewer, Picseel Document Viewer, Picseel PDF Viewer and the Picseel cube logo are trademarks or registered trademarks of Picseel Technologies and/or its affiliates.



The Wi-Fi CERTIFIED Logo is a certification mark of the Wi-Fi Alliance.



Declaration of conformity

We, **Toshiba Information Systems UK (Ltd), Mobile Communications Division**, of Toshiba Court, Weybridge Business Park, Addlestone Road, Weybridge, KT15 2UL declare under our sole responsibility that this product (G810, Type (Model) Name TK5-E01) is in conformity with the following standards and/or other normative documents:

EN 301 511, EN 301 908-1, EN 301 908-2, EN 50360, EN 50361, EN 301 489-1, EN 301 489-7, EN 301 489-17, EN 301 489-24, EN 300 328, EN 55013, EN 55020, EN 50392 and EN 60950

We hereby declare that all essential radio test suites, EMC & safety requirements have been carried out and that the above named product is in conformity to all the essential requirements of Directive 1999/5/EC.

The conformity assessment procedure referred to in Article 10(5) and detailed in Annex IV of Directive 1999/5/EC has been followed with the involvement of the following Notified Body(ies):

Cetecom ICT Services GmbH, Untertürkheimer Straße 6-10, D-66117 Saarbrücken, Germany

CE 0682 

20 March 2008



Takashi Okamoto
Deputy Managing Director of TIU
General Manager Mobile Communications Division

Health and safety

General

- Do not attempt to dismantle the phone or any of its accessories. Only qualified service personnel should repair the phone and its accessories.
 - Do not touch the phone, battery or AC charger with wet hands.
 - Keep your Toshiba phone, and all parts and accessories, out of the reach of small children and pets. The SIM card and other small parts could present a choking hazard.
 - Use only Toshiba approved batteries and accessories.
 - The bundled battery and AC charger are only for use with your Toshiba phone. Do not use this battery or AC charger with any other device.
 - Use of third party equipment (including batteries, cables and accessories) not manufactured or authorised by Toshiba may invalidate the warranty of your phone and adversely affect the operation of the phone.
 - Before connecting your Toshiba phone to another device, read the supporting documentation to confirm that the other device is compatible.
 - When using the headset, be careful not to listen at excessive volumes. Listening to loud sound levels may lead to hearing loss.
- It is recommended that pregnant and young women take precautions while in a call and keep the phone at a distance from their lower abdomen. For this situation, use of a hands-free kit is recommended.
 - Your phone contains metal that may cause skin irritation.
 - Do not operate the camera flash too close to somebody's eyes - this may cause damage to their eyes.

Health and safety

Operating environment

- Observe all local safety regulations regarding the use of mobile phones while driving.
- Pull off the road and park before making or answering a call.
- Do not stop on the hard shoulder of a motorway to answer or make a call, except in an emergency.
- If using an integrated hands-free device, make sure the phone is securely placed in its holder.
- Only qualified personnel should install the device in a vehicle. Faulty installation or service may be dangerous and may invalidate any warranty. For more information, consult your vehicle manufacturer or representative.
- Do not place objects, including either installed or portable wireless equipment, in the area over the airbag or in the airbag deployment area.
- Switch off your Toshiba phone when refuelling.
- Do not handle your Toshiba phone when operating machinery.
- Switch your Toshiba phone off if you are entering a hospital or health care facility. Medical equipment may be affected by phone usage.
- Switch your Toshiba phone off when travelling on an aircraft. The phone signal may interfere with systems in the aircraft. You are legally bound to comply with this recommendation.
- Switch your Toshiba phone off in any facility where posted notices prohibit phone usage. Always follow building regulations governing phone usage.
- Switch your Toshiba phone off when blasting is in progress, and observe all provided guidelines and regulations.
- Switch your Toshiba phone off in areas with potentially explosive atmospheres, such as fuel storage areas and spray paint facilities.
- Switch your Toshiba phone off when outdoors during an electrical storm.
- Keep your Toshiba phone away from fuel and chemicals.

Health and safety

Electronic devices

- If you wear a pacemaker, or are in the company of someone who does, you should be aware that there is a small risk of mobile phone usage interfering with the operation of the pacemaker. You should contact your doctor, or the manufacturer of the pacemaker, for more information. If you have any reason to suspect that interference is taking place, switch off your phone immediately.
- Mobile phone usage may interfere with some hearing aids. If this happens, you should contact your service provider or doctor for further information.
- Mobile phone usage may interfere with the functionality of inadequately shielded medical devices. Consult a physician or the manufacturer of the device to ensure safe procedures are used.
- Mobile phone usage may interfere with the functionality of any inadequately shielded electronic system in a motor vehicle. Examples include airbags and fuel injection systems. You should contact the manufacturer of the vehicle or system to ensure that the system is properly shielded.

Battery safety

- Only use batteries approved by Toshiba for use in this handset. There is a risk of explosion if the battery is replaced with an incorrect type.
- Only recharge the battery with the recommended charger supplied by Toshiba.
- Stop using the battery if you detect any abnormalities, such as odour, discolouration or heat during use, charging or storage.
- Do not use your Toshiba phone with a damaged battery.
- When the charger is not in use, disconnect it from the power source.
- Do not short-circuit the battery. Accidental short-circuiting can occur when a metallic object causes a direct connection between the + and - terminals of the battery.
- Do not touch the battery terminals.
- Do not leave the battery in areas of extreme cold or heat.
- Never soak the battery in water or any other liquid.
- Never attempt to open the battery. The battery contains substances that may be harmful if swallowed or allowed to come into contact with unprotected skin.

Health and safety

- In the unlikely event of a battery leak, take care to keep the battery discharge away from your eyes and skin. If the leakage does come into contact with eyes or skin, flush thoroughly with clean water and consult a doctor.
- Do not dispose of the battery in a fire.
- Do not dispose of the battery in a regular waste container. The battery contains toxic chemicals and must be disposed of appropriately. Contact your local authorities for more information.

AC charger safety

- Do not use a damaged or worn AC charger. The use of a damaged or worn AC charger could result in electric shock, burns or fire. Contact an authorised Toshiba service provider immediately to obtain suitable replacements.
- Do not bend or twist the cable of the AC charger.
- Do not pull on the cable of the AC charger in order to remove the plug from a socket. Grasp the plug directly when unplugging the AC charger to avoid causing any damage to the cable.
- Do not touch the pins of the plug when connecting or disconnecting it from a power source.
- Do not place heavy objects on the AC charger.

Health and safety

Emergency calls

When making emergency calls from your Toshiba phone, ensure that the phone is switched on and in service.

Calls cannot be made to emergency services while data communication is being performed within a GSM area. Also, calls may not be able to be made to emergency services depending on the network services of some service providers.



IMPORTANT: You can still make calls to emergency services when the SIM card is not inserted, the SIM card is locked, the phone is locked, **Call Barring** is set, or **Fixed Dialing** is set.

There is no guarantee that a connection can be established in all countries and areas because operation of your phone differs depending on the wireless network, wireless signal and your setting status. Do not rely solely on your mobile phone when you need to make emergency calls.

European RF Exposure Information

Your Toshiba phone is a radio transmitter and receiver. It is designed not to exceed the limits for exposure to radio waves recommended by international guidelines. These guidelines were developed by the independent scientific organisation ICNIRP and include safety margins designed to assure the protection of all persons, regardless of age and health.

The guidelines use a unit of measurement known as the Specific Absorption Rate, or SAR. The SAR limit for mobile devices is 2 W/kg and the SAR value for this device when tested at the ear was 0.684 W/kg*.

As SAR is measured utilising the device's highest transmitting power, the actual SAR of this device while operating is typically below that indicated above. This is due to automatic changes to the power level of the device to ensure it only uses the minimum level required to reach the network.

The World Health Organization has stated that present scientific information does not indicate the need for any special precautions for the use of mobile devices. They state that if you want to reduce your exposure then you can do so by limiting the length of calls or using a 'hands-free' device to keep

Health and safety

the mobile phone away from the head and body. Additional Information can be found on the website of the World Health Organization (<http://www.who.int/emf>).

* The tests are carried out in accordance with international guidelines for testing.

The following Information is only for European Union Member States:



The use of the above symbol indicates that this product may not be treated as household waste. By ensuring this product is disposed of correctly, you will help prevent potential negative consequences for the environment and human health, which could otherwise be caused by inappropriate waste handling of this product. For more detailed information about recycling of this product, please contact your local city office, your household waste disposal service or the shop where you purchased the product.

Please recycle the cardboard packaging supplied with this phone.

Care and maintenance

General

You can greatly enhance the lifespan of your Toshiba phone, and the parts and accessories, by following the suggestions below.



TIP: Maintaining your Toshiba phone, and the parts and accessories, in a good condition will help you fulfil the warranty obligations.

- Always use your Toshiba phone in the intended manner. Incorrect usage may affect performance.
- To avoid permanent damage to your Toshiba phone, use only Toshiba approved batteries and accessories.
- The bundled battery and AC charger are only for use with your Toshiba phone. Do not use this battery or AC charger with any other device. This could cause permanent damage to the device, battery or charger.
- Use of third party equipment (including batteries, cables and accessories) not manufactured or authorised by Toshiba may invalidate the warranty of your phone and adversely affect the operation of the phone.
- Before connecting your Toshiba phone to another device, read the supporting documentation to confirm that the other device is compatible.
- Keep your Toshiba phone, and all parts and accessories, out of the reach of small children and pets.
- Do not allow your Toshiba phone, battery or accessories to come into contact with liquids or moisture. Moisture of any kind can corrode the electronic circuits. The manufacturer's warranty may become invalid if the phone or battery get wet due to misuse.
- Do not use or store your Toshiba phone in dusty or dirty locations.
- Do not use or store your Toshiba phone in hot areas. High temperatures will shorten the lifespan of the phone, damage the battery, and warp/melt internal circuits.
- Do not store your Toshiba phone in, or near, direct heat sources such as radiators. This could cause the battery to overheat and explode.
- Do not store your Toshiba phone in cold areas. A big difference between room temperature and the temperature in the phone can cause condensation to form inside the phone, damaging the electronic circuits.
- Do not place your Toshiba phone alongside computer disks, credit cards, travel cards and other magnetic media. Information contained on

Care and maintenance

- disks or cards may be affected by the phone.
- Do not expose your Toshiba phone to strong magnetic fields. This may cause temporary malfunction.
- Do not open your Toshiba phone unless absolutely necessary.
- Do not mishandle or abuse your Toshiba phone. Dropping the phone, or knocking or shaking it, can damage the internal circuits.
- Do not apply paint or other such substances to your Toshiba phone.
- Interference may affect the performance of your Toshiba phone. This is normal and the phone should operate as normal once you move away from the source of the interference.
- If your Toshiba phone, or any of the accessories, are not working as they should, please consult your dealer. They can provide you with the expert assistance you require.
- Do not attempt to disassemble your Toshiba phone. Only Toshiba authorised personnel should service the phone.
- When your Toshiba phone is set to vibrate, the vibration may cause the phone to move. Take care not to place the phone near a heat source or the edge of a high surface.
- Only use a soft, clean cloth to clean your Toshiba phone. Do not use chemicals, detergents, abrasive substances, or any liquids. Use a cotton swab to clean the camera lens.
- Do not use water to clean the touch screen.
- Keep the touch screen and tip of the stylus clean to avoid permanent damage.
- Keep sharp objects away from the touch screen to avoid it being scratched and damaged.
- For touch screen input, use only the included stylus or your finger. Use of other objects can damage the input panel and will void the warranty.
- If the tip of the stylus is damaged, do not use it. If you operate the touch screen with a damaged stylus, the touch screen may be damaged. When the stylus is damaged, please purchase a new one.
- Do not tap hard on the touch screen, as this may cause permanent damage to the screen.
- To avoid scratches on the touch screen, avoid placing your Toshiba phone with the touch screen facing downwards.
- It is recommended that you use the bundled stylus when pressing the **Reset button**.

Care and maintenance

Battery care and maintenance

Your Toshiba phone is powered by a rechargeable Lithium ion (Li-ion) battery.

The full performance of a new battery is achieved only after two or three complete charge and discharge cycles.

The battery can be charged and discharged hundreds of times, but it will eventually wear out. When the talk and standby times are noticeably shorter than normal, it is recommended that you buy a new battery.

- A new battery, or one that has not been used for a long time, could have reduced capacity during initial use.
- Do not leave the battery connected to the charger and power source for longer than necessary. This will result in repeated short charging, which will reduce battery performance and lifespan. Please disconnect the AC charger when the battery is full.
- Do not leave the battery in areas of extreme cold or heat. This could affect the performance of the battery.
- The battery has optimum performance in an ambient temperature of between +5 °C (+41 °F) and +35 °C (+95 °F).

- Only remove the battery with the phone switched off.
- Do not leave the battery empty or disconnected for a long time, as this may cause data to be reset.
- If you are not going to use your phone for a long time, fully charge the battery, then switch off the phone. The phone should be stored in a dry place away from direct sunlight. Recharge the phone approximately every six months.
- Avoid repeated short charging. It is preferable to let the battery go flat and then recharge it completely.

Care and maintenance

Restarting your Toshiba phone

If you have any problems, such as the phone freezing, restart the phone.

To restart your Toshiba phone:

1. Press and hold the **Power key**.
2. Tap **Yes** to confirm powering off the phone.
3. Wait a few seconds, then press and hold the **Power key** to switch on the phone.

 **IMPORTANT:** If you restart your Toshiba phone, data that you have not saved will be lost.

If, after you have restarted your Toshiba phone, there is still a problem:

1. Remove the battery (refer to **Getting started** for instructions).
2. Re-insert the battery, then switch on the phone (refer to **Getting started** for instructions).

Resetting your Toshiba phone

If you still have problems after restarting your phone, you can reset the phone.

Resetting your Toshiba phone causes it to restart and adjust memory allocation. Your phone will return to the same status as the last time you used it, though unsaved data may be lost.

To reset your Toshiba phone:

Using the stylus, press and hold the **Reset button**. The phone will switch on after resetting.

 **IMPORTANT:** If you reset your Toshiba phone, data that you have not saved may be lost.

Care and maintenance

Reinitialising your Toshiba phone

Reinitialising your Toshiba phone resets all settings to their factory defaults, and deletes all of your data. You should only use this procedure as a last resort. We recommend that you back up all of your data before resetting your Toshiba phone.

If you are experiencing a problem with an application, it is most likely a result of a conflict between installed programs. We recommend uninstalling the most recently added program first. Also verify that the program is designed to be run on your Toshiba phone by comparing the requirements to the information provided with your phone. To view this information:

1. From the **Today** screen, tap **Start > Settings**.
2. Tap the **System** tab.
3. Tap **About**.

To reinitialise your Toshiba phone:

1. With your Toshiba phone switched off, press and hold both **Volume keys**.
2. While keeping the the **Volume keys** pressed, press the **Power key** for approximately three seconds.
3. Wait for the touch panel to load.
4. Press **Y** to reinitialise your Toshiba phone, or **N** to cancel. Your phone will restart.



IMPORTANT: If you reset your Toshiba phone, any applications that you have installed will be deleted. You will also lose all personal data such as music, ringtones and pictures.



IMPORTANT: It is recommended that you frequently back up the data on your Toshiba phone.



TIP: This procedure is also referred to as a hard reset.

Getting started

Unpacking

Please ensure that the contents of your sales pack include:

- Your Toshiba phone
- Battery
- AC charger
- USB cable
- Headset
- User guide
- CD (Getting Started)



NOTE: If any of the items listed above are missing, contact the retailer where you purchased your Toshiba phone.

Getting started

Phone layout and functions

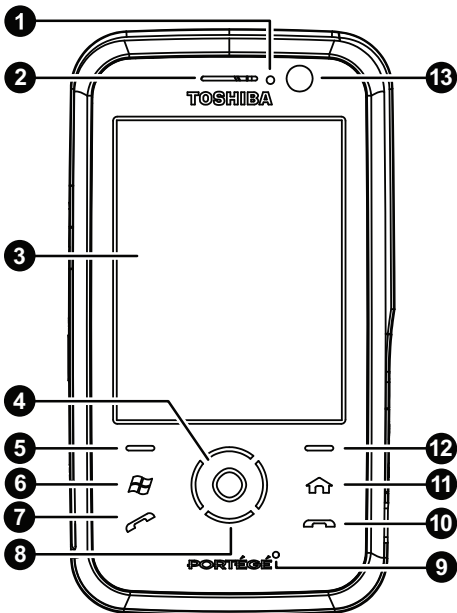

1. **LED indicator** - indicates various states of the phone.
 Red- Phone is charging.
 Red flashing - charging from very low battery.
 Blue flashing - Bluetooth™ wireless technology is active.
 Green flashing slowly - new message received.
 Green flashing quickly - incoming call.
2. **Earpiece**
3. **Touch screen**
4. **Action key** - press to select items and confirm operations.
5. **Left softkey** - press to perform operations indicated on the touch screen.
6. **Start key** - press to access the **Start** menu.
7. **Send key** - short press to access the **Phone** screen, and make, answer and hold calls, long press to activate speakerphone while in a call.
8. **Navigation keys** - press to scroll up, down, left and right.
9. **Microphone**
10. **End key** - press to end calls or operations and return to the **Today** screen.
11. **Home key** - press to access the **Home** screen.
12. **Right softkey** - press to perform operations indicated on the touch screen.

Getting started

13. Front camera lens

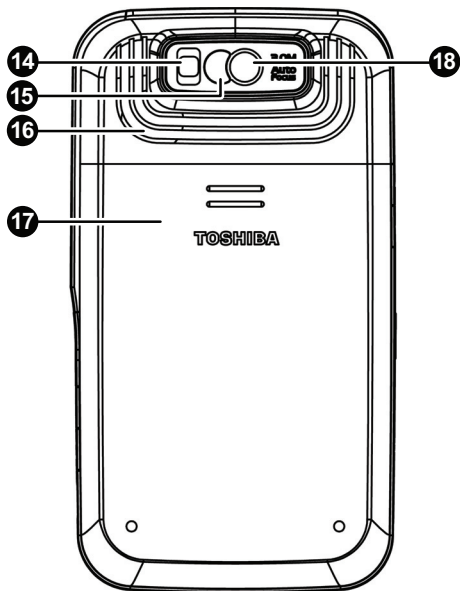

14. **Camera flash**

15. **Preview mirror** - used when taking a self-portrait photo.

16. **Speaker**

17. **Battery cover**

18. **Rear camera lens**

Getting started

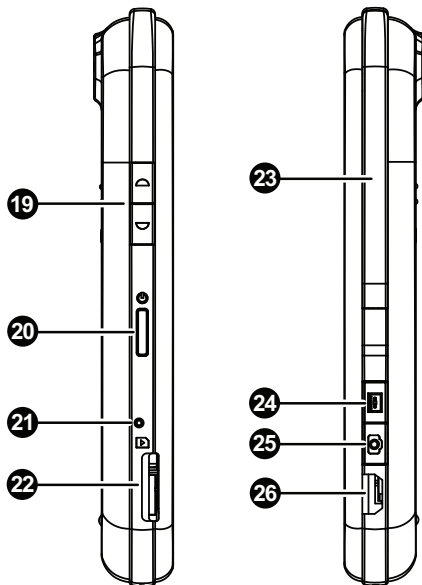

19. **Volume keys** - press the upper key to increase the volume, and the lower key to decrease the volume.
20. **Power key** - short press to enter/leave standby mode, long press to switch phone on/off.
21. **Reset button** - press using the stylus to reset the phone.
22. **microSD card slot**
23. **Stylus and stylus slot**
24. **Record key** - short press to access the **Notes** application, long press to record a voice note.
25. **Camera key** - press to launch the **Camera** application.
If **Camera** application is already running, press to capture a photo or begin recording of a video clip.
26. **Cable, phone charging and headset connector** (mini USB)

Getting started

Today screen

Important information such as date, time, status indicators and appointments is displayed on the **Today** screen.

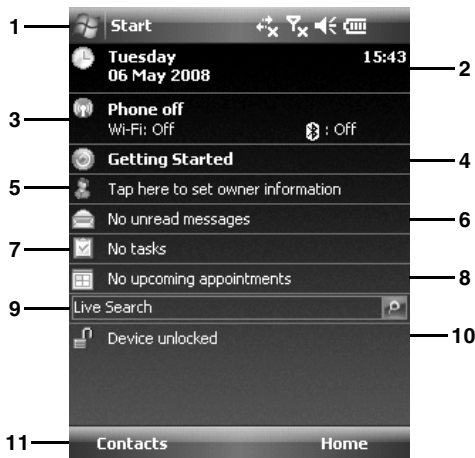

1. Title bar. Status icons are also displayed here.
2. Time and date. See **Clock & Alarms** in **Settings** for information on setting the time and date.

3. Name of wireless service provider, and Wi-Fi and Bluetooth status. See the **Connectivity** section for further information about these items.
4. **Getting Started**. Tap this item to view instructions on carrying out simple operations on your Toshiba phone.
5. Owner information. See **Owner Information** in **Settings** for details on setting the owner information.
6. Unread messages. See the **Messaging** section for information about messages.
7. Tasks. See **Tasks** in **Applications and multimedia** for information about tasks.
8. Upcoming appointments. See **Calendar** in **Applications and multimedia** for information about appointments.
9. **Live Search**. See **Searching the Internet using Live Search** in **Applications and multimedia** for further information.
10. Lock status.
11. Command bar. These buttons are dynamic, and depend on previous activity on the phone.

You can open an application directly by tapping it. To access the **Today** screen at any time, press the **End key**.

Getting started

For information on customising the **Today** screen, refer to **Customising the Today screen** in **Settings**.

Start menu

To access the **Start** menu, tap **Start** from the **Today** screen.

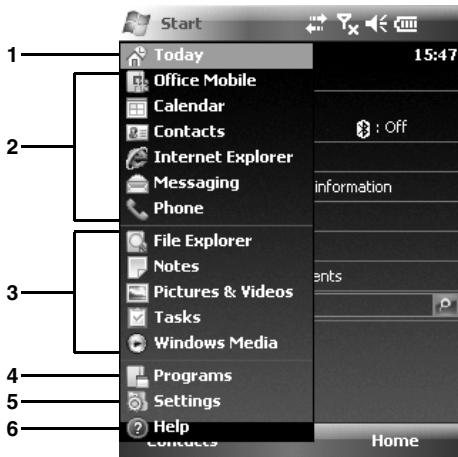



















1. **Today**
2. Pinned applications.
3. Recently used applications.
4. **Programs**. See the **Applications and multimedia** section for information about the programs/applications on your Toshiba phone.
5. **Settings**. See the **Settings** section for information about the settings on your Toshiba phone.
6. **Help**
Tap the required item to access it.

Getting started













Common status icons

Type	Icon	Description
Radio signal icons		Signal strength
		No signal
		No radio service. The phone has not yet connected to a network.
		Radio signal lost. The phone is searching for a signal.
		Phone set to Off. Refer to Switching radio transmission on/off in Connectivity for details.
		GPRS available
		EDGE available
		3G/UMTS available
		HSDPA available
		Connecting to GPRS
		Connecting to EDGE
		Connecting to 3G/UMTS
		Connecting to HSDPA
		Active GPRS connection
		Active EDGE connection
		Active 3G/UMTS connection
		Active HSDPA connection
		Roaming

Getting started

Type	Icon	Description
Connectivity icons		Bluetooth set to On . Refer to Changing Bluetooth mode in Connectivity for details.
		Incoming beam. Refer to Beam in Connectivity for details.
		Wi-Fi set to On . Refer to Wi-Fi in Connectivity for details.
		Wi-Fi network(s) in range.
		Animated - connecting to a Wi-Fi network. Static - connected to a Wi-Fi network.
Call icons		Call in progress
		Data call in progress
		Call on hold
		Speakerphone on
		Calls forwarded
		Missed call
Volume icons		Ringer on for incoming calls ¹
		Ringer off for incoming calls ¹
		Vibrate for incoming calls ¹
Notification icons		New message(s) received (includes voice mail messages) ²
		New voice mail message received ²
		New instant message(s) received
		New MMS message(s) received

Getting started

Type	Icon	Description
Notification icons		Multiple notifications. This icon is displayed when there are multiple occurrences that would normally each display an icon, for example, when there is a missed call and a message received. This icon is displayed automatically after the last notification icon has been displayed briefly. You can tap this icon to view the individual notifications.
Battery icons		Battery level
		Battery level low
		Battery charging
ActiveSync icons		Synchronisation over GPRS in progress
		Synchronisation over EDGE in progress
		Synchronisation over 3G/UMTS in progress
		Synchronisation over Wi-Fi in progress
		Synchronisation error
Other icons		Alarm pending
		No SIM card
		Headset connected

¹ The volume control window is displayed when you tap these icons. Refer to **Volume control** in **Settings** for further details.

² The type of voice mail message indicator displayed is dependent on your service provider. Your service provider may also allow you to select the type of voice mail notification that you receive. Please contact your service provider for details.

Getting started

Installing the SIM card and battery

⚠ WARNING: There is a danger of explosion if the battery is incorrectly replaced. To reduce risk of fire or burns, do not disassemble, crush, puncture, short external contacts, expose to temperature above 60°C (140°F), or dispose of battery in fire or water. Replace only with specified batteries according to the local regulations.

i IMPORTANT: The SIM card is easily damaged by scratching and bending, so take care when handling it.

i IMPORTANT: Keep SIM card away from static, dust and water.

i IMPORTANT: Power off the phone and disconnect the charger before inserting or removing the SIM card.

To install the SIM card and battery:

1. With the back of the phone facing up, press down on the back cover. Slide the cover as shown in the diagram below, and remove it from the phone.

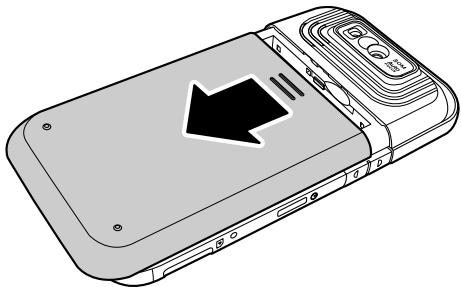

Getting started

2. If the battery is already installed, lift the tab at the base of the battery. Remove the battery from its compartment.
3. With the gold connectors facing downwards, align the SIM card the correct way, as shown in the diagram below. Push down lightly while sliding the SIM card into place.
4. Insert the battery into the battery compartment with the gold connectors facing towards the bottom of the phone. The battery is shaped so that it can only be inserted this way. Gently push on the bottom of the battery (non-connector end) to insert it completely.

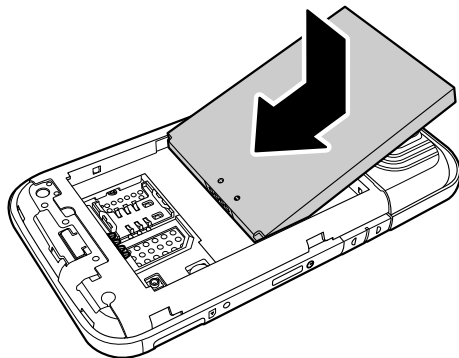
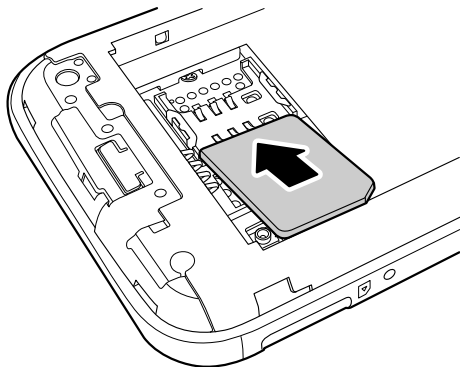

Getting started

5. Gently slide the back cover upward into place.



Installing a microSD card

A microSD card is a removable storage card that can be used to increase the memory of the phone.

i IMPORTANT: Do not remove the microSD card while the phone is reading data from, or writing data to, the card.

To install a microSD card:

1. With the gold connectors facing upwards, align the microSD card the correct way, as shown in the diagram below.

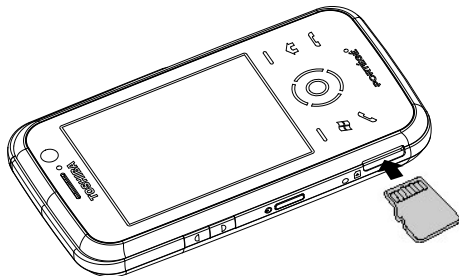

2. Gently slide the microSD card into the slot until it clicks into place.

To remove the microSD, gently press it inwards. It will automatically eject.

Getting started

Removing and reinserting the stylus

- Remove the stylus by pushing it upwards along the side of the phone (from above the **Record key**) sliding it towards the top of the phone, as shown in the diagram below.
- To reinsert the stylus, slide it downwards along the side of the phone until it clicks into place.

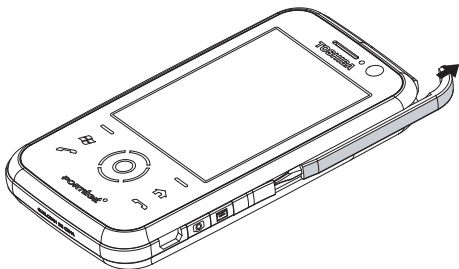

Using the stylus

The stylus is used for menu selection and data input on the touch screen of your Toshiba phone.

- Tap: Touch the screen once with the stylus to open items and select options.
- Drag: Hold the stylus on the screen and drag it to select text and images. Drag in a list to select multiple items.
- Tap and hold: Tap and hold the stylus on an item to see a list of actions available for that item. On the pop-up menu that is displayed, tap the required action.



WARNINGS:

- For touch screen input, use only the included stylus or your finger. Use of other objects can damage the touch screen and will void the warranty.
- If the tip of the stylus is damaged, do not use it. If you use the touch screen with a damaged stylus, the touch screen may be damaged. When the stylus is damaged, please purchase a new one.
- Do not tap hard on the touch screen, as this may cause permanent damage to the screen.

Getting started

Charging the battery

You will need to fully charge the battery before you can switch your Toshiba phone on for the first time. You can charge your battery in the following two ways:

- Either plug the AC charger into an AC outlet and connect it to the charger connector on your Toshiba phone. When the battery is fully charged, unplug the AC charger from the AC outlet and disconnect it from the phone charger connector by gripping it tightly and pulling gently, or
- connect your Toshiba phone to a PC with the USB cable.



IMPORTANT: Do not remove the battery while it is charging.

Fully charging the battery may take up to four hours when using the AC charger, or up to eight hours when using the USB cable.

The battery will only achieve optimum performance after two or three complete charges.

When charging is complete, disconnect the AC charger from the power source, or the USB cable from the PC, then disconnect your Toshiba phone.

Low battery

When the battery charge level drops to 20% of its total capacity, an alert message and the low battery icon are displayed.

If the battery charge level runs too low for normal operation, your Toshiba phone will automatically switch off.

Battery information

Battery performance depends on many factors, such as your service provider's network configuration, signal strength, the temperature of the environment in which you operate your Toshiba phone, the features and/or settings you select and use, items attached to your phone's connecting ports, and your voice, data, and other program usage patterns.



NOTE: It is recommended that you save the data in your phone memory to a PC or storage card. The manufacturer is not responsible for data lost or altered due to battery discharge.



TIP: For information on optimising the power performance of your Toshiba phone, refer to **Backlight settings** and **Power settings** in **Settings**.

Getting started

Managing a low battery

When the low battery alert is displayed, you should do the following:

1. Save your current data.
2. Charge the battery as soon as possible.
3. If you are unable to charge the battery immediately, we recommend that you switch off your phone.

Switching the power on and off

To switch your Toshiba phone on:

1. Press and hold the **Power key**.
2. If a PIN or security code is requested, enter the code.



WARNING: The PIN code activates the services in your Toshiba phone and should be provided in the documentation supplied by your service provider.

If you enter the incorrect PIN for your SIM card three consecutive times, you will need to contact your service provider to obtain the Personal Unblocking Key (PUK). Do not attempt to guess the PUK as your SIM card will be rendered permanently inoperative following ten consecutive unsuccessful attempts.

To switch your Toshiba phone off:

1. Press and hold the **Power key**.
2. Tap **Yes** to confirm powering off the phone.

Getting started

Keypad lock

This feature prevents accidental calls and operations.



NOTE: Emergency calls can be placed at any time, without requiring deactivation of any security feature first.

Locking the keypad

To lock the keypad, on the **Today** screen, tap **Device unlocked**.

Unlocking the keypad

To unlock the keypad, tap the **Unlock** softkey, then tap **Unlock** on the screen.

Auto Configurator

The **Auto Configurator** application provides a quick and easy way to configure service provider settings, including GPRS, WAP, and MMS.

To use **Auto Configurator**:

1. From the **Today** screen, tap **Start > Programs**.
2. Tap **AutoConfig**.
3. Select your country in the **Country** field.
4. Select your service provider in the **Operator** field.
5. Tap **ok**.
6. Tap **Yes**. The configuration is carried out. This may take a few seconds.

Getting started

TOSHIBA User Interface

Overview

The **TOSHIBA User Interface** provides a customisable user interface and behaviour, while keeping all the advantages of a Windows Mobile device.

The **TOSHIBA User Interface** enables you to access information, run applications, make calls and navigate your Toshiba phone in a simple and flexible manner, even using one hand.

You can customise items such as the **Now Screen**, **Today** plug-in, softkeys, tabs and weather updates.

For details of customising the **TOSHIBA User Interface**, refer to **Spb Mobile Shell for Toshiba in Settings**.

The **TOSHIBA User Interface** consists of three main screens:

- **Home** screen
- **Now Screen**
- Quick Dial screen

All of these screens are designed for one-handed stylus-free navigation, and animated transitions are supported.

You can use a left or right gesture, or tap the appropriate icons, to switch between these screens. You can also use a left gesture to return to the previous menu level.

Slide your finger in a downwards gesture or tap the exit icon to return to the **Today** screen or last active application.

Getting started

Home screen

The **Home** screen adds a fast and convenient way to navigate through your Toshiba phone. It has been designed for one-handed navigation and stylus-free use.

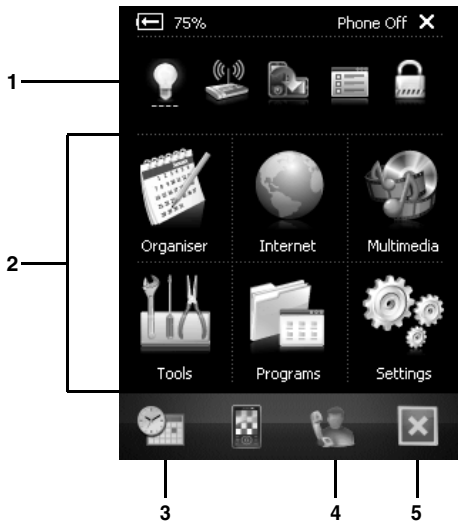

1. Smart launcher.
2. Menu style icons.
3. To access the **Now Screen**.
4. To access the Quick Dial screen.
5. To exit the **TOSHIBA User Interface**.

The **Home** screen consists of two parts - a smart launcher in the top part of the screen, and six menu style items below.

The smart launcher uses an algorithm to display shortcuts for frequently used items. You can tap and hold on any of the smart launcher items to customise the shortcuts.

The six menu style icons enable you to quickly and easily access items available via the standard Windows Mobile user interface, along with some extras such as **Phone Profiles**.

Getting started

Now Screen

The **Now Screen** displays all of your important information in one place.



1. Weather, messaging, call and phone volume information.
2. Time, date and calendar information.
3. To access the **Home** screen.
4. To access the **Quick Dial** screen.
5. To exit the **TOSHIBA User Interface**.

Getting started

Quick Dial screen

The Quick Dial screen displays up to sixteen photo contacts of your choice for quick access.

You can also keep a shortcut to all your **Toshiba Contacts** here.

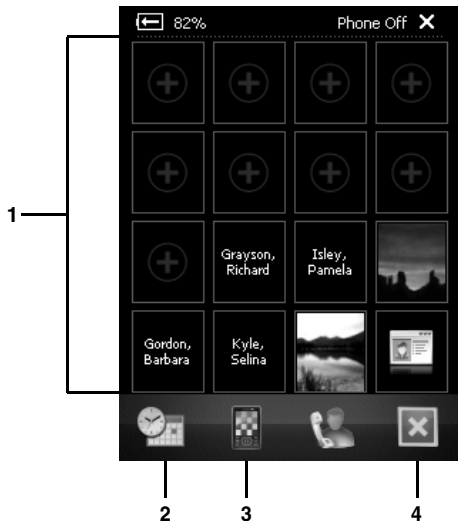

1. Contacts for quick access.
2. To access the **Now Screen**.
3. To access the **Home** screen.
4. To exit the **TOSHIBA User Interface**.

You can add your favourite contacts from those stored in **Contacts** on your Toshiba phone. You can also add a shortcut to **Recent Calls**.

Tap and hold on an entry to view the available options.

To make a call from the Quick Dial screen:

1. Tap the required Quick Dial entry.
2. Tap the phone number to call.

Getting started

Today plug-in

The **TOSHIBA User Interface** also contains a **Today** plug-in that enables you to add **TOSHIBA User Interface** items to the **Today** screen.

For information on setting up the **Today** plug-in, refer to **Customising the TOSHIBA User Interface** in **Settings**.

Call functions

Making a call

Before making a call, ensure that your Toshiba phone is switched on, that there is a valid SIM card installed, and that the signal is sufficiently strong.

Making a call from the Phone screen

To make a call from the **Phone** screen:

1. From the **Today** screen, press the **Send key** or tap **Start > Phone**.
2. Enter a phone number using the numeric keypad.
3. Press the **Send key** or tap **Talk**.



TIP: When you tap a key on the numeric keypad, a list of names and/or numbers is displayed. This list shows matching names and numbers from **Contacts**, **Call History**, **Speed Dial** and the SIM card.

For example, if you tap **2**, names beginning with **A**, **B** or **C** and phone numbers beginning with **2** are displayed.

You can enter more characters to reduce the number of matching entries.

To call an entry, tap it, then tap **Call**.

Making an emergency call

You can make calls to emergency service numbers under almost any circumstances, even if you have locked your Toshiba phone or if you have not enabled your SIM.

For further information, see **Emergency calls** in **Health and safety**.

Making a call from Contacts

To make a call from **Contacts**:

1. From the **Today** screen, tap **Contacts** or **Start > Contacts**.
2. Scroll to the required contact, then press the **Send key**.



TIP: If you have a long list of contacts, enter the first few letters of the contact's name. The phone will display only the matching contact. To call the contact, press the **Send key**.

Making a call to a non-default number

You can assign a work phone number (**w**), mobile phone number (**m**) and home phone number (**h**) to a contact that is saved to the phone.

The mobile phone number is dialled by default.

Call functions

To make a call to a non-default number:

1. From the **Today** screen, tap **Contacts** or **Start > Contacts**.
2. Tap the required contact.
3. Scroll to the required phone number, then press the **Send key** or **Action key**, or tap **Call**.

Making a call from Call History

Call History displays calls you have made, received, and missed recently.

To make a call from the **Call History**:

1. From the **Today** screen, press the **Send key** or tap **Start > Phone**.
2. Tap **Hide Keypad**.
3. Tap **Call History**.
4. Scroll to the required name or phone number, then press the **Send key** or tap **Call**.

Dialling the last number called

To dial the last number called:

From the **Today** screen, press the **Send key** twice.

Making an international call

To make an international call:

1. From the **Today** screen, press the **Send key** or tap **Start > Phone**.
2. Tap and hold **0** on the keypad until the **+** sign is displayed.
3. Enter the full phone number, including the country code, area code (without the first **0**) and phone number.
4. Press the **Send key** or tap **Talk**.

Call functions

Speed Dial

Creating a speed dial

To create a speed dial:

1. From the **Today** screen, press the **Send key** or tap **Start > Phone**.
2. Tap **Hide Keypad**.
3. Tap **Speed Dial**.
4. Tap **Menu > New**.
5. Tap the required contact.
6. In the **Location:** field, select the speed dial number.
7. Tap **ok** twice.



NOTE: The digit **0** is reserved for inserting the **+** character when dialling an international phone number. The digit **1** is reserved for calling your voice mail mailbox as a speed dial.



TIP: You can also create a speed dial from **Contacts**. To do this:

1. From **Contacts**, tap the required contact.
2. Scroll to the required phone number, then tap **Menu > Add to Speed Dial...**
3. In the **Location:** field, select the speed dial number.
4. Tap **ok** twice.

Setting up voice mail speed dial

The voice mail speed dial is normally preconfigured. If it is not preconfigured, you can save your voice mail number to the phone manually.

To set up voice mail speed dial manually:

1. From the **Today** screen, tap **Start > Settings**.
2. On the **Personal** tab, tap **Phone**.
3. Tap the **Services** tab.
4. Tap **Voice Mail and Text Messages**, then tap **Get Settings...**
5. Enter your voice mail number in the **Voice Mail:** field. This can be obtained from your service provider.
6. Tap **ok** twice.

Call functions

Making a call using speed dial

To make a call using speed dial:

1. From the **Today** screen, press the **Send key** or tap **Start > Phone**.
2. Tap **Hide Keypad**.
3. Tap **Speed Dial**.
4. Scroll to the required speed dial, then press the **Send key** or tap **Call**.



TIP: You can also make a call using speed dial from the **Phone** screen. To do this:

From the **Phone** screen, tap and hold the required speed dial number on the keypad. If the speed dial number has two digits, tap the first digit, then tap and hold the second digit.

Deleting a speed dial

To delete a speed dial:

1. From the **Today** screen, press the **Send key** or tap **Start > Phone**.
2. Tap **Hide Keypad**.
3. Tap **Speed Dial**.
4. Scroll to the required speed dial, then tap **Menu > Delete**.
5. Tap **Yes** to confirm the deletion.
6. Tap **ok**.

Receiving a call

Answering or ignoring a call

- To answer an incoming call, press the **Send key** or tap **Answer**.
- To ignore an incoming call, press the **End key** or tap **Ignore**.



NOTE: If you choose to ignore a call, the caller will be connected to your voice mail, provided you are subscribed to this service.



TIP: When you have the headset connected to your Toshiba phone, you can do the following:

- Answer an incoming call by pressing the headset button.
- Ignore an incoming call by pressing and holding the headset button.

Ending a call

To end a call, press the **End key** or tap **End**.



TIP: When you have the headset connected to your Toshiba phone, you can end a call by pressing and holding the headset button.

Call functions

In-call options

Adjusting the volume

To adjust the volume while in a call:

Press the upper volume key to increase the volume, and the lower volume key to decrease the volume.

Putting a call on hold

To put a call on hold, tap **Hold** or **Menu > Hold**.

To unhold the call, tap **Unhold** or **Menu > Unhold**.



TIP: When you have the headset connected to your Toshiba phone, you can place a call on hold by pressing the headset button.

To unhold the call, press the button again.

Muting a call

To mute a call, tap **Mute** or **Menu > Mute**.

To unmute the call, tap **Unmute** or **Menu > Unmute**.

Putting a call on speakerphone

To put a call on speakerphone, press and hold the **Send key** or tap **Menu > Turn Speakerphone On**.

To switch the speakerphone off, press and hold the **Send key** or tap **Menu > Turn Speakerphone Off**.



NOTE: The speakerphone is automatically switched off at the end of a call.

Putting a call on hands-free

To put a call on hands-free:

When hands-free equipment is attached to your Toshiba phone, the item **Menu > Turn Hands-free On** will be enabled.

Making a second call

To make a second call while already in a call:

1. Tap **Hold** or **Menu > Hold** to put the first call on hold.
2. Dial the second number, then press the **Send key**. The first call will remain on hold.

Answering or ignoring a second call

- To answer a second call, press the **Send key** or tap **Answer**. The original call will be put on hold.
- To ignore a second call, press the **End key** or tap **Ignore**.



NOTE: To interact with a second call, you need to have **Call Waiting** enabled. For information on enabling **Call Waiting**, see **Call Waiting** in **Settings**.

Call functions

Swapping between calls

To swap between calls, press the **Send key**, or tap **Swap** or **Menu > Swap**.

Creating a conference call

To create a conference call:

With two calls active on your Toshiba phone, one active and the other on hold, tap **Menu > Conference**. The calls will be joined together, and each party will be able to hear the other.



NOTE: The conference call feature is dependent on your service provider supporting it.

Adding a party to a conference call

To add another party to a conference call:

1. Tap **Hold** or **Menu > Hold** to put the conference call on hold.
2. Dial the number for the new party, then press the **Send key**.
3. When the new party has answered, tap **Menu > Conference**.

Having a private conversation with a conference call party

To have a private conversation with a conference call party, you need to split the conference call.

To have a private conversation from a conference call:

1. Tap **Menu > Private**.
2. Scroll to the party with whom you wish to have the private conversation, then tap **Private**.

Creating a note

You can create a note from the **Phone** screen during or after a call. The note will be saved as an attachment to the call in the **Call History**.

To create a note:

1. While in a call, tap **Note**.
2. Add the required information to the note.
3. Tap **ok** when you have finished.

For more information about **Notes**, see **Notes in Applications and multimedia**.

Call functions

Video telephony

Video calls allow you to enjoy live 'face-to-face' conversations with friends, family and colleagues.



NOTE: Before making a video call, you will need to confirm that the person you are calling has a phone enabled for video telephony.

Making a video call from the Phone screen

To make a video call from the **Phone** screen:

1. From the **Today** screen, press the **Send key** or tap **Start > Phone**.
2. Enter a phone number using the numeric keypad.
3. Tap the video call icon.

Making a video call from Contacts

To make a video call from **Contacts**:

1. From the **Today** screen, tap **Contacts** or **Start > Contacts**.
2. Tap and hold the required contact until the pop-up menu is displayed.
3. Tap **Video Call**.

Making a video call from Call History

To make a video call from the **Call History**:

1. From the **Today** screen, press the **Send key** or tap **Start > Phone**.
2. Tap **Hide Keypad**.
3. Tap **Call History**.
4. Tap and hold the required entry until the pop-up menu is displayed.
5. Tap **Video Call**.

Answering or ignoring a video call

- To answer an incoming video call, press the **Send key** or tap **Answer**.
- To ignore an incoming video call, press the **End key** or tap **Ignore**.

Blocking video sending

To block sending of video during a video call:

While in a video call, tap **Options > Block Video**. The other party will see a blank image.

Tap **Options > Unblock Video** to start sending video again.

Call functions

Sharing images and videos

To share an image or video during a video call:

1. Tap **Options > Share Image/Share Video**.
2. Tap the required image or video.

Tap **Options > Stop Sharing** to stop sending the image.

Recording video

To record the video received or sent during a video call, tap **Options > Recording > Record Incoming Video/Record Outgoing Video**.

Tap **Options > Recording > Stop Recording** to stop recording the video.

Call History

Call History displays a list of calls that you have missed, received and dialled recently.

Viewing Call History

To view the **Call History**:

1. From the **Today** screen, press the **Send key** or tap **Start > Phone**.
2. Tap **Hide Keypad**.
3. Tap **Call History**.
4. If required, you can filter the list by tapping **Menu > Filter > Missed/Outgoing/Incoming**.
5. To view the details of a call, tap the required call.

Creating a contact from Call History

For details of how to create a contact from **Call History**, see **Creating a new contact in Applications and multimedia**.

Deleting a call from Call History

To delete a call from the **Call History**:

1. From the **Today** screen, press the **Send key** or tap **Start > Phone**.
2. Tap **Hide Keypad**.

Call functions

3. Tap **Call History**.
4. Scroll to the required entry in the list, then tap **Menu > Delete**.
5. Tap **Yes** to confirm the deletion.

Deleting all calls from Call History

To delete all calls from the **Call History**:

1. From the **Today** screen, press the **Send key** or tap **Start > Phone**.
2. Tap **Hide Keypad**.
3. Tap **Call History**.
4. Tap **Menu > Delete All Calls**.
5. Tap **Yes** to confirm the deletion.



NOTE: Deleting all calls from the **Call History** does not reset the **Call Timers**. These need to be reset separately (see **Resetting Call Timers**).

Viewing Call Timers

To view **Call Timers**:

1. From the **Today** screen, press the **Send key** or tap **Start > Phone**.
2. Tap **Hide Keypad**.
3. Tap **Call History**.
4. Tap **Menu > Call Timers...**



NOTE: The length of waiting calls is not recorded.

Resetting Call Timers

To reset **Call Timers**:

1. From the **Today** screen, press the **Send key** or tap **Start > Phone**.
2. Tap **Hide Keypad**.
3. Tap **Call History**.
4. Tap **Menu > Call Timers...**
5. Tap **Reset**.

Messaging

This chapter describes how you can create, send, receive, organise, delete and store the following message types on your Toshiba phone:

- Text messages (SMS, Short Message Service)
- Multimedia messages (MMS)
- E-mail

You can also use **Windows Live** for instant messaging with **Windows Live Messenger** and to access **Hotmail**.

Text messages

Text messaging, or the Short Message Service (SMS), enables you to exchange text messages with other phones. For details on text messages, contact your service provider.

For information on setting up your text message service centre, refer to **Viewing and editing text messages service centre** in **Settings**.

Your Toshiba phone supports the sending of more than the standard 160-character limit. If you enter more than 160 characters, the message is split into linked text messages. These linked messages will be sent at the same time.

Creating and sending a text message (SMS)

To create and send a text message:

1. From the **Today** screen, tap **Start** > **Messaging**.
2. Tap **Text Messages**.
3. Tap **Menu** > **New** > **SMS**.
4. With the cursor in the **To:** field, add recipient(s) using one or more of the following methods:
 - Press the **Action key**, then tap a recipient from the list of contacts.

Messaging

- Tap **Menu > Add Recipient...**, then tap a recipient from the list of contacts.
 - Enter the first few letters of a name stored in **Contacts**, then tap **Menu > Check Names**. If several matches are displayed, select the required one.
 - Enter mobile phone number(s) in the **To:** field. Use a semicolon to separate multiple recipients.
5. Scroll to the message area and enter your message.



TIP: To save time by inserting predefined text:

1. Tap **Menu > My Text**.
2. Select the text to insert.

You can also edit existing **My Text** items as required.



TIP: To check spelling before sending the message, tap **Menu > Spell Check**.

6. Tap **Send**.



TIP: To delete the message without sending it, tap **Menu > Cancel Message**.

Saving a message as a draft

To save a message as a draft:

From the message creation screen, tap **Menu > Save to Drafts**.

Requesting delivery notification

To request a delivery notification:

1. From the message creation screen, tap **Menu > Message Options...**
2. Press the **Action key** to tick the **Request message delivery notification** checkbox.
3. Tap **ok**.

Receiving text messages

Text messages are automatically received when your Toshiba phone is switched on. When your phone is off, messages are held by your service provider until the next time your phone is connected to the network.

Your Toshiba phone will alert you when a new text message arrives.

Messaging

Replying to a message

To reply to a message:

1. From an open message, tap **Reply**. If you are replying to multiple recipients, tap **Menu > Reply > Reply All**.
2. Enter your message.
3. Tap **Send**.

Forwarding a message

To forward a message:

1. From an open message, tap **Menu > Reply > Forward**.
2. Add recipient(s). For details of how to add a recipient, refer to **Creating and sending a text message (SMS)**.
3. If required, edit the message in the message area.
4. Tap **Send**.

Deleting messages

To delete a message:

1. From the **Today** screen, tap **Start > Messaging**.
2. Tap **Text Messages**.
3. Scroll to the message to delete, then tap **Delete**.

MMS messages

The Multimedia Messaging Service (MMS) enables you to exchange multimedia messages containing data such as text, pictures, sounds, animation and video clips. You can send MMS messages to other mobile phones or to e-mail addresses. For details of MMS, and to enable your account for this service, contact your service provider.

Configuring MMS settings

If your Toshiba phone has not been preconfigured, you will need to manually enter the details of the MMS account. These details are available from your service provider.

To configure MMS settings:

1. From the **Today** screen, tap **Start > Messaging**.
2. Tap **Text Messages**.
3. Tap **Menu > MMS Options...**
4. Tap the **Servers** tab.
5. Tap **New**.
6. Enter the following MMSC details:
 - **Server name:** - enter a descriptive name, such as the name of your service provider.

Messaging

- **Gateway:** - enter the WAP gateway to be used for this connection.
 - **Port number:** - enter the HTTP port number for connecting to the MMS server and for file transfer.
 - **Server address:** - enter the URL address of the MMS server.
 - **Connect via:** - select the connection point for the MMS server. This is typically **The Internet**.
 - **Send limit:** - select the maximum MMS message size permitted by your service provider.
7. Tap **Done**.



TIP: If you have several MMS providers, you can set one as the default. To do this, scroll to the required MMSC entry, then tap **Set as Default**. A red arrow mark is displayed next to the default MMSC entry.

Creating an MMS message

An MMS message can consist of many pages, also known as 'slides'. Each slide can hold an image, a sound and text, but you do not need to set all of these for each message. The maximum amount of content that can be sent in a message is set by your service provider.

To create an MMS message:

1. From the **Today** screen, tap **Start > Messaging**.
2. Tap **Text Messages**.
3. Tap **Menu > New > MMS**.
4. With the cursor in the **To:** field, add recipient(s) using one or more of the following methods:
 - Press the **Action key**, then tap a recipient from the list of contacts.
 - Tap **Menu > Add Recipient > From Contacts.../From Call History...**, then tap a recipient.
 - Enter mobile phone number(s) in the **To:** field. Use a semicolon to separate multiple recipients.
5. Enter a subject for the message in the **Subject:** field if required.
6. Enter a message.
7. Tap **Send** when the message is ready.



TIP: To preview the message before sending, tap the Play icon.



TIP: To delete the message without sending it, tap **Menu > Cancel Message**.

Messaging

Inserting a picture or video

To insert a picture or video in the message:

1. Scroll to the **Insert picture/video** area, then press the **Action key**. A preview of all pictures and videos in the current folder is displayed.
2. Either select one of the previewed pictures or launch the **Camera** application and capture a new picture or video.

Once you have selected a picture or video, the message creation screen is displayed again.



NOTE: If you add a video to a slide, you cannot add any further audio to that slide.



TIP: You can also insert a picture or video from the message creation screen by tapping **Menu > Insert > Picture/Video...**

Inserting text

To insert text in the message:

1. Scroll to the **Insert text here** area, then press the **Action key**.
2. Enter text. To insert predefined text, tap **Menu > Insert My Text...**
3. Tap **Done** when you have finished inserting text.



TIP: You can also insert text from the message creation screen by tapping **Menu > Insert > Text...**

Inserting audio

To insert audio in the message:

1. Scroll to the **Insert audio** area, then press the **Action key**. A list of all audio files in the current folder is displayed.
2. Select one of the audio files.



TIP: You can also insert audio from the message creation screen by tapping **Menu > Insert > Audio...**

Using and creating templates

To use or create a template:

From the message creation screen, tap **Menu > Template**. Tap **Select a Template...** to select a template to use for a new MMS message, or **Save as Template** to save the current MMS message as a template for future use.

Messaging

Selecting a message background colour

To select a background colour for the message:

1. From the message creation screen, tap **Menu > Options > Background**. A list of colours is displayed.
2. Tap the required colour.

Additional MMS message options

You can add recipient(s) in copy (**Cc:**) or blind copy (**Bcc:**) to your message.



TIP: Scroll up to view the **Cc:** and **Bcc:** fields.

You can also set the priority of the message, a delivery time delay for the sending of the message, an expiry time for the message, and request delivery and read reports.

To set these options, from the message creation screen, tap **Menu > Options > Send Options...**, then set the options as required.

Receiving MMS messages

Your Toshiba phone will alert you when a new MMS message arrives. Depending on your settings, the message contents may download a few moments later, when the message will be ready to view in your **Inbox**.

Messaging

E-mail

Before you can send or receive e-mails, you need to set up an e-mail account. Your Toshiba phone supports the following types of e-mail accounts:

- Internet e-mail (POP3/IMAP).
- Exchange server (Outlook).

Setting up an e-mail account automatically

To set up an e-mail account automatically:

1. From the **Today** screen, tap **Start > Messaging**.
2. Tap **Setup E-mail**.
3. In the **E-mail address:** field, enter the e-mail address for this account.
4. Enter a password in the **Password:** field.



TIP: Choose a strong password - strengthen the security of your password by selecting a combination of alphabet and numeric characters.

5. Tick the **Save password** checkbox if you wish to save your password to your Toshiba phone. This will mean that you do not need to enter it each time you connect to your e-mail server.

This may or may not be required by your internet service provider (ISP).



WARNING: If you save your password and then lose your Toshiba phone, you run the risk of someone else being able to access your e-mail account.

6. Tap **Next**.
7. Tick the **Try to get email settings automatically from the Internet** checkbox.
8. Tap **Next**.

If the account has set up successfully, you are prompted to send and receive e-mail.

If the account has not set up successfully, you will need to set up the account manually, as described in the following section.

Setting up an e-mail account manually

If you need to manually enter the details of an e-mail account, you may need to obtain some of these details from your ISP.

1. From the **Today** screen, tap **Start > Messaging**.
2. Tap **Setup E-mail**.

Messaging

3. In the **E-mail address:** field, enter the e-mail address for this account.
4. Enter a password in the **Password:** field.



TIP: Choose a strong password - strengthen the security of your password by selecting a combination of alphabet and numeric characters.

5. Tick the **Save password** checkbox if you wish to save your password to your Toshiba phone. This will mean that you do not need to enter it each time you connect to your e-mail server. This may or may not be required by your internet service provider (ISP).



WARNING: If you save your password and then lose your Toshiba phone, you run the risk of someone else being able to access your e-mail account.

6. Tap **Next**.
7. Select the required option in the **Your e-mail provider:** field, then tap **Next**.
8. Enter the name that you want displayed when you send e-mail in the **Your name:** field.
9. Enter a unique name for this account in the **Account display name:** field, then tap **Next**. This name cannot be changed later.

10. Enter the name of the incoming server in the **Incoming mail server:** field.
11. Select the server type that hosts your e-mail mailbox in the **Account type:** list (**POP3** or **IMAP4**), then tap **Next**.
12. Enter the user name assigned to you by your ISP or network administrator in the **User name:** field. This is usually the first part of your e-mail address, before the '@' sign.
13. Enter a password in the **Password:** field.
14. Tick the **Save password** checkbox if you wish to save your password to your Toshiba phone.
15. Tap **Next**.
16. Enter the name of the outgoing server in the **Outgoing (SMTP) mail server:** field.
17. Tick the **Outgoing server requires authentication** checkbox if the outgoing server requires authentication. This authentication will use the user name and password that you have already entered.
18. Tick the **Use the same user name and password for sending e-mail** checkbox if required.
19. Tap the **Advanced Server Settings** link to set the following additional settings if required.

Messaging

Tick the checkboxes if you wish to enable SSL connection.



IMPORTANT: SSL connection enables you to send and/or receive personal information more securely. If you select one or both of these options and your ISP does not support SSL connection, you will not be able to send and/or receive e-mail.

The **Network connection:** field enables you to select the network to which your e-mail server connects.

Tap **Done** when you have finished.

20. Tap **Next**.

21. Select the frequency with which to send and receive your e-mail in the **Automatic Send/Receive:** field.

22. Tap the **Review all download settings** link to set the following additional settings if required:

The **Download messages:** field enables you to set the time range for downloading messages from the server.

Tap **Advanced Settings** to edit additional settings for sending, receiving and deleting e-mails if required.

Tap **Done**, then **Next** when you have finished.

23. Select the format for sending messages (**HTML** or **Plain Text**) in the **Message format:** field.

24. Select the download size limitation in the **Message download limit:** field.

25. Tap **Finish**.

Creating an e-mail

To create an e-mail:

1. From the **Today** screen, tap **Start > Messaging**.
2. Tap the e-mail account to use.
3. Tap **Menu > New**.
4. With the cursor in the **To:** field, add recipient(s) using one or more of the following methods:
 - Press the **Action key**, then tap a recipient from the list of contacts.
 - Tap **Menu > Add Recipient...**, then tap a recipient from the list of contacts.
 - Enter the first few letters of a name stored in **Contacts**, then tap **Menu > Check Names**. If several matches are displayed, select the required one.
 - Enter e-mail address(es) in the **To:** field. Use a semicolon to separate multiple recipients.

Messaging

5. Add recipients in the **Cc:** and/or **Bcc:** fields if required.



TIP: Scroll up to view the **Cc:** and **Bcc:** fields.

6. Enter a subject for the e-mail in the **Subject:** field if required.
7. Scroll to the message area and enter your message.



TIP: To save time by inserting predefined text:

1. Tap **Menu > My Text**.
2. Select the text to insert.

You can also edit existing **My Text** items as required.



TIP: To check spelling before sending the message, tap **Menu > Spell Check**.



TIP: To set the priority of the e-mail:

1. Tap **Menu > Message Options...**
 2. Select the required option in the **Priority:** field.
8. Tap **Send** when the message is ready.
E-mails are stored in your **Outbox** and are sent to recipients the next time you synchronise or connect to your e-mail server.



TIP: To delete the message without sending it, tap **Menu > Cancel Message**.

Adding an attachment to an e-mail

To add an attachment to an e-mail:

1. Tap **Menu > Insert > Picture/Voice Note/File**.
2. Select the item to add.

Digitally signing an e-mail

Digitally signing an e-mail applies your certificate with the public key to the e-mail. This provides the recipient with proof that the e-mail is from you and not an imposter, and that it has not been altered.

To digitally sign an e-mail:

1. Tap **Menu > Message Options...**
2. In the **Security:** field, select the required security function.



NOTE: S/MIME encryption and digital signatures for Windows Mobile-based devices are available only with Exchange Server 2003 Service Pack 2 or a later version that supports S/MIME. If you are not using one of these products, or have not yet synchronised, these options will not be available.

Messaging

Sending and receiving e-mail

To send and receive e-mail:

1. From the **Today** screen, tap **Start > Messaging**.
2. Tap the required e-mail account.
3. Tap **Menu > Send/Receive**. Your Toshiba phone connects to your Internet e-mail server and sends and receives your messages.



TIP: To stop this process, tap **Menu > Stop Send/Receive**.

Downloading a complete e-mail

To download a complete e-mail:

1. From the **Today** screen, tap **Start > Messaging**.
2. Tap the required e-mail account.
3. Scroll to the required e-mail, then tap **Menu > Download Message**. The complete message is retrieved the next time you synchronise or connect to your e-mail server to send/receive e-mail.

Downloading an e-mail attachment

To download an e-mail attachment:

From an open message with an attachment, select the attachment. The attachment is downloaded the next time you synchronise or connect to your e-mail server to send/receive e-mail.

Viewing an attachment

To view an attachment:

In an open message containing a downloaded attachment, select the attachment.

Messaging

General messaging options

You can customise the options for your **Messaging** accounts, message options, addressing, and message storage.

To access the **Messaging** options:

1. From the **Today** screen, tap **Start > Messaging**.
2. Scroll to an account, then tap **Menu > Options**.
3. Customise the following options as required:
 - **Accounts** tab - Enables you to change the settings for each messaging account. For example, tap **Text Messages** to change the **Request delivery notifications** and **Use Unicode when necessary** settings as required. Tap **New account...** to set up a new messaging account. Tick the **Display account picker when opening Messaging** checkbox if you would like to select the messaging account each time you open **Messaging**.
 - **Message** tab - Enables you to change options for sending and deleting messages.
 - **Address** tab - Enables you to select whether to check **Contacts** as well as any online address books for e-mail addresses.

You can also add online address books and select which ones to use for e-mail address checking.

- **Storage** tab - Enables you to check the memory space of your phone, storage card and attachments. You can also select whether to store attachments on a storage card, and specify how deleted items are emptied.

Switching between messaging accounts

You can switch between **Text Messages**, **MMS** or any e-mail account.

To switch between messaging accounts:

1. From any **Messaging** folder, tap **Menu > Go To**.
2. Tap the required account.

Messaging

Switching between messaging folders

For each **Messaging** account, you can switch between the **Deleted Items**, **Drafts**, **Inbox**, **Outbox** and **Sent Items** folders.

To switch between messaging folders:

1. From any **Messaging** folder, tap **Menu > Go To > Folders...**
2. Tap the folder that you want to view.

Inserting a signature

For each **Messaging** account, you can specify a signature to be automatically inserted into messages that you send.

To create a signature and insert it in messages:

1. From the **Today** screen, tap **Start > Messaging**.
2. Scroll to an account, then tap **Menu > Options**.
3. On the **Accounts** tab, tap **Signatures...**
4. In the **Select an account:** field, select the account for which you are creating the signature.
5. Tick the **Use signature with this account** checkbox.
6. To insert a signature in every message you send, tick the **Use when replying and forwarding** checkbox. If this checkbox is not ticked, the signature is inserted in new messages only.
7. Enter the signature.
8. Tap **ok** twice.

Text input

Input methods

Your Toshiba phone enables you to enter information in three different ways:

- Typing - Using the **Input Panel**.
- Writing - Using the stylus, writing directly on the screen.
- Drawing - Using the stylus, drawing directly on the screen.

The **Input Panel** provides various input methods, including **Block Recognizer**, **Keyboard**, **Letter Recognizer** and **Transcriber**.

The **Input Panel** icon is displayed on the command bar when text input is possible.

To open the **Input Panel**, tap the **Input Panel** icon. You can then tap the arrow beside the icon to select other input methods.

When you begin entering a word using any of the input methods except **Transcriber**, your Toshiba phone will suggest possible words. Tap on one of the suggested words to enter it.

Your Toshiba phone will learn words as you use them. They will then be used as suggested words in the future.

Block Recognizer

With **Block Recognizer**, you use a single stroke to write individual letters, numbers and punctuation, which are then converted into typed text.

To use **Block Recognizer**, tap the **Input Panel** selector arrow, then tap **Block Recognizer**.

The handwriting area is divided into two designated parts: **abc** and **123**.

Write characters, numbers, symbols and punctuation in the separate areas:

- Write in the **abc** area to enter lower case letters.
- Write in the **123** area to enter numbers.
- Tap the button in the bottom right corner labelled '@\$*' to open the table of symbols and punctuation.



NOTE: **Block Recognizer** is available when text entry is possible.



TIP: For help with using **Block Recognizer**, tap ? in the right corner to see a demo.

Text input

Keyboard

With the on-screen keyboard, you use the stylus to tap on the keyboard to enter characters.



TIP: Tap **áú** to enter miscellaneous letters and symbols.

To use **Keyboard**, tap the **Input Panel** selector arrow, then tap **Keyboard**.

To set the **Keyboard** options:

1. Tap the **Input Panel** selector arrow, then tap **Options...**
2. In the **Input method:** field, tap **Keyboard**.
3. Select the required options by:
 - tapping **Large keys** or **Small keys** to select the size of the buttons on the keyboard.
 - ticking the **Use gestures for the following keys:** checkbox to enable gesture commands.

Letter Recognizer

With **Letter Recognizer**, you can write individual letters, numbers and punctuation, which are then converted into typed text.

To use **Letter Recognizer**, tap the **Input Panel** selector arrow, then tap **Letter Recognizer**.

The handwriting area is divided into three designated parts: **ABC**, **abc** and **123**.

Write characters, numbers, symbols, and punctuation in the separate areas:

- Write in the **ABC** area to enter upper case letters.
- Write in the **abc** area to enter lower case letters.
- Write in the **123** area to enter numbers.
- Tap the button in the bottom right corner labelled '@\$*' to open the table of symbols and punctuation.



NOTE: **Letter Recognizer** is available when text entry is possible.



TIP: For help with using **Letter Recognizer**, tap **?** in the right corner to see a demo.

Text input

Input Options

To set the input options:

1. Tap the **Input Panel** selector arrow, then tap **Options...**
2. Tap the **Word Completion** tab to change the settings for suggested words and automatic correction.
3. Tap the **Options** tab to change the general input settings, including zoom levels and capitalisation.
4. Tap **ok** when you have finished.



TIP: You can also access the input options from the **Today** screen by tapping **Start > Settings > Input**.

Transcriber

Transcriber is a handwriting recognition program that enables you to write in cursive, print, or a combination of both.

Transcriber enables you to write anywhere on the screen using the stylus, just as you would write on paper. Unlike **Block Recognizer** and **Letter Recognizer**, you can write entire sentences. When you pause, **Transcriber** will convert the written text to typed text.

Transcriber works transparently in the background, recognising words with its integrated dictionary. When **Transcriber** is active, it interprets stylus movement anywhere on the screen as handwriting input.

Text input

Starting Transcriber

Because **Transcriber** works transparently in the background of applications that accept text input, you need to have one of these programs open to use **Transcriber**.

To start **Transcriber**:

1. Start an application such as **Word Mobile**.
2. Tap the **Input Panel** selector arrow, then tap **Transcriber**. The **Transcriber Intro** screen will be displayed.



TIP: To stop the **Transcriber Intro** screen being displayed each time you use start **Transcriber**, tick the **Don't show this** checkbox, then tap **ok**.









Showing and hiding the Transcriber toolbar

The **Transcriber** toolbar provides easy access to several tools, as well as Enter, Space, and Backspace buttons, and left and right arrow buttons. It is displayed at the bottom of the screen when **Transcriber** is active.

To show or hide the **Transcriber** toolbar, tap the **Transcriber** icon at the bottom of the screen.

Text input

Transcriber toolbar functions

Toolbar icon	Description
	Displays the Transcriber: Options screen. From here, you can set options such as Writing Direction ., pen settings, Shorthand and Dictionaries .
	Displays the Letter Shapes screen. This screen enables you to set your personal writing styles to maximise recognition.
	Displays the on-screen keyboard. This enables you to quickly enter numbers, punctuation, and other symbols.
	Toggles between the following character recognition modes: a - default mode for optimum handwriting recognition. 123 - numbers and some letters are allowed. A - all letters are converted to upper case. From A and 123 modes, recognition returns automatically to the default (a) mode when you lift the stylus.
	Inserts a space at the cursor. Equivalent to the Space key on a keyboard.
	Inserts a paragraph return at the cursor. Equivalent to the Enter key on a keyboard.
	Moves the cursor one space to the left.
	Moves the cursor one space to the right.
	Moves the cursor one space back and erases any text. Equivalent to the Backspace key on a keyboard.

Text input

Toolbar icon	Description
	Displays the Overview of Microsoft Transcriber .

Using the Transcriber keyboard

Transcriber comes with an on-screen keyboard that provides an easy way to add punctuation or a special symbol to existing text.

To access the **Transcriber** keyboard:

Tap the keyboard button on the **Transcriber** toolbar. The keyboard is displayed until you tap the keyboard button again.



TIP: To reposition the keyboard, tap and hold the top bar, then drag it to the desired location.



TIP: When no text is selected, you can open the keyboard by doing the  gesture.

Writing with Transcriber

To write with **Transcriber**:

1. Position the cursor where you want to enter text.
2. Using the stylus, write on the screen. The handwriting will be converted to text after you lift the stylus from the screen.

Editing text with Transcriber

To edit text with **Transcriber**:

1. Draw a line across the text you want to edit. After you lift the stylus from the screen, the line will disappear and the selected text will be highlighted.
2. Do one of the following:
 - Rewrite the text.
 - Use gestures to capitalise letters, insert a space, etc.









Using gestures in Transcriber

To use gestures in **Transcriber**:



Use quick strokes of the stylus to edit your text. Do the Enter, Space, and Tab gestures while writing text to insert returns, spaces, or tabs.

Available gestures are described in the following table.

Text input

Name	Action	Description
Enter		Inserts a paragraph return at the cursor. The horizontal portion of this gesture must be at least two times longer than the vertical portion.
Space		Inserts a space at the cursor. The horizontal portion of this gesture must be at least two times longer than the vertical portion.
Backspace		Moves the cursor one space back and erases any text. Do this gesture by drawing a line from right to left.
Words		Opens the menu of alternate words if a word is selected, or the on-screen Transcriber keyboard if no text is selected. Do this gesture by drawing a line straight down and back up.
Caps		Changes the capitalisation of a selected letter, word, or block of text. Do this gesture by drawing a line straight up.
Undo		To undo the last action. Do this gesture by drawing a line straight up and back down.
Cut		Cuts the selected text. Do this gesture by drawing a line from right to left and back.
Copy		Copies the selected text. Do this gesture by drawing a line from left to right and back.

Text input

Name	Action	Description
Paste		Pastes cut or copied text. Do this gesture by drawing a line from the lower left of the screen diagonally up toward the right and back down to the right.
Tab		Inserts a tab. The horizontal portion of this gesture must be at least two times longer than the vertical portion.

Optimising handwriting recognition for Transcriber

If **Transcriber** does not recognise your handwriting as accurately or quickly as you would like, there are some things you can do to optimise handwriting recognition.

- Select the **Writing Direction**: picture that best matches the slant of your handwriting.
 - Use **Letter Shapes** to eliminate letter shapes that you do not use or to learn methods of writing characters that will make them easier for **Transcriber** to recognise.
 - Try writing in another format. If you have been printing, try writing cursive, or if you have been writing in both cursive and print, try printing alone.
 - Adjust the speed at which **Transcriber** returns text after you write.
- Add a user dictionary that contains special terms you may be using, such as medical or legal terms.
 - Verify that you are using your **Letter Shapes** user profile.

Text input

Drawing and writing on the screen

With your Toshiba phone, you can draw directly on the screen, write on the screen, and save notes in your own handwriting. To do this, you must first set the input mode in **Notes** to **Writing**. If you prefer to use handwriting or frequently add drawings to your notes, you may find it helpful to set **Writing** as the default input mode. If you prefer typed text, set **Typing** as the default input mode.

To set the input mode for **Notes**:

1. Tap **Start > Programs > Notes**.
2. Tap **Menu > Options...**
3. In the **Default mode:** field, select one of the following:
 - **Writing** - if you want to draw or enter handwritten text in a note.
 - **Typing** - if you want to create a typed note.
4. Tap **ok**.

To hand write a note:

1. Tap **Start > Programs > Notes**.
2. Tap **New**.
3. Tap **Menu**, and make sure that **Draw** is ticked.
4. Write text on the screen.
5. Tap **ok** when you have finished.



NOTE: If a letter crosses three or more ruled lines, it is treated as a drawing rather than text.

To draw on the screen using the stylus:

1. Tap **Start > Programs > Notes**.
2. Tap **New**.
3. Tap **Menu**, and make sure that **Draw** is ticked.
4. Using the stylus, draw over at least three ruled lines. A box labelled **Drawing** is displayed around the drawing.
5. Tap **ok** when you have finished.



TIP: To select a drawing (for example, to copy or delete it), tap and hold the drawing briefly. When you lift the stylus, the drawing is selected.

Text input

Full Screen Keyboard

Full Screen Keyboard enables you to enter text from a full screen keyboard that has keys large enough to be typed with your fingertips. Since the keyboard can be operated with both hands, it is convenient for entering large amounts of text.

To use **Full Screen Keyboard**:

1. Tap the **Input Panel** selector arrow, then tap **Full Screen Keyboard**.
2. Tap the keyboard icon. The **Full Screen Keyboard** is displayed.
3. Enter text.
4. Tap the keyboard icon when you have finished.

You can configure **Full Screen Keyboard** to your own requirements and preferences. Items that you can configure include the keyboard skin, character repeat settings, sounds, auto correction settings and dictionaries.

To configure **Full Screen Keyboard**:

1. Tap the **Input Panel** selector arrow, then tap **Options...**
2. In the **Input method:** field, tap **Full Screen Keyboard**.
3. Tap **Options...**
4. Select the required options, then tap **ok** twice.

Applications and multimedia

The following items are available from the **Start** menu of your Toshiba phone:

- **Office Mobile**
- **Calendar**
- **Contacts**
- **Internet Explorer**
- **Games**
- **TOSHIBA User Interface**
- **ActiveSync**
- **A-GPS**
- **AutoConfig**
- **AutoInstall**
- **BlackList**
- **Calculator**
- **Camera**
- **Certificate Enrollment**
- **File Explorer**
- **FM Radio**
- **Full Screen Keyboard**
- **Getting Started**
- **Home**
- **Image Editor**
- **Image To Text**
- **Internet Sharing**
- **JBlend**
- **Messenger**
- **Notes**
- **PicSel Viewer**
- **Pictures & Videos**
- **Search**
- **SIM Toolkit**
- **Streaming Player**
- **Task Manager**
- **Tasks**
- **Windows Live**
- **Windows Media**

Applications and multimedia

Office Mobile

To access **Office Mobile** on your Toshiba phone:

1. From the **Today** screen, tap **Start > Office Mobile**.
2. Select one of the following applications:
 - **Excel Mobile**
 - **OneNote Mobile**
 - **PowerPoint Mobile**
 - **Word Mobile**

Excel Mobile

With **Excel Mobile** you can work on spreadsheets in the same way as on a PC. You can create new spreadsheets and charts, and open and edit workbooks created on a PC.

 **NOTE:** **Excel Mobile** does not fully support some features. Refer to the Microsoft website for details.

 **NOTE:** Some data and formatting may be lost when you save a workbook created on a PC to your Toshiba phone. Refer to the Microsoft website for details.

OneNote Mobile

With **OneNote Mobile**, you can gather notes and information in one place.

Notes in **OneNote Mobile** can contain text, images and voice recordings. You can also synchronise the notes with **OneNote** on a PC using **ActiveSync**.

PowerPoint Mobile

With **PowerPoint Mobile**, slide show presentations created on your PC can be opened and viewed on your Toshiba phone.

Slide shows created in *.ppt and *.pps format with PowerPoint '97 and later are supported.

Many presentation elements built into the slide shows, such as slide transitions and animations, will play back on your Toshiba phone. If the presentation is set up as a timed slide show, one slide will advance to the next automatically. Links to URLs are also supported.

 **NOTE:** **PowerPoint Mobile** does not fully support some features. Refer to the Microsoft website for details.

Applications and multimedia

Word Mobile

With **Word Mobile** you can work on documents in the same way as on a PC. You can create new documents and templates, and open and edit documents created on a PC.



NOTE: **Word Mobile** does not fully support some features. Refer to the Microsoft website for details.



NOTE: Some data and formatting may be lost when you save the document on your Toshiba phone. Refer to the Microsoft website for details.

Calendar

The **Calendar** application works like an electronic diary. You can keep track of your appointments, including meetings and other events.

You can display reminders on your Toshiba phone, as well as synchronising your phone with Outlook on your PC.

Scheduling an appointment

To schedule a new appointment:

1. From the **Today** screen, tap **Start > Calendar**.
2. Tap **Menu > New Appointment**.
3. Enter details of the appointment, then tap **ok**.



NOTE: All day events do not occupy blocks of time in the **Calendar** - instead they are displayed as banners at the top of the **Calendar**.

Sending a meeting request

You can use the **Calendar** application to schedule meetings via e-mail with contacts who use Microsoft Outlook or Outlook Mobile.

To send a meeting request:

1. From the **Today** screen, tap **Start > Calendar**.

Applications and multimedia

2. Schedule a new appointment or open an existing one.
3. Tap **Menu** > **Edit**.
4. If the appointment is recurring, tap **All**.
5. Tap the **Attendees**: field.
6. Tap **Add Required Attendee...** or **Add Optional Attendee...** as required.
7. Tap the contact to invite.
8. Add more contacts if required.
9. Tap **ok** or **Done** when you have finished adding attendees.
10. Tap **ok**.
11. Tap **Yes** to save the change and send the meeting request to the attendees. The meeting request will be sent to the attendees when you next synchronise your Toshiba phone with your PC.



NOTE: When attendees accept the meeting request, the meeting is automatically added to their schedules. When their responses are received, your calendar is updated.

Sending an appointment

You can send an appointment within an MMS message.

To send an appointment:

1. From the **Today** screen, tap **Start** > **Calendar**.
2. Tap the required appointment.
3. Tap **Menu** > **Send as vCalendar**.
4. Add a recipient to the message, then tap **Send**.

Updating an appointment

To update an appointment:

1. From the **Today** screen, tap **Start** > **Calendar**.
2. Tap the required appointment.
3. Tap **Menu** > **Edit**.
4. If the appointment is recurring, tap **All** to edit all occurrences, or tap **One** to edit only the next occurrence.
5. Update the appointment details, then tap **ok**.

Applications and multimedia

Changing the default reminder time

By default, the reminder time is set to 15 minutes before an appointment.

To change the default reminder time:

1. From the **Today** screen, tap **Start > Calendar**.
2. Tap **Menu > Tools > Options...**
3. Tap the **Appointments** tab.
4. Make sure that the **Set reminders for new items** checkbox is ticked, then change the reminder time.
5. Tap **ok**.

Deleting an appointment

To delete an appointment:

1. From the **Today** screen, tap **Start > Calendar**.
2. Tap the required appointment.
3. Tap **Menu > Delete**.
4. If the appointment is recurring, tap **All** to delete all occurrences, or tap **One** to delete only the next occurrence.



NOTE: If an appointment that has been synchronised with your PC is deleted, it will be deleted on the PC the next time you synchronise.

Changing the work week display

To change the work week display:

1. From the **Today** screen, tap **Start > Calendar**.
2. Tap **Menu > Tools > Options...**
3. On the **General** tab, set the following as required:
 - In the **1st day of week:** field, select **Sunday** or **Monday** as required.
 - In the **Week view:** field, select **5-day week**, **6-day week** or **7-day week** as required.
4. Tap **ok** when you have finished.

Viewing today's agenda

To view today's agenda:

- From the **Today** screen, tap **Start > Calendar > Menu > Go to Today**
or
- From **Day**, **Week**, **Month** or **Year** view, tap **Menu > View > Agenda** or **Agenda**.



TIP: To view past or future dates, press the left and right navigation keys.

Applications and multimedia

Viewing your agenda for a specific date

To view your agenda for a specific date:

1. From the **Today** screen, tap **Start > Calendar**.
2. Tap **Menu > Go to Date**.
3. Tap the required date.

Viewing your schedule for the next week

To view your schedule for the next week:

1. From the **Today** screen, tap **Start > Calendar**.
2. Tap **Menu > View > Week**.

Viewing your schedule for the next month

To view your schedule for the next month:

1. From the **Today** screen, tap **Start > Calendar**.
2. Tap **Menu > View > Month**.

Contacts

You can use the **Contacts** feature to store phone numbers, e-mail addresses, home addresses, and other information relating to a contact. You can also add a picture or assign a ring tone to a contact.

If you use **Microsoft Outlook** on a PC, you can synchronise contacts between your Toshiba phone and the PC.

Creating a new contact

To create a new contact:

1. From the **Today** screen, tap **Contacts** or **Start > Contacts**.
2. Tap **New**.
3. Tap the contact type to create (**Outlook Contact** or **SIM Contact**). Outlook contacts are stored on your Toshiba phone.

 **NOTE:** SIM contacts (except when using a USIM card) only support a single name and phone number. Contacts stored on a USIM card can include a name, three phone numbers and an e-mail address.

 **NOTE:** If you move the SIM card to another phone, your SIM contacts are moved as well.

4. Enter the details of the new contact.

Applications and multimedia

5. Tap **ok**.



TIP: You can customise Outlook contacts by adding a picture or a ring tone to uniquely identify the person calling you.



TIP: If someone whose phone number isn't stored in **Contacts** calls you, you can create a contact for that person. To do this:

1. From the **Today** screen, press the **Send key** or tap **Start > Phone**.
2. Tap **Hide Keypad**.
3. Tap **Call History**.
4. Scroll to the required call, then tap **Menu > Save to Contacts**.
5. Tap **<New Contact>**.
6. Edit the details of the new contact as required, then tap **Save**.

Assigning phone numbers to a contact

You can assign a work phone number (**w**), mobile phone number (**m**) and home phone number (**h**) to a contact that is saved to the phone.

The mobile phone number is dialled by default.

For further information, refer to **Making a call to a non-default number** in **Call functions**.

Finding a contact

To find a contact by name:

1. From the **Today** screen, tap **Contacts** or **Start > Contacts**.
2. Tap the **Enter a name...** field.
3. Enter the first letter of the name of the contact to find. Matching contacts will be listed.

To find a contact by company:

1. From the **Today** screen, tap **Contacts** or **Start > Contacts**.
2. Tap **Menu > View By**.
3. Tap **Company**.

Viewing and editing a contact

To view and edit a contact:

1. From the **Today** screen, tap **Contacts** or **Start > Contacts**.
2. Tap the required contact.
3. To edit the contact, tap **Menu > Edit**.
4. Tap **ok** when you have finished.

To set the viewing filter:

1. From the **Today** screen, tap **Contacts** or **Start > Contacts**.
2. Tap **Menu > Filter**.

Applications and multimedia

3. Tap the required filter item.



NOTE: To display all contacts again, tap **Menu > Filter > All Contacts**.

Adding a picture to a contact

To add a picture to a contact:

1. From the **Today** screen, tap **Contacts** or **Start > Contacts**.
2. Tap the required contact.
3. Tap **Menu > Edit**.
4. On the **Details** tab, tap **Select a picture...**
5. Tap a picture, or tap **Camera** and capture a photograph.
6. Tap **ok** twice.

Removing a picture from a contact

To remove a picture from a contact:

1. From the **Today** screen, tap **Contacts** or **Start > Contacts**.
2. Tap the required contact.
3. Tap **Menu > Edit**.
4. Tap **Menu > Remove Picture**.
5. Tap **Yes** to confirm the removal.
6. Tap **ok**.

Assigning a ring tone to a contact

To assign a ring tone to a contact:

1. From the **Today** screen, tap **Contacts** or **Start > Contacts**.
2. Tap the required contact.
3. Tap **Menu > Edit**.
4. On the **Details** tab, tap **Ring tone:**, then tap the required ring tone.
5. Tap **ok**.

Assigning a category to a contact

You can use categories to help organise your contacts.

To assign a category to a contact:

1. From the **Today** screen, tap **Contacts** or **Start > Contacts**.
2. Tap the required contact.
3. Tap **Menu > Edit**.
4. On the **Details** tab, tap **Categories:**, then tap the required categories.



TIP: Tap **New** to create a new category.



TIP: You can assign more than one category to a contact.

Applications and multimedia

5. Tap **ok** twice.

 **NOTE:** Categories are shared between your appointments, **Contacts**, and **Tasks**.

 **NOTE:** If you filter your list of contacts by a category, when you create a new contact, it will be automatically assigned to that category.

Copying contacts

To copy a phone contact to the SIM card:

1. From the **Today** screen, tap **Contacts** or **Start > Contacts**.
2. Tap the required contact.
3. Tap **Menu > Save to SIM**.

 **NOTE:** When copying phone contacts to a SIM card, only the supported fields will be copied.

To copy a SIM contact to the phone:

1. From the **Today** screen, tap **Contacts** or **Start > Contacts**.
2. Tap the required contact.
3. Tap **Menu > Save to Contacts**.

To copy all phone contacts to the SIM card:

1. From the **Today** screen, tap **Contacts** or **Start**

> Contacts.

2. Tap **Menu > SIM > Copy all phone contacts to SIM**.

To copy all SIM contacts to the phone:

1. From the **Today** screen, tap **Contacts** or **Start > Contacts**.
2. Tap **Menu > SIM > Copy all SIM contacts to phone**.

Deleting a contact

To delete a contact:

1. From the **Today** screen, tap **Contacts** or **Start > Contacts**.
2. Tap the required contact.
3. Tap **Menu > Delete Contact**.
4. Tap **Yes** to confirm the deletion.

Deleting all contacts

To delete all contacts from the phone:

1. From the **Today** screen, tap **Contacts** or **Start > Contacts**.
2. Tap **Menu > SIM > Delete all phone contacts**.
3. Tap **Yes** to confirm the deletion.

Applications and multimedia

To delete all contacts from the SIM card:

1. From the **Today** screen, tap **Contacts** or **Start > Contacts**.
2. Tap **Menu > SIM > Delete all SIM contacts**.
3. Tap **Yes** to confirm the deletion.

Sending contact information

You can send contact information in a text message or MMS message, or using Bluetooth.

To send contact information in a text message:

1. From the **Today** screen, tap **Contacts** or **Start > Contacts**.
2. Tap the required contact.
3. Tap **Menu > Send Contact > Text Messages**.
4. Select the specific information to send, then tap **Done**.
5. Add a recipient to the message, then tap **Send**.

To send contact information in an MMS message:

1. From the **Today** screen, tap **Contacts** or **Start > Contacts**.
2. Tap the required contact.
3. Tap **Menu > Send as vCard**.
4. Add a recipient to the message, then tap **Send**.

For details of sending contact information using Bluetooth, refer to **Beaming an item** in

Connectivity.

Internet Explorer

Internet Explorer Mobile gives quick and easy access to searching using **Live Search** and web pages in your **Favorites** and **History**.

You can also type in an address to access other web pages.

Searching the Internet using Live Search

To search the Internet using **Live Search**:

1. From the **Today** screen, tap **Start > Internet Explorer**.
2. Enter a search term into the search field, then tap the search icon.

Accessing a web page

To access a web page:

1. From the **Today** screen, tap **Start > Internet Explorer**.
2. Tap **Menu > Address Bar**.
3. Enter the address of the web page.
4. Tap the icon to the right of the address bar (green arrow).

Applications and multimedia

Changing the text size of web pages

To change the text size of a web page:

1. From a web page, tap **Menu > View > Zoom Level**.
2. Tap the required size.

Showing or hiding pictures on web pages

To show or hide pictures on a web page:

From a web page, tap **Menu > View > Show Pictures**.

Adding a web page to Favorites

To add a web page to **Favorites**:

1. From a web page, tap **Menu > Add to Favorites...**
2. Edit the details if required, then tap **Add**.



TIP: You can also add **Favorites** from your PC to your Toshiba phone using **ActiveSync**. For more information, see Microsoft ActiveSync Help on your PC.

Creating a folder in Favorites

To create a folder in **Favorites**:

1. From the **Today** screen, tap **Start > Internet Explorer**.
2. Tap **Menu > Favorites...**
3. Tap the **Add / Delete** tab.
4. Tap **New Folder**.
5. Enter a name for the folder, then tap **Add**.
6. Tap **ok**.

Accessing a web page from Favorites

To access a web page from **Favorites**:

1. From the **Today** screen, tap **Start > Internet Explorer**.
2. Tap **Favorites**.
3. Tap the required web page in the list.



TIP: You can also select a web page from your **Favorites** by tapping **Menu > Favorites...**

Applications and multimedia

Deleting a web page from Favorites

To delete a web page from **Favorites**:

1. From the **Today** screen, tap **Start > Internet Explorer**.
2. Tap **Menu > Favorites...**
3. Tap the **Add / Delete** tab.
4. Tap the required web page, then tap **Delete**.
5. Tap **Yes** to confirm the deletion.
6. Tap **ok**.

Viewing the History

To view the **History**:

1. From the **Today** screen, tap **Start > Internet Explorer**.
2. Tap **History**.



TIP: You can also view the **History** by tapping **Menu > Tools > History...**



TIP: To access a web page from the **History**, tap the required page in the list.

Changing the home page

To change the home page:

1. From a web page, tap **Menu > Tools > Options...**
2. On the **General** tab, tap the required item for the **Home page**:
 - **Use Current** - sets the currently displayed page as your home page.
 - **Use Default** - sets the default home page.
3. Tap **ok**.

Changing security settings and clearing cookies

Internet Explorer Mobile supports the protocols used by Secure Sockets Layer (SSL). A connection that uses SSL helps you to send personal information more safely.

Cookies are small files containing information about your identity and preferences so that a page can tailor information to your needs. The page sends the file, and it is stored on your Toshiba phone.

To change cookies and security settings:

1. From the **Today** screen, tap **Start > Internet Explorer**.
2. Tap **Menu > Tools > Options...**

Applications and multimedia

3. Tap the **Security** tab.
4. Tick the checkboxes for the required security options.
5. Tap **ok**.

To clear cookies:

1. From the **Today** screen, tap **Start > Internet Explorer**.
2. Tap **Menu > Tools > Options...**
3. Tap the **Security** tab.
4. Tap **Clear Cookies**.
5. Tap **ok**.

Clearing History and temporary files

When you use the Internet, your Toshiba phone stores data that uses up some of the storage capacity of the phone. You can delete these files to free up storage.

To clear **History** and temporary files:

1. From the **Today** screen, tap **Start > Internet Explorer**.
2. Tap **Menu > Tools > Options...**
3. Tap the **Memory** tab.
4. Tap **Clear History** to delete web page links stored in the **History**.

5. Tap **Delete Files** to delete temporary internet files.
6. Tap **ok**.

Sending a link

To send a link using **Messaging**:

1. From a web page, tap **Menu > Tools > Send Link...**
2. Select the **Messaging** account to use to send the link. A new message is created with the web page address in the body of the message.
3. Add a recipient and edit the message if required.
4. Tap **Send**.

Games

Your Toshiba phone comes preloaded with two games.

To access the games on your Toshiba phone:

1. From the **Today** screen, tap **Start > Programs**.
2. Tap **Games**.
3. Tap the required game.

Applications and multimedia

TOSHIBA User Interface

This application enables you to quickly access all items of the Toshiba UI. For further information on the Toshiba UI, see **TOSHIBA User Interface in Getting started**.

ActiveSync

ActiveSync enables you to create a synchronisation relationship between your Toshiba phone and PC, and between your Toshiba phone and your Exchange server. This means that the shared data, such as contacts and tasks, is always consistent. If you make a change, it is automatically made to the corresponding information on the other computer. This is an effective way of keeping your data up-to-date.

The synchronisation relationship is created to manage the data that is copied between your Toshiba phone and PC.

You can connect your Toshiba phone to your PC using the USB cable or over a Bluetooth connection.

You can also use **ActiveSync** to connect your Toshiba phone to other resources through your PC. However, you cannot synchronise remotely to a PC using a modem or network connection. You can connect to your Exchange server using a cellular connection, or you can connect your Toshiba phone to your PC as a way of connecting back to the Internet.

Applications and multimedia

Installing and setting up ActiveSync

You can either install **ActiveSync** from your Windows Mobile Getting Started CD or you can download a copy of **ActiveSync** from <http://www.microsoft.com/windowsmobile/activesync/activesync45.msp>.

Once the software has been installed and your Toshiba phone is connected to your PC, the ActiveSync Setup Wizard is started. Simply follow the on-screen instructions.



NOTE: If you have a PC which is already fully synchronized with your Exchange server, you should synchronise your Toshiba phone with your PC rather than synchronising your Toshiba phone with the Exchange server. Data will be downloaded via your PC, saving you the charges for traffic volume. In addition, synchronising via your mobile phone network will take longer than it would with your local PC.

If you are not synchronising directly with a Microsoft Exchange server, do not select the option to synchronise directly with a server. The alternative is to synchronise your Toshiba phone with your PC. You cannot do both at the same time.

Changing ActiveSync settings

Once you have set up synchronisation using the ActiveSync Setup Wizard on the PC, you can change your synchronization settings at a later stage:

- If you want to change **ActiveSync** settings for synchronising with a PC, use **ActiveSync** on the PC. For more information, see ActiveSync Help on the PC.
- If you want to change **ActiveSync** settings for synchronising with an Exchange server, use **ActiveSync** on your Toshiba phone.



NOTE: Disconnect your Toshiba phone from your PC before changing the synchronisation settings.

Starting and stopping synchronisation

To start and stop synchronisation:

1. From the **Today** screen, tap **Start > Programs**.
2. Tap **ActiveSync**.
3. To start synchronisation, tap **Sync**.
4. To stop synchronisation, tap **Stop**.

Applications and multimedia

A-GPS

A-GPS enables you to regularly download updated GPS satellite data. This can improve the GPS performance.

Using **A-GPS** greatly reduces the time taken by your Toshiba phone to calculate its starting location when first switched on. There will also be improved performance in challenging environments, such as indoors and when surrounded by tall buildings or trees.

You can set **A-GPS** to automatically download updated GPS data, or you can manually update the data.

To access **A-GPS**:

1. From the **Today** screen, tap **Start > Programs**.
2. Tap **A-GPS**.

AutoConfig

For details of **AutoConfig**, refer to **Auto Configurator** in **Getting started**.

AutoInstall

AutoInstall enables you to easily install applications loaded on your Toshiba phone.

To install applications using **AutoInstall**:

1. From the **Today** screen, tap **Start > Programs**.
2. Tap **AutoInstall**.
3. Tick the checkboxes for the applications to install. To select all applications, tap **Menu > Select All**.
4. Tap **Next**.
5. Tap **Yes** to confirm the installation.
6. Tap **ok** when the installation is complete. You may need to restart your Toshiba phone for the changes to take effect.

Applications and multimedia

BlackList

BlackList enables you to allow or block incoming calls from particular contacts or groups. You can set specific times for allowing and blocking callers. The blocked caller will receive a busy tone when they call you.

The default **BlackList** settings allow the following groups to call you:

- **All** - all callers.
- **Unknown** - callers with no caller ID.
- **All Contacts** - callers with a phone number that is stored in **Contacts**.
- **Not in Contacts** - callers with a phone number that is not stored in **Contacts**.

You can also disable or enable the **BlackList** service.

Allowing and blocking groups

To allow or block the default **BlackList** groups:

1. From the **Today** screen, tap **Start > Programs**.
2. Tap **BlackList**.
3. Tap and hold the required group. The pop-up menu is displayed.
4. Select the required action from the following:
 - To allow the group, tap **Set Action > Allow**.

- To block the group, tap **Set Action > Block**.
5. Tap **ok**.

Setting specific times

To set specific times for allowing or blocking a group:

1. From the **Today** screen, tap **Start > Programs**.
2. Tap **BlackList**.
3. Tap and hold the required group.
4. Tap **Edit**.
5. In the **Action:** field, select whether to **Allow** or **Block** the group.
6. Tick the **Enable during set times** checkbox.
7. Select the days and times during which you want to allow or block the group.
8. If you want to be notified when a call has been blocked, tick the **Show notifications** checkbox.
9. Tap **Save**.
10. Tap **ok**.

Adding a block

To add a new block:

1. From the **Today** screen, tap **Start > Programs**.
2. Tap **BlackList**.

Applications and multimedia

3. Tap **Menu** > **New**.
4. Tap the grey box in the top right corner.
5. Select an existing contact or add a new contact to block.
6. Edit the settings as required.
7. Tap **Save**.
8. Tap **ok**.

Deleting a block

To delete an existing block:

1. From the **Today** screen, tap **Start** > **Programs**.
2. Tap **BlackList**.
3. Tap and hold the required group.
4. Tap **Delete**.
5. Tap **ok**.



TIP: You can only delete groups or contacts that you have added.

Disabling/Re-enabling BlackList

When you disable the **BlackList** service, all **BlackList** settings will be ignored.

To disable the **BlackList** service:

1. From the **Today** screen, tap **Start** > **Programs**.
2. Tap **BlackList**.

3. Tap **Menu** > **Disable Service**.
4. Tap **ok**.

To re-enable the **BlackList** service:

1. From the **Today** screen, tap **Start** > **Programs**.
2. Tap **BlackList**.
3. Tap **Menu** > **Enable Service**.
4. Tap **ok**.

Calculator

To access the **Calculator**:

1. From the **Today** screen, tap **Start** > **Programs**.
2. Tap **Calculator**.

Use the **Calculator** buttons to enter numbers and perform calculations.

Applications and multimedia

Camera

Your Toshiba phone is equipped with a digital camera which can be used to capture photographs and video clips.





Starting the Camera

You can launch the **Camera** application using one of the following methods:

- From the **Today** screen, tap **Start > Programs > Camera**.
- Press the **Camera key**.

Capturing a photo

To capture a photo:



1. Start the **Camera**.
2. Aim the camera at the subject, then press the **Action key** or **Camera key**. A preview of the photo is displayed.
3. Select the required action by tapping one of the following icons:
 -  - to save the photo and return to the main **Camera** screen.
 -  - to send the photo in an e-mail.
 -  - to beam the photo to another device.
 -  - to send the photo in an MMS message.



TIP: You can also send a photo in an MMS message by selecting MMS photo mode () before capturing the photo.

-  - to delete the photo.

To capture a framed photo:



1. Tap the mode icon () until framed photo mode () is displayed.
2. To change the frame, tap the frame icon () until the required frame is displayed.
3. Capture the photo by pressing the **Action key** or **Camera key**.



Capturing a video

To capture a video:

1. Start the **Camera**.
2. Tap the mode icon until video mode () is displayed.
3. Aim the camera at the subject, then press the **Action key** or **Camera key** to start recording the video.
4. Press the **Action key** or **Camera key** to stop recording the video.
5. Select the required action by tapping one of the icons (see **Capturing a photo** for details of the icons).

Applications and multimedia

 **TIP:** You can send a video in an MMS message by selecting MMS video mode  before capturing the video.







 **TIP:** You can capture a framed video by selecting framed video mode  before capturing the video.



Main Camera screen

The following options are available from the main **Camera** screen:

-  - to select the required resolution for the photo or video. The default resolution is dependent on the **Camera** mode.

 **NOTE:** Images of higher resolution (quality) will use more storage space.

-  - to activate/deactivate the **Camera** flash.
-  - to set the storage location for photos and videos if you have a storage card installed.
-  - to exit the **Camera** application.
-  - to zoom in.
-  - to zoom out.
-  - to access the **Camera** settings. These settings include extra photo and video settings, as well as advanced settings such as colour effects and ambient light settings.

-  - to access **Pictures & Videos**.
-  - to use the front camera (for example, to take a self-portrait photograph).
-  - to use the rear camera (default).

Tips for using the camera

- Fingerprints or grease sticking to the lens may result in problems such as blurred pictures. If this happens, you should wipe the lens clean with a lens tissue.
- Try to maintain a steady hand when capturing pictures. Any movement of the phone may lead to blurred pictures.
- Avoid aiming the camera at bright light sources as this will affect the quality of the picture.

Applications and multimedia

Certificate Enrollment

Certificate Enrollment enables you to add or enroll for trusted digital certificates.

To use **Certificate Enrollment**:

1. From the **Today** screen, tap **Start > Programs**.
2. Tap **Certificate Enrollment**.
3. Enter your user name and password, and the server from which to obtain the certificate.
4. Tap **Certificate Fetch**. The certificate request is sent to the server.

File Explorer

File Explorer enables you to view and manage files saved in your Toshiba phone, or on a storage card.

To access **File Explorer**:

1. From the **Today** screen, tap **Start > Programs**.
2. Tap **File Explorer**. The **My Documents** folder is opened by default.

FM Radio

You can listen to FM radio stations on your Toshiba phone using the **FM Radio** application.

You can manually search for new radio stations, save favourite stations, and record current or scheduled radio programmes.



NOTE: You can only use the **FM Radio** application when the headset is connected.

To access **FM Radio**:

1. From the **Today** screen, tap **Start > Programs**.
2. Tap **FM Radio**.

Applications and multimedia

The main **FM Radio** screen is shown opposite. The main items and functions on this screen are as follows:

1. Radio signal strength.
2. Current radio channel and frequency.
3. Frequency slider bar. Drag this bar to change the frequency.
4. Current volume.
5. Saved radio stations.
6. To play a previously saved audio file.
7. To skip to the previous radio station in the list.
8. To skip to the next radio station in the list.
9. To stop playing or recording of an audio file.
10. To start recording the current radio station.
11. To toggle playback between headset and phone speaker.
12. To change the volume.

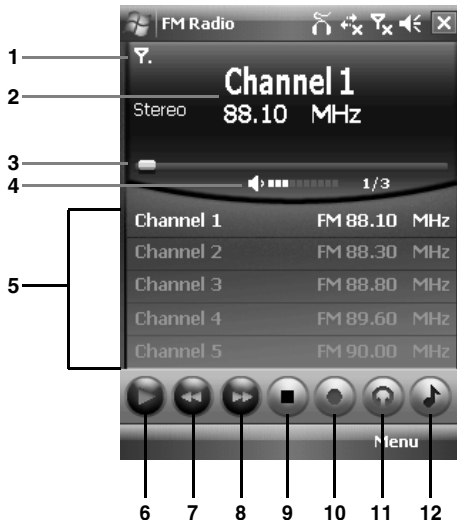

Applications and multimedia

The following menu items are available when using the **FM Radio** application:

- **Auto Scan** - starts automatic scanning for radio stations.

 **NOTE:** If you use the **Auto Scan** feature, the current list of radio stations will be deleted.

- **Favourites** - to add, edit and delete saved radio stations.
- **Auto recording** - to set up recording of a future radio programme.
- **Settings** - to edit the **FM Radio** settings. These include settings for saved audio files, settings to be used when the signal quality is low, and settings for services such as traffic announcements.
- **About** - to view details of the **FM Radio** application.
- **Exit** - to exit the **FM Radio** application.

 **NOTE:** The **FM Radio** application will be muted during a voice call. When you end the call, the radio will resume.

Full Screen Keyboard

For details of **Full Screen Keyboard**, refer to **Full Screen Keyboard** in **Text input**.

Getting Started

Getting Started gives you step-by-step instructions for carrying out common procedures with your Toshiba phone.

To access **Getting Started**:

1. From the **Today** screen, tap **Start > Programs**.
2. Tap **Getting Started**.
3. Tap a procedure to view the instructions.

Home

Home enables you to access the **Home** screen. This is the main Toshiba UI screen. For further information on the Toshiba UI, see **TOSHIBA User Interface** in **Getting started**.

Applications and multimedia

Image Editor

Image Editor enables you to easily edit images stored on your Toshiba phone.

To start using **Image Editor**:

1. From the **Today** screen, tap **Start > Programs**.
2. Tap **Image Editor**.
3. Tap an image to edit.

Image Editor functions

Tap the file icon  to open image files, save edited files, view information about the **Image Editor** application, or exit **Image Editor**.

Tap the edit icon  to access and use the main editing tools, including cropping and transformation tools.

Tap the filter icon  to select and apply filters and colour effects to the image.

Tap the frame icon  to select and add a frame to the image.

Tap the clip art icon  to select and add clip art to the image.

Image To Text

Image To Text is an Optical Character Reader (OCR) application that enables you to scan business cards or documents using the **Camera** application. You can save the extracted data as a contact or a plain text document.

Saving business card information

To save business card information as a contact:

1. From the **Today** screen, tap **Start > Programs**.
2. Tap **Image To Text**.
3. Tap **Business Card Reader**.
4. Select the source of the image file.
 - Select **Camera** to start the **Camera** application. Tap **Next**, then capture a photograph of the business card.
 - Select **My Pictures** to open the **My Pictures** folder, then tap the required image.
5. Tap **Next**.
6. Wait a few seconds while the image is processed.
7. Edit details of the contact as required.
8. Tap **Menu > Save > Outlook Contacts/SIM Contact**, depending on where you would like the contact to be stored.

Applications and multimedia



NOTE: When saving the contact to the SIM card, only the fields supported on the SIM card will be saved.

9. Tap **ok** when the confirmation is displayed.



TIP: Depending on the contact details available, you can call the contact, send them a text message or e-mail, or browse the contact's URL using the menu items from the current screen.

10. Tap **Menu > Back** as many times as needed to return to the first **Image To Text** screen.

11. Tap **ok**.

Saving plain text information

To save plain text information from an image:

1. From the **Today** screen, tap **Start > Programs**.

2. Tap **Image To Text**.

3. Tap **Newspaper Reader**.

4. Select the source of the image file.

- Select **Camera** to start the **Camera** application. Tap **Next**, then capture a photograph of the required text.
- Select **My Pictures** to open the **My Pictures** folder, then tap the required image.

5. Tap **Next**.

6. Wait a few seconds while the image is processed.

7. Edit the text information as required.

8. Tap **Menu > File > Save As...**

9. Edit the name, file type and storage location as required.

10. Tap **Save**.

11. Tap **ok** twice.

12. Tap **Menu > Back** as many times as needed to return to the first **Image To Text** screen.

13. Tap **ok**.

Internet Sharing

For details of **Internet Sharing**, refer to **Internet Sharing** in **Connectivity**.

Applications and multimedia

JBlend

Your Toshiba phone supports Java applications (also known as MIDlets) that are written for mobile devices. Java applications include games and utilities.

Your phone supports Java 2 Edition and J2ME. The **JBlend** application on your Toshiba phone enables you to download, install and manage Java applications.

To access the **JBlend** application:

1. From the **Today** screen, tap **Start > Programs**.
2. Tap **JBlend**.

Installing a Java application

To install a Java application:

1. From the **Today** screen, tap **Start > Programs**.
2. Tap **JBlend**.
3. Tap **Install**.
4. Select where to install the application from:
 - To install from a website, tap **Download**. This will launch the default browser. Go to the website with the required Java application and download the application. It is then loaded into the **JBlend** application.

- To install an application stored on your Toshiba phone, tap **Local Install**. All uninstalled Java applications stored on the phone and the storage card are displayed. Select one to install.
5. The details of the selected application will be displayed and you will be prompted to confirm the installation. Tap **Yes** to install the application.
 6. Wait a few seconds while the application is installed. You can then run the application.

Running a Java application

Once Java applications are successfully installed, they are displayed on the main **JBlend** screen.

To run a Java application:

1. From the **Today** screen, tap **Start > Programs**.
2. Tap **JBlend**.
3. Tap the required application.

Applications and multimedia

Deleting Java applications

You may want to delete Java applications to free up memory.

To delete a single installed Java application:

1. From the **Today** screen, tap **Start > Programs**.
2. Tap **JBlend**.
3. Scroll to the required application, then tap **Menu > Application > Delete**.
4. Tap **Yes** to confirm the deletion.

To delete all installed Java applications:

1. From the **Today** screen, tap **Start > Programs**.
2. Tap **JBlend**.
3. Tap **Menu > Application > Delete All**.
4. Tap **Yes** to confirm the deletion.

Exiting the JBlend application

To exit the **JBlend** application:

From the main **JBlend** screen, tap **Menu > Exit**.

Messenger

Windows Live Messenger on your Toshiba phone enables you to:

- send instant messages or join group chats.
- set your status and see the presence of friends and colleagues.
- send messages via voice as well as text.
- send pictures and files.
- use emoticons to express how you feel.

To use **Windows Live Messenger**, you need **Windows Live ID** credentials.

For details of **Windows Live ID**, go to:

<https://accountservices.passport.net/ppnetworkhome.srf>.

You will also need to sign in to **Windows Live** before you can sign in to **Windows Live Messenger**.

To access **Windows Live Messenger**:

1. From the **Today** screen, tap **Start > Programs**.
2. Tap **Messenger**.

Applications and multimedia

Notes

With **Notes**, you can quickly capture ideas, questions, reminders, to-do lists and meeting notes by writing, typing or recording your voice in a note. This is especially useful when you don't have a pen and paper to hand.

For further details of **Notes**, refer to **Drawing and writing on the screen** in **Text input**.

Creating a note

To create a note:

1. From the **Today** screen, tap **Start > Programs**.
2. Tap **Notes**.
3. Tap **New**.
4. Change the input method if required. Refer to **Input methods** in **Text input** for further details.
5. Enter the note using your selected input method.
6. Tap **ok** when you have finished.



NOTE: To record a voice note, use the recording toolbar.

If this bar is not displayed, tap **Menu > View Recording Toolbar**.

Viewing or playing a note

To view a or play a note:

1. From the **Today** screen, tap **Start > Programs**.
2. Tap **Notes**.
3. Tap the note to view or play.

Applications and multimedia

Picse! Viewer

Picse! Viewer is a tool used to view documents.

Opening Picse! Viewer

To open **Picse! Viewer**:

1. From the **Today** screen, tap **Start > Programs**.
2. Tap **Picse! Viewer**.
3. Tap the required document.

Picse! Viewer menu

To access the **Picse! Viewer** menu:

1. From the **Today** screen, tap **Start > Programs**.
2. Tap **Picse! Viewer**.
3. If the **Open** screen is displayed, tap the **Cancel** button.
4. Tap **Menu**.

Picse! Viewer has the following menu items:

- **Open File** - to open the selected file.
- **Recent** - to display the list of recently viewed files.
- **Page** - to rotate or resize the page, or view a different page in the document.
- **Settings** - enables you to clear the history and select the file types to associate with **Picse! Viewer**. You can also view information about the **Picse! Viewer** application.
- **Close** - to close **Picse! Viewer**.

Applications and multimedia

Pictures & Videos

Viewing pictures and videos

You can view pictures and videos stored on your Toshiba phone or storage card using the **Pictures & Videos** application.

To view pictures and videos:

1. From the **Today** screen, tap **Start > Programs**.
2. Tap **Pictures & Videos**.
3. Tap the required picture or video.

Pictures & Videos menu items

The following menu items are available when a picture is highlighted in the main **Pictures & Videos** screen:

- **Send...** - to send a picture or video in an MMS message or e-mail.
- **Beam...** - to send a picture or video over a Bluetooth connection.
- **Save to Contact...** - to save a picture to a contact.
- **Delete** - to delete a picture or video.
- **Edit** - enables you to move and copy pictures and videos between folders.

- **Play Slide Show** - to play all pictures in the current folder as a slide show.
- **Set as Today Background...** - to set the picture as the background for the **Today** screen.
- **Go To** - to view pictures and videos stored in other folders on your Toshiba phone.
- **Tools** - to display file information, sort files, and access settings for configuration of the **Pictures & Videos** application.
- **Send to your space** - to send a picture to your **Windows Live** space.

The following menu items are available when viewing a picture:

- **Zoom** - to zoom in or out of the picture.
- **Play Slide Show** - to play all pictures in the current folder as a slide show.
- **Set as Today Background...** - to set the picture as the background for the **Today** screen.
- **Beam picture...** - to send the picture over a Bluetooth connection.
- **Save** - to save the picture to a contact or rename the picture.
- **Edit** - to edit the picture using the simple tools built in to the **Pictures & Videos** application.
- **Properties** - displays information about the picture, such as file type and size.

Applications and multimedia

- **Options...** - to access settings for configuration of the **Pictures & Videos** application.
- **Send to your space** - to send the picture to your **Windows Live** space.

Search

You can search for files and other items stored on your Toshiba phone in the **My Documents** folder or on a storage card.

You can search by file name or by keywords located in the item. For example, you can search e-mail messages, notes, appointments, contacts, and tasks as well as in **Help**.

To search for a file or an item:

1. From the **Today** screen, tap **Start > Programs**.
2. Tap **Search**.
3. In the **Search for:** field, enter the file name, word, or other information you require.
4. If you have searched for an item before, tap the arrow to the right of the **Search for:** field to find it in the searching history.
5. In the **Type:** field, select a data type to help narrow your search.
6. Tap **Search**.

In the **Results** list, you can tap the item you require to open it.



NOTE: The **My Documents** folder and its subfolders are included in the search.



NOTE: Results found on a storage card are indicated by an icon.

Applications and multimedia

SIM Toolkit

When you install a SIM card that has applications loaded on it, you can run the applications using the **SIM Toolkit** application.

To run an application from the SIM card:

1. From the **Today** screen, tap **Start > Programs**.
2. Tap **SIM Toolkit**. The list of SIM applications is displayed.
3. Select the application that you want to run, then tap **Select**.



NOTE: The **SIM Toolkit** icon () is not displayed when the installed SIM card does not have any applications loaded.

The title of this icon depends on title of the SIM.

Streaming Player

Streaming Player enables you to play live and recorded streaming media on your Toshiba phone.

To use **Streaming Player**:

1. From the **Today** screen, tap **Start > Programs**.
2. Tap **Streaming Player**.
3. Tap **Open**.
4. Enter the URL of the required media, then tap **Connect**.



NOTE: To access the URL of a streaming media item, your Toshiba phone must connect to the network. For more information about connecting your phone to a network, refer to **Internet connections in Connectivity**.

To edit the **Streaming Player** settings:

1. From the **Today** screen, tap **Start > Programs**.
2. Tap **Streaming Player**.
3. Tap **Menu > Options**.
4. Edit the settings as required, then tap **Done**.

Task Manager

For details of **Task Manager**, refer to **Task Manager** in **Settings**.

Applications and multimedia

Tasks

With the **Tasks** application, you can create one-off tasks or recurring tasks. You can also set reminders for your tasks, and organise them by category.

Overdue tasks will be displayed in red.

Creating a task

To create a new task:

1. From the **Today** screen, tap **Start > Programs**.
2. Tap **Tasks**.
3. Tap **Menu > New Task**.



TIP: You can also create a task by entering a name for the task in the **Tap here to add a new task** field, then pressing the **Action** key. However, using this method you will need to add the details of the task separately.

4. Edit the details of the task as required.
5. Tap **ok**.



TIP: You can synchronise tasks on your Toshiba phone with your PC. This will keep tasks up to date in both locations.

If you create a new task with a reminder on your PC and then synchronise tasks with your phone, the reminder is activated at the time set on your PC.

Applications and multimedia

Changing the status of a task

When a new task is created, it will be set as active. When you have completed the task, you can update its status.

To mark a task as completed:

1. From the **Today** screen, tap **Start > Programs**.
2. Tap **Tasks**.
3. Scroll to the required task, then tap **Complete**.



TIP: If you need to reactivate a task, scroll to the required task, then tap **Activate**.

Sorting and filtering tasks

To sort and filter tasks:

1. From the **Today** screen, tap **Start > Programs**.
2. Tap **Tasks**.
3. To sort the tasks, tap **Menu > Sort By**, then select an item by which to sort the list
or
to filter the tasks, tap **Menu > Filter**, then select a filter.



TIP: You can use the filter option for **Active Tasks** or **Completed Tasks** at the same time as another filter.

Deleting a task

To delete a task:

1. From the **Today** screen, tap **Start > Programs**.
2. Tap **Tasks**.
3. Tap the required task.
4. Tap **Menu > Delete**.
5. Tap **Yes** to confirm the deletion.

Windows Live

Windows Live gives access to searching using **Live Search**, as well as access to **Windows Live Messenger**.

For information on using **Live Search**, see **Searching the Internet using Live Search**.

For information on **Windows Live Messenger**, see **Messenger**.

Applications and multimedia

Windows Media

Overview of Windows Media Player Mobile

You can use Windows Media Player 10 Mobile to play digital audio and video files that are stored on your Toshiba phone, a storage card or on the Internet.

Windows Media Player Mobile can play files with the following extensions by default:

- .asf
- .wma
- .wmv
- .mp3.

Your Toshiba phone can also play .mid, .wav, .3gp and .mp4 files.

Overview of screens and menus

Windows Media Player Mobile has three primary screens:

- **Library** screen - enables quick access of files and playlists. It also includes an item that enables you to switch to the **Now Playing** screen.

To switch to the **Playback** screen from the **Library** screen, tap **ok**.

The **Library** screen will be the default screen displayed when you first use Windows Media Player Mobile.

- **Now Playing** screen - displays the **Now Playing** playlist. This shows the file currently playing, as well as any files that are queued up to play next.
- **Playback** screen - displays the playback controls and the video window. You can change the appearance of this screen by selecting a different skin.

Tapping **Menu** from any of these screens will give menu items relevant to the screen.

Applications and multimedia

Library screen menu items

- **Queue Up** - adds the highlighted item to the end of the current playlist.
- **Delete from Library** - deletes the highlighted item from the library.
- **Now Playing** - switches to the **Now Playing** screen.
- **Library** - to switch between libraries.
- **Update Library...** - adds new items to the library by searching your Toshiba phone, and storage card if available.
- **Open File...** - enables you to play files that are stored on your phone or storage card but are not in the library.
- **Open URL...** - enables you to play a file stored on a network, such as the Internet.
- **Properties** - displays information about the highlighted file.

Now Playing screen menu items

- **Library...** - switches to the **Library** screen.
- **Move Up** - moves the highlighted item up in the playlist order.
- **Move Down** - moves the highlighted item down in the playlist order.
- **Remove from Playlist** - deletes the highlighted item from the playlist.
- **Shuffle/Repeat > Shuffle** - sets items in the playlist to play in a random order.
- **Shuffle/Repeat > Repeat** - sets items in the playlist to play repeatedly.
- **Save Playlist...** - to save the current playlist. You can enter a name for the playlist, or a default name can be used.
- **Clear Now Playing** - to delete all items from the **Now Playing** playlist.
- **Error Details**- displays error information about the highlighted item. An exclamation mark is displayed before the item name if error details are available.
- **Properties** - displays information about the highlighted file.

Applications and multimedia

Playback screen menu items

- **Library...** - switches to the **Library** screen.
- **Play/Pause** - starts or pauses playback.
- **Stop** - stops playback.
- **Shuffle/Repeat > Shuffle** - sets items in the playlist to play in a random order.
- **Shuffle/Repeat > Repeat** - sets items in the playlist to play repeatedly.
- **Full Screen** - plays video files in full screen mode.
- **Options...** - enables you to set options for Windows Media Player Mobile, including changing the appearance of the **Playback** screen.
- **Properties** - displays information about the current file.
- **About** - displays information about Windows Media Player Mobile.

Playing items stored on your Toshiba phone

Use the **Library** to find and play music, videos, and playlists that are stored on your Toshiba phone or storage card.

To play an item stored on your Toshiba phone:

1. From the **Today** screen, tap **Start > Programs**.
2. Tap **Windows Media**.
3. If the item is in the **Library**, scroll to the item, then tap **Play**.

If the item is not in the **Library**, tap **Menu > Open File...** Scroll to the item, then tap **Play**.



TIP: To add files to the **Library**, tap **Menu > Update Library...**

Playing items stored on a network

To play an item stored on a network:

1. From the **Today** screen, tap **Start > Programs**.
2. Tap **Windows Media**.
3. From the **Library** screen, tap **Menu > Open URL...**
4. Enter the URL of the file, then tap **OK**, or select a URL from the **History:** field.

Applications and multimedia

 **NOTE:** To play an item on a network, your Toshiba phone must connect to the network. For more information about connecting your phone to a network, refer to **Internet connections** in **Connectivity**.

Changing the appearance of the player

You can change the appearance of the **Playback** screen by selecting a new skin.

To select a new skin:

1. From the **Today** screen, tap **Start > Programs**.
2. Tap **Windows Media**.
3. Tap **Menu > Options...**
4. Tap the **Skins** tab.
5. Tap the required skin.
6. Tap **ok**.

 **NOTE:** To download new skins, access the Wmplugins website at: www.wmplugins.com.

After downloading a skin to your computer, use **ActiveSync** to copy the *.skn and *.bmp files to your Toshiba phone. To ensure that the skin is displayed on the **Skins** tab, do not store skin files in the Windows folder on your Toshiba phone.

Troubleshooting

If you encounter any difficulty while using Windows Media Player Mobile, refer to the Troubleshooting Windows Media Player Mobile page on the Microsoft website at:

<http://www.microsoft.com/windows/windowsmedia/player/windowsmobile/troubleshooting.aspx>.

Connectivity

Wireless Manager

Wireless Manager enables you to easily switch the **Phone**, **Data**, **Bluetooth** and **Wi-Fi** functionality on or off.

To access **Wireless Manager**:

- From the **Today** screen, tap the area displaying the service provider name.
- From the **Today** screen, tap **Start > Settings > Connections > Wireless Manager**.

Switching radio transmission on/off

You can switch the telephony radio transmission of your Toshiba phone on and off.

When the radio transmission is off, it is in '**Flight Mode**'. In this mode, you will not be able to make or receive calls, send or receive messages, or access the Internet.

To switch radio transmission on/off:

From **Wireless Manager**, tap the **Phone** item. Radio transmission will toggle on or off.

Disconnecting current active data connection

You can disconnect an active data connection without switching off the radio transmission by tapping **Data** from **Wireless Manager**.

However, the data connection will automatically reconnect if you are using Direct Push e-mail. This is because your Toshiba phone must have a connection permanently open to receive e-mails from the e-mail server. To disconnect the data connection in this scenario, you must first disable the Direct Push e-mail.

To disable Direct Push e-mail:

1. From the **Today** screen, tap **Start > Programs**.
2. Tap **ActiveSync**.
3. Tap **Menu > Schedule...**
4. Set the **Peak times:** and **Off-peak times:** fields to **Manually**.

To re-enable Direct Push e-mail:

1. From the **Today** screen, tap **Start > Programs > ActiveSync**.
2. Tap **Menu > Schedule...**
3. Set the **Peak times:** and **Off-peak times:** fields to **As items arrive**.

Connectivity

Switching all wireless functions on/off

To switch all wireless functions on or off at the same time:

From **Wireless Manager**, tap **Switch all Wireless Off**.



NOTE: You can conserve battery power by switching off **Bluetooth** and **Wi-Fi** when they are not in use.

Bluetooth

Bluetooth is a short-range wireless communications technology. Devices with Bluetooth capabilities can exchange data over a distance of approximately 10 metres without requiring a wired connection.

Bluetooth on your Toshiba phone has three modes: **Off**, **On** and **Visible**.

In **Off** mode, you cannot send or receive data using Bluetooth.

In **On** mode, your Toshiba phone can search for and connect to other devices. However, your phone will not be visible in searches by other devices.

In **Visible** mode, your Toshiba phone can search for and connect to other devices. Your phone will also be visible to other devices.

Changing Bluetooth mode

By default, Bluetooth is in **Off** mode. Bluetooth will remain in the same mode when turning your Toshiba phone off and on.

To change Bluetooth mode:

1. From the **Today** screen, tap **Start > Settings**.
2. Tap the **Connections** tab.
3. Tap **Bluetooth**.
4. Tap the **Mode** tab.

Connectivity

5. To set Bluetooth to **Off** mode, untick the **Turn on Bluetooth** checkbox.

To set **Bluetooth** to **On** mode, tick the **Turn on Bluetooth** checkbox.

To set **Bluetooth** to **Visible** mode, tick both the the **Turn on Bluetooth** and **Make this device visible to other devices** checkboxes.



TIP: You can also toggle Bluetooth mode using **Wireless Manager**.

Pairing devices

When devices are paired, a relationship is created that enables the exchange of data between the devices.

The pairing can be set up using a passcode, which will ensure that exchanged data is kept secure.

Pairing of devices only needs to be carried out once. After this, the devices can connect to each other and exchange data without the passcode needing to be entered again.

Before pairing your Toshiba phone with another device, ensure that:

- Your Toshiba phone and the other device are within 10 metres of each other.
- Bluetooth on your Toshiba phone is set to **On** or **Visible**.

- Bluetooth on the other device is set to **Visible**.

To pair your Toshiba phone with another device:

1. From the **Today** screen, tap **Start > Settings**.
2. Tap the **Connections** tab.
3. Tap **Bluetooth**.
4. On the **Devices** tab, tap **Add new device...**
Your Toshiba phone will search for other Bluetooth-enabled devices and display them in a list.
5. Tap the required device, then tap **Next**.
6. For enhanced security, enter a passcode in the **Passcode:** field. This is alphanumeric, and can be between 1 and 16 characters in length.
7. Tap **Next**.
8. Wait for the other device to accept the pairing. If a passcode has been set on your Toshiba phone, then it will need to be entered on the other device.
9. To edit the settings for the device, tap **Advanced**. You can then edit the name to be used for the device, and select services to use from the device. Tap **Save** when you have finished.
To finish the pairing without editing the settings, tap **Done**.

Connectivity

Connecting a Bluetooth headset

Before connecting a Bluetooth headset to your Toshiba phone, ensure that:

- Bluetooth on your Toshiba phone is set to **Visible**.
- the Bluetooth headset is set to pairing mode.

To connect a Bluetooth headset:

1. From the **Today** screen, tap **Start > Settings**.
2. Tap the **Connections** tab.
3. Tap **Bluetooth**.
4. On the **Devices** tab, tap **Add new device...**
5. Tap the Bluetooth headset in the list of devices, then tap **Next**.
6. Enter the passcode for the headset. This will be provided with your Bluetooth headset.
7. Tap **Next**.
8. Wait for the headset to accept the pairing.
9. A confirmation will be displayed when the headset has been connected. Tap **Advanced**.
10. If required, edit the name of the headset.
11. Make sure that the **Hands Free** checkbox is ticked. If you are using a stereo Bluetooth headset, also make sure that the **Wireless Stereo** checkbox is ticked.
12. Tap **Save** when you have finished.

Unpairing devices

To unpair your Toshiba phone from another device:

1. From the **Today** screen, tap **Start > Settings**.
2. Tap the **Connections** tab.
3. Tap **Bluetooth**.
4. On the **Devices** tab, tap and hold the required device.
5. When the options are displayed, tap **Delete**.
6. Tap **Yes** to confirm the deletion.

Bluetooth security

Although your Toshiba phone has security features compliant with the Bluetooth standard specification, this security might not work properly when using your Toshiba phone in a non-secure environment. Take care when using the Bluetooth feature.

Connectivity

Beam

The term '**Beam**' is used to describe the short range transfer of data between two devices via a Bluetooth connection.

You can beam **Calendar**, **Contacts**, **Tasks**, and **Pictures & Videos** items, and other files stored on your Toshiba phone, to other devices.



NOTE: Bluetooth must be set to **On** or **Visible** to send beamed items.

To receive beamed items, Bluetooth must be set to **Visible**.

Beaming an item

To beam an item to another device:

1. Scroll to the item that you want to beam, then tap **Menu > Beam...** (This path will vary slightly depending on the type of item that you want to beam.)
2. Tap the device to which you want to send the item.

Configuring your Toshiba phone to receive beamed data

To configure your Toshiba phone to receive beamed data:

1. From the **Today** screen, tap **Start > Settings**.
2. Tap the **Connections** tab.
3. Tap **Beam**.
4. Tick the **Receive all incoming beams** checkbox, then tap **ok**.

Cell Broadcast

Cell Broadcast receives broadcast channel information and news from your service provider.



NOTE: This functionality is only available if it is supported by your service provider. Please contact your service provider for further information.

Connectivity

Internet connections

Your Toshiba phone is equipped with powerful networking functions that enable you to connect to the Internet through a General Packet Radio Service (GPRS) or Universal Mobile Telecommunications System (UMTS) network. You can set up connections to the Internet or to a corporate network to browse the Internet, and exchange e-mail or instant messages.

Your phone has two groups of connection settings:

My ISP and **My Work Network**. The **My ISP** settings are used to connect to the Internet, while **My Work Network** settings can be used to connect to any private, corporate network.



NOTE: Before you begin, you will need to obtain the following information:

- From your phone service provider - data connectivity plan information, access point name, and PAP/CHAP security settings.
- From your ISP or wireless service provider - access point name, user name and password, and other security information.



NOTE: If you connect to the Internet using your service provider's data network, the service may be provided through a GPRS connection (fast, but generally billed by volume of data transferred), or through a Circuit Switched Data (CSD) connection (slow, but generally billed by amount of time connected). You should check with your service provider which connection you will be using on their network.

Connectivity

Setting up a GPRS connection

GPRS is a packet-based wireless communication service which enables data to be sent and received using mobile phones.

You can use GPRS to connect to the Internet or to send and receive MMS messages using your phone. When you use GPRS, you will usually be billed based on the data traffic volume. However, you should check billing information with your service provider.



NOTE: Before setting up a GPRS connection, you will need to obtain the required settings from your service provider. As a minimum, the access point name will be required.



TIP: You can quickly and easily configure your GPRS settings using **Auto Configurator**. For details, see **Auto Configurator** in **Getting started**.

To set up a GPRS connection manually:

1. From the **Today** screen, tap **Start > Settings**.
2. Tap the **Connections** tab.
3. Tap **Connections**.
4. On the **Tasks** tab, tap **Add a new modem connection** for the required group.
5. Enter a name for the connection.
6. In the **Select a modem:** field, select **Cellular Line (GPRS)**.
7. Tap **Next**.
8. Enter the GPRS APN for your service provider, then tap **Next**.
9. Enter details for the following fields if they are required by your service provider:
 - **User name:** - your user name for the network.
 - **Password:** - your password.
 - **Domain:** - domain name.
10. If you need to specify extra settings, tap the **Advanced...** button and enter the following information:
 - On the **TCP/IP** tab, tap the **Use server-assigned IP address** radio button to automatically configure the IP address. Otherwise, tap the **Use specific IP address** radio button and manually enter the IP address.
 - Tick the **Use software compression** checkbox if required.
 - Tick the **Use IP header compression** checkbox if required.
 - On the **Servers** tab, tap the **Use server-assigned addresses** radio button to automatically configure the server address.

Connectivity

Otherwise, tap the **Use specific server address** radio button to manually enter the server address information in the **DNS:**, **Alt DNS:**, **WINS:**, and **Alt WINS:** fields. Tap **ok**.

11. Tap **Finish**.

Setting up a dial-up connection



NOTE: Before setting up a dial-up connection, you will need to obtain the required settings from your service provider.

To set up a dial-up connection:

1. From the **Today** screen, tap **Start > Settings**.
2. Tap the **Connections** tab.
3. Tap **Connections**.
4. On the **Tasks** tab, tap **Add a new modem connection** for the required group.
5. Enter a name for the connection.
6. In the **Select a modem:** field, select **Cellular Line**.
7. Tap **Next**.
8. Enter the phone number used to dial the network, then tap **Next**.
9. Enter the required information. Refer to **Setting up a GPRS connection** for details.
10. Tap **Finish**.

Connectivity

Setting up a VPN connection



IMPORTANT: Please ensure that you have set up a GPRS connection before attempting to set up a VPN connection. The VPN connection uses the GPRS connection to connect to a network, such as a corporate network.



NOTE: Before setting up a VPN connection, you will need to obtain the required settings.

To set up a VPN connection:

1. From the **Today** screen, tap **Start > Settings**.
2. Tap the **Connections** tab.
3. Tap **Connections**.
4. On the **Tasks** tab, tap **Add a new VPN server connection** in the **My Work Network** section.
5. Enter the following information:
 - **Name:** - name for the connection.
 - **Host name/ IP:** - name of the VPN server.
 - **VPN type:** - select the type of VPN.
6. Tap **Next**.
7. If you selected **IPSec/L2TP** in the **VPN type:** field, select the type of authentication. Enter the pre-shared key if required. Tap **Next**.
8. Enter the required information. Refer to **Setting up a GPRS connection** for details.
9. Tap **Finish**.

Connectivity

Setting up a proxy connection

Depending on your service provider's configuration, you may need to add a proxy connection to allow your Toshiba phone to access the Internet or WAP services.

Your service provider will be able to advise whether you need to create a proxy connection.



NOTE: Before setting up a proxy connection, you will need to obtain the required settings from your service provider.

To set up a proxy connection:

1. From the **Today** screen, tap **Start > Settings**.
2. Tap the **Connections** tab.
3. Tap **Connections**.
4. On the **Tasks** tab, tap **Set up my proxy server** for the required group.
5. In the **Proxy Settings** tab, tick the **This network connects to the Internet** and **This network uses a proxy server to connect to the Internet** checkboxes.
6. In the **Proxy server:** field, enter the name of the proxy server.
7. If you need to specify extra settings, tap the **Advanced...** button and edit the settings as required.

Tap **ok** when you have finished.

8. Tap **ok**.

Connecting to intranet URLs

Some URLs for corporate intranet pages may use '.' characters, for example:
intranet.companyname.com. To view these pages, you need to set up a URL exception.

To set up a URL exception:

1. From the **Today** screen, tap **Start > Settings**.
2. Tap the **Connections** tab.
3. Tap **Connections**.
4. Tap the **Advanced** tab.
5. Tap the **Exceptions...** button.
6. Tap **Add new URL...**
7. In the **Work URL:** field, enter the required URL.
8. Tap **ok** three times.

Connectivity

Advanced settings

Advanced settings allow you to specify the particular connection to be used for different connection types.

You can also specify dialing rules.

To access advanced settings:

1. From the **Today** screen, tap **Start > Settings**.
2. Tap the **Connections** tab.
3. Tap **Connections**.
4. Tap the **Advanced** tab.

CSD Line

CSD Line enables you to select the line settings for CSD connections.



NOTE: The default setting on your Toshiba phone is set for optimal use. Do not change the CSD line settings unless you are having trouble using the CSD connection.

To edit CSD line settings:

1. From the **Today** screen, tap **Start > Settings**.
2. Tap the **Connections** tab.
3. Tap **CSD Line**.
4. Select the data rate and type of connection, then tap **ok**.

Domain Enroll

Domain Enroll enables you to enroll your Toshiba phone as a domain member. You can then connect your phone securely to a network, e.g. your work network.

To use **Domain Enroll**:

1. From the **Today** screen, tap **Start > Settings**.
2. Tap the **Connections** tab.
3. Tap **Domain Enroll**.
4. Tap **Enroll**.
5. A notification screen is displayed. Tap **Next**.
6. Enter your e-mail address for the domain server to which you are enrolling.
7. Tap **Next**.
8. If required, enter the name of the domain server.
9. Enter the enrollment password, then tap **Next**.
10. Restart your Toshiba phone if requested.

Connectivity

Internet Sharing

Internet Sharing enables you to use your Toshiba phone as a modem for a PC.

 **NOTE:** This functionality is only available if it is supported on your SIM card. Please contact your service provider for further information.

To connect to the Internet using **Internet Sharing**:

1. Connect your Toshiba phone to a PC using the USB cable or Bluetooth.
2. From the **Today** screen, tap **Start > Programs**.
3. Tap **Internet Sharing**.
4. In the **PC Connection:** field, select the type of connection used for connecting the phone and PC.
5. In the **Network Connection:** field, select the connection to use to connect to the Internet.
6. Tap **Connect**. Once the connection is enabled, you can access the Internet on a PC using your Toshiba phone as a modem.
7. When you have finished using the Internet, tap **Disconnect** on your phone.

Network Mode

Network Mode enables you to set the radio system used by your Toshiba phone, and the frequency band.

 **NOTE:** Changing the **Network Mode** settings may limit the ability of your Toshiba phone to connect to the wireless network, and may result in signal failure.

To change the **Network Mode** settings:

1. From the **Today** screen, tap **Start > Settings**.
2. Tap the **Connections** tab.
3. Tap **Network Mode**.
4. Select a network mode from one of the following:
 - **Auto** - selects network mode automatically.
 - **GSM** - selects 2G/2.5G network mode.
 - **UMTS** - selects 3G network mode.
5. Select a GSM/UMTS frequency band if required.
6. Tap **ok**.

Connectivity

USB to PC

USB to PC enables you to change the type of USB connection used between your Toshiba phone and PC.

To change the **USB to PC** setting:

1. From the **Today** screen, tap **Start > Settings**.
2. Tap the **Connections** tab.
3. Tap **USB to PC**.
4. Tap the required mode, then tap **ok**.

Wi-Fi

Your Toshiba phone supports Wi-Fi (Wireless LAN), which is IEEE 802.11b/g compliant.

Connecting to a Wi-Fi network

Before connecting to a Wi-Fi network, ensure that Wi-Fi on your Toshiba phone is on.

To connect to a Wi-Fi network:

1. From the **Today** screen, tap **Start > Settings**.
2. Tap the **Connections** tab.
3. Tap **Wi-Fi**. Available networks will be displayed on the **Wireless** tab.



TIP: You can filter the networks displayed by selecting **Only access points** or **Only computer-to-computer** in the **Networks to access:** field.

4. Tap the required network, or add a new network by tapping **Menu > Add New...** and entering the details of the network.

Connectivity

Configuring a network adapter

To configure a network adaptor:

1. From the **Today** screen, tap **Start > Settings**.
2. Tap the **Connections** tab.
3. Tap **Wi-Fi**.
4. Tap the **Network Adapters** tab.
5. Tap the adaptor to configure.
6. On the **IP Address** tab, tick the **Use server-assigned IP address** or **Use specific IP address** radio button.
7. On the **Name Servers** tab, specify **DNS:**, **Alt DNS:**, **WINS:** and **Alt WINS:**.
8. Tap **ok**.

Wi-Fi security

It is possible for an outside party to easily gain unlawful access to your Toshiba phone via Wi-Fi if the security function is not used.

Without this security, your Toshiba phone carries the risk of unlawful access, wiretapping, and loss or destruction of data.

You should set up your Toshiba phone to use the authentication and encryption features in order to prevent such access.

When using a public Wi-Fi access point, your Toshiba phone should be protected from unlawful access by the Windows firewall of Windows Security Centre and the anti-virus software within the firewall feature.

Settings

Volume control

You can access the phone sound volume and ringer/call volume settings by tapping the ringer icon on the title bar.

Volume control has the following settings:

- Phone sound volume - 6 levels.
- Ringer/call volume - 6 levels.
- Both phone volume and ringer/call volume can be set to **On**, **Vibrate** or **Off**.

You can also change the volume settings by pressing the **Volume keys**.

Reassigning button functions

There are already applications assigned to the hardware buttons. However, you may want to change some assignments to applications that you use more frequently.

To reassign a button:

1. From the **Today** screen, tap **Start > Settings**.
2. On the **Personal** tab, tap **Buttons**. On the **Program Buttons** tab, a list of buttons and their assigned application is displayed.



TIP: An icon represents the original function of a button. This helps you to identify a button and restore its default.

3. Tap a button to reassign.
4. In the **2. Assign a program:** field, select an application for this button.
5. Tap **ok**.

Input method settings

For details of changing the input method settings, refer to the **Text input** section.

Settings

Security settings

It is advisable to apply certain security features in case your Toshiba phone is lost or stolen.

You can apply the following security to prevent unauthorised use:

- Device lock - using a password, this feature prevents unauthorised use of your Toshiba phone.
When this feature is activated, you will be prompted for a password when you switch on your Toshiba phone, and when you leave it idle for a set period of time.

When this feature is activated, you will need to enter the password before you can use your Toshiba phone.

- Phone lock - using a personal identification number (PIN), this feature prevents unauthorised use of your SIM card in any phone. When this feature is activated, you will be prompted for your PIN when you switch on your Toshiba phone. You cannot use the SIM card until the PIN is entered correctly.

 **NOTE:** Emergency calls can be placed at any time, without requiring deactivation of any security feature first.

Enabling device lock

To enable the device lock:

1. From the **Today** screen, tap **Start > Settings**.
2. On the **Personal** tab, tap **Lock**.
3. On the **Password** tab, tick the **Prompt if device unused for** checkbox, and select how long your device can be left idle before a password is required.
4. Select a password type.
5. Enter and confirm a password.

 **NOTE:** Make a note of the password.

6. Enter a hint on the **Hint** tab if required.
7. Tap **ok**.
8. Tap **Yes** to confirm the changes.

 **IMPORTANT:** If you forget your password, you will need to reinitialise your phone. Refer to **Reinitialising your Toshiba phone in Care and maintenance** for details. This will delete any applications that you have installed. You will also lose all personal data such as music, ringtones and pictures, and will need to restore the data from a backup file.

Settings

Changing device lock password

To change the device lock password:

1. From the **Today** screen, tap **Start > Settings**.
2. On the **Personal** tab, tap **Lock**.
3. Enter your current password, then tap **Unlock**.
4. Enter and confirm a new password.
5. Tap **ok**.
6. Tap **Yes** to confirm the changes.

Disabling device lock

To disable the device lock:

1. From the **Today** screen, tap **Start > Settings**.
2. On the **Personal** tab, tap **Lock**.
3. Enter your current password, then tap **Unlock**.
4. On the **Password** tab, untick the **Prompt if device unused for** checkbox.
5. Tap **ok**.
6. Tap **Yes** to confirm the change.

Enabling phone lock

To enable the phone lock:

1. From the **Today** screen, tap **Start > Settings**.
2. On the **Personal** tab, tap **Phone**.
3. Tap the **Security** tab.

4. Tick the **Require PIN when phone is used** checkbox.
5. Tap **ok**.

Changing SIM PIN



NOTE: Before you start, you will need to know the SIM PIN. This is provided with your SIM card.

To change the SIM PIN:

1. From the **Today** screen, tap **Start > Settings**.
2. On the **Personal** tab, tap **Phone**.
3. Tap the **Security** tab.
4. Tap **Change PIN**.
5. Enter the old SIM PIN, then tap **Enter**.



WARNING: If you enter the incorrect PIN for your SIM card three consecutive times, you will need to contact your service provider to obtain the PUK. Do not attempt to guess the PUK as your SIM card will be rendered permanently inoperative following ten consecutive unsuccessful attempts.

6. Enter the new SIM PIN, then tap **Enter**.
7. Confirm the new SIM PIN, then tap **Enter**.



NOTE: Make a note of the new SIM PIN.

Settings

Disabling phone lock

To disable the phone lock:

1. From the **Today** screen, tap **Start** > **Settings**.
2. On the **Personal** tab, tap **Phone**.
3. Tap the **Security** tab.
4. Untick the **Require PIN when phone is used** checkbox.
5. Enter the SIM PIN, then tap **Enter**.

 **WARNING:** If you enter the incorrect PIN for your SIM card three consecutive times, you will need to contact your service provider to obtain the PUK. Do not attempt to guess the PUK as your SIM card will be rendered permanently inoperative following ten consecutive unsuccessful attempts.

6. Tap **ok**.

Changing PIN2

 **NOTE:** You can only change PIN2 if this functionality is enabled on your SIM card.

To change PIN2:

1. From the **Today** screen, tap **Start** > **Settings**.
2. On the **Personal** tab, tap **Phone**.
3. Tap the **Security** tab.

4. Tap **Change PIN2**.
5. Enter the old PIN2, then tap **Enter**.

 **NOTE:** If you enter the incorrect PIN2 for your SIM card three consecutive times, you will need to contact your service provider to obtain the PUK2.

6. Enter the new PIN2, then tap **Enter**.
7. Confirm the new PIN2, then tap **Enter**.

 **NOTE:** Make a note of the new PIN2.

Customising the Start menu

You can select the applications to be displayed in the **Start** menu. Applications that are not selected can be accessed by tapping **Start** > **Programs** from the **Today** screen.

To customise the **Start** menu:

1. From the **Today** screen, tap **Start** > **Settings**.
2. On the **Personal** tab, tap **Menus**.
3. Tick the checkboxes for the required applications, then tap **ok**.

 **NOTE:** Only seven items can be selected for the **Start** menu.

Settings

Owner Information

Owner Information enables you to enter contact information so that your phone can be easily returned if it is lost.

To enter or edit **Owner Information**:

1. From the **Today** screen, tap **Start > Settings**.
2. On the **Personal** tab, tap **Owner Information**.
3. Enter your contact information on the **Identification** tab. You can also make any important notes on the **Notes** tab. On the **Options** tab, you can select whether to display information from the **Identification** and **Notes** tabs when your Toshiba phone is switched on.



TIP: You can also set owner information by tapping the appropriate section on the **Today** screen.

4. Tap **ok** when you have finished.

Phone settings

Setting ring tones

To set a ring tone:

1. From the **Today** screen, tap **Start > Settings**.
2. On the **Personal** tab, tap **Phone**.
3. On the **Phone** tab, select the following:
 - In the **Ring type:** field, select the required type of tone. This can be ringing, vibration, a combination of ringing and vibration, or none.
 - In the **Ring tone:** field, select the required tone.



TIP: Tap the Play icon to listen to a sample of the selected ring tone.

4. Tap **ok**.



TIP: You can also set the ring tone from the **Sounds & Notifications** settings.



TIP: You can also use custom sounds as ring tones. You can copy the files to your phone from your PC using **ActiveSync**, or download them from the Internet.

Settings

Setting keypad tones

1. From the **Today** screen, tap **Start > Settings**.
2. On the **Personal** tab, tap **Phone**.
3. On the **Phone** tab, select the required type of keypad tones in the **Keypad:** field. To have no keypad tones, select **Off**.

Call Barring

Call Barring enables you to block certain categories of incoming and outgoing calls (for example, international calls).



NOTE: **Call Barring** is only available if it is supported by your service provider.



NOTE: Before setting up **Call Barring**, you will need to obtain your call barring password from your service provider.

To set up **Call Barring**:

1. From the **Today** screen, tap **Start > Settings**.
2. On the **Personal** tab, tap **Phone**.
3. Tap the **Services** tab.
4. In the list of services, tap **Call Barring**, then tap the **Get Settings...** button. The settings will then be read from the network.
5. When the current settings are displayed, select the settings required for blocking incoming and

outgoing calls.

6. Tap **ok**.
7. Enter the call barring password, then tap **ok**. The settings are sent to the network.

Caller ID

Caller ID allows selected call recipients to view your name and phone number information on their phone when you call them.

To configure **Caller ID**:

1. From the **Today** screen, tap **Start > Settings**.
2. On the **Personal** tab, tap **Phone**.
3. Tap the **Services** tab.
4. In the list of services, tap **Caller ID**, then tap the **Get Settings...** button. The settings will then be read from the network.
5. In the **Provide my caller ID to:** field, select one of the following:
 - **Everyone** - your information will be displayed to everyone that you call.
 - **No one** - your information will be hidden from everyone that you call.
 - **Only to contacts** - your information will only be displayed when you call a number stored in **Contacts**.
6. Tap **ok**. The settings are sent to the network.

Settings

Call Forwarding

Call Forwarding enables you to forward incoming calls to another number.



NOTE: Call Forwarding is only available if it is supported by your service provider.

To set up **Call Forwarding**:

1. From the **Today** screen, tap **Start > Settings**.
2. On the **Personal** tab, tap **Phone**.
3. Tap the **Services** tab.
4. In the list of services, tap **Call Forwarding**, then tap the **Get Settings...** button. The settings will then be read from the network.
5. When the current settings are displayed, select the conditions during which you would like to forward incoming calls. Enter the phone number(s) for forwarded calls.



TIP: If you have set up voice mail, you can select **Voice mail** as the phone number for forwarded calls. For details of setting up voice mail, refer to **Setting up voice mail**.

6. Tap **ok**. The settings are sent to the network.

Call Waiting

Call Waiting notifies you of incoming calls when you are already in a call. You will then have the option to answer or ignore the second call.



NOTE: Call Waiting is only available if it is supported by your service provider.

To enable **Call Waiting**:

1. From the **Today** screen, tap **Start > Settings**.
2. On the **Personal** tab, tap **Phone**.
3. Tap the **Services** tab.
4. In the list of services, tap **Call Waiting**, then tap the **Get Settings...** button. The settings will then be read from the network.
5. When the current settings are displayed, select whether or not you wish to be notified of waiting calls.
6. Tap **ok**. The settings are sent to the network.

Viewing and editing text messages service centre

To view and edit the text messages service centre:

1. From the **Today** screen, tap **Start > Settings**.
2. On the **Personal** tab, tap **Phone**.
3. Tap the **Services** tab.

Settings

4. In the list of services, tap **Voice Mail and Text Messages**, then tap the **Get Settings...** button. The settings will then be read from the network.
5. Edit the number in the **Text messages service center:** field if required. This number can be obtained from your service provider.
6. Tap **ok**. The settings are sent to the network.

Setting up voice mail

To set up voice mail:

1. From the **Today** screen, tap **Start > Settings**.
2. On the **Personal** tab, tap **Phone**.
3. Tap the **Services** tab.
4. In the list of services, tap **Voice Mail and Text Messages**, then tap the **Get Settings...** button. The settings will then be read from the network.
5. Enter your voice mail number in the **Voice Mail:** field. This can be obtained from your service provider.
6. Tap **ok**. The settings are sent to the network.

Fixed Dialing

Fixed Dialing restricts the numbers that you can call from your Toshiba phone. When **Fixed Dialing** is activated, you can only call predefined numbers or area codes. These numbers are stored in a list that you can set up and edit using your Toshiba phone.



NOTE: **Fixed Dialing** is only available if it is supported by your service provider.



NOTE: Before setting up **Fixed Dialing**, you will need to obtain PIN2 from your service provider.

To set up **Fixed Dialing**:

1. From the **Today** screen, tap **Start > Settings**.
2. On the **Personal** tab, tap **Phone**.
3. Tap the **Services** tab.
4. In the list of services, tap **Fixed Dialing**, then tap the **Get Settings...** button. The settings will then be read from the network.
5. Tick the **Enable fixed dialing** checkbox.
6. Tap **Menu > Add**.
7. In the **Add or change the number pattern:** field, enter the phone number or area code you want to be able to call.
8. Tap **Done**.

Settings

9. If required, add more numbers, then tap **Done**.
10. Enter PIN2, then tap **Done**. The settings are sent to the network.

Network settings

You can select whether your Toshiba phone will automatically search and select a network to connect to, or whether you will be prompted to select one manually.

You can set up and update a list of **Preferred networks** that your phone will attempt to connect to if your current network becomes unavailable. This setting will also apply if you roam out of the service area of your current network.

You can also search for new networks and select a network to connect to.

For details of setting the network mode, refer to **Network Mode** in **Connectivity**.

Setting the network selection type

To set the network selection type:

1. From the **Today** screen, tap **Start > Settings**.
2. On the **Personal** tab, tap **Phone**.
3. Tap the **Network** tab.

4. In the **Network selection** field, select **Automatic** or **Manual** as required.
5. If you select **Automatic**, your Toshiba phone will register to the default network. This network is defined by your SIM card.
6. If you select **Manual**, you will need to wait for the phone to search for all available networks. When the list of networks is displayed, tap the required network, then tap **OK**. Your Toshiba phone will register to the selected network.
7. Tap **ok**.

The default setting is **Automatic**.

If you select **Manual**, and your current network becomes unavailable, you will need to wait for the phone to search for all available networks. You can then select one to connect to.

Preferred networks

If you have selected the **Automatic** network selection type, following any failure in connection to your home network, your Toshiba phone will attempt to connect to the first network in the list of **Preferred networks**. If this fails, the phone will attempt to connect to the next network in the list, and so on.

To set up or update the list of **Preferred networks**:

1. From the **Today** screen, tap **Start > Settings**.

Settings

2. On the **Personal** tab, tap **Phone**.
3. Tap the **Network** tab.
4. Tap **Set Networks**. The settings will then be read from the network.
5. Add new networks or reorder the list as required. You can also remove networks from the list by unticking the checkbox beside the network name.
6. Tap **ok** when you have finished. The settings are sent to the network.

Connecting to a network

To connect to a network:

1. From the **Today** screen, tap **Start > Settings**.
2. On the **Personal** tab, tap **Phone**.
3. Tap the **Network** tab.
4. Tap **Find Network**. You will need to wait for the phone to search for all available networks. When the list of networks is displayed, tap the required network, then tap **OK**. Your Toshiba phone will register to the selected network.

Video Phone settings

Call Barring

Call Barring on the **Video Phone** tab enables you to block certain categories of incoming and outgoing video calls.



NOTE: Call Barring is only available if it is supported by your service provider.



NOTE: Before setting up **Call Barring**, you will need to obtain your call barring password from your service provider.

To set up **Call Barring** for video calls:

1. From the **Today** screen, tap **Start > Settings**.
2. On the **Personal** tab, tap **Phone**.
3. Tap the **Video Phone** tab.
4. In the list of services, tap **Call Barring**, then tap the **Get Settings...** button. The settings will then be read from the network.
5. When the current settings are displayed, select the settings required for blocking incoming and outgoing video calls.
6. Tap **ok**.
7. Enter the call barring password, then tap **ok**. The settings are sent to the network.

Settings

Call Forwarding

Call Forwarding on the **Video Phone** tab enables you to forward incoming video calls to another number.



NOTE: **Call Forwarding** is only available if it is supported by your service provider.

To set up **Call Forwarding** for video calls:

1. From the **Today** screen, tap **Start > Settings**.
2. On the **Personal** tab, tap **Phone**.
3. Tap the **Video Phone** tab.
4. In the list of services, tap **Call Forwarding**, then tap the **Get Settings...** button. The settings will then be read from the network.
5. When the current settings are displayed, select the conditions during which you would like to forward incoming video calls. Enter the phone number(s) for forwarded calls.
6. Tap **ok**. The settings are sent to the network.

Call Waiting

Call Waiting on the **Video Phone** tab notifies you of incoming video calls when you are already in a call. You will then have the option to answer or ignore the second call.



NOTE: **Call Waiting** is only available if it is supported by your service provider.

To enable **Call Waiting** for video calls:

1. From the **Today** screen, tap **Start > Settings**.
2. On the **Personal** tab, tap **Phone**.
3. Tap the **Video Phone** tab.
4. In the list of services, tap **Call Waiting**, then tap the **Get Settings...** button. The settings will then be read from the network.
5. When the current settings are displayed, select whether or not you wish to be notified of waiting video calls.
6. Tap **ok**. The settings are sent to the network.

Settings

Sounds & Notifications

You can set a different sound for different events. The sound can be set to something different for each type of event.



TIP: You can also use custom sounds. You can copy the files to your phone from your PC using **ActiveSync**, or download them from the Internet.

Setting the sound and notification for an event

To set the sound and notification for an event:

1. From the **Today** screen, tap **Start > Settings**.
2. On the **Personal** tab, tap **Sounds & Notifications**.
3. On the **Sounds** tab, select the required settings from the following:
 - Tick the **Events** checkbox to enable sounds for events such as warnings.
 - Tick the **Programs** checkbox to enable sounds for applications.
 - Select whether to enable sounds for **Screen taps** or pressing **Hardware buttons**. You can also specify the level of the sounds.

4. On the **Notifications** tab, select the specific sound required for each event, and the way in which you want to be notified of the event. Available items are dependent on the event selected.



TIP: Tap the Play icon to listen to a sample of the selected sound.

5. Tap **ok** when you have finished.



TIP: Disabling sounds and flashing lights for events will help to conserve battery power.

Settings

Customising the Today screen

You can customise the **Today** screen using:

- A theme. This is a pre-packaged file that includes a picture, colour scheme and new layout. It will be a *.hme or *.cab file type.
- A picture file. This will only replace the background of the **Today** screen.



TIP: You can copy the theme and picture files to your phone from your PC using **ActiveSync**, or download them from the Internet.

Setting the theme for the Today screen

To set the theme for the **Today** screen:

1. From the **Today** screen, tap **Start > Settings**.
2. On the **Personal** tab, tap **Today**.
3. On the **Appearance** tab, tap the required theme for the **Today** screen.
4. Tap **ok**.

Setting a picture as the Today screen background

To set a picture as the **Today** screen background:

1. From the **Today** screen, tap **Start > Settings**.
2. On the **Personal** tab, tap **Today**.
3. On the **Appearance** tab, tick the **Use this picture as the background** checkbox.
4. Tap the **Browse** button to view the picture files.
5. Tap the file name of the selected picture.
6. Tap **ok**.

Setting information displayed on the Today screen

To set the information displayed on the **Today** screen:

1. From the **Today** screen, tap **Start > Settings**.
2. On the **Personal** tab, tap **Today**.
3. Tap the **Items** tab.
4. Tick the checkboxes for the items that you want to display on the **Today** screen. You can also set the order of the items on the screen, and set extra options for some items such as **Tasks**.
5. Tap **ok** when you have finished.

Settings

About

The **About** setting enables you to view technical information about your Toshiba phone, including the operating system and memory of the phone. This information is useful when installing new applications on your Toshiba phone.

You can also change the name of your Toshiba phone as it is displayed to other devices (for example, when using Bluetooth).

Viewing phone information

To view the phone information:

1. From the **Today** screen, tap **Start > Settings**.
2. Tap the **System** tab.
3. Tap **About**. The phone information is displayed on the **Version** tab.
4. Tap **ok** when you have finished.

Changing device name

To change the device name:

1. From the **Today** screen, tap **Start > Settings**.
2. Tap the **System** tab.
3. Tap **About**.
4. Tap the **Device ID** tab.

5. Enter a new name for your Toshiba phone in the **Device name:** field. You can also add a description if required.



NOTE: The device name should start with a letter and contain only a combination of the letters A to Z, numbers 0 to 9, and underscore and hyphen characters.

6. Tap **ok**.



NOTE: The device name is used to identify your Toshiba phone in the following situations:

- Synchronising with PC.
- Connecting to a network.
- Restoring information from a back up.
- Bluetooth pairing.
- Data exchange via beaming.

Settings

Backlight settings

You can adjust the brightness of the backlight, and set the backlight to dim after a specific amount of time has elapsed.

You can configure settings to prolong battery power.

To change the backlight settings:

1. From the **Today** screen, tap **Start > Settings**.
2. Tap the **System** tab.
3. Tap **Backlight**.
4. On the **Brightness** tab, you can adjust the brightness of the screen when using battery or external power.
5. On the **On battery power** tab, you can select when to turn off the backlight when using battery power, and specify the time delay.
6. On the **On external power** tab, you can select when to turn off the backlight when using external power, and specify the time delay.
7. Tap **ok** when you have finished.



NOTE: The higher the brightness, and the longer the backlight remains on, the more power will be used.

Certificates

To view certificate details:

1. From the **Today** screen, tap **Start > Settings**.
2. Tap the **System** tab.
3. Tap **Certificates**. On each tab, the certificate names, along with their issuing authority and expiry date, are displayed. Tap a certificate to view its details.

Settings

Clock & Alarms

Setting the date and time

To set the date and time:

1. From the **Today** screen, tap **Start > Settings**.
2. Tap the **System** tab.
3. Tap **Clock & Alarms**.
4. On the **Time** tab, in the **Home** section, you can set the time zone, current time and date for when you are at home.
5. In the **Visiting** section, you can set the time zone, current time and date when visiting another country or time zone.
6. Tap **ok** when you have finished.



NOTE: These settings are only lost if you reset your Toshiba phone. Your settings are saved if you power off the phone, or if the battery is fully discharged.

Setting an alarm

To set an alarm:

1. From the **Today** screen, tap **Start > Settings**.
2. Tap the **System** tab.
3. Tap **Clock & Alarms**.
4. Tap the **Alarms** tab.

5. To enter a description of the alarm, tap **< Description >**, and enter a description using the keyboard or another input method.
6. Tap the letters below the **< Description >** field to select the days when the alarm is required.
7. Tap the time display on the right to set a time for this alarm.
8. Tap the bell icon to select the types of alarm to use.
9. Tap **ok** twice.

Cancelling an alarm

To cancel an alarm:

1. From the **Today** screen, tap **Start > Settings**.
2. Tap the **System** tab.
3. Tap **Clock & Alarms**.
4. Tap the **Alarms** tab.
5. Untick the checkbox beside the alarm you want to cancel.
6. Tap **ok**.

Settings

Setting the clock display

To set the clock to be displayed on the title bar at all times:

1. From the **Today** screen, tap **Start > Settings**.
2. Tap the **System** tab.
3. Tap **Clock & Alarms**.
4. Tap the **More** tab.
5. Tick the **Display the clock on the title bar in all programs** checkbox.
6. Tap **ok**.

Customer Feedback

Customer Feedback sends anonymous information to Microsoft for use in helping improve Windows Mobile software.



NOTE: You will not incur any data charges to send this information.

To enable/disable **Customer Feedback**:

1. From the **Today** screen, tap **Start > Settings**.
2. Tap the **System** tab.
3. Tap **Customer Feedback**.
4. Tap **Send Feedback** or **Don't Send Feedback** as required.
5. Tap **ok**.

Encryption

This feature allows you to secure sensitive information on your storage card. The data will only be accessible when the card is installed in your Toshiba phone. If the card is lost or stolen, the information remains secure. The contents of the storage card cannot be accessed by anyone else because they are encrypted.

To encrypt the contents of your storage card:

1. From the **Today** screen, tap **Start > Settings**.
2. Tap the **System** tab.
3. Tap **Encryption**.
4. Tick the **Encrypt files when placed on a storage card** checkbox.
5. Tap **ok**.



WARNING: Anyone in possession of the encryption key can decrypt and access information stored on the storage card.

Settings

Error Reporting

Error Reporting sends data from your Toshiba phone to Microsoft technical support groups. The data is used to diagnose program errors for devices running Windows Mobile software.

If a program error occurs, **Error Reporting** starts automatically. The information Microsoft receives is used by programming groups at Microsoft. The data is used for quality control and will not be used for tracking individual users, installations or for any marketing purpose.



NOTE: You will not incur any data charges to send this information.

To enable/disable **Error Reporting**:

1. From the **Today** screen, tap **Start > Settings**.
2. Tap the **System** tab.
3. Tap **Error Reporting**.
4. Tap **Enable error reporting** or **Disable error reporting** as required.
5. Tap **ok**.

External GPS

To set up **External GPS**:

1. From the **Today** screen, tap **Start > Settings**.
2. Tap the **System** tab.
3. Tap **External GPS**.
4. On the **Programs** tab, select the port that your Toshiba phone will use to obtain GPS data.
5. On the **Hardware** tab, select the hardware port to which your GPS device is connected. You can also set the baud rate.
6. On the **Access** tab, tick the **Manage GPS automatically (recommended)** checkbox if required. You are strongly advised to use this feature as it will enable Windows Mobile to manage access to your GPS device, and allows multiple programs to obtain GPS data simultaneously.
7. Tap **ok** when you have finished.

Settings

Headset Volume Limiter

Headset Volume Limiter enables you to set a maximum headset volume to suit your needs.

To set the maximum headset volume:

1. From the **Today** screen, tap **Start > Settings**.
2. Tap the **System** tab.
3. Tap **Headset Volume Limiter**.
4. Slide the marker to change the maximum volume. The dB level for the current setting is displayed. To reset the maximum volume to the default value, tap **Reset to Default**.
5. Tap **ok**.

Memory management settings

To ensure optimum performance of your Toshiba phone, it is necessary to maintain sufficient memory.

Checking memory

To check the memory available on your Toshiba phone:

1. From the **Today** screen, tap **Start > Settings**.
2. Tap the **System** tab.
3. Tap **Memory**.
4. On the **Main** tab, you can view the details of **Storage** and **Program** memory.
5. On the **Storage Card** tab, you can view the memory available on the storage card.
6. Tap **Find large files using storage memory** to search for specific files.

Managed Programs

Managed Programs lists applications that have been installed remotely by your company system administrator. You can view details of these applications.

Settings

Power settings

The **Power** settings enable you to check the battery status and configure settings to prolong battery power.

To view and change **Power** settings:

1. From the **Today** screen, tap **Start > Settings**.
2. Tap the **System** tab.
3. Tap **Power**.
4. On the **Battery** tab, the remaining battery power is displayed.
5. On the **Advanced** tab, you can select when to turn off the phone when using battery or external power, and specify the time delay.
6. Tap **ok** when you have finished.

Regional Settings

Regional Settings enables you to specify the styles in which numbers, currency, time and date are displayed.

To change **Regional Settings**:

1. From the **Today** screen, tap **Start > Settings**.
2. Tap the **System** tab.
3. Tap **Regional Settings**.
4. On the **Region** tab, select your region in the drop-down list. Changing this setting automatically updates the styles in which numbers, currency, time and date are displayed to the defaults for the selected region.
5. Change specific items on the other tabs if required.
6. Tap **ok** when you have finished.

Settings

Remove Programs

Remove Programs enables you to delete applications that you have installed.



NOTE: Programs that were pre-installed on your Toshiba phone cannot be removed in this way.

To remove a program:

1. From the **Today** screen, tap **Start > Settings**.
2. Tap the **System** tab.
3. Tap **Remove Programs**.
4. Tap the application to remove, then tap **Remove**.
5. Tap **Yes** to confirm the deletion.
6. Tap **ok** when you have finished removing programs.

Screen settings

To adjust screen settings:

1. From the **Today** screen, tap **Start > Settings**.
2. Tap the **System** tab.
3. Tap **Screen**.
4. On the **General** tab, you can set up the screen orientation and alignment.
5. On the **ClearType** tab, you can enable ClearType, which smooths the edge of screen fonts.
6. On the **Text Size** tab, you can slide the marker to adjust the text size. An example of the selected text size is displayed.
7. Tap **ok** when you have finished.

Settings

Spb Mobile Shell for Toshiba

Spb Mobile Shell for Toshiba provides customisation settings for the **TOSHIBA User Interface**.

You can customise items such as the **Now Screen**, **Today** plug-in, softkeys, tabs and weather updates.

To access **Spb Mobile Shell for Toshiba** settings:

1. From the **Today** screen, tap **Start > Settings**.
2. Tap the **System** tab.
3. Tap **Spb Mobile Shell for Toshiba**.

Customising the TOSHIBA User Interface

On the **Now Screen** tab, tick the **Show the Now Screen when device wakes up** checkbox to display the **Now Screen** each time your Toshiba phone wakes up from standby mode.

Tap the **Configure...** button to set the alarm and calendar display settings for the **Now Screen**. If you select **Auto** in the display settings, the displayed item will be automatically adjusted for the best fit and information view in the **Now Screen**.

On the **Today** tab, tick the **Auto-hide the tab content** checkbox to see only the tab headers in the **Today** plug-in. You can tap the header icon to view

the hidden tab content.

Tick the **Backlight indicator in the Home Tab** checkbox to show the backlight indicator icon in the **Home Tab** for quick access.

You can also set the items to be available on the left and right softkeys.



NOTE: The **Today** plug-in is disabled by default. To enable it:

1. From the **Today** screen, tap **Start > Settings**.
2. On the **Personal** tab, tap **Today**.
3. Tap the **Items** tab.
4. Tick the checkboxes for the **TOSHIBA User Interface** items that you want to display on the **Today** screen.
5. Tap **ok** when you have finished.

On the **Animation** tab, you can change the animation transitions for the main **TOSHIBA User Interface** screens.

Tick the **Enable taskbar smart gestures** checkbox to enable launching of the main **TOSHIBA User Interface** screens from any application. To use a smart gesture, tap and hold in the middle of the title bar/task bar while moving your finger down the screen. When the grey pop-up windows are displayed, drag your finger to the required screen

Settings

then release. The required screen will be displayed. Tick the **Animate transitions** checkbox to enable animated transitions for the main **TOSHIBA User Interface** screens.

You can also select the type of animation effect when shifting between panels of a main window, and when moving backwards and forwards between sub-panels of a main window,

On the **Tabs** tab, you can select items to be displayed in the **Today** plug-in. You can also change the order in which the items are displayed.

On the **Advanced** tab, you can customise the advanced options for the main **TOSHIBA User Interface** screens. You can also reset the settings for these screens to their defaults.

On the **Weather** tab, you can select the required units for temperature measurement.

You can also select and remove cities that you would like to receive weather information for, and select whether to update the weather information automatically.

System Information

System Information displays all of the system information for your Toshiba phone.

To view **System Information**:

1. From the **Today** screen, tap **Start > Settings**.
2. Tap the **System** tab.
3. Tap **System Information**.
4. Tap **ok** when you have finished.

Settings

Task Manager

Task Manager enables you to quickly switch between currently running applications.

It also enables you to end an application if it becomes unstable or the memory is low.

Switching between applications

To switch between applications using **Task Manager**:

1. From the **Today** screen, tap **Start > Settings**.
2. Tap the **System** tab.
3. Tap **Task Manager**.
4. Double-tap on the application to access.



TIP: Alternatively, tap the application, then tap **Menu > Switch To**.

Ending applications

To end an application using **Task Manager**:

1. From the **Today** screen, tap **Start > Settings**.
2. Tap the **System** tab.
3. Tap **Task Manager**.
4. Tap the application to end, then tap **End Task**.

To end all running applications, tap **Menu > End All Tasks**, then tap **Yes** to confirm the action.

5. Tap **Menu > Exit** when you have finished.

Settings

Windows Update

You can use **Windows Update** to update the Microsoft applications on your Toshiba phone.

Setting up Windows Update

To set up **Windows Update**:

1. From the **Today** screen, tap **Start > Settings**.
2. Tap the **System** tab.
3. Tap **Windows Update**.
4. Tap **Next**.
5. Select one of the following options:
 - **Automatic** - your Toshiba phone will automatically check for and download important updates.
 - **Manual** - you will need to manually download and install important and optional updates.
6. Tap **Next**.
7. Tap **Finish**.

Checking for updates



NOTE: Your Toshiba phone will need to connect to the update server to check for updates. Refer to **Internet connections** in **Connectivity** for details of setting up the connection.

To check for updates:

1. From the **Today** screen, tap **Start > Settings**.
2. Tap the **System** tab.
3. Tap **Windows Update**.
4. Tap **Check Now**.

Connections

For details of the **Connections** settings, refer to the **Connectivity** section.

Specifications

System Information	
Processor	Qualcomm® MSM7200 Processor at 400MHz
Memory	RAM : 128 MB ROM : 256 MB
Operating System	Windows Mobile® 6.1 Professional
UMTS/HSDPA/HSUPA GSM/GPRS/EDGE Frequency Range	
Within 3G (UMTS) 850	824 - 894 MHz
Within 3G (UMTS) 1900	1850 - 1990 MHz
Within 3G (UMTS) 2100	1920 - 2170 MHz
Within GSM 850	824 - 894 MHz
Within GSM 900	880 - 960 MHz
Within DCS 1800	1710 - 1880 MHz
Within PCS 1900	1850 - 1990 MHz
Continuous Talk Time	
Within 3G (UMTS) area	Approximately 240 minutes
Video call	Approximately 150 minutes
Within GSM area	Approximately 330 minutes
Continuous Standby Time	
Within 3G (UMTS) area	Approximately 315 hours
Within GSM area	Approximately 315 hours

Specifications

Maximum Output	
Within 3G (UMTS) 850	Class 3 0.25W
Within 3G (UMTS) 1900	Class 3 0.25W
Within 3G (UMTS) 2100	Class 3 0.25W
Within GSM 850	Class 4 2W
Within GSM 900	Class 4 2W
Within DCS 1800	Class 1 1W
Within PCS 1900	Class 1 1W
Dimensions (H x W x D)	Approximately 112.5 mm x 61 mm x 13.9 mm
Weight	Approximately 123 g
AC Charger	
Input voltage	100 to 240 VAC, 50/60 Hz
Charging temperature range	5 to 35 °C
Battery charging time	Approximately 160 minutes
Display	
LCD	2.8" TFT LCD with Touch screen
Resolution	240 x 320 (64k colours)

Specifications

Audio/Video codecs	
Audio	AAC, AAC+, AMR, AMRNB, AWB, M4A, MID, MMF, MP3, WMA, WAV
Video	3GP, ASF, AVI, H.263, MPEG-4, WMV
Connectivity	
Bluetooth	Bluetooth™ ver2.0 + EDR (Power Class 2) Advanced Audio Distribution Profile (A2DP) Audio/Video Remote Control Profile (AVRCP) Generic Access Profile (GAP) Hands-Free Profile (HFP) Headset Profile (HSP) Human Interface Device Profile (HID) Object Push Profile (OPP) Personal Area Networking Profile (PAN) Serial Port Profile (SPP)
Wireless LAN	IEEE 802.11b/g AES, TKIP, WEP, WPA, WPA-PSK, WPA2, WPA2-PSK
Interface	
Cable, headset and phone charging	mini USB (Client, Full Speed) / Headset/ Charger
Headset Connector	mini USB stereo headset
Expansion slot	microSD™

Troubleshooting

Problem	Possible cause	Possible solution
Cannot switch phone on	Battery out of power	Charge the battery (see page 37).
	Battery not installed correctly	Ensure that the battery is inserted correctly (see page 34).
Phone switches off automatically	Battery out of power	Charge the battery (see page 37).
Cannot charge battery	Battery not installed correctly	Ensure that the battery is inserted correctly (see page 34).
	AC charger not connected	Ensure that the AC charger is connected to the phone and to a working AC outlet.
	Connectors are dirty	Clean the connectors of the AC charger and battery.
	Battery has worn out	Replace the battery.
	Battery or AC charger is damaged	Replace the battery or charger. Contact your dealer for assistance.
Battery loses power quickly	Backlight and Power settings need to be adjusted	Adjust settings to optimise power performance (see pages 143 and 148).

Troubleshooting

Problem	Possible cause	Possible solution
Network not displayed	SIM card not installed correctly	Ensure that the SIM card is inserted correctly (see page 34).
	Contacts between SIM card and phone are dirty	Gently clean the contacts of the SIM card and phone.
	Network signal is weak	Move clear of any obstructions that may block the signal.
	SIM card is damaged	Contact your service provider to obtain a replacement SIM card.
Cannot make a voice or video call	You are outside of your network service area	Connect to a different network if this is supported by your service provider (see page 138).
	A video call can only be made in an area with UMTS/3G coverage.	Ensure that the icon indicating that you are in an area with UMTS/3G coverage is displayed.
	Phone or SIM card is locked	Unlock the phone or SIM card (see page 130).
	Call Barring is active	Deactivate Call Barring (see page 134).
Cannot answer a voice or video call	A video call can only be received in an area with UMTS/3G coverage.	Ensure that the icon indicating that you are in an area with UMTS/3G coverage is displayed.
	Call Forwarding is active	Deactivate Call Forwarding (see page 135).
	Call Barring is active	Deactivate Call Barring (see page 134).
No ringing for an incoming call	Phone is set to not ring for incoming calls	Edit the ringtone settings (see page 133).

Troubleshooting

Problem	Possible cause	Possible solution
Poor call quality	Network signal is weak	Move clear of any obstructions that may block the signal.
	Network signal is changing frequently, e.g. when travelling on a train.	Wait until signal strength is consistently high before making or answering a call.
Other party in a call cannot hear you	Phone is muted	Unmute the phone (see page 49).
Cannot send or receive text messages	Your service provider is not enabling this service	Contact your service provider to check your subscription status.
	Service centre number is not correct	Ensure that the service centre number is correct (see page 135). To obtain the number, contact your service provider.
Cannot send or receive MMS messages	Your service provider is not enabling this service	Contact your service provider to check your subscription status.
	MMS settings are missing or incorrect	Ensure that the MMS settings are correct (see page 56). To obtain the settings, contact your service provider.
Cannot access the Internet	Your service provider is not enabling this service	Contact your service provider to check your subscription status.
	Network settings are missing or incorrect	Ensure that the network settings are correct (see page 120). To obtain the settings, contact your service provider.

Troubleshooting

Problem	Possible cause	Possible solution
Storage memory is low	Too many items stored on the phone	Delete any unwanted messages, clear the Internet history, and delete any unwanted files.
Storage card is not recognised	Storage card not installed correctly	Ensure that the storage card is inserted correctly (see page 35).
	Storage card is damaged	Replace the storage card.

Purchase record

For your future reference, we recommend that you fill in your purchase details in the form below.

Serial Number*:

Dealer Name:

Purchase Date:

* The serial number is printed on the bottom of the battery compartment.

Menu tree

Start

- Today
- Office Mobile
 - Excel Mobile
 - OneNote Mobile
 - PowerPoint Mobile
 - Word Mobile
- Calendar
- Contacts
- Internet Explorer
- Messaging
 - Text Messages
 - Outlook E-mail
 - Setup E-mail
- Phone
- Help

Programs

- Games
- TOSHIBA User Interface
- ActiveSync
- A-GPS
- AutoConfig
- AutoInstall
- BlackList
- Calculator
- Camera
- Certificate Enrollment
- File Explorer
- FM Radio
- Full Screen Keyboard
- Getting Started
- Home
- Image Editor
- Image To Text
- Internet Sharing
- JBlend
- Messenger
- Notes
- Picsel Viewer
- Pictures & Videos

- Search
- SIM Toolkit
- Streaming Player
- Task Manager
- Tasks
- Windows Live
- Windows Media

Menu tree

Settings

Personal

- Buttons
- Input
- Lock
- Menus
- Owner Information
- Phone
- Sounds & Notifications
- Today

System

- About
- Backlight
- Certificates
- Clock & Alarms
- Customer Feedback
- Encryption
- Error Reporting
- External GPS
- Headset Volume Limiter
- Managed Programs
- Memory
- Power
- Regional Settings
- Remove Programs
- Screen
- Spb Mobile Shell for Toshiba
- System Information
- Task Manager
- Windows Update

Connections

- Beam
- Bluetooth
- Cell Broadcast
- Connections
- CSD Line
- Domain Enroll
- Network Mode
- USB to PC
- Wi-Fi
- Wireless Manager

End User License Agreements (EULAs)

MICROSOFT SOFTWARE LICENSE TERMS FOR WINDOWS MOBILE 6.1 SOFTWARE

These license terms are an agreement between you and TOSHIBA. Please read them. They apply to the software included on this device. The software also includes any separate media on which you received the software.

The software on this device includes software licensed by TOSHIBA from Microsoft Corporation or its affiliate.

The terms also apply to any

- updates,
- supplements,
- Internet-based services, and
- support services

for this software, unless other terms accompany those items. If so, those terms apply.

As described below, using some features also operates as your consent to the transmission of certain standard computer information for Internet-based services.

By using the software, including use on this device, you accept these terms. If you do not accept them, do not use the device or software.

Instead, contact TOSHIBA to determine its return policy for a refund or credit.

WARNING: If the software contains voice operated technologies, then operating this software requires user attention. Diverting attention away from the road while driving can possibly cause an accident or other serious consequence. Even occasional, short diversions of attention can be dangerous if your attention is diverted away from your driving task at a critical time. TOSHIBA and Microsoft make no representations, warranties or other determinations that ANY use of this software is legal, safe, or in any manner recommended or intended while driving or otherwise operating a motor vehicle.

If you comply with these license terms, you have the rights below.

1. **USE RIGHTS.** You may use the software on the device with which you acquired the software.
2. **ADDITIONAL LICENSING REQUIREMENTS AND/OR USE RIGHTS.**
 - a. **Specific Use.** TOSHIBA designed this device for a specific use. You may only use the software for that use.
 - b. **Included Microsoft Programs and Additional Required Licenses.** Except as provided below, these license terms apply to

End User License Agreements (EULAs)

all Microsoft programs included with the software. If the license terms with any of those programs give you other rights that do not expressly conflict with these license terms, you also have those rights.

i. This agreement does not grant you any rights with respect to the Windows Mobile Device Center, Microsoft ActiveSync or Microsoft Outlook 2007 Trial which are subject to the licenses accompanying those items.

c. **Speech Recognition.** If the software includes speech recognition component(s), you understand that speech recognition is an inherently statistical process and that recognition errors are inherent in the process. Neither TOSHIBA nor Microsoft or their suppliers shall be liable for any damages arising out of errors in the speech recognition process.

d. **Phone Functionality.** If the device software includes phone functionality, all or certain portions of the device software may be inoperable if you do not have and maintain a service account with a wireless telecommunication carrier ("Mobile Operator"), or if the Mobile Operator's network

is not operating or configured to operate with the device.

3. **SCOPE OF LICENSE.** The software is licensed, not sold. This agreement only gives you some rights to use the software. TOSHIBA and Microsoft reserve all other rights. Unless applicable law gives you more rights despite this limitation, you may use the software only as expressly permitted in this agreement. In doing so, you must comply with any technical limitations in the software that allow you to use it only in certain ways. You shall not:

- work around any technical limitations in the software;
- reverse engineer, decompile or disassemble the software;
- make more copies of the software than specified in this agreement;
- publish the software for others to copy;
- rent, lease or lend the software; or
- use the software for commercial software hosting services.

Except as expressly provided in this agreement, rights to access the software on this device do not give you any right to implement Microsoft patents or other Microsoft intellectual property in software or

End User License Agreements (EULAs)

devices that access this device.

You may use remote access technologies in the software such as Remote Desktop Mobile to access the software remotely from a computer or server.

You are responsible for obtaining any licenses required for use of the protocols to access other software.

4. **INTERNET-BASED SERVICES.** Microsoft provides Internet-based services with the software. Microsoft may change or cancel them at any time.

- a. **Consent for Internet-Based Services.** The software features described below connect to Microsoft or service provider computer systems over the Internet. In some cases, you will not receive a separate notice when they connect. You may switch off some of these features or not use them. For more information about these features, visit <http://go.microsoft.com/fwlink/?LinkId=81931>.

By using these features, you consent to the transmission of this information.

Microsoft does not use the information to identify or contact you.

Device Information. The following features use Internet protocols, which send to the

appropriate systems device information, such as your Internet protocol address, the type of operating system, browser and name and version of the software you are using, and the language code of the device where you installed the software. Microsoft uses this information to make the Internet-based services available to you.

- **Windows Mobile Update Feature.** The Windows Mobile Update feature provides you the ability to obtain and install software updates on your device if updates are available. You may choose not to use this feature. TOSHIBA and/or your Mobile Operator may not support this feature or an update for your device.
- **Windows Media Digital Rights Management.** Content owners use Windows Media digital rights management technology (WMDRM) to protect their intellectual property, including copyrights. This software and third party software use WMDRM to play and copy WMDRM-protected content. If the software fails to protect the content, content owners may ask Microsoft to revoke the software's ability to use WMDRM to play or copy protected content. Revocation does not

End User License Agreements (EULAs)

affect other content. When you download licenses for protected content, you agree that Microsoft may include a revocation list with the licenses. Content owners may require you to upgrade WMDRM to access their content. Microsoft software that includes WMDRM will ask for your consent prior to the upgrade. If you decline an upgrade, you will not be able to access content that requires the upgrade.

- b. **Misuse of Internet-based Services.** You shall not use these services in any way that could harm them or impair anyone else's use of them. You shall not use the services to try to gain unauthorized access to any service, data, account or network by any means.
5. **NOTICES ABOUT THE MPEG-4 VISUAL STANDARD.** The software may include MPEG-4 visual decoding technology. This technology is a format for data compression of video information. MPEG LA, L.L.C. requires this notice:
- USE OF THIS PRODUCT IN ANY MANNER THAT COMPLIES WITH THE MPEG 4 VISUAL STANDARD IS PROHIBITED, EXCEPT FOR USE DIRECTLY RELATED TO (A) DATA OR INFORMATION (i) GENERATED BY AND OBTAINED WITHOUT CHARGE FROM A

CONSUMER NOT THEREBY ENGAGED IN A BUSINESS ENTERPRISE, AND (ii) FOR PERSONAL USE ONLY; AND (B) OTHER USES SPECIFICALLY AND SEPARATELY LICENSED BY MPEG LA, L.L.C.

If you have questions about the MPEG-4 visual standard, please contact MPEG LA, L.L.C., 250 Steele Street, Suite 300, Denver, CO 80206; www.mpegla.com.

6. **DIGITAL CERTIFICATES.** The software uses digital certificates in X.509 format. These digital certificates are used for authentication.
7. **CONNECTIVITY SOFTWARE.** Your device package may include Windows Mobile Device Center or Microsoft ActiveSync software. If it is included, then you may install and use it in accordance with the license terms that are provided with it. If no license terms are provided, then you may install and use only one (1) copy of the software on a single computer.
8. **NETWORK ACCESS.** If you are using a network, such as an employer network, the network administrator may limit features or functionality on your device.
9. **PRODUCT SUPPORT.** Contact TOSHIBA for support options. Refer to the support information provided with the device.

End User License Agreements (EULAs)

10. **LINKS TO THIRD PARTY WEBSITES.** If the software provides links to third party websites, those links are provided to you only as a convenience, and the inclusion of any link does not imply an endorsement of the third party website by Microsoft or TOSHIBA.
11. **BACKUP COPY.** You may make one backup copy of the software. You may use it only to reinstall the software on the device.
12. **PROOF OF LICENSE.** If you acquired the software on the device, or on a disc or other media, a genuine Certificate of Authenticity label with a genuine copy of the software identifies licensed software. To be valid, this label must be affixed to the device, or included on or in TOSHIBA's software packaging. If you receive the label separately, it is not valid. You should keep the label on the device or packaging to prove that you are licensed to use the software. To identify genuine Microsoft software, see <http://www.howtotell.com>.
13. **TRANSFER TO A THIRD PARTY.** You may transfer the software only with the device, the Certificate of Authenticity label, and these license terms directly to a third party. Before the transfer, that party must agree that these license terms apply to the transfer and use of the software. You may not retain any copies of the software including the backup copy.
14. **RESTRICTED USE.** The Microsoft software was designed for systems that do not require fail-safe performance. You may not use the Microsoft software in any device or system in which a malfunction of the software would result in foreseeable risk of injury or death to any person. This includes operation of nuclear facilities, aircraft navigation or communication systems and air traffic control.
15. **NO WARRANTIES FOR THE SOFTWARE.** **The software is provided "as is". You bear all risks of using it. Microsoft gives no express warranties, guarantees or conditions. Any warranties you receive regarding the device or the software do not originate from, and are not binding on, Microsoft or its affiliates. When allowed by your local laws, TOSHIBA and Microsoft exclude implied warranties of merchantability, fitness for a particular purpose and non-infringement.**
16. **LIABILITY LIMITATIONS.** **You can recover from Microsoft and its affiliates only direct damages up to fifty U.S. Dollars (U.S. \$50.00). You cannot recover any other damages, including consequential, lost**

End User License Agreements (EULAs)

profits, special, indirect or incidental damages.

This limitation applies to:

- anything related to the software, services, content (including code) on third party internet sites, or third party programs, and
- claims for breach of contract, breach of warranty, guarantee or condition, strict liability, negligence, or other tort to the extent permitted by applicable law.

It also applies even if Microsoft should have been aware of the possibility of the damages. The above limitation may not apply to you because your country may not allow the exclusion or limitation of incidental, consequential or other damages.

17. **EXPORT RESTRICTIONS.** The software is subject to United States export laws and regulations. You must comply with all domestic and international export laws and regulations that apply to the software. These laws include restrictions on destinations, end users and end use. For additional information, see www.microsoft.com/exporting.

End User License Agreement for ArcSoft Software

The following is a legal software license agreement between you, the software end user, and ArcSoft, Inc. Carefully read this license agreement before using the relevant ArcSoft software ("**Software**"). Installing the Software on a computer or other hardware device indicates that you have read this license agreement and agree to its terms.

1. **Grant of License.** This license permits you to use one copy of the Software included in this package or product on any single computer. For each software licensee, the program can be "in use" on only one computer or hardware device at any given time. The Software is "in use" when it is either loaded into RAM or installed into the hard disk or other permanent memory of a computer or other hardware device. A special license permit from ArcSoft is required if the program is going to be installed on a network server for the sole purpose of distribution to other computers. You may not modify, translate, reverse assemble, decompile, disassemble or otherwise attempt (i) to defeat, avoid, bypass, remove, deactivate or otherwise circumvent any software protection mechanisms in the Software,

End User License Agreements (EULAs)

including without limitation any such mechanism used to restrict or control the functionality of the Software, or (ii) to derive the source code or the underlying ideas, algorithms, structure or organization from the Software (except to the extent that such activities may not be prohibited under applicable law).

2. **Copyright.** The Software contained in this package or device is protected by United States copyright laws, international treaty provisions, and all other applicable national laws. The Software must be treated like all other copyrighted materials (e.g. books and musical recordings). This license does not allow the Software to be rented or leased, and the written materials accompanying the Software (if any) may not be copied.
3. **Ownership.** Title, ownership rights, and all intellectual property rights in and to the Software and any accompanying documentation, and any copy of the foregoing, shall remain the sole and exclusive property of ArcSoft and/or its third party licensors. You agree to abide by the copyright law and all other applicable laws. You acknowledge that the Software contains valuable confidential information and trade secrets of ArcSoft and/or its third party licensors.
4. **Warranty Disclaimer.** NO WARRANTIES, EITHER EXPRESS OR IMPLIED, ARE MADE WITH RESPECT TO THIS SOFTWARE, INCLUDING BUT NOT LIMITED TO THE IMPLIED WARRANTIES OF MERCHANTABILITY AND FITNESS FOR A PARTICULAR PURPOSE AND WARRANTIES FOR NON-INFRINGEMENT OF INTELLECTUAL PROPERTY, AND ARCSOFT EXPRESSLY DISCLAIMS ALL WARRANTIES NOT STATED HEREIN. YOU ASSUME THE ENTIRE RISK AS TO THE QUALITY AND PERFORMANCE OF THE SOFTWARE. SHOULD THE SOFTWARE PROVE DEFECTIVE, YOU, AND NOT ARCSOFT OR AN AUTHORIZED RESELLER, ASSUME THE ENTIRE COST OF NECESSARY SERVICING, REPAIR, OR CORRECTION. SOME STATES DO NOT ALLOW THE EXCLUSION OF IMPLIED WARRANTIES, SO THE ABOVE EXCLUSION MAY NOT APPLY TO YOU. THIS WARRANTY GIVES YOU SPECIFIC LEGAL RIGHTS, AND YOU MAY ALSO HAVE OTHER RIGHTS THAT VARY FROM STATE TO STATE. YOUR SOLE REMEDY AND THE ENTIRE LIABILITY OF ARCSOFT ARE SET FORTH

End User License Agreements (EULAs)

ABOVE. IN NO EVENT WILL ARCSOFT BE LIABLE TO YOU OR ANY OTHER PERSON FOR ANY DAMAGES, INCLUDING ANY INCIDENTAL OR CONSEQUENTIAL DAMAGES, EXPENSES, LOST PROFITS, LOST SAVINGS, OR OTHER DAMAGES ARISING OUT OF USE OF OR INABILITY TO USE SUCH SOFTWARE.

5. **No Liability for Consequential Damages.** In no event shall ArcSoft be liable for any damages whatsoever (including but not limited to damages for loss of business profits, business interruption, loss of business information, or any other pecuniary loss) which results from an inability to use this Software, even if ArcSoft, Inc. has been advised of the possibility of such damages. Because some states/jurisdictions do not allow the exclusion or limitation of consequential or incidental damages, the above limitations may not apply to you.
6. **Export.** Subject to permission of the appropriate United States or foreign licenses, export or re-export the product incorporating the Software is able to be made.
7. **U.S. Government Restricted Rights.** If you are a unit or agency of the United States government, the Software and related

documentation are deemed to be "commercial computer software" and "commercial computer software documentation," respectively, pursuant to DFAR Section 227.7202 and FAR Section 12.212(b), as applicable. Any use, modification, reproduction, release, performing, displaying or disclosing of the Software and/or the related documentation by the United States government shall be governed solely by the terms of this Agreement and shall be prohibited except to the extent expressly permitted by the terms of this Agreement. Any technical data provided that is not covered by the above provisions is deemed to be "technical data commercial items" pursuant to DFAR Section 227.7015(a). Any use, modification, reproduction, release, performing, displaying or disclosing of such technical data shall be governed by the terms of DFAR Section 227.7015(b).

8. **High Risk Activities.** The Software is not fault-tolerant and is not designed or intended for use in hazardous environments requiring fail-safe performance, or any other application in which the failure of the Software could lead directly to death, personal injury, or severe physical or property damage (collectively, "High Risk Activities"). ARCSOFT EXPRESSLY

End User License Agreements (EULAs)

DISCLAIMS ANY EXPRESS OR IMPLIED WARRANTY OF FITNESS FOR HIGH RISK ACTIVITIES.

9. **Termination.** Your rights with respect to the Software may be terminated, either immediately or after a notice period not exceeding thirty (30) days, upon unauthorized copying of the Software or failure to comply with the restrictions contained in this license agreement. Upon termination of the license, you shall **cease to use thereof**. [Toshiba comment: This is a ROM based product and there is no way for the end user to return or uninstall the Software thereof.]
10. **Governing Law.** If this product was purchased in the United States, this Agreement is governed by the laws of the state of California; otherwise, local laws may apply.

End User License Agreement for Picstel Software

1. The End User shall be made aware that all copyrights and intellectual property rights in the Product are proprietary to Picstel and that PICSEL, PICSEL POWERED, PICSEL BROWSER, PICSEL DOCUMENT VIEWER, PICSEL PDF VIEWER, EPAGE, e-PAGE, DEMOCRACY OF ACCESS or the Picstel Cube Logo are trademarks or registered trademarks of Picstel Technologies Limited.
2. The End User shall be prohibited from reverse engineering, disassembling, reversing translating, or in any way decoding the Product or any copying of part of it in order to derive any source code.
3. US law and international agreements currently prohibit (as of May 2005) export of the device and the software to the following countries - Cuba, Iran, Libya, North Korea, Sudan and Syria.

Index

A

- About 142
- AC charger 157
- AC charger safety 16
- ActiveSync 90
- A-GPS 92
- Alarm 144
- Animation 150
- Attachments 63, 64
- Auto Configurator 39
- AutoInstall 92

B

- Backlight 143, 150, 157
- Battery 21, 33, 34, 37, 143, 148, 157
- Battery safety 15
- Beam 119
- BlackList 93
- Block Recognizer 67
- Blocking video 51
- Bluetooth 90, 116
- Bluetooth headset 118
- Bluetooth mode 116
- Bluetooth security 118
- Business cards 100
- Buttons 129

Index

C

Calculator 94
Calendar 79
Call Barring 134, 138, 158
Call barring password 134, 138
Call Forwarding 135, 139, 158
Call History 46, 52
Call Timers 53
Call Waiting 135, 139
Caller ID 134
Camera 95
Categories 84
Cell Broadcast 119
Certificate Enrollment 97
Certificates 143
Clock 145
Conference calls 50
Contacts 45, 51, 82
Cookies 88
Creating a contact 82
Creating an e-mail 62
Creating an MMS message 57

CSD Line 125
Customer Feedback 145

D

Data connection 115
Date 144
Deleting messages 56
Device lock 130
Device name 142
Dial-up connection 122
Digital signing 63
Direct Push e-mail 115
Domain Enroll 125
Draft messages 55
Drawing 75

Index

E

- Electronic devices 15
- E-mail 60
- Emergency calls 17, 45
- Encryption 145
- Ending a call 48
- Ending applications 152
- Error Reporting 146
- European RF Exposure Information 17
- Excel Mobile 78
- Exchange server 60, 90
- External GPS 146

F

- File Explorer 97
- Fixed Dialling 136
- Flight Mode 115
- FM Radio 97
- Forwarding a message 56
- Full Screen Keyboard 76

G

- Games 89
- Gestures 72, 150
- Getting Started 99
- GPRS connection 121
- GSM 126

H

- Hands-free 49
- Headset Volume Limiter 147
- Holding a call 49
- Home 99
- Home screen 41
- Home Tab 150

Index

I

Image Editor 100
Image To Text 100
Input Options 69
Input Panel 67
International calls 46
Internet 159
Internet connections 120
Internet e-mail 60
Internet Explorer 86
Internet Favourites 87
Internet History 88
Internet Sharing 126

J

Java 102
JBlend 102

K

Keyboard 68
Keypad lock 39
Keypad tones 134

L

Letter Recognizer 68
Live Search 86

M

Making a call 45
Managed Programs 147
Meeting requests 79
Memory 147
Messaging folders 66
Messenger 103
MMS messages 56, 159
MMS settings 56
Muting a call 49

N

Network adaptor 128
Network Mode 126
Network settings 137
Notes 104
Notifications 140
Now Screen 42, 150

Index

O

- Office Mobile 78
- OneNote Mobile 78
- Operating environment 14
- Owner Information 133

P

- Pairing 117
- Phone layout 25
- Phone lock 131
- Photographs 95
- Picxel Viewer 105
- Pictures 84, 106
- Pictures & Videos 106
- PIN2 132
- Power 148, 157
- PowerPoint Mobile 78
- Preferred Networks 137
- Proxy connection 124

Q

- Quick Dial screen 43

R

- Receiving a call 48
- Receiving MMS messages 59
- Regional Settings 148
- Reinitialising (hard reset) 23
- Reminders 81
- Removing Programs 149
- Replying to a message 56
- Resetting 22
- Restarting 22
- Ring tone 84
- Ring tones 133

Index

S

Screen 149
Search 107
Security 130
Sending a text message 54
Sending and receiving e-mail 64
Sending contacts 86
Setting up e-mail 60
Signatures 66
SIM card 33, 34, 158
SIM PIN 131
SIM Toolkit 108
Slide show 106
SMS 54
Sounds 140
Speakerphone 49
Speed Dial 47
Start menu 29, 132
Starting and stopping synchronisation 91
Status icons 30
Streaming Player 108
Stylus 36

System Information 151

T

Tabs 151
Task Manager 152
Tasks 109
Text messages 54, 159
Text messages service centre 135
Themes 141
Time 144
Today plug-in 44
Today screen 28, 106, 141
Toshiba UI 150
TOSHIBA User Interface 40, 90
Transcriber 69
Transcriber toolbar 70

U

UMTS 126
Unpairing 118
USB to PC 127

Index

V

Video calls 51
Videos 95, 106
Voice mail 47, 136
Volume 49
Volume control 129
VPN connection 123

W

Weather 151
Wi-Fi 127
Wi-Fi security 128
Windows Live 106, 110
Windows Live Messenger 103
Windows Media Player 111
Windows Update 153
Wireless Manager 115
Word Completion 69
Word Mobile 79
Word Mobile 78

Free Manuals Download Website

<http://myh66.com>

<http://usermanuals.us>

<http://www.somanuals.com>

<http://www.4manuals.cc>

<http://www.manual-lib.com>

<http://www.404manual.com>

<http://www.luxmanual.com>

<http://aubethermostatmanual.com>

Golf course search by state

<http://golfingnear.com>

Email search by domain

<http://emailbydomain.com>

Auto manuals search

<http://auto.somanuals.com>

TV manuals search

<http://tv.somanuals.com>