

TOSHIBA

15VL33

Owner's manual

Bedienungsanleitung

Manuel de l'utilisateur

Gebruiksaanwijzing



stasia

List of contents

Special features	2
Safety instructions	3
Getting started	4
Aerial connection.....	4
Switching on.....	4
Battery fitting.....	4
Control unit	5
Front and rear panel.....	5
External connections table.....	6
Remote control	6
Using the TV	7
Tuning the TV	8
Automatic tuning.....	8
Manual tuning.....	9
Program organising	10
TV setup	11
Sound menu	11
Sound Features	12
Picture menu.....	13
Features Menu	13
Using teletext	15-16
Connecting external equipment	18-24
Help and service tips	25
Technical specifications table	26

Television

Thank you for buying this television which is designed to give you many years of satisfactory service.

You may already be familiar with using a television but do please take time to read these instructions. They are designed to familiarise you with the unit's many new features and to ensure you get the very best out of your purchase.

Special features

- 15" TFT-LCD XGA Panel
- 1024x768 resolution
- 16,722,216 colors (8 bit)
- CATV
- 430 cd/m² brightness
- 400:1 Contrast ratio
- 2x2W Stereo Sound
- 124 page teletext
- Wide viewing angles
- 1 Scart, AV, Audio Out.
- Low Power Consumption
- AVL
- ATS
- Intelligent programme switch
- On timer
- Off timer
- Graphical equaliser
- On screen display
- Manual fine tuning
- 100 Programme memory
- Full function remote control
- Child Lock

Safety is Important

Your safety and the safety of others is important. Please, therefore, ensure you read the Safety instructions **before** you operate this television.

Safety instructions

! Read all the safety instructions before first use of your TV.



- Position the television so that direct light does not fall on the screen. Excessive light will cause a washed out effect.



- Position the power supply lead and other leads so that they are not likely to be walked on or pinched by things placed on or against them.



- Do not place objects filled with liquid such as vase or flower pot near the television.

- Do not expose the TV to dripping or splashing of liquids.

- Do not place naked flame sources such as lighted candles on the TV set.



- Make sure that no naked flame sources, such as lighted candles, are placed on top of the appliance.

- Do not place the television near heat sources such as radiators, ovens, stoves, etc.



- Do not push, hit or screw the screen of your product.



- The heat built up in the set escapes through ventilation holes, so do not cover the set by drapes, clothes etc. that may block air circulation. Do not place the television on carpet or soft furnishings.

- NEVER let children push anything into the holes or slots on the case.



- Clean the TV Screen using a slightly damp cloth or chamois leather. Never use abrasive cleaning agents like liquid or aerosol cleaners.

- Remove the mains plug from the socket outlet while cleaning.

- Never apply pressure on the screen when cleaning.



- Never put your screen on hard objects. Your TFT screen may be damaged.



- Your TV set is designed to operate with the adaptor provided 12V DC.-5A. If you leave power cord at the mains plug the adaptor will get hot although the unit is off. Better to unplug the cord from the mains if you will not use the unit for a long time.



- Use the adaptor supplied with the product. Never connect any other power sources to the product. Turn off the TV set from mains switch before unplug the adaptor mains. Be sure your hands are dry.

Getting started

Remove your Television carefully from the box. You may wish to store the packaging for future use.

In the box

Inside the carton box you should have:

- Accessories box
- Power cord
- Adapter
- Remote control
- Batteries

Read these instructions before use.

Aerial connection

To connect an aerial, plug the aerial lead into the aerial socket on the rear of the TV.



You can use an outdoor or indoor aerial. However, if you use an indoor aerial the quality of the reception may be reduced and adjustment of the aerial may be required when changing programs.

Please note

If you live in a poor reception area or use an indoor aerial you may experience loss or corruption of teletext transmissions.

Switching on and First Use

1. Connect the power cord to the mains plug.
2. Connect the input socket of the adapter to the 12 V DC socket at the back panel of the LCD TV.
3. Connect adapter to the mains plug.

Note 1: Your TV will move to stand-by mode in five minutes when there is no broadcast signal.

Note 2: Your TV is equipped to operate with front panel buttons, “MENU”, “PR+”, “PR-”, “+”, “-” in case your R/C is broken or you run out of batteries.

Please Note

When not in use disconnect the plug from the mains power supply.



4. Press the **Power** button on the front of the TV. The standby indicator will illuminate.



5. Press a **Numeric** button or the **Program up** or **Program down** button on the remote handset or **Program up**, **Program down** or **MENU** button on the front panel to switch the TV on.



The standby indicator remains on. The picture will appear after a few seconds.



Press the **Standby** button to switch the TV to standby. The standby indicator will brighter.

Please Note

Do not leave the television on standby unattended or overnight.

Switching the TV on for the first time

To install your TV, please read the sections “TV controls” and “Tuning the television”.

Battery fitting

Insert the 2 AAA Batteries supplied into the compartment on the rear of the remote control, ensure you follow the polarity diagram inside the compartment.

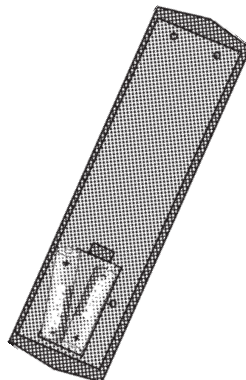

Control Unit

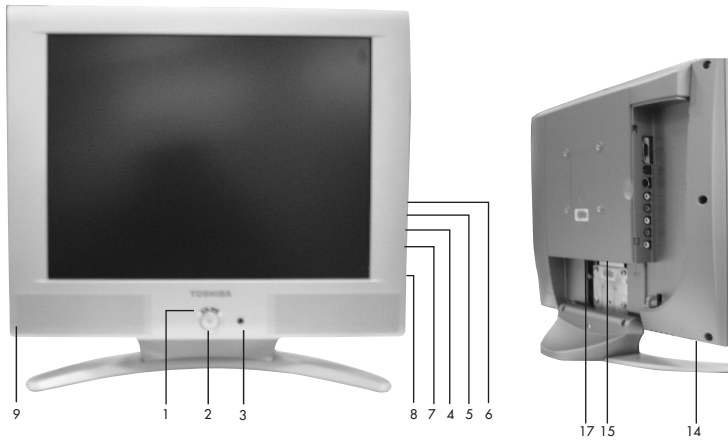

5

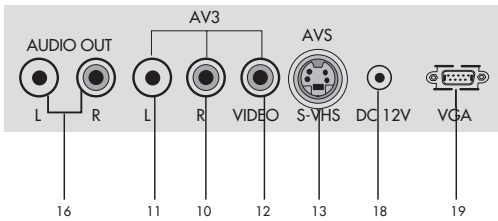

- | | |
|--------------------------|--|
| 1. Stand-by | 11. Audio RCA (L) |
| 2. Power on / off | 12. Video input CINCH connector |
| 3. Remote control | 13. S-VHS |
| 4. Menu button | 14. Headphone |
| 5. Volume up | 15. Antenna input |
| 6. Volume down | 16. Audio out (R,L) |
| 7. Program up | 17. Scart |
| 8. Program down | 18. DC 12V Power supply input |
| 9. Speaker | 19. VGA |
| 10. Audio RCA (R) | |

Please note

- See the external connections table on next page for available connections.
- Do not use Video RCA and S-Video connections at the same time, otherwise they will effect the picture each other.
- RGB inputs from scart will give you better picture quality.

External connections table

Picture tube size/type	15" 4:3
AV1 Scart	STD.
Headphone socket	STD.
Audio/Video RCA	STD.
S-Video socket	STD.
Back audio out	STD.

STD : Standart
 OPT : Optional
 N/A : Not available

Remote control

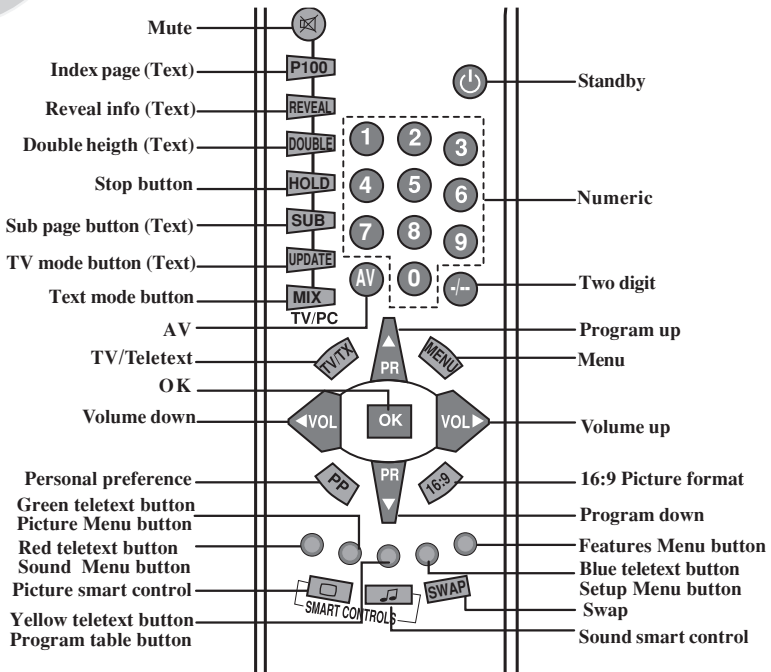

Using the TV

Turning on for the first time and Tuning

TV controls

Stand-By mode



When your TV is working on, press the red “STAND-BY” button on the right upper corner of your remote control to switch off and the Stand-By indicator (Led) will be brighter. To turn on your TV again, press one off the numeric buttons, **Program up** or **Program down**.

Please Note: If you will not use your TV for a long time, do not leave it on Stand-By mode, instead switch it off from the power button on the front panel of the TV set.

Programme selection



Press the **Program up** or **Program down** buttons on the TV or remote control or press a **Numeric** button to select a programme.

To select a programme whose number is greater than 9 using the numeric buttons, press the **/--** button first and then press the two **Numeric** buttons. For example, to select programme 12, press the **/--** button followed by **1** and then **2**.

You can also select a program by pressing in the Yellow button to see the Program Table.

PROGRAM TABLE		
00. ----	05.	10.
01.	06.	11.
02. BBC	07.	12.
03.	08.	13.
04.	09.	14.

SKIP MODE NAME DELETE



Use the **Program up** and **Program down** buttons to scroll through the programme numbers. When you find the program number you want press the **OK** button again.

Press the **TV/TX** button to close the Program Table.

Volume

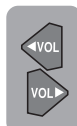

Press the **Volume +** or **Volume -** button on the TV or the **Vol** or **Vol** button on the remote control. A sound level bar will appear on the screen.

Mute



To mute the sound press the **Mute** button on the remote control. A loudspeaker symbol will appear on the screen.



Press the **Mute** button again to restore the sound. The symbol will disappear.

Pressing **Volume up** buttons will also restore the sound. But pressing the **Volume down** button will decrease the volume without restoring.

PP



Personal preference. Press the **PP** button to revert to the default settings for the TV. (See TV setup).

Swap



Select the programme you would like to recall by pressing **SWAP** button. Selected programme number will appear on the lower left side of the screen. While watching any programme, you can recall the selected one by pressing **SWAP** button again. If you press swap button again you can recall the last programme you watched. You can cancel **SWAP** function by pressing **MENU** button.

PR 01 → (SWAP) PR 11 → PR 12 → PR 13... → (SWAP) PR 01

AV



Your TV has 1 scart so every time you press your AV button, your input will change as follows:

- 1 AV1 when using SCART socket 1 (RGB support).
- 2 AV2 when using RCA socket.
- 3 AVS when using the S-video socket.



Press the **AV** button again to return to TV.

Tuning the television

There are two ways of tuning your television: Manual, where you control the tuning process or Autoprogram where the television does it all automatically.

Your TV will sort all the channels with the ATS. Sorting will be performed in the following order:

- a- Selected country's channels with teletext and channel names.
- b- Selected country's channels with teletext and without channel names.
- c- Selected country's channels without teletext.
- d- Foreign channels with teletext and channel names.

Please Note

If the TV is set to a channel with no signal the TV will return to standby in 5 minutes. The last minute remaining is displayed on the screen.

Automatic tuning (Autoprogram)

There are two ways to access the **SETUP** menu:



Press the blue **Setup** button.
or
Press the **Menu** button and use the **Program down** button to select **SETUP**. Press the **OK** button to enter the **SETUP** menu.

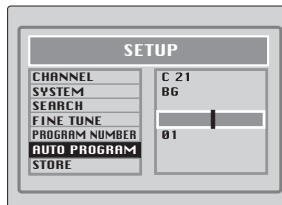
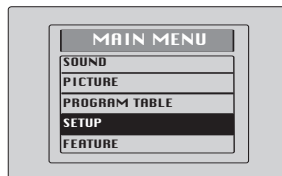

Please note

The system will be displayed automatically on SYSTEM row i.e.BG, L, I or DK depending the receiving broadcasting system of your country. In some countries the broadcasting system can be both in BG/DK or BG/LL'. Only the TV sets produced with Pal Secam BG/DK or Pal Secam BG/LL' systems can receive both BG/DK or BG/LL' broadcasts. In this case the user can select the required SYSTEM using **Volume up/down** buttons.

Please note

If you do not press any buttons for 15 seconds the TV will exit the menu system.



Use the Program down button to select AUTOPROGRAM and press the OK button. A list of countries will appear. Select the desired country using **Program** and **Volume** buttons.



When you are sure the aerial is connected properly press the **OK** button. Autoprogram will start.

To cancel Autoprogram whilst it is working press the **Menu** button repetitively.

As Autoprogram stores a channel it will appear briefly on the screen before the search continues.

Manual tuning

If you want to tune manually:



In the Setup menu select PROGRAM NO using the **Program down** button and use the **Volume up** button to change the Program No to 01.

Starting with Program 01, tune in the first channel as follows:

Use the **Program down** button to select SEARCH.

Press the **Volume up** or **Volume down** button to start the tuning search.

When the search finds a strong channel signal it will stop searching. The picture will appear.

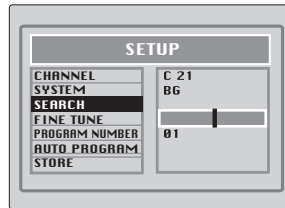

Use the **Program down** button to select PROGRAM NO.

Use the **Volume up/down** or numeric buttons to select the desired programme number.

Use the **Program down** button to select STORE. Press the **OK** button and STORED will appear on the STORE line.

You have now stored the first channel.

Use the **Program up** button to select again SEARCH and continue the tuning procedure until you have tuned in all the programmes you want or the television can receive.

Your TV is now tuned and ready to use.

Please note:

If auto sort fails to arrange the programmes in the required sequence please refer to programme organising.

Tuning with channel numbers

Enter the SETUP menu by pressing the blue button.

OK

Press **OK** button when CHANNEL row is blue.

OK

Use OK button to select "S" for cable channels and "C" for terrestrial broadcast.

7

Enter the channel number using the Numeric buttons or use the **Volume up/down** buttons to tune channels.

<VOL

VOL>

PR

>

Use the **Program down** button to select PROGRAM NUMBER.

<VOL

VOL>

Use the **Volume up/down** or numeric buttons to select the desired programme number.

PR

>

Use the **Program down** button to select STORE. Press the **OK** button and STORED will appear on the STORE line.

OK

You have now stored the first channel.

PR

<

Use the **Program up** button to select again CHANNEL and continue the tuning procedure until you have tuned in all the programmes you want or the television can receive.

TV/TX

To exit the SETUP menu press the TV/TX button.

Fine tuning

Although the search and Autoprogram will automatically try and tune to the best reception, in areas of poor reception a bit of fine tuning may be required.

PR

<

PR

>

<VOL

VOL>

OK

In the SETUP menu use the **Program up/down** buttons to select FINE TUNING. Use the **Volume up** and **Volume down** buttons to fine tune.

When you have finished use the **Program down** button to select STORE and press the **OK** button.

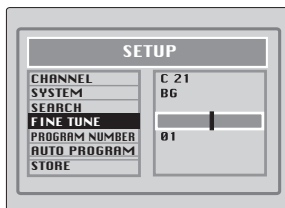

Program organising

Once you have tuned in all the channels you want, you can change their programme number, if required, and name them.

To enter the PROGRAM TABLE menu press the **Menu** button and select PROGRAM TABLE and press the **OK** button or press directly the **Yellow** button.



The buttons used to edit the programs are shown at the bottom of the display:

- Blue button - Name
- Green button - Move
- Pink button - Delete
- Red button - Skip

To name the programmes

You can name the programmes and AV inputs.

Press the **Blue** button, the selected programme will be highlighted.

Use the **Program up** and **Program down** buttons to select the letters and numbers and the **Volume up** and **Volume down** buttons to move through the name.

Press the **Blue** button again to store the name.

Repeat this process to name all the programmes.

Please Note

1. Some TV channels may send their names with teletext transmission. In this case their names will be automatically shown on the name line.

1. Child locked programmes will be shown as "no".

To move the programmes

You can move the programmes around the programme list to the order you want

Select the programme you want to move and press the **Green** button. The programme will turn to yellow. Select the number you want to move and press the **Green** button again and the programme will be moved to that number.

All the following programmes are shifted down by one place.

To delete a programme

To delete a programme, select it and press the **Pink** button. The programme will be deleted.

All the following programmes are shifted up by one position.

To skip programmes

Skipped programmes will not appear when you move through the program list using the **Program up/Program down** buttons.

They can still be selected using the numeric buttons or the OK button.

Select the programs you want to skip and press the **Red** button. The program will turn red. To unskip the program press the **Red** button again.

To exit the PROGRAM EDIT press the **TV/TX** button once or the **Menu** button twice.

When you select a programme, the information you entered in the PROGRAM EDIT menu will appear on the top of the screen i.e. P1 BBC1. This will disappear after about three seconds.

TV set up

The TV set up is accessed through a menu system.

Once you have stored your set up, this is the set up the TV will default to when you switch it on.



To enter the MAIN menu press the **Menu** button.

Once in the MAIN menu use the **Program up** and **Program down** buttons to select items in the menu and the **OK** to access sub menus or use the coloured fastext buttons for quick access.

- Red button - SOUND
- Green button - PICTURE
- Pink button - FEATURES

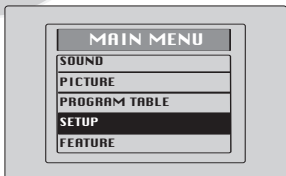

Please note

If you do not press any buttons for 15 seconds the TV will exit the menu system.

Sound menu (red button)

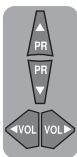

Select the required item in the menu using the **Program up/down** buttons and make the changes pressing **Volume up/down** buttons. Use the **OK** button to enter **HEADPHONE** from main menu.

Volume

Sets default volume using the **Volume up** and **down** buttons.



To save your settings, select **STORE** and press the **OK** button. **STORED** will be displayed. Press the **Menu** button to go back to the previous menu.

Balance

Sets the sound balance mode using the **Volume up** and **down** buttons



To save your settings, select **STORE** and press the **OK** button. **STORED** will be displayed. Press the **Menu** button to go back to the previous menu.

Sound type

This item shows **STEREO** when receiving stereo transmission and **MONO** for mono transmissions.

The TV can be produced to receive the **NICAM** broadcasts as a optional feature.

If the channel you are watching is in **Nicam stereo** the **On Screen Display** will show **NICAM STEREO** for a while.

Please Note

If, while watching a **nicam stereo** channel, the signal strength drops and the system cannot receive **nicam stereo** the **OSD** will show **MONO**. If the signal strength increases again and **nicam stereo** can be received again, the **OSD** will show **NICAM STEREO**.

Dual I/II

Some broadcasters supply the programmes in two languages. To able to listen the second language select **DUAL II** by **SOUND TYPE** using **Volume up/down** buttons.



To save your settings, select **STORE** and press the **OK** button. **STORED** will be displayed. Press the **Menu** button to go back to the previous menu.

Sound mode

You can select **NORMAL** or **SPATIAL** **Volume up/down** buttons.

SPATIAL sound is an 'expanded stereo'. It gives the impression that the two speakers in the TV are further apart than they really are.

AVL

TV transmitters have different sound levels. AVL (automatic volume limiting) maintains the same sound level as you switch from program to program.

To apply this press **Volume up** or **down** button and select **ON** for AVL in **Sound Features** menu.

Equalizer

To access the 5 band equalizer menu press **Volume up** or **down** button and press **OK** on the **Equalizer** line.

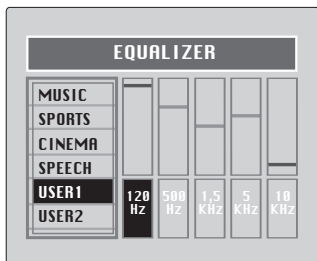

In this menu there are a series of preset equalizer settings for different types of sound output.

There are four music settings - **MUSIC**, **SPORTS**, **CINEMA**, **SPEECH** and **USER1** & **USER2** modes.

MUSIC, **SPORTS**, **CINEMA**, **SPEECH** are factory presets.

USER modes allow you to set your own sound outputs as follows:



Press the **OK** button to enter the **EQUALIZER** menu.

Use the **Program down** button to select **USER1**.

Press **OK** button to adjust the frequency band levels.

Use the **Volume up** button to select the **KHz** column you want to change.

Use the **Program up/down** buttons to make the changes.

To save your settings, press the **OK** button. Press the **Menu** button to go back to the previous menu.

13

You can also adjust the settings of **USER2** by the same method.

You can change the equalizer setting whilst watching the TV using the sound Smart control.



Press the sound **Smart control** to page through the different equalizer settings and select the one you want.

Once you have switched the TV off the equalizer setting will revert to the stored setting.

Headphone

You can set up the volume, balance, bass treble and sound type (stereo or mono) of the headphone output.

Use **OK** button to enter the **HEADPHONE** menu.



To save your settings, select **STORE** and press the **OK** button. **STORED** will be displayed. Press the **Menu** button to go back to the previous menu.

Picture menu (Green button)

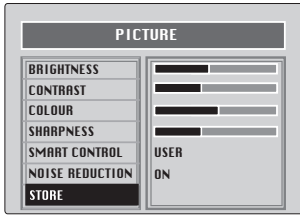

The picture menu allows you to set up the following:

BRIGHTNESS
CONTRAST
COLOUR
SHARPNESS
SMART CONTROL
and NOISE REDUCTION

14



To change, for example, the colour, select it using **Program up** and **down** buttons.

Use the **Volume up** and **Volume down** buttons to change the setting.

To save your settings, select STORE and press the **OK** button. STORED will be displayed.

These settings are stored as USER picture type.

You can change the picture type whilst watching the TV using the picture Smart control.



Press the picture **Smart control** page through the different picture types and select the one you want: SOFT, NATURAL, RICH or USER.

NOISE REDUCTION: You can reduce the noise effects in the pictures by selecting ON.



To save your settings, select STORE and press the **OK** button. STORED will be displayed. Press the **Menu** button to go back to the previous menu.

Features Menu (Purple button)



To select **Features** menu press the menu button and using the **Program up** and **down** buttons select **Features**.

You can also select the **Features** menu directly by pressing the **purple** button on the remote control.

The **Features** menu allows you to set up the following:

CHILD LOCK
CLOCK
TIMER
BACKGROUND
LANGUAGE



Use the **Program up** and **down** buttons to select the feature you wish to change and use **Volume up** and **down** buttons to adjust this feature.

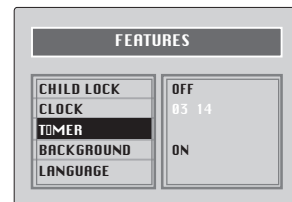



Child Lock: Using the **Child Lock**, you can lock any Program you want so that adult channels can not be watched by children.

You can cancel child lock any time you want. To cancel **Child Lock**, select **Child Lock** as OFF when you are watching that program.



Clock: Use the numeric buttons to set the real time.

Note: If you enter any channel with teletext transmission, clock will automatically set to real time.

Background: You can adjust the menu background as ON or OFF.



Language: You can select one of the 16 languages by pressing OK button in the language selection.

Timer: Use **Program up** and **down** buttons to select **Timer** in the features menu. Using the Timer function, you can switch to a specific programme at a pre-programmed time or you can turn your TV off at the time you want your TV to be turned off.

Press OK to access the **Timer** menu.

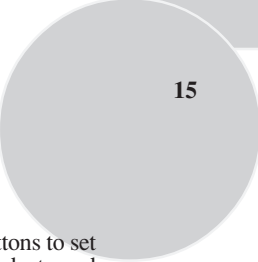
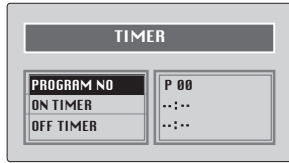

On Timer: Use the numeric buttons to set the time that you want your TV to be turned on (TV should be on stand-by mode).

Off Timer: Use the numeric buttons to set the time that you want your TV to be turned off (Stand-by mode).

Program No: Use the numeric buttons to set the programme number that will be shown when you set the **On Time**.

Using Teletext

Teletext is an information system that displays text on your TV screen. Using the teletext control buttons you can view pages of information that are listed in the teletext index.

Please Note

No on screen display is available in text mode. The contrast, brightness and colour cannot be changed but the volume control is still available.

16

To enter Text mode

Please Note

Make sure the TV channel you are watching transmits teletext. If not NO TEXT sign will be shown on the screen.



Press the **TV/TEXT** button. The text page will appear, normally the index page.

To exit Text mode



Press the **TV/TXT** button. The TV will return to the channel you were watching.

To select a page of text



Find the number of the page in the index and enter it using the **Numeric** buttons. The number of the page will appear in the top left hand corner of the screen.

The page counter will search for your page. When it finds it, the page will be displayed.



To move to the next page of text press the **Program up** button.



To move to the previous page press the **Program down** button.



To return to the index page press the **P100** button.

TV/text mix



To view a page of text whilst watching a TV programme press the **MIX** button. The text will be superimposed over the TV programme.



Press the **MIX** button again to return to the text page.

Page search whilst watching TV



In Text mode press the **Update** button. The TV will return to TV mode with the text page number in the top left hand corner of the screen.



Enter the page number you want using the **Numeric** buttons.

The top line of the text page will appear whilst the text searches for your page. When the page is found the number will remain in the top left hand corner of the screen.



Press the **Update** button to view your selected page of text.

Double height text



If you have difficulty reading the text on the TV you can double the height of the text.

Press the **Double height** button. The top half of the page will be displayed in double height text.



Press the **Double height** button again. The bottom half of the page will be displayed in double height text.



Press the **Double height** button again to return to the full page.

Page Stop

HOLD

If the page of text you have selected contains sub pages, these sub pages will automatically be displayed in order with a delay to allow you to read the page.

To stop the move to the next sub page press the **STOP** button. **STOP** will appear in the top left hand corner.

HOLD

To continue moving through the sub pages press the **STOP** button again.

To select a sub page

SUB

If the page of text you are viewing contains sub pages, the number of the sub page you are on and the total number of sub pages is displayed on the right of the screen i.e. 1/7.

To select a sub page press the **SUB** button. Press green button to select next sub-page or press red button to select previous sub-page.

5

Enter the number of the sub page, using the **Numeric** buttons in the format S0001 for sub page 1.

The teletext will search for the sub page. This may take some time. To return to the TV whilst the teletext is searching press the **Update** button.

When the page number is found it will appear in the top left hand corner of the screen.

UPDATE

Press the **Update** button again to view the text page.

To reveal information

REVEAL

Press the **Rev** button to reveal concealed information (quiz answers etc.).

REVEAL

Press the **Rev** button again to conceal the information again.

Clock

SUB

Press the **Sub** button, whilst watching a TV program, to display the time.

Fast text

At the bottom of the teletext screen is a row of subject headings in red, green yellow and blue.

The remote control has a row of coloured buttons corresponding to the row of coloured subjects on the screen.

Pressing one of the coloured buttons will take you directly to the page corresponding to the subject heading.

Connecting external equipment

You can connect a wide range of audio and video equipment to your TV.

Connecting a video recorder

① Via SCART

Make sure the TV and video recorder are both switched off.

Plug one end of the SCART lead (not supplied) into the back of the video recorder and the other end into one of the SCART sockets on the back of the TV.

Switch on the video recorder and the TV.



Press the AV button on the remote control to select AV1 to correspond with the SCART socket you are using on the back of the TV.

Please note:

You can connect a RGB external equipment via Scart. It is necessary to you use full Scart cable for this purpose.

Select the video outputs of external device by using its menu to RGB if it's available.

② Via RCA lead (optional)

Make sure the TV and video recorder are both switched off.

Plug one end of the RCA lead into the video and audio out sockets on the back of the video recorder and plug the other end into the video and audio in sockets of the TV.

If the sound is in mono use the Audio Input L. In the SOUND menu select MONO.

3 Via aerial socket

Make sure the TV and video recorder are both switched off.

Unplug the aerial lead from the TV and plug it into the aerial socket on the video recorder (if fitted).

Plug a coaxial plug into the RF out socket on the rear of the video recorder and plug the other end into the aerial socket of the TV.

Switch on the video recorder and the TV.

If your video recorder has a test signal, switch it on. (Refer to the video recorder user guide).

See 'Tuning the TV' and carry out the tuning procedure for the video recorder test signal. Select a programme number 0.

4-5 Via RCA lead and S-Video socket

You can also connect it through the S-Video socket of the TV.

Plug the S-Video plug into the S-Video socket and the audio leads into the audio sockets.

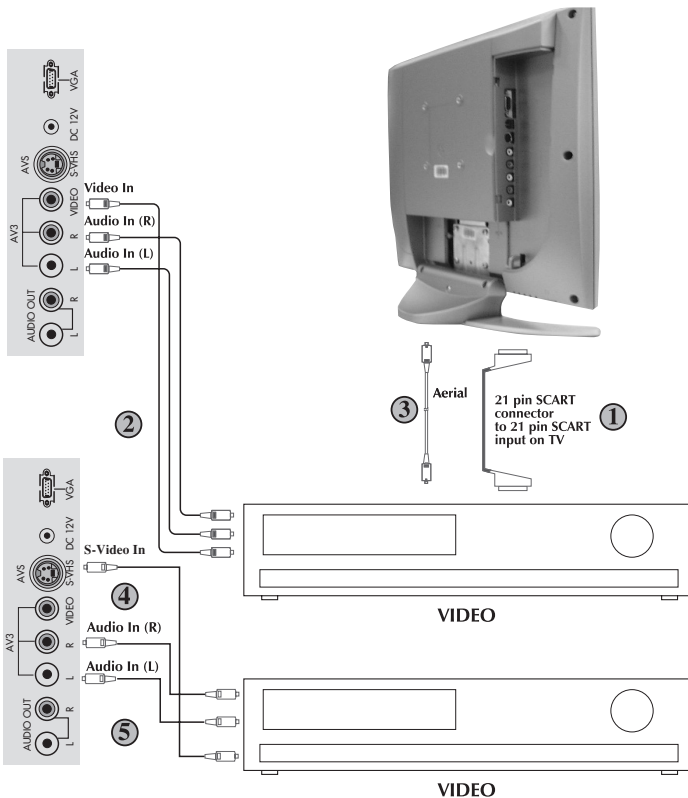

Connecting a DVD player

① Via SCART

Make sure the TV and DVD player are both switched off.

Plug one end of the SCART lead (not supplied) into the back of the DVD player and the other end into the SCART socket on the back of the TV.

Switch on the DVD and the TV.

② Via RCA lead

Make sure the TV and DVD player are both switched off.

Plug one end of the RCA lead into the video and audio out sockets on the back of the DVD player and plug the other end into the video and audio in sockets of the TV.

③ Via RCA lead and S-Video socket

You can also connect it through the S-Video socket of the TV.

Plug the S-Video plug into the S-Video socket and the audio leads into the audio sockets.

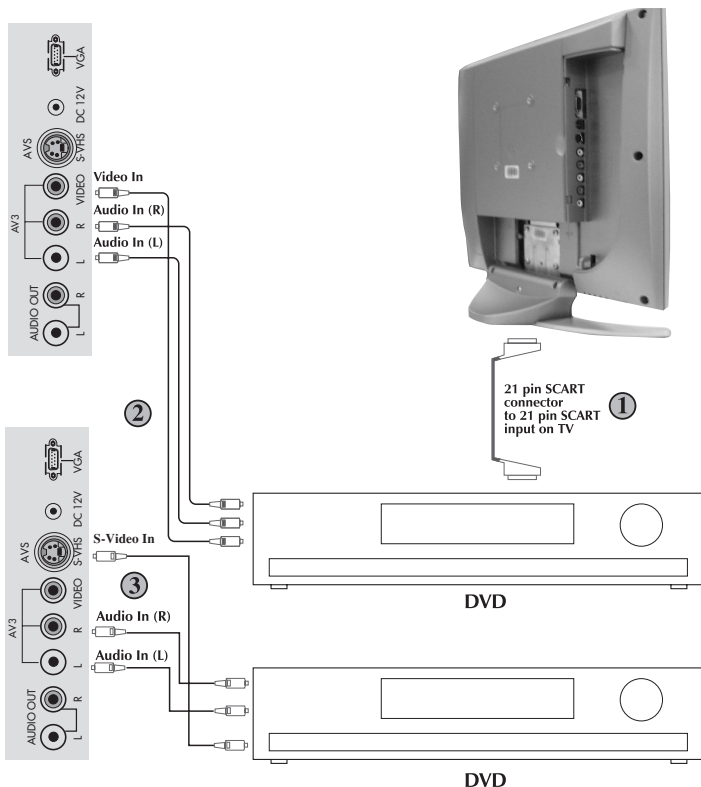

Connecting a decoder

Via SCART

Make sure the TV and decoder are both switched off.

Plug one end of the SCART lead (not supplied) into the back of the decoder and the other end into the SCART on the back of the TV.

Switch on the decoder and the TV.

 Press the **AV** button on the remote control to select AV1.

② Via RCA lead

Make sure the TV and decoder are both switched off.

Note: For Decoder connection Via RCA lead your Decoder device should have the tuner built in.

Plug one end of the RCA lead into the video and audio out sockets on the back of the decoder and plug the other end into the video and audio in sockets on the TV.

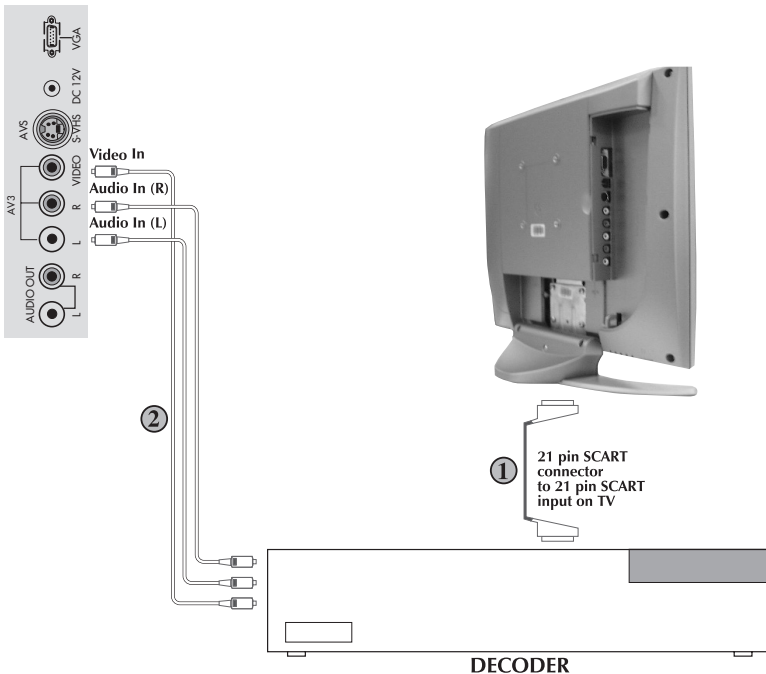
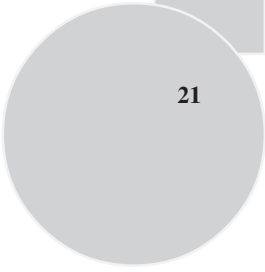

INTRODUCTION

Because your 15"LCD-TV equipment is provided with VGA inputs, it may be used as a PC monitor as well. (Pug&Play)

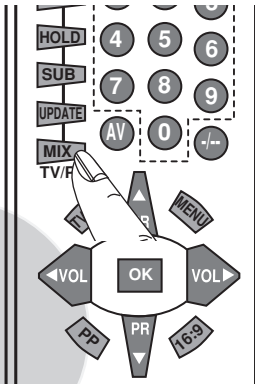

Entering the PC Mode

To enter the LCD-TV in to the monitor (PC) mode, the "MIX(TV-PC)" button on your remote control is used. Each time the "MIX(TV/PC)" button is pressed, operation changes from the PC mode, press the "MIX" button again. In addition, you may return to the TV mode by selecting the "TV SELECTION" option from the monitor menu alternatively.

Note 1: When the system is in the monitor mode, the sound from the TV channel selected may be heard from the speakers. When you enter this mode, the sound control buttons on the remote control. ("VOL" / "VOL" MUTE) become functional
Note 2: When the system is in the monitor mode, the STANDBY button is operational. Upon exit from STANDBY, the system starts up in the TV mode again.

22

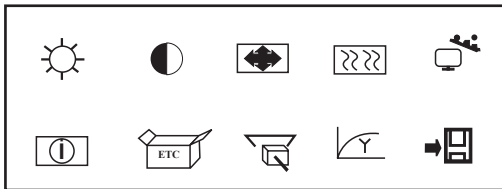

PC Mode Menu Structure

After changing to the PC mode, you may access the monitor menus by pressing the "MENU" button on the front panel of the system

To browse in the menus, you may use the "PR" / "PR" buttons and Vol+ or Vol- buttons to select the type of adjustment you wish to make. Once you make your selection, you may set the desired adjustment value using the "PR" / "PR" buttons.

BRIGHTNESS

After entering the Brightness Menu using the "VOL" / "VOL" buttons, you may set the brightness value of the monitor to the desired level by using the "PR" / "PR" buttons.

CONTRAST

After entering the Contrast Menu using the "VOL" / "VOL" buttons, you may set the contrast value of the monitor to the desired level by using the "PR" / "PR" buttons.

POSITION

After entering the Position Menu using the "VOL" / "VOL" buttons, you may set the geometrical adjustment value of the monitor to the desired level by using the "PR" / "PR" buttons.

H-POSITION : Horizontal position adjustment

V-POSITION : Vertical position adjustment

IMAGE

After entering the Image Menu using the "VOL" / "VOL" buttons, you may set the phase adjustment value of the monitor to the desired level by using the "PR" / "PR" buttons

PHASE : ADC sampling phase adjustment

CLOCK : ADC clock count Per line

AUTO CONFIG : Allows the entry of optimum geometrical adjustments based on the input mode

INFORMATION : Displays the input mode information on the screen.

MISCELLANEOUS

You may enter the factory default settings, Menu position and duration on the screen, resolution settings etc. by selecting the MISCELLANEOUS option.

FACTORY RESET : Loads the factory default settings

OSD TIMEOUT : The on-screen timeout may be adjusted to a value between 5 - 60 seconds.

OSD POSITION : Used for adjusting the OSD Horizontal and Vertical position

NATIVE MODE : Displays the input cursor in its actual resolution

TV SELECTION : To change from Monitor mode to TV mode

GAMMA : Correction of linear RGB data to compensate for non-linear response of TFT display.

MOIRE : Correction of distortions giving an image of the picture lines superimposed over one another.

SAVE : Stores the settings entered.

NOTE: The user can store the geometrical adjustments (H-Position, V-Position) entered for 6 different input graphic modes. When the Autoconfig is performed, the settings provided for that mode are stored, therefore, activating the Autoconfig function each time the mode is changed, is not necessary. When the user stores the settings for a 7th mode, the first mode stored will be erased

Warning Messages

1. No SYNC: The VGA input code (resolution) is missing. The "NO SYNC" message appears on the display. The message stays on the screen for 30 seconds and if no other VGA input signal that is supported by the system is not provided within that period, the system will go to "POWER SAVING" mode in order to protect the LCD panel. In this mode, the display will turn off, but the sound from the selected tuner channel will be audible

2. Input Not Supported: The input code (resolution) is not a supported graphics mode. The message "INPUT NOT SUPPORTED" appears on the display. The message stays on the screen until a supported graphic input code is received.

Input Graphic Modes Supported (progressive non-interlaced)

640 x 400 x 56 Hz	640 x 480 x 85 Hz	800 x 600 x 85 Hz
640 x 480 x 60 Hz	720 x 400 x 70 Hz	832 x 624 x 75 Hz
640 x 480 x 69 Hz	720 x 400 x 85 Hz	1024 x 768 x 60 Hz
640 x 480 x 72 Hz	800 x 600 x 56 Hz	1024 x 768 x 70 Hz
640 x 480 x 75 Hz	800 x 600 x 60 Hz	1024 x 768 x 75 Hz
640 x 350 x 70 Hz	800 x 600 x 72 Hz	1024 x 768 x 85 Hz
640 x 480 x 66 Hz (MAC)	800 x 600 x 75 Hz	

Important Warning:

1. When the system changes from TV mode to VGA mode for the first time, the sound from the speakers is muted, but available through the ear-phones
2. When a particular VGA mode is displayed for the first time, selecting the "Autoconfiguration" option may be necessary. The position adjustment as well as the H-Position and V-Position fine adjustments must be entered and the values "saved (stored)"
3. When the signal is cut off, depending on the VGA power-saving standard, the message "NO SIGNAL" is displayed on the screen for 30 seconds. At the end of this period, the system turns off, providing an energy saving of 30 watts.

Connecting TV with video and satellite/digital receiver

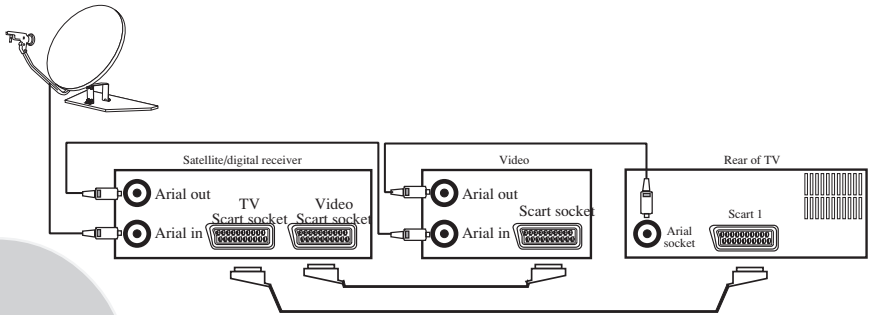

24

Connecting TV with camcorder

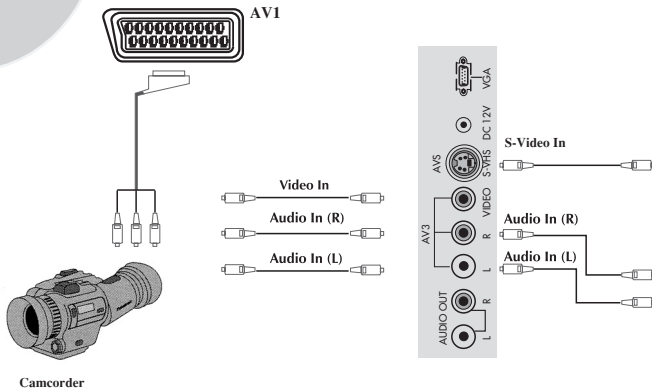

Connecting TV games and computer

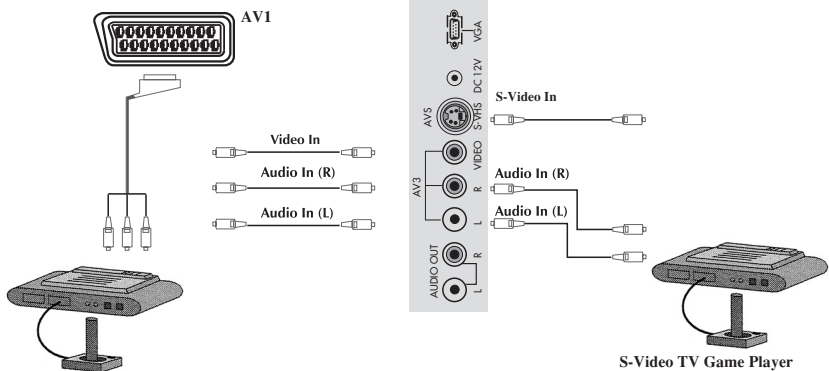

Technical specifications table

Picture tube size/type	15" 4:3
Screen size	38 cm
Visible screen size	304,15 (H) x 228,1 (V)mm
Sound Output (%10 THD)	2x2 W
Power consumption	45W (max)
Stand by Power consumption	2,5 W

26

General technical specifications

Power Supply

DC: 12V-5A

Number of preset programmes 100

RF Aerial input 75 ohm (unbalanced)

Speaker impedance 8 ohm

Sound Systems..... Mono/Stereo/NICAM

Batteries 2x AAA

Receiving channels VHF (Band I Channels 2-4)

..... VHF (Band III Channels 5-12)

..... UHF (Channels 21-69)

..... Cable TV (S1-S20/S21-S41)

Receiving broadcast system..... PAL BG

PAL SECAM BG

PAL SECAM BG DK/DK'

PAL SECAM BG LL'

PAL I

Free Manuals Download Website

<http://myh66.com>

<http://usermanuals.us>

<http://www.somanuals.com>

<http://www.4manuals.cc>

<http://www.manual-lib.com>

<http://www.404manual.com>

<http://www.luxmanual.com>

<http://aubethermostatmanual.com>

Golf course search by state

<http://golfingnear.com>

Email search by domain

<http://emailbydomain.com>

Auto manuals search

<http://auto.somanuals.com>

TV manuals search

<http://tv.somanuals.com>