

TOSHIBA



Introduction

Connecting
your TV

Using the
Remote Control

Setting up
your TV

Using the TV's
Features

Appendix

OWNER'S MANUAL

Color Television

COLORSTREAM®

32A33
32A43
36A43

Owner's Record

The model number and serial number are on the back of your TV. Record these numbers in the spaces below. Refer to these numbers whenever you communicate with your Toshiba dealer about this TV.

Model number:

Serial number:



Dear Customer,

Thank you for purchasing this Toshiba TV. This manual will help you use the many exciting features of your new TV.

Before operating the TV, please read this manual completely, and keep it nearby for future reference.

Safety Precautions

WARNING

TO REDUCE THE RISK OF FIRE OR ELECTRIC SHOCK, DO NOT EXPOSE THIS APPLIANCE TO RAIN OR MOISTURE.

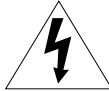

WARNING
RISK OF ELECTRIC SHOCK
DO NOT OPEN



WARNING: TO REDUCE THE RISK OF ELECTRIC SHOCK, DO NOT REMOVE COVER (OR BACK). NO USER-SERVICEABLE PARTS INSIDE. REFER SERVICING TO QUALIFIED SERVICE PERSONNEL.

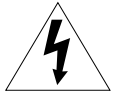

The lightning symbol in the triangle tells you that the voltage inside this product may be strong enough to cause an electric shock. **DO NOT TRY TO SERVICE THIS PRODUCT YOURSELF.**



The exclamation mark in the triangle tells you that important operating and maintenance instructions follow this symbol.

NOTE TO CATV INSTALLERS IN THE USA

This is a reminder to call the CATV system installer's attention to Article 820-40 of the NEC, which provides guidelines for proper grounding and, in particular, specifies that the cable ground shall be connected to the grounding system of the building, as close to the point of cable entry as practical. For additional antenna grounding information, see items 25 and 26 on page 4.

NOTICE OF POSSIBLE TV STAND INSTABILITY



DANGER: RISK OF SERIOUS PERSONAL INJURY OR DEATH! Use this TV with the TOSHIBA TV stand recommended in the "Specifications" section only.

Use with other stands may result in instability, causing possible injury or death.

NOTICE OF POSSIBLE ADVERSE EFFECTS ON TV PICTURE TUBE

If a fixed (non-moving) pattern remains on the TV screen for long periods of time, the image can become permanently engrained in the picture tube. **This type of damage is NOT COVERED BY YOUR WARRANTY.** See item 33 on page 4.



ENERGY STAR® qualified TV. Products that earn the ENERGY STAR prevent green house gas emissions by meeting strict energy efficiency guidelines set by the U.S. Environmental Protection Agency and the U.S. Department of Energy. ENERGY STAR and the ENERGY STAR mark are registered U.S. marks.

Child Safety

It Makes A Difference Where Your TV Stands



Congratulations on your purchase! As you enjoy your new TV, keep these safety tips in mind:

The Issue

- If you are like most consumers, you have a TV in your home. Many homes, in fact, have more than one TV.
- The home theater entertainment experience is a growing trend, and larger TVs are popular purchases; however, they are not always supported on the proper TV stands.
- Sometimes TVs are improperly secured or inappropriately situated on dressers, bookcases, shelves, desks, audio speakers, chests, or carts. As a result, TVs may fall over, causing unnecessary injury.

Toshiba Cares!

- The consumer electronics industry is committed to making home entertainment enjoyable and safe.
- The Consumer Electronics Association formed the Home Entertainment Support Safety Committee, comprised of TV and consumer electronics furniture manufacturers, to advocate children's safety and educate consumers and their families about television safety.



Tune Into Safety

- One size does NOT fit all! Use appropriate furniture large enough to support the weight of your TV (and other electronic components).
- Use appropriate angle braces, straps, and anchors to secure your furniture to the wall (but never screw anything directly into the TV).
- Carefully read and understand the other enclosed instructions for proper use of this product.
- Do not allow children to climb on or play with furniture and TVs.
- Avoid placing any item on top of your TV (such as a VCR, remote control, or toy) that a curious child may reach for.
- Remember that children can become excited while watching a program and can potentially push or pull a TV over.
- Share our safety message about this hidden hazard of the home with your family and friends. Thank you!



2500 Wilson Blvd.
Arlington, VA 22201 U.S.A.
Tel. 703-907-7600 Fax 703-907-7690
www.CE.org

CEA is the Sponsor, Producer and Manager of the International CES®

Important Safety Instructions

- 1) **Read these instructions.**
- 2) **Keep these instructions.**
- 3) **Heed all warnings.**
- 4) **Follow all instructions.**



- 5) **Do not use this apparatus near water.**



- 6) **Clean only with a dry cloth.**

- 7) **Do not block any ventilation openings.** Install in accordance with the manufacturer's instructions.

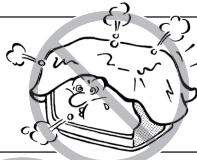

- 8) **Do not install near any heat sources** such as radiators, heat registers, stoves, or other apparatus (including amplifiers) that produce heat.

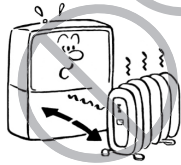

- 9) **Do not defeat the safety purpose of the polarized or grounding type plug.** A polarized plug has two blades with one wider than the other. A grounding type plug has two blades and a third grounding prong. The wide blade or the third prong are provided for your safety. If the provided plug does not fit into your outlet, consult an electrician for replacement of the obsolete outlet.

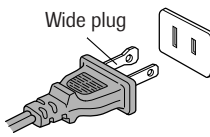

- 10) **Protect the power cord** from being walked on or pinched, particularly at plugs, convenience receptacles, and the point where it exits the apparatus.

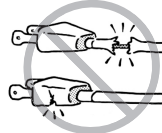

- 11) **Only use attachments/accessories specified by the manufacturer.**

- 12) **Use only with the cart, stand, tripod, bracket, or table specified by the manufacturer, or sold with the apparatus.** When a cart is used, use caution when moving the cart/apparatus combination to avoid injury from tip-over.



- 13) **Unplug this apparatus during lightning storms or when unused for long periods of time.**



- 14) **Refer all servicing to qualified service personnel.**

Service is required when the apparatus has been damaged in any way, such as power supply cord or plug is damaged, liquid has been spilled or objects have fallen into the apparatus, the apparatus has been exposed to rain or moisture, does not operate normally, or has been dropped.



- 15) **CAUTION:** To reduce the risk of electric shock, do not use the polarized plug with an extension cord, receptacle, or other outlet unless the blades can be inserted completely to prevent blade exposure.

Installation, Care, and Service

Installation

Follow these recommendations and precautions and heed all warnings when installing your TV:

- 16) Never modify this equipment. Changes or modifications may void: a) the warranty, and b) the user's authority to operate this equipment under the rules of the Federal Communications Commission.

- 17) **DANGER: RISK OF SERIOUS PERSONAL INJURY, DEATH, OR EQUIPMENT DAMAGE!** Never place the TV on an unstable cart, stand, or table. The TV may fall, causing serious personal injury, death, or serious damage to the TV.



- 18) Never place or store the TV in direct sunlight; hot, humid areas; areas subject to excessive dust or vibration; or locations with temperatures at or below 41°F (5°C).

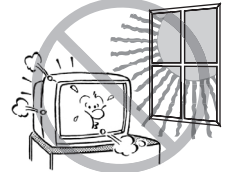

- 19) Always place the TV on the floor or a sturdy, level, stable surface that can support the weight of the unit.



- 20) Never place items such as vases, aquariums, or candles on top of the TV.



- 21) Never block or cover the slots or openings in the TV cabinet back, bottom, and sides. Never place the TV:
 - on a bed, sofa, rug, or similar surface;
 - too close to drapes, curtains, or walls; or
 - in a confined space such as a bookcase, built-in cabinet, or any other place with poor ventilation.



The slots and openings are provided to protect the TV from overheating and to help maintain reliable operation of the TV.

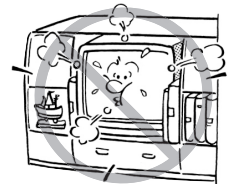

- 22) Never allow anything to rest on or roll over the power cord, and never place the TV where the power cord is subject to wear or abuse.

- 23) Never overload wall outlets and extension cords.



- 24) Always operate this equipment from a 120 VAC, 60 Hz power source only.

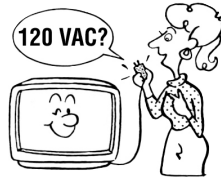

- 25) Always make sure the antenna system is properly grounded to provide adequate protection against voltage surges and built-up static charges (see Section 810 of the National Electric Code).

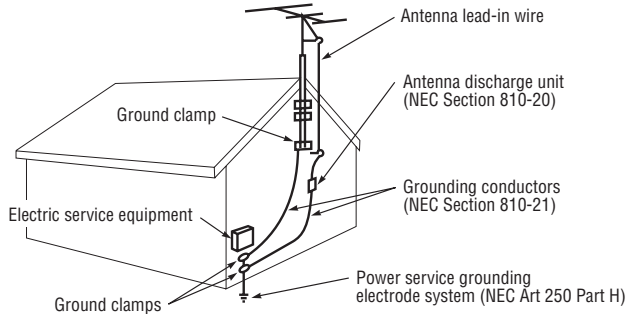

- 26) **! DANGER: RISK OF SERIOUS PERSONAL INJURY OR DEATH!**
- Use extreme care to make sure you are never in a position where your body (or any item you are in contact with, such as a ladder or screwdriver) can accidentally touch overhead power lines. Never locate the antenna near overhead power lines or other electrical circuits.
 - Never attempt to install any of the following during lightning activity:
 - a) an antenna system; or b) cables, wires, or any home theater component connected to an antenna or phone system.

Care

For better performance and safer operation of your TOSHIBA TV, follow these recommendations and precautions:

- 27) Always sit approximately 10–25 feet away from the TV and as directly in front of it as possible. The picture can appear dull if you sit too far to the left or right of the TV, or if sunlight or room lights reflect on the screen. Turn the TV off to check for reflections on the screen, and then remove the source of reflections while viewing the TV.

- 28) Always unplug the TV before cleaning. Never use liquid or aerosol cleaners.

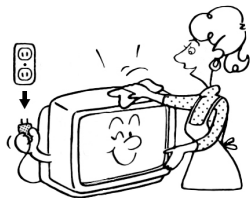

- 29) **! WARNING: RISK OF ELECTRIC SHOCK!** Never spill liquids or push objects of any kind into the TV cabinet slots.

- 30) [This item applies to projection TVs only.] If the air temperature rises suddenly (for example, when the TV is first delivered), condensation may form on the lenses. This can make the picture appear distorted or the color appear faded. If this happens, turn off the TV for 6 to 7 hours to allow the condensation to evaporate.

- 31) For added protection of your TV from lightning and power surges, always unplug the power cord and disconnect the antenna from the TV if you leave the TV unattended or unused for long periods of time.

- 32) During normal use, the TV may make occasional snapping or popping sounds. This is normal, especially when the unit is being turned on or off. If these sounds become frequent or continuous, unplug the power cord and contact a Toshiba Authorized Service Center.

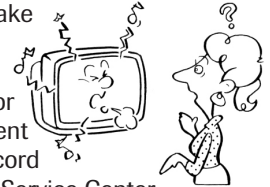

- 33) **Possible Adverse Effects on TV Picture Tube:** If a fixed (non-moving) pattern remains on the TV screen for long periods of time, the image can become permanently engrained in the picture tube and cause subtle but permanent ghost images. **This type of damage is NOT COVERED BY YOUR WARRANTY.** Never leave your TV on for long periods of time while it is displaying the following formats or images:

- **Fixed Images**, such as PIP/POP windows, stock tickers, video game patterns, TV station logos, and websites.
- **Special Formats** that do not use the entire screen. For example, viewing letterbox style (16:9) media on a normal (4:3) display (gray bars at top and bottom of screen); or viewing normal style (4:3) media on a widescreen (16:9) display (gray bars on left and right sides of screen).

Service

- 34) **! WARNING: RISK OF ELECTRIC SHOCK!** Never attempt to service the TV yourself. Opening and removing the covers may expose you to dangerous voltage or other hazards. Refer all servicing to a Toshiba Authorized Service Center.

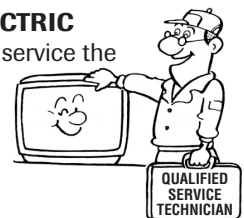

- 35) If you have the TV serviced:

- Ask the service technician to use only replacement parts specified by the manufacturer.
- Upon completion of service, ask the service technician to perform routine safety checks to determine that the TV is in safe operating condition.

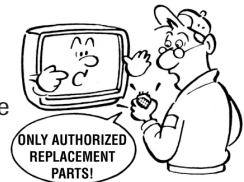

- 36) When the TV reaches the end of its useful life, ask a qualified service technician to properly dispose of the TV. Improper disposal may result in a picture tube implosion and possible personal injury.

Contents

Important safety information	2–4	Using the TV's features	18
Introduction	6	Adjusting the channel settings	18
Exploring your new TV	6	Switching between two channels	18
Selecting a location for your TV	6	Programming your favorite channels	18
Connecting your TV	7	Using the V-Chip Control (blocking) feature	19
Note regarding picture quality	7	Selecting a PIN code	19
Connecting a VCR	7	Changing your PIN code	20
Connecting a cable converter box	7	If you forget your PIN code	20
Connecting a cable converter box and a VCR	8	Blocking programs by ratings	21
Connecting a satellite receiver and a VCR	8	Ratings definitions (MPAA, Youth TV, TV)	21
Connecting a DVD player with ColorStream® (component video) and a VCR	9	Unblocking programs temporarily	22
Connecting two VCRs	9	Blocking unrated movies and programs	23
Using the remote control	10	Blocking channels	24
Preparing the remote control for use	10	Adjusting the picture	25
Installing the remote control batteries	10	Adjusting the picture quality	25
Location of controls on TV and remote control	11	Selecting the color temperature	25
Programming the remote control to operate a cable converter box, satellite receiver, VCR, DVD player, or HTIB (home theater in a box)	12	Selecting the picture preference	26
Remote control codes	12–13	Displaying on-screen information	26
Using the remote control to operate a cable converter box, satellite receiver, VCR, DVD player, or HTIB (home theater in a box)	14	Setting the off timer	26
Setting up your TV	15	Auto power off	26
Menu system (general instructions)	15	Using the closed caption feature	27
Changing the on-screen display language	16	Adjusting the sound	28
Selecting the signal source	16	Muting the sound	28
Programming channels into the TV's memory	16	Selecting stereo/SAP broadcasts	28
Programming channels automatically	16	Adjusting the sound quality	29
Adding and erasing channels manually	17	Using the surround sound feature	29
Changing channels	17	Viewing the demonstration (DEMO) mode	30
		Understanding the last mode memory feature	30
		Appendix	31
		Specifications	31
		Troubleshooting	32
		Limited United States warranty	33
		Limited Canada warranty	34

Introduction

- This owner's manual applies to models 32A33, 32A43, and 36A43, and there are slight differences among them.
- Model 32A43 is used in this manual for illustration purposes.
- Instructions in this manual are based on using the remote control; however, you can use the buttons on the front panel of the TV if they have the same name as those referred to on the remote control.
- Check the model number on the back of your TV before using this manual. Write your model and serial numbers in the space provided on the front cover of this manual for your records.

Exploring your new TV

- You can operate your TV using the buttons on the front panel or remote control.
- The back panel provides all the inputs you will need to connect other equipment to your TV. Models 32A43 and 36A43 have additional audio/video inputs on the front panel (referred to as "VIDEO-3").

Front of TV

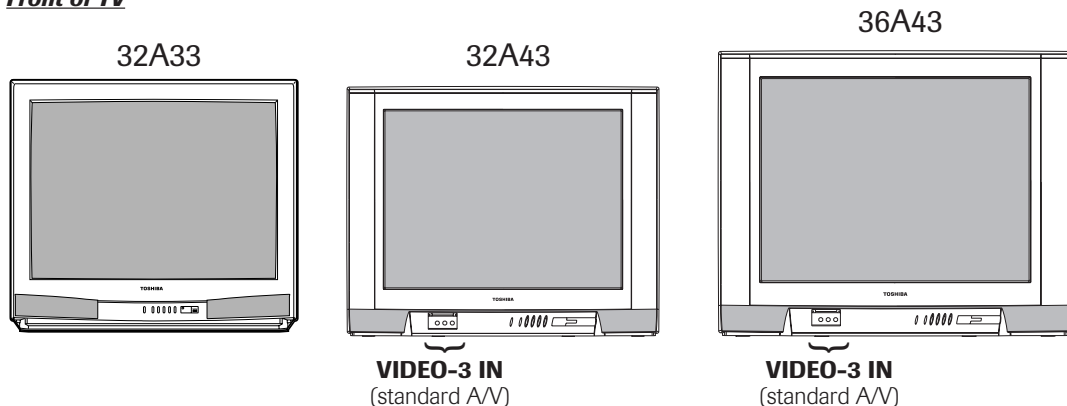

Back of TV

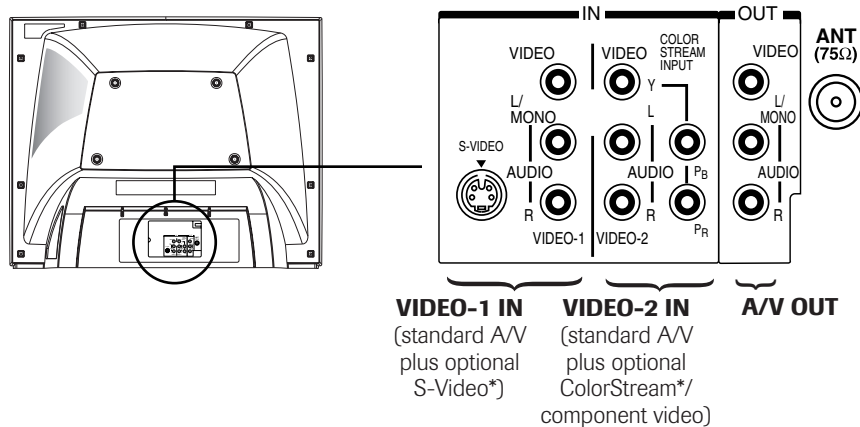

*If you use an S-Video cable with a VIDEO-1 connection or a set of component video cables with a VIDEO-2 connection, you will need to disconnect the respective standard video cable or the picture performance will be unacceptable.

Selecting a location for your TV

- Place the TV either on the floor or on the TV stand listed in the "Specifications" section.
- Place the TV in a location where light does not directly hit the screen.
- Place the TV far enough from the walls to allow proper ventilation. Inadequate ventilation may cause overheating, which can damage the TV.

Before installing your TV, please read the important safety information on pages 2–4.

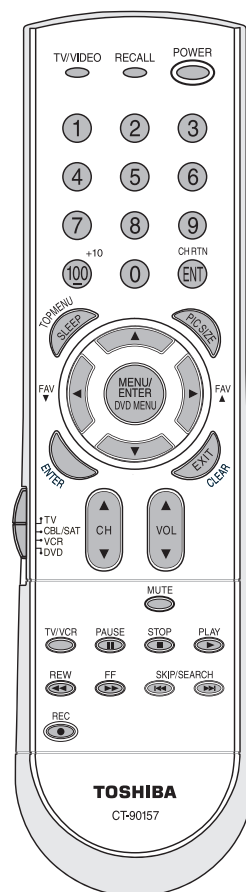

Connecting your TV

Note: Cables are not supplied with your TV.

- **Coaxial cable** is the cable that comes in from your antenna, cable TV service, or cable converter box. Coaxial cable uses "F" connectors.
- **Standard stereo A/V cables** usually come in sets of three, and are typically color-coded according to use: yellow for video, red for stereo right audio, and white for stereo left (or mono) audio. Your TV's standard A/V inputs are color-coded in the same manner as the cables.
- **S-Video cable** is for use with video equipment that has S-Video connectors.
- **Component video cables** come in sets of three (typically color-coded green, blue, and red), and are for use with video equipment that has component video connectors. Your TV's ColorStream® (component video) inputs are color-coded yellow, blue, and red. Plug the green component video cable into the yellow VIDEO-2 input (see "Back of TV" on page 6).

NOTE REGARDING PICTURE QUALITY

When connecting video equipment to your Toshiba TV:

- **For GOOD picture quality:** Use a standard yellow video cable.
- **For BETTER picture quality:** If your equipment has S-video connectors, use an S-video cable *instead of* a standard yellow video cable. You still must connect the standard red and white audio cables for full system connection, but *do not connect a standard yellow video cable at the same time* or the picture performance will be unacceptable.
- **For BEST picture quality:** If your equipment has component video connectors, use component video cables *instead of* a standard yellow video cable or S-video cable. You still must connect the standard red and white audio cables for full system connection.

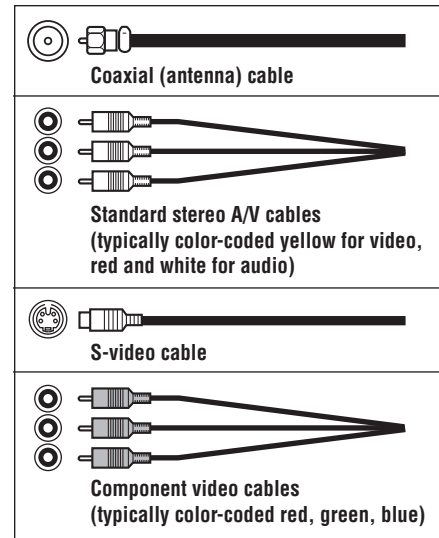

CAUTION: Do not plug in any power cords until you have finished connecting all equipment.

Connecting a VCR

With this connection you can:

- watch local TV channels and videotapes
- record one channel while watching the same or another channel

You will need:

- two coaxial cables
- one set of standard A/V cables (If your VCR has S-video, you can use an S-video cable instead of the standard video cable. See "Note Regarding Picture Quality" above.)

Note:

If you have a mono VCR, connect L/Mono to VCR Audio OUT using only one audio cable.

The VIDEO-2 inputs on the back of the TV can be used for connecting a second piece of video equipment such as a DVD player. The VIDEO-3 inputs* on the front of the TV can be used for connecting a third piece of video equipment such as a camcorder. See "Note Regarding Picture Quality" above.

*Model 32A33 does not have VIDEO 3 inputs.

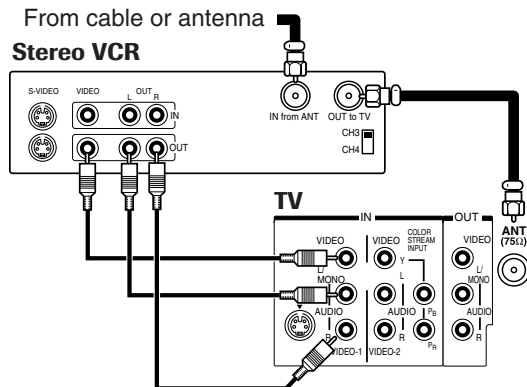

Connecting a cable converter box

With this connection you can:

- watch basic and premium cable channels

Tune the TV to channel 3 or 4 (whichever channel is vacant in your area), and then use the cable converter box to change channels.

You will need:

- two coaxial cables

Note:

When you use a cable converter box with your TV, you may not be able to use the remote control to program certain features (for example, blocking channels).

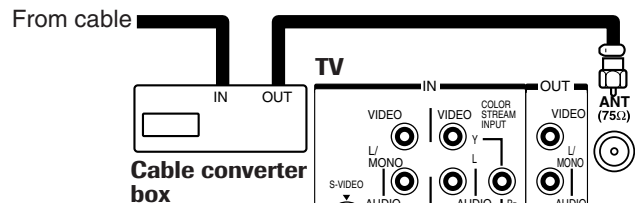

The unauthorized recording, use, distribution, or revision of television programs, videotapes, DVDs, and other materials is prohibited under the Copyright Laws of the United States and other countries, and may subject you to civil and criminal liability.

Connecting a cable converter box and a VCR

With this connection you can:

- watch videotapes
- watch and record basic and premium cable channels
- record one channel while watching the same or another non-premium channel

Tune the VCR to channel 3 or 4 (whichever channel is vacant in your area), place the TV in VIDEO 1 mode, and then use the converter box to change channels.

You will need:

- one cable signal splitter
- four coaxial cables
- one set of standard A/V cables (If your VCR has S-video, you can use an S-video cable instead of the standard video cable. See “Note Regarding Picture Quality” on page 7.)

Note:

If you have a mono VCR, connect TV L/Mono Audio IN to VCR Audio OUT using only one audio cable.

When you use a cable converter box with your TV, you may not be able to use the remote control to program certain features (for example, blocking channels).

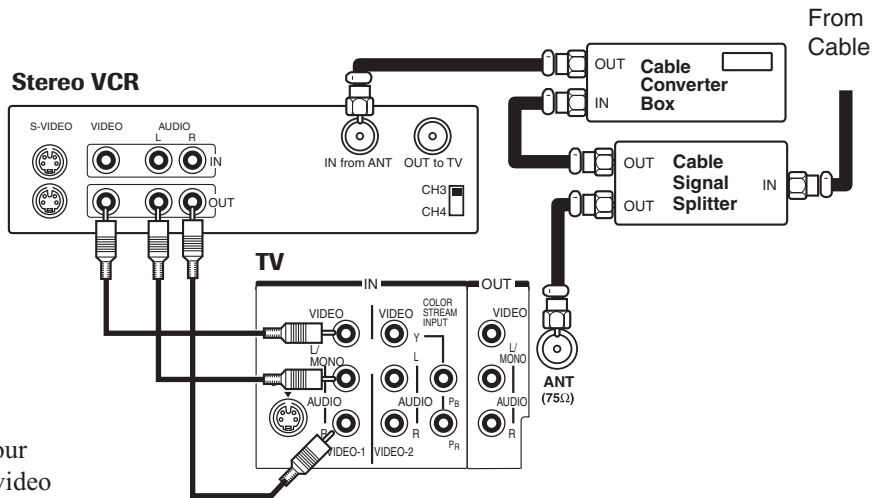

The unauthorized recording, use, distribution, or revision of television programs, videotapes, DVDs, and other materials is prohibited under the Copyright Laws of the United States and other countries, and may subject you to civil and criminal liability.

Connecting a satellite receiver and a VCR

With this connection you can:

- watch videotapes
- watch satellite and TV channels

You will need:

- three coaxial cables
- two sets of standard A/V cables (If your satellite receiver has S-video, you can use an S-video cable from the satellite receiver instead of the standard video cable. See “Note Regarding Picture Quality” on page 7.)

Note:

To watch satellite programs, the TV must select VIDEO-1 (see “Selecting the signal source” on page 16).

To watch VCR programs, the TV must select VIDEO-2 (see “Selecting the signal source” on page 16).

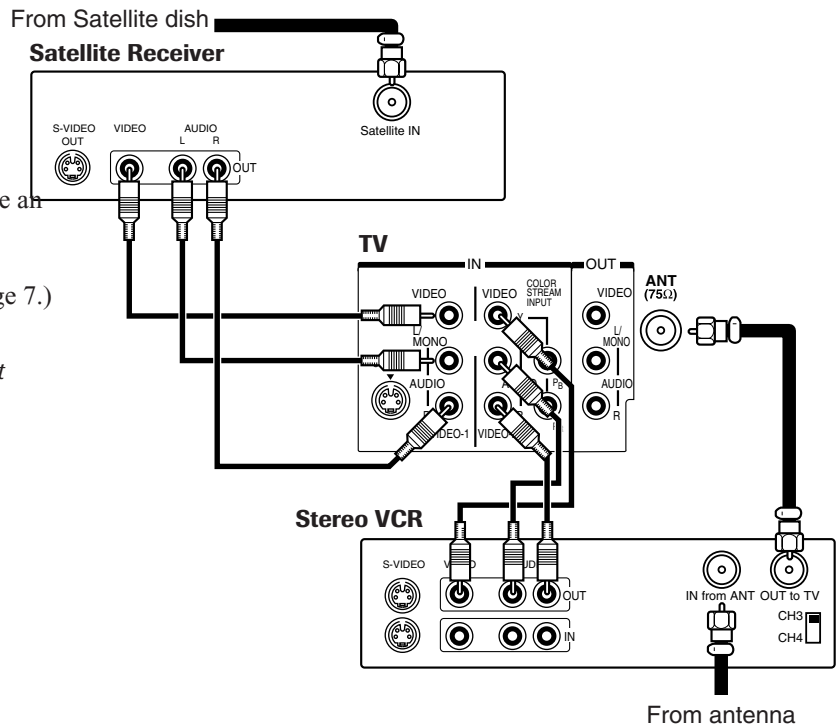

Connecting a DVD player with ColorStream® (component video) and a VCR

Your TV has ColorStream® (component video) inputs. Connecting your TV to a DVD player with component video (such as a Toshiba DVD player with ColorStream®) can greatly enhance picture quality and performance.

With this connection you can:

- watch TV channels, DVDs, and videotapes
- record TV channels
- record one channel while watching the same or another channel

You will need:

- two coaxial cables
- one set of standard A/V cables from the VCR (If your VCR has S-video, you can use an S-video cable instead of the standard video cable. See “Note Regarding Picture Quality” on page 7.)
- one set of component video cables from the DVD player
- one pair of standard audio cables from the DVD player

Note:

To watch the VCR, the TV must select VIDEO 1 (see page 16).

To watch the DVD player, the TV must select VIDEO 2 (see “Selecting the signal source” on page 16).

The ColorStream inputs on the TV are for use with DVD players with 480i interlaced scanning only. If you have a 480p progressive scan DVD player, **you must switch the DVD player to 480i interlaced mode first**, and then connect it to the TV's ColorStream inputs. Failure to do this will cause a poor picture or no picture to display.

You can connect a high-definition set-top receiver only if the output is switched to 480i interlaced mode first. **This TV will not accept or display 480p or 720p progressive scan signals or 1080i interlaced high-definition signals.**

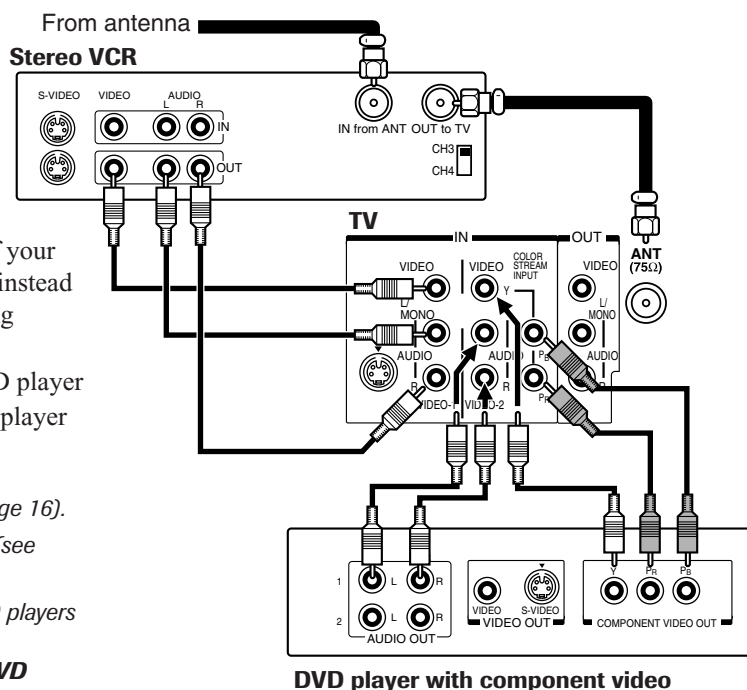

The unauthorized recording, use, distribution, or revision of television programs, videotapes, DVDs, and other materials is prohibited under the Copyright Laws of the United States and other countries, and may subject you to civil and criminal liability.

Connecting two VCRs

With this connection you can:

- watch TV channels and videotapes
- record TV channels
- record one TV channel while watching the same or another channel
- record (dub/edit) from one VCR to the other VCR while watching a videotape

You will need:

- two coaxial cables
- two sets of standard A/V cables (If VCR1 has S-video, you can use an S-video cable between VCR1 and the TV instead of the standard video cable. See “Note Regarding Picture Quality” on page 7.)

Note:

Do not connect the same VCR to both the OUT and the IN connections on the TV at the same time.

To record (dub/edit) from VCR 1 to VCR 2, the TV must select VIDEO 1 (see page 16), and VCR 2 must select LINE IN.

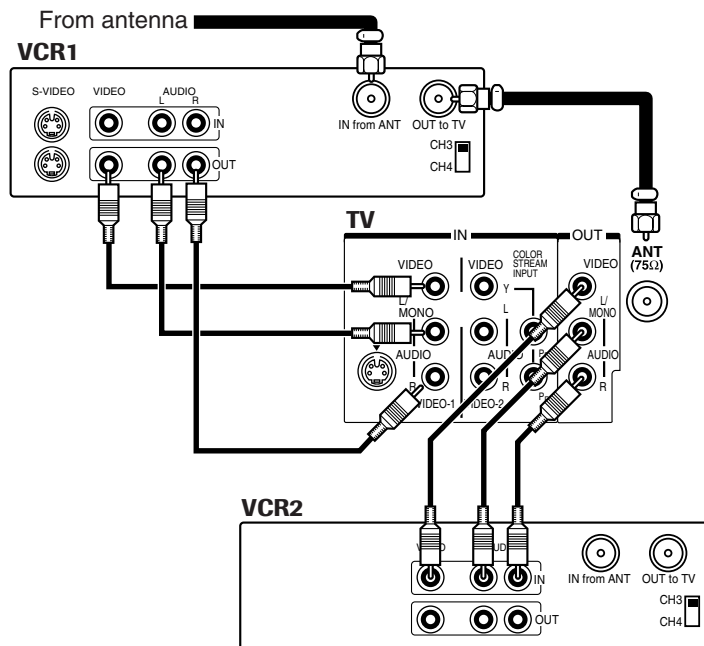

Using the remote control

Preparing the remote control for use

Your TV remote control can operate your TV and most cable converter boxes, satellite receivers, VCRs, DVD players, and HTIBs (home theater in a box), even if they are different brands.

If you have a Toshiba device:

Your TV remote control is preprogrammed to operate most Toshiba devices. See page 14.

If you have a non-Toshiba device or a Toshiba device that the remote control is not preprogrammed to operate:

You can program the TV remote control so it will operate the other device. See pages 12–14.

Installing the remote control batteries

- 1 Remove the battery cover from the back of the remote control.

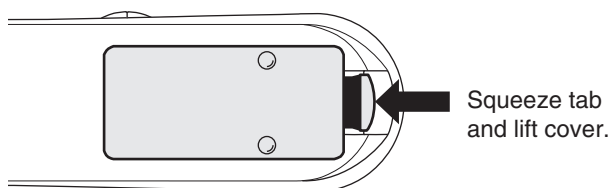

Caution:

Dispose of batteries in a designated disposal area. Do not throw batteries into a fire.

Do not mix battery types or combine used batteries with new ones.

Remove dead batteries immediately to prevent battery acid from leaking into the battery compartment.

If you do not intend to use the remote control for a long time, remove the batteries.

- 2 Install two “AA” size batteries, making sure to match the + and – signs on the batteries to the signs on the battery compartment.

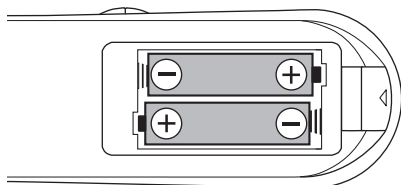

Note:

If your Toshiba TV remote control does not operate all the features of your other device, use the original remote control for that device.

- 3 Reinsert the battery cover in the remote control until the tab snaps.

Location of controls on TV and remote control

For details on the use of each control, refer to pages in brackets.

TV front panel

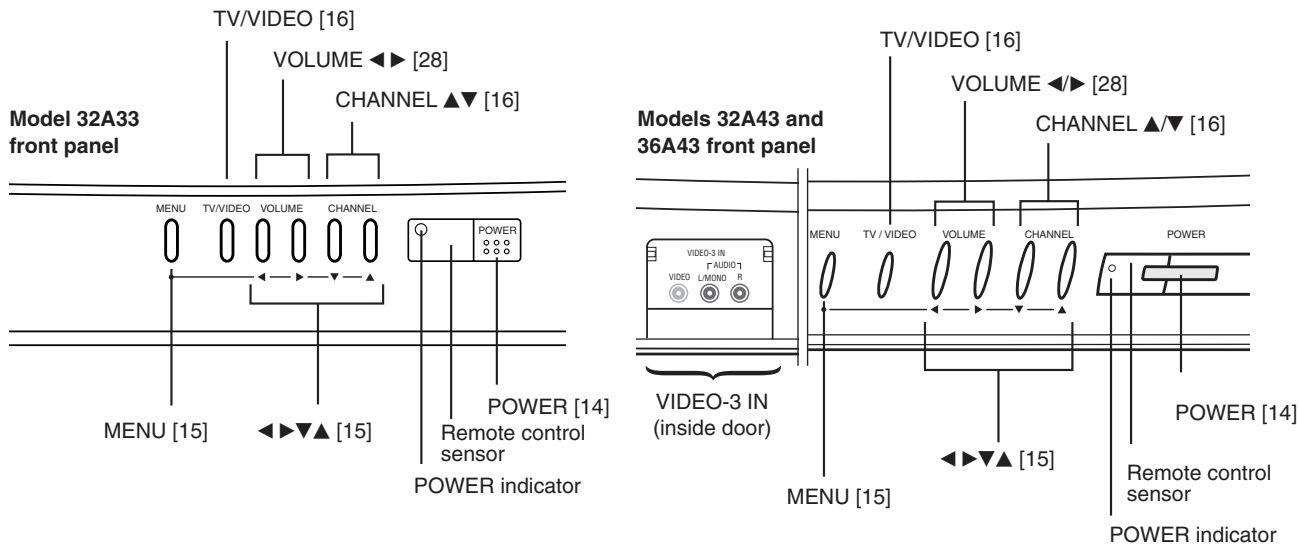

Remote control

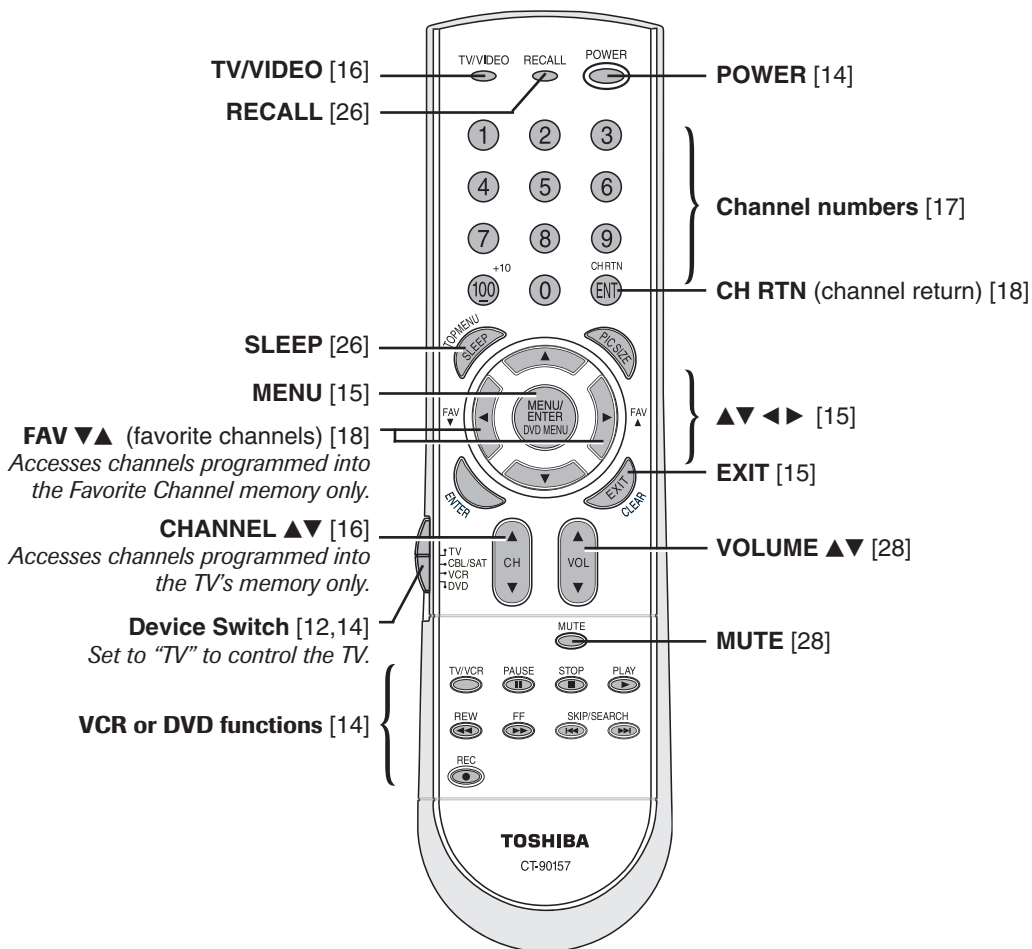

Programming the remote control to operate a cable converter box, satellite receiver, VCR, DVD player, or HTIB (home theater in a box)

Your Toshiba TV remote control is preprogrammed to operate most Toshiba devices. To program your TV remote control to operate a non-Toshiba device (or a Toshiba device that it is not preprogrammed to operate), follow the steps below. For details on using the remote control to operate the device, see page 14.

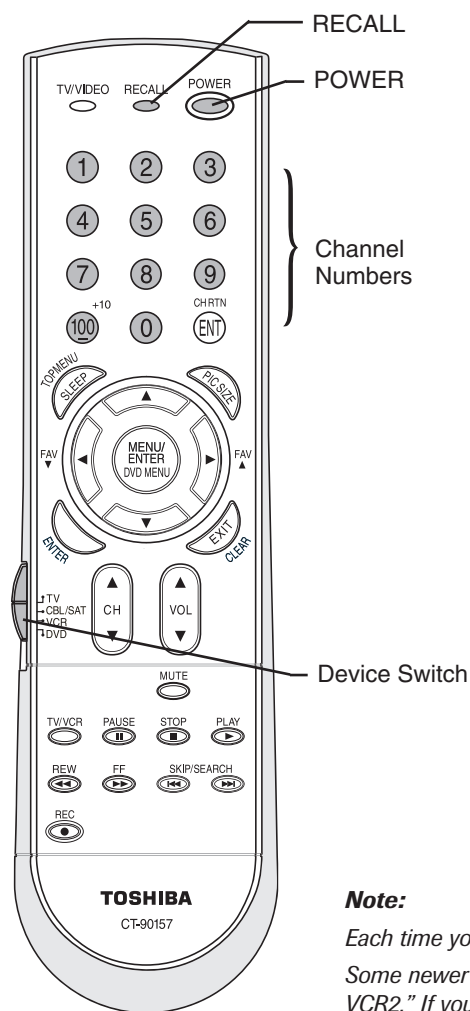

Using the Remote Control

- 1 In the remote control code table (below and on the next page), find the code for your device. If more than one code is listed, try each one separately until you find one that works.
- 2 Set the **Device Switch** to the type of device you are programming the remote control to operate—**CBL/SAT** (for a cable converter box or satellite receiver), **VCR** (for a VCR or TV/VCR combo), or **DVD** (for a DVD player or HTIB [home theater in a box]).
- 3 While holding down **RECALL**, press the **Channel Number** buttons to enter the 3-digit code for your device.
- 4 To test the code, turn on the device, point the remote control at it, and press **POWER**.
 - If the correct code was entered, the device will turn off.
 - If the device does not respond, repeat steps 1–4 using another code.
 - If the device does not respond to another code, you will need to use the remote control that came with the device.
- 5 Remember to set the **Device Switch** back to “TV” to control the TV.
- 6 For future reference, write down the code(s) you used:

DEVICE	CODE	DEVICE	CODE

Note:

Each time you change the batteries, you will need to reprogram the remote control. Some newer VCRs respond to either of two codes. These VCRs have a switch labeled “VCR1/VCR2.” If your VCR has this kind of switch and does not respond to the codes for your VCR brand, set the switch to the other position (“VCR1” or “VCR2”) and reprogram the remote control.

Remote control codes

In some cases you may not be able to operate your device with the TV remote control. Your other device may use a code that is not recognized by the TV remote control. If this happens, you will need to use the remote control provided with the device.

Cable converter box

ABC: 061, 062, 063, 082, 084, 087, 091, 092, 096, 098
 Archer: 065, 092, 097, 099
 Cableview: 064, 094
 Century: 092
 Citizen: 090, 092, 097
 Contec: 083, 085, 086, 088, 093, 098
 Diamond: 093
 Eagle: 091
 GE: 061, 062
 Gemini: 069, 070, 094

General Instruments: 062, 089, 096
 Hamlin: 093
 Hitachi: 062, 095, 096
 Jasco: 097
 Jerrold: 062, 069, 071, 082, 086, 089, 091, 096
 Magnavox: 072, 096
 Memorex: 091, 092, 104
 Multi Canal: 090
 Novavision: 101
 Panasonic: 081, 083, 085
 Philco: 087

Philips: 066, 067, 068, 070, 072, 073, 074, 075, 091, 092
 Pioneer: 076, 077
 Proscan: 061, 062
 Radio Shack: 092, 097, 099
 RCA: 064, 081
 Realistic: 065
 Recoton: 102
 Samsung: 077, 090
 Scientific Atlanta: 063, 078, 079, 080, 085, 098, 101, 105

Sears: 095
 Signature: 062
 Signature 2000: 096
 Sprucer: 081, 085
 Starcom: 069, 082, 087, 096, 103, 104
 Stargate: 069, 090
 Sylvania: 095, 100
 TeleView: 090
 Texscan: 100
 Tocom: 071, 084, 085
 U. S. Electronics: 087, 096, 098
 United Cable: 082

Universal: 065, 092, 097, 099, 102, 103
 Wards: 096

Satellite receiver

Alphastar: 038, 059
 Chaparral: 034
 DISH Network: 057
 Drake: 020, 040, 044, 046, 050, 053
 Echostar: 018, 041, 051
 Express Vu: 057
 Fujitsu: 027
 GE: 008, 009, 013

Remote control codes (cont.)

Satellite receiver (cont.)

General Instruments: 010, 011, 012, 022, 023, 031, 049
Hitachi: 033
Hughes: 033
Hughes Network Systems: 019
Intersat: 048
Janeil: 027
JVC: 017, 057
Kenwood: 029
Magnavox: 060
Optimus: 058
Pansat: 036, 052
Primestar: 015, 042
Proscan: 008, 009, 013
Radio Shack: 022, 023, 030
RCA: 008, 009, 013, 016
Realistic: 030
Samsung: 059
Sony: 014, 055
Star Choice: 057
Star Trak: 025, 026, 037, 054
STS: 024
Toshiba: 000, 001, 002, 003, 004, 005, 006, 007, 020, 031, 056
Uniden: 021, 028, 030, 032, 035, 039, 043, 045, 047, 058
Zenith: 027

TV/VCR Combo

Action: 078
GE: 059, 062
Goldstar: 065
Panasonic: 065
Precision: 078
Quasar: 065
Realistic: 079
Sony: 074
Toshiba: 057
Zenith: 065

DVD/VCR Combo

Go Video:
DVD=087, VCR=081
JVC:
DVD=088, VCR=082
RCA:
DVD=089, VCR=083
Samsung:
DVD=090, VCR=084
Sanyo:
DVD=091, VCR=085
Zenith:
DVD=092, VCR=086

DVD player

Aiwa: 006, 015
Apex: 016, 017
BOSE: 097
Broksonic: 018
Clarion: 019
Classic: 020
Daewoo: 021
Denon: 022, 023, 024, 025
Emerson: 026, 027
Fisher: 028
Funai: 027
GE: 001, 029, 030
Go Video: 087
GPX: 031
Hitachi: 005, 032, 033, 034, 035
JVC: 003, 007, 036, 042, 088
Kenwood: 037
Konka: 008, 009
Magnavox: 004, 038
Memorex: 039
Mintek: 040
NAD: 026
Nakamichi: 041
Norcent: 043
Onkyo: 044
Oritron: 058
Panasonic: 010, 045, 046, 047, 048, 049, 050
Philips: 004, 051
Pioneer: 052, 053, 054, 055
Proscan: 001, 056
Qwestar: 057, 058
RCA: 001, 002, 059, 089
Sampo: 060
Samsung: 061, 062, 086, 090
Sansui: 073
Sanyo: 063, 091
Sharp: 064, 067
Sherwood: 074
Sony: 011, 012, 065, 066, 068, 069, 070
Sylvania: 027
Teac: 071
Technics: 072
Techwood: 075
Toshiba: 000, 013, 076, 077, 078
Yamaha: 079, 080, 081
Zenith: 014, 082, 092

Portable DVD player

Aiwa: 093
Audiovox: 094, 095
Panasonic: 024, 096, 099
RCA: 098

VCR

Admiral: 049
Aiko: 019
Aiwa: 018
Akai: 003, 004, 037, 038, 039, 058, 069
Audiovox: 010
Bell & Howell: 007, 068
Broksonic: 008, 017
Calix: 010
Carver: 026
CCE: 019
Citizen: 009, 010, 011, 012, 013, 014, 015, 019, 057, 073
Colortyme: 005
Craig: 009, 010, 016, 061, 065, 079
Curtis Mathes: 001, 005, 009, 012, 014, 040, 048, 053, 056, 057
Daewoo: 011, 013, 015, 017, 018, 019, 057, 078
Daytron: 078
Denon: 063
Dimensia: 001, 048
Electrohome: 010, 020, 065
Emerson: 003, 008, 010, 011, 017, 018, 020, 028, 039, 054, 057, 062, 065, 068, 072
Fisher: 007, 016, 021, 022, 023, 057, 064, 068, 070, 071, 079
Fuji: 004, 041
Funai: 018, 073
Garrard: 018
GE: 001, 002, 009, 040, 042, 048, 056
Go Video: 056, 059, 061, 081
Goldstar: 005, 010, 014, 054, 056, 065, 067
Gradiente: 018, 065
Harman Kardon: 005
Hitachi: 024, 025, 035, 037, 042, 063, 070, 080
JBL: 076
JC Penney: 005, 006, 007, 008, 009, 010, 023, 024, 025, 026, 035, 056, 061, 063, 065
Jensen: 024, 025, 037, 050
JVC: 005, 006, 007, 014, 037, 043, 050, 062, 063, 068, 082
Kenwood: 005, 006, 007, 012, 014, 037, 043, 050, 053, 068, 071

Kodak: 010
LG: 010
Lloyds: 053, 073, 079
Logik: 061
LXI: 010
Magnasonic: 061, 065, 078
Magnavox: 026, 027, 034, 044, 057, 061, 072
Marantz: 005, 006, 007, 012, 014, 026, 053, 067
Memorex: 007, 009, 010, 016, 018, 034, 049, 063, 065, 066, 068, 075, 079
MGA: 020, 028, 039
MGN: 056
Minolta: 024, 025, 035, 063
Mitsubishi: 020, 024, 025, 028, 039, 043, 065
Montgomery Ward: 049
Motorola: 049
MTC: 009, 046, 061
Multitech: 009, 012, 018
NEC: 005, 006, 007, 012, 014, 037, 043, 053, 054, 067, 070
Nikko: 010
Noblex: 009
Optimus: 010, 049, 065
Optonica: 031
Orion: 054, 057, 062, 065, 068, 072
Panasonic: 036, 045, 046, 057, 061, 072, 079
Pentax: 012, 024, 025, 035, 042, 053, 063
Pentax Research: 014
Philco: 026, 027, 063
Philips: 026, 031, 044, 057
Pioneer: 006, 024, 043, 055
Portland: 012, 013, 015
Proscan: 001, 002, 048
Proton: 061
Quasar: 045
Radio Shack: 010, 031, 065
Radio Shack/Realistic: 007, 009, 010, 016, 018, 020, 021, 022, 031, 049
Radix: 010
RCA: 001, 002, 003, 009, 024, 025, 029, 035, 040, 042, 045, 048, 055, 056, 063, 071, 083
Realistic: 007, 009, 010, 011, 016, 018, 020, 021, 022, 031, 049, 051, 056, 060, 065, 075, 079

Ricoh: 047
Runco: 034
Samsung: 009, 011, 038, 056, 073, 084
Sansui: 006, 037, 043, 061
Sanyo: 007, 009, 016, 054, 064, 068, 071, 075, 079, 085
Scott: 008, 011, 017, 028, 030, 057, 065, 072
Sears: 007, 010, 016, 021, 022, 023, 024, 025, 035, 053, 057, 063, 064, 065, 068, 071, 075, 079
Sharp: 013, 020, 031, 049, 051, 060, 066
Shintom: 004, 025, 032, 061
Signature: 049
Signature 2000: 075
Singer: 047, 061
Sony: 004, 032, 033, 041, 052, 058, 070, 074, 076, 077, 080
STS: 035
Sylvania: 018, 026, 027, 028, 044, 072
Symphonic: 018, 050, 051, 053, 073, 079
Tandy: 007
Tashiko: 010
Tatung: 037
Teac: 018, 029, 037
Technics: 036
Teknika: 010, 018, 065
Toshiba: 057, 011, 021, 023, 024, 028, 030, 039, 074, 078, 079, 000
Totevision: 009, 010, 065
Unitech: 073
Unitech: 009
Vector Research: 005, 006, 011, 012, 053
Video Concepts: 005, 006, 011, 012, 039, 053
Wards: 009, 010, 011, 016, 018, 020, 024, 025, 031, 035, 049, 051, 056, 057, 060, 065, 066, 079
White Westinghouse: 073
XR-1000: 018
Yamaha: 005, 006, 007, 014, 037, 053
Zenith: 004, 032, 034, 041, 047, 069, 086

HTIB

Lasonix: 083
Panasonic: 084
Venturer: 085

Using the remote control to operate a cable converter box, satellite receiver, VCR, DVD player, or HTIB (home theater in a box)

If you have a non-Toshiba device or a Toshiba device that the remote control is not preprogrammed to operate, you must first program the remote control to recognize the device (if you have not already done so). See pages 12 and 13.

To use your TV remote control to operate a:

- cable converter box or satellite receiver, set the **Device Switch** to CBL/SAT.
- VCR, set the **Device Switch** to VCR.
- DVD player or HTIB, set the **Device Switch** to DVD.

Note:

- Even after the TV remote control is programmed, it may not operate certain features on your other device. If this happens and you wish to use those features, you will need to use the device's original remote control.
- This illustration describes typical external device functions (not TV functions). The buttons on this remote control may or may not work as described for your specific device.

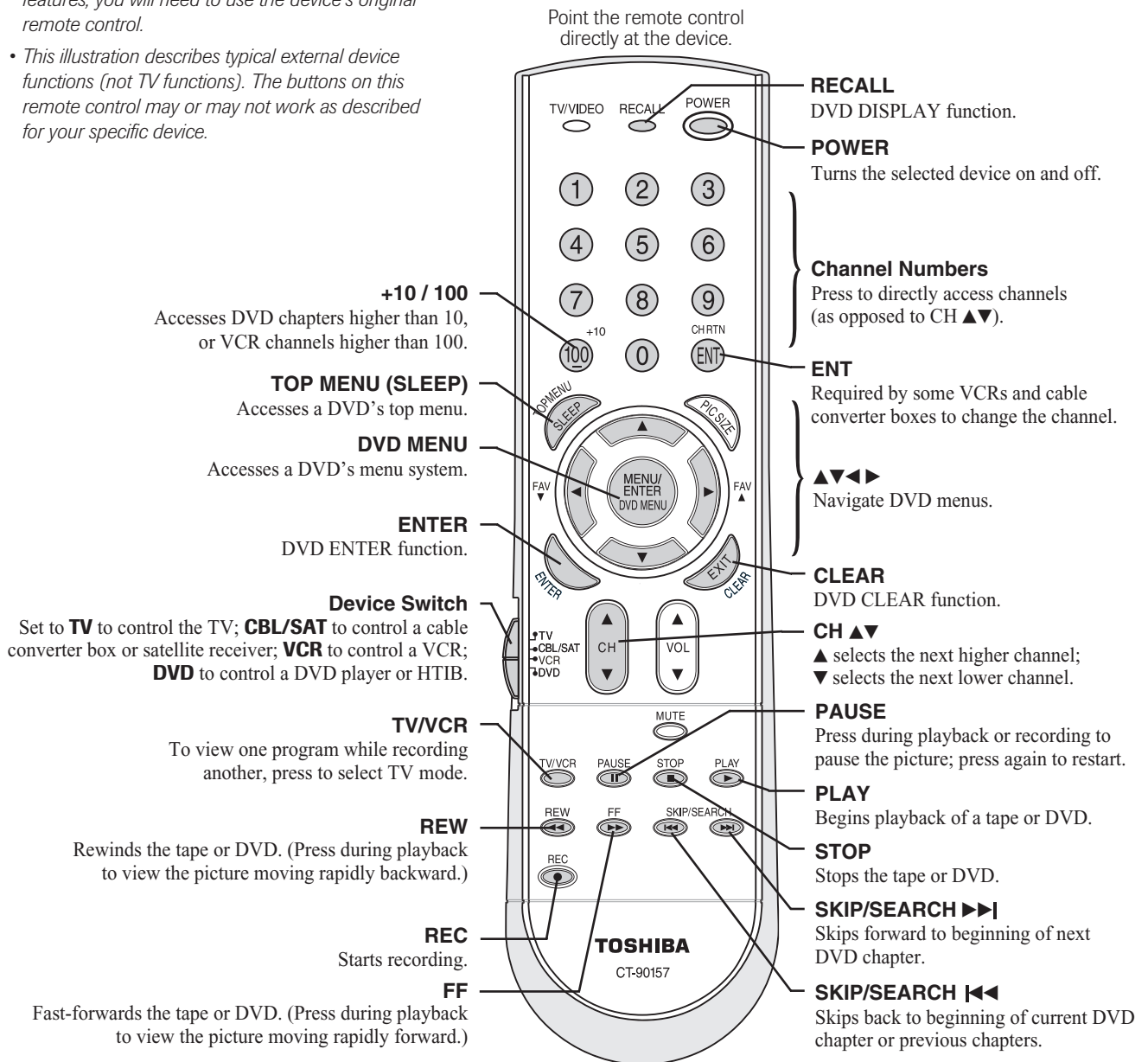

Setting up your TV

Menu system (general instructions)

After installing the batteries and programming the remote control, you will need to set some preferences on your TV using the menu system.

You can access the menus using the buttons on the TV front panel or remote control. Following are general instructions for using the menu system:

1. Press **MENU** and then ◀ or ▶ to select a menu (Picture, Audio, Setup, Preference, or Closed Caption, as shown in the menu system overview, below).
2. Press ▲ or ▼ to select the function you want to adjust in the menu.
3. Press ◀ or ▶ to adjust the selected function.

Note: The ◀▶ buttons function as FAV ▲▼ (favorite channel) buttons when no menu is on-screen.
4. When you make a menu selection, your changes occur immediately. You do not have to press **MENU** or **EXIT** to save your changes.

Note: The TV front panel does not have an EXIT button.
5. On-screen menus close automatically if no adjustments are made within 15 seconds. To close an on-screen menu instantly, press **EXIT** on the remote control.

TV Front Panel

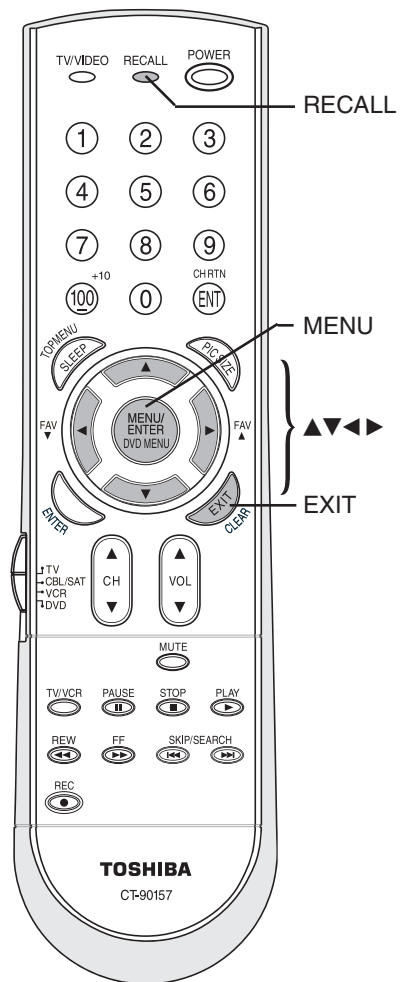
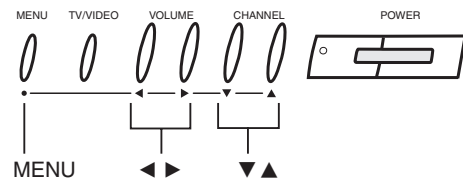

Menu system overview

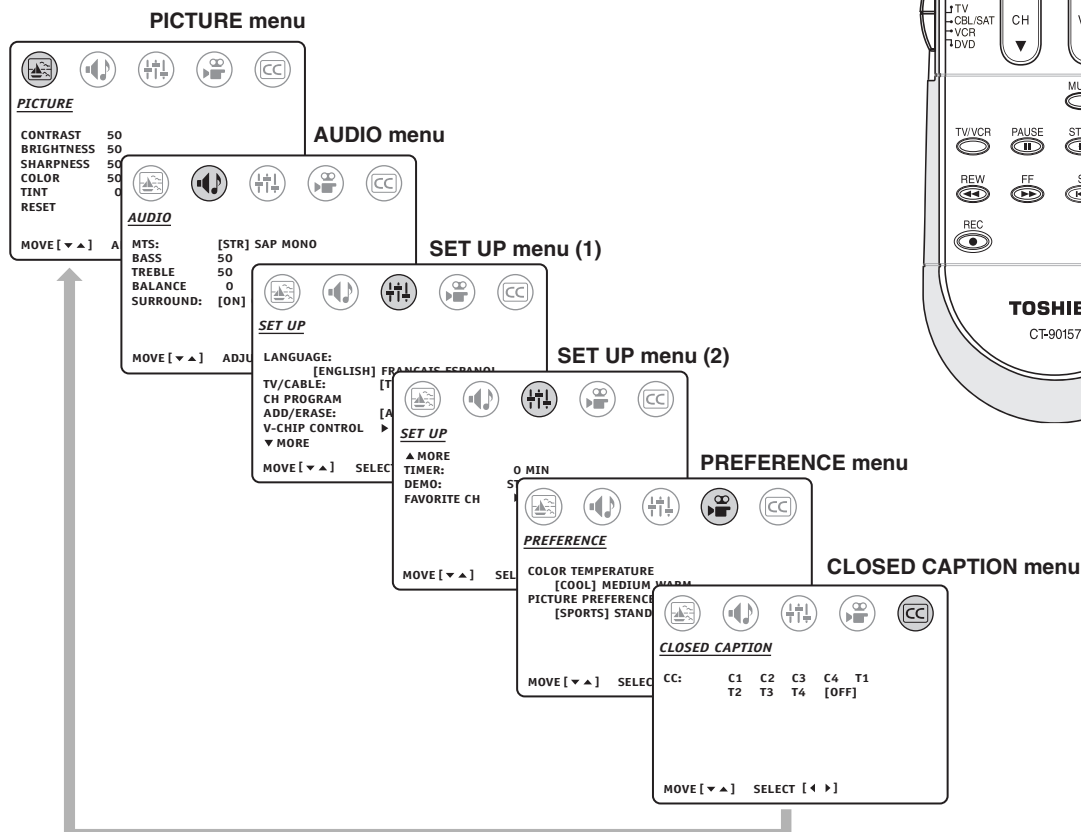

Changing the on-screen display language

You can choose from three different languages (English, French, or Spanish) for the on-screen display of menus and messages.

To select an on-screen display language:

1. Press **MENU**.
2. Press ◀ or ▶ until the SET UP menu appears.
3. Press ▲ or ▼ to highlight LANGUAGE.
4. Press ◀ or ▶ to highlight your desired language.

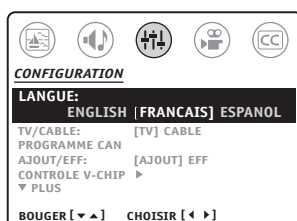
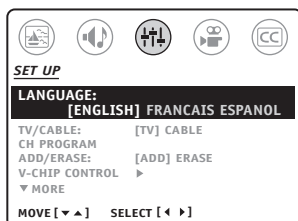

Selecting the signal source

You can use the **TV/VIDEO** button on the remote control or TV to select the signal source connected to your TV.

To change the signal source:

Repeatedly press **TV/VIDEO** to select either TV, VIDEO 1, VIDEO 2, or VIDEO 3 (32A43 and 36A43 only). The selected signal source is highlighted on-screen.

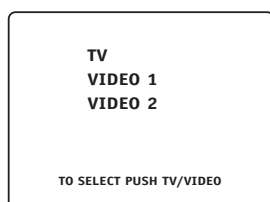

32A33

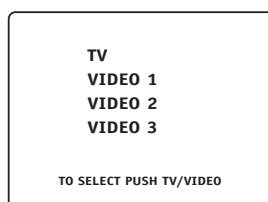

32A43 and 36A43

To verify the signal source:

Press **RECALL**.

Programming channels into the TV's memory

When you press **CHANNEL ▲▼** on the TV or remote control, the TV stops only on the channels stored in the TV's memory.

Note: To tune the TV to a channel not programmed into the memory, use the **CHANNEL NUMBERS** on the remote control.

Follow the steps below and on the next page to program channels into the TV's memory.

Programming channels automatically

Your TV can automatically detect all active channels in your area and store them in the TV's memory. After the channels are stored automatically, you can manually add or erase individual channels (see page 17).

To program channels automatically:

1. Press **MENU**.
2. Press ◀ or ▶ to highlight the SET UP menu.

TV Front Panel

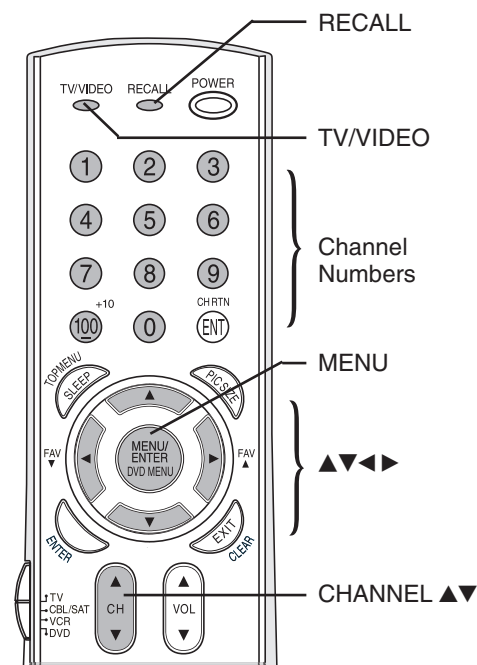
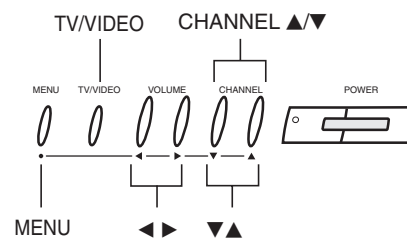

- Press ▲ or ▼ to highlight TV/CABLE.
- Press ◀ or ▶ to highlight TV (if you use an antenna) or CABLE (if you use cable).
- Press ▼ to highlight CH PROGRAM.

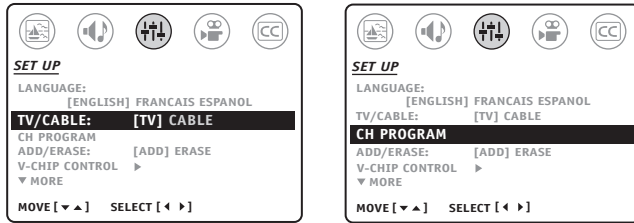

- Press ◀ or ▶ to start automatic channel programming (“CH PROGRAM” displays on-screen). The TV automatically cycles through every TV or cable channel (depending on which you selected), and stores all active channels in the TV’s memory.
- When automatic channel programming is complete, the message “CH Programming Completed” appears.
- Press **CHANNEL ▲▼** to view the programmed channels.

Adding and erasing channels manually

After you have automatically programmed the channels into the TV’s memory, you can manually add and erase individual channels.

To add or erase a channel in the TV’s memory:

- Tune the TV to the channel you want to add or erase. If you are adding a channel, you will need to use the **CHANNEL NUMBERS** to select the channel.
- Press **MENU**.
- Press ◀ or ▶ to highlight the SET UP menu.
- Press ▲ or ▼ to highlight ADD/ERASE.

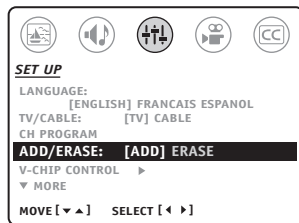

- Press ◀ or ▶ to highlight ADD or ERASE, whichever function you want to perform.
- Press **MENU**.
- Repeat steps 1–6 for other channels you want to add or erase, or press **EXIT** to return to normal TV viewing.

Changing channels

To change to the next programmed channel:

Press **CHANNEL ▲▼**.

To change to a specific channel (programmed or unprogrammed):

Press the **CHANNEL NUMBERS** (0–9 and 100).

Note: For channels 100 and higher, press the 100 button, and then the next two channel numbers (for example, to select channel 100, press 100 - 0 - 0; to select channel 125, press 100 - 2 - 5).

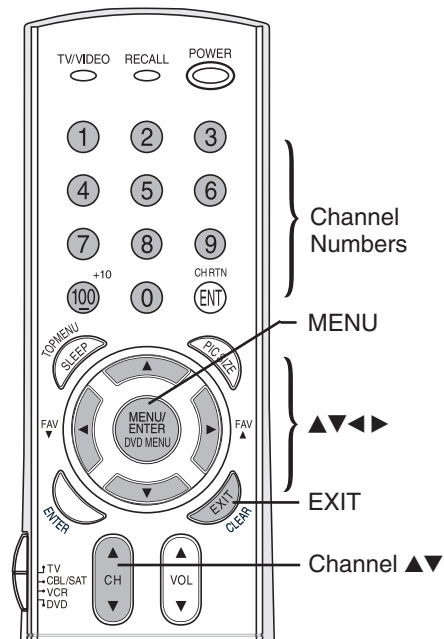

Using the TV's features

Adjusting the channel settings

Switching between two channels

To switch between two channels without entering a channel number:

1. Select the first channel you want to view.
2. Select a second channel using the **CHANNEL NUMBERS** (0–9 and 100).
3. Press **CH RTN** (channel return). The previous channel will display.

Every time you press **CH RTN**, the TV will switch back and forth between the last two channels you tuned the TV to.

Programming your favorite channels

The Favorite Channel feature allows you to use the **FAV** \blacktriangledown / \blacktriangle buttons on the remote control to cycle through your favorite channels, skipping over channels you do not normally watch. You can program a maximum of 12 favorite channels.

Note: You can still use **CHANNEL** \blacktriangle / \blacktriangledown to cycle through all the channels you programmed into the TV's memory on page 16.

To program your favorite channels:

1. Tune the TV to a channel you want to program as a favorite channel.
2. Press **MENU**.
3. Press \blacktriangleleft or \blacktriangleright to highlight the SET UP menu.
4. Press \blacktriangle or \blacktriangledown to highlight FAVORITE CH.



5. Press \blacktriangleleft or \blacktriangleright to display the FAVORITE CH menu.
6. Press \blacktriangleleft or \blacktriangleright to highlight SET.
7. Press \blacktriangledown to add the current channel to the list.
8. Press **EXIT**.

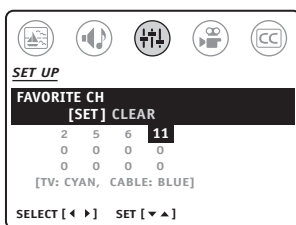

9. Repeat steps 1–8 for up to 12 channels.

(Continued on next page)

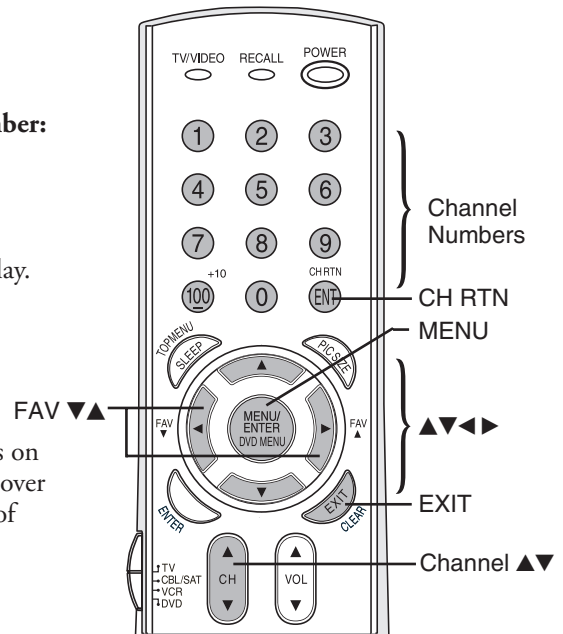

To select your favorite channels:

Press **FAV** \blacktriangledown \blacktriangle on the remote control to cycle through the favorite channels you programmed.

To clear a favorite channel:

1. Tune the TV to the channel you want to clear from your favorite channel list.
2. Press **MENU**.
3. Press \blacktriangleleft or \blacktriangleright to highlight the SET UP menu.
4. Press \blacktriangle or \blacktriangledown to highlight FAVORITE CH.
5. Press \blacktriangleleft or \blacktriangleright to display the FAVORITE CH menu.
6. Press \blacktriangleleft or \blacktriangleright to highlight CLEAR.

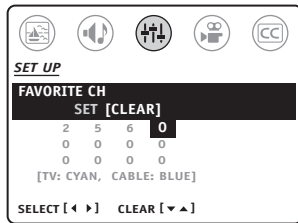

7. Press \blacktriangledown to clear the current channel number from the list.
8. Press **EXIT**.
9. Repeat steps 1–8 for other channels you want to clear from your favorite channel list.

Using the V-Chip Control (blocking) feature

You can use the V-Chip Control feature to block certain programs or channels, to prevent others from viewing them.

Selecting a PIN code

Before you can block programs or channels, you must select a personal identification number (PIN) code. Your PIN code allows you to access the V-Chip Control menu, and prevents others from changing the rating and blocking limits you set.

To select your PIN code and access the V-Chip Control menu:

1. Press **MENU**.
2. Press \blacktriangleleft or \blacktriangleright to highlight the SET UP menu.
3. Press \blacktriangle or \blacktriangledown to highlight V-CHIP CONTROL.
4. Press \blacktriangleleft or \blacktriangleright to display the NEW PIN CODE entering screen.

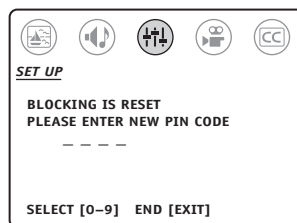

Note:

- The FAV \blacktriangledown \blacktriangle buttons function as menu \blacktriangleleft \blacktriangleright buttons when a menu is on-screen.
- The FAV \blacktriangledown \blacktriangle buttons will not work as favorite channel buttons unless you program at least one favorite channel.

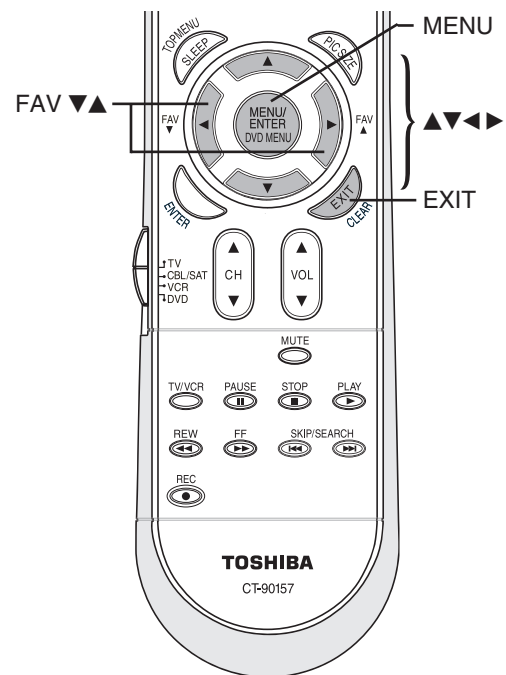

(Continued on next page)

- Use the **CHANNEL NUMBERS** (0–9) to enter your four-digit PIN code. After the code is entered, the V-Chip Control menu appears.

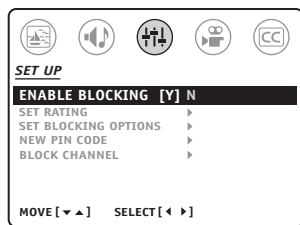

V-Chip Control (Blocking) Menu

- Press **▲** or **▼** to highlight **ENABLE BLOCKING**.
- Press **◀** or **▶** to highlight **“Y,”** which enables all blocking by activating the V-Chip. See “Blocking programs by ratings” on page 21, “Blocking unrated movies and programs” on page 23.

Note: The “Blocking channels” feature (page 24) is not affected by the **ENABLE BLOCKING** setting.

To disable blocking:

Highlight **“N”** in step 7, above, to deactivate the V-Chip Control feature and disable blocking.

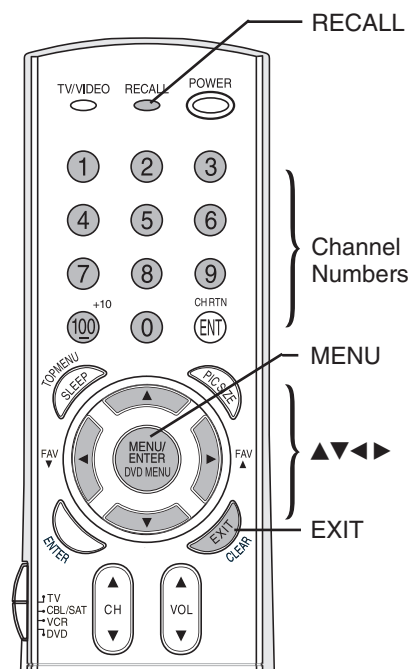

Changing your PIN code

- Press **MENU**.
- Press **◀** or **▶** to highlight the **SET UP** menu.
- Press **▲** or **▼** to highlight **V-CHIP CONTROL**.
- Press **◀** or **▶** to display the PIN code entering screen.
- Use the Channel Number buttons (0–9) to enter your existing PIN code. After the code is entered, the V-Chip Control menu appears.
- Press **▲** or **▼** to highlight **NEW PIN CODE**.
- Press **◀** or **▶** to display the New PIN Code entering screen.

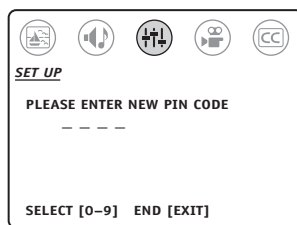
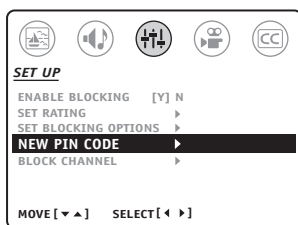

- Use the **CHANNEL NUMBERS** (0–9) to enter a new PIN code. After the new code is entered, the V-Chip Control menu appears.
- Press **EXIT** to return to normal TV viewing.

If you forget your PIN code

- Press **MENU**.
- Press **◀** or **▶** to highlight the **SET UP** menu.
- Press **▲** or **▼** to highlight **V-CHIP CONTROL**.
- Press **◀** or **▶** to display the PIN code entering screen.
- While the PIN code entering screen is displayed, press **RECALL** four times within five seconds. The “Blocking Is Reset” screen appears.

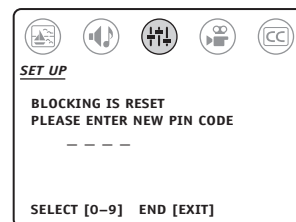

- Use the **CHANNEL NUMBERS** (0–9) to enter a new PIN code. After the new code is entered, the V-Chip Control menu appears.
- Press **EXIT** to return to normal TV viewing.

Blocking programs by ratings

The Motion Picture Association of America (MPAA) uses a rating system to qualify motion picture content. Television broadcasters employ a similar rating system to qualify the content of television programs. The MPAA, Youth TV, and TV ratings work with the V-Chip feature to allow you to block access to programs that exceed the rating limits you set.

Note:

Press **RECALL** to see the rating of the program you are viewing. Not all programs are rated, however. To block programs or movies that are not rated, see "Blocking unrated movies and programs" on page 23.

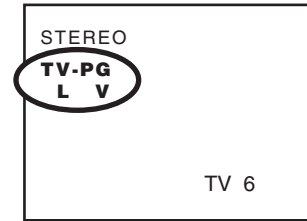

Ratings definitions

MPAA Ratings

X	For adults only.
NC17	Not intended for anyone 17 or under.
R	Restricted. Under 17 requires an accompanying parent or adult guardian.
PG13	Parents strongly cautioned. Some material may not be appropriate for children under 13.
PG	Parental guidance suggested. Some material may not be appropriate for children.
G	General audience. Appropriate for all ages.

Youth TV Ratings

Y7, Y7FV	Directed to older children. Programs rated Y7 are designed for children 7 and above. Programs rated Y7FV contain fantasy violence that may be more intense or combative than Y7-rated programs.
Y	For all children. Programs rated Y are designed to be appropriate for all children.

TV Ratings

MA	Mature audience only. This program is specifically designed to be viewed by adults and therefore may be unsuitable for children under 17.
Dialog	Intensely suggestive dialog
Language	Crude or indecent language
Sex	Explicit sexual activity
Violence	Graphic violence
14	Parents strongly cautioned. This program contains some material that many parents would find unsuitable for children under 14 years of age.
Dialog	Frequent suggestive dialog
Language	Frequent coarse language
Sex	Intense sexual situations
Violence	Intense violence
PG	Parental guidance suggested. This program contains material that parents may find unsuitable for younger children.
Dialog	Some suggestive dialog
Language	Occasional coarse language
Sex	Some sexual situations
Violence	Moderate violence
G	General audience. Most parents would find this program suitable for all ages.
No DLSV	Programs without any Dialog, Language, Sex, or Violence ratings.

To block programs by rating:

1. Press **MENU**.
2. Press ◀ or ▶ to highlight the SET UP menu.
3. Press ▲ or ▼ to highlight V-CHIP CONTROL.
4. Press ◀ or ▶ to display the PIN code entering screen.
5. Use the **CHANNEL NUMBERS** (0–9) to enter your four-digit PIN code. After the code is entered, the V-Chip Control menu appears.
6. Press ▲ or ▼ to highlight ENABLE BLOCKING.
7. Press ◀ or ▶ to highlight "Y," which enables all blocking by activating the V-Chip. (**Note:** Highlight "N" to deactivate the V-Chip Control feature and disable blocking.)

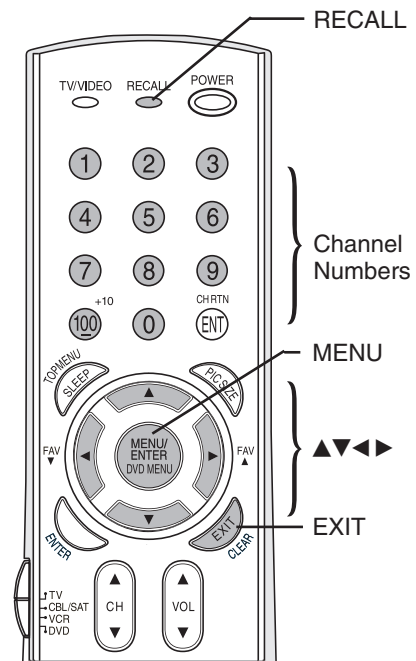
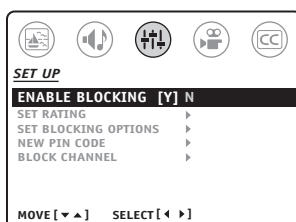

8. Press ▲ or ▼ to highlight SET RATING.
9. Press ◀ or ▶ to display the Set Rating menu.
10. Press ▲ or ▼ to highlight MPAA Rating, Youth TV Rating, or TV Rating.
11. Press ▶ to select (or ◀ to deselect) the ratings to be blocked. Blocked ratings will be marked with “X”; unblocked ratings will be marked with “✓.” All ratings higher than the ones that are selected are blocked as well. For example, if you block the MPAA rating R, programs with the higher ratings NC17 and X also will be blocked.

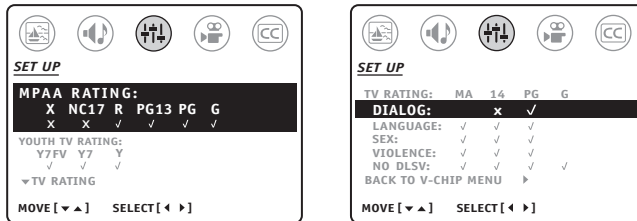

12. When you finish selecting the program ratings to be blocked:
 - To return to the V-Chip menu, press ▲ or ▼ to highlight BACK TO V-CHIP MENU, and then press ◀ or ▶.
 - To return to normal TV viewing, press **EXIT**.

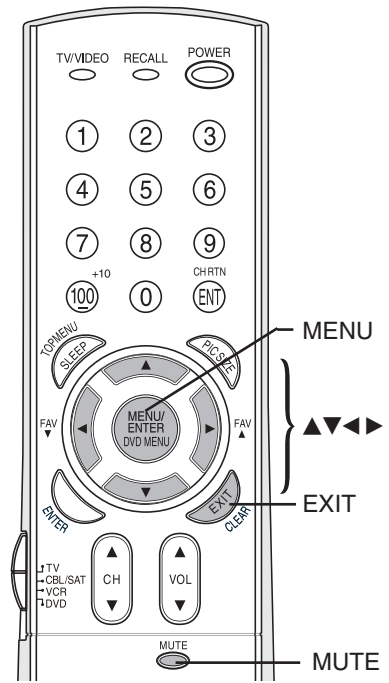

Unblocking programs temporarily

When you try to view a program with a ratings block, a message appears stating that the program has been blocked because the program's rating exceeds the set limits. To temporarily override the block and view the program, press **MUTE** and enter your PIN code. To reset your original ratings blocks, turn the TV off and then on again.

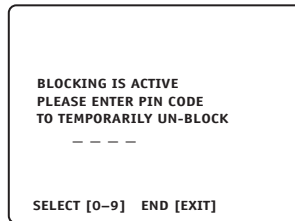
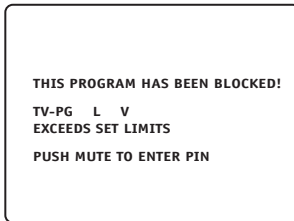

Note:

After unblocking programs temporarily, all programs will be unblocked until the TV is turned off. The TV will enter blocked mode when it is turned on again.

Blocking unrated movies and programs

Some movies and programs are not rated. You can use the V-Chip Control feature to block unrated movies and programs.

To block unrated movies and programs:

1. Press **MENU**.
2. Press ◀ or ▶ to highlight the SET UP menu.
3. Press ▲ or ▼ to highlight V-CHIP CONTROL.
4. Press ◀ or ▶ to display the PIN code entering screen.
5. Use the **CHANNEL NUMBERS** (0–9) to enter your four-digit PIN code. After entering the code, the V-Chip Control menu appears.
6. Press ▲ or ▼ to highlight ENABLE BLOCKING.
7. Press ◀ or ▶ to highlight “Y,” which enables all blocking by activating the V-Chip.
- Note:** Highlight “N” to deactivate the V-Chip feature and disable blocking.
8. Press ▲ or ▼ to highlight SET BLOCKING OPTIONS.
9. Press ◀ or ▶ to display the unrated movie/program blocking menu.
10. Press ▲ or ▼ to highlight BLOCK MPAA UNRATED (to block unrated movies) or BLOCK TV NONE RATING (to block unrated TV programs).
11. Press ◀ or ▶ to highlight “Y” to block unrated programs.
- Note:** Highlight “N” to unblock unrated programs.
12. Press **EXIT** to return to normal TV viewing.

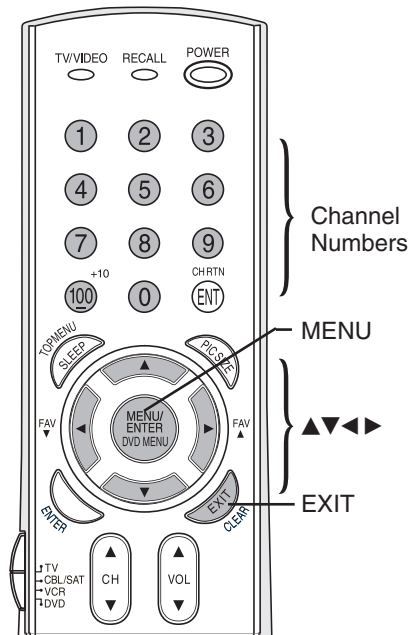
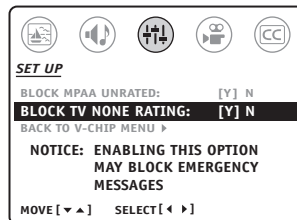
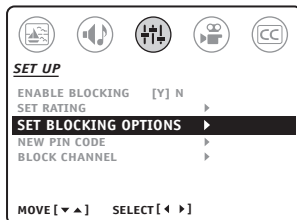

Note:

Blocking unrated TV programs (those rated “TV NONE”) also may block emergency messages.

Blocking channels

You can block a maximum of four TV channels and four cable channels. Blocked channels cannot be viewed, regardless of their programs' ratings. If you try to tune the TV to a blocked channel, the nearest unblocked channel will display.

To block a channel:

1. Tune the TV to the channel you want to block.
2. Press **MENU**.
3. Press ◀ or ▶ to highlight the SET UP menu.
4. Press ▲ or ▼ to highlight V-CHIP CONTROL.
5. Press ◀ or ▶ to display the PIN code entering screen.
6. Use the **CHANNEL NUMBERS** (0–9) to enter your four-digit PIN code. After entering the code, the V-Chip Control menu appears.
7. Press ▲ or ▼ to highlight BLOCK CHANNEL.
8. Press ◀ or ▶ to display the BLOCK CHANNEL menu.
9. Press ◀ or ▶ to highlight SET.
10. Press ▼ to add the current channel to the list.

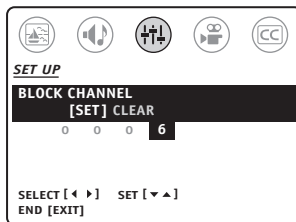

11. Press **EXIT**.
12. Repeat steps 1–11 to block additional channels.

To unblock all blocked channels:

Note: This will unblock every channel you have blocked. You cannot unblock individual channels.

1. Press **MENU**.
2. Press ◀ or ▶ to highlight the SET UP menu.
3. Press ▲ or ▼ to highlight V-CHIP CONTROL.
4. Press ◀ or ▶ to display the PIN code entering screen.
5. Use the **CHANNEL NUMBERS** (0–9) to enter your four-digit PIN code. After entering the code, the V-Chip Control menu appears.
6. Press ▲ or ▼ to highlight BLOCK CHANNEL.
7. Press ◀ or ▶ to display the BLOCK CHANNEL menu.
8. Press ◀ or ▶ to highlight CLEAR.
9. Press ▼ to clear all blocked channels from the list.
10. Press **EXIT**.

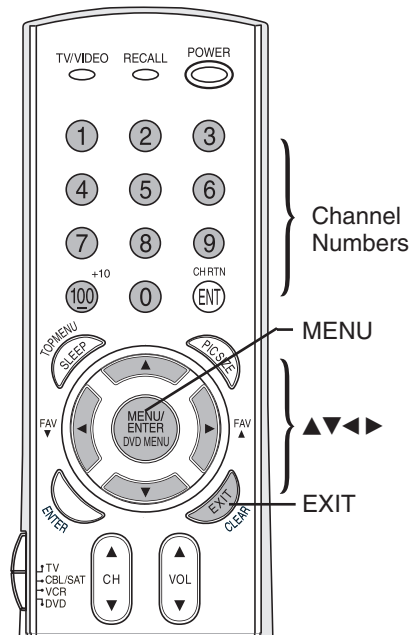

Note:

After programming CHANNEL BLOCK, be sure to tune the TV to a channel that is not blocked before turning the TV off.

Adjusting the picture

Adjusting the picture quality

You can adjust the picture's contrast, brightness, sharpness, color, and tint. Your picture quality adjustments are stored automatically in the TV's memory. You can keep these settings or choose preset options in the PREFERENCE menu (see "Selecting the color temperature" below, and "Selecting the picture preference" on the next page.)

To adjust the picture quality:

1. Press **MENU**.
2. Press ◀ or ▶ to highlight the PICTURE menu.
3. Press ▲ or ▼ until the quality you want to adjust is highlighted.

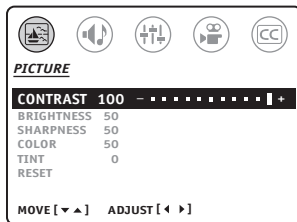

Note:

To reset the picture (and audio) adjustments to the factory settings, select **RESET** in the PICTURE menu, and then press ▶.

4. Press ◀ or ▶ to adjust the level, as described in the following table:

Selection	◀ Pressing ▶	
Contrast	Lower	Higher
Brightness	Darker	Lighter
Sharpness	Softer	Sharper
Color	Paler	Deeper
Tint	Reddish	Greenish

Selecting the color temperature

You can change the picture quality by selecting from three preset color temperatures—cool, medium, and warm.

To select the color temperature:

1. Press **MENU**.
2. Press ◀ or ▶ to highlight the PREFERENCE menu.
3. Press ▲ or ▼ to highlight COLOR TEMPERATURE.

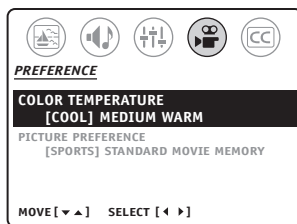

4. Press ◀ or ▶ to highlight the mode you prefer, as described in the following table:

Mode	Picture Quality
Cool	Blueish
Medium	Neutral
Warm	Reddish

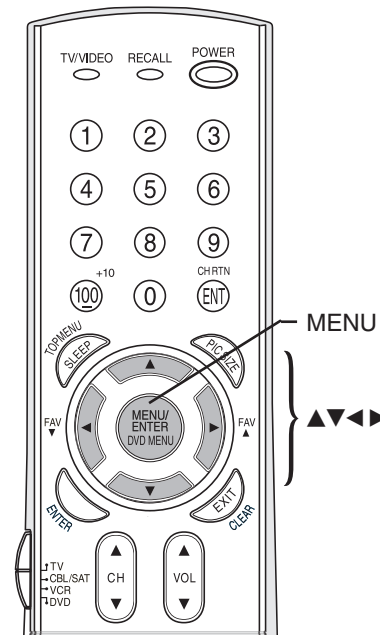

Selecting the picture preference

You can select from four picture modes—Sports, Standard, Movie, and Memory.

To select the picture preference:

1. Press **MENU**.
2. Press ◀ or ▶ to highlight the PREFERENCE menu.
3. Press ▲ or ▼ to highlight PICTURE PREFERENCE.

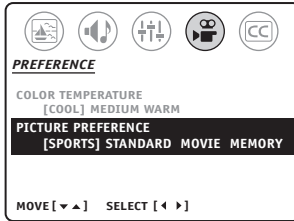

4. Press ◀ or ▶ to highlight the mode you prefer, as described in the following table:

Mode	Picture Quality
Sports	Bright and dynamic picture (factory-set)
Standard	Standard picture quality (factory-set)
Movie	Movie-like picture setting (factory-set)
Memory	Your personal preferences (set by you; see "Adjusting the picture quality" on previous page)

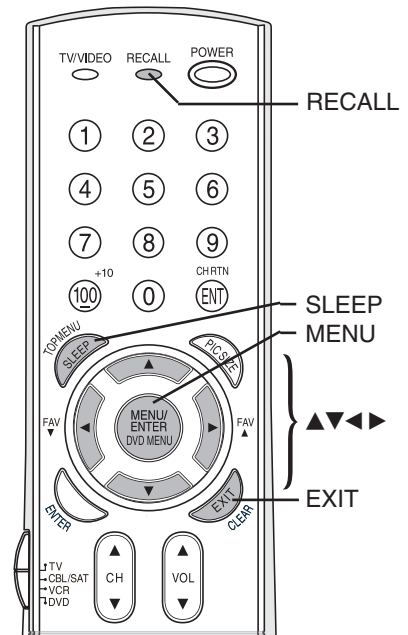

Displaying on-screen information

Press **RECALL** to display the following information on-screen:

- Audio status (stereo or SAP)
- Rating of current program (if rated)
- Channel number or video mode

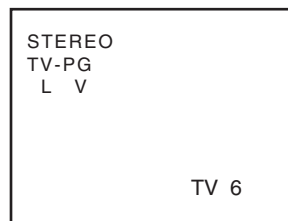

Setting the off timer

The off timer automatically turns off the TV after a set amount of time.

To set the off timer:

1. Press **SLEEP** on the remote control, which opens the SET UP menu and highlights TIMER. (Or press MENU and then ▶ or ◀ to open the SET UP menu, and then ▲ or ▼ to highlight TIMER.)
2. Press ▶ to increase (or ◀ to decrease) the amount of time until the TV turns off (in 10-minute increments, to a maximum of 180).

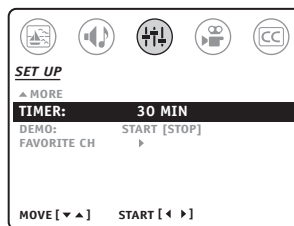

To cancel the off timer:

Press **SLEEP** and then ▶ or ◀ until the timer is set to 0, or turn off the TV.

Auto power off

The TV turns off automatically after approximately 15 minutes if it is tuned to a vacant channel or a station that stops broadcasting for the day.

Note: The auto power off feature does not work in VIDEO mode.

Using the closed caption feature

The Closed Caption feature has two options:

- **Captions**—An on-screen display of the dialogue, narration, and sound effects of programs and videos that are closed-captioned (usually identified in your local TV listing as “CC”).
- **Text**—An on-screen display of information not related to the program, such as weather or stock data (if available in your viewing area).

To view captions or text:

1. Tune the TV to the desired program.
2. Press **MENU**, and then press ◀ or ▶ to highlight the CLOSED CAPTION menu.
3. Press ▲ or ▼ to highlight CC.

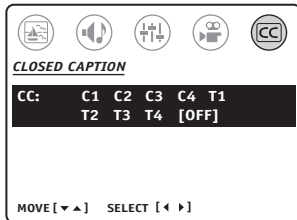

4. Press ◀ or ▶ to select the desired Closed Caption mode, as follows:

- To view captions, select C1, C2, C3, or C4 (C1 displays translation of the primary language in your area). **Note:** If the program or video you selected is not closed-captioned, no captions will display on-screen.



- To view text, select T1, T2, T3, or T4. **Note:** If text is not available in your viewing area, a black rectangle may appear on-screen. If this happens, set the Closed Caption feature to OFF.

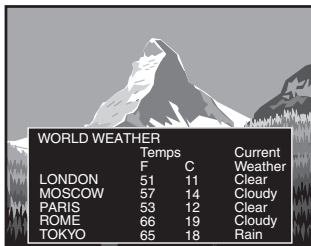

- To turn the Closed Caption feature off, highlight OFF in the Closed Caption menu.

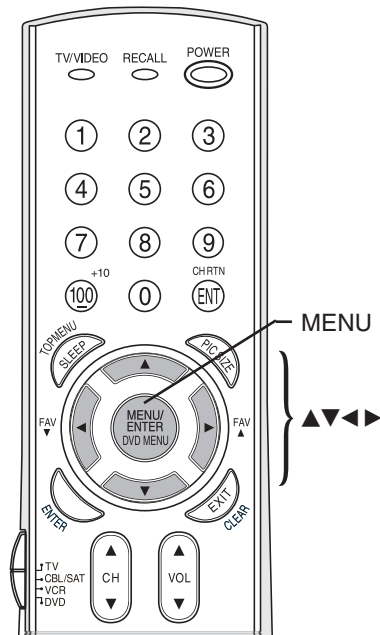

Note:

A closed caption signal may not display in the following situations:

- when a videotape has been dubbed
- when the signal reception is weak
- when the signal reception is non-standard

Adjusting the sound

Muting the sound

Press **MUTE** to temporarily turn off the sound (the screen briefly displays the word “MUTE” in the lower right corner). To restore the sound, press **MUTE** or **VOL ▲▼**.

When you press **MUTE**, the Closed Caption feature is automatically activated. To deactivate captions and restore normal sound, press **MUTE** again. This feature works only when the Closed Caption mode is set to OFF. For more information about closed caption settings, see “Using the closed caption feature” on page 27.

Selecting stereo/SAP broadcasts

The multi-channel TV sound (MTS) feature provides high-fidelity stereo sound from your TV speakers. MTS also can transmit a second audio program (SAP) containing a second language or other audio information.

Note: The MTS feature is not available in VIDEO mode.

When the TV receives a stereo or SAP broadcast, the word “STEREO” or “SAP” displays on-screen every time you turn on the TV, change the channel, or press **RECALL**.

To listen to stereo sound:

1. Press **MENU**.
2. Press ◀ or ▶ to highlight the AUDIO menu.
3. Press ▲ or ▼ to highlight MTS.
4. Press ◀ or ▶ to highlight STR (stereo).

Note: If the stereo sound is noisy, select MONO to reduce the noise.

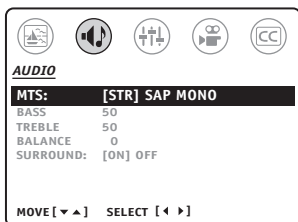

Note: In general, if you leave the TV in STR (stereo) mode, the TV will automatically output the type of sound being broadcast (stereo or mono).

To listen to a second audio program (SAP):

1. Press **MENU**.
2. Press ◀ or ▶ to highlight the AUDIO menu.
3. Press ▲ or ▼ to highlight MTS.
4. Press ◀ or ▶ to highlight SAP. The TV speakers will output the second audio program (if available), instead of normal audio.

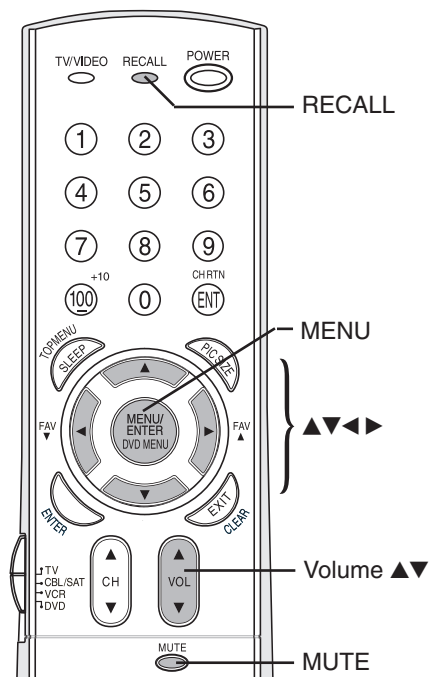

Adjusting the sound quality

You can change your TV's sound quality by adjusting the bass, treble, and balance.

To adjust the sound quality:

1. Press **MENU**.
2. Press ◀ or ▶ to highlight the AUDIO menu.
3. Press ▲ or ▼ to highlight the quality you want to adjust (BASS, TREBLE, or BALANCE).
4. Press ◀ or ▶ to adjust the level:
 - ◀ makes the sound quality weaker or increases the balance in the right channel, depending on the item selected.
 - ▶ makes the sound quality stronger or increases the balance in the left channel, depending on the item selected.

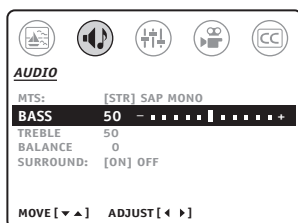

Using the surround sound feature

The surround sound feature expands the audio listening field wider and deeper to create exceptional sound quality from the TV speakers. This feature uses stereo signals from a TV broadcast or video input.

To turn surround sound on:

1. Press **MENU**.
2. Press ◀ or ▶ to highlight the AUDIO menu.
3. Press ▲ or ▼ to highlight MTS.
4. Press ◀ or ▶ to highlight STR.
5. Press ▼ to highlight SURROUND.
6. Press ◀ or ▶ to highlight ON.

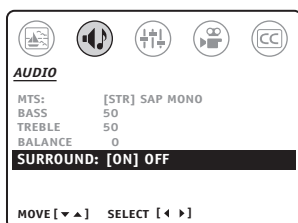

To turn surround sound off:

Highlight OFF in step 6 above.

Note: In general, if you leave the surround sound feature ON, the TV will automatically output the type of sound being broadcast (surround stereo or mono).

Note:

To reset the audio adjustments (bass, treble, and balance) to the factory settings, select RESET in the PICTURE menu (see note on page 25).

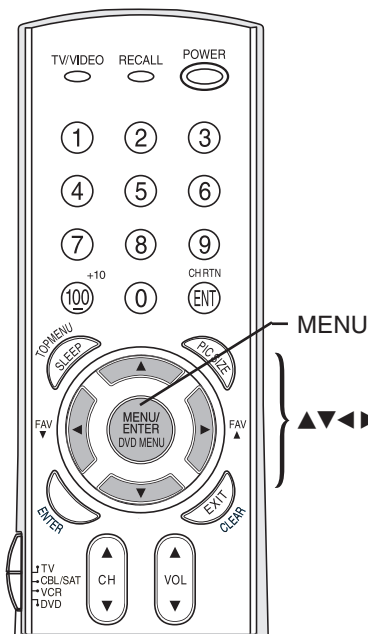

Viewing the demonstration (DEMO) mode

The DEMO mode automatically demonstrates several features of your TV.

To start the DEMO mode:

1. Press **MENU**.
2. Press ◀ or ▶ to highlight the SET UP menu.
3. Press ▲ or ▼ to highlight DEMO.

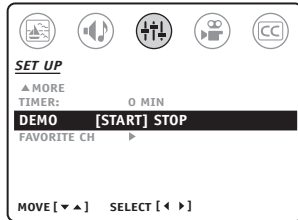

4. Press ◀ or ▶ to highlight START.

To stop the DEMO mode:

Press **RECALL**, **EXIT**, or **POWER**.

Understanding the last mode memory feature

If the power is cut off while you are viewing the TV, the Last Mode Memory feature automatically turns on the TV when the power is resupplied.

If the power is going to be off for a long time and you are going to be away from your TV, unplug the power cord to prevent the TV from turning on in your absence.

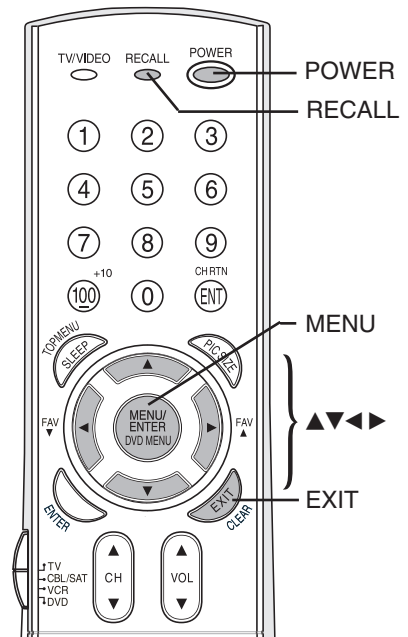

Appendix

Specifications

Television system	NTSC standard
Channel coverage	VHF: 2 through 13 UHF: 14 through 69 Cable TV: mid band (A-8 through A-1, A through I) super band (J through W) hyper band (AA through ZZ, AAA, BBB) ultra band (65 through 94, 100 through 125)
Power source	120V AC, 60Hz
Power consumption	32A33: 94W (average) 32A43: 94W (average) 36A43: 109 W (average)
Audio power	5W + 5W
Speaker type	2-3/8 x 4-3/4 inches (60 x 120 mm)
Audio/Video terminals	S-VIDEO INPUT Y-INPUT: 1V (p-p), 75 ohm, negative sync. C-INPUT: 0.286V (p-p) (burst signal), 75 ohm AUDIO/VIDEO INPUT VIDEO: 1V(p-p), 75 ohm, negative sync. AUDIO: 150mV(rms) (30% modulation equivalent, 47k ohm) ColorStream® (component video) INPUT Y: 1V (p-p), 75 ohm C _R (P _R): 0.7 V (p-p), 75 ohm C _B (P _B): 0.7 V (p-p), 75 ohm AUDIO/VIDEO OUTPUT VIDEO: 1V(p-p), 75 ohm, negative sync. AUDIO: 150mV(rms) (30% modulation equivalent, 4.7k ohm)
Dimensions	32A33: Width 30-3/8 inches (772mm) Height 28 inches (711mm) Depth 22-1/2 inches (572mm) 32A43: Width 34 inches (864mm) Height 27-1/2 inches (699mm) Depth 21-1/8 inches (537mm) 36A43: Width 38-3/16 inches (970mm) Height 30-1/16 inches (764mm) Depth 25-1/4 inches (641mm)
Mass	32A33: 111 lbs (50.3kg) 32A43: 111 lbs (50.3kg) 36A43: 154 lbs (69.9kg)
Supplied accessories	Remote Control with 2 size “AA” batteries
Optional TV stand	32A33: ST3233 32A43: ST3243 36A43: ST3643

Design and specifications are subject to change without notice.

Troubleshooting

Before returning your TV to your retailer or calling service personnel, please check the following chart for a possible cause of the problem you are experiencing. A minor adjustment on your part may eliminate the problem and restore your TV reception.

Problem	Checks and Adjustments
TV will not turn on	<ul style="list-style-type: none"> • Make sure the power cord is plugged in, and then press POWER. • The remote control batteries may be dead. Replace the batteries.
No picture	<ul style="list-style-type: none"> • Check the antenna/cable connections. • This TV will not accept or display 480p, 720p, or 1080i signals. If you are using a DVD player or high-definition set-top box, make sure it is in 480i (interlaced) mode. See notes on page 9.
No sound, picture OK	<ul style="list-style-type: none"> • The sound may be muted. Press VOLUME ▲ or ▼. • The station may have broadcast difficulties. Try another channel. • Make sure the MTS feature is set correctly (see page 28).
Poor sound, picture OK	<ul style="list-style-type: none"> • The station may have broadcast difficulties. Try another channel. • An appliance near the TV may be causing interference. Move or turn off the appliance.
Poor picture, sound OK	<ul style="list-style-type: none"> • Check the antenna/cable connections. • The station may have broadcast difficulties. Try another channel. • An appliance near the TV may be causing interference. Move or turn off the appliance. • Adjust the PICTURE menu. • This TV will not accept or display 480p, 720p, or 1080i signals. If you are using a DVD player or high-definition set-top box, make sure it is in 480i (interlaced) mode. See notes on page 9.
Poor reception of broadcast channels	<ul style="list-style-type: none"> • The station may have broadcast difficulties. Try another channel. • Check the antenna connections. • If using a VCR, make sure the TV/VCR button is set correctly.
No UHF, VHF OK	<ul style="list-style-type: none"> • Make sure the TV/CABLE function is set to the mode that corresponds to the signal source type (cable company or outside antenna).
Black box appears on the screen	<ul style="list-style-type: none"> • The Closed Caption Text feature (T1, T2, T3, or T4) may be on. Set the Closed Caption feature to OFF.
Cannot select a certain channel	<ul style="list-style-type: none"> • The channel may be blocked by the BLOCK CHANNEL function. Unblock the channel. • The channel may have been erased from the channel memory by the ADD/ERASE function. Reprogram the channel into channel memory or use the Channel Numbers to select the channel.
Multiple images (ghosts)	<ul style="list-style-type: none"> • The station may have broadcast difficulties. Try another channel. • Antenna reception may be poor. Use a highly directional outdoor antenna.
Poor color or no color	<ul style="list-style-type: none"> • The station may have broadcast difficulties. Try another channel. • An appliance near the TV may be causing interference. Move or turn off the appliance. • Adjust the TINT and/or COLOR in the Picture menu. • If you change the direction of the TV while the TV is on, the picture may suffer from color shading. Turn off the TV and allow it to cool for about 30 minutes; then turn it on again.
No stereo or SAP sound from an MTS broadcast	<ul style="list-style-type: none"> • Make sure the MTS feature is set correctly (see page 28).
The remote control does not operate	<ul style="list-style-type: none"> • Make sure the TV/CABLE/VCR switch is set correctly. • There may be an obstruction between the remote control and the TV. Remove the obstruction and retry the remote control. • The remote control batteries may be dead. Replace the batteries.

Limited United States Warranty

for 27" FST PURE® and All Larger Television Models

Toshiba America Consumer Products, L.L.C. ("TACP") makes the following limited warranties to original consumers in the United States. THESE LIMITED WARRANTIES EXTEND TO THE ORIGINAL CONSUMER PURCHASER OR ANY PERSON RECEIVING THIS TELEVISION AS A GIFT FROM THE ORIGINAL CONSUMER PURCHASER AND TO NO OTHER PURCHASER OR TRANSFEREE.

PRODUCTS PURCHASED IN THE U.S.A. AND USED IN CANADA ARE NOT COVERED BY THESE WARRANTIES.

PRODUCTS PURCHASED IN CANADA AND USED IN THE U.S.A. ARE NOT COVERED BY THESE WARRANTIES.

Limited One (1) Year Warranty on Parts and Labor*

TACP warrants this television and its parts against defects in materials or workmanship for a period of one (1) year after the date of original retail purchase. DURING THIS PERIOD, TACP WILL, AT TACP'S OPTION, REPAIR OR REPLACE A DEFECTIVE PART WITH A NEW OR REFURBISHED PART WITHOUT CHARGE TO YOU FOR PARTS OR LABOR. TACP Authorized Service Station personnel will come to your home when warranty service is required. Depending on the type of repair required, either the service will be performed in your home or the set will be taken to the TACP Authorized Service Station for repair and returned to your home at no cost to you.

Limited Two (2) Year Warranty on Picture Tube*

TACP further warrants the picture tube in this television against defects in materials or workmanship for a period of two (2) years after the date of original retail purchase. DURING THIS PERIOD, TACP WILL, AT TACP'S OPTION, REPAIR OR REPLACE A DEFECTIVE PICTURE TUBE WITH A NEW OR REFURBISHED PICTURE TUBE WITHOUT CHARGE TO YOU, EXCEPT THAT, IF A DEFECTIVE PICTURE TUBE IS REPAIRED OR REPLACED AFTER ONE (1) YEAR FROM THE DATE OF THE ORIGINAL RETAIL PURCHASE, YOU PAY LABOR CHARGES INVOLVED IN THE REPAIR OR REPLACEMENT.

Rental Units

The warranty for rental units begins with the date of first rental or thirty (30) days from the date of shipment to the rental firm, whichever comes first.

*Commercial Units

Televisions sold and used for commercial purposes have a limited ninety (90) day warranty for all parts, labor, and picture tubes.

Owner's Manual and Product Registration Card

Read this owner's manual thoroughly before operating this television. Complete and mail the enclosed product registration card within ten days after you, or the person who has given you this product as a gift, purchased this television. Returning the product registration card will enable TACP to provide you with better customer service and improved product support. Failure to return the product registration card will not affect your rights under this warranty.

Your Responsibility

THE ABOVE WARRANTIES ARE SUBJECT TO THE FOLLOWING CONDITIONS:

- (1) You must provide your bill of sale or other proof of purchase.
- (2) All warranty servicing of this television must be made by an Authorized TACP Service Station.
- (3) The warranties from TACP are effective only if the television is purchased and operated in the U.S.A. or Puerto Rico.

- (4) Labor service charges for set installation, setup, adjustment of customer controls, and installation or repair of antenna systems are not covered by these warranties. Reception problems caused by inadequate antenna systems are your responsibility.
- (5) Warranties extend only to defects in materials or workmanship as limited above and do not extend to any television or parts that have been lost or discarded by you or to damage to television or parts caused by misuse, accident, Acts of God (such as lightning or fluctuations in electric power), improper installation, improper maintenance, or use in violation of instructions furnished by TACP; or to units that have been modified or had the serial number removed, altered, defaced, or rendered illegible.

How to Obtain Warranty Services

If, after following all of the operating instructions in this manual and checking the "Troubleshooting" section, you find that service is needed:

- (1) Visit TACP's web site at www.toshiba.com/tacp or call toll free 1-800-631-3811 to find the nearest TACP Authorized Service Station.
- (2) Present your bill of sale or other proof of purchase to the Authorized Service Station. Authorized TACP Service Station personnel will come to your home when warranty service is required. Depending on the type of repair required, either the service will be performed in your home or the set will be taken to the Authorized Service Station for repair and returned to your home at no cost to you.

**For additional information, visit TACP's web site:
www.toshiba.com/tacp.**

ALL WARRANTIES IMPLIED BY THE LAW OF ANY STATE OF THE U.S.A., INCLUDING THE IMPLIED WARRANTIES OF MERCHANTABILITY AND FITNESS FOR A PARTICULAR PURPOSE, ARE EXPRESSLY LIMITED TO THE DURATION OF THE LIMITED WARRANTIES SET FORTH ABOVE. WITH THE EXCEPTION OF ANY WARRANTIES IMPLIED BY THE LAW OF ANY STATE OF THE U.S.A. AS HEREBY LIMITED, THE FOREGOING WARRANTY IS EXCLUSIVE AND IN LIEU OF ALL OTHER WARRANTIES, GUARANTEES, AGREEMENTS, AND SIMILAR OBLIGATIONS OF TACP WITH RESPECT TO THE REPAIR OR REPLACEMENT OF ANY PARTS. IN NO EVENT SHALL TACP BE LIABLE FOR CONSEQUENTIAL OR INCIDENTAL DAMAGES.

No person, agent, distributor, dealer, or company is authorized to change, modify, or extend the terms of these warranties in any manner whatsoever. The time within which action must be commenced to enforce any obligation of TACP arising under this warranty or under any law of the United States or of any state thereof is hereby limited to 90 days from the date you discover, or should have discovered, the defect. This limitation does not apply to implied warranties arising under the law of any state of the U.S.A.

THIS WARRANTY GIVES YOU SPECIFIC LEGAL RIGHTS, AND YOU MAY ALSO HAVE OTHER RIGHTS, WHICH MAY VARY FROM STATE TO STATE IN THE U.S.A. SOME STATES OF THE U.S.A. DO NOT ALLOW LIMITATIONS ON THE DURATION OF AN IMPLIED WARRANTY, LIMITATIONS ON THE TIME WITHIN WHICH AN ACTION MAY BE BROUGHT, OR THE EXCLUSION OR LIMITATION OF INCIDENTAL OR CONSEQUENTIAL DAMAGES; THEREFORE, THE ABOVE LIMITATIONS OR EXCLUSIONS MAY NOT APPLY TO YOU UNDER SUCH CIRCUMSTANCES.

FST PURE® is a registered trademark of Toshiba America Consumer Products, L.L.C.
0104

Limited Canada Warranty

for 27" FST PURE® and All Larger Television Models

If you purchased your TV in Canada, register it online at www.toshiba.ca

Toshiba of Canada Limited ("TCL") makes the following limited warranties to original consumers in Canada.

THESE LIMITED WARRANTIES EXTEND TO THE ORIGINAL CONSUMER PURCHASER OR ANY PERSON RECEIVING THIS TELEVISION AS A GIFT FROM THE ORIGINAL CONSUMER PURCHASER AND TO NO OTHER PURCHASER OR TRANSFEREE.

PRODUCTS PURCHASED IN THE U.S.A. AND USED IN CANADA ARE NOT COVERED BY THESE WARRANTIES.

PRODUCTS PURCHASED IN CANADA AND USED IN THE U.S.A. ARE NOT COVERED BY THESE WARRANTIES.

Limited One (1) Year Warranty on Parts and Labor*

TCL warrants this television and its parts against defects in materials or workmanship for a period of one (1) year after the date of original retail purchase. DURING THIS PERIOD, TCL WILL, AT TCL'S OPTION, REPAIR OR REPLACE A DEFECTIVE PART WITH A NEW OR REFURBISHED PART WITHOUT CHARGE TO YOU FOR PARTS OR LABOR. TCL Authorized Service Depot personnel will come to your home when warranty service is required. Depending on the type of repair required, either the service will be performed in your home or the set will be taken to the TCL Authorized Service Depot for repair and returned to your home at no cost to you. IN-HOME SERVICE ONLY APPLIES WITHIN 100 KILOMETERS OF AN AUTHORIZED TCL SERVICE DEPOT.

Limited Two (2) Year Warranty on Picture Tube*

TCL further warrants the picture tube in this television against defects in materials or workmanship for a period of two (2) years after the date of original retail purchase. DURING THIS PERIOD, TCL WILL, AT TCL'S OPTION, REPAIR OR REPLACE A DEFECTIVE PICTURE TUBE WITH A NEW OR REFURBISHED PICTURE TUBE WITHOUT CHARGE TO YOU, EXCEPT THAT, IF A DEFECTIVE PICTURE TUBE IS REPAIRED OR REPLACED AFTER ONE (1) YEAR FROM THE DATE OF THE ORIGINAL RETAIL PURCHASE, YOU PAY LABOR CHARGES INVOLVED IN THE REPAIR OR REPLACEMENT.

Rental Units

The warranty for rental units begins with the date of first rental or thirty (30) days from the date of shipment to the rental firm, whichever comes first.

*Commercial Units

Televisions sold and used for commercial purposes have a limited ninety (90) day warranty for all parts, labor, and picture tubes.

Owner's Manual

Read this owner's manual thoroughly before operating this television.

Your Responsibility

THE ABOVE WARRANTIES ARE SUBJECT TO THE FOLLOWING CONDITIONS:

- (1) You must provide your bill of sale or other proof of purchase.
- (2) All warranty servicing of this television must be made by an Authorized TCL Service Depot.
- (3) The warranties from TCL are effective only if the television is purchased in Canada from an authorized TCL dealer and operated in Canada.
- (4) Labor service charges for set installation, setup, adjustment of customer controls, and installation or repair of antenna systems are not covered by these warranties. Reception

problems caused by inadequate antenna systems are your responsibility.

- (5) Warranties extend only to defects in materials or workmanship as limited above and do not extend to any television or parts that have been lost or discarded by you or to damage to television or parts caused by misuse, accident, Acts of God (such as lightning or fluctuations in electric power), improper installation, improper maintenance, or use in violation of instructions furnished by TCL; or to units that have been modified or had the serial number removed, altered, defaced, or rendered illegible.

How to Obtain Warranty Services

If, after following all of the operating instructions in this manual and checking the "Troubleshooting" section, you find that service is needed:

- (1) To find the nearest TCL Authorized Service Depot, visit TCL's web site: www.toshiba.ca.
- (2) Present your bill of sale or other proof of purchase to the Authorized Service Depot. Authorized TCL Service Depot personnel will come to your home when warranty service is required. Depending on the type of repair required, either the service will be performed in your home or the set will be taken to the Authorized Service Depot for repair and returned to your home at no cost to you. IN-HOME SERVICE ONLY APPLIES WITHIN 100 KILOMETERS OF AN AUTHORIZED TCL SERVICE DEPOT.

For additional information, visit TCL's web site:
www.toshiba.ca

ALL WARRANTIES IMPLIED BY THE LAW OF ANY PROVINCE OF CANADA, INCLUDING THE IMPLIED WARRANTIES OF MERCHANTABILITY AND FITNESS FOR A PARTICULAR PURPOSE, ARE EXPRESSLY LIMITED TO THE DURATION OF THE LIMITED WARRANTIES SET FORTH ABOVE. WITH THE EXCEPTION OF ANY WARRANTIES IMPLIED BY THE LAW OF ANY PROVINCE OF CANADA AS HEREBY LIMITED, THE FOREGOING WARRANTY IS EXCLUSIVE AND IN LIEU OF ALL OTHER WARRANTIES, GUARANTEES, AGREEMENTS, AND SIMILAR OBLIGATIONS OF TCL WITH RESPECT TO THE REPAIR OR REPLACEMENT OF ANY PARTS. IN NO EVENT SHALL TCL BE LIABLE FOR CONSEQUENTIAL OR INCIDENTAL DAMAGES.

No person, agent, distributor, dealer, or company is authorized to change, modify, or extend the terms of these warranties in any manner whatsoever. The time within which action must be commenced to enforce any obligation of TCL arising under this warranty or under any law of Canada or of any province thereof, is hereby limited to 90 days from the date you discover, or should have discovered, the defect. This limitation does not apply to implied warranties arising under the law of any province of Canada.

THIS WARRANTY GIVES YOU SPECIFIC LEGAL RIGHTS, AND YOU MAY ALSO HAVE OTHER RIGHTS, WHICH MAY VARY FROM PROVINCE TO PROVINCE IN CANADA. SOME PROVINCES OF CANADA DO NOT ALLOW LIMITATIONS ON THE DURATION OF AN IMPLIED WARRANTY, LIMITATIONS ON THE TIME WITHIN WHICH AN ACTION MAY BE BROUGHT, OR THE EXCLUSION OR LIMITATION OF INCIDENTAL OR CONSEQUENTIAL DAMAGES; THEREFORE, THE ABOVE LIMITATIONS OR EXCLUSIONS MAY NOT APPLY TO YOU UNDER SUCH CIRCUMSTANCES.

FST PURE® is a registered trademark of Toshiba America Consumer Products, L.L.C.
0104

TOSHIBA AMERICA CONSUMER PRODUCTS, L.L.C.

HEAD OFFICE: 82 TOTOWA ROAD, WAYNE, NJ 07470, U.S.A.
NATIONAL SERVICE DIVISION: 1420-B TOSHIBA DRIVE, LEBANON, TN 37087, U.S.A.

TOSHIBA OF CANADA LTD.

HEAD OFFICE: 191 McNABB STREET, MARKHAM, ONTARIO, L3R 8H2, CANADA – TEL: (905) 470-5400

SERVICE CENTERS:

TORONTO: 191 McNABB STREET, MARKHAM, ONTARIO L3R 8H2, CANADA – TEL: (905) 470-5400
MONTREAL: 18050 TRANS CANADA, KIRKLAND, QUEBEC, H9J 4A1, CANADA – TEL: (514) 390-7766
VANCOUVER: 22171 FRASERWOOD WAY, RICHMOND, B.C., V6W 1J5, CANADA – TEL: (604) 303-2500

MANUFACTURED BY

TOSHIBA AMERICA CONSUMER PRODUCTS, L.L.C.

ColorStream is a registered trademark of Toshiba America Consumer Products, L.L.C.

PRINTED IN USA
(04-01) R

TOSHIBA

Free Manuals Download Website

<http://myh66.com>

<http://usermanuals.us>

<http://www.somanuals.com>

<http://www.4manuals.cc>

<http://www.manual-lib.com>

<http://www.404manual.com>

<http://www.luxmanual.com>

<http://aubethermostatmanual.com>

Golf course search by state

<http://golfingnear.com>

Email search by domain

<http://emailbydomain.com>

Auto manuals search

<http://auto.somanuals.com>

TV manuals search

<http://tv.somanuals.com>