

**TOSHIBA**

# HD-XA2KN

HD DVD player



Introduction

Connections

Playback  
(Basic)

Playback  
(Advanced)

Internet  
connection

Others

## OWNER'S MANUAL



# SAFETY PRECAUTIONS

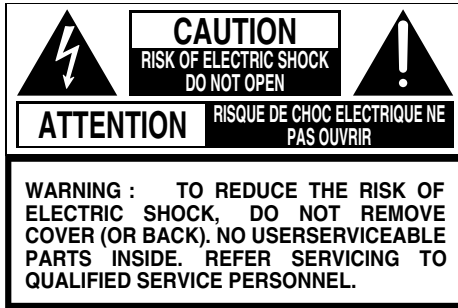

The lightning flash with arrowhead symbol, within an equilateral triangle, is intended to alert the user to the presence of uninsulated "dangerous voltage" within the product's enclosure that may be of sufficient magnitude to constitute a risk of electric shock to persons.



The exclamation point within an equilateral triangle is intended to alert the user to the presence of important operating and maintenance (servicing) instructions in the literature accompanying the appliance.

**WARNING:** TO REDUCE THE RISK OF FIRE OR ELECTRIC SHOCK, DO NOT EXPOSE THIS APPLIANCE TO RAIN OR MOISTURE. DANGEROUS HIGH VOLTAGES ARE PRESENT INSIDE THE ENCLOSURE. DO NOT OPEN THE CABINET. REFER SERVICING TO QUALIFIED PERSONNEL ONLY.

**CAUTION:** TO PREVENT ELECTRIC SHOCK, MATCH WIDE BLADE OF PLUG TO WIDE SLOT, FULLY INSERT.

**ATTENTION:** POUR EVITER LES CHOCS ELECTRIQUES, INTRODUIRE LA LAME LA PLUS LARGE DE LA FICHE DANS LA BORNE CORRESPONDANTE DE LA PRISE ET POUSSER JUSQU'AU FOND.

**CAUTION:** This HD DVD player employs a Laser System.  
To ensure proper use of this product, please read this owner's manual carefully and retain for future reference. Should the unit require maintenance, contact an authorized service location - see service procedure.

Use of controls or adjustments or performance of procedures other than those specified herein may result in hazardous radiation exposure.

To prevent direct exposure to laser beam, do not try to open the enclosure.  
Visible and invisible laser radiation when open and interlocks defeated.  
DO NOT STARE INTO BEAM.

**FCC NOTICE:** This equipment has been tested and found to comply with the limits for a Class B digital device, pursuant to part 15 of the FCC Rule. These limits are designed to provide reasonable protection against harmful interference in a residential installation.

This equipment generates, uses, and can radiate radio frequency energy and, if not installed and used in accordance with the instructions, may cause harmful interference to radio communications.

However, there is no guarantee that interference will not occur in a particular installation. If this equipment does cause harmful interference to radio or television reception, which can be determined by turning the equipment off and on, the user is encouraged to try to correct the interference by one or more of the following measures:

- Reorient or relocate the receiving antenna.
- Increase the separation between the equipment and receiver.
- Connect the equipment into an outlet on a circuit different from that to which the receiver is connected.
- Consult the dealer or an experienced radio/TV technician for help.

**WARNING:** Changes or modifications made to this equipment, not expressly approved by Toshiba, or parties authorized by Toshiba, could void the user's authority to operate the equipment.

**CAUTION:** These servicing instructions are for use by qualified service personnel only. To reduce the risk of electric shock do not perform any servicing other than that contained in the operating instructions unless you are qualified to do so.

In the spaces provided below, record the Model and Serial No. located on the rear panel of your player.

Model No. \_\_\_\_\_ Serial No. \_\_\_\_\_

Retain this information for future reference.

### Location of the required label

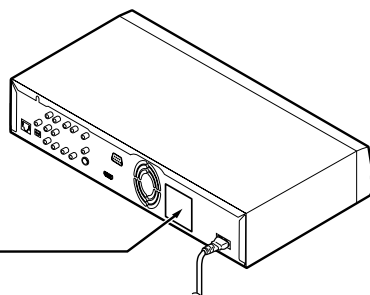

# IMPORTANT SAFETY INSTRUCTIONS

1. Read these instructions.
2. Keep these instructions.
3. Heed all warnings.
4. Follow all instructions.
5. Do not use this apparatus near water.
6. Clean only with dry cloth.
7. Do not block any ventilation openings. Install in accordance with the manufacturer's instructions.
8. Do not install near any heat sources such as radiators, heat registers, stoves, or other apparatus (including amplifiers) that produce heat.
9. Do not defeat the safety purpose of the polarized or grounding-type plug. A polarized plug has two blades with one wider than the other. A grounding type plug has two blades and a third grounding prong. The wide blade or the third prong are provided for your safety. If the provided plug does not fit into your outlet, consult an electrician for replacement of the obsolete outlet.
10. Protect the power cord from being walked on or pinched particularly at plugs, convenience receptacles, and the point where they exit from the apparatus.
11. Only use attachments/accessories specified by the manufacturer.
12. Use only with the cart, stand, tripod, bracket, or table specified by the manufacturer, or sold with the apparatus. When a cart is used, use caution when moving the cart/apparatus combination to avoid injury from tip-over.
13. Unplug this apparatus during lightning storms or when unused for long periods of time.
14. Refer all servicing to qualified service personnel. Servicing is required when the apparatus has been damaged in any way, such as power-supply cord or plug is damaged, liquid has been spilled or objects have fallen into the apparatus, the apparatus has been exposed to rain or moisture, does not operate normally, or has been dropped.



## **ADDITIONAL SAFETY INSTRUCTIONS**

15. Do not overload wall outlets; extension cords, or integral convenience receptacles as this can result in a risk of fire or electric shock.
16. Never expose the apparatus to dripping or splashing or place items such as vases, aquariums, any other item filled with liquid, or candles on top of the unit.
17. Keep your fingers well clear of the disc tray as it is closing. Neglecting to do so may cause serious personal injury.
18. Do not place anything on top of this unit.
19. Do not place the apparatus on amplifiers or equipment that may produce heat.
20. Never block or cover the slots or openings in the unit.  
Never place the unit:
  - on a bed, sofa, rug or similar surface;
  - too close to drapes, curtains, or walls; or
  - in a confined space such as a bookcase, built-in cabinet, or any other place with poor ventilation.The slots and openings are provided to protect the unit from overheating and to help maintain reliable operation.
21. Do not use a cracked, deformed, or repaired disc. These discs are easily broken and may cause serious personal injury and apparatus malfunction.
22. If the apparatus should emit smoke or an unusual odor, immediately disconnect the power cord from the wall outlet. Wait until the smoke or smell stops, then ask your dealer for a check and repair. Neglecting to do so may cause fire.
23. During thunderstorms, do not touch the connecting cables or the apparatus.

# Precautions

## Notes on handling

- Never disconnect the power cord from a wall outlet while the player is turned on, unless it is in an emergency. Doing so may cause malfunction.
- When shipping the player, the original shipping carton and packing materials come in handy. For maximum protection, repack the unit as it was originally packed at the factory.
- Do not use volatile liquids, such as insect spray, near the player. Do not leave rubber or plastic products in contact with the player for a long time. They will leave marks on the finish.
- The top and rear panels of the player may become warm after a long period of use. This is not a malfunction.

## When not in use

- For usual absence  
Be sure to remove the disc from the player and turn off the power.
- Prolonged absence  
Unplug the player from a wall outlet. (This will stop the clock. Display "SETUP MENU" by pressing SETUP, and reset the clock (➡ page 52, 60).)

## Notes on locating

- Place the player on a level surface. Do not use it on a shaky or unstable surface such as a wobbly table or inclined stand. The loaded disc may dislodge from its proper position and cause damage to the player. Before placing the player, make sure that the surface can stand the weight of the player. Never place the player in a high location to avoid damage to the product or person by an accidental fall of the player.
- When you place this player near a TV, radio, or VCR, the playback picture may become poor and the sound may be distorted depending on the condition and location of said equipment. In such an event, place the player as far away as practical from the TV, radio, or VCR.
- To avoid damage to this product, never place or store the unit in direct sunlight; hot, humid areas; or areas subject to excessive dust, oily smoke, cigarette smoke or vibration.

## Notes on cleaning

Use a soft, dry cloth for cleaning.

- Do not use any type of solvent, such as thinner or benzene, as they may damage the surface of the player.

## About the volume level

The volume level of some commercial HD DVD and DVD discs may seem lower than that of audio CDs, other software, etc. If you turn up the volume of the TV or amplifier to play such discs, be sure to turn it back down after playback finishes.

## Playback restrictions

This owner's manual explains the basic instructions for this player. Some HD DVD discs or DVD video discs are produced in a manner that allows specific or limited operation during playback. As such, the player may not respond to all operating commands. This is not a defect in the player. Please refer to the notes on compatible discs later in this Introduction and to the discussion of DVD playback and features later in this manual.

"⊘" may appear on the TV screen during operation. "⊘" means that the operation is not permitted by the player or the disc.

## About software

Because of problems and errors that can occur during the creation of HD DVD, DVD and CD software and/or the manufacture of HD DVD, DVD and CD discs, Toshiba cannot assure that this player will successfully play every disc bearing the HD DVD, DVD or CD logos. If you happen to experience any difficulty playing an HD DVD, DVD or CD disc on this player, please contact Toshiba Customer Service.

## Some differences

The HD DVD player operates more like a computer and differently than a standard DVD player. In addition to containing a microprocessor, it contains an operating system, random access memory (RAM), and an HD DVD drive. The operating system includes software that is transferred to the RAM when the machine is turned on and at other times during operation. This transfer can take time. Therefore, when you turn the HD DVD player on, it may take a little while before it is ready to use. Likewise, other functions may not be performed as quickly as they would on other AV equipment. Please take these factors into consideration as you use the HD DVD player.

## Notes on moisture condensation

### Moisture condensation damages the unit. Please read the following carefully.

Moisture condensation occurs, for example, when you pour a cold drink into a glass on a warm day. Drops of water form on the outside of the glass. In the same way, moisture may condense on the optical pick-up lens inside this unit, one of the most crucial internal parts of the unit.

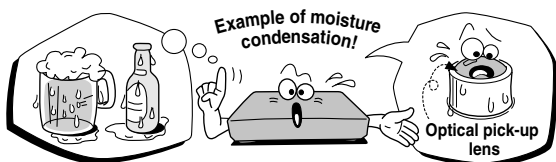

### Moisture condensation occurs during the following cases.

- When you bring the unit directly from a cold place to a warm place.
- When you use the unit in a room where you just turned on the heater, or a place where the cool air from an air conditioner blows directly on the unit.
- When the unit is moved from an air conditioned room to a hot, humid location.
- When you use the unit in a humid place.

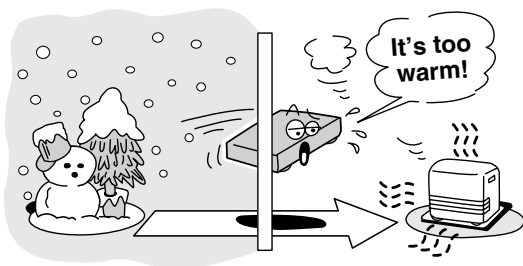

### Do not use the unit when moisture condensation may occur.

If you use the unit in such a situation, it may damage discs and internal parts. Connect the power cord of the unit to the wall outlet, turn on the unit, remove the disc, and leave it for two or three hours. After two or three hours, the unit will have warmed up and evaporated any moisture. Keep the unit connected to the wall outlet and moisture condensation will seldom occur.

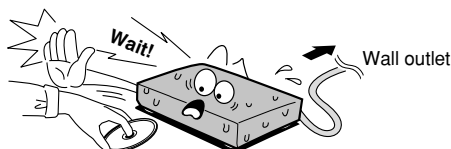

## Notes on copyright

- The unauthorized recording, use, display, distribution, or revision of television programs, videotapes, HD DVDs, DVDs, CDs and other materials, is prohibited under the Copyright Laws of the United States and other countries, and may subject you to civil and/or criminal liability.
- This product incorporates copyright protection technology that is protected by method claims of certain U.S. patents and other intellectual property rights owned by Macrovision Corporation and other rights owners. Use of this copyright protection technology must be authorized by Macrovision Corporation, and is intended for home and other limited viewing uses only unless otherwise authorized by Macrovision Corporation. Reverse engineering or disassembly is prohibited.

Dolby and the double-D symbol are registered trademarks of Dolby Laboratories.

U.S. Pat. No's. 5,451,942; 5,956,674; 5,974,380; 5,978,762; 6,226,616; 6,487,535 and other U.S. and world-wide patents issued and pending. "DTS" and "DTS Digital Surround" are registered trademarks of Digital Theater Systems, Inc.

HDMI, the HDMI logo and High-Definition Multimedia Interface are trademarks or registered trademarks of HDMI Licensing LLC.

SHARC and Melody are registered trademarks of Analog Devices, Inc.

**HD DVD** and **DVD** are trademarks of DVD Format/Logo Licensing Corporation.

All other brand and product names mentioned in this manual are trademarks and/or registered trademarks of their respective holders.

# Features

## Playback of HD DVD video discs

HD DVD video discs are high-density, high-capacity discs.

- The HD DVD disc standard has been approved by the DVD forum.
- HD DVD (single layer): 15 GB  
HD DVD (dual layer): Maximum capacity of 30 GB  
A single layer single sided disc (15 GB) has capacity of about 8 hours in 1125 line high definition picture; about 48 hours in 525 line standard definition picture (depending on bitrate of pre-recorded contents).  
\*1GB means 1,000,000,000 bytes.
- HD DVD Twin Format Discs have both HD DVD and DVD layers on one side. HD DVD Combination DVD Discs have HD DVD material on one side and standard DVD material on the other side. Because both disc types are new, such discs may not operate properly in this player.
- To view high-definition picture in HD DVD discs, an HDTV display (720p, 1080i, 1080p) is required.
- Connect an HDTV set to the COMPONENT OUTPUT jacks or the HDMI OUTPUT jack on this player.
- Some discs may require use of HDMI OUTPUT for viewing of high resolution material.

## Compatible with multiple disc types

- Playback of commercial HD DVD video disc, DVD video, and Audio CD
- Playback of DVD-RW (disc recorded in DVD VR mode or DVD video mode), and DVD-R
- Playback of CD-RW and CD-R (Audio CD of CD-DA format only; playback of MP3, WMA and other non-CD-DA audio formats are not supported.)

Because HD DVD is a new format, disc compatibility issues with new and existing format discs are possible. Not all discs are compatible. If you experience compatibility problems, please contact Toshiba Customer Service.

Blu-ray Discs cannot be played on this player.

## Internet connection feature (LAN port)

- Some HD DVD discs enable you to access special HD DVD sites. If an HD DVD site includes content such as movie trailers, you can watch the content on the player via the Internet if your internet connection provides sufficient bandwidth.

## HD output jacks

- An HDMI jack for connecting a single cable to output video and audio signals
- Component jacks
- 5.1 channel surround analog audio jacks

## Compatibility notes

- For compatibility, see  page 28.

## Certain system requirements

For high definition video playback:

- HD display (some discs may require HDCP capable input)
- HD DVD disc with HD content

For Dolby® Digital Plus and Dolby TrueHD multi-channel audio playback:

- A/V Receiver with HDMI™ multi-channel LPCM capable audio input and 5.1 channel speaker setup.



## Certain limitations

Viewing high-definition content and up-converting DVD content may require an HDCP capable input on your display device. 1080p capable display required for 1080p output resolution. Because HD DVD is a new format that makes use of new technologies, certain disc, digital connection and other compatibility and/or performance issues are possible. Some recordable media may not be supported. Dolby Digital Plus, Dolby TrueHD and DTS® support for up to 5.1 channels. DTS-HD support for DTS core only.

MP3/WMA audio files not supported. Please see [www.toshibahddvd.com](http://www.toshibahddvd.com) for more information.

Deep Color requires a Deep Color capable display device. Some devices may not be compatible.

Features subject to change and delayed availability.

The firmware in this player can be updated.

## Customer support

To reach Toshiba Customer Support in the U.S., please call 1 (800) 319-6684 or visit [www.tacp.com/customersupport](http://www.tacp.com/customersupport).

To reach Toshiba Customer Support in Canada, please call 1 (800) 268-3404 or visit [www.toshiba.ca](http://www.toshiba.ca) and click on support.

This HD DVD player is manufactured under the HD DVD Format adopted by the DVD Forum. The DVD Forum approved AACSS (Advance Access Content System) as content protection system for HD DVD format like it approved CSS (Content Scramble System) for DVD format. Therefore, certain restrictions are imposed on play, analog signal output, etc. of AACSS protected contents.

When you use pre-recorded contents, the contents may designate whether or not to apply such restrictions.

As those restrictions may be adopted and/or changed and announced by AACSS after the production of this product, the operation of this product and restrictions thereon may vary depending on the time you purchase this product as well as during the life of this product.

To obtain updated information about AACSS and this product, please contact the following:

\*In the U.S., please call 1 (800) 319-6684 or visit [www.tacp.com/customersupport](http://www.tacp.com/customersupport).

\*In Canada, please call 1 (800) 268-3404 or visit [www.toshiba.ca](http://www.toshiba.ca) and click on support.

# Accessories

## Accessories

Check that the following accessories are supplied.

### Remote control

Batteries (AAA)x4

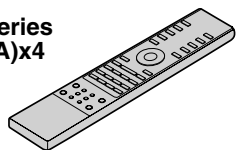

### Composite audio/video cable

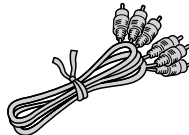

### Power cord

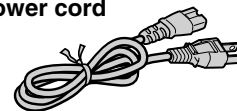

#### Caution

- Do not use this power cord with any device other than this player.

# Table of Contents

<b>1</b> Introduction	■ SAFETY PRECAUTIONS .....	2
	■ IMPORTANT SAFETY INSTRUCTIONS.....	4
	■ Precautions .....	6
	■ Features .....	8
	■ Accessories.....	9
	■ Index to parts and controls.....	12
	● Front panel .....	12
	● Rear panel.....	13
	● Display .....	14
	● Remote control.....	15
	■ Preparation of the remote control.....	16
	● Loading batteries .....	16
	● Operating with the remote control.....	16
	● About the remote control backlight.....	16
	● Programming for TV control .....	17
	● Operating your TV with the remote control.....	17
■ Hint on reading this manual .....	18	
● Icons for function applicability .....	18	
● Instructions and actual buttons.....	18	
<b>2</b> Connections	■ Connecting to a TV .....	20
	■ Connecting to an audio system .....	25
	● Via HDMI output .....	25
	● Via digital audio output .....	25
● Via 5.1ch analog audio output .....	26	
<b>3</b> Playback (Basic)	■ Disc compatibility .....	28
	■ Powering on/Loading a disc .....	30
	■ Playing a disc.....	31
	● Stopping playback / Pausing playback .....	31
	● Playing from the top menu .....	32
	● Using A/B/C/D buttons .....	32
	● Playing from a menu in a recorded disc .....	32
	● Selecting the sound .....	33
	● Selecting the sound of a disc recorded in DVD VR mode.....	33
	● Selecting subtitles .....	34
● Selecting the camera angle .....	34	
■ Playing at various speeds.....	35	
● Locating by entering a section number .....	36	
● Locating by entering elapsed time .....	36	
● Resuming playback from the location last stopped (Title resume).....	36	

## ■ Changing picture quality..... 37

- Adjusting picture quality .....37
- Selecting picture quality.....38

## 4

### Playback (Advanced)

## ■ Repeat playback ..... 40

## ■ EXTENSION ports ..... 41

## ■ Using the cursor function ..... 41

## ■ Checking the current status and settings ..... 42

## 5

### Internet connection

## ■ Internet connection feature (Outline)..... 44

## ■ Internet connection feature (Preparation)..... 46

## ■ Internet connection feature (Operation)..... 49

## 6

### Others

## ■ Customizing the function settings..... 52

- Picture .....54
- Audio .....55
- Language .....57
- Ethernet .....58
- General.....59
- Firmware update .....61

## ■ Language code list ..... 62

## ■ Output sound conversion table..... 63

## ■ License information on the software used in the TOSHIBA HD DVD player... 64

## ■ Before calling service personnel ..... 71

## ■ Specification ..... 72

## ■ Limited United States Warranty..... 74

## ■ Limited Canadian Warranty ..... 76

## ■ INFORMATION ON CUSTOMER SUPPORT ..... Back cover

# Index to parts and controls

See pages with arrows for details.

## Front panel

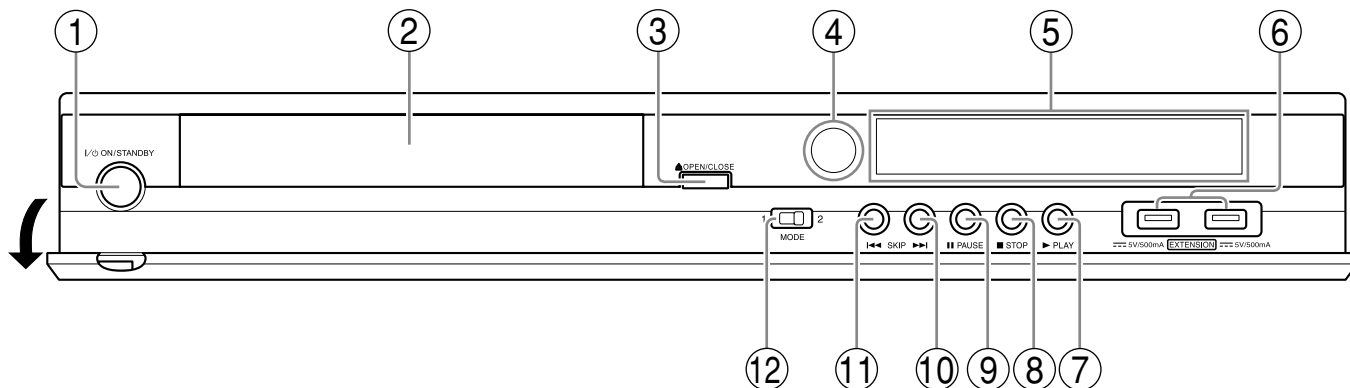

\* The above illustration displays the front panel with the cover open.

### Note

- Do not place a heavy object on the cover while it is open. Doing so may damage the player.

- |  |  |
|--|--|
| <p>① <b>ON/STANDBY button / ON/STANDBY indicator</b><br/>           ➡ page 30<br/>           Turns the power on/restores the unit to the standby mode.</p> <p>② <b>Disc tray</b> ➡ page 30<br/>           Loads a disc into the disc drive.</p> <p>③ <b>OPEN/CLOSE button</b> ➡ page 30<br/>           Opens and closes the disc tray.</p> <p>④ <b>Remote sensor</b> ➡ page 16</p> <p>⑤ <b>Front panel display</b> ➡ page 14</p> <p>⑥ <b>EXTENSION ports</b> ➡ page 41</p> <p>⑦ <b>▶ (PLAY) button</b> ➡ page 31<br/>           Starts playback.</p> | <p>⑧ <b>■ (STOP) button</b> ➡ page 31<br/>           Stops playback.</p> <p>⑨ <b>⏸ (PAUSE) button</b> ➡ page 31<br/>           Stops playback momentarily.</p> <p>⑩ <b>▶▶ (SKIP) button</b> ➡ page 35<br/>           Skips to the next chapter or track.</p> <p>⑪ <b>◀◀ (SKIP) button</b> ➡ page 35<br/>           Skips to the previous chapter or track.</p> <p>⑫ <b>MODE switch</b> ➡ page 20<br/>           Selects the video output jack.</p> |
|--|--|

## Rear panel

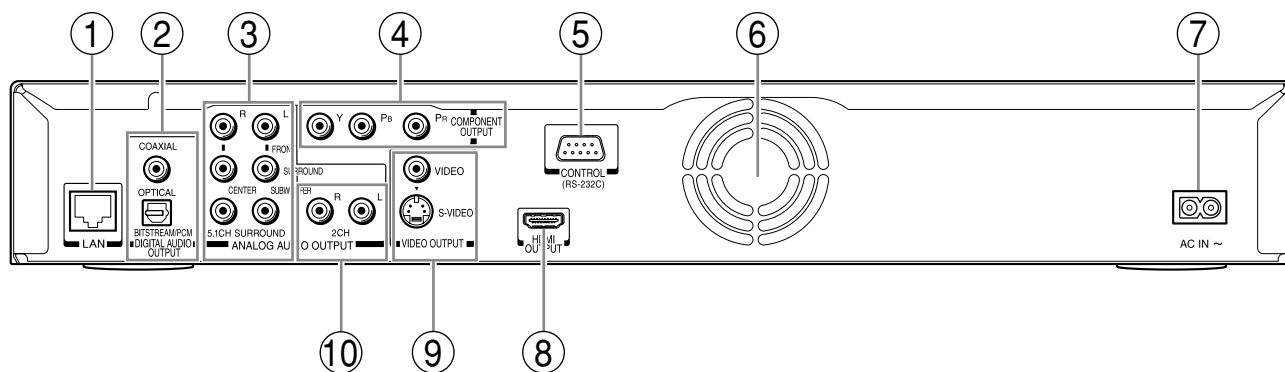

### ① LAN port ➔ page 46

Use this to connect to a network with an always-on broadband connection.

### ② DIGITAL AUDIO OUTPUT BITSTREAM/PCM (OPTICAL/COAXIAL) jack ➔ page 25

Outputs digital audio signals.

Connect to a digital audio input on an amplifier equipped with digital audio decoder.

When connecting the optional digital cable, fit the connector into the jack firmly.

### ③ ANALOG AUDIO OUTPUT 5.1 CH SURROUND jacks ➔ page 26

Connect to an amplifier equipped with 5.1 CH audio input.

### ④ COMPONENT OUTPUT jacks ➔ page 22

Outputs video signals to a connected TV or monitor.

Connect to a TV or monitor equipped with component video jacks.

### ⑤ CONTROL (RS-232C) jack

Used for custom control devices.

### ⑥ Ventilation fan

Do not cover the ventilation holes.

### ⑦ AC IN socket ➔ page 21, 22

Connect the supplied power cord.

### ⑧ HDMI OUTPUT jack ➔ page 21

Outputs video/audio signals to a connected TV, monitor or AV amplifier.

Connect to a TV, monitor or AV amplifier equipped with HDMI input.

### ⑨ VIDEO OUTPUT (VIDEO, S-VIDEO) jack ➔ page 22

Outputs video signals to a connected TV or amplifier.

### ⑩ ANALOG AUDIO OUTPUT jacks ➔ page 22

Outputs audio signals to a connected TV or AV amplifier.

## Index to parts and controls (Continued)

## Display

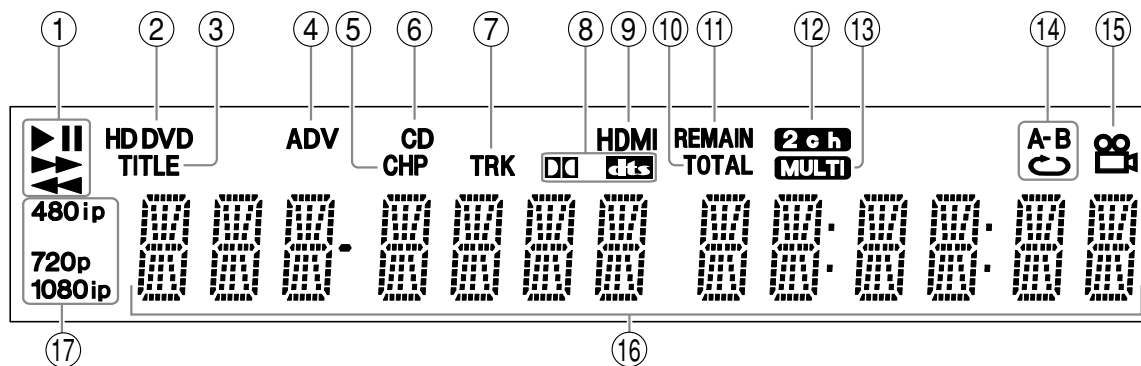
① **Status indicator**

- ▶ : Playing
- ⏸ : Pausing
- ⏩ : Fast forward playback
- ⏪ : Fast reverse playback

② **Disc indicator**

- HD DVD : Illuminates when an HD DVD disc is loaded.
- DVD : Illuminates when a DVD disc is loaded.

③ **TITLE indicator**

- Illuminates when a title number is displayed.

④ **ADV (Advanced) indicator**

- Illuminates when advanced content is played.

⑤ **CHP (Chapter) indicator**

- Illuminates when a chapter number is displayed.

⑥ **CD indicator**

- Illuminates when a CD is loaded.

⑦ **TRK (Track) indicator**

- Illuminates when a track number is displayed.

⑧ **Sound format indicator**

- ⓁⓁ : Illuminates when Dolby Digital sound is played.
- ⓁⓁⓁ : Illuminates when DTS sound is played.

⑨ **HDMI Indicator**

- Illuminates when HDMI connection is verified between the player and another device.

⑩ **TOTAL indicator**

- Illuminates when the total playing time of the disc is displayed.

⑪ **REMAIN (Remaining) indicator**

- Illuminates when a remaining playback time is displayed.

⑫ **2ch indicator**

- Illuminates when 2 channel (L/R) sound is output.

⑬ **MULTI indicator**

- Illuminates when 5.1 channel sound is output.

⑭ **Repeat mode indicator**

- Illuminates when playing in repeat mode.

⑮ **Angle icon indicator**

- Illuminates when playing a scene recorded with multi angles.

⑯ **Multi display**

- Displays the total playing time of the disc, elapsed time, remaining time, title number, chapter number or message, etc.

⑰ **Video output format indicator**

- Displays the video output format currently selected.
- 480i : 480 interlace
- 480p : 480 progressive
- 720p : 720 progressive
- 1080i : 1080 interlace
- 1080p : 1080 progressive

■ **Switching the display**

- DISPLAY Every time you press DISPLAY button on the remote control, the display changes the contents.
- The display may not change, depending on the disc conditions.

■ **Dimming the display**

- Pressing DIMMER button on the remote control changes the brightness of the display.

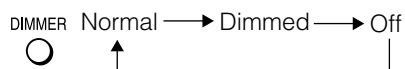

- Turning off the power resets this setting.

# Remote control

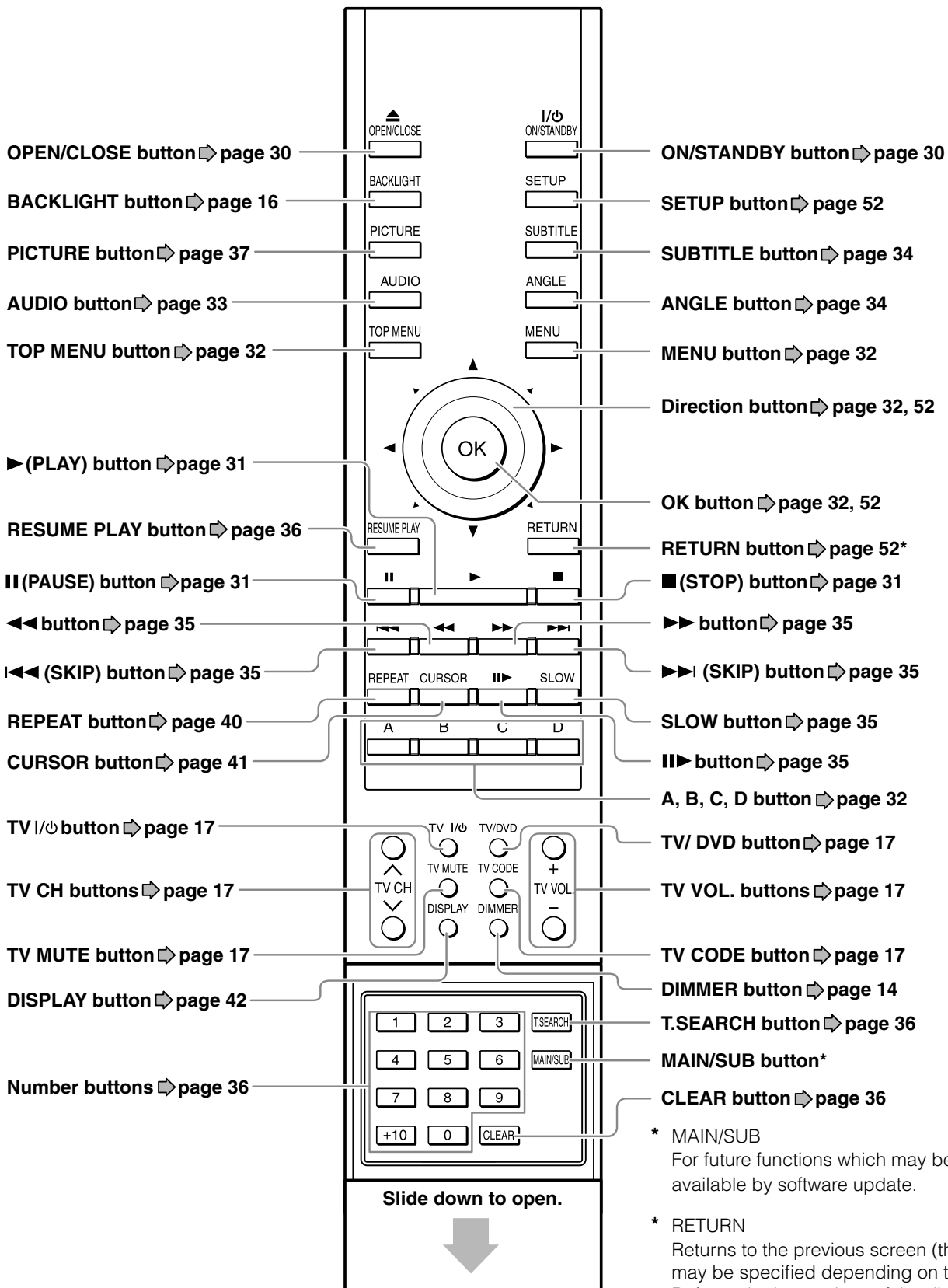

\* MAIN/SUB  
For future functions which may become available by software update.

\* RETURN  
Returns to the previous screen (the screen may be specified depending on the disc). Refer to the instructions of the disc.

# Preparation of the remote control

Set up the remote control to operate the player and your TV.

## Loading batteries

### 1 Open the cover.

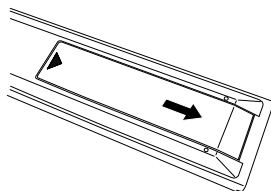

### 2 Insert batteries.

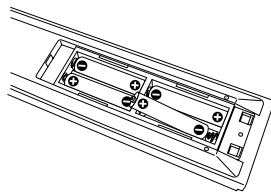

- Use 4 batteries (AAA sizes).
- Make sure to match the + and – on the batteries to the marks inside the battery compartment.

### 3 Close the cover.

## Notes

- Do not drop or give the remote control a shock.
- Do not leave the remote control near an extremely hot or humid place.
- Do not spill water or put anything wet on the remote control.
- Do not disassemble the remote control.
- Dispose of batteries in a designated disposal area.
- Batteries should always be disposed of with the environment in mind.
- Always dispose of batteries in accordance with applicable laws and regulations.
- If the remote control does not operate correctly, or if the operating range becomes reduced, replace all batteries with new ones.
- When necessary to replace batteries in the remote control, always replace all batteries with new ones. Never mix battery types or use new and used batteries in combination.
- Be sure to use AAA size batteries.
- Always remove batteries from remote control if they are dead or if the remote control is not be used for an extended period of time. This will prevent battery acid from leaking into the battery compartment.

## Caution

- Never throw batteries into a fire.

## About the remote control backlight

The remote control has a backlight function for conveniently illuminating the buttons when you use the remote control in a dark room, etc.

Lights for approximately 10 seconds when a button is pressed.

The backlight function is off by default.

## Operating with the remote control

Point the remote control at the remote sensor and press the buttons.

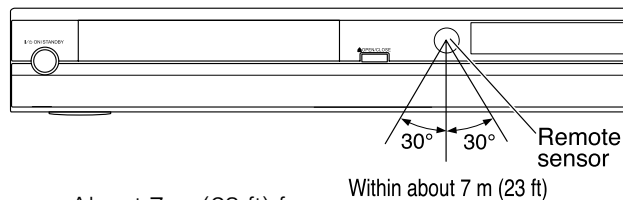

**Distance:** About 7 m (23 ft) from the front of the remote sensor

**Angle :** About 30° in each direction of the front of the remote sensor

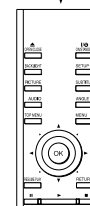



## Programming for TV control

**1** While holding , press the number buttons to enter a corresponding brand code (see below) of your TV.

e.g. To enter 0001



Hold down.

- Some brands have several codes. Try one by one until the remote control can operate your TV.

**2** Release .

The brand code is memorized.

### Notes

- TOSHIBA code is already set when you operate this player for the first time.
- When replacing the batteries of the remote control, re-enter the brand code of your TV.

### Brand code table

Brand name	Brand code					
Toshiba	0001	0021	0071	0411	0431	0831
	0841	0851	0881	1341	1611	1621
	1681	1781	1951	2121	2461	2491
	4071	4371	5951	5971	6041	6101
Bell & Howell	6111	6121	6131	6141		
	0081	0431				
Citizen	0051	0381	0471	0551	0621	0851
	1561					
Curtis Mathes	0051	0391	0431	0531	0621	0851
	1521	1561				
Emerson	0051	0111	0121	0141	0151	0161
	0201	0211	0351	0381	0431	0521
	0561	0571	0621	0691	1241	1291
	1371	1561	2481	4871		
Fisher	0251	0401	0431	1151	2451	2461
	0001	0041	0051	0091	0181	0321
GE	0371	0391	0591	0621	0711	0741
	1041	1471	1521	2481	4691	4881
	4891					

## Operating your TV with the remote control

Point the remote control to your TV after you have entered the brand code. Operate your TV with the buttons below.

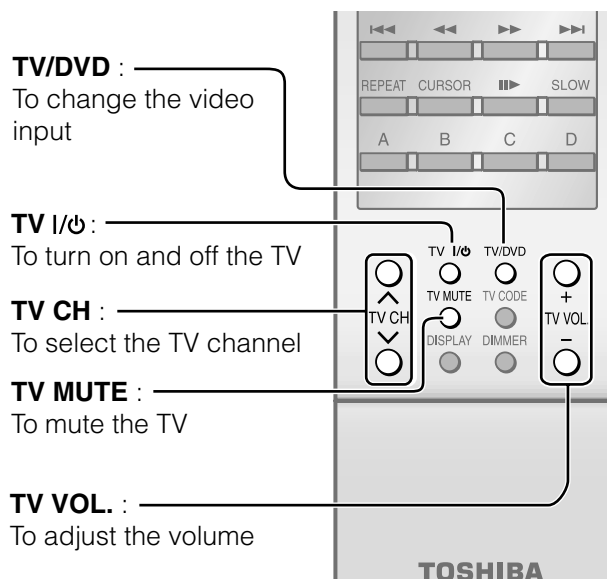

### Notes

- For some TVs, pressing the volume button once may change the volume by more than one level.
- Even after the player's remote control is programmed, it may not operate some or all of the features on your other device.

If this happens and you wish to use those features, you will need to use the device's original remote control.

(Continued)

## Preparation of the remote control (Continued)

Brand name	Brand code					
LXI	0311	0391	0411	0431	0621	0631
	0881	1041	1171	1521	2491	
Maganvox	0051	0271	0291	0341	0361	0421
	0551	0621	0631	0661	0971	0981
	1131	2221	5221	5231	5241	
Marantz	0051	0481	0621	0631	0641	2491
Memorex	0081	0431	0501	0621	2491	4421
	5251					
MGA	0051	0251	0261	0371	0501	0621
	0661	0761				
Mitsubishi	0051	0251	0261	0281	0371	0491
	0501	0621	0661	0761	2231	2241
	5261	5271				
MTC	0051	0501	0621	0851		
NAD	0311	0411	0621	0881	1061	
Optonica	0541	1101				
Panasonic	0631	0711	0741	1271	1351	1401
	1501	1701	1791	1801	2111	2151
	2301	2321	4101	5281	5291	5301
	5311	5321	5331	5341	5351	5361
	5371	5381	5391	5661		
Philco	0051	0161	0271	0291	0361	0421
	0501	0551	0621	0631	0661	0711
Philips	0051	0161	0271	0321	0361	0421
	0461	0551	0631	0661	0711	2141
	2351	5401	5411	5421	5431	5451
	5461	5471	5481	5491	5501	5531
	5541	5551	5601	5621		
Pioneer	0051	0621	0681	0721	0751	1061
	1241	1581	1971	4081	4111	
Proton	0051	0161	0621	0651	2491	
Quasar	0711	0741	0801	1401	2281	5651
	5661					
Radio Shack	0431	1521	2481			
Radio Shack/Realistic	0051	0161	0381	0391	0431	0541
	0621	1431	1561			
RCA	6641	0001	0051	0221	0391	0501
	0621	0661	0711	0871	0911	0921
	0941	1001	1041	1071	1091	1181
	1211	1241	1301	1461	1491	1521
	1531	2291	2481	4361	5671	5681
	5691	5701	5711	5721		







Brand name	Brand code					
Realistic	0431	1521				
Runco	0011					
Samsung	0051	0161	0501	0531	0621	0661
	0851	0931	1021	1141	1431	1561
	1591	1601	1771	1811	1821	1831
	1841	1851	1861	1931	2081	2101
	2311	4011	4061	5731		
Sanyo	0051	0261	0401	0431	0791	0901
	1151	2461				
Sears	0051	0151	0191	0251	0311	0331
	0391	0401	0411	0431	0621	0661
	0881	1041	1081	1151	1481	1521
	2461	2481				
Sharp	0051	0111	0161	0351	0541	0581
	0611	0621	0731	0891	1101	1561
	1721	1871	1881	1941	2181	2341
	5741	5751	5761	5771		
Sony	0441	1111	1231	1511	2401	2411
	2431	1891	1901	2061	2421	5781
	5791	5801	5811	5821	5831	5841
	5851	5861	5871	5881	5891	5901
	5911					
Soundesign	0051	0151	0381	0551	0621	2481
Sylvania	0051	0071	0271	0291	0341	0361
	0421	0551	0621	0631	0661	0861
	1441	2191	2201	4151	4441	5921
	5931					
Tandy	1101					
Technics	0741					
Teknika	0051	0081	0151	0161	0191	0341
	0381	0471	0501	0551	0621	0851
	1271	1401	1561	2481		
Wards	0051	0081	0141	0151	0181	0211
	0271	0321	0341	0361	0391	0421
	0501	0541	0621	0631	0661	1051
	1521	2491				
Zenith	0011	0051	0081	0781	1281	1571
	2091	2211	2251	2361	2391	2441
	4821	4831	4841	4851	6151	6161
	6171	6181				

## Hint on reading this manual

## Icons for function applicability

The following icons are used in this manual to indicate features and/or functions that are applicable to various types of discs.

(For disc compatibility information, see  page 28.)

Icon	Disc	Icon	Disc
	HD DVD video disc		Audio CD
	DVD video disc		CD-RW (CD-DA format)
	DVD-RW		CD-R (CD-DA format)
	DVD-R		

## Instructions and actual buttons

Most instructions are based on remote control operation, unless otherwise noted. You can use the buttons on the remote control and those on the main unit as well when they have the same function. Some functions are available only from the remote control.

# 2 Connections

Connect your player to your A/V system.

■ Connecting to a TV

■ Connecting to an audio system

# Connecting to a TV

## Step 1 Check the type of video input on your TV.

To view high definition content, use the **HDMI OUTPUT** jack or the **COMPONENT OUTPUT** jacks to connect to a TV.

Some discs may require use of the **HDMI OUTPUT** jack for viewing of high resolution material. Set the **MODE** switch according to your connection.

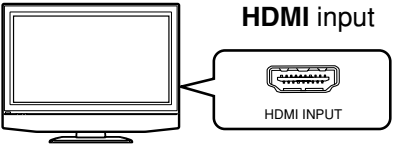
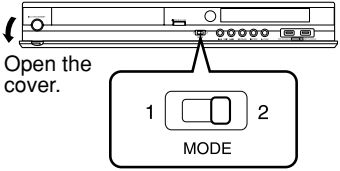
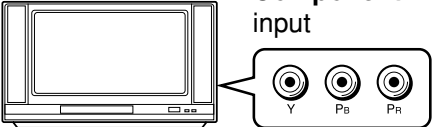
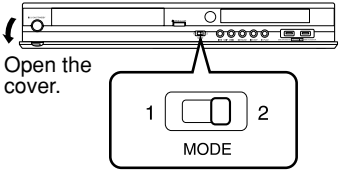
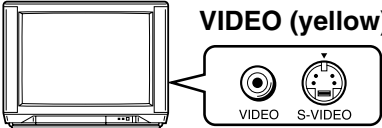
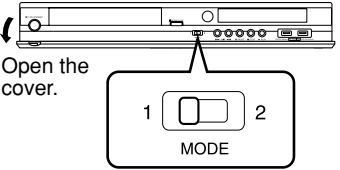
TV input	High definition video	MODE switch on the player Incorrect setting may disable the player's output.	Page
 <p><b>HDMI input</b></p> <p><b>Most recommended*</b></p>	<p><b>Viewable.</b> To view 1080p output, make this connection.</p>	 <p>Open the cover.</p> <p><b>Be sure to set while the power is off.</b></p>	<b>21</b>
 <p><b>Component video input</b></p>	<p><b>Viewable.</b> (Some discs may be down converted or require <b>HDMI connection.</b>) Not compatible with 1080p. To view 1080p output, select HDMI connection.</p>	 <p>Open the cover.</p> <p><b>Be sure to set while the power is off.</b></p>	<b>22</b>
 <p><b>S-VIDEO or VIDEO (yellow) input</b></p>	<p><b>Down converted.</b> (Some discs may require <b>HDMI connection.</b>)</p>	 <p>Open the cover.</p> <p><b>Be sure to set while the power is off.</b></p>	<b>22</b>

### \*Why HDMI connection is most recommended?

HD DVD and DVD video disc creators have the option to include copy protection instructions in their discs that prohibit the output of some standard video or high definition video (original 720p, 1080i or 1080p or up-converted 480i or 480p) from the **COMPONENT OUTPUT** jacks. If such instructions are present in the disc you are playing, you must use the **HDMI OUTPUT** jack to view the disc in a high definition format and the **COMPONENT OUTPUT** jacks, if activated, will output video only in 480i or 480p resolution.

### Caution on connection

- Do not power this player using any power cord other than the one supplied with this player.
- Do not use the supplied power cord with any device other than this player.

### Notes on connection

- When you connect the player to your TV, be sure to turn off the power and unplug both units from the wall outlet before making any connections.
- Connect the player directly to your TV. If you connect the player to a VCR, TV/VCR combination, video selector or AV amplifier, the playback picture may be distorted due to copy protection.

# Step 2 Connect the player to your TV.

## Via HDMI input

**HDMI stands for High Definition Multimedia Interface. HDMI transfers digital audio and uncompressed digital video on a single cable. As a result, audio cables and video cables don't need to be connected separately to a device. Use a commercially available authorized HDMI cable.**

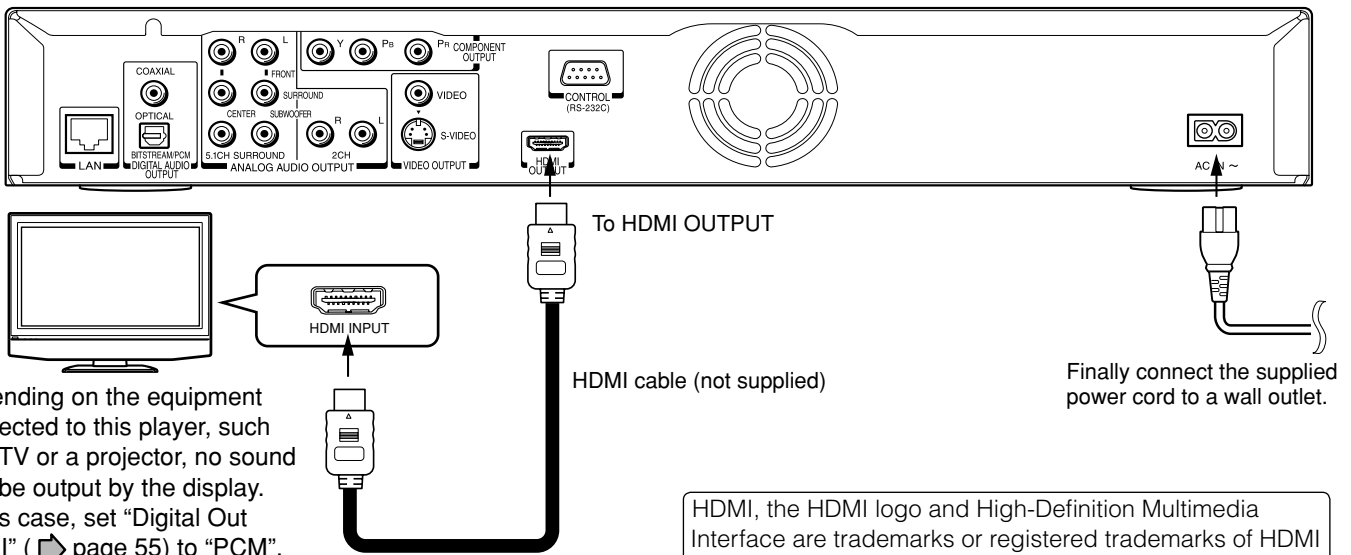

Depending on the equipment connected to this player, such as a TV or a projector, no sound may be output by the display. In this case, set "Digital Out HDMI" (▶ page 55) to "PCM". If sound still is not heard, use analog output.

HDMI, the HDMI logo and High-Definition Multimedia Interface are trademarks or registered trademarks of HDMI Licensing LLC.

This player supports simultaneous output of video on its HDMI and component video ports. However, some discs may restrict output of video on the component video ports when viewing high definition content or up-converted DVD content. The resolution on the HDMI output will be the same as the resolution output on the component video output. Thus, because the HDMI output can change automatically to match the maximum available resolution of your display, if you connect both the HDMI output and component output, the resolution on the component output will change if the HDMI output Auto-adjusts.

**After completing the connection, proceed to ▶ page 23 to make the setting.**

### Notes

- Refer to the owner's manual for the TV to be connected to this player for more information concerning HDMI connections.
- When the HDMI connection is not verified, an error message appears on the front panel display. In this case, disconnect the HDMI cable then connect it again, or turn off the connected HDMI device then turn it on.
- HDMI output is digital only, DVI analog is not supported.
- HDMI is an evolving technology, so it is possible that some devices may not operate properly with this player.
- Be sure to confirm compatibility of a cable when connecting a Deep Color compatible display device.

Connecting to a TV (Continued)

**Via component video input**

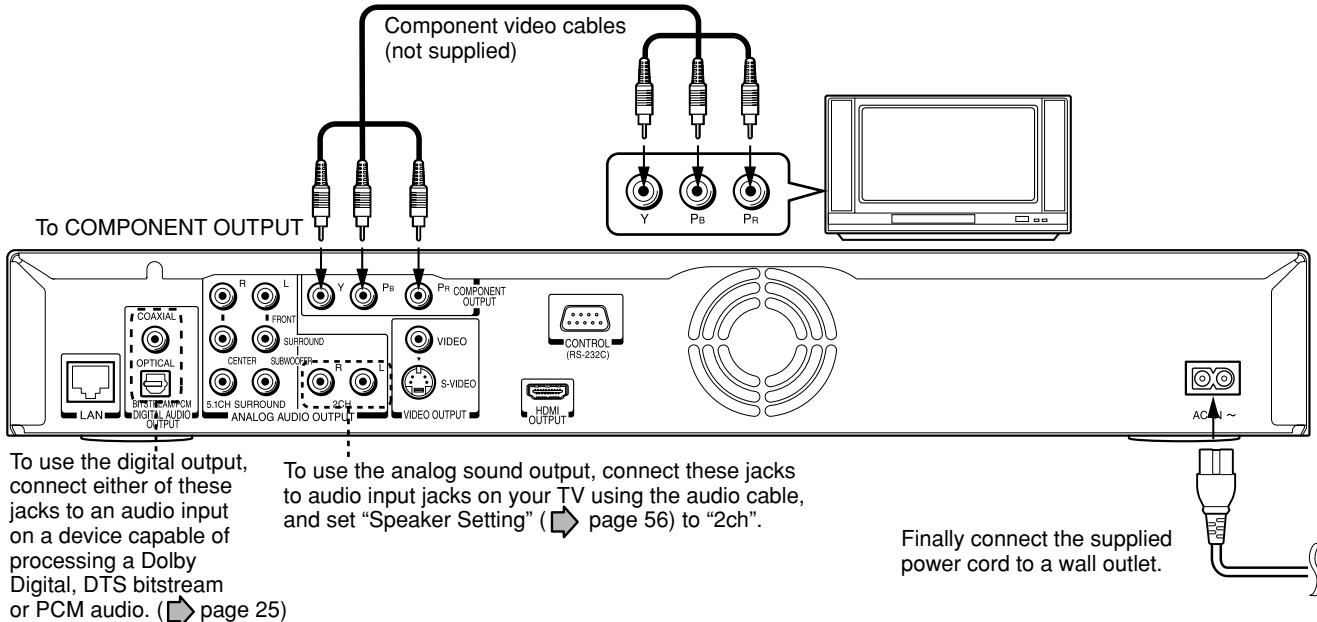

This player supports simultaneous output of video on its HDMI and component video ports. However, some discs may restrict output of video on the component video ports when viewing high definition content or up-converted DVD content. The resolution on the HDMI output will be the same as the resolution output on the component video output. Thus, because the HDMI output can change automatically to match the maximum available resolution of your display, if you connect both the HDMI output and component video output, the resolution on the component output will change if the HDMI output Auto-adjusts.

After completing the connection, proceed to ▶ page 23 to make the setting.

**Via S-VIDEO or VIDEO (yellow) input**

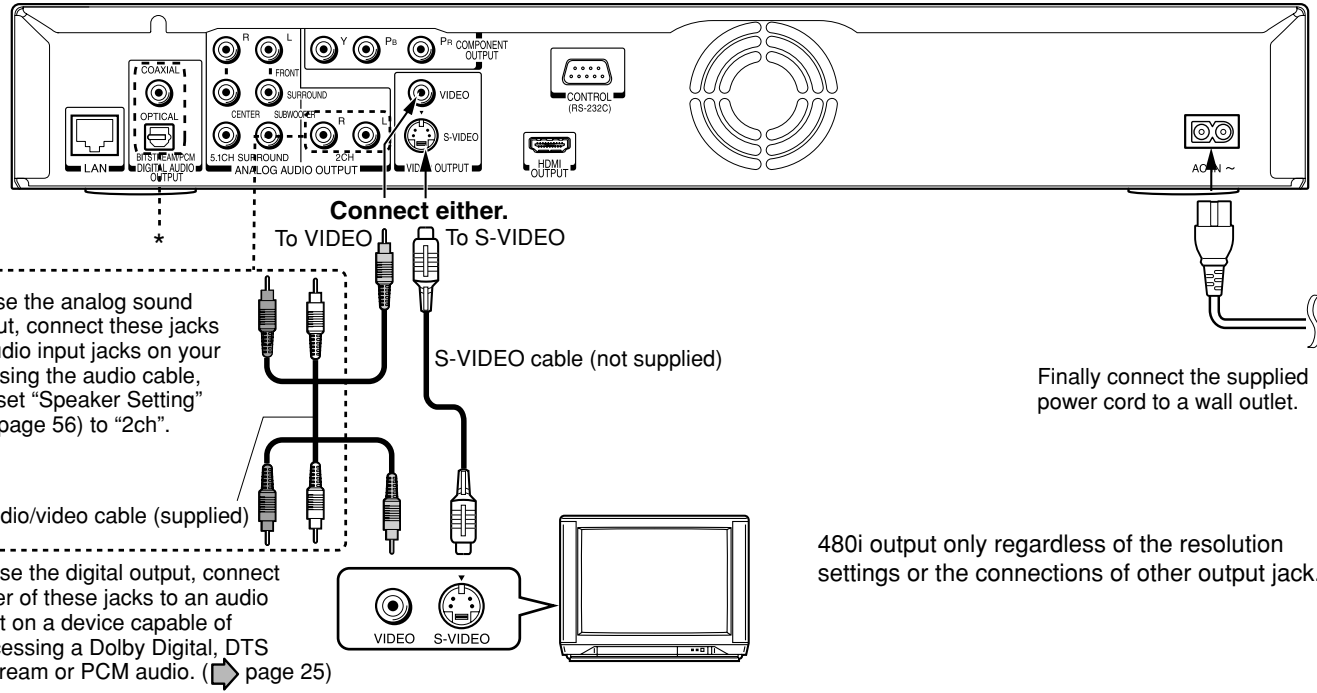

After completing the connection, proceed to ▶ page 23 to make the setting.

# Step 3 Configure settings for your display.

## Setting of video output resolution of this player

- 1 Turn on the TV and select the input to which the player is connected.
- 2 Press **ON/STANDBY** to turn on the player (➔ page 30).
- 3 Press **SETUP** to display "SETUP MENU", if not displayed.

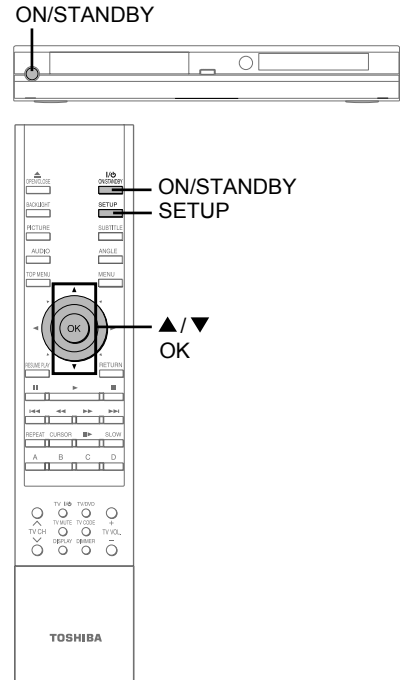
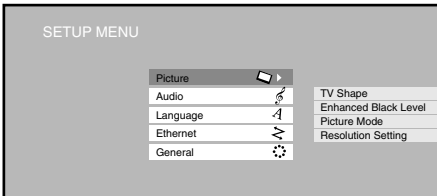

- 4 Press **▲ / ▼** to select "Picture" then press **OK**.
- 5 Press **▲ / ▼** to select "Resolution Setting", then press **OK**.
- 6 Press **▲ / ▼** to select the resolution according to the performance of your TV as shown in the table below.





TV input	"Resolution Setting"				
<p><b>HDMI input</b></p>	Select the resolution. e.g. <table border="1"> <tr><td>up to 480p</td></tr> <tr><td>up to 720p</td></tr> <tr><td><b>up to 1080i</b></td></tr> <tr><td>up to 1080p</td></tr> </table>	up to 480p	up to 720p	<b>up to 1080i</b>	up to 1080p
up to 480p					
up to 720p					
<b>up to 1080i</b>					
up to 1080p					
<p><b>Component video input</b></p>	Select the resolution according to the performance of the connected TV. e.g. <table border="1"> <tr><td>up to 480p</td></tr> <tr><td>up to 720p</td></tr> <tr><td><b>up to 1080i</b></td></tr> <tr><td>up to 1080p</td></tr> </table> Do not select "up to 1080p".	up to 480p	up to 720p	<b>up to 1080i</b>	up to 1080p
up to 480p					
up to 720p					
<b>up to 1080i</b>					
up to 1080p					
<p><b>S-VIDEO or VIDEO (yellow) input</b></p>	"Resolution Setting" selection is not necessary.				

- You may find that setting the output resolution of the player to match as closely as possible the native resolution of your display provides the best picture performance (e.g., 720p for 720p and 1080p for 1080p).
- Refer to the table on the next page as well.

- 7 Press **OK**.
- 8 Press **SETUP** to turn off "SETUP MENU".

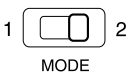
Connecting to a TV (Continued)

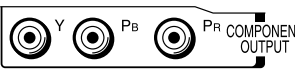
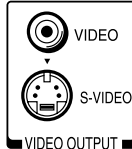
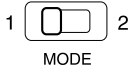
■ Settings and actual output resolution

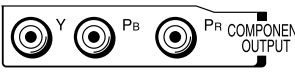
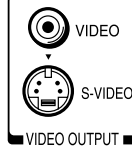
MODE switch (⇨ page 20)	Output jacks on the player	“Resolution Setting” (⇨ page 23)			
		up to 480p	up to 720p	up to 1080i	up to 1080p
 MODE	 HDMI OUTPUT	480p	720p (maximum) <sup>1</sup>	1080i (maximum) <sup>1</sup>	1080p (maximum) <sup>1</sup>
	 COMPONENT OUTPUT	480p <sup>2</sup>	720p <sup>2</sup>	1080i <sup>2</sup>	No video output.
	 VIDEO OUTPUT	No video output.			
 MODE	 HDMI OUTPUT	No video output.			
	 COMPONENT OUTPUT	480i			
	 VIDEO OUTPUT	480i			

<sup>1</sup> Maximum of the player's actual resolution according to a connected HDMI TV. The order of precedence is 1080p>1080i>720p>480p.

<sup>2</sup> Fixed. However, when an HDMI TV is also connected to the player, the player will select resolution in the same manner as in HDMI connection, i.e., <sup>1</sup>.



# Connecting to an audio system

You can enjoy the benefits of Dolby Digital Plus or Dolby TrueHD by connecting the HDMI output of your player to an AV receiver with an HDMI audio input. You can listen to down-converted Dolby Digital Plus and Dolby TrueHD as well as Dolby Digital and DTS using a receiver with Dolby Digital and DTS decoding capabilities and an optical digital input.

## Via HDMI output

Make the connection as below, and set "Digital Out HDMI" (➡ page 55).

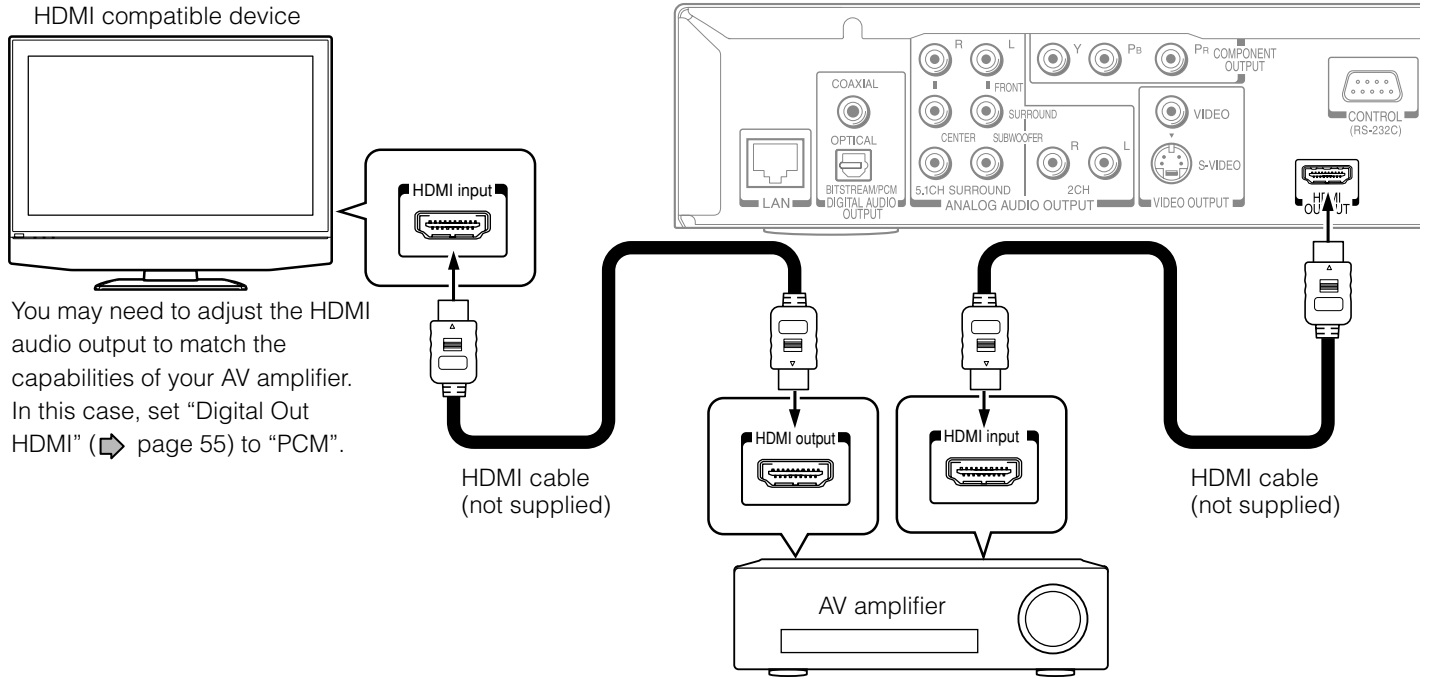

You may need to adjust the HDMI audio output to match the capabilities of your AV amplifier. In this case, set "Digital Out HDMI" (➡ page 55) to "PCM".

## Via digital audio output

Make the connection as below, and set "Digital Out SPDIF" (➡ page 55).

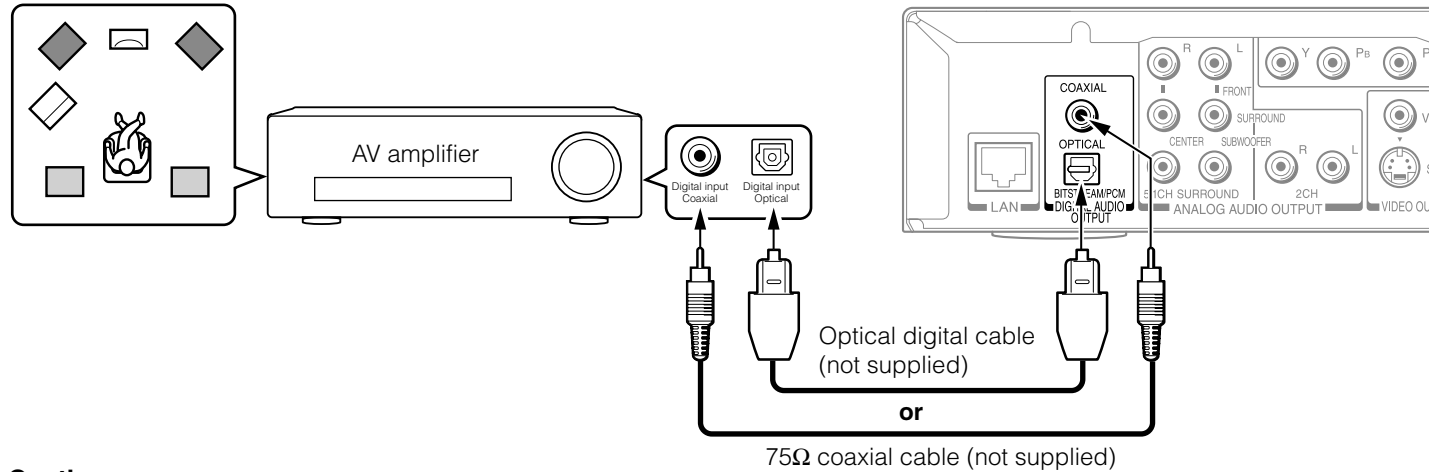

**Caution**

- When you are connecting (via the DIGITAL AUDIO OUTPUT BITSTREAM/PCM jack) an AV decoder that does not have Dolby Digital, DTS or MPEG decoding capability, be sure to set "Digital Out SPDIF" (➡ page 55) to "PCM". Otherwise, high volume sound may damage your hearing as well as the speakers.

Introduction

Connections

Playback (Basic)

Playback (Advanced)

Internet connection

Others

Connecting to an audio system (Continued)

**Via 5.1ch analog audio output**

Make the connection as below, and set "Speaker Setting" (➔ page 56).

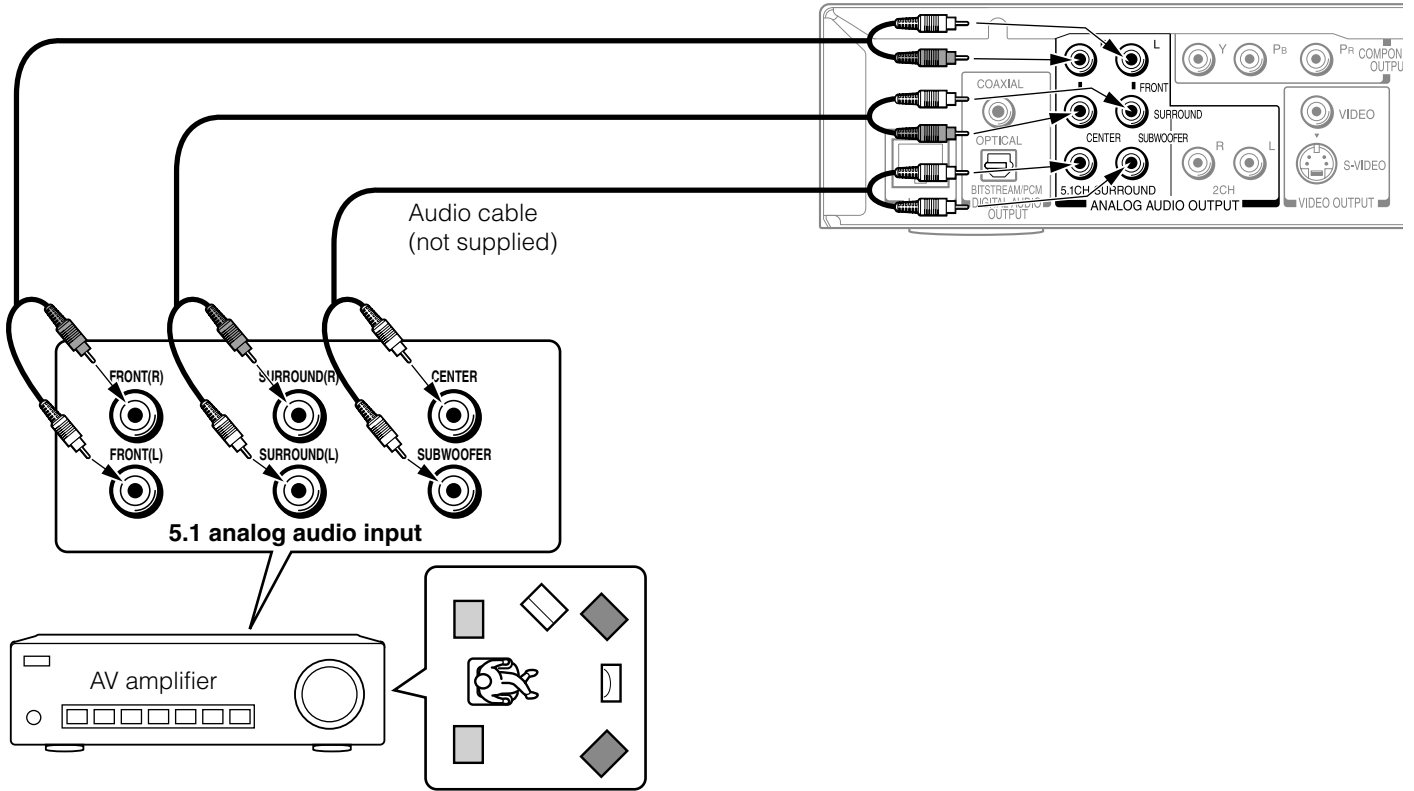

**Note about audio capabilities**

- Dolby Digital Plus and DTS-HD (DTS core only) capability limited to 5.1 channels.
- DTS-HD processing of DTS core only. Full DTS-HD is not supported.

Manufactured under license from Dolby Laboratories. Dolby and the double-D symbol are trademarks of Dolby Laboratories.

Manufactured under license from Digital Theater Systems, Inc. U.S. Pat. No's. 5,451,942; 5,956,674; 5,974,380; 5,978,762; 6,226,616; 6,487,535 and other U.S. and world-wide patents issued and pending. "DTS" and "DTS Digital Surround" are registered trademarks of Digital Theater Systems, Inc. Copyright 1996, 2003 Digital Theater Systems, Inc. All Rights Reserved.

# 3 Playback (Basic)

Play your favorite disc.

Disc compatibility

Powering on/Loading a disc





Playing a disc

Playing at various speeds



Changing picture quality

# Disc compatibility

## Pre-recorded discs

Disc	Specification
HD DVD video disc 	<ul style="list-style-type: none"> <li>• 12cm (4<sup>3</sup>/<sub>4</sub> in.)</li> </ul>
DVD video disc 	<ul style="list-style-type: none"> <li>• 12cm (4<sup>3</sup>/<sub>4</sub> in.)/ 8cm (3<sup>1</sup>/<sub>4</sub> in.)</li> <li>• Region number 1 or ALL</li> </ul> <p>The region number of this HD DVD player is 1. If region numbers, corresponding to a specific playable area, are printed on your DVD video disc and you do not find  or , or the disc is encoded to permit playback only in regions other than Region 1, disc playback will not be allowed by the player.</p>
Audio CD 	<ul style="list-style-type: none"> <li>• 12cm (4<sup>3</sup>/<sub>4</sub> in.)/ 8cm (3<sup>1</sup>/<sub>4</sub> in.)</li> </ul>



## Recordable discs you can play on this player

Disc	Specification
DVD-RW  Except Ver. 1.0	<ul style="list-style-type: none"> <li>• DVD VR mode recording (CPRM compatible discs supported.)</li> <li>• DVD Video mode recording</li> </ul> Finalized discs only.
DVD-R  DVD-R For DL	<ul style="list-style-type: none"> <li>• DVD VR mode recording (CPRM compatible discs supported.)</li> <li>• DVD Video mode recording</li> <li>• 4.7GB For General</li> </ul> Finalized discs only.

Disc	Specification
CD-RW	<ul style="list-style-type: none"> <li>• CD-DA (audio CD) format</li> </ul> Finalized discs only.
CD-R	<ul style="list-style-type: none"> <li>• CD-DA (audio CD) format</li> </ul> Finalized discs only.

### Notes

- Because HD DVD is a new format, disc compatibility issues with new and existing format discs are possible. Not all discs are compatible. If you experience compatibility problems, please contact Toshiba Customer Service, See  page 8 for more information about disc compatibility.
- This player can play pictures of the NTSC color system only.
- You cannot play non-standardized discs even if they may be labeled as above.
- Discs other than the above cannot be played. Even some of the above discs may not be able to be played depending on their state.
- MP3 and WMA audio formats are not supported.
- Blu-ray Discs cannot be played on this player.

 and  are trademarks of DVD Format/Logo Licensing Corporation.

## Compatibility notes

- Because HD DVD is a new format that makes use of new technologies, certain disc, digital connection and other compatibility and/or performance issues are possible. If you experience compatibility problems, please contact Toshiba Customer Service.
- Viewing high-definition content and up-converting standard DVD content may require an HDMI-capable input or HDCP-capable DVI input on your display device.
- Some HD DVD discs and DVD discs may restrict the use of some operation commands or features.
- Dolby Digital Plus, Dolby TrueHD and DTS-HD (DTS core only) capability limited to 5.1 channels.
- DTS-HD processing of DTS core only. Full DTS-HD is not supported.
- Some DVD-R/DVD-RW and CD-R/CD-RW discs may be incompatible due to laser pick-up and disc design.
- CD-R/CD-RW discs must be recorded using CD-DA method for CD audio playback.
- The included remote control may not operate some or all features of your TV or monitor, so it may be necessary to use your original remote control.
- Certain features are subject to delayed availability.
- This product includes memory that is used to store some disc related information, including downloaded on-line content. The disc you are using will control how long this information is retained.

### Note

- The firmware in this player can be updated. See ➡ page 61 for details.

## On handling discs

- Do not touch the playback side of the disc.
- Do not stick paper or tape to discs.

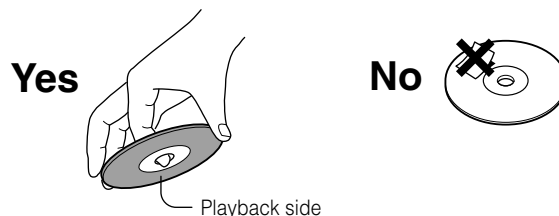

## On cleaning discs

- Fingerprints and dust on the disc may cause picture and/or sound deterioration or prevent playback. Wipe the disc from the center outwards with a soft cloth. Always keep the disc clean.



## On storing discs

- Do not store discs in a place subject to direct sunlight or near heat sources.
- Do not store discs in places subject to moisture and dust such as a bathroom or near a humidifier.
- Store discs vertically in a case. Stacking or placing objects on discs outside of their case may cause warping.
- Refer to the instructions of the disc as well.

# Powering on/Loading a disc

## Turning the power on

- 1** Press  (front panel) or  (remote control).

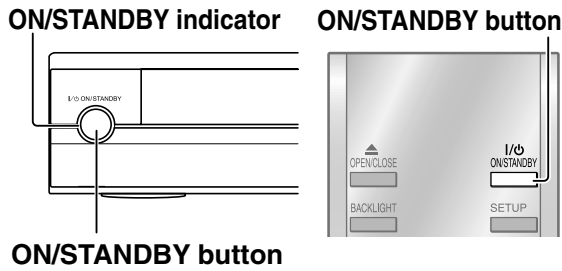

When the power turns on, ON/STANDBY indicator on the front panel changes color from red (standby mode) to blue (operation).

Start up (and disc loading (see below)) may take time.

### Note

- When you power on this player for the first time, the setting screen will appear. Please refer to  page 52 and select “General” > “Clock Set”. Check the date and time are set properly and correct them if necessary. When complete, press SETUP to exit. Your player is ready.

## Turning the power off

- 1** Press **ON/STANDBY**.
- The power turns off and ON/STANDBY indicator on the front panel turns red (standby mode).

### Note

- If the player freezes for about 15 minutes or more and will not respond to any buttons, holding down ON/STANDBY button on the front panel for about 10 seconds can force the player to turn off. However, this is an emergency measure, which may cause damage to the player. Avoid casual use of this measure.

## Loading a disc

- 1** Press  (front panel) or  (remote control).

The player opens the disc tray.

- 2** Place a disc in the hollow of the disc tray with the playback side down.

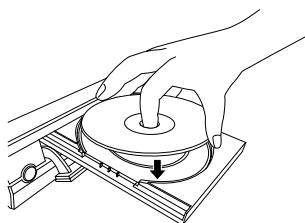

When using a double-sided disc, turn the label of the playing side up.

After placing a disc, press OPEN/CLOSE.

### Notes

- Use the button on the front panel or the remote control to open and close the disc tray. Do not push or hold the disc tray while it is moving. Doing so may cause the player to malfunction.
- Do not load a disc which is unplayable, or any object other than a playable disc.
- Do not apply downforce to the disc tray. Doing so may cause the player to malfunction.
- If the disc tray stops while closing, the mechanical protection system of this player will open it. Do not force it to close. Doing so may damage the disc tray.
- If the disc tray will not open, turn the player off, and press OPEN/CLOSE on the front panel. This may turn the player on and open the disc tray. If it still won't open, contact TOSHIBA Customer Support.

# Playing a disc

HD DVD	DVD-Video	DVD-RW
DVD-R	CD	CD-RW (CD-DA)
CD-R (CD-DA)		

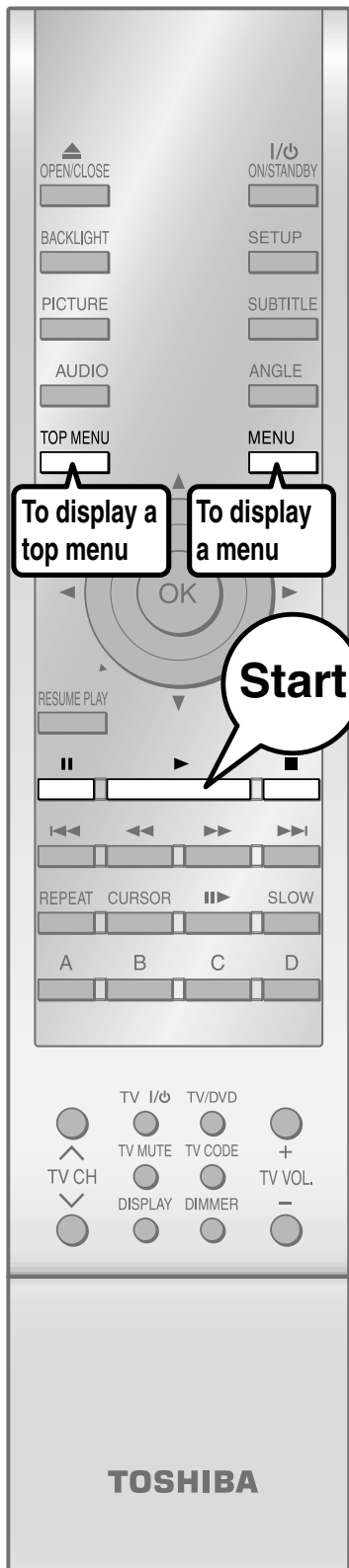

## Preparation

- 1 Turn on the TV or audio system and select the corresponding input source that the player is connected to.
- 2 Turn the power on. (➡ page 30)

## 1 Load a disc and close the disc tray. (➡ page 30)

Playback starts.

### ● If playback does not start

Press .

### HD DVD | DVD-Video

If a loaded disc contains a top menu, a top menu appears when you start playback.

Depending on the disc, you may need to press or to display a top menu.

("Playing from the top menu", ➡ page 32)

### DVD-RW | DVD-R

If a loaded disc contains a title menu, you can display it to select a desired title.

("Playing from a menu in a recorded disc", ➡ page 32)

### CD | CD-RW (CD-DA) | CD-R (CD-DA)

Playback starts automatically.

## Stopping playback / Pausing playback

Press .

Playback stops.

During playback, press .

Playback pauses.

To resume, press .

**Playing a disc (Continued)****Playing from the top menu**



HD DVD | DVD-Video

Some discs may include a top menu, on which you can view the structure of contents or select a scene.

- 1** Press **TOP MENU** .
 

A top menu appears.
- 2** Press **▲/▼/◀/▶** to select the title you want.
 

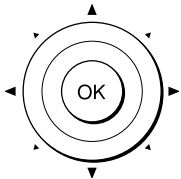
If the titles in the top menu are assigned a number, you can directly locate a specific title by pressing its designated number with the number buttons.

- 3** Press **OK** .
 

Playback starts from chapter 1 of the selected title.

**Notes**

- The instructions above describe basic procedures which may vary depending on the contents of a disc. If different instructions appear on the TV screen, follow those instructions.
- If you display the top menu during playback and press TOP MENU button again without selecting any title, the player may resume playback from the point where you first pressed TOP MENU button (depending on the actual disc.)
- This method of locating a title is available only on a disc that contains a top menu.
- Instruction notes of discs may refer to the button that displays the top menu as TITLE button.
- Depending on a disc, MENU button may have to be pressed instead of TOP MENU button to display the top menu.

**Using A/B/C/D buttons**

HD DVD



Use these buttons as indicated by the video display during HD DVD disc playback. Depending on the disc contents, the functions of each button may differ.

**Playing from a menu in a recorded disc**

DVD-RW | DVD-R

Discs recorded on personal devices such as DVD recorders may contain menus, on which items can be easily selected.

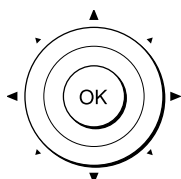
- 1** Press **MENU** .
 

Recorded contents are displayed.
- 2** Press **▲/▼/◀/▶** to select the item you want.
 
- 3** Press **OK** .
 

Playback of the selected item starts.

**Notes**

- Disc menus vary depending on the disc or the recording device. Some discs may not contain a disc menu.
- Discs recorded in DVD VR mode display the recorded contents not in thumbnails but in a list. Select an item on the list and press OK button.



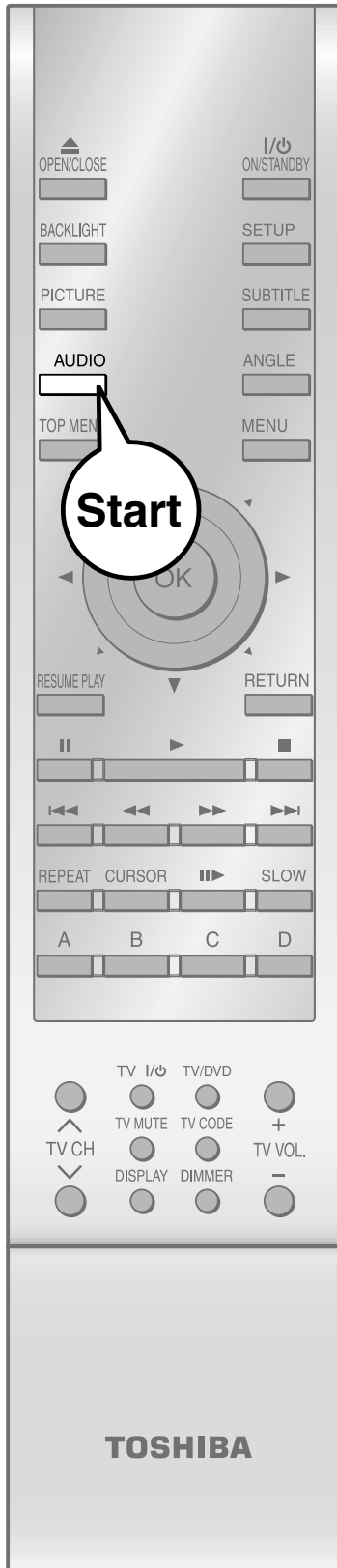

## Selecting the sound

HD DVD   DVD-Video   DVD-RW   DVD-R

If a disc contains several languages, you can select a preferred language from them to hear.

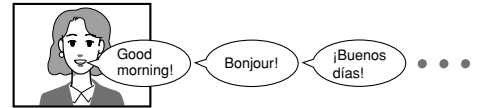

**1** During playback, press **AUDIO**.

e.g.

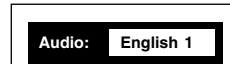

Language code (→ page 62)

Some HD DVD video discs may not display this window.

**2** Press **AUDIO** while the audio setting is displayed on the TV screen.

### Notes

- Some discs allow you to change audio selections only via the disc menu. If this is the case, press MENU button and choose the appropriate language from the selections on the disc menu.
- When you turn on the player or replace a disc, the player returns to the initial default setting (→ page 57). Depending on a disc, a specific type of audio the disc has is output.
- Immediately after you have switched audio output modes, there may be a temporary discrepancy between the display and actual sound.

## Selecting the sound of a disc recorded in DVD VR mode

DVD-RW   DVD-R (DVD VR mode)

When playing a disc recorded in DVD VR mode, select the sound as follows.

**1** During playback, press **AUDIO**.

- The current audio setting appears.
- The language code appears instead of the language name. Refer to the list of languages and their abbreviations. (→ page 62)

**2** Press **AUDIO** while the audio setting is displayed on the TV screen.

Each time you press the button, the sound changes.

e.g.

### Stereo sound contents

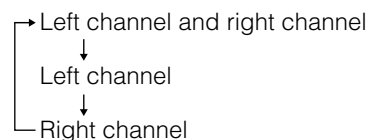

## Playing a disc (Continued)



## Selecting subtitles

HD DVD | DVD-Video

You can display subtitles on the TV and select a subtitle language from those included on the disc.

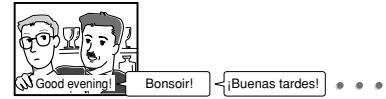
**1** Press **SUBTITLE** during playback.

The current subtitle setting appears.

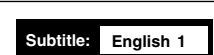
e.g.  Some HD DVD video discs may not display this window.

Language code (▶ page 62)

Each time you press ◀▶, “On” and “Off” alternate. Select “On” to view subtitles.

**2** Press **SUBTITLE** while the subtitle setting is displayed on the TV screen.

Subtitle languages which do not appear in the setting are not included in the disc.

## Notes

- Some discs are set to display subtitles automatically.
- Depending on the scene, subtitles may not appear immediately after you set the subtitle function to on.
- Some discs will allow you to change subtitle languages and turn subtitles on or off only via the disc menu.
- When you turn on the player or replace a disc, the player returns to the initial default setting (▶ page 57). Depending on a disc, a specific type of subtitles the disc has is output.
- Depending on the scene, the subtitle language may not change immediately after selected.

## Selecting the camera angle

HD DVD | DVD-Video

If the scene was recorded with multiple angles, you can easily change the camera angle of the scene you are watching.

**1** Press **ANGLE** while playing a scene recorded with multiple angles.

While playing a scene recorded with multiple angles, the angle icon appears on the TV screen and on the front panel. Press ANGLE button while the angle icon is displayed.

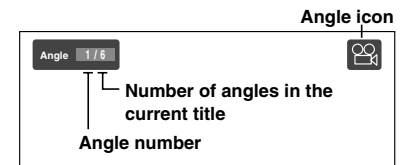

Some HD DVD video discs may not display this window.

**2** While the angle number is displayed, press **ANGLE** repeatedly to select the angle number.

## Notes

- You can also change the camera angle during still playback. The camera angle changes to the new setting when you resume normal playback.
- If you pause a picture immediately after changing a camera angle, the resumed playback picture may not display the new camera angle.

# Playing at various speeds

HD DVD	DVD-Video	DVD-RW
DVD-R	CD	CD-RW (CD-DA)
CD-R (CD-DA)		

## Skipping chapters or tracks

Playback starts from the beginning of the current chapter or track. When you press twice, playback starts from the beginning of the previous chapter or track.

➔ Page 36

## Playing frame by frame



During playback, press .

Picture pauses.

If you press  while a picture is paused, you can play the picture frame by frame.

- To resume normal playback, press .
- Some discs may not permit this operation.

## Playing in fast reverse or fast forward

During normal playback, press  / .

: Fast reverse playback

: Fast forward playback

- Each time you press the button, the playback speed changes.
- To resume normal playback, press .

## Skipping chapters or tracks

Playback starts from the beginning of the next chapter or track.

## Playing in slow-motion

Press  during playback.

Picture is played forward in slow-motion.

- Each time you press the button, the slow-motion speed changes.
- To resume normal playback, press .
- Not available in CD playback.

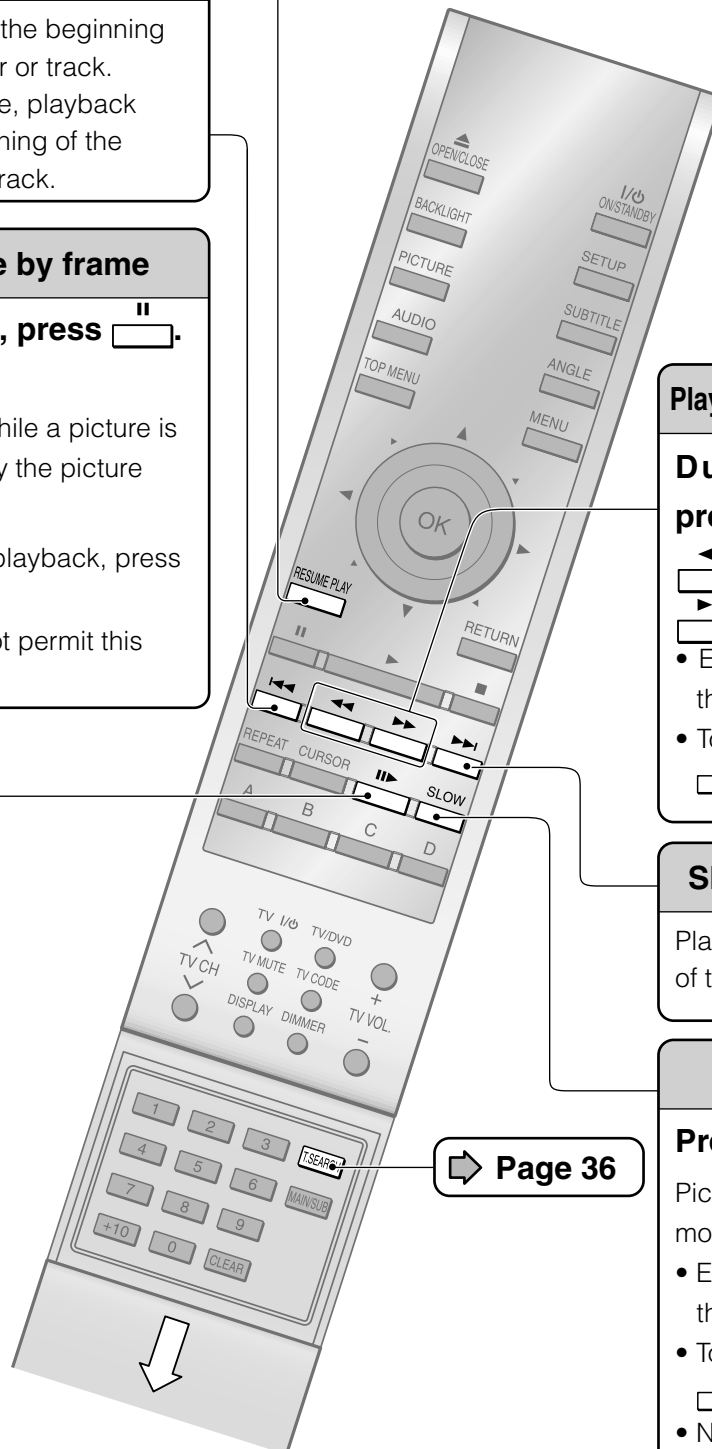

➔ Page 36

## Playing at various speeds (Continued)

### Locating by entering a section number

HD DVD	DVD-Video	DVD-RW	DVD-R	CD	CD-RW (CD-DA)
CD-R (CD-DA)					

Normally titles, chapters, and tracks are numbered. By entering these numbers, you can access a desired section.

**1** Press **T.SEARCH** repeatedly to select the area you want to input.

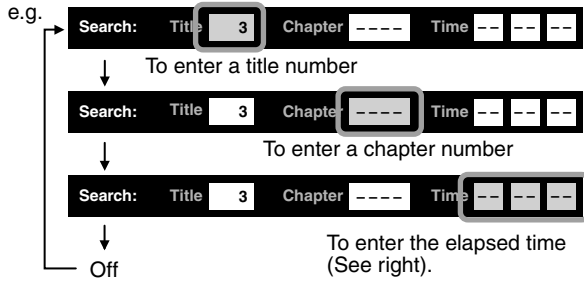

- The actual display may vary depending on the disc.

The cursor shifts also by ◀/▶.

**2** Press the number buttons to enter a number of the section.

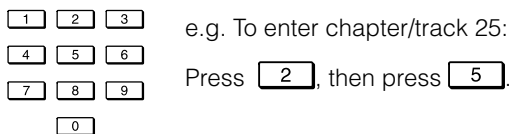

- Pressing CLEAR resets the numbers. To turn off the display, press T.SEARCH several times (depending on the disc).

**3** Press **OK**.

Playback starts from the selected section.

#### Notes

- Some discs may not permit these operations.
- When the ADV indicator on the front panel is illuminated, these features are not available.

### Resuming playback from the location last stopped (Title resume)

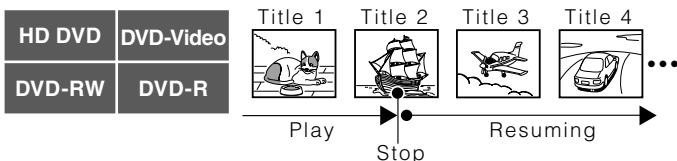

**You can resume playback from the location last stopped.**

If you press **RESUME PLAY** after stopping playback, playback starts from the location last stopped.

If you press **■** after stopping playback, the resume feature is canceled.

### Locating by entering elapsed time

HD DVD	DVD-Video	DVD-RW	DVD-R	CD	CD-RW (CD-DA)
CD-R (CD-DA)					

**1** Press **T.SEARCH**.

You may have to press repeatedly, depending on a disc. Press the button until the cursor moves to "----" area.

e.g.



**2** Press the number buttons to enter the desired time location on the disc.

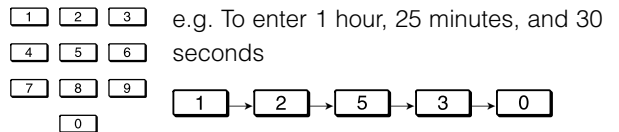

- Pressing CLEAR resets the numbers.

**3** Press **OK**.

Playback starts from the specified location.

#### Notes

- Resume feature cannot function when:
  - you select a disc menu language (▶ page 57) or change the parental lock setting (▶ page 59).
  - you open the disc tray.
- There may be a difference in the location where playback resumes depending on the disc.
- It is possible to change the setting from the setup menu while the player retains a location in memory, however, the new setting can be valid only after the player clears the location memory, i.e., starts resume playback.
- Some discs or scenes may not permit this operation.
- While the ADV indicator on the front panel illuminates, this feature is not available.

# Changing picture quality

HD DVD DVD-Video DVD-RW  
DVD-R

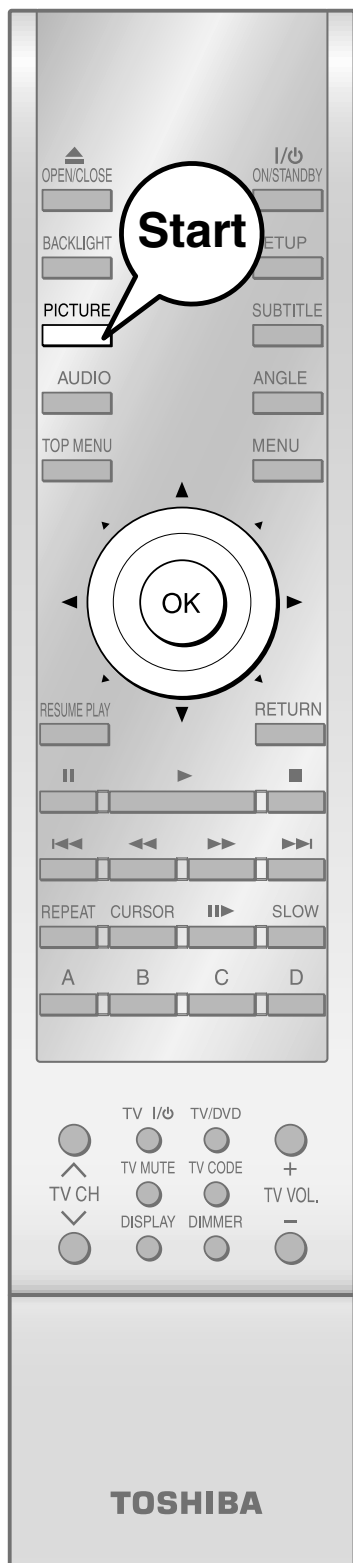

You can adjust picture quality and save the adjustment values up to 3 sets. These may be used, e.g. for each preference of 3 separate people or for 3 favorite genres of contents.

## Adjusting picture quality

- 1** Press **PICTURE** .

The menu appears.

Picture Setting	
1	Edit
2	Edit
3	Edit
- 2** Press **▲/▼/◀/▶** to select “Edit” of “1”, “2” or “3”, then press **OK** .
- 3** Press **▲/▼** to select the item (see below), then press **OK** .
- 4** Press **◀/▶** to change the value.

You can scroll the items by **▲/▼** .
- 5** When complete, press **PICTURE** .

See the next page for selecting of the picture quality.

Item	Value
Contrast	(-7) Weaker ↔ Stronger (+7)
Brightness	(0) Darker ↔ Brighter (+14)
Color	(-7) Duller ↔ Brighter (+7)
Tint	(-7) Red ↔ Green (+7)
Selective Color Enhancement	(-7) Duller in certain color ↔ Brighter in certain color (+7)
Edge Enhancement <sup>1</sup>	(OFF/1/2) (1: Low, 2: High) Effect to enhance picture edges.
Mosquito NR <sup>2</sup>	(OFF/ON) Reduction of mosquito (scattering) noise produced in MPEG compression process.
Block NR <sup>2</sup>	(OFF/ON) Reduction of block noise, which may appear especially on fast-moving pictures, produced in MPEG compression process.
Random NR <sup>2</sup>	(OFF/ON) Reduction of occasional and irregular noise.

1: May not be effective in HD DVD disc playback.

2: Not effective in HD DVD disc playback.

**Changing picture quality (Continued)****Selecting picture quality**

At step 2 (⇒ page 37), select the number (“1”, “2” or “3”), then press .

Playback picture reflects the selected picture quality.

# 4 Playback (Advanced)

Playback variations and other functions.

Repeat playback

EXTENSION ports

Using the cursor function

Checking the current status and settings

# Repeat playback

	DVD-Video	DVD-RW
DVD-R	CD	CD-RW (CD-DA)
CD-R (CD-DA)		

You can repeat a desired section.

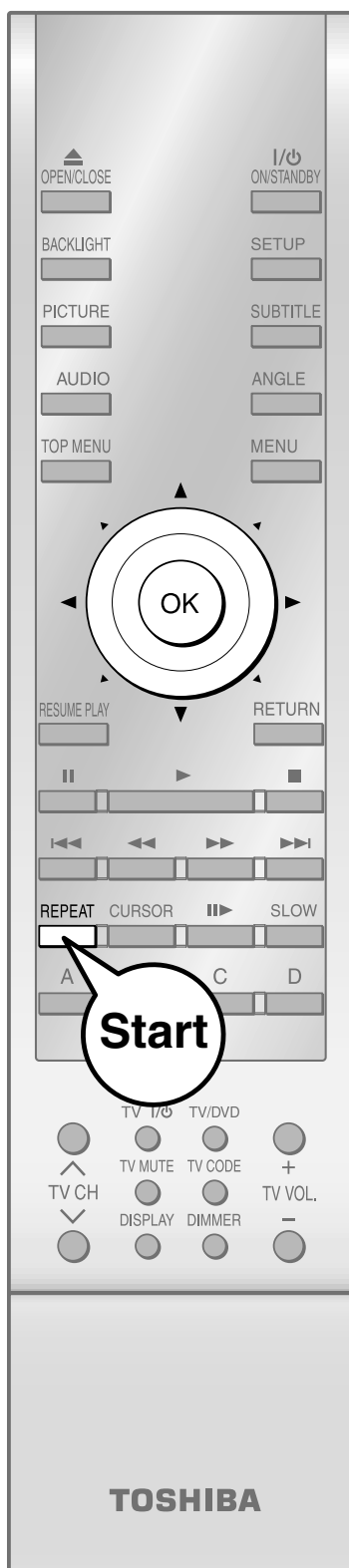
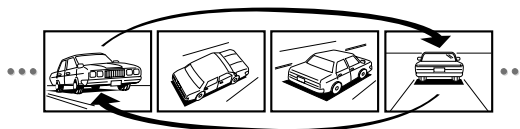

## 1

Press **REPEAT**.

The repeat modes are listed.

## 2

Press **▲/▼** to select the repeat mode.

(The selections on the list vary depending on category or status of a disc.)

e.g.

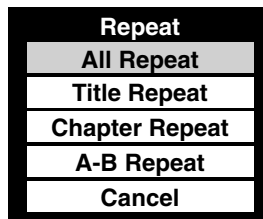

### All Repeat:

Repeats the entire disc.

(Not available in playback of a disc recorded in DVD VR mode.)

### Title Repeat:

Repeats the same title.

### Chapter Repeat:

Repeats the same chapter.

### Track Repeat:

Repeats the same track.

### Disc Repeat:

Repeats the entire disc.

### A-B Repeat:

Repeats the specified segment.

Select and press OK.

Perform step 1) and 2) below and skip step 3.



- 1) While the above display appears, press OK at a start point of a segment where you want to repeat.

The display changes to "B Point".



- 2) Press OK at an end point of a segment where you want to repeat.

Playback returns to the point A and repeats between A and B.

## 3

Press **OK**.

Repeat playback starts.

### Notes

- Some discs may not permit repeat playback operation.
- You can cancel repeat playback also by pressing **REPEAT**.



## EXTENSION ports

### HD DVD

The EXTENSION ports may be used in the future for additional control options.

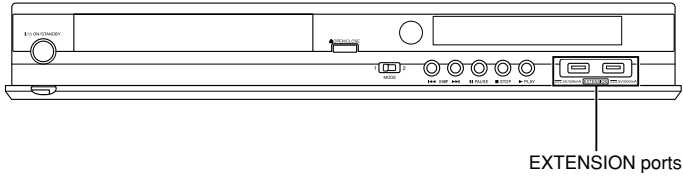

## Using the cursor function

### HD DVD

Future HD DVD discs may include game software and drawing software. If they do you can use the cursor function for some software.



**1** Press **CURSOR** while a disc with support for cursor use is playing.

**2** Use the eight direction buttons to move the cursor.

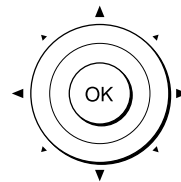

Example: Game/drawing software

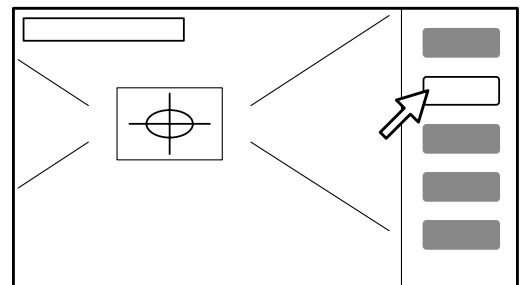

Move the cursor to select the game target or selection item. For details on actual operations, also refer to the operations guide for the disc.

# Checking the current status and settings

HD DVD	DVD-Video	DVD-RW
DVD-R	CD	CD-RW (CD-DA)
CD-R (CD-DA)		

You can confirm operational status and setting details.



**1** Press .

The following on-screen display appears.  
(The actual display varies depending on the disc.)

HD DVD	DVD-Video	DVD-RW	DVD-R
--------	-----------	--------	-------

e.g.

Title 0002	00:19:13	Elapsed time of a title
Chapter 0003	00:00:28	Elapsed time of a chapter
Video Codec: MPEG4AVC		Video codec
Audio: English 1		Language setting
Subtitle: None		Subtitle setting
Angle: 1/1		Angle number
Video Output: 1080i		Definition
Audio Output: Digital Bitstream		Sound output setting

\*The subtitle setting shows a language code (➡ page 62).

CD	CD-RW (CD-DA)	CD-R (CD-DA)
----	---------------	--------------

e.g.

CD PLAYER	TRACK 002	00:03:12 / 00:05:16
-----------	-----------	---------------------

# 5 Internet connection

Connect to a network with an always-on broadband connection and use special content.

Internet connection feature (Outline)

Internet connection feature (Preparation)

Internet connection feature (Operation)

Introduction

Connections

Playback  
(Basic)

Playback  
(Advanced)

Internet  
connection

Others

# Internet connection feature (Outline)

You may use the internet connection feature to update the player's firmware. See [page 61](#).

Future HD DVD discs may enable you to access special HD DVD sites, if you connect the player to the Internet via an always-on broadband connection. For example, if an HD DVD site includes content such as links to future movie trailers, you can watch the content on the player via the Internet.

You do not need to connect to a PC to use this function.

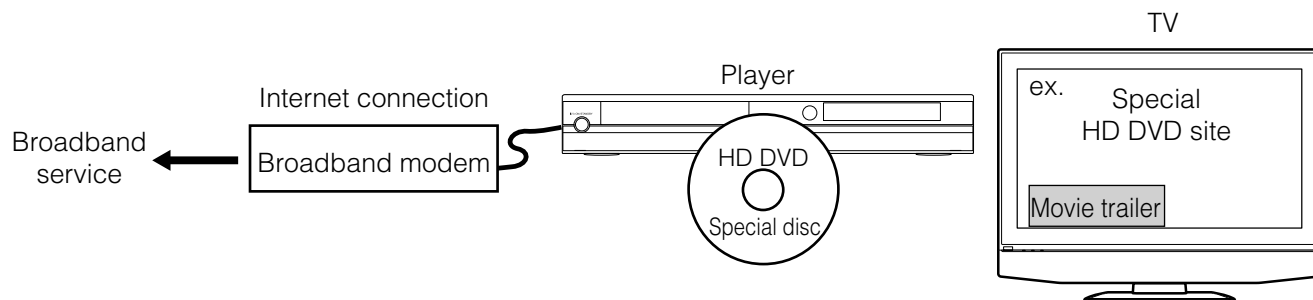

## Before using

- Before using this feature, please read and understand the important information in "Notes".
- This feature requires an always-on broadband internet connection.
- An HD DVD disc compatible with this feature is required. Not all HD DVD discs are compatible.

## Connection requirement

Always-on broadband internet connection.

## Notes

- Toshiba is not responsible for any malfunction of the player and/or the internet connection feature due to communication errors/malfunctions associated with your broadband internet connection, or other connected equipment.
- Toshiba is not responsible for any trouble in your internet connection.
- If you wish to use a wireless network to connect the player, you will need to use a wireless LAN ethernet adapter to connect the player to the network.
- The features of HD DVD discs made available through the Internet Connection feature are not created or provided by Toshiba, and Toshiba is not responsible for their functionality or continued availability. Some disc related material available by the Internet Connection may not be compatible with this player. If you have questions about such content, please contact the producer of the disc.
- Some internet contents may require a higher bandwidth connection.

- Even if the player is properly connected and configured, some internet contents may not operate properly because of internet congestion, the quality or bandwidth of your internet service, problems at the provider of the content or compatibility issues.
- Some internet connection operations may not be possible due to certain restrictions set by the Internet service provider (ISP) supplying your broadband Internet connection.
- Any fees charged by an ISP including, without limitation, connection charges are your responsibility.
- A 10 Base-T or 100 Base-TX LAN port is required for connection to this player. If your internet service does not allow for such a connection, you will not be able to connect the player.
- A DSL modem is required to use DSL service and a cable modem is required to use cable modem service. Depending on the access method of and subscriber agreement with your ISP, you may not be able to use the internet connection feature contained in this player or you may be limited to the number of devices you can connect at the same time. (If your ISP limits subscription to one device, this player may not be allowed to connect when a PC is already connected.)
- The use of a “Router” may not be allowed or its usage may be limited depending on the policies and restrictions of your ISP. For details, contact your ISP directly.

# Internet connection feature (Preparation)

**HD DVD**

Connect the player to the Internet via an always-on broadband connection. In addition to accessing special HD DVD sites, this function is used when updates are available for the control program (firmware) of the player.

## Connection

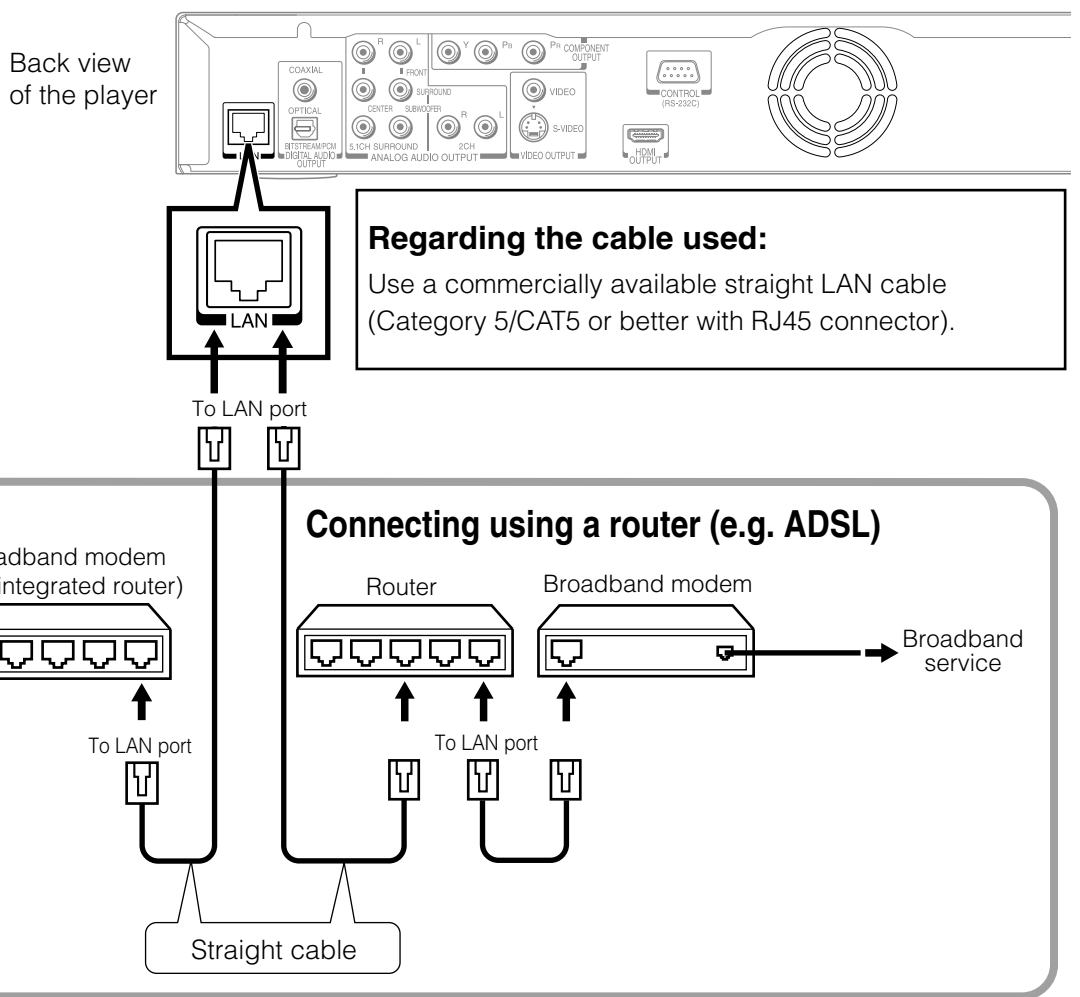

**Caution**

- When plugging or unplugging the LAN cable, hold the plug portion of the cable. When unplugging, do not pull on the LAN cable but unplug while pressing down on the lock.
- Do not connect a modular phone cable to the LAN port.
- Since there are various connection configurations, please follow the specifications of your telecommunication carrier or internet service provider.

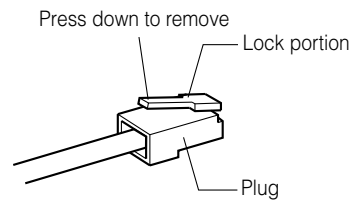

**Note**

- Depending on the internet service provider (ISP), the number of devices that can receive internet service may be limited by the applicable terms of service. For details, contact your ISP.

## Internet connection setting procedure (Outline)

**1st DHCP setting**

- Set "DHCP" to "On".  
The network information is automatically set.
- Set "DNS" to "On".  
The DNS server is obtained automatically from the DHCP server.

If a connection cannot be established even if "DHCP" is set to "On".

- Set "DHCP" to "Off".  
Set "IP Address", "Subnet Mask", and "Gateway" manually.
- Set "DNS" to "Off".  
Set the DNS server address manually.

**2nd Proxy setting**

If the provider you are using requires a proxy setting to be configured, set the corresponding proxy server address.

**3rd NTP Server setting**

The player automatically accesses an internet server to adjust its clock via the network time protocol.

**4th Network Speed setting**

Select the speed according to the specification of your LAN.

**5th Cookie setting**

Select whether you accept "cookies" or not.

**1st DHCP setting**

- 1 Press SETUP button.  
"SETUP MENU" appears.
- 2 Press ▲/▼ buttons to select "Ethernet", then press OK button.
- 3 On "Ethernet" menu, press ▲/▼ buttons to select "DHCP" then press OK button.
- 4 Set "DHCP" to "On", then press OK button.

DHCP

DHCP  On  Off

IP Address 0 . 0 . 0 . 0

Subnet Mask 0 . 0 . 0 . 0

Gateway 0 . 0 . 0 . 0

DNS  On  Off

DNS Server 0 . 0 . 0 . 0

Confirm

OK Cancel

Skipped when "DHCP" is set to "On".

- 5 Set "DNS" to "On", then press OK button.

DHCP

DHCP  On  Off

IP Address 0 . 0 . 0 . 0

Subnet Mask 0 . 0 . 0 . 0

Gateway 0 . 0 . 0 . 0

DNS  On  Off

DNS Server 0 . 0 . 0 . 0

Confirm

OK Cancel

Skipped when "DHCP" is set to "On".

- 6 Select "Confirm", then press OK button.  
Confirming starts.  
If the setup is successful, an IP address appears.  
Press OK button.

***If the setup is not successful:***

- a) Set "DHCP" to "Off" then press OK button.
- b) Input the addresses into "IP Address", "Subnet Mask" and "Gateway" using the number buttons.

IP Address	This sets a different address within the same subnet of the PC on your network. e.g.: If the IP address of the PC is 192.168.1.10, set 192.168.1.15 (or some other unused address).
Subnet Mask	This sets the subnet mask of the network environment that will be connected. e.g.: 255.255.255.0
Gateway	This sets the gateway used by the player (e.g.: 192.168.1.1).

- c) Set "DNS" to "Off" then press OK button.
- d) Input the address into "DNS Server".  
This sets the DNS server to be used by the player.  
e.g.: 192.168.1.1
- e) Press OK button.

**Internet connection feature (Preparation) (Continued)****2nd Proxy Setting**

Enter the proxy server address when your provider requires proxy setting.

- 1 On "Ethernet" menu, press ▲/▼ buttons to select "Proxy setting" then press OK button.
- 2 Set "Proxy" to "On" then press OK button.

- 3 Press ▲/▼/◀/▶ buttons to input.
  - Server: Enter the specified data from the provider.
  - Port: Enter the specified data from the provider.
  - User: Enter the specified data from the provider.
  - Password: Enter the specified data from the provider.
- 4 Select "OK" then press OK button.

**3rd NTP Server setting (Clock adjustment setting)**

- 1 On "Ethernet" menu, press ▲/▼ buttons to select "NTP Server" then press OK button.
- 2 Select "On" or "Off" by pressing ▲/▼ buttons.

On	The player automatically accesses an internet server to adjust time protocol.
Off	The player does not access an internet server to adjust its clock.

- 3 Select "OK" then press OK button.

**4th Network Speed setting**

Select your network speed.

- 1 On "Ethernet" menu, press ▲/▼ buttons to select "Network Speed" then press OK button.
- 2 Select the speed by pressing ▲/▼ buttons.
- 3 Select "OK" then press OK button.

**5th Cookie Setting**

Select whether you wish to accept "cookies" or not.

- 1 On "Ethernet" menu, press ▲/▼ buttons to select "Cookie Setting" then press OK button.
- 2 Select "Accept" or "Not Accept" by pressing ▲/▼ buttons.

Accept	Cookies are accepted.
Not Accept	Cookies are rejected. This may disable some services on web pages.

- 3 Select "OK" then press OK button.

**Note**

- If you select to accept "cookies", the HD DVD internet services you use may record or track information about your use of the player and/or those sites. If you do not choose to allow cookies, some or all features of a site may not properly function.

**User information setting**

Although not directly related to the Internet connection, some HD DVD discs may require the following settings to be configured.

- 1 On "Ethernet" menu, press ▲/▼ buttons to select "User Information" then press OK button.

- 2 Select "User" then press OK button.
- 3 Input characters for your name by pressing ▲/▼ buttons. To shift the position, press ◀/▶ buttons. Up to 16 characters can be input. Press OK button.
- 4 Select "Password" then press OK button. Input your password in the same manner as step 3. Up to 16 characters can be input. Press OK button.
- 5 Select "OK" then press OK button.
  - Use a password that others cannot easily guess.
  - Do not use the same password you use for other services.

**Mac Address**

Displays the MAC address of the player.

It cannot be changed.

- 1 On "Ethernet" menu, press ▲/▼ buttons to select "Mac Address" then press OK button. The MAC address appears.

**Notes**

- Please contact the router manufacturer when the router DHCP feature is not operating properly (in such a case, an error will occur since the default gateway and the DNS server IP address cannot be obtained).
- The firmware in this player is updateable. See ➡ page 61 for information.
- Some applications may require additional bandwidth.



# Internet connection feature (Operation)

## HD DVD



### Preparation

Connect and configure the player to access the Internet beforehand (➡ pages 46 to 48).

#### 1 Insert the HD DVD disc and close the tray.

The disc begins to play.

If the disc does not begin to play, press .

#### 2 Select an item from the menu.

- If the menu does not appear, press  or .

- To select an item, use the direction buttons to select the item and press .



# 6 Others

This chapter includes details on setting items and information on troubleshooting problems.

**Customizing the function settings**

**Language code list**

**Output sound conversion table**

**License information on the software used in the TOSHIBA HD DVD player**

**Before calling service personnel**

**Specification**

**Limited United States Warranty**

**Limited Canadian Warranty**

**INFORMATION ON CUSTOMER SUPPORT**

# Customizing the function settings

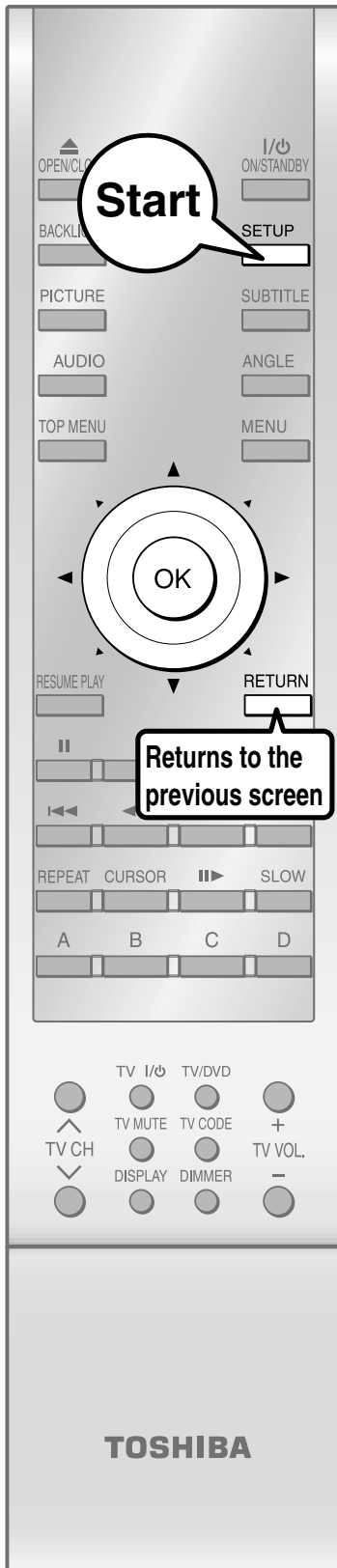

You can change the default settings to customize performance to your preference.

- 1** During stop, press . "SETUP MENU" appears.
- 2** Press **▲/▼** to select the group that contains a desired item, then press .

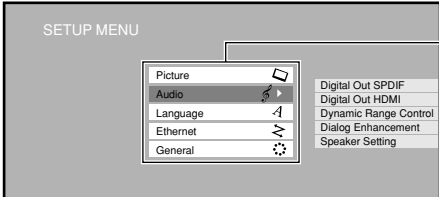
- 3** Press **▲/▼** to select the setting item, then press .

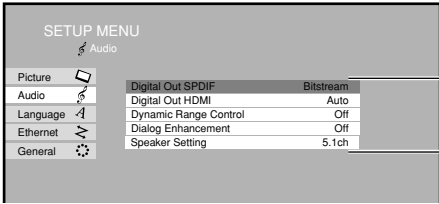
- 4** Refer to the explanations on pages beginning from 54, to change the selection by **▲/▼** or other buttons, then press .
- 5** Repeat step 3 and 4 to set other items if necessary.
- 6** Press . "SETUP MENU" disappears and the setting is completed.

Group	Setting	Disc				Details	Page
Picture	TV Shape	HD DVD	DVD-Video	DVD-RW	DVD-R	To select a picture size according to the aspect ratio of your TV.	54
		CD					
	Enhanced Black Level	HD DVD	DVD-Video	DVD-RW	DVD-R	To select the black level (0 IRE or 7.5 IRE).	54
	Picture Mode	HD DVD	DVD-Video	DVD-RW	DVD-R	To select the system of output signal corresponding to playback source. (Only when connected to a PROGRESSIVE TV.)	54
	Resolution Setting	HD DVD	DVD-Video	DVD-RW	DVD-R	To select the resolution of the player's output, according to the connected TV.	23
Audio	Digital Out SPDIF	HD DVD	DVD-Video	DVD-RW	DVD-R	To select the output sound format when connecting the DIGITAL AUDIO OUTPUT jack.	55
		CD	CD-RW (CD-DA)	CD-R (CD-DA)			
	Digital Out HDMI	HD DVD	DVD-Video	DVD-RW	DVD-R	To select the output sound format when connecting the HDMI OUTPUT jack.	55
		CD	CD-RW (CD-DA)	CD-R (CD-DA)			
	Dynamic Range Control	HD DVD	DVD-Video	DVD-RW	DVD-R	To turn on or off a function that makes faint sounds easier to hear even if you lower the volume during late-hour playback.	55
	Dialog Enhancement	HD DVD	DVD-Video	DVD-RW	DVD-R	To turn on or off a function that increases dialog volume of a disc playback.	56
	Speaker Setting	HD DVD	DVD-Video	DVD-RW	DVD-R	To select various parameters for the analog 5.1ch output.	56
		CD	CD-RW (CD-DA)	CD-R (CD-DA)			
Language	Disc Menu Language	HD DVD	DVD-Video			To select a preferred language for disc menus.	57
	Subtitle Language	HD DVD	DVD-Video			To select a preferred language for subtitles.	57
	Audio Language	HD DVD	DVD-Video			To select a preferred language for the sound track.	57
	On Screen Language	HD DVD	DVD-Video	DVD-RW	DVD-R	To select a preferred language for on-screen displays.	58
		CD	CD-RW (CD-DA)	CD-R (CD-DA)			
Ethernet		HD DVD				To set up internet connection feature.	47
General	Parental Lock	HD DVD	DVD-Video			To turn the parental lock function on or off.	59
	Clock Set	HD DVD	DVD-Video	DVD-RW	DVD-R	To set the clock of the player.	60
		CD	CD-RW (CD-DA)	CD-R (CD-DA)			
	OSD On/Off	HD DVD	DVD-Video	DVD-RW	DVD-R	To activate or deactivate the operational status display on the TV screen.	60
		CD	CD-RW (CD-DA)	CD-R (CD-DA)			
	Remote Controller Sound	HD DVD	DVD-Video	DVD-RW	DVD-R	To turn on or off the confirmation beeper announcing when each remote command is received.	60
		CD	CD-RW (CD-DA)	CD-R (CD-DA)			
Screen Saver		DVD-Video	DVD-RW	DVD-R	To turn on or off the screen saver (screen protection to prevent image burn).	60	
	CD	CD-RW (CD-DA)	CD-R (CD-DA)				
	Maintenance	HD DVD	DVD-Video	DVD-RW	DVD-R	To reset player options to factory defaults or check for firmware updates.	61
		CD	CD-RW (CD-DA)	CD-R (CD-DA)			
	Twin Format Disc	HD DVD				To select the layer to play of an HD DVD Twin Format Disc. (Not available while a disc is loaded.)	61

## Customizing the function settings (Continued)

### Picture

#### TV Shape

##### 16:9

Select when a 16:9 wide TV is connected.

##### 4:3

Select when a standard 4:3 TV is connected.

Displays pictures cropped to fill your TV screen. Both of the picture's sides are cut off.

##### 4:3 Letter Box

Select when a standard 4:3 TV is connected.

Displays theatrical images with masking bars above and below the picture.

#### Notes

- When an HD DVD disc or a DVD video disc has a particular available picture shape, the contents may not be compatible with other picture shapes.
- DVD video discs containing 4:3 picture only always display 4:3 pictures regardless of this setting.
- If "16:9" is selected while connecting a 4:3 TV, playback pictures may be distorted horizontally or shrink vertically. Make this setting according to your TV shape.
- Actual picture shape may depend on signal types of broadcasts or input sources, or settings on the connected TV. Refer to the owner's manual of your TV.

#### Enhanced Black Level

You can adjust the black level of the output signal.

##### On

To display deeper, richer black than in "Off" setting. (0 IRE)

##### Off

Normal black level. (7.5 IRE)

#### Picture Mode

There are two types of source content in pictures recorded in DVD video discs: film content (pictures recorded from films at 24 frames per second) and video content (video signals recorded at 30 frames per second). Make this selection according to the type of content being viewed.

##### Film

The player converts film content pictures in the progressive output format appropriately. Suitable for playback of film content pictures.

##### Video

The player filters video signal, and converts it in the progressive output format appropriately. Suitable for playback of video content pictures.

##### Auto

Select this position normally. The player automatically detects source content, film or video, of playback source, and converts that signal in the progressive output format in an appropriate method.

#### Note

- The player may not be able to detect the source (film or video) of some material. If you notice undesirable picture performance, try selecting "Film" or "Video".

#### Resolution Setting

See  page 23.

#### Note

- Actual effects of these settings may vary depending on performance of connected device.

## Audio

### Digital Out SPDIF

Selects the output sound format by the DIGITAL AUDIO OUTPUT BITSTREAM/PCM jack on this player.

For details about output sound selection, see ➡ page 63.

#### Bitstream

Select this when an AV receiver or processor equipped with built-in Dolby Digital, DTS or MPEG decoder is connected to this player.

When you play a disc recorded in Dolby Digital Plus or Dolby TrueHD format, Dolby Digital sound is output. When you play a disc recorded in DTS-HD format, the sound is converted to a DTS bitstream.

#### PCM

Select this when a 2 channel digital stereo amplifier is connected to this player.

When you play an HD DVD or DVD video disc recorded in Dolby Digital, Dolby Digital Plus, Dolby TrueHD, DTS or DTS-HD format, sound is converted into PCM (2 channel) format.

### Digital Out HDMI

Select the output sound format when a device equipped with an HDMI terminal is connected to the HDMI OUTPUT jack on this player.

For details about output sound selection, see ➡ page 63.

#### Auto

Select this when an HDMI device equipped with built-in Dolby Digital, DTS, MPEG or linear PCM decoder is connected to this player.

Digital audio signal (bitstream audio) is output. If a connected HDMI device does not support bitstream audio input, sound is converted into linear PCM to output.

#### PCM

Select this when an HDMI device which has multi channel input is connected to this player.

The sound is output in multi channel in linear PCM format.

#### Downmixed PCM

Select this when a 2 channel digital stereo AV receiver or processor is connected to this player.

When you play a disc recorded in multi channel, sound is converted into PCM (2 channel) format to output.

### Dynamic Range Control

To turn on or off a function that makes faint sounds easier to hear even if you lower the volume during late-hour playback.

#### Auto

While playing an HD DVD video disc recorded in Dolby TrueHD format, this function will be automatically activated or disabled according to certain command included in the content.

For other discs, this function is activated.

#### On

This function is activated.

#### Off

This function is disabled.

#### Notes

- This function is effective only in playback of HD DVD or DVD video discs recorded in Dolby Digital, Dolby Digital Plus or Dolby TrueHD format.
- The effect level of this function vary depending on the disc.

## Customizing the function settings (Continued)

### Audio

#### Dialog Enhancement

To turn on or off a function that increases dialog volume of a DVD video disc playback.

##### On

This function is activated.

##### Off

This function is disabled.

#### Notes

- This function is effective only in playback of HD DVD or DVD video discs recorded in Dolby Digital or Dolby Digital Plus.
- The effect level of this function vary depending on the disc.

#### Speaker Setting

To select various parameters for the analog 5.1 channel output.

##### 5.1ch

When a 5.1 channel surround system is connected to this player.

Go to the next step (see below) for detailed selections.

##### 2ch

When a 2 channel stereo system is connected to this player.

#### When you selected "5.1ch":

Set the speaker sizes, distance to each speaker and the crossover frequency.

- 1 Select a speaker by pressing ▲/▼/◀/▶ buttons, and press OK button.
- 2 Select the size by pressing ▲/▼ buttons, and press OK button.

##### Front Left / Front Right

Small: Select if the speaker cannot output low frequency.

Large: Select if the speaker can output low frequency.

##### Center / L Surround / R Surround

Small: Select if the speaker cannot output low frequency.

Large: Select if the speaker can output low frequency.

None: When the speaker is not connected.

##### Subwoofer

Use: When a subwoofer is connected.

Don't Use: When a subwoofer is not connected.

#### Crossover Setting

Low frequency under which you set here will be of a subwoofer. Select one from 80 Hz/100 Hz/120 Hz.

##### ft

Select a distance to each speaker from the listening position.

If you select "Clear" and press OK button, your selection is canceled and the previous menu returns.

If you select "End" and press OK button, your selection is saved and the setting finishes.

- 3 Select "Next" by pressing ▲/▼/◀/▶ buttons, and press OK button.

The next screen appears.

- 4 Select "Automatic Test Tone" by pressing ▲/▼/◀/▶ buttons, and press OK button.

A test signal is sent to each speaker. Adjust each of the volumes by pressing ▲/▼, selecting speakers by ◀/▶, so that each speaker can sound at the same volume.

For further adjustment, check the channel balance on the amplifier.

- 5 When complete, select "OK" and press OK button.



## Language

### Disc Menu Language

To select a preferred language for disc menus.

#### English

To display disc menus in English.

#### French

To display disc menus in French.

#### Japanese

To display disc menus in Japanese.

#### German

To display disc menus in German.

#### Other

To make a further language choice.

After pressing OK button, follow steps 1) – 4) below.

- 1) Obtain the language code of the preferred language from the Language code list (➡ page 62).
- 2) Select the first character by pressing ▲/▼ buttons.
- 3) Press ◀/▶ buttons to shift. Select the second character by pressing ▲/▼ buttons.
- 4) Select "OK" and press OK button.

#### Note

- Some discs may be played in a different language from that you selected, as the disc may contain alternate language.

### Subtitle Language

To select a preferred language for subtitles.

#### None

To disable subtitles.

#### English

To display subtitles in English.

#### French

To display subtitles in French.

#### Japanese

To display subtitles in Japanese.

#### German

To display subtitles in German.

#### Other

To make a further language choice.

After pressing OK button, follow steps 1) – 4) below.

- 1) Obtain the language code of the preferred language from the Language code list (➡ page 62).
- 2) Select the first character by pressing ▲/▼ buttons.
- 3) Press ◀/▶ buttons to shift. Select the second character by pressing ▲/▼ buttons.
- 4) Select "OK" and press OK button.

#### Notes

- Some discs may be set to display subtitles in a different language from that you selected, as the disc may contain alternate language.
- Some discs allow you to change subtitle selections only via the disc menu. In this case, press MENU button and choose the appropriate subtitle language from the selection on the disc menu.

### Audio Language

To select a preferred language for the sound track.

#### English

To display sound tracks recorded in English.

#### French

To display sound tracks recorded in French.

#### Japanese

To display sound tracks recorded in Japanese.

#### German

To display sound tracks recorded in German.

#### Other

To make a further language choice.

After pressing OK button, follow steps 1) – 4) below.

- 1) Obtain the language code of the preferred language from the Language code list (➡ page 62).
- 2) Select the first character by pressing ▲/▼ buttons.
- 3) Press ◀/▶ buttons to shift. Select the second character by pressing ▲/▼ buttons.
- 4) Select "OK" and press OK button.

#### Note

- Some discs may be played in a different language from that you selected, as the disc may contain alternate language.

**Customizing the function settings (Continued)****Language****On Screen Language**

To select a preferred language for on-screen displays.

**English**

To view on-screen display in English.

**French**

To view on-screen display in French.

**Japanese**

To view on-screen display in Japanese.

**German**

To view on-screen display in German.

**Ethernet**

See the “Internet connection” chapter (➡ page 44).

## General

### Parental Lock

HD DVD and DVD video discs equipped with the Parental Lock function have a predetermined limitation level. The limitation level or limitation method may differ depending on the disc. For example the whole contents of a disc may not be played back, or an extreme violent scene may be cut or replaced automatically by another scene.

### Important

Depending on discs, it may not be evident whether the disc is compatible with Parental Lock function. Make sure that Parental Lock function you set is activated correctly.

#### 1 Enter a 4-digit password by using the number buttons, then press OK button.

When you use the player for the first time, set a new password of 4-digit. If you make a mistake entering your password, press CLEAR button before pressing OK button, and re-enter the correct password.

#### 2 Set the details.

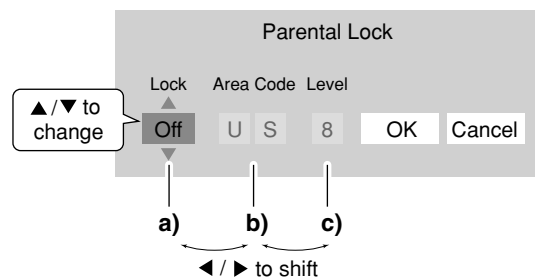

#### a) Select "On" or "Off" by pressing ▲/▼ buttons.

##### On

Select this to activate Parental Lock function or to change the setting.

##### Off

Deactivate the Parental Lock function.  
Skip step 3.

#### b) Press ▲/▼ buttons to enter the code of a country/area whose standards were used to rate a disc, referring to the list below.

Country/Area	Code
AUSTRALIA	AU
BELGIUM	BE
CANADA	CA
CHINA	CN
CHINA HONG KONG	HK
DENMARK	DK
FINLAND	FI

FRANCE	FR
GERMANY	DE
INDONESIA	ID
ITALY	IT
JAPAN	JP
MALAYSIA	MY
NETHERLANDS	NL
NORWAY	NO
PHILIPPINES	PH
RUSSIAN FEDERATION	RU
SINGAPORE	SG
SPAIN	ES
SWEDEN	SE
SWITZERLAND	CH
TAIWAN	TW
THAILAND	TH
UNITED KINGDOM	GB
UNITED STATES	US

#### c) Select the desired limitation level by pressing ◀/▶ buttons.

Unless the Parental Lock function is set to "Off", a disc that has a higher limitation level than your selected limitation level cannot be played back. For example, if you select level 7, discs exceeding level 8 are locked and cannot be played back.

When "US" is selected, its limitation level corresponds to the following settings.

Level 7 : NC-17	Level 3 : PG
Level 6 : R	Level 1 : G
Level 4 : PG13	

#### 3 Select "OK" then press OK button.

#### ■ To change the limitation level of Parental Lock function

Follow step 1 - 3 above.

#### ■ To change the password

#### 1 At step 1, press STOP button 4 times then press OK button.

The password is cleared.

#### 2 Enter a new 4-digit password by using the number buttons.

#### 3 Press OK button.

**Customizing the function settings (Continued)**

**General**

**Clock Set**

To set the clock of the player.

- 1 **Select your time zone by ◀/▶ buttons, then press OK button.**
- 2 **Press ▼ button to shift the cursor to the next input area.**
- 3 **Enter the year using the number buttons, then press OK button.**
- 4 **Set “Month”, “Date” and “Time” in the same manner as 3.**
- 5 **Select “AM” or “PM” by ▲/▼ buttons.**
- 6 **Press ◀ button then ▼ button to select “OK”, then press OK button.**

The clock starts.

**Note**

- If a power failure occurs or the power cord is disconnected, the clock data will be erased. Reset the clock.

**OSD On/Off**

To activate or deactivate the operational status display on the TV screen.

**On**

Activates the operational status display (e.g., ▶) on the TV screen.

**Off**

Deactivates the operational status display (e.g., ▶) on the TV screen.

**Remote Controller Sound**

To turn on or off the confirmation beeper announcing when each remote command is received.

**On**

Turns on the beep sound.

**Off**

Turns off the beep sound.

**Screen Saver**

To turn on or off the screen protection function.

**Auto Power Off**

Turns the player off if picture pausing continues for about 20 minutes.

**On**

Activates the screen saver if picture pausing continues for about 20 minutes.

**Off**

Deactivates the screen saver.

**Notes**

- Toshiba does not guarantee that this function will protect your display.
- To close the screen saver, press any button on the player or the remote control.

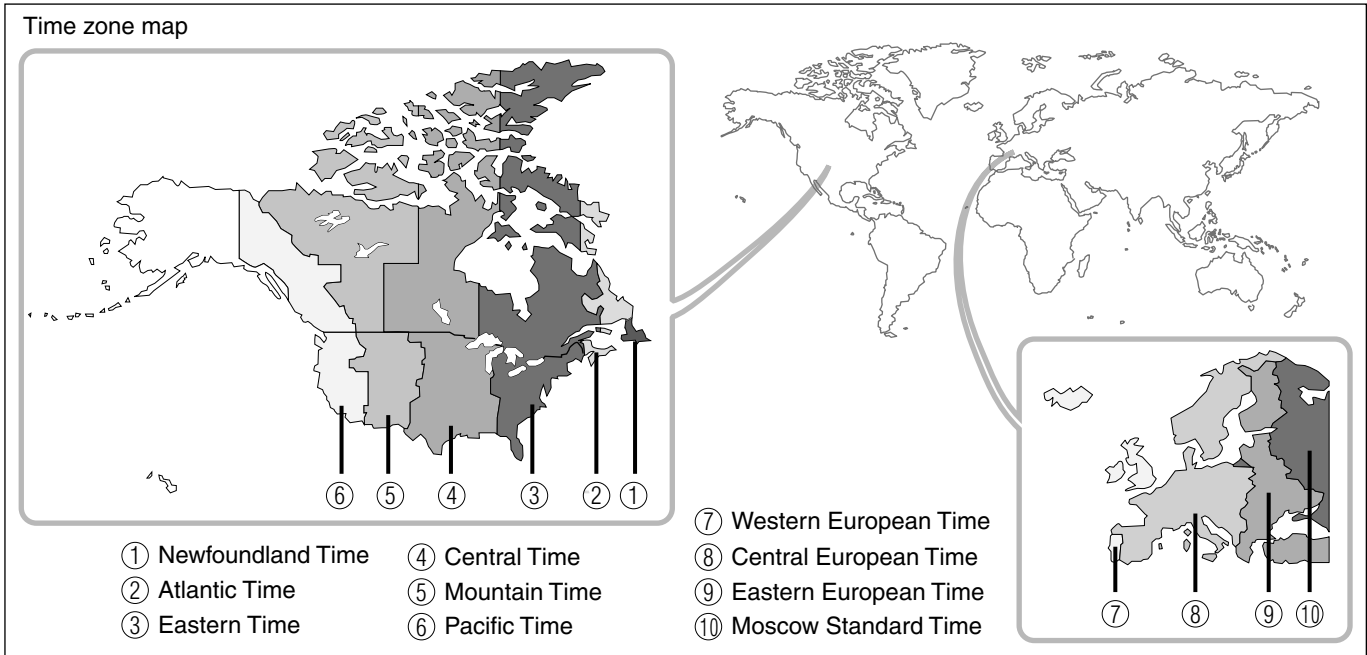

**Maintenance (including internet firmware update)****Initialize**

To reset all the settings listed on ➔ page 53 to factory set default.

Press ◀/▶ buttons to select "Yes" then press OK button.

**Update (Firmware update)**

If you have a broadband internet service you may obtain firmware updates over the internet using the LAN port on the back of your player. (➔ pages 46 to 48 for information on configuring and connecting your LAN port.) Then follow these steps:

- Make sure no disc is loaded in the player.
- Press SETUP and select Maintenance. Follow the instructions on the screen.
- If no update is available, a message will note this and the process will terminate.
- If an update is available, the player will download it showing the status of the process on its display.
- Do not attempt to roll back to a prior firmware version. This may damage your player.

**Caution**

- Do not unplug, turn off or use any other feature of the player during the download. The writing of the software being downloaded will be halted and the player may no longer work properly. If the player stops working, contact Toshiba Customer Service.

**Note**

- If a broadband connection is not available for use by your player, you may obtain firmware updates by mail. There is a postcard included with this player that you can use to sign up for updates on firmware availability and to automatically receive update discs.

**Persistent Storage**

To open the menu to control player's memory allocated for content.

The menu selections will vary depending on the content. Operate following the instructions displayed on your screen.

**Twin Format Disc**

To select a layer to play, HD DVD or DVD of an HD DVD Twin Format Disc. (Not available if a disc is loaded.)

**HD DVD**

Only the HD DVD layer is played.

**DVD**

Only the DVD layer is played.

**Note**

- For combination discs, select the desired version by disc side (see label for information).

# Language code list

Abbreviation	Language	Abbreviation	Language	Abbreviation	Language
---	No alternate language	GN	Guarani	PT	Portuguese
CHI (ZH)	Chinese	GU	Gujarati	QU	Quechua
DUT (NL)	Dutch	HA	Hausa	RM	Rhaeto-Romance
ENG (EN)	English	HI	Hindi	RN	Kirundi
FRE (FR)	French	HR	Croatian	RO	Rumanian
GER (DE)	German	HU	Hungarian	RU	Russian
ITA (IT)	Italian	HY	Armenian	RW	Kinyarwanda
JPN (JA)	Japanese	IA	Interlingua	SA	Sanskrit
KOR (KO)	Korean	IE	Interlingue	SD	Sindhi
MAY (MS)	Malay	IK	Inupiak	SG	Sango
SPA (ES)	Spanish	IN	Indonesian	SH	Serbo-Croatian
AA	Afar	IS	Icelandic	SI	Singhalese
AB	Abkhazian	IW	Hebrew	SK	Slovak
AF	Afrikaans	JI	Yiddish	SL	Slovenian
AM	Amharic	JW	Javanese	SM	Samoan
AR	Arabic	KA	Georgian	SN	Shona
AS	Assamese	KK	Kazakh	SO	Somali
AY	Aymara	KL	Greenlandic	SQ	Albanian
AZ	Azerbaijani	KM	Cambodian	SR	Serbian
BA	Bashkir	KN	Kannada	SS	Siswati
BE	Belorussian	KS	Kashmiri	ST	Sesotho
BG	Bulgarian	KU	Kurdish	SU	Sundanese
BH	Bihari	KY	Kirghiz	SV	Swedish
BI	Bislama	LA	Latin	SW	Swahili
BN	Bengali, Bangla	LN	Lingala	TA	Tamil
BO	Tibetan	LO	Laotian	TE	Telugu
BR	Breton	LT	Lithuanian	TG	Tajik
CA	Catalan	LV	Latvian, Lettish	TH	Thai
CO	Corsican	MG	Malagasy	TI	Tigrinya
CS	Czech	MI	Maori	TK	Turkmen
CY	Welsh	MK	Macedonian	TL	Tagalog
DA	Danish	ML	Malayalam	TN	Setswana
DZ	Bhutani	MN	Mongolian	TO	Tongan
EL	Greek	MO	Moldavian	TR	Turkish
EO	Esperanto	MR	Marathi	TS	Tsonga
ET	Estonian	MT	Maltese	TT	Tatar
EU	Basque	MY	Burmese	TW	Twi
FA	Persian	NA	Nauru	UK	Ukrainian
FI	Finnish	NE	Nepali	UR	Urdu
FJ	Fiji	NO	Norwegian	UZ	Uzbek
FO	Faroese	OC	Occitan	VI	Vietnamese
FY	Frisian	OM	(Afan) Oromo	VO	Volapük
GA	Irish	OR	Oriya	WO	Wolof
GD	Scottish Gaelic	PA	Panjabi	XH	Xhosa
GL	Galician	PL	Polish	YO	Yoruba
		PS	Pashto, Pushto	ZU	Zulu

# Output sound conversion table

Disc	Audio Format	5.1CH ANALOG AUDIO OUTPUT	2CH ANALOG AUDIO OUTPUT	"Digital Out SPDIF"	
				Bitstream	PCM
HD DVD Video Advanced con.	DD Plus/Dolby TrueHD	up to 5.1ch PCM	2ch PCM	Dolby Bitstream	2ch PCM
	dts-HD/L-PCM	up to 5.1ch PCM	2ch PCM	DTS Bitstream	2ch PCM
HD DVD Video Standard content	DD plus	up to 5.1ch PCM	2ch PCM	Bitstream	2ch PCM
	True HD 48kHz 96kHz 192kHz	up to 5.1ch PCM	2ch PCM	Dolby Bitstream	2ch PCM
		up to 5.1ch PCM	2ch PCM	Dolby Bitstream	2ch PCM <sup>1</sup>
		2ch PCM	2ch PCM	Dolby Bitstream	2ch PCM <sup>1</sup>
	dts-HD	up to 5.1ch PCM	2ch PCM	Bitstream	2ch PCM
	L-PCM 48kHz 96kHz 192kHz	up to 5.1ch PCM	2ch PCM	DTS Bitstream	2ch PCM
up to 5.1ch PCM		2ch PCM	DTS Bitstream	2ch PCM <sup>1</sup>	
2ch PCM		2ch PCM	DTS Bitstream	2ch PCM <sup>1</sup>	
MPEG	2ch PCM	2ch PCM	Bitstream	2ch PCM	
DVD-Video	DD	up to 5.1ch PCM	2ch PCM	Bitstream	2ch PCM
	L-PCM 48kHz 96kHz	2ch PCM	2ch PCM	2ch PCM	2ch PCM
		2ch PCM	2ch PCM	2ch PCM <sup>1</sup>	2ch PCM <sup>1</sup>
	dts	up to 5.1ch PCM	2ch PCM	Bitstream	2ch PCM
	MPEG	2ch PCM	2ch PCM	Bitstream	2ch PCM
CD	L-PCM 44.1kHz	2ch PCM	2ch PCM	2ch PCM	2ch PCM
	dts 44.1kHz	up to 5.1ch PCM	2ch PCM	Bitstream	2ch PCM
DVD-VR	DD	2ch PCM	2ch PCM	Bitstream	2ch PCM
	L-PCM	2ch PCM	2ch PCM	2ch PCM	2ch PCM
	MPEG	2ch PCM	2ch PCM	Bitstream	2ch PCM

Disc	Audio Format	"Digital Out HDMI"		
		Auto	PCM <sup>2</sup>	Downmixed PCM
HD DVD Video Advanced con.	DD Plus/Dolby TrueHD/ dts-HD/L-PCM	Depend on HDMI receiver	up to 5.1ch PCM <sup>3</sup>	2ch PCM <sup>1</sup>
HD DVD Video Standard content	DD plus	Depend on HDMI receiver	up to 5.1ch PCM	2ch PCM
	True HD 48kHz 96kHz 192kHz	Depend on HDMI receiver	up to 5.1ch PCM	2ch PCM
		Depend on HDMI receiver	up to 5.1ch PCM <sup>3</sup>	2ch PCM <sup>1</sup>
		Depend on HDMI receiver	2ch PCM <sup>3</sup>	2ch PCM <sup>1</sup>
	dts-HD	Depend on HDMI receiver	up to 5.1ch PCM	2ch PCM
	L-PCM 48kHz 96kHz 192kHz	Depend on HDMI receiver	up to 5.1ch PCM	2ch PCM
Depend on HDMI receiver		up to 5.1ch PCM <sup>3</sup>	2ch PCM <sup>1</sup>	
Depend on HDMI receiver		2ch PCM <sup>3</sup>	2ch PCM <sup>1</sup>	
MPEG	Depend on HDMI receiver	2ch PCM	2ch PCM	
DVD-Video	DD	Depend on HDMI receiver	up to 5.1ch PCM	2ch PCM
	L-PCM 48kHz 96kHz	2ch PCM	2ch PCM	2ch PCM
		2ch PCM	2ch PCM <sup>3</sup>	2ch PCM <sup>1</sup>
	dts	Depend on HDMI receiver	up to 5.1ch PCM	2ch PCM
MPEG	Depend on HDMI receiver	2ch PCM	2ch PCM	
CD	L-PCM 44.1kHz	2ch PCM	2ch PCM	2ch PCM
	dts 44.1kHz	Depend on HDMI receiver	up to 5.1ch PCM	2ch PCM
DVD-VR	DD	Depend on HDMI receiver	2ch PCM	2ch PCM
	L-PCM	2ch PCM	2ch PCM	2ch PCM
	MPEG	Depend on HDMI receiver	2ch PCM	2ch PCM

1: Downsampled PCM.

2: Up to 5.1 channel PCM audio output is possible only when the connected device supports multi channel output.

3: This output format is possible when the resolution setting is "720p", "1080i" or "1080p". When the resolution setting is set to "480p", this output format depends on HDMI receiver.

## Notes

- The main title content of most movie HD DVD discs is "advanced content".
- The BITSTREAM/PCM jack may not output SAP sound you select. In this instance, set "Digital Out SPDIF" to "PCM".

# License information on the software used in the TOSHIBA HD DVD player

**This document is statement purpose only. Not concerned with operation of this product.**

The software pre-installed in the TOSHIBA HD DVD player consists of multiple, independent software components. Each software component is copyrighted by TOSHIBA or a third party.

The TOSHIBA HD DVD player uses software components that are distributed as freeware under a third-party end-user license agreement or copyright notice (hereinafter referred to as a "EULA").

Some EULAs require that the source code of the applicable component be disclosed as the condition for distributing the software component in executable format. You can check the software components subject to such EULA requirements on the following phone number:

Phone number: 1-800-631-3811

TOSHIBA provides a warranty for the TOSHIBA HD DVD player you have purchased under conditions set forth by TOSHIBA.

However, some of the software components distributed under an EULA are made available for use by the user on the assumption that they are not copyrighted or warranted by TOSHIBA or any third party. These software components are licensed to the user free of charge and therefore not covered by any warranty within the scope of the applicable laws. These software components are not subject to any copyrights or other third-party rights and are provided in "as is" condition without any warranty, whether express or implied. "Warranty" here includes, but not limited to, an implied warranty for marketability or fitness for specific uses. All risks associated with the quality or performance of these software components are assumed by the user. TOSHIBA shall not be liable whatsoever for any cost of repair or correction or other incidental expense incurred in connection with a defect found in any of these software components. Unless specified under the applicable laws or in a written agreement, a party who changes or redistributes the software with consent from the copyright holders or based on the aforementioned licenses shall not be held liable whatsoever for any loss arising from the use of or inability to use such software components. The same applies even when the copyright holders or relevant third parties have been informed of the possibility of such loss. "Loss" here includes normal, special, incidental and indirect loss (including, but not limited to, the loss of data or its accuracy; loss incurred by the user or any third party; and interface incompatibility with other software). Please read each EULA for details on the use conditions and items that must be observed regarding these software components.

The table below lists the software components pre-installed in the TOSHIBA HD DVD player, which are subject to EULAs. The user should read the applicable EULAs carefully before using these software components. The EULAs are exhibited in their original text (English) as exactly written by the respective parties other than TOSHIBA

Pre-installed software	EULA	Pre-installed software	EULA
Linux Kernel	Exhibit A	OpenSSL	Exhibit C
Busybox		freetype	Exhibit D
glibc	Exhibit B		

## Exhibit A

### GNU GENERAL PUBLIC LICENSE Version 2, June 1991

Copyright © 1989, 1991 Free Software Foundation, Inc.  
59 Temple Place, Suite 330, Boston, MA 02111-1307

USA

Everyone is permitted to copy and distribute verbatim copies of this license document, but changing it is not allowed.

#### Preamble

The licenses for most software are designed to take away your freedom to share and change it. By contrast, the GNU General Public License is intended to guarantee your freedom to share and change free software – to make sure the software is free for all its users. This General Public License applies to most of the Free Software Foundation's software and to any other program whose authors commit to using it. (Some other Free Software Foundation software is covered by the GNU Library General Public License instead.) You can apply it to your programs, too.

When we speak of free software, we are referring to freedom, not price. Our General Public Licenses are designed to make sure that you have the freedom to distribute copies of free software (and charge for this service if you wish), that you receive source code or can get it if you want it, that you can change the software or use pieces of it in new free programs; and that you know you can do these things.

To protect your rights, we need to make restrictions that forbid

anyone to deny you these rights or to ask you to surrender the rights. These restrictions translate to certain responsibilities for you if you distribute copies of the software, or if you modify it.

For example, if you distribute copies of such a program, whether gratis or for a fee, you must give the recipients all the rights that you have. You must make sure that they, too, receive or can get the source code. And you must show them these terms so they know their rights.

We protect your rights with two steps: (1) copyright the software, and (2) offer you this license which gives you legal permission to copy, distribute and/or modify the software.

Also, for each author's protection and ours, we want to make certain that everyone understands that there is no warranty for this free software. If the software is modified by someone else and passed on, we want its recipients to know that what they have is not the original, so that any problems introduced by others will not reflect on the original authors' reputations.

Finally, any free program is threatened constantly by software patents. We wish to avoid the danger that redistributors of a free program will individually obtain patent licenses, in effect making the program proprietary. To prevent this, we have made it clear that any patent must be licensed for everyone's free use or not licensed at all.

The precise terms and conditions for copying, distribution and modification follow.



## GNU GENERAL PUBLIC LICENSE TERMS AND CONDITIONS FOR COPYING, DISTRIBUTION AND MODIFICATION

0. This License applies to any program or other work which contains a notice placed by the copyright holder saying it may be distributed under the terms of this General Public License. The "Program", below, refers to any such program or work, and a "work based on the Program" means either the Program or any derivative work under copyright law: that is to say, a work containing the Program or a portion of it, either verbatim or with modifications and/or translated into another language. (Hereinafter, translation is included without limitation in the term "modification".) Each licensee is addressed as "you".

Activities other than copying, distribution and modification are not covered by this License; they are outside its scope. The act of running the Program is not restricted, and the output from the Program is covered only if its contents constitute a work based on the Program (independent of having been made by running the Program). Whether that is true depends on what the Program does.

1. You may copy and distribute verbatim copies of the Program's source code as you receive it, in any medium, provided that you conspicuously and appropriately publish on each copy an appropriate copyright notice and disclaimer of warranty; keep intact all the notices that refer to this License and to the absence of any warranty; and give any other recipients of the Program a copy of this License along with the Program.

You may charge a fee for the physical act of transferring a copy, and you may at your option offer warranty protection in exchange for a fee.

2. You may modify your copy or copies of the Program or any portion of it, thus forming a work based on the Program, and copy and distribute such modifications or work under the terms of Section 1 above, provided that you also meet all of these conditions:

- You must cause the modified files to carry prominent notices stating that you changed the files and the date of any change.
- You must cause any work that you distribute or publish, that in whole or in part contains or is derived from the Program or any part thereof, to be licensed as a whole at no charge to all third parties under the terms of this License.
- If the modified program normally reads commands interactively when run, you must cause it, when started running for such interactive use in the most ordinary way, to print or display an announcement including an appropriate copyright notice and a notice that there is no warranty (or else, saying that you provide a warranty) and that users may redistribute the program under these conditions, and telling the user how to view a copy of this License.

(Exception: if the Program itself is interactive but does not normally print such an announcement, your work based on the Program is not required to print an announcement.)

These requirements apply to the modified work as a whole. If identifiable sections of that work are not derived from the Program, and can be reasonably considered independent and separate works in themselves, then this License, and its terms, do not apply to those sections when you distribute them as separate works. But when you distribute the same sections as part of a whole which is a work based on the Program, the distribution of the whole must be on the terms of this License, whose permissions for other licensees extend to the entire whole, and thus to each and every part regardless of who wrote it.

Thus, it is not the intent of this section to claim rights or contest your rights to work written entirely by you; rather, the intent is to exercise the right to control the distribution of derivative or collective works based on the Program.

In addition, mere aggregation of another work not based on the Program with the Program (or with a work based on the Program) on a volume of a storage or distribution medium does not bring the other work under the scope of this License.

3. You may copy and distribute the Program (or a work based on it, under Section 2) in object code or executable form under the terms of Sections 1 and 2 above provided that you also do one of the following:

- Accompany it with the complete corresponding machine-readable source code, which must be distributed under the terms of Sections 1 and 2 above on a medium customarily used for software interchange; or,
- Accompany it with a written offer, valid for at least three years, to give any third party, for a charge no more than your cost of physically performing source distribution, a complete machine-readable copy of the corresponding source code, to be distributed under the terms of Sections 1 and 2 above on a medium customarily used for software interchange; or,
- Accompany it with the information you received as to the offer to distribute corresponding source code. (This alternative is allowed only for noncommercial distribution and only if you received the program in object code or executable form with such an offer, in accord with Subsection b above.)

The source code for a work means the preferred form of the work for making modifications to it. For an executable work, complete source code means all the source code for all modules it contains, plus any associated interface definition files, plus the scripts used to control compilation and installation of the executable. However, as a special exception, the source code distributed need not include anything that is normally distributed (in either source or binary form) with the major components (compiler, kernel, and so on) of the operating system on which the executable runs, unless that component itself accompanies the executable.

If distribution of executable or object code is made by offering access to copy from a designated place, then offering equivalent access to copy the source code from the same place counts as distribution of the source code, even though third parties are not compelled to copy the source along with the object code.

4. You may not copy, modify, sublicense, or distribute the Program except as expressly provided under this License. Any attempt otherwise to copy, modify, sublicense or distribute the Program is void, and will automatically terminate your rights under this License. However, parties who have received copies, or rights, from you under this License will not have their licenses terminated so long as such parties remain in full compliance.

5. You are not required to accept this License, since you have not signed it. However, nothing else grants you permission to modify or distribute the Program or its derivative works. These actions are prohibited by law if you do not accept this License. Therefore, by modifying or distributing the Program (or any work based on the Program), you indicate your acceptance of this License to do so, and all its terms and conditions for copying, distributing or modifying the Program or works based on it.

6. Each time you redistribute the Program (or any work based on the Program), the recipient automatically receives a license from the original licensor to copy, distribute or modify the Program subject to these terms and conditions. You may not impose any further restrictions on the recipients' exercise of the rights granted herein. You are not responsible for enforcing compliance by third parties to this License.

7. If as a consequence of a court judgment or allegation of patent infringement or for any other reason (not limited to patent issues), conditions are imposed on you (whether by court order, agreement or otherwise) that contradict the conditions of this License, they do not excuse you from the conditions of this License. If you cannot

## License information on the software used in the TOSHIBA HD DVD player (Continued)

distribute so as to satisfy simultaneously your obligations under this License and any other pertinent obligations, then as a consequence you may not distribute the Program at all.

For example, if a patent license would not permit royalty-free redistribution of the Program by all those who receive copies directly or indirectly through you, then the only way you could satisfy both it and this License would be to refrain entirely from distribution of the Program. If any portion of this section is held invalid or unenforceable under any particular circumstance, the balance of the section is intended to apply and the section as a whole is intended to apply in other circumstances.

It is not the purpose of this section to induce you to infringe any patents or other property right claims or to contest validity of any such claims; this section has the sole purpose of protecting the integrity of the free software distribution system, which is implemented by public license practices. Many people have made generous contributions to the wide range of software distributed through that system in reliance on consistent application of that system; it is up to the author/donor to decide if he or she is willing to distribute software through any other system and a licensee cannot impose that choice.

This section is intended to make thoroughly clear what is believed to be a consequence of the rest of this License.

8.If the distribution and/or use of the Program is restricted in certain countries either by patents or by copyrighted interfaces, the original copyright holder who places the Program under this License may add an explicit geographical distribution limitation excluding those countries, so that distribution is permitted only in or among countries not thus excluded. In such case, this License incorporates the limitation as if written in the body of this License.

9.The Free Software Foundation may publish revised and/or new versions of the General Public License from time to time. Such new versions will be similar in spirit to the present version, but may differ in detail to address new problems or concerns.

Each version is given a distinguishing version number. If the Program specifies a version number of this License which applies to it and "any later version", you have the option of following the terms and conditions either of that version or of any later version published by the Free Software Foundation. If the Program does not specify a version number of this License, you may choose any version ever published by the Free Software Foundation.

10.If you wish to incorporate parts of the Program into other free programs whose distribution conditions are different, write to the author to ask for permission. For software which is copyrighted by the Free Software Foundation, write to the Free Software Foundation; we sometimes make exceptions for this. Our decision will be guided by the two goals of preserving the free status of all derivatives of our free software and of promoting the sharing and reuse of software generally.

#### NO WARRANTY

11.BECAUSE THE PROGRAM IS LICENSED FREE OF CHARGE, THERE IS NO WARRANTY FOR THE PROGRAM, TO THE EXTENT PERMITTED BY APPLICABLE LAW. EXCEPT WHEN OTHERWISE STATED IN WRITING THE COPYRIGHT HOLDERS AND/OR OTHER PARTIES PROVIDE THE PROGRAM "AS IS" WITHOUT WARRANTY OF ANY KIND, EITHER EXPRESSED OR IMPLIED, INCLUDING, BUT NOT LIMITED TO, THE IMPLIED WARRANTIES OF MERCHANTABILITY AND FITNESS FOR A PARTICULAR PURPOSE. THE ENTIRE RISK AS TO THE QUALITY AND PERFORMANCE OF THE PROGRAM IS WITH YOU. SHOULD THE PROGRAM PROVE DEFECTIVE, YOU ASSUME THE COST OF ALL NECESSARY SERVICING, REPAIR OR CORRECTION.

12.IN NO EVENT UNLESS REQUIRED BY APPLICABLE LAW OR AGREED TO IN WRITING WILL ANY COPYRIGHT HOLDER, OR

ANY OTHER PARTY WHO MAY MODIFY AND/OR REDISTRIBUTE THE PROGRAM AS PERMITTED ABOVE, BE LIABLE TO YOU FOR DAMAGES, INCLUDING ANY GENERAL, SPECIAL, INCIDENTAL OR CONSEQUENTIAL DAMAGES ARISING OUT OF THE USE OR INABILITY TO USE THE PROGRAM (INCLUDING BUT NOT LIMITED TO LOSS OF DATA OR DATA BEING RENDERED INACCURATE OR LOSSES SUSTAINED BY YOU OR THIRD PARTIES OR A FAILURE OF THE PROGRAM TO OPERATE WITH ANY OTHER PROGRAMS), EVEN IF SUCH HOLDER OR OTHER PARTY HAS BEEN ADVISED OF THE POSSIBILITY OF SUCH DAMAGES.

#### END OF TERMS AND CONDITIONS

How to Apply These Terms to Your New Programs

If you develop a new program, and you want it to be of the greatest possible use to the public, the best way to achieve this is to make it free software which everyone can redistribute and change under these terms.

To do so, attach the following notices to the program. It is safest to attach them to the start of each source file to most effectively convey the exclusion of warranty; and each file should have at least the "copyright" line and a pointer to where the full notice is found.

<One line to give the program's name and a brief idea of what it does.>

Copyright © 19yy <name of author>

This program is free software; you can redistribute it and/or modify it under the terms of the GNU General Public License as published by the Free Software Foundation; either version 2 of the License, or (at your option) any later version.

This program is distributed in the hope that it will be useful, but WITHOUT ANY WARRANTY; without even the implied warranty of MERCHANTABILITY or FITNESS FOR A PARTICULAR PURPOSE. See the GNU General Public License for more details.

You should have received a copy of the GNU General Public License along with this program; if not, write to the Free Software Foundation, Inc., 59 Temple Place, Suite 330, Boston, MA 02111-1307 USA

Also add information on how to contact you by electronic and paper mail.

If the program is interactive, make it output a short notice like this when it starts in an interactive mode:

Gnomovision version 69, Copyright © 19yy name of author  
Gnomovision comes with ABSOLUTELY NO WARRANTY;  
for details type `show w'. This is free software, and you are  
welcome to redistribute it under certain conditions; type `show  
c' for details.

The hypothetical commands `show w' and `show c' should show the appropriate parts of the General Public License. Of course, the commands you use may be called something other than `show w' and `show c'; they could even be mouse-clicks or menu items – whatever suits your program.

You should also get your employer (if you work as a programmer) or your school, if any, to sign a "copyright disclaimer" for the program; if necessary. Here is a sample; alter the names:

Yoyodyne, Inc., hereby disclaims all copyright interest in the program `Gnomovision' (which makes passes at compilers) written by James Hacker.

<signature of Ty Coon>, 1 April 1989 Ty Coon, President of Vice

This General Public License does not permit incorporating your program into proprietary programs. If your program is a subroutine library, you may consider it more useful to permit linking proprietary applications with the library. If this is what you want to do, use the GNU Library General Public License instead of this License.

## Exhibit B

### GNU LESSER GENERAL PUBLIC LICENSE Version 2.1, February 1999

Copyright © 1991, 1999 Free Software Foundation, Inc. 59 Temple Place, Suite 330, Boston, MA 02111-1307 USA Everyone is permitted to copy and distribute verbatim copies of this license document, but changing it is not allowed.

[This is the first released version of the Lesser GPL. It also counts as the successor of the GNU Library Public License, version 2, hence the version number 2.1.]

#### Preamble

The licenses for most software are designed to take away your freedom to share and change it. By contrast, the GNU General Public Licenses are intended to guarantee your freedom to share and change free software – to make sure the software is free for all its users.

This license, the Lesser General Public License, applies to some specially designated software packages – typically libraries – of the Free Software Foundation and other authors who decide to use it. You can use it too, but we suggest you first think carefully about whether this license or the ordinary General Public License is the better strategy to use in any particular case, based on the explanations below.

When we speak of free software, we are referring to freedom of use, not price. Our General Public Licenses are designed to make sure that you have the freedom to distribute copies of free software (and charge for this service if you wish); that you receive source code or can get it if you want it; that you can change the software and use pieces of it in new free programs; and that you are informed that you can do these things.

To protect your rights, we need to make restrictions that forbid distributors to deny you these rights or to ask you to surrender these rights. These restrictions translate to certain responsibilities for you if you distribute copies of the library or if you modify it.

For example, if you distribute copies of the library, whether gratis or for a fee, you must give the recipients all the rights that we gave you. You must make sure that they, too, receive or can get the source code. If you link other code with the library, you must provide complete object files to the recipients, so that they can relink them with the library after making changes to the library and recompiling it. And you must show them these terms so they know their rights.

We protect your rights with a two-step method: (1) we copyright the library, and (2) we offer you this license, which gives you legal permission to copy, distribute and/ or modify the library.

To protect each distributor, we want to make it very clear that there is no warranty for the free library. Also, if the library is modified by someone else and passed on, the recipients should know that what they have is not the original version, so that the original author's reputation will not be affected by problems that might be introduced by others.

Finally, software patents pose a constant threat to the existence of any free program. We wish to make sure that a company cannot effectively restrict the users of a free program by obtaining a restrictive license from a patent holder. Therefore, we insist that any patent license obtained for a version of the library must be consistent with the full freedom of use specified in this license.

Most GNU software, including some libraries, is covered by the ordinary GNU General Public License. This license, the GNU Lesser General Public License, applies to certain designated libraries, and is quite different from the ordinary General Public License. We use this license for certain libraries in order to permit linking those libraries into non-free programs.

When a program is linked with a library, whether statically or using a shared library, the combination of the two is legally speaking a combined work, a derivative of the original library. The ordinary General Public License therefore permits such linking only if the entire combination fits its criteria of freedom. The Lesser General Public License permits more lax criteria for linking other code with the library.

We call this license the "Lesser" General Public License because it does Less to protect the user's freedom than the ordinary General Public License. It also provides other free software developers Less of an advantage over competing non-free programs. These disadvantages are the reason we use the ordinary General Public License for many libraries. However, the Lesser license provides advantages in certain special circumstances.

For example, on rare occasions, there may be a special need to encourage the widest possible use of a certain library, so that it becomes a de-facto standard. To achieve this, non-free programs must be allowed to use the library. A more frequent case is that a free library does the same job as widely used non-free libraries. In this case, there is little to gain by limiting the free library to free software only, so we use the Lesser General Public License.

In other cases, permission to use a particular library in non-free programs enables a greater number of people to use a large body of free software. For example, permission to use the GNU C Library in non-free programs enables many more people to use the whole GNU operating system, as well as its variant, the GNU/Linux operating system.

Although the Lesser General Public License is Less protective of the users' freedom, it does ensure that the user of a program that is linked with the Library has the freedom and the wherewithal to run that program using a modified version of the Library.

The precise terms and conditions for copying, distribution and modification follow. Pay close attention to the difference between a "work based on the library" and a "work that uses the library". The former contains code derived from the library, whereas the latter must be combined with the library in order to run.

#### GNU LESSER GENERAL PUBLIC LICENSE TERMS AND CONDITIONS FOR COPYING, DISTRIBUTION AND MODIFICATION

0. This License Agreement applies to any software library or other program which contains a notice placed by the copyright holder or other authorized party saying it may be distributed under the terms of this Lesser General Public License (also called "this License"). Each licensee is addressed as "you".

A "library" means a collection of software functions and/ or data prepared so as to be conveniently linked with application programs (which use some of those functions and data) to form executables.

The "Library", below, refers to any such software library or work which has been distributed under these terms. A "work based on the Library" means either the Library or any derivative work under copyright law: that is to say, a work containing the Library or a portion of it, either verbatim or with modifications and/or translated straightforwardly into another language. (Hereinafter, translation is included without limitation in the term "modification".)

"Source code" for a work means the preferred form of the work for making modifications to it. For a library, complete source code means all the source code for all modules it contains, plus any associated interface definition files, plus the scripts used to control compilation and installation of the library.

Activities other than copying, distribution and modification are not covered by this License; they are outside its scope. The act of running a program using the Library is not restricted, and output from such a program is covered only if its contents constitute a work based on the Library (independent of the use of the Library in a tool for writing it). Whether that is true depends on what the Library does and what the program that uses the Library does.

1. You may copy and distribute verbatim copies of the Library's complete source code as you receive it, in any medium, provided that you conspicuously and appropriately publish on each copy an appropriate copyright notice and disclaimer of warranty; keep intact all the notices that refer to this License and to the absence of any warranty; and distribute a copy of this License along with the Library.

You may charge a fee for the physical act of transferring a copy, and you may at your option offer warranty protection in exchange for a fee.

2. You may modify your copy or copies of the Library or any portion of it, thus forming a work based on the Library, and copy and distribute

## License information on the software used in the TOSHIBA HD DVD player (Continued)

such modifications or work under the terms of Section 1 above, provided that you also meet all of these conditions:

- a) The modified work must itself be a software library.
- b) You must cause the files modified to carry prominent notices stating that you changed the files and the date of any change.
- c) You must cause the whole of the work to be licensed at no charge to all third parties under the terms of this License.
- d) If a facility in the modified Library refers to a function or a table of data to be supplied by an application program that uses the facility, other than as an argument passed when the facility is invoked, then you must make a good faith effort to ensure that, in the event an application does not supply such function or table, the facility still operates, and performs whatever part of its purpose remains meaningful.  
(For example, a function in a library to compute square roots has a purpose that is entirely welldefined independent of the application. Therefore, Subsection 2d requires that any applicationsupplied function or table used by this function must be optional: if the application does not supply it, the square root function must still compute square roots.)

These requirements apply to the modified work as a whole. If identifiable sections of that work are not derived from the Library, and can be reasonably considered independent and separate works in themselves, then this License, and its terms, do not apply to those sections when you distribute them as separate works. But when you distribute the same sections as part of a whole which is a work based on the Library, the distribution of the whole must be on the terms of this License, whose permissions for other licensees extend to the entire whole, and thus to each and every part regardless of who wrote it.

Thus, it is not the intent of this section to claim rights or contest your rights to work written entirely by you; rather, the intent is to exercise the right to control the distribution of derivative or collective works based on the Library.

In addition, mere aggregation of another work not based on the Library with the Library (or with a work based on the Library) on a volume of a storage or distribution medium does not bring the other work under the scope of this License.

3. You may opt to apply the terms of the ordinary GNU General Public License instead of this License to a given copy of the Library. To do this, you must alter all the notices that refer to this License, so that they refer to the ordinary GNU General Public License, version 2, instead of to this License. (If a newer version than version 2 of the ordinary GNU General Public License has appeared, then you can specify that version instead if you wish.) Do not make any other change in these notices.

Once this change is made in a given copy, it is irreversible for that copy, so the ordinary GNU General Public License applies to all subsequent copies and derivative works made from that copy.

This option is useful when you wish to copy part of the code of the Library into a program that is not a library.

4. You may copy and distribute the Library (or a portion or derivative of it, under Section 2) in object code or executable form under the terms of Sections 1 and 2 above provided that you accompany it with the complete corresponding machine-readable source code, which must be distributed under the terms of Sections 1 and 2 above on a medium customarily used for software interchange.

If distribution of object code is made by offering access to copy from a designated place, then offering equivalent access to copy the source code from the same place satisfies the requirement to distribute the source code, even though third parties are not compelled to copy the source along with the object code.

5. A program that contains no derivative of any portion of the Library, but is designed to work with the Library by being compiled or linked with it, is called a "work that uses the Library". Such a work, in isolation, is not a derivative work of the Library, and therefore falls outside the scope of this License.

However, linking a "work that uses the Library" with the Library creates an executable that is a derivative of the Library (because it contains portions of the Library), rather than a "work that uses the library". The executable is therefore covered by this License. Section 6 states terms for distribution of such executables.

When a "work that uses the Library" uses material from a header file that is part of the Library, the object code for the work may be a derivative work of the Library even though the source code is not. Whether this is true is especially significant if the work can be linked without the Library, or if the work is itself a library. The threshold for this to be true is not precisely defined by law.

If such an object file uses only numerical parameters, data structure layouts and accessors, and small macros and small inline functions (ten lines or less in length), then the use of the object file is unrestricted, regardless of whether it is legally a derivative work. (Executables containing this object code plus portions of the Library will still fall under Section 6.)

Otherwise, if the work is a derivative of the Library, you may distribute the object code for the work under the terms of Section 6. Any executables containing that work also fall under Section 6, whether or not they are linked directly with the Library itself.

6. As an exception to the Sections above, you may also combine or link a "work that uses the Library" with the Library to produce a work containing portions of the Library, and distribute that work under terms of your choice, provided that the terms permit modification of the work for the customer's own use and reverse engineering for debugging such modifications.

You must give prominent notice with each copy of the work that the Library is used in it and that the Library and its use are covered by this License. You must supply a copy of this License. If the work during execution displays copyright notices, you must include the copyright notice for the Library among them, as well as a reference directing the user to the copy of this License. Also, you must do one of these things:

- a) Accompany the work with the complete corresponding machine-readable source code for the Library including whatever changes were used in the work (which must be distributed under Sections 1 and 2 above); and, if the work is an executable linked with the Library, with the complete machine-readable "work that uses the Library", as object code and/or source code, so that the user can modify the Library and then relink to produce a modified executable containing the modified Library. (It is understood that the user who changes the contents of definitions files in the Library will not necessarily be able to recompile the application to use the modified definitions.)
- b) Use a suitable shared library mechanism for linking with the Library. A suitable mechanism is one that (1) uses at run time a copy of the library already present on the user's computer system, rather than copying library functions into the executable, and (2) will operate properly with a modified version of the library, if the user installs one, as long as the modified version is interface-compatible with the version that the work was made with.
- c) Accompany the work with a written offer, valid for at least three years, to give the same user the materials specified in Subsection 6a, above, for a charge no more than the cost of performing this distribution.
- d) If distribution of the work is made by offering access to copy from a designated place, offer equivalent access to copy the above specified materials from the same place.
- e) Verify that the user has already received a copy of these materials or that you have already sent this user a copy.

For an executable, the required form of the "work that uses the Library" must include any data and utility programs needed for reproducing the executable from it. However, as a special exception, the materials to be distributed need not include anything that is normally distributed (in either source or binary form) with the major components (compiler, kernel, and so on) of the operating system on which the executable runs, unless that component itself accompanies the executable.

It may happen that this requirement contradicts the license restrictions of other proprietary libraries that do not normally accompany the operating system. Such a contradiction means you cannot use both them and the Library together in an executable that you distribute.

7. You may place library facilities that are a work based on the Library side-by-side in a single library together with other library facilities not covered by this License, and distribute such a combined library, provided that the separate distribution of the work based on the Library

and of the other library facilities is otherwise permitted, and provided that you do these two things:

- a) Accompany the combined library with a copy of the same work based on the Library, uncombined with any other library facilities. This must be distributed under the terms of the Sections above.
- b) Give prominent notice with the combined library of the fact that part of it is a work based on the Library, and explaining where to find the accompanying uncombined form of the same work.

8. You may not copy, modify, sublicense, link with, or distribute the Library except as expressly provided under this License. Any attempt otherwise to copy, modify, sublicense, link with, or distribute the Library is void, and will automatically terminate your rights under this License. However, parties who have received copies, or rights, from you under this License will not have their licenses terminated so long as such parties remain in full compliance.

9. You are not required to accept this License, since you have not signed it. However, nothing else grants you permission to modify or distribute the Library or its derivative works. These actions are prohibited by law if you do not accept this License. Therefore, by modifying or distributing the Library (or any work based on the Library), you indicate your acceptance of this License to do so, and all its terms and conditions for copying, distributing or modifying the Library or works based on it.

10. Each time you redistribute the Library (or any work based on the Library), the recipient automatically receives a license from the original licensor to copy, distribute, link with or modify the Library subject to these terms and conditions. You may not impose any further restrictions on the recipients' exercise of the rights granted herein. You are not responsible for enforcing compliance by third parties with this License.

11. If, as a consequence of a court judgment or allegation of patent infringement or for any other reason (not limited to patent issues), conditions are imposed on you (whether by court order, agreement or otherwise) that contradict the conditions of this License, they do not excuse you from the conditions of this License. If you cannot distribute so as to satisfy simultaneously your obligations under this License and any other pertinent obligations, then as a consequence you may not distribute the Library at all. For example, if a patent license would not permit royalty-free redistribution of the Library by all those who receive copies directly or indirectly through you, then the only way you could satisfy both it and this License would be to refrain entirely from distribution of the Library.

If any portion of this section is held invalid or unenforceable under any particular circumstance, the balance of the section is intended to apply, and the section as a whole is intended to apply in other circumstances.

It is not the purpose of this section to induce you to infringe any patents or other property right claims or to contest validity of any such claims; this section has the sole purpose of protecting the integrity of the free software distribution system which is implemented by public license practices. Many people have made generous contributions to the wide range of software distributed through that system in reliance on consistent application of that system; it is up to the author/donor to decide if he or she is willing to distribute software through any other system and a licensee cannot impose that choice.

This section is intended to make thoroughly clear what is believed to be a consequence of the rest of this License.

12. If the distribution and/or use of the Library is restricted in certain countries either by patents or by copyrighted interfaces, the original copyright holder who places the Library under this License may add an explicit geographical distribution limitation excluding those countries, so that distribution is permitted only in or among countries not thus excluded. In such case, this License incorporates the limitation as if written in the body of this License.

13. The Free Software Foundation may publish revised and/or new versions of the Lesser General Public License from time to time. Such new versions will be similar in spirit to the present version, but may differ in detail to address new problems or concerns. Each version is given a distinguishing version number. If the Library specifies a version number of this License which applies to it and "any later version", you have the option of following the terms and conditions either of that version or of any later version published by the Free Software Foundation. If the Library does not specify a license version number, you may choose any

version ever published by the Free Software Foundation.

14. If you wish to incorporate parts of the Library into other free programs whose distribution conditions are incompatible with these, write to the author to ask for permission. For software which is copyrighted by the Free Software Foundation, write to the Free Software Foundation; we sometimes make exceptions for this. Our decision will be guided by the two goals of preserving the free status of all derivatives of our free software and of promoting the sharing and reuse of software generally.

### NO WARRANTY

15. BECAUSE THE LIBRARY IS LICENSED FREE OF CHARGE, THERE IS NO WARRANTY FOR THE LIBRARY, TO THE EXTENT PERMITTED BY APPLICABLE LAW. EXCEPT WHEN OTHERWISE STATED IN WRITING THE COPYRIGHT HOLDERS AND/OR OTHER PARTIES PROVIDE THE LIBRARY "AS IS" WITHOUT WARRANTY OF ANY KIND, EITHER EXPRESSED OR IMPLIED, INCLUDING, BUT NOT LIMITED TO, THE IMPLIED WARRANTIES OF MERCHANTABILITY AND FITNESS FOR A PARTICULAR PURPOSE. THE ENTIRE RISK AS TO THE QUALITY AND PERFORMANCE OF THE LIBRARY IS WITH YOU. SHOULD THE LIBRARY PROVE DEFECTIVE, YOU ASSUME THE COST OF ALL NECESSARY SERVICING, REPAIR OR CORRECTION.

16. IN NO EVENT UNLESS REQUIRED BY APPLICABLE LAW OR AGREED TO IN WRITING WILL ANY COPYRIGHT HOLDER, OR ANY OTHER PARTY WHO MAY MODIFY AND/OR REDISTRIBUTE THE LIBRARY AS PERMITTED ABOVE, BE LIABLE TO YOU FOR DAMAGES, INCLUDING ANY GENERAL, SPECIAL, INCIDENTAL OR CONSEQUENTIAL DAMAGES ARISING OUT OF THE USE OR INABILITY TO USE THE LIBRARY (INCLUDING BUT NOT LIMITED TO LOSS OF DATA OR DATA BEING RENDERED INACCURATE OR LOSSES SUSTAINED BY YOU OR THIRD PARTIES OR A FAILURE OF THE LIBRARY TO OPERATE WITH ANY OTHER SOFTWARE), EVEN IF SUCH HOLDER OR OTHER PARTY HAS BEEN ADVISED OF THE POSSIBILITY OF SUCH DAMAGES.

### END OF TERMS AND CONDITIONS

#### How to Apply These Terms to Your New Libraries

If you develop a new library, and you want it to be of the greatest possible use to the public, we recommend making it free software that everyone can redistribute and change. You can do so by permitting redistribution under these terms (or, alternatively, under the terms of the ordinary General Public License).

To apply these terms, attach the following notices to the library. It is safest to attach them to the start of each source file to most effectively convey the exclusion of warranty; and each file should have at least the "copyright" line and a pointer to where the full notice is found.

<one line to give the library's name and a brief idea of what it does.>

Copyright © <year> <name of author>

This library is free software; you can redistribute it and/or modify it under the terms of the GNU Lesser General Public License as published by the Free Software Foundation; either version 2 of the License, or (at your option) any later version.

This library is distributed in the hope that it will be useful, but WITHOUT ANY WARRANTY; without even the implied warranty of MERCHANTABILITY or FITNESS FOR A PARTICULAR PURPOSE. See the GNU Lesser General Public License for more details.

You should have received a copy of the GNU Lesser General Public License along with this library; if not, write to the Free Software Foundation, Inc., 59 Temple Place, Suite 330, Boston, MA 02111-1307 USA

Also add information on how to contact you by electronic and paper mail.

You should also get your employer (if you work as a programmer) or your school, if any, to sign a "copyright disclaimer" for the library, if necessary. Here is a sample; alter the names: Yoyodyne, Inc., hereby disclaims all copyright interest in the library 'Frob' (a library for tweaking knobs) written by James Random Hacker.

<signature of Ty Coon>, 1 April 1990

Ty Coon, President of Vice

That's all there is to it!

## License information on the software used in the TOSHIBA HD DVD player (Continued)

**Exhibit C**

## LICENSE ISSUES

The OpenSSL toolkit stays under a dual license, i.e. both the conditions of the OpenSSL License and the original SSLeay license apply to the toolkit.

See below for the actual license texts. Actually both licenses are BSD-style Open Source licenses. In case of any license issues related to OpenSSL please contact [openssl-core@openssl.org](mailto:openssl-core@openssl.org).

## OpenSSL License

Copyright © 1998-2002 The OpenSSL Project. All rights reserved.

Redistribution and use in source and binary forms, with or without modification, are permitted provided that the following conditions are met:

1. Redistributions of source code must retain the above copyright notice, this list of conditions and the following disclaimer.
2. Redistributions in binary form must reproduce the above copyright notice, this list of conditions and the following disclaimer in the documentation and/or other materials provided with the distribution.
3. All advertising materials mentioning features or use of this software must display the following acknowledgment:

"This product includes software developed by the OpenSSL Project for use in the OpenSSL Toolkit. (<http://www.openssl.org/>)"

4. The names "OpenSSL Toolkit" and "OpenSSL Project" must not be used to endorse or promote products derived from this software without prior written permission. For written permission, please contact [openssl-core@openssl.org](mailto:openssl-core@openssl.org).

5. Products derived from this software may not be called "OpenSSL" nor may "OpenSSL" appear in their names without prior written permission of the OpenSSL Project.

6. Redistributions of any form whatsoever must retain the following acknowledgment:

"This product includes software developed by the OpenSSL Project for use in the OpenSSL Toolkit (<http://www.openssl.org/>)"

THIS SOFTWARE IS PROVIDED BY THE OpenSSL PROJECT "AS IS" AND ANY EXPRESSED OR IMPLIED WARRANTIES, INCLUDING, BUT NOT LIMITED TO, THE IMPLIED WARRANTIES OF MERCHANTABILITY AND FITNESS FOR A PARTICULAR PURPOSE ARE DISCLAIMED. IN NO EVENT SHALL THE OpenSSL PROJECT OR ITS CONTRIBUTORS BE LIABLE FOR ANY DIRECT, INDIRECT, INCIDENTAL, SPECIAL, EXEMPLARY, OR CONSEQUENTIAL DAMAGES (INCLUDING, BUT NOT LIMITED TO, PROCUREMENT OF SUBSTITUTE GOODS OR SERVICES; LOSS OF USE, DATA, OR PROFITS; OR BUSINESS INTERRUPTION)

HOWEVER CAUSED AND ON ANY THEORY OF LIABILITY, WHETHER IN CONTRACT, STRICT LIABILITY, OR TORT (INCLUDING NEGLIGENCE OR OTHERWISE) ARISING IN ANY WAY OUT OF THE USE OF THIS SOFTWARE, EVEN IF ADVISED OF THE POSSIBILITY OF SUCH DAMAGE.

This product includes cryptographic software written by Eric Young ([ey@cryptsoft.com](mailto:ey@cryptsoft.com)). This product includes software written by Tim Hudson ([tjh@cryptsoft.com](mailto:tjh@cryptsoft.com)).

## Original SSLeay License

Copyright © 1995-1998 Eric Young ([ey@cryptsoft.com](mailto:ey@cryptsoft.com)) All rights reserved.

This package is an SSL implementation written by Eric Young ([ey@cryptsoft.com](mailto:ey@cryptsoft.com)).

The implementation was written so as to conform with Netscape SSL.

This library is free for commercial and non-commercial use as long as the following conditions are adhered to. The following conditions apply to all code found in this distribution, be it the RC4, RSA, lhash, DES, etc., code; not just the SSL code. The SSL documentation included with this distribution is covered by the same copyright terms except that the holder is Tim Hudson ([tjh@cryptsoft.com](mailto:tjh@cryptsoft.com)).

Copyright remains Eric Young's, and as such any Copyright notices in the code are not to be removed.

If this package is used in a product, Eric Young should be given attribution as the author of the parts of the library used.

This can be in the form of a textual message at program startup or in documentation (online or textual) provided with the package.

Redistribution and use in source and binary forms, with or without modification, are permitted provided that the following conditions are met:

1. Redistributions of source code must retain the copyright notice, this list of conditions and the following disclaimer.
2. Redistributions in binary form must reproduce the above copyright notice, this list of conditions and the following disclaimer in the documentation and/or other materials provided with the distribution.
3. All advertising materials mentioning features or use of this software must display the following acknowledgement:

"This product includes cryptographic software written by Eric Young ([ey@cryptsoft.com](mailto:ey@cryptsoft.com))"

The word 'cryptographic' can be left out if the routines in the library being used are not cryptographic related :-).

4. If you include any Windows specific code (or a derivative thereof) from the apps directory (application code) you must include an acknowledgement:

"This product includes software written by Tim Hudson ([tjh@cryptsoft.com](mailto:tjh@cryptsoft.com))"

THIS SOFTWARE IS PROVIDED BY ERIC YOUNG "AS IS" AND ANY EXPRESS OR IMPLIED WARRANTIES, INCLUDING, BUT NOT LIMITED TO, THE IMPLIED WARRANTIES OF MERCHANTABILITY AND FITNESS FOR A PARTICULAR PURPOSE ARE DISCLAIMED. IN NO EVENT SHALL THE AUTHOR OR CONTRIBUTORS BE LIABLE FOR ANY DIRECT, INDIRECT, INCIDENTAL, SPECIAL, EXEMPLARY, OR CONSEQUENTIAL DAMAGES (INCLUDING, BUT NOT LIMITED TO, PROCUREMENT OF SUBSTITUTE GOODS OR SERVICES; LOSS OF USE, DATA, OR PROFITS; OR BUSINESS INTERRUPTION) HOWEVER CAUSED AND ON ANY THEORY OF LIABILITY, WHETHER IN CONTRACT, STRICT LIABILITY, OR TORT (INCLUDING NEGLIGENCE OR OTHERWISE) ARISING IN ANY WAY OUT OF THE USE OF THIS SOFTWARE, EVEN IF ADVISED OF THE POSSIBILITY OF SUCH DAMAGE.

The licence and distribution terms for any publically available version or derivative of this code cannot be changed. i.e. this code cannot simply be copied and put under another distribution licence [including the GNU Public Licence.]

**Exhibit D**

Portions of this software are copyright © 2005 The FreeType Project ([www.freetype.org](http://www.freetype.org)). All rights reserved.

- This product includes software developed by the OpenSSL project.
- Reverse engineering, disassembling, decompiling, dismantling, or otherwise attempting to analyze or modify the software included in this product is prohibited.

# Before calling service personnel

If you experience any of the following difficulties while using this unit, check the list below before consulting your nearest Toshiba dealer.

Symptom	Remedy
■ <b>No power.</b>	→ Is the power plug disconnected? Check the power connection.
■ <b>No picture.</b>	<p>→ Is the cable for connecting the player and TV disconnected or not connected properly? Check the connections (➡ page 21 – 22)</p> <p>→ Switch the input of the connected TV to the signal from the player.</p> <p>→ Check the settings (MODE switch and “Resolution Setting”). (➡ page 24)</p> <p>→ Are both the HDMI OUTPUT jack and the COMPONENT OUTPUT jacks connected simultaneously? Select either connection and make the appropriate setting. (➡ page 21 – 23)</p>
■ <b>No sound.</b>	<p>→ Is the audio cable disconnected? (➡ page 22)</p> <p>→ Is the volume of the device turned down to the minimum level? Check the volume.</p> <p>→ Switch the audio input of the device connected by the audio cable to the input from the player.</p> <p>→ Set “Digital Out SPDIF” or “Digital Out HDMI” (➡ page 55) properly in accordance with the connected device and connection procedure.</p> <p>→ The volume level is set to the minimum. Adjust the volume. (➡ page 56)</p> <p>→ Change the output resolution (➡ page 23) so that sound can be heard.</p> <p>→ If using the optical digital output for a Dolby Digital Plus, Dolby TrueHD, DTS-HD or DTS soundtrack, be sure your AV receiver or processor is set to use the input connected to your player and is set to output the respective sounds.</p>
■ <b>Output level of multi channel sound is reduced.</b>	→ Set “Speaker Setting” (➡ page 56) to “2ch”.
■ <b>Multi channel sound is not output.</b>	→ Set “Speaker Setting” (➡ page 56) to “5.1ch”.
■ <b>The disc does not play.</b>	<p>→ Make sure the disc type can be played with the player (➡ page 28).</p> <p>→ Is the disc dirty or scratched? Check or clean the disc. (➡ page 29)</p> <p>→ If the disc is a DVD-RW or DVD-R disc, finalize the disc before attempting to play it with the player.</p> <p>→ If the disc includes parent lock support, playback is restricted while the parent lock of the player is set. Cancel Parental Lock (➡ page 59) or change the restriction level.</p>
■ <b>Playback picture has noise.</b>	→ If video from the player is watched via a video recorder or on a TV with a built-in video recorder, the copy guard may prevent images from being displayed properly. Be sure to connect the player directly to the TV.
■ <b>The remote control does not work.</b>	<p>→ Are the batteries of the remote control dead? Replace the batteries. (➡ page 16)</p> <p>→ Make sure the remote control is within range and pointed in the correct direction.</p>
■ <b>Screen freezes and no buttons work.</b>	→ Pressing ON/STANDBY button on the player for approximately ten seconds forces the player to turn off. Turn the player off and then on again.

# Specification

## ■ Power requirement

47.0W

## ■ Power supply

120V AC 60Hz

## ■ Mass

6.2kg

## ■ External dimension

Width 438 x Height 74.4 x Depth 344mm

## ■ Signal system

Standard NTSC Color TV system

## ■ Laser

Semiconductor laser, Wavelength: 405nm/650nm/  
780nm

## ■ VIDEO output

1.0Vp-p (75Ω), Sync signal negative,

Pin jack x 1 system

## ■ S-VIDEO output

(Y) 1.0Vp-p (75Ω), Sync signal negative,

(C) 0.286Vp-p (75Ω), 1 at rear

Mini DIN4 Pin x 1 system

## ■ Component output (Y, P<sub>B</sub> P<sub>R</sub>)

Y output (green), 1.0Vp-p (75Ω),

Sync signal negative, Pin jack x 1 system

P<sub>B</sub>, P<sub>R</sub> output (blue, red), 0.7Vp-p (75Ω),

Pin jack x 1 system each

## ■ Analog audio output

2.0V (rms), 2.2kΩ or below, pin jack

(L, R) x 1 system

2.0V (rms), 2.2kΩ or below, pin jack

Pin jack x 6

## ■ Digital audio output (BITSTREAM/PCM jack)

Optical connector x 1 system

Coaxial pin jack x 1 system, 0.5Vp-p (75Ω)

## ■ LAN port

100BASE-TX/10BASE-T x 1

## ■ EXTENSION port

EXTENSION port x 2 systems

## ■ RS-232C connector

DSUB 9 pin

## ■ HDMI output

19 pin

## ■ Remote control

Wireless remote control (SE-R0251)

## ■ Operating conditions

Temperature: 41°F ~ 95°F (5°C ~ 35°C),

Position: Horizontal

## ■ Clock accuracy

Quartz (monthly deviation: approximately ±30 seconds)

- Designs and specifications are subject to change without notice.
- This model may not be compatible with features and/or specifications that may be added in the future.
- The Illustrations and screens described in this manual may be exaggerated or simplified for easy recognition and may be slightly different from the actual unit.



Introduction

Connections

Playback  
(Basic)

Playback  
(Advanced)

Internet  
connection

**Others**

## Limited United States Warranty

### Digital Audio Video (“DAV”) Product-Depot Repair Warranty

Toshiba America Consumer Products, L.L.C., (“TACP”) makes the following limited warranties to original consumers in the United States. THESE LIMITED WARRANTIES EXTEND TO THE ORIGINAL CONSUMER PURCHASER OR ANY PERSON RECEIVING THIS DAV PRODUCT AS A GIFT FROM THE ORIGINAL CONSUMER PURCHASER AND TO NO OTHER PURCHASER OR TRANSFEREE.

DAV PRODUCTS PURCHASED IN THE U.S.A. AND USED ANYWHERE OUTSIDE OF THE U.S.A., INCLUDING, WITHOUT LIMITATION, CANADA AND MEXICO, ARE NOT COVERED BY THESE WARRANTIES.

DAV PRODUCTS PURCHASED ANYWHERE OUTSIDE OF THE U.S.A., INCLUDING, WITHOUT LIMITATION, CANADA AND MEXICO, AND USED IN THE U.S.A., ARE NOT COVERED BY THESE WARRANTIES.

### Limited Ninety (90) Day Warranty on Labor\*

TACP warrants this DAV Product and its parts against defects in materials or workmanship for a period of ninety (90) days after the date of original retail purchase. DURING THIS PERIOD, TACP WILL, AT TACP’S OPTION, REPAIR OR REPLACE A DEFECTIVE PART WITH A NEW OR REFURBISHED PART WITHOUT CHARGE TO YOU FOR PARTS OR LABOR.

### Limited One (1) Year Warranty on Parts\*

TACP further warrants the parts in this DAV Product against defects in materials or workmanship for a period of one (1) year after the date of original retail purchase. DURING THIS PERIOD, TACP WILL, AT TACP’S OPTION, REPAIR OR REPLACE A DEFECTIVE PART WITH A NEW OR REFURBISHED PART WITHOUT CHARGE TO YOU FOR THE PART, PROVIDED THAT IF A DEFECTIVE PART IS REPAIRED OR REPLACED AFTER NINETY (90) DAYS FROM THE DATE OF ORIGINAL RETAIL PURCHASE, THE CONSUMER SHALL PAY ALL LABOR CHARGES INVOLVED IN THE REPAIR OR REPLACEMENT THEREOF.

### \*Rental Units

The warranty for DAV Product rental units begins on the date of the first rental or thirty (30) days after the date of shipment to the rental firm, whichever comes first.

### \*Commercial Units

DAV Products sold and used for commercial purposes have a limited warranty for all parts and labor, which warranty begins on the date of original retail purchase and ends on the date that is ninety (90) days thereafter.

### Owner’s Manual and Product Registration Card

Read this owner’s manual thoroughly before operating this DAV Product.

Complete and mail the enclosed product registration card or register your DAV Product on-line at [www.tacp.toshiba.com/service](http://www.tacp.toshiba.com/service) as soon as possible. By registering your DAV Product you will enable TACP to bring you new products specifically designed to meet your needs and help us to contact you in the unlikely event a safety notification is required under the Consumer Product Safety Act. Failure to complete and return the product registration card does not diminish your warranty rights.

### Your Responsibility

THE ABOVE WARRANTIES ARE SUBJECT TO THE FOLLOWING CONDITIONS:

- (1) You must retain your bill of sale or provide other proof of purchase.
- (2) All warranty servicing of this DAV Product must be made by the Depot Warranty Repair Center specified by the TACP Consumer Solutions Center.
- (3) The warranties from TACP are effective only if the DAV Product is purchased and operated in the United States or Puerto Rico.
- (4) Labor service charges for set installation, setup, adjustment of customer controls and installation or repair of antenna systems are not covered by this warranty. Reception problems caused by inadequate antenna systems are your responsibility.
- (5) Warranties extend only to defects in materials or workmanship as limited above and do not extend to any DAV Product or parts that have been lost or discarded by you or to damage to DAV Product or parts caused by fires, misuse, accident, Acts of God, such as lightning or fluctuations in electric power, improper installation, improper maintenance or use in violation of instructions furnished by TACP; use or malfunction through simultaneous use of this DAV Product and connected equipment; or to units that have been modified or had the serial number removed, altered, defaced, or rendered illegible.

## How to Obtain Warranty Services

If, after following all of the operating instructions in this manual and checking the section “Before calling service personnel”, you find that service is needed:

- (1) For instructions on how to obtain warranty service for your DAV Product, contact TACP’s Consumer Solution Center toll-free at 1-800-319-6684.
- (2) You must include a copy of original bill of sale or other proof of purchase along with the entire DAV Product to the Depot Warranty Repair Center specified by the TACP Consumer Solutions Center. You are responsible for all inbound transportation and insurance charges for the DAV Product to the Depot Warranty Repair Center specified by the TACP Consumer Solutions Center.

For additional information, visit TACP’s web site:  
[www.tacp.toshiba.com](http://www.tacp.toshiba.com).

ALL WARRANTIES IMPLIED BY THE LAW OF ANY STATE OF THE U.S.A., INCLUDING THE IMPLIED WARRANTIES OF MERCHANTABILITY AND FITNESS FOR A PARTICULAR PURPOSE, ARE EXPRESSLY LIMITED TO THE DURATION OF THE LIMITED WARRANTIES SET FORTH ABOVE. WITH THE EXCEPTION OF ANY WARRANTIES IMPLIED BY THE LAW OF ANY STATE OF THE U.S.A. AS HEREBY LIMITED, THE FOREGOING WARRANTY IS EXCLUSIVE AND IN LIEU OF ALL OTHER WARRANTIES, GUARANTEES, AGREEMENTS, AND SIMILAR OBLIGATIONS OF TACP WITH RESPECT TO THE REPAIR OR REPLACEMENT OF ANY PARTS. IN NO EVENT SHALL TACP BE LIABLE FOR CONSEQUENTIAL OR INCIDENTAL DAMAGES (INCLUDING, BUT NOT LIMITED TO, LOST PROFITS, BUSINESS INTERRUPTION, OR MODIFICATION OR ERASURE OF RECORDED DATA CAUSED BY USE, MISUSE OR INABILITY TO USE THIS DAV PRODUCT).

No person, agent, distributor, dealer or company is authorized to change, modify or extend the terms of these warranties in any manner whatsoever. The time within which an action must be commenced to enforce any obligation of TACP arising under the warranty or under any statute, or law of the United States or of any state thereof, is hereby limited to ninety (90) days from the date you discovered or should have discovered, the defect. This limitation does not apply to implied warranties arising under state law.

THIS WARRANTY GIVES YOU SPECIFIC LEGAL RIGHTS AND YOU MAY ALSO HAVE OTHER RIGHTS WHICH MAY VARY FROM STATE TO STATE IN THE U.S.A. SOME STATES OF THE U.S.A. DO NOT ALLOW LIMITATIONS ON HOW LONG AN IMPLIED WARRANTY LASTS, WHEN AN ACTION MAY BE BROUGHT, OR THE EXCLUSION OR LIMITATION OF INCIDENTAL OR CONSEQUENTIAL DAMAGES, SO THE ABOVE PROVISIONS MAY NOT APPLY TO YOU UNDER SUCH CIRCUMSTANCES.

## Limited Canadian Warranty For Toshiba Brand HD DVD Players

Toshiba of Canada Limited (“TCL”) makes the following limited warranties to original consumers in Canada. **THESE LIMITED WARRANTIES EXTEND TO THE ORIGINAL CONSUMER PURCHASER OR ANY PERSON RECEIVING THIS TOSHIBA BRAND HD DVD Player (the “PLAYER(S)” or “Player(s)”) AS A GIFT FROM THE ORIGINAL CONSUMER PURCHASER AND TO NO OTHER PURCHASER OR TRANSFEREE.**

**PLAYERS PURCHASED IN CANADA, AND USED ANYWHERE OUTSIDE OF CANADA INCLUDING, WITHOUT LIMITATION, THE UNITED STATES AND MEXICO, ARE NOT COVERED BY THESE WARRANTIES.**

**PLAYERS PURCHASED ANYWHERE OUTSIDE OF CANADA, INCLUDING, WITHOUT LIMITATION, THE UNITED STATES AND MEXICO, AND USED IN CANADA, ARE NOT COVERED BY THESE WARRANTIES.**

### Limited One (1) Year Warranty on Parts and Labour (home/non-commercial use)

Subject to the more limited warranty if the Player is used for any commercial or business purposes as set out below, TCL warrants the Player and its parts against material defects in materials or workmanship that result in the Player failing for a period of one (1) year after the date of original retail purchase. **DURING THIS PERIOD, TCL WILL, AT TCL’S OPTION, REPAIR OR REPLACE A DEFECTIVE PART WITH A NEW OR REFURBISHED PART, WITHOUT CHARGE TO YOU FOR PARTS OR LABOUR. THE ENTIRE PLAYER MUST BE SHIPPED PREPAID TO THE CLOSEST TOSHIBA FACTORY SERVICE DEPOT IN MARKHAM, MONTREAL OR VANCOUVER (a “Toshiba Factory Service Depot” or “TOSHIBA FACTORY SERVICE DEPOT”). TRANSPORTATION AND INSURANCE CHARGES FOR THE PLAYER ARE THE RESPONSIBILITY OF THE OWNER. THE REPAIRED PLAYER WILL BE RETURNED PREPAID.**

### Rental Units

The warranty for Player rental units begins with the date of first rental or thirty (30) days from the date of shipment to the rental firm, whichever comes first.

### Limited Warranty for Commercial Units

TCL warrants Players that are used for any commercial or business purposes as follows: all parts are warranted against material defects in materials or workmanship that result in the Player failing for a period of ninety (90) days after the date of original retail purchase. **DURING THIS PERIOD, TCL WILL, AT TCL’S OPTION, REPAIR OR REPLACE A DEFECTIVE PART WITH A NEW OR REFURBISHED PART, WITHOUT CHARGE TO YOU FOR PARTS OR LABOUR. THE ENTIRE PLAYER MUST BE SHIPPED PREPAID TO THE CLOSEST TOSHIBA FACTORY SERVICE DEPOT IN MARKHAM, MONTREAL OR VANCOUVER. TRANSPORTATION AND INSURANCE CHARGES FOR THE PLAYER ARE THE RESPONSIBILITY OF THE OWNER. THE REPAIRED PLAYER WILL BE RETURNED PREPAID.**

### Your Responsibility

**THE ABOVE WARRANTIES ARE SUBJECT TO THE FOLLOWING CONDITIONS:**

- 1) You must provide your bill of sale or other proof of purchase.
- 2) All warranty servicing of this Player must be performed by a Toshiba Factory Service Depot.
- 3) The warranties from TCL are effective only if the Player is (i) purchased as new and unopened from TCL or from TCL’s authorized distributors, dealers or resellers (“**ADR’s**”) and (ii) located/operated in Canada.

- 4) Warranties extend only to material defects in materials or workmanship as limited above, and do not extend to:
  - a. Service, repairs or replacement made necessary by accident, misuse, abuse, moisture, liquids, dust, dirt, neglect, accident, damage, 24/7 applications, improper installation, improper operation, improper cleaning, improper maintenance, normal wear and tear, or any other external cause or event, act or omission outside the control of TCL, including fire, theft, acts of God, alteration, power failures, power surges or power shortages, lightning, other electrical faults, or repairs, modifications or replacements by persons other than those authorized by TCL to service the Player;
  - b. Replacement of missing, discarded or lost parts, the provision of retrofits, or preventive maintenance;
  - c. Repair of damage that is cosmetic only or does not affect the Player functionality, such as wear and tear, scratches and dents;
  - d. Service on Toshiba-branded accessory items (such accessory items may be covered by their own warranty);
  - e. Service on third party products or service made necessary by use of incompatible third party products;
  - f. Service made necessary by the simultaneous use of this Player and connected equipment;
  - g. Modifications to the Player not approved in writing by TCL, and service made necessary by the use or installation of non-Toshiba modifications to the Player;
  - h. Service of a Player on which the TOSHIBA label or logo, rating label or serial number have been defaced or removed;
  - i. On-site service and repair of the Player; and
  - j. Damage to the Player caused by failure to follow the specifications, User manuals or guides as to usage and/or storage.

### Disclaimer and Limitation of Remedy

**TO THE EXTENT NOT PRECLUDED BY LAW, ALL OTHER EXPRESS AND IMPLIED WARRANTIES, CONDITIONS AND REPRESENTATIONS FOR THIS PLAYER, INCLUDING THE IMPLIED WARRANTIES AND CONDITIONS OF MERCHANTABILITY AND FITNESS FOR A PARTICULAR PURPOSE, ARE HEREBY DISCLAIMED AND EXCLUDED. IF THE APPLICABLE LAW, STATUTORY OR OTHERWISE, PRECLUDES THE EXCLUSION OF ANY IMPLIED WARRANTIES, CONDITIONS AND REPRESENTATIONS THEN SUCH IMPLIED WARRANTIES, CONDITIONS AND REPRESENTATIONS ARE OTHERWISE LIMITED IN DURATION TO THE TERM OF THIS EXPRESS WRITTEN LIMITED WARRANTY. TO THE EXTENT NOT PRECLUDED BY LAW, THIS WRITTEN WARRANTY SUPERCEDES AND**

**SPECIFICALLY DISCLAIMS ANY OTHER WARRANTY, CONDITION OR REPRESENTATION NOT STATED IN THIS WARRANTY, WHETHER MADE BY TCL, TOSHIBA CORPORATION, THEIR AFFILIATES, AND ADRs AND WHETHER MADE ORALLY OR IN WRITING (INCLUDING ANY STATEMENT IN ANY BROCHURE, PRESS RELEASE, ANNOUNCEMENT, ADVERTISEMENT, POINT OF SALE DISPLAY, ETC.).**

YOU MUST READ AND FOLLOW ALL SET-UP AND USAGE INSTRUCTIONS IN THE APPLICABLE USER GUIDES AND/OR MANUALS. IF YOU FAIL TO DO SO, THIS PLAYER MAY NOT FUNCTION PROPERLY AND YOU MAY SUFFER DAMAGE. THIS WARRANTY WILL NOT COVER ANY SERVICE THAT IS REQUIRED, IN PART OR IN WHOLE, AS A RESULT OF ANY FAILURE TO FOLLOW THE SET-UP AND USAGE INSTRUCTIONS. THIS WARRANTY DOES NOT APPLY AND SHALL BE VOID AND UNENFORCEABLE IF THE PLAYER IS OPENED, SERVICED, OR REPAIRED BY PERSONS OTHER THAN THOSE AUTHORIZED BY TCL TO SERVICE OR REPAIR THE PRODUCT.

IF THE PLAYER FAILS TO WORK AS WARRANTED ABOVE, YOUR SOLE AND EXCLUSIVE REMEDY SHALL BE REPAIR OR REPLACEMENT OF THE DEFECTIVE PART. IN NO EVENT WILL TCL, TOSHIBA CORPORATION, THEIR AFFILIATES OR ADRs (THE "RELATED PARTIES") BE LIABLE TO YOU OR ANY THIRD PARTY FOR ANY DAMAGES, MONEY, REIMBURSEMENT, COSTS OR EXPENSES. THIS LIMITATION APPLIES TO DAMAGES, MONEY, REIMBURSEMENT, COSTS OR EXPENSES OF ANY KIND WHATSOEVER INCLUDING ANY DIRECT OR INDIRECT DAMAGES, DAMAGE TO PROPERTY OR PERSON, LOST PROFITS, LOST SAVINGS, INCONVENIENCE OR OTHER SPECIAL, INCIDENTAL, EXEMPLARY OR CONSEQUENTIAL DAMAGES, WHETHER FOR BREACH OF WARRANTY, BREACH OF CONTRACT, TORT (INCLUDING NEGLIGENCE), UNDER A STATUTE OR UNDER ANY OTHER LAW OR FORM OF ACTION, OR WHETHER ARISING OUT OF THE USE OF OR INABILITY TO USE THE PLAYER, EVEN IF ANY OF THE RELATED PARTIES HAS BEEN ADVISED OF THE POSSIBILITY OF SUCH DAMAGES OR OF ANY CLAIM BY ANY OTHER PARTY.

No person, agent, distributor, dealer or company is authorized to change, modify or extend the terms of these warranties in any manner whatsoever.

### **Arbitration and Dispute Resolution**

To the extent not precluded by law, any claim, dispute, controversy or disagreement (whether for breach of warranty, breach of contract, tort (including negligence), under a statute or under any other law or form of action) against any of the Related Parties arising out of, or otherwise relating to: (i) this warranty; (ii) the Player; (iii) any oral or written representations, statements, brochures, press releases, advertising, announcement, point of sale display, or promotional material relating to the Player; (iv) the relationships that result from this warranty, (the foregoing claims, disputes controversies and disagreements are collectively referred to as the "Dispute"), shall be referred to and resolved by final and binding arbitration (to the exclusion of the courts). To the extent not precluded by law, you agree to waive any right that you may have to commence or participate in any representative or class proceeding against the Related Parties relating to any Dispute. If and where applicable and to the extent not precluded by law, you further agree to opt out of any such representative or

class proceedings. Arbitration of any Dispute will be conducted in the forum and in the manner as agreed to between you and TCL. Failing such agreement, the arbitration will be conducted by one arbitrator pursuant to the laws and rules relating to arbitration generally in force in the jurisdiction in which you reside at the time that the Dispute arises. To the extent not precluded by law, no claim, dispute, controversy or disagreement of any other person may be joined or combined with any Dispute by you, without the prior written consent of TCL.

### **General Provisions**

If and to the extent that any provision of this limited warranty should generally be found to be unenforceable, the unenforceable provision shall be severed from the warranty and deemed not to form part of the warranty. The remaining provisions of this warranty shall be and remain valid and enforceable. If and to the extent that any provision of this limited warranty as it relates to any of the Related Parties is found to be invalid or unenforceable in respect of that party (the "Excluded Party"), the Excluded Party shall be deemed to be severed or excluded from the provision, and the provision shall remain valid, enforceable and applicable in respect of the other or remaining Related Parties.

To the extent permitted by law, this limited warranty shall be governed and construed in accordance with the laws of Ontario.

If there is any inconsistency between this limited warranty, on the one hand, and any statement in the packaging of the Player or in any other document enclosed with, or used in the context of the promotion or sale of, the Player, on the other hand, the provisions of this limited warranty shall prevail.

### **How to Obtain Warranty Services**

If, after following all of the operating instructions in this manual and checking the "Troubleshooting" section, you find that service is needed:

- (1) To find the nearest Toshiba Factory Service Depot, visit TCL's web site at [www.toshiba.ca](http://www.toshiba.ca), or call toll free 1-800-268-3404
- (2) Present your bill of sale or other proof of purchase to the Toshiba Factory Service Depot.

For additional information, visit TCL's website: [www.toshiba.ca](http://www.toshiba.ca)

# MEMO

# MEMO

Introduction

Connections

Playback  
(Basic)

Playback  
(Advanced)

Internet  
connection

**Others**

## **INFORMATION ON CUSTOMER SUPPORT**

HD DVD is a new and evolving format, so changes and improvements are possible. To obtain updated information about HD DVD and this product, as well as customer support information about this product, please contact Toshiba Customer Support:

\* In the U.S., please call 1 (800) 319-6684 or visit [www.tacp.com/customersupport](http://www.tacp.com/customersupport).

\* In Canada, please call 1 (800) 268-3404 or visit [www.toshiba.ca](http://www.toshiba.ca) and click on support.

# **TOSHIBA**



Printed on 70% Recycled Paper

ⓂGX1D00000481



## Free Manuals Download Website

<http://myh66.com>

<http://usermanuals.us>

<http://www.somanuals.com>

<http://www.4manuals.cc>

<http://www.manual-lib.com>

<http://www.404manual.com>

<http://www.luxmanual.com>

<http://aubethermostatmanual.com>

Golf course search by state

<http://golfingnear.com>

Email search by domain

<http://emailbydomain.com>

Auto manuals search

<http://auto.somanuals.com>

TV manuals search

<http://tv.somanuals.com>