

TOSHIBA

HD-XA1KN

HD DVD player

Introduction

Connections

Playback
(Basic)

Playback
(Advanced)

Internet
connection

Others



OWNER'S MANUAL



SAFETY PRECAUTIONS

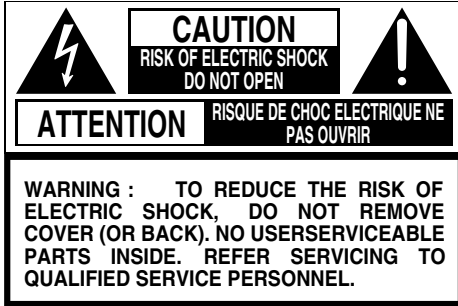

The lightning flash with arrowhead symbol, within an equilateral triangle, is intended to alert the user to the presence of uninsulated "dangerous voltage" within the product's enclosure that may be of sufficient magnitude to constitute a risk of electric shock to persons.



The exclamation point within an equilateral triangle is intended to alert the user to the presence of important operating and maintenance (servicing) instructions in the literature accompanying the appliance.

WARNING: TO REDUCE THE RISK OF FIRE OR ELECTRIC SHOCK, DO NOT EXPOSE THIS APPLIANCE TO RAIN OR MOISTURE. DANGEROUS HIGH VOLTAGES ARE PRESENT INSIDE THE ENCLOSURE. DO NOT OPEN THE CABINET. REFER SERVICING TO QUALIFIED PERSONNEL ONLY.

CAUTION: TO PREVENT ELECTRIC SHOCK, MATCH WIDE BLADE OF PLUG TO WIDE SLOT, FULLY INSERT.

ATTENTION: POUR EVITER LES CHOCS ELECTRIQUES, INTRODUIRE LA LAME LA PLUS LARGE DE LA FICHE DANS LA BORNE CORRESPONDANTE DE LA PRISE ET POUSSER JUSQU'AU FOND.

CAUTION: This HD DVD player employs a Laser System.
To ensure proper use of this product, please read this owner's manual carefully and retain for future reference. Should the unit require maintenance, contact an authorized service location - see service procedure.

Use of controls or adjustments or performance of procedures other than those specified herein may result in hazardous radiation exposure.

To prevent direct exposure to laser beam, do not try to open the enclosure.
Visible and invisible laser radiation when open and interlocks defeated.
DO NOT STARE INTO BEAM.

FCC NOTICE: This equipment has been tested and found to comply with the limits for a Class B digital device, pursuant to part 15 of the FCC Rule. These limits are designed to provide reasonable protection against harmful interference in a residential installation.

This equipment generates, uses, and can radiate radio frequency energy and, if not installed and used in accordance with the instructions, may cause harmful interference to radio communications.

However, there is no guarantee that interference will not occur in a particular installation. If this equipment does cause harmful interference to radio or television reception, which can be determined by turning the equipment off and on, the user is encouraged to try to correct the interference by one or more of the following measures:

- Reorient or relocate the receiving antenna.
- Increase the separation between the equipment and receiver.
- Connect the equipment into an outlet on a circuit different from that to which the receiver is connected.
- Consult the dealer or an experienced radio/TV technician for help.

WARNING: Changes or modifications made to this equipment, not expressly approved by Toshiba, or parties authorized by Toshiba, could void the user's authority to operate the equipment.

The instructions shall state that an ALL-POLE MAINS SWITCH with a contact separation of at least 3 mm in each pole shall be incorporated in the electrical installation of the building.

CAUTION: These servicing instructions are for use by qualified service personnel only. To reduce the risk of electric shock do not perform any servicing other than that contained in the operating instructions unless you are qualified to do so.

In the spaces provided below, record the Model and Serial No. located on the rear panel of your player.

Model No. _____

Serial No. _____

Retain this information for future reference.

Location of the required label

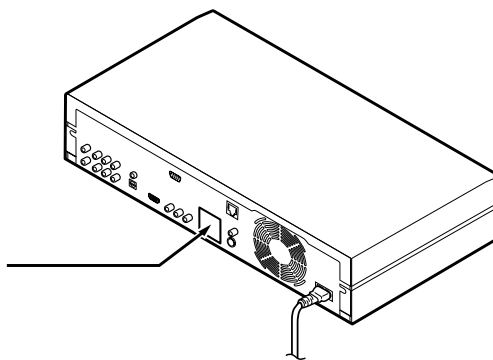
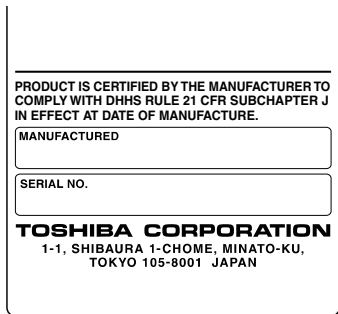

IMPORTANT SAFETY INSTRUCTIONS

1. Read these instructions.
2. Keep these instructions.
3. Heed all warnings.
4. Follow all instructions.
5. Do not use this apparatus near water.
6. Clean only with dry cloth.
7. Do not block any ventilation openings. Install in accordance with the manufacturer's instructions.
8. Do not install near any heat sources such as radiators, heat registers, stoves, or other apparatus (including amplifiers) that produce heat.
9. Do not defeat the safety purpose of the polarized or grounding-type plug. A polarized plug has two blades with one wider than the other. A grounding type plug has two blades and a third grounding prong. The wide blade or the third prong are provided for your safety. If the provided plug does not fit into your outlet, consult an electrician for replacement of the obsolete outlet.
10. Protect the power cord from being walked on or pinched particularly at plugs, convenience receptacles, and the point where they exit from the apparatus.
11. Only use attachments/accessories specified by the manufacturer.
12. Use only with the cart, stand, tripod, bracket, or table specified by the manufacturer, or sold with the apparatus. When a cart is used, use caution when moving the cart/apparatus combination to avoid injury from tip-over.
13. Unplug this apparatus during lightning storms or when unused for long periods of time.
14. Refer all servicing to qualified service personnel. Servicing is required when the apparatus has been damaged in any way, such as power-supply cord or plug is damaged, liquid has been spilled or objects have fallen into the apparatus, the apparatus has been exposed to rain or moisture, does not operate normally, or has been dropped.



ADDITIONAL SAFETY INSTRUCTIONS

15. Do not overload wall outlets; extension cords, or integral convenience receptacles as this can result in a risk of fire or electric shock.
16. Apparatus should not be exposed to dripping or splashing and no objects filled with liquids, such as vases, should not be placed on the apparatus.
17. Keep your fingers well clear of the disc tray as it is closing. Neglecting to do so may cause serious personal injury.
18. Do not place anything on top of this unit.
19. Do not place the apparatus on amplifiers or equipment that may produce heat.
20. Do not cover the ventilating holes for the inside cooling fan.
21. Do not use a cracked, deformed, or repaired disc. These discs are easily broken and may cause serious personal injury and apparatus malfunction.
22. If the apparatus should smoke or smell, immediately disconnect the power cord from the wall outlet. Wait until the smoke or smell stops, then ask your dealer for a check and repair. Neglecting to do so may cause fire.
23. During thunderstorms, do not touch the connecting cables or the apparatus.
24. Handling the cord on this product or cords associated with accessories sold with this product, will expose you to lead, a chemical known to the State of California to cause birth defects or other reproductive harm. Wash hands after handling.

Precautions

Notes on handling

- Never disconnect the power cord from a wall outlet while the player is turned on, unless it is in an emergency. Doing so may cause malfunction.
- When shipping the player, the original shipping carton and packing materials come in handy. For maximum protection, repack the unit as it was originally packed at the factory.
- Do not use volatile liquids, such as insect spray, near the player. Do not leave rubber or plastic products in contact with the player for a long time. They will leave marks on the finish.
- The top and rear panels of the player may become warm after a long period of use. This is not a malfunction.

When not in use

- For usual absence
Be sure to remove the disc from the player and turn off the power.
- Prolonged absence
Unplug the player from a wall outlet.

Notes on locating

- Place the player on a level surface. Do not use it on a shaky or unstable surface such as a wobbly table or inclined stand. The loaded disc may dislodge from its proper position and cause damage to the player.
Before placing the player, make sure that the surface can stand the weight of the player. Never place the player in a high location to avoid damage to the product or person by an accidental fall of the player.
- When you place this player near a TV, radio, or VCR, the playback picture may become poor and the sound may be distorted depending on the condition and location of said equipment. In such an event, place the player as far away much as possible from the TV, radio, or VCR.
- To avoid damage to this product, never place or store the unit in direct sunlight; hot, humid areas; or areas subject to excessive dust, oily smoke, cigarette smoke or vibration.

Notes on cleaning

Use a soft, dry cloth for cleaning.

- Do not use any type of solvent, such as thinner or benzene, as they may damage the surface of the player.

About the volume level

The volume level of some commercial DVD discs may seem lower than that of audio CDs, other software, etc. If you turn up the volume of the TV or amplifier to play such discs, be sure to turn it back down after playback finishes.

Playback restrictions

This owner's manual explains the basic instructions for this player. Some HD DVD discs or DVD video discs are produced in a manner that allows specific or limited operation during playback. As such, the player may not respond to all operating commands. This is not a defect in the player. Please refer to the notes on compatible discs later in this Introduction and to the discussion of DVD playback and features later in this manual.

“⊘” may appear on the TV screen during operation.

“⊘” means that the operation is not permitted by the player or the disc.

About software

Because of problems and errors that can occur during the creation of HD DVD, DVD and CD software and/or the manufacture of HD DVD, DVD and CD discs, Toshiba cannot assure that this player will successfully play every disc bearing the HD DVD, DVD and CD logos. If you happen to experience any difficulty playing an HD DVD, DVD and CD disc on this player, please contact Toshiba Customer Service.

Some differences

The HD DVD player operates more like a computer and differently than a standard DVD player. In addition to containing a microprocessor, it contains an operating system, random access memory (RAM), and an HD DVD drive. The operating system includes software that is transferred to the RAM when the machine is turned on and at other times during operation. This transfer can take time. Therefore, when you turn the HD DVD player on, it may take a little while before it is ready to use. Likewise, other functions may not be performed as quickly as they would on other AV equipment. Please take these factors into consideration as you use the HD DVD player.

Notes on moisture condensation

Moisture condensation damages the unit. Please read the following carefully.

Moisture condensation occurs, for example, when you pour a cold drink into a glass on a warm day. Drops of water form on the outside of the glass. In the same way, moisture may condense on the optical pick-up lens inside this unit, one of the most crucial internal parts of the unit.

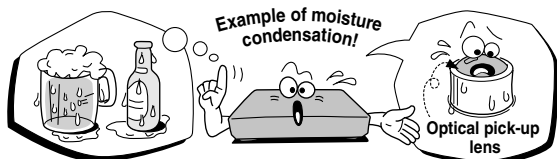

Moisture condensation occurs during the following cases.

- When you bring the unit directly from a cold place to a warm place.
- When you use the unit in a room where you just turned on the heater, or a place where the cold wind from the air conditioner directly hits the unit.
- In summer, when you use the unit in a hot and humid place just after you move the unit from an air conditioned room.
- When you use the unit in a humid place.

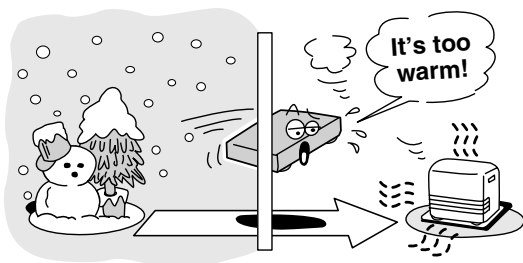

Do not use the unit when moisture condensation may occur.

If you use the unit in such a situation, it may damage discs and internal parts. Connect the power cord of the unit to the wall outlet, turn on the unit, remove the disc, and leave it for two or three hours. After two or three hours, the unit will have warmed up and evaporated any moisture. Keep the unit connected to the wall outlet and moisture condensation will seldom occur.

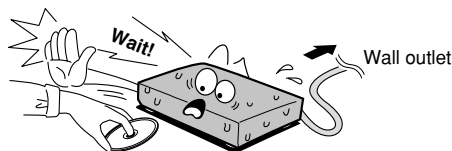

Notes on copyright

- The unauthorized recording, use, display, distribution, or revision of television programs, videotapes, HD DVDs, DVDs, CDs and other materials, is prohibited under the Copyright Laws of the United States and other countries, and may subject you to civil and/or criminal liability.
- This product incorporates copyright protection technology that is protected by method claims of certain U.S. patents and other intellectual property rights owned by Macrovision Corporation and other rights owners. Use of this copyright protection technology must be authorized by Macrovision Corporation, and is intended for home and other limited viewing uses only unless otherwise authorized by Macrovision Corporation. Reverse engineering or disassembly is prohibited.

Manufactured under license from Dolby Laboratories. Dolby and the double-D symbol are trademarks of Dolby Laboratories.

Manufactured under license from Digital Theater Systems, Inc. U.S. Pat. No's. 5,451,942; 5,956,674; 5,974,380; 5,978,762; 6,226,616; 6,487,535 and other U.S. and world-wide patents issued and pending. "DTS" and "DTS Digital Surround" are registered trademarks of Digital Theater Systems, Inc. Copyright 1996, 2003 Digital Theater Systems, Inc. All Rights Reserved.

HDMI, the HDMI logo and High-Definition Multimedia Interface are trademarks or registered trademarks of HDMI Licensing LLC.

SHARC is a registered trademark and Melody is a trademark of Analog Devices, Inc.

All other brand and product names mentioned in this manual are trademarks and/or registered trademarks of their respective holders.

Features

Playback of HD DVD video discs

HD DVD video discs are high-density, high-capacity discs.

- The HD DVD disc standard has been approved by the DVD forum.
- HD DVD (single layer): 15 GB
HD DVD (dual layer): Maximum capacity of 30 GB
A single layer single sided disc (15 GB) has capacity of about 8 hours in 1125 line high definition picture; about 48 hours in 525 line standard definition picture (depending on bitrate of pre-recorded contents).
*1GB means 1,000,000,000 bytes.
- HD DVD Twin Format Discs have both HD DVD and DVD layers on one side. HD DVD Combination DVD Discs have HD DVD material on one side and standard DVD material on the other side. Because both disc types are new, such discs may not operate properly in this player.
- To view high-definition picture in HD DVD discs, an HDTV display (720p, 1080i) is required.
- Connect an HDTV set to the COMPONENT OUTPUT jacks or the HDMI OUTPUT jack on this player.
- Some discs may require use of HDMI OUTPUT for viewing of high resolution material.

Compatible with multiple disc types

- Playback of commercial HD DVD video disc, DVD video, and Audio CD
- Playback of DVD-RAM, DVD-RW (disc recorded in DVD VR mode or DVD video mode), and DVD-R
- Playback of CD-RW and CD-R (Audio CD or CD-DA format, MP3 file, WMA file)

Because HD DVD is a new format, disc compatibility issues with new and existing format discs are possible. Not all discs are compatible. If you experience compatibility problems, please contact Toshiba Customer Service.

Blu-ray Discs cannot be played on this player.

Internet connection feature (LAN port)

- Some HD DVD discs enable you to access special HD DVD sites. If an HD DVD site includes content such as movie trailers, you can watch the content on the player via the Internet if your internet connection provides sufficient bandwidth.

Compatibility notes

- For compatibility, see  page 27.

Various output jacks

- An HDMI jack for connecting a single cable to output video and audio signals
- Component jacks
- 5.1 channel surround analog audio jacks

Certain system requirements

For high definition video playback:

- High definition display (720p and 1080i input capable).
- HD DVD disc with high definition content.
- HDMI or HDCP capable DVI input on your display device required for some content (as specified by disc authors).
- For up-conversion of standard definition DVD, an HDMI or HDCP capable DVI input on your display device is required for copy protected content.

For Dolby® Digital Plus and DTS-HD (DTS core only) multi-channel audio playback:

- Receiver or processor/amp combination with 5.1 channel analog input or HDMI™ multi-channel LPCM capable audio input.
- Main, center, surround speakers and subwoofer as necessary for chosen format.

For on-line interactive features:

- Ethernet connection to customer supplied always-on broadband internet service.
- Some features may require higher bandwidth.

Customer support

To reach Toshiba Customer Support in the U.S., please call 1 (800) 319-6684 or visit www.tacp.com/customersupport.

To reach Toshiba Customer Support in Canada, please call 1 (800) 268-3404 or visit www.toshiba.ca and click on support.

This HD DVD player is manufactured under the HD DVD Format adopted by DVD Forum. DVD Forum approved AACSS (Advance Access Content System) as content protection system for HD DVD Format like it approved CSS (Content Scramble System) for DVD Format. Therefore, certain restrictions are imposed on play, analog signal output, etc. of AACSS protected contents.

When you use pre-recorded contents, the contents may designate whether or not to apply such restrictions.

As those restrictions may be adopted and/or changed and announced by AACSS after the production of this product, the operation of this product and restrictions thereon may vary depending on the time you purchase this product.

To obtain updated information about AACSS and this product, please contact the following:

*In the U.S., please call 1 (800) 319-6684 or visit www.tacp.com/customersupport.

*In Canada, please call 1 (800) 268-3404 or visit www.toshiba.ca and click on support.

Accessories

Accessories

Check that the following accessories are supplied.

Remote control
Batteries
(AAA)x4

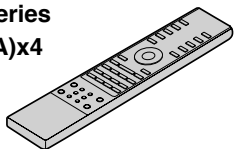

Audio cable

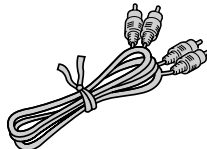

Video cable

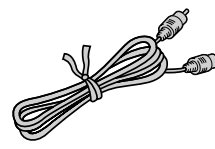

HDMI cable

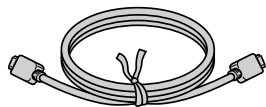

Power cord

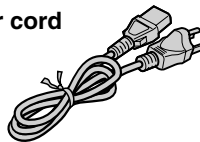

Caution

- Do not use this power cord with any device other than this player.

Table of Contents

1 Introduction	■ SAFETY PRECAUTIONS	2
	■ IMPORTANT SAFETY INSTRUCTIONS.....	4
	■ Precautions	6
	■ Features.....	8
	■ Accessories.....	9
	■ Index to parts and controls.....	12
	● Front panel	12
	● Rear panel.....	13
	● Display	14
	● Remote control.....	15
	■ Preparation of the remote control.....	16
	● Loading batteries	16
	● Operating with the remote control.....	16
	● About the remote control backlight.....	16
	● Programming for TV control	17
	● Operating your TV with the remote control.....	17
■ Hint on reading this manual	18	
● Icons for disc compatibility	18	
● Instructions and actual buttons.....	18	
2 Connections	■ Connecting to a TV	20
	■ Connecting to a device with an HDMI input.....	21
	■ Connecting to a TV with component video inputs	22
	■ Connecting to an audio system	23
3 Playback (Basic)	■ Disc compatibility	26
	■ Powering on/Loading a disc	28
	■ Playing a disc.....	29
	● Stopping playback / Pausing playback	29
	● Playing from the top menu	30
	● Using A/B/C/D buttons.....	30
	● Playing from a recorded title menu	30
	● Selecting the sound	31
	● Selecting the sound of a disc recorded in DVD VR mode.....	31
	● Selecting subtitles	32
	● Selecting the camera angle	32
■ Playing at various speeds.....	33	
● Locating by entering a section number	34	
● Locating by entering elapsed time	34	
● Resuming playback from the location last stopped (Title resume).....	34	

4 Playback (Advanced)	■ Playing repeatedly (Repeat playback)	36
	■ Playing MP3/WMA files on a CD	37
	● Playable files	37
	■ Using EXTENSION ports	38
	■ Using the cursor function	38
	■ Checking the current status and settings	39
5 Internet connection	■ Internet connection feature (Outline).....	42
	■ Internet connection feature (Preparation).....	44
	■ Internet connection feature (Operation).....	47
6 Others	■ Customizing the function settings.....	50
	● Picture	52
	● Audio	53
	● Language	54
	● Ethernet	55
	● General.....	56
	● Firmware update	57
	■ Language code list	58
	■ Output sound conversion table.....	59
	■ Before calling service personnel	60
	■ Specification	61
■ Limited United States Warranty.....	62	
■ CANADIAN WARRANTY INFORMATION.....	64	
■ INFORMATION ON CUSTOMER SUPPORT	Back cover	

Index to parts and controls

See pages with arrows for details.

Front panel

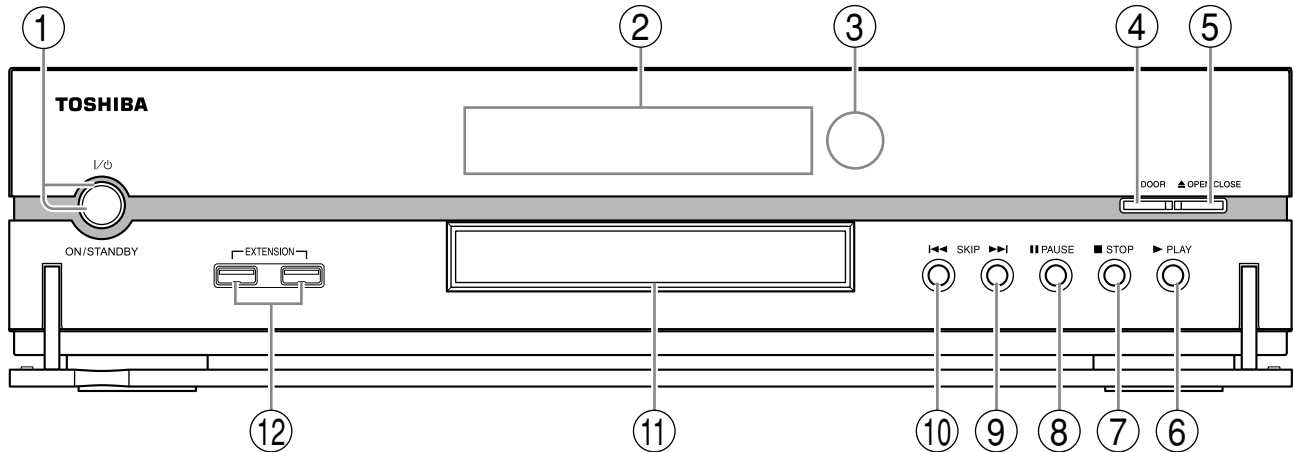

① **ON/STANDBY button / ON/STANDBY indicator** ➔ page 28

Turns the power on/restores the unit to the standby mode.

② **Front panel display** ➔ page 14

③ **Remote sensor** ➔ page 16

④ **DOOR button** ➔ page 28

Opens and closes the front door.

⑤ **OPEN/CLOSE button** ➔ page 28

Opens and closes the disc tray.

⑥ **▶ (PLAY) button** ➔ page 29

Starts playback.

⑦ **■ (STOP) button** ➔ page 29

Stops playback.

⑧ **⏸ (PAUSE) button** ➔ page 29

Stops playback momentarily.

⑨ **⏭ (SKIP) button** ➔ page 33

Skips to the next chapter or track.

⑩ **⏮ (SKIP) button** ➔ page 33

Skips to the previous chapter or track.

⑪ **Disc tray** ➔ page 28

Loads a disc into the disc drive.

⑫ **EXTENSION ports** ➔ page 38

Rear panel

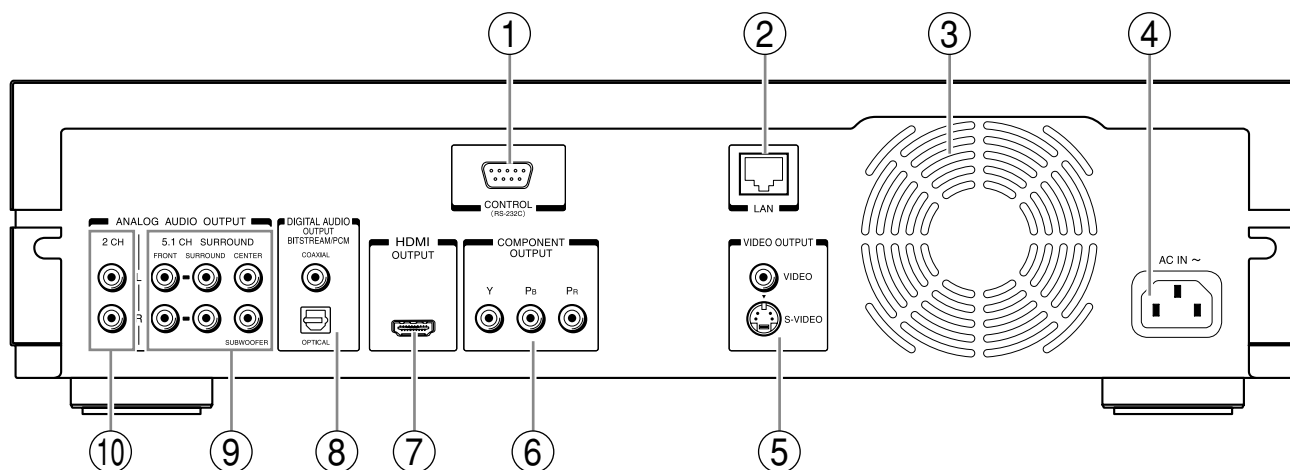

① CONTROL (RS-232C)

Used for custom control devices.

② LAN port ➔ page 44

Use this to connect to a network with an always-on broadband connection.

③ Ventilation fan

Do not cover the ventilation holes.

④ AC IN socket ➔ page 20

Connect the supplied power cord.

⑤ VIDEO OUTPUT (VIDEO, S-VIDEO) ➔ page 20

Outputs video and audio signals to a connected TV or amplifier.

⑥ COMPONENT OUTPUT jacks ➔ page 22

Outputs video signals to a connected TV or monitor.

Connect to a TV or monitor equipped with component video jacks.

⑦ HDMI OUTPUT jack ➔ page 21

Outputs video/audio signals to a connected TV, monitor or AV amplifier.

Connect to a TV, monitor or AV amplifier equipped with HDMI input.

⑧ DIGITAL AUDIO OUTPUT BITSTREAM/PCM (OPTICAL/COAXIAL) jacks ➔ page 23

Outputs digital audio signals.

Connect to a digital audio input on an amplifier equipped with digital audio decoder.

When connecting the optional digital cable, fit the connector into the jack firmly.

⑨ ANALOG AUDIO OUTPUT 5.1 CH SURROUND jacks ➔ page 23

Connect to an amplifier equipped with 5.1 CH audio input.

⑩ ANALOG AUDIO OUTPUT 2 CH jacks ➔ page 20

Outputs audio signals to a connected TV or AV amplifier.

Index to parts and controls (Continued)

Display

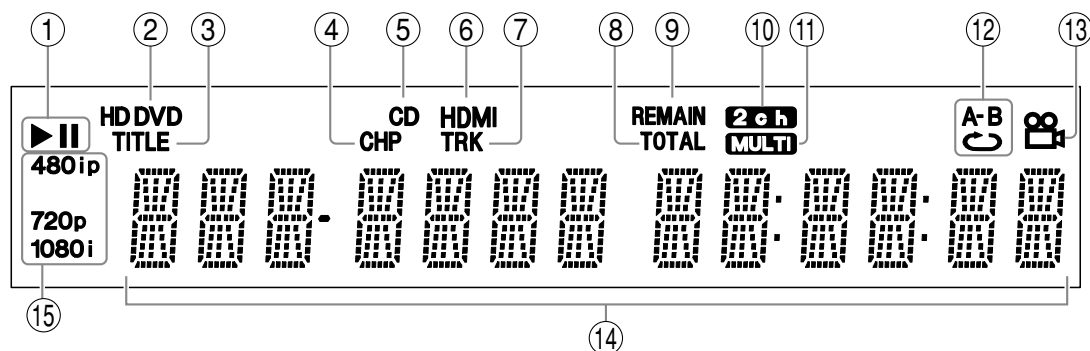
① **Status indicator**

- ▶ : Playing
- ⏸ : Pausing

② **Disc indicator**

- HD DVD: Illuminates when an HD DVD disc is loaded.
- DVD : Illuminates when a DVD disc is loaded.

③ **TITLE indicator**

- Illuminates when a title number is displayed.

④ **CHP (Chapter) indicator**

- Illuminates when a chapter number is displayed.

⑤ **CD indicator**

- Illuminates when a CD is loaded.

⑥ **HDMI Indicator**

- Illuminates when selecting the HDMI output.

⑦ **TRK (Track) indicator**

- Illuminates when a track number is displayed.

⑧ **TOTAL indicator**

- Illuminates when the total playing time of the disc is displayed.

⑨ **REMAIN (Remaining) indicator**

- Illuminates when a remaining playback time is displayed.

⑩ **2ch indicator**

- Illuminates when 2 channel (L/R) sound is output.

⑪ **MULTI indicator**

- Illuminates when 5.1 channel sound is output.

⑫ **Repeat mode indicator**

- Illuminates when playing in repeat mode.

⑬ **Angle icon indicator**

- Illuminates when playing a scene recorded with multi angles.

⑭ **Multi display**

- Displays the total playing time of the disc, elapsed time, remaining time, title number, chapter number or message, etc.

⑮ **Video output format indicator**

- Displays the video output format currently selected.
- 480i : 480 interlace
- 480p : 480 progressive
- 720p : 720 progressive
- 1080i : 1080 interlace

■ **Switching the display**

- DISPLAY Every time you press DISPLAY button on the remote control, the display changes the contents.
- The display may not change, depending on the disc conditions.

■ **Dimming the display**

Pressing DIMMER button on the remote control changes the brightness of the display.

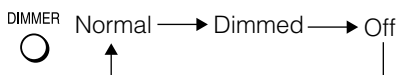

- Turning off the power resets this setting.

Remote control

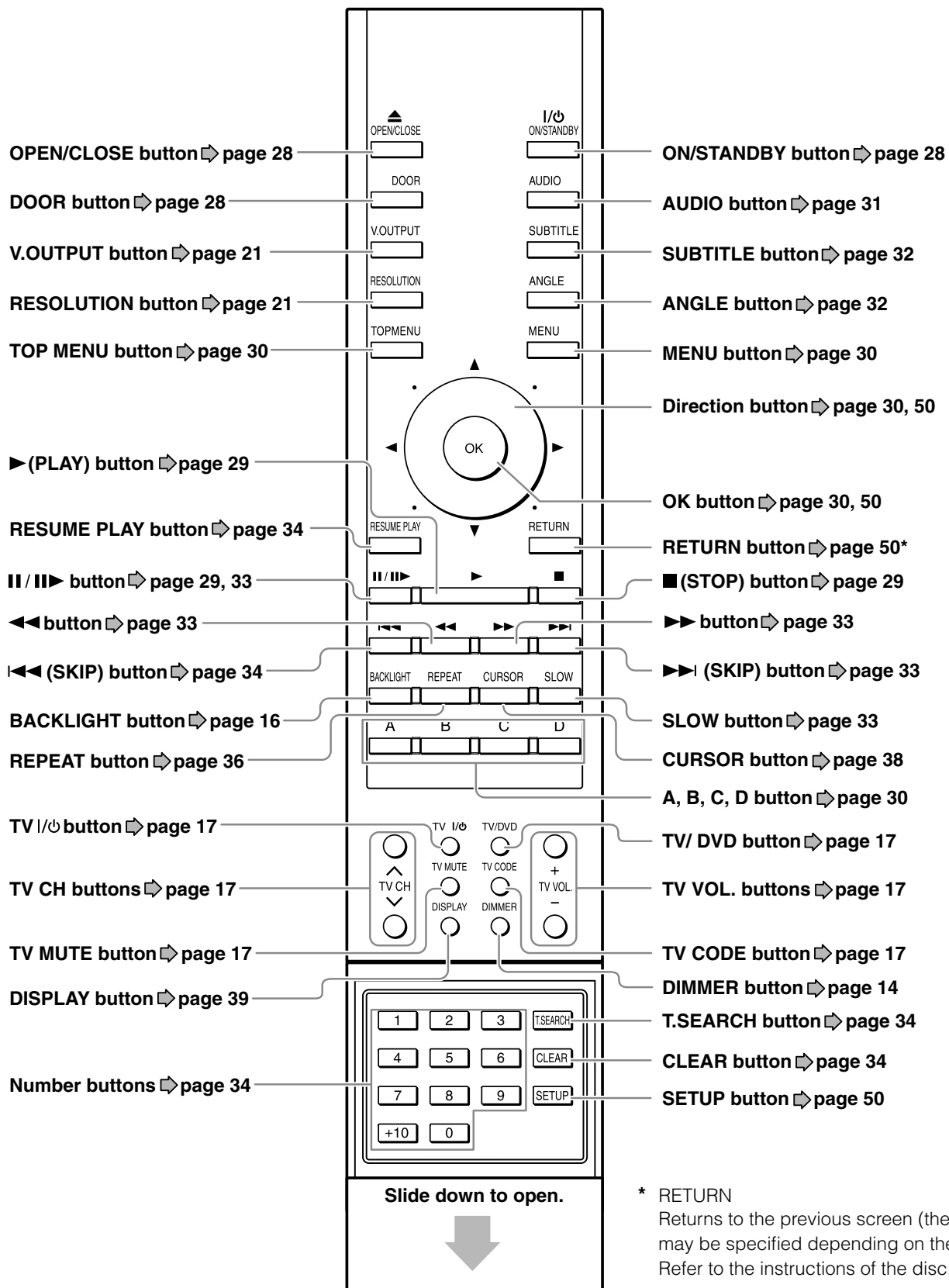

Preparation of the remote control

Set up the remote control to operate the player and your TV.

Loading batteries

1 Open the cover.

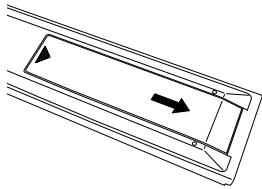

2 Insert batteries.

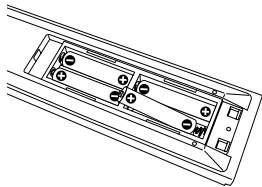

- Use 4 batteries (AAA sizes).
- Make sure to match the + and – on the batteries to the marks inside the battery compartment.

3 Close the cover.

Notes

- Do not drop or give the remote control a shock.
- Do not leave the remote control near an extremely hot or humid place.
- Do not spill water or put anything wet on the remote control.
- Do not disassemble the remote control.
- Dispose of batteries in a designated disposal area.
- Batteries should always be disposed of with the environment in mind.
- Always dispose of batteries in accordance with applicable laws and regulations.
- If the remote control does not operate correctly, or if the operating range becomes reduced, replace all batteries with new ones.
- When necessary to replace batteries in the remote control, always replace all batteries with new ones. Never mix battery types or use new and used batteries in combination.
- Be sure to use AAA size batteries.
- Always remove batteries from remote control if they are dead or if the remote control is not be used for an extended period of time. This will prevent battery acid from leaking into the battery compartment.

Caution

- Never throw batteries into a fire.

About the remote control backlight

The remote control has a backlight function for conveniently illuminating the buttons when you use the remote control in a dark room, etc.

- Lights for approximately 10 seconds when a button is pressed.
- Lights for approximately 10 seconds when the remote control senses a certain amount of vibration (approximately 1 second for a small amount of vibration).

Operating with the remote control

Point the remote control at the remote sensor and press the buttons.

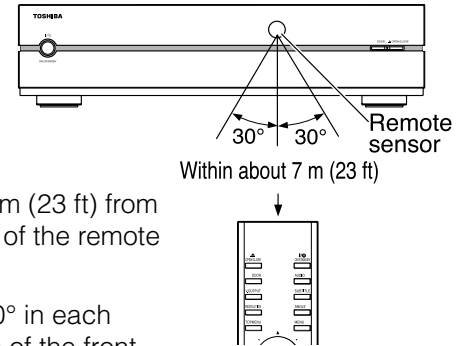

Distance: About 7 m (23 ft) from the front of the remote sensor

Angle : About 30° in each direction of the front of the remote sensor

Programming for TV control

1 While holding , press the number buttons to enter a corresponding brand code (see below) of your TV.

e.g. To enter 0001

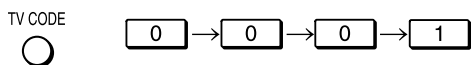

Hold down.

- Some brands have several codes. Try one by one until the remote control can operate your TV.

2 Release .

The brand code is memorized.

Notes

- TOSHIBA code is already set when you operate this player for the first time.
- When replacing the batteries of the remote control, re-enter the brand code of your TV.

Operating your TV with the remote control

Point the remote control to your TV after you have entered the brand code. Operate your TV with the buttons below.

TV/DVD :
To change the video input

TV I/O :
To turn on and off the TV

TV CH :
To select the TV channel

TV MUTE :
To mute the TV

TV VOL. :
To adjust the volume

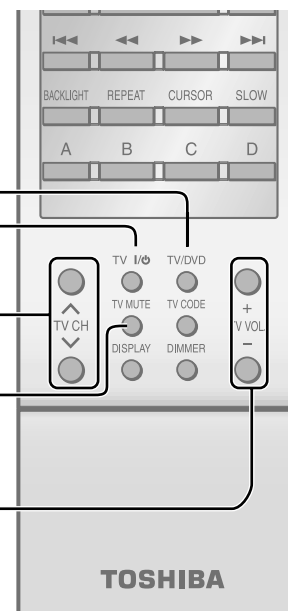

Notes

- For some TVs, pressing the volume button once may change the volume by more than one level.
- Even after the player's remote control is programmed, it may not operate some or all of the features on your other device.

If this happens and you wish to use those features, you will need to use the device's original remote control.

Brand code table

Brand name	Brand code						
Toshiba	0001	0021	0071	0411	0431	0831	
	0841	0851	1341	1611	1621	1781	
	1951	2121	2491	4371	5951	5971	
	6041						
Bell & Howell	0081	0431					
Citizen	0051	0381	0471	0551	0621	0851	
	1561						
Curtis Mathes	0051	0431	0531	0621	0851	1521	
	1561	6671					
Emerson	0051	0111	0121	0141	0151	0161	
	0201	0211	0351	0381	0431	0521	
	0561	0621	0691	1241	1291	1371	
	1561	2481	4861				
Fisher	0251	0401	0431	1151	2451		
	0051	0091	0181	0321	0371	0591	
GE	0621	0711	0741	1041	1471	1521	
	2481	4691	4881	4891	6671		
Goldstar	0051	0161	0231	0451	0501	0621	
	0661	0771	0961	1431	1561	2491	

Brand name	Brand code					
Hitachi	0031	0051	0161	0191	0301	0601
	0621	0641	0671	0811	0951	1011
	1061	1241	1361	1651	1711	1731
	1741	1751	2051	2131	2381	4121
	4731	4911	4961			
Infinity	0631					
	0631					
JBL	0101	0161	0191	0241	0331	0511
	0561	0601	0741	1321	1421	2161
	2171	4351	4701	4751	4771	4971
	5031	5041	5051			
LXI	0411	0431	0621	0631	1041	1171
	1521	2491	6671			
Magnavox	0051	0271	0291	0341	0361	0421
	0551	0621	0631	0661	0971	0981
	2221	5221	5231	5241		
	0051	0481	0621	0631	0641	2491
Memorex	0081	0431	0501	0621	2491	4421
	5251					
MGA	0051	0251	0261	0371	0501	0621
	0661	0761				

(Continued)

Preparation of the remote control (Continued)

Brand name	Brand code					
Mitsubishi	0051	0251	0261	0371	0491	0501
	0621	0661	0761	2231	5261	5271
MTC	0051	0501	0621	0851		
NAD	0411	0621	1061			
Optonica	0541	1101				
Panasonic	0631	0711	0741	1271	1351	1501
	1701	1791	1801	2111	2151	2281
	5281	5301	5661			
Philco	0051	0161	0271	0291	0361	0421
	0501	0551	0621	0631	0661	0711
Philips	0051	0161	0271	0321	0361	0421
	0461	0551	0631	0661	0711	2141
	2351	5221	5401	5411	5431	5451
	5461	5481	5501	5531	5541	5601
	5621					
Pioneer	0051	0621	0681	0721	0751	1061
	1241	1581	1971	4081	4111	
Proton	0051	0161	0621	0651	2491	
Quasar	0711	0741	0801	1271	2281	5651
	5661					
Radio Shack	0431	1521	2481			
Radio Shack/Realistic	0051	0161	0381	0431	0541	0621
	1431	1561	6671			
RCA	0051	0221	0501	0621	0661	0711
	0871	0921	0941	1001	1041	1071
	1091	1181	1241	1301	1461	1521
	1531	2481	4361	4861	4881	5681
	6641	6671				
Realistic	0431	1521				
Runco	0011					









Brand name	Brand code					
Samsung	0051	0161	0501	0531	0621	0661
	0851	0931	1021	1141	1431	1561
	1591	1601	1771	1811	1821	1831
	1841	1851	1931	2081	2101	2311
	4011	4061				
Sanyo	0051	0261	0401	0431	0791	0901
	1151					
Sears	0051	0151	0191	0251	0331	0401
	0411	0431	0621	0661	1041	1081
	1151	1481	1521	2481	6671	
Sharp	0051	0111	0161	0351	0541	0581
	0611	0621	0731	0891	1101	1561
	1721	1871	1881	1941	2181	2341
	5741	5751				
Sony	0441	1111	1231	1511	1901	2061
Soundesign	0051	0151	0381	0551	0621	2481
Sylvania	0051	0071	0271	0291	0341	0361
	0421	0551	0621	0631	0661	0861
	1441	2191	2201	4151	5481	
Tandy	1101					
Technics	0741					
Teknika	0051	0081	0151	0161	0191	0341
	0381	0471	0501	0551	0621	0851
	1271	1561	2481			
Wards	0051	0081	0141	0151	0181	0211
	0271	0321	0341	0361	0421	0501
	0541	0621	0631	0661	1051	1521
	2491	6671				
Zenith	0011	0051	0081	0781	1281	1571
	2091	2251	2361	2441	4821	6151
	6171	6181				

Hint on reading this manual

Icons for function applicability

The following icons are used in this manual to indicate features and/or functions that are applicable to various types of discs.

(For disc compatibility information, see  page 26.)

Icon	Disc	Icon	Disc
	HD DVD video disc		DVD-R
	DVD video disc		Audio CD
	DVD-RAM		CD-RW (CD-DA format)
	DVD-RW		CD-R (CD-DA format)

Instructions and actual buttons

Most instructions are based on remote control operation, unless otherwise noted. You can use the buttons on the remote control and those on the main unit as well when they have the same function. Some functions are available only from the remote control.

2 Connections

Connect your player to your A/V system.

Connecting to a TV

Connecting to a device with an HDMI input

Connecting to a TV with component video inputs

Connecting to an audio system

Connecting to a TV

Connect the player to your TV to view disc contents.

To view 480p, 720p, 1080i pictures, use the HDMI OUTPUT jack or the COMPONENT OUTPUT jacks to connect to a TV. (➡ page 21, “Connecting to a device with an HDMI input”, ➡ page 22, “Connecting to a TV with component video inputs”). Some discs may require use of the HDMI OUTPUT for viewing of high resolution material.

See ➡ page 21.

If the TV has an S-video input, connect the player with an S-video cable. When using an S-video cable, do not connect the yellow video cable.

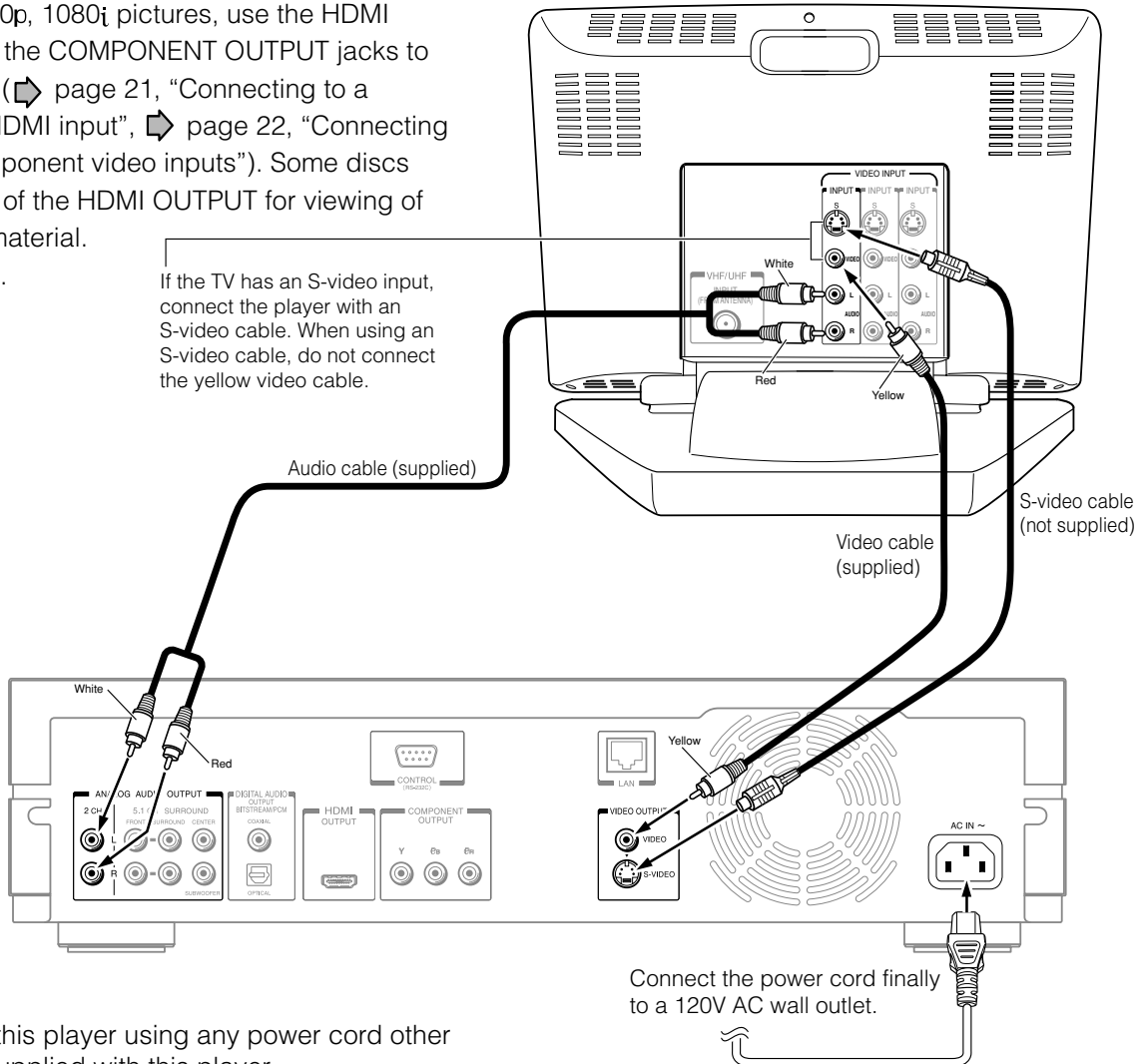

Caution

- Do not power this player using any power cord other than the one supplied with this player.
- Do not use the supplied power cord with any device other than this player.

Switching output signals and setting the resolution

Turn on the player (➡ page 28) before you configure the following setting.

1 Press **V.OUTPUT** (remote control).

Player display window: **HDMI**

Make sure the HDMI indicator **URNS OFF**.

2 Press **RESOLUTION** repeatedly (remote control).

Set the resolution to output from the player in accordance with the scanning method (480i) of the connected TV. Select “480i” on the player display window.

Notes

- When you connect the player to your TV, be sure to turn off the power and unplug both units from the wall outlet before making any connections.
- Connect the player directly to your TV. If you connect the player to a VCR, TV/VCR combination, video selector or AV amplifier, the playback picture may be distorted due to copy protection.

Connecting to a device with an HDMI input

HDMI stands for High Definition Multimedia Interface. HDMI transfers digital audio and uncompressed digital video on a single cable. As a result, audio cables and video cables don't need to be connected separately to a device. The HDMI OUTPUT jack is designed to HDMI Version 1.1.

To view 480p, 720p, 1080i pictures, use the HDMI OUTPUT jack or the COMPONENT OUTPUT jacks to connect to a TV (➡ page 22, "Connecting to a TV with component video inputs"). Some discs may require use of the HDMI OUTPUT for viewing of high resolution material. See note regarding copy protection.

Note on copy protection and high definition viewing

HD DVD and DVD video disc creators have the option to include copy protection instructions in their discs that prohibit the output of some standard video or high definition video (original 720p or 1080i or up-converted 480i or 480p) from the COMPONENT OUTPUT jacks. If such instructions are present in the disc you are playing, you must use the HDMI OUTPUT jack to view the disc in a high definition format and the COMPONENT OUTPUT jacks, if activated, will output video only in 480i or 480p resolution.

HDMI compatible device

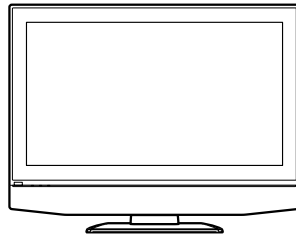

Depending on the equipment connected to this player, such as a TV or a projector, no sound may be output by the display. In this case, set "Digital out HDMI" (➡ page 53) to "PCM". If sound still is not heard, use analog output.

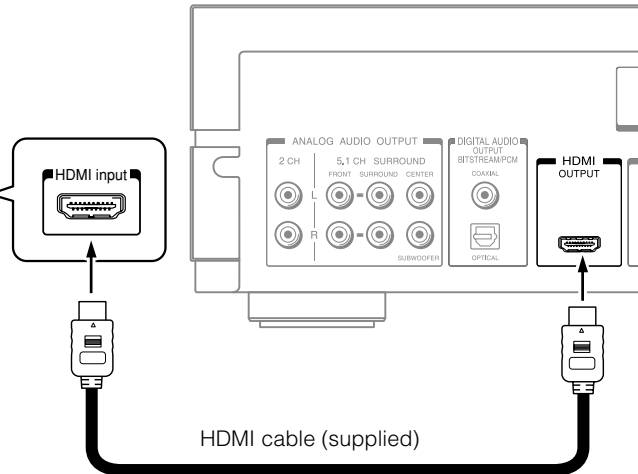

• Set "Digital out HDMI" (➡ page 53).

Switching output signals (Switching to HDMI output and setting the resolution)

Turn on the player (➡ page 28) before you configure the following setting.

1 Press **V.OUTPUT** (remote control).

Player display window **HDMI** Make sure the HDMI indicator **ILLUMINATES**.



When the HDMI indicator illuminates, signals are being input from the HDMI OUTPUT jack.

When HDMI output is selected, video cannot be displayed from the COMPONENT OUTPUT jacks, S-VIDEO jack, and VIDEO jack (yellow).

2 Press **RESOLUTION** repeatedly (remote control).

Set the resolution to output from the player in accordance with the scanning method of the connected TV.

Pressing the button switches between 480p, 720p, and 1080i. The setting is indicated on the player display window.

Notes

- Refer to the owner's manual for the TV to be connected to this player for more information concerning HDMI connections.
- When the HDMI connection is not verified, the error message appears on the front panel display. In this case, disconnect the HDMI cable then connect it again, or turn off the connected HDMI device then turn it on.
- HDMI output is digital only, DVI analog is not supported.
- HDMI is an evolving technology, so it is possible that some devices may not operate properly with this player.
- Be sure to use an HDMI cable with the HDMI logo (**HDMI**) to connect an HDMI device.
- If your display does not support multi-channel audio, to use multi-channel audio you will need to either use an AV receiver that supports multi-channel audio over HDMI (set "Digital out HDMI" to "Auto" or to match the decoding capability of your equipment) or use a receiver that has a coaxial or optical SPDIF digital audio input (set "Digital audio SPDIF" to match the decoding capability of your equipment).

HDMI, the HDMI logo and High-Definition Multimedia Interface are trademarks or registered trademarks of HDMI Licensing LLC.

Connecting to a TV with component video inputs

If your TV has component video inputs, you can obtain pictures in better quality. You may also view 480p, 720p, 1080i pictures using the HDMI OUTPUT jack to connect to a TV (➔ page 21, “Connecting to a device with an HDMI input”).

Note on copy protection and high definition viewing

HD DVD and DVD video disc creators have the option to include copy protection instructions in their discs that prohibit the output of some standard video or high definition video (original 720p or 1080i or up-converted 480i or 480p) from the COMPONENT OUTPUT jacks. If such instructions are present in the disc you are playing, you must use the HDMI OUTPUT jack to view the disc in a high definition format and the COMPONENT OUTPUT jacks, if activated, will output video only in 480i or 480p resolution.

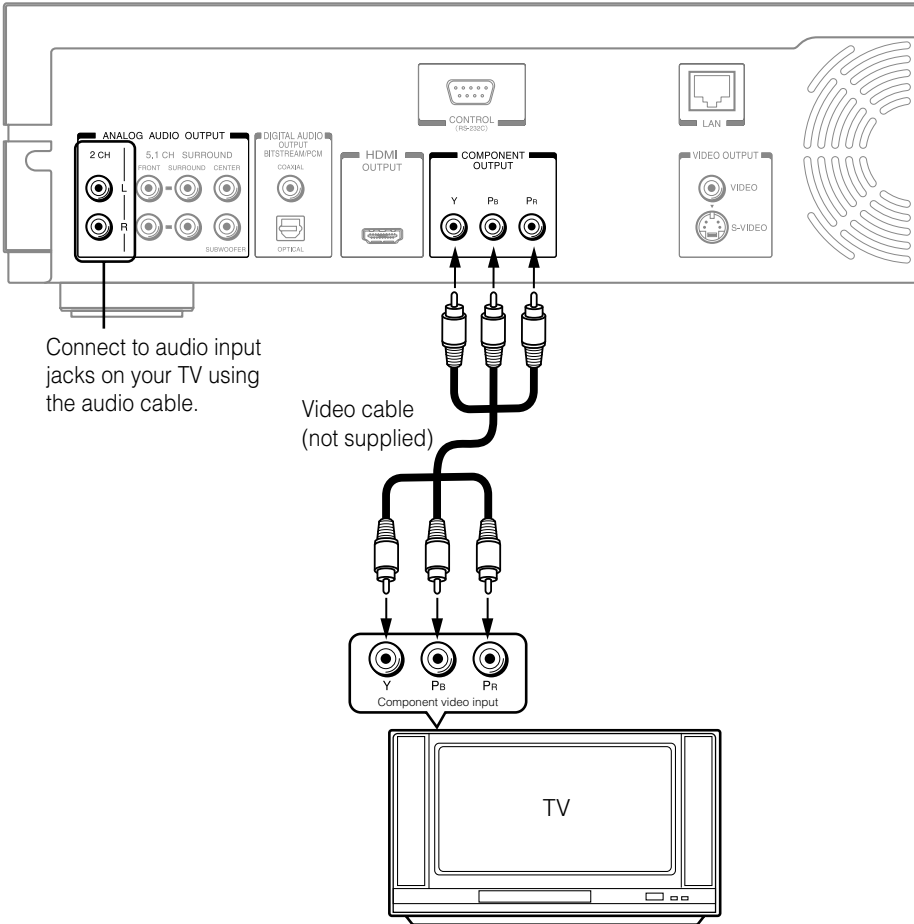

Switching output signals (Switching to component video output and setting the resolution)

Turn on the player (➔ page 28) before you configure the following setting.

1 Press **V.OUTPUT** (remote control).

Player display window: **HDMI** (circled in red)

Make sure the HDMI indicator **TURNS OFF**.

When the HDMI indicator turns off, signals are being output from the COMPONENT OUTPUT jacks.

2 Press **RESOLUTION** repeatedly (remote control).

Set the resolution to output from the player in accordance with the scanning method of the connected TV. Pressing the button switches between 480i, 480p, 720p, and 1080i. The setting is indicated on the player display window.

Notes

- When 1080i or 720p is selected, video cannot be displayed from the S-VIDEO jack nor VIDEO jack (yellow).
- Depending on a combination of the characteristics of the connected TV, resolution of the video source, and video output resolution of the player, high-resolution output may not provide the best picture. Change the output resolution according to your preferences.

Connecting to an audio system

You can enjoy multichannel surround-sound such as 5.1 channel by connecting to an amplifier compatible with Dolby® Digital and DTS® sound.

Via digital audio output

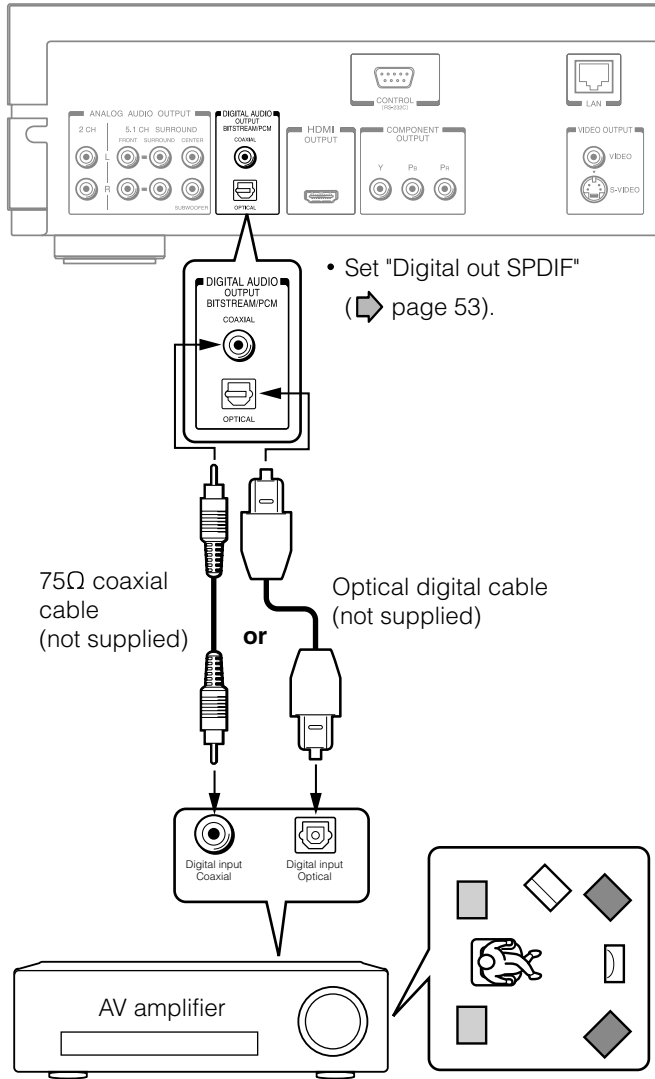

Via 5.1ch analog audio output

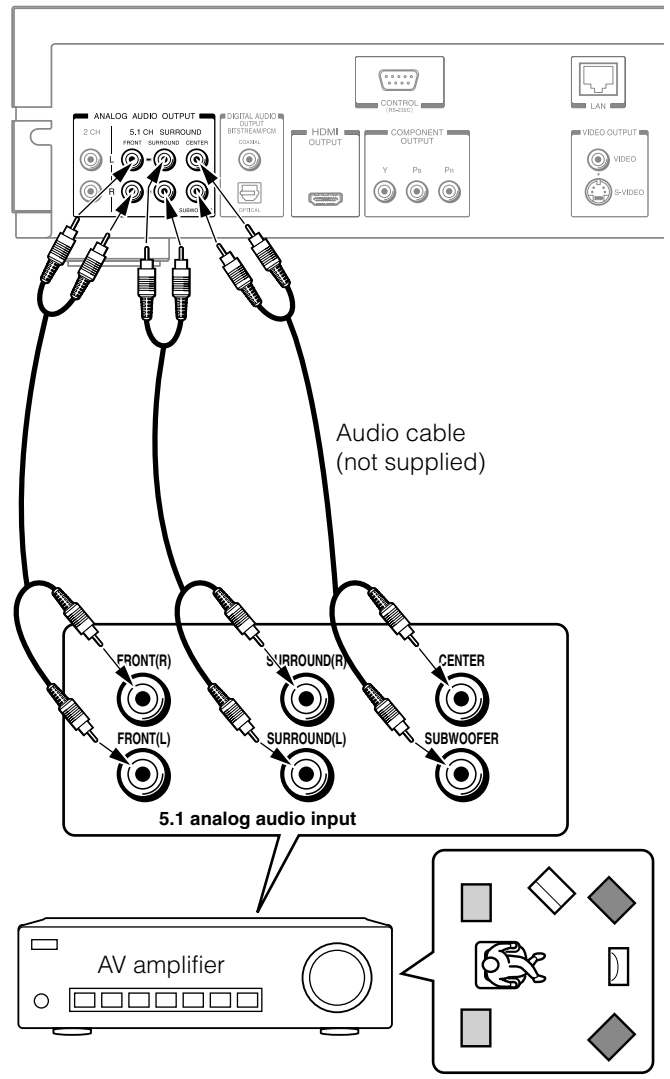

Caution

- When you are connecting (via the DIGITAL AUDIO OUTPUT BITSTREAM/PCM jack) an AV decoder that does not have Dolby Digital, DTS or MPEG decoding capability, be sure to set "Digital out SPDIF" (➔ page 53) to "PCM". Otherwise, high volume sound may damage your hearing as well as the speakers.

Manufactured under license from Dolby Laboratories. Dolby and the double-D symbol are trademarks of Dolby Laboratories.

Manufactured under license from Digital Theater Systems, Inc. U.S. Pat. No's. 5,451,942; 5,956,674; 5,974,380; 5,978,762; 6,226,616; 6,487,535 and other U.S. and world-wide patents issued and pending. "DTS" and "DTS Digital Surround" are registered trademarks of Digital Theater Systems, Inc. Copyright 1996, 2003 Digital Theater Systems, Inc. All Rights Reserved.

Connecting to an audio system (Continued)

Via HDMI output

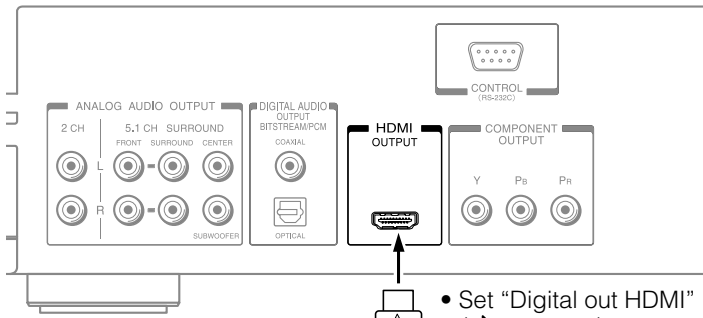

• Set "Digital out HDMI" (➡ page 53).

HDMI cable (supplied)

You may need to adjust the HDMI audio output to match the capabilities of your AV amplifier. In this case, set "Digital out HDMI" (➡ page 53) to "PCM".

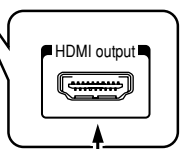
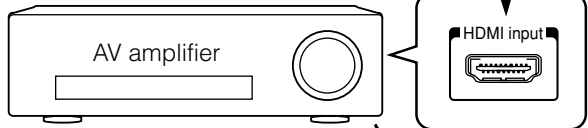

HDMI cable (not supplied)

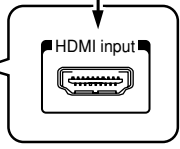
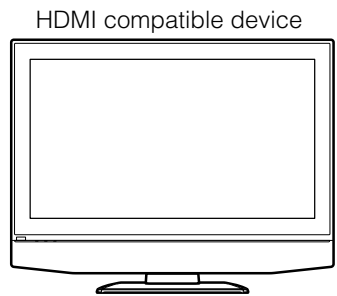

Caution

- When you are connecting (via the HDMI OUTPUT jack) an AV decoder that does not have Dolby Digital or DTS decoding capability, be sure to set "Digital out HDMI" (➡ page 53) to "PCM" or "Downmixed PCM". Otherwise, high volume sound may damage your hearing as well as the speakers.

Note about audio capabilities

- Dolby Digital Plus and DTS-HD (DTS core only) capability limited to 5.1 channels.
- DTS-HD processing of DTS core only. Full DTS-HD is not supported.
- Dolby TrueHD processing for two channels only.

3 Playback (Basic)

Play your favorite disc.

Disc compatibility





Powering on/Loading a disc

Playing a disc



Playing at various speeds

Disc compatibility

Pre-recorded discs

Disc	Specification
HD DVD video disc 	<ul style="list-style-type: none"> • 12cm (4³/₄ in.)/ 8cm (3¹/₄ in.)
DVD video disc 	<ul style="list-style-type: none"> • 12cm (4³/₄ in.)/ 8cm (3¹/₄ in.) • Region number 1 or ALL <p>The region number of this HD DVD player is 1. If region numbers, corresponding to a specific playable area, are printed on your DVD video disc and you do not find  or , or the disc is encoded to permit playback only in regions other than Region 1, disc playback will not be allowed by the player.</p>
Audio CD 	<ul style="list-style-type: none"> • 12cm (4³/₄ in.)/ 8cm (3¹/₄ in.)

Recordable discs you can play on this player

Disc	Specification
DVD-RAM 	<ul style="list-style-type: none"> • DVD VR mode recording (CPRM compatible discs can not be played.) • Single sided 4.7GB(12cm (4³/₄ in.)) • Double sided 9.4GB(12cm (4³/₄ in.)) <p>Note The DVD-RAM cartridge format is not supported. You may be able to remove the disc from a DVD-RAM cartridge to allow playback. Check the documentation that came with your DVD-RAM cartridge for availability of this option and instructions.</p>
DVD-RW  Except Ver. 1.0	<ul style="list-style-type: none"> • DVD VR mode recording (CPRM compatible discs can not be played.) • DVD Video mode recording <p>*Finalized discs only.</p>
DVD-R  DVD-R For DL	<ul style="list-style-type: none"> • DVD Video mode recording • 4.7GB For General <p>*Finalized discs only.</p>
CD-RW	<ul style="list-style-type: none"> • CD-DA (audio CD) format • MP3 file (➡ page 37) • WMA file (➡ page 37) <p>*Finalized discs only.</p>
CD-R	<ul style="list-style-type: none"> • CD-DA (audio CD) format • MP3 file • WMA file <p>*Finalized discs only.</p>

Notes

- Because HD DVD is a new format, disc compatibility issues with new and existing format discs are possible. Not all discs are compatible. If you experience compatibility problems, please contact Toshiba Customer Service. See ➡ page 8 for more information about disc compatibility.
- This player can play pictures of the NTSC color system only.
- You cannot play non-standardized discs even if they may be labeled as above.
- Discs other than the above cannot be played. Even some of the above discs may not be able to be played depending on their state.
- Blu-ray Discs cannot be played on this player.



is a trademark of DVD Format/Logo Licensing Corporation.

Compatibility notes

- Because HD DVD is a new format, certain disc, digital connection and other compatibility issues are possible. If you experience compatibility problems, please contact Toshiba Customer Service.
- Viewing high-definition content and up-converting standard DVD content may require an HDMI-capable input or HDCP-capable DVI input on your display device.
- Some HD DVD discs and DVD discs may restrict the use of some operation commands or features.
- Dolby Digital Plus and DTS-HD (DTS core only) capability limited to 5.1 channels.
- DTS-HD processing of DTS core only. Full DTS-HD is not supported.
- Dolby TrueHD processing for two channels only.
- Some DVD-R/DVD-RW and CD-R/CD-RW discs may be incompatible due to laser pick-up and disc design.
- DVD-R/DVD-RW discs must be recorded using DVD-Video method for video playback.
- CD-R/CD-RW discs must be recorded using CD-DA method for CD audio playback.
- This player may not support some MP3/WMA recordings due to differences in recording formats, disc structure or condition. (Use of CD-RW for MP3 files is not recommended.)
- The included remote control may not operate some or all features of your TV or monitor, so it may be necessary to use your original remote control.
- Certain features are subject to delayed availability.
- This product includes memory that is used to store some disc related information, including downloaded on-line content. The disc you are using will control how long this information is retained.

Note

- The firmware in this player can be updated. See  page 57 for details.

On handling discs

- Do not touch the playback side of the disc.
- Do not stick paper or tape to discs.

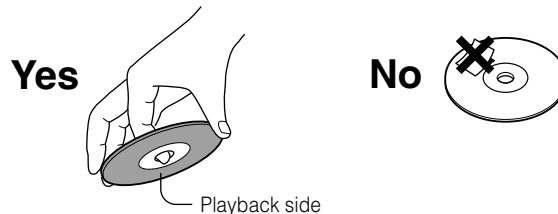

On cleaning discs

- Fingerprints and dust on the disc cause picture and sound deterioration. Wipe the disc from the center outwards with a soft cloth. Always keep the disc clean.





- Do not use any type of solvent such as thinner, benzene, commercially available cleaners or antistatic spray for vinyl LPs. It may damage the disc.
- Refer to the instructions of the disc as well.

On storing discs

- Do not store discs in a place subject to direct sunlight or near heat sources.
- Do not store discs in places subject to moisture and dust such as a bathroom or near a humidifier.
- Store discs vertically in a case. Stacking or placing objects on discs outside of their case may cause warping.
- Refer to the instructions of the disc as well.

Powering on/Loading a disc

Turning the power on

- 1** Press  (front panel) or  (remote control).

ON/STANDBY indicator ON/STANDBY button

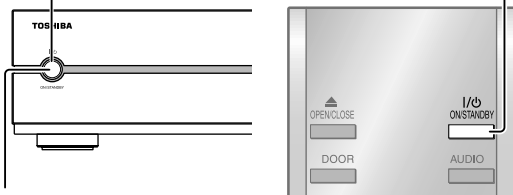

ON/STANDBY button

When the power turns on, ON/STANDBY indicator on the front panel changes color from red (standby mode) to green (operation).

Turning the power off



- 1** Press **ON/STANDBY**.

The power turns off and ON/STANDBY indicator on the front panel turns red (standby mode).

Note

- If the player freezes for about 15 minutes or more and will not respond to any buttons, holding down ON/STANDBY button on the front panel for about 10 seconds can force the player to turn off. However, this is an emergency measure, which may cause damage to the player. Avoid casual use of this measure.

Loading a disc

- 1** Press  (front panel) or  (remote control).

The player opens the door and then the disc tray.

- 2** Place a disc in the hollow of the disc tray with the playback side down.

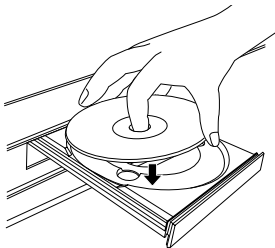



When using a double-sided disc, turn the label of the playing side up.

After placing a disc, press DOOR (see right) or OPEN/CLOSE.

- Do not load a disc which is unplayable, or any object other than a playable disc.
- Do not apply downforce to the disc tray. Doing so may cause the player to malfunction.
- If the disc tray stops while closing, the mechanical protection system of this player will open it. Do not force it to close. Doing so may damage the disc tray.
- If the disc tray will not open, turn the player off, and press OPEN/CLOSE on the front panel. This may turn the player on and open the disc tray. If it still won't open, contact your nearest TOSHIBA dealer.

Opening or closing the door

- Press  (front panel) or  (remote control).

The door on the front panel opens (closes).

- Use the button on the front panel or the remote control to open and close the door. Do not pull or push the door. Doing so may cause the player to malfunction.
- To close the door, unplug USB game controllers from the EXTENSION ports.
- The door may not be operated in some conditions such as immediately after powering on.
- The door automatically opens when opening the disc tray.

Notes

- Use the button on the front panel or the remote control to open and close the disc tray. Do not push or hold the disc tray while it is moving. Doing so may cause the player to malfunction.

Playing a disc

HD DVD	DVD-Video	CD
DVD-RAM	DVD-RW	DVD-R
CD-RW (CD-DA)	CD-R (CD-DA)	

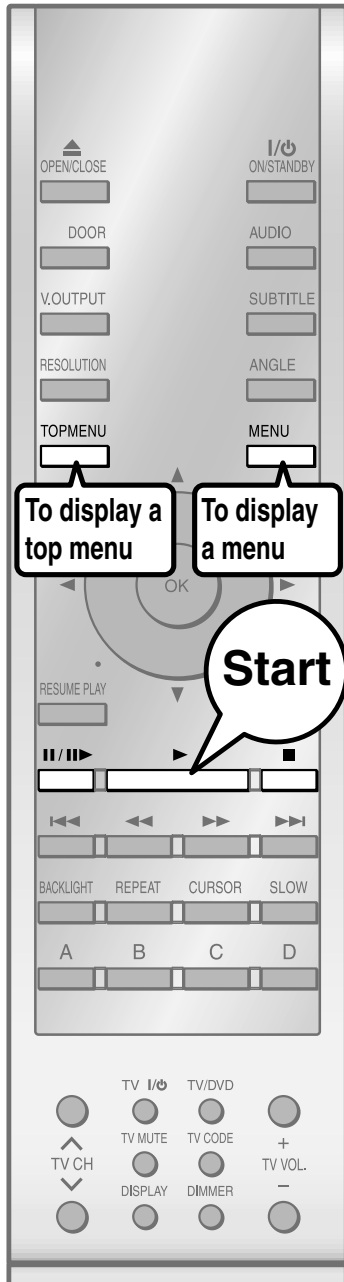

Preparation

- 1 Turn on the TV or audio system and select the corresponding input source that the player is connected to.
- 2 Turn the power on. (➡ page 28)

1

Load a disc and close the disc tray.

(➡ page 28)

Playback starts.

● If playback does not start

Press .

HD DVD | DVD-Video

If a loaded disc contains a top menu, a top menu appears when you start playback.

Depending on the disc, you may need to press or to display a top menu.

("Playing from the top menu", ➡ page 30)

DVD-RAM | DVD-RW | DVD-R

If a loaded disc contains a title menu, you can display it to select a desired title.

("Playing from a recorded title menu", ➡ page 30)

CD | CD-RW (CD-DA) | CD-R (CD-DA)

Playback starts automatically.

Stopping playback / Pausing playback

Press .

Playback stops.

During playback, press .

Playback pauses.

To resume, press .

Notes

- HD DVD video discs or DVD video discs provide high resolution pictures and a lot of information. Because of this, you may notice some fine picture noise on the TV screen, which you have never seen with a regular broadcast TV program. While the amount of noise depends on the TV you use with the player, you should generally reduce the sharpness adjustment on your TV when viewing HD DVD or DVD video discs.

Playing a disc (Continued)

Playing from the top menu

HD DVD DVD-Video

Some DVD video discs may include a top menu, on which you can view the structure of contents or select a scene.

1 Press .

A top menu appears.

2 Press  to select the title you want.

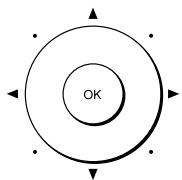

If the titles in the top menu are assigned a number, you can directly locate a specific title by pressing its designated number with the number buttons.

3 Press .

Playback starts from chapter 1 of the selected title.

Notes

- The instructions above describe basic procedures which may vary depending on the contents of a disc. If different instructions appear on the TV screen, follow those instructions.
- If you display the top menu during playback and press TOP MENU button again without selecting any title, the player may resume playback from the point where you first pressed TOP MENU button (depending on the actual disc.)
- This method of locating a title is available only on a disc that contains a top menu.
- Instruction notes of discs may refer to the button that displays the top menu as TITLE button.
- Depending on a disc, MENU button may have to be pressed instead of TOP MENU button to display the top menu.

Using A/B/C/D buttons

HD DVD

Use these buttons as indicated by the video display during HD DVD disc playback. Depending on the disc contents, the functions of each button may differ.

Playing from a recorded title menu

DVD-RAM DVD-RW

Discs recorded on personal devices such as DVD recorders may contain title menus, on which titles can be easily selected.

1 Press .

Recorded contents are displayed.

2 Press  to select the title you want.

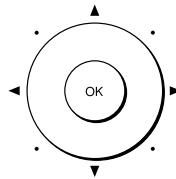

3 Press .

Playback of the selected title starts.

Notes

- Disc menus vary depending on the disc or the recording device. Some discs may not contain a disc menu.
- Discs recorded in DVD VR mode display the recorded contents not in thumbnails but in a list. Select a title on the list and press OK.



Selecting the sound

HD DVD DVD-Video DVD-RAM DVD-RW DVD-R

If a disc contains several languages, you can select a preferred language from them to hear.

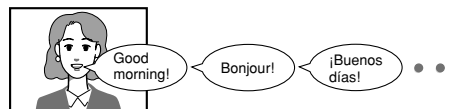

1

During playback, press **AUDIO** .

e.g.



The current audio setting appears.
The language code appears instead of the language name. Refer to the list of languages and their abbreviations. (▶ page 58)

2

Press **AUDIO** while the audio setting is displayed on the TV screen.

Notes

- Some discs allow you to change audio selections only via the disc menu. If this is the case, press MENU button and choose the appropriate language from the selections on the disc menu.
- When you turn on the player or replace a disc, the player returns to the initial default setting (▶ page 55). Depending on a disc, a specific type of audio the disc has is output.

Selecting the sound of a disc recorded in DVD VR mode

DVD-RAM DVD-RW (DVD VR mode)

When playing a disc recorded in DVD VR mode, select the sound as follows.

1

During playback, press **AUDIO** .

- The current audio setting appears.
- The language code appears instead of the language name. Refer to the list of languages and their abbreviations. (▶ page 58)

2

Press **AUDIO** while the audio setting is displayed on the TV screen.

Depending on the disc or the type of broadcast, variation of sound differs.

● DVD-RAM DVD-RW DVD-R

Stereo sound contents

"Stereo" or "LR" (Left main channel and right sub channel) → "L" (Left main channel) → "R" (Right sub channel) → Back to "Stereo" or "LR".

SAP sound contents

"Main" → "Sub" → "Main and Sub" → Back to "Main".

Playing a disc (Continued)



Selecting subtitles

HD DVD DVD-Video

You can display subtitles on the TV and select a subtitle language from those included on the disc.



1 Press during playback.

- The current subtitle setting appears.

e.g.

Subtitle: ENG 1

- The language code appears instead of the language name. Refer to the list of languages and their abbreviations. (▶ page 58)

Each time you press ◀▶, "On" and "Off" alternate. Select "On" to view subtitles.

2 Press while the subtitle setting is displayed on the TV screen.

Subtitle languages which do not appear in the setting are not included in the disc.

Notes

- Some DVD video discs are set to display subtitles automatically.
- Depending on the scene, subtitles may not appear immediately after you set the subtitle function to on.
- Some DVD video discs will allow you to change subtitle languages and turn subtitles on or off only via the disc menu.
- When you turn on the player or replace a disc, the player returns to the initial default setting (▶ page 55). Depending on a disc, a specific type of subtitles the disc has is output.
- Depending on the scene, the subtitle language may not change immediately after selected.

Selecting the camera angle

HD DVD DVD-Video

If the scene was recorded with multiple angles, you can easily change the camera angle of the scene you are watching.

1 Press while playing a scene recorded with multiple angles.

- While playing a scene recorded with multiple angles, the angle icon appears on the TV screen and on the front panel. Press ANGLE button while the angle icon is displayed.

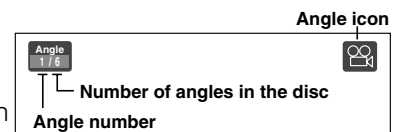

2 While the angle number is displayed, press repeatedly to select the angle number.

Notes

- You can also change the camera angle during still playback. The camera angle changes to the new setting when you resume normal playback.
- If you pause a picture immediately after changing a camera angle, the resumed playback picture may not display the new camera angle.

Playing at various speeds

HD DVD	DVD-Video	CD
DVD-RAM	DVD-RW	DVD-R
CD-RW (CD-DA)	CD-R (CD-DA)	

Playing frame by frame

During playback, press  .

Picture pauses.

If you press  while a picture is paused, you can play the picture frame by frame.

- To resume normal playback, press  .
Some discs may not permit this operation.



Skipping chapters or tracks

Playback starts from the beginning of the current chapter or track. When you press twice, playback starts from the beginning of the previous chapter or track.

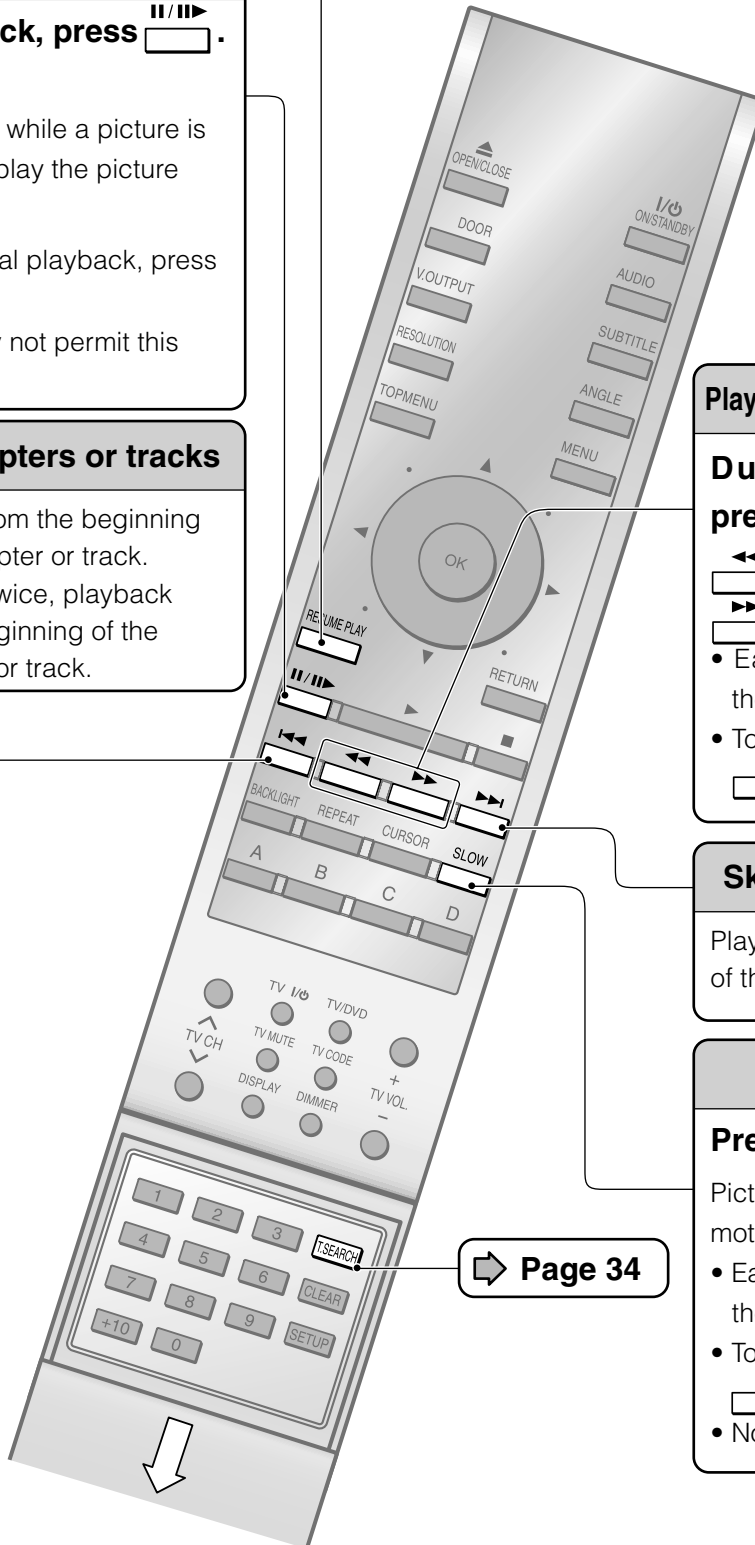
➔ Page 34



Playing in fast reverse or fast forward

During normal playback, press  /  .

 : Fast reverse playback

 : Fast forward playback

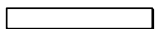
- Each time you press the button, the playback speed changes.
- To resume normal playback, press  .

Skipping chapters or tracks

Playback starts from the beginning of the next chapter or track.

Playing in slow-motion

Press  during playback.

Picture is played forward in slow-motion.

- Each time you press the button, the slow-motion speed changes.
- To resume normal playback, press  .
- Not available in CD playback.

➔ Page 34

Playing at various speeds (Continued)

Locating by entering a section number

HD DVD	DVD-Video	CD	DVD-RAM	DVD-RW
DVD-R	CD-RW (CD-DA)	CD-R (CD-DA)		

Normally titles, chapters, and tracks are numbered. By entering these numbers, you can access a desired section.

1 Press **T.SEARCH** repeatedly to select the area you want to input.

e.g. When you want to locate a chapter.

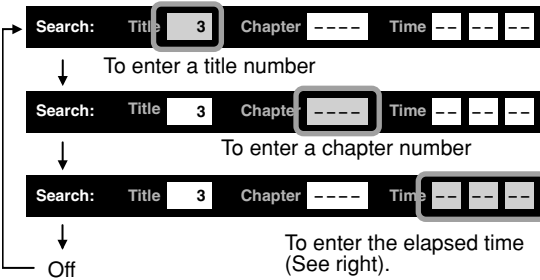

- The actual display may vary depending on the disc. The cursor shifts also by ◀/▶.

2 Press the number buttons to enter a number of the section.

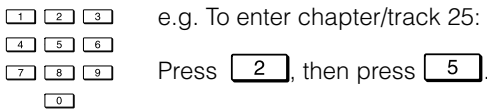

- Pressing CLEAR button resets the numbers. To turn off the display, press T.SEARCH several times (depending on the disc).

3 Press **OK**.

Playback starts from the selected section.

Note

- Some discs may not permit these operations.

Resuming playback from the location last stopped (Title resume)

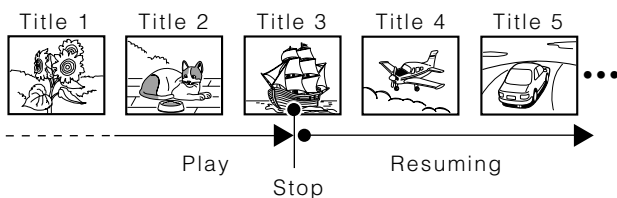

You can resume playback from the location last stopped.

If you press **RESUME PLAY** after stopping playback, playback starts from the location last stopped.

If you press **■** after stopping playback, the resume feature is canceled.

Locating by entering elapsed time

HD DVD	DVD-Video	CD	DVD-RAM	DVD-RW
DVD-R	CD-RW (CD-DA)	CD-R (CD-DA)		

1 Press **T.SEARCH**.

You may have to press repeatedly, depending on a disc. Press the button until the cursor moves to "----" area.

e.g.



2 Press the number buttons to enter the desired time location on the disc.

e.g. To enter 1 hour, 25 minutes, and 30 seconds

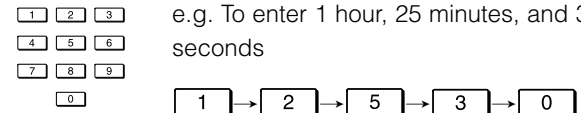

- Pressing CLEAR button resets the numbers.

3 Press **OK**.

Playback starts from the specified location.

Notes

- Resume feature cannot function when:
 - you select a disc menu language (➡ page 54) or change the parental lock setting (➡ page 56).
 - you open the disc tray.
- There may be a difference in the location where playback resumes depending on the disc.
- It is possible to change the setting from the setup menu while the player retains a location in memory, however, the new setting can be valid only after the player clears the location memory, i.e., starts resume playback.
- Some discs or scenes may not permit this operation.

4 Playback (Advanced)

Playback variations and other functions.

Playing repeatedly (Repeat playback)

Playing MP3/WMA files on a CD

Using EXTENSION ports

Using the cursor function

Checking the current status and settings

Playing repeatedly (Repeat playback)

	DVD-Video	CD
DVD-RAM	DVD-RW	DVD-R
CD-RW (CD-DA)	CD-R (CD-DA)	

You can repeat a desired section.

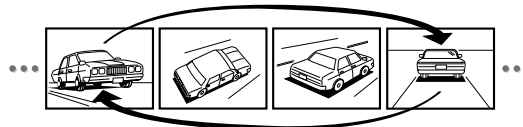

1

Press .

The repeat modes are listed.

2

Press / to select the repeat mode.

(The selections on the list vary depending on category or status of a disc.)

e.g.

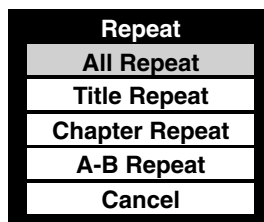

All Repeat:

Repeats the entire disc.
(Not available in playback of a disc recorded in DVD VR mode.)

Title Repeat:

Repeats the same title.

Chapter Repeat:

Repeats the same chapter.

Track Repeat:

Repeats the same track.

Disc Repeat:

Repeats the entire disc.

A-B Repeat:

Repeats the specified segment.
Select and press OK.

Perform step 1) and 2) below and skip step 3.



1) While the above display appears, press OK at a start point of a segment where you want to repeat.

The display changes to "B Point".



2) Press OK at an end point of a segment where you want to repeat.

Playback returns to the point A and repeats between A and B.

3

Press .

Repeat playback starts.

Notes

- Some discs may not permit repeat playback operation.
- You can cancel repeat playback also by pressing .

Playing MP3/WMA files on a CD

CD-RW (CD-DA) CD-R (CD-DA)

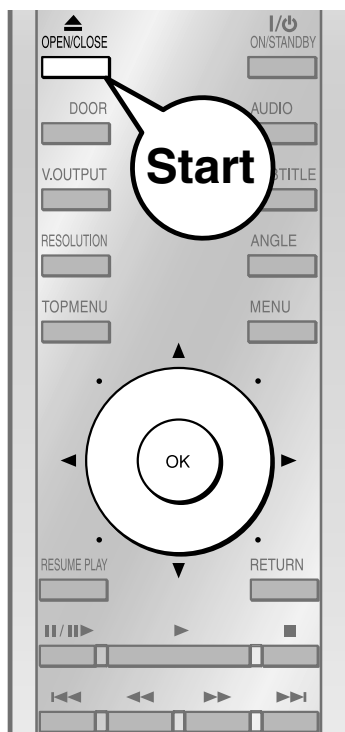

You can play MP3/WMA files that have been recorded on a CD-RW or CD-R on this player.

1

Load a CD that contains MP3/WMA files, and close the disc tray.

A menu appears.

2

Press ▲/▼ to select a file.

To go to the upper folder, select “Next Level Up” by pressing ▲ then press OK.

3

Press  .

Playback starts.

Notes

- Some disc cannot be played.
- WMA tracks that are copy-protected cannot be played.
- The DIGITAL AUDIO OUT BITSTREAM/PCM jack outputs MP3/WMA sounds in the linear PCM format regardless of the current “Digital Out” ( page 53) selection.
- Each file name is displayed up to 8 characters.

Playable files

Playable discs:	CD-RW, CD-R
Sampling frequency:	44.1 kHz
Bitrate:	WMA: 48 kbps - 192 kbps MP3: 32 kbps - 320 kbps
Format:	MODE 1
File system:	ISO9660 Level 1
File name (MP3):	A file name should be in alphabet and numerals only, and must incorporate “MP3” extension. (e.g. “*****.mp3”) Less than 50 bytes
File name (WMA):	A file name should be in alphabet and numerals only, and must incorporate “WMA” extension. (e.g. “*****.wma”) Less than 50 bytes
Total number of files:	Less than 650
WMA codec version:	V7, V8, V9 (Stereo sound only)

This player requires discs/recordings to meet certain technical standards in order to achieve optimal playback quality. There are many different types of recordable disc formats (including CD-R containing MP3/WMA files). Not all recordable discs will produce optimal playback quality. The technical criteria set forth in this owner’s manual are meant only as a guide. Use of CD-RW for MP3 files is not recommended.

You must obtain any required permission from copyright owners to download or use copyrighted content. Toshiba cannot and does not grant such permission.

Microsoft, Windows Media, and the Windows Logo are trademarks or registered trademarks of Microsoft Corporation in both the United States and other countries.



Using EXTENSION ports

HD DVD

Depending on the features of the disc you are using, you may be able to connect USB game controllers to the Extension ports to use some interactive features. Additional features may be supported in the future.

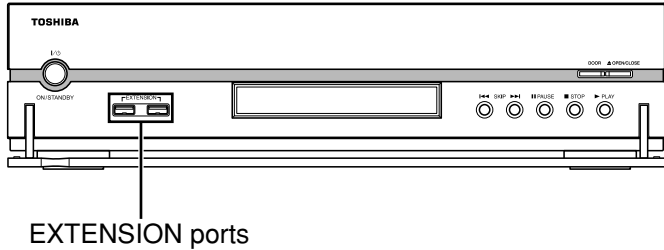

Using the cursor function

HD DVD

Available commercial HD DVD discs include game software and drawing software. You can use the cursor function for some software.

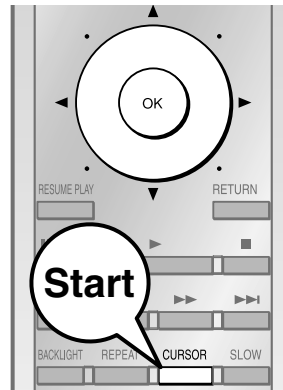

1

Press **CURSOR** while a disc with support for cursor use is playing.

2

Use the eight direction buttons to move the cursor.

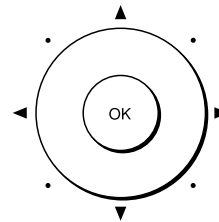

Example: Game/drawing software

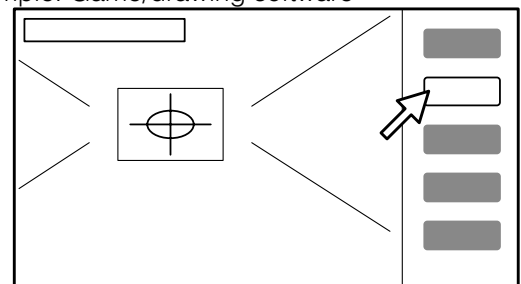

Move the cursor to select the game target or selection item. For details on actual operations, also refer to the operations guide for the disc.

Checking the current status and settings

HD DVD	DVD-Video	CD
DVD-RAM	DVD-RW	DVD-R
CD-RW (CD-DA)	CD-R (CD-DA)	

You can confirm operational status and setting details.



1 Press  .

The following on-screen display appears.
(The actual display varies depending on the disc.)

HD DVD	DVD-Video	DVD-RAM	DVD-RW	DVD-R
--------	-----------	---------	--------	-------

e.g.

*The subtitle setting shows a language code (➡ page 58).

CD	CD-RW (CD-DA)	CD-R (CD-DA)
----	------------------	-----------------

e.g.

5 Internet connection

Connect to a network with an always-on broadband connection and use special content.

Internet connection feature (Outline)

Internet connection feature (Preparation)

Internet connection feature (Operation)

Internet connection feature (Outline)

If you connect the player to the Internet via an always-on broadband connection, some HD DVD discs enable you to access special HD DVD sites, etc. For example, if an HD DVD site includes content such as movie trailers, you can watch the content on the player via the Internet. On such sites, downloading service of the control program (firmware) updates of the player is also available.

You do not need to connect to a PC to use this function.

You may also use the internet connection feature to update the player's firmware. See  page 57.

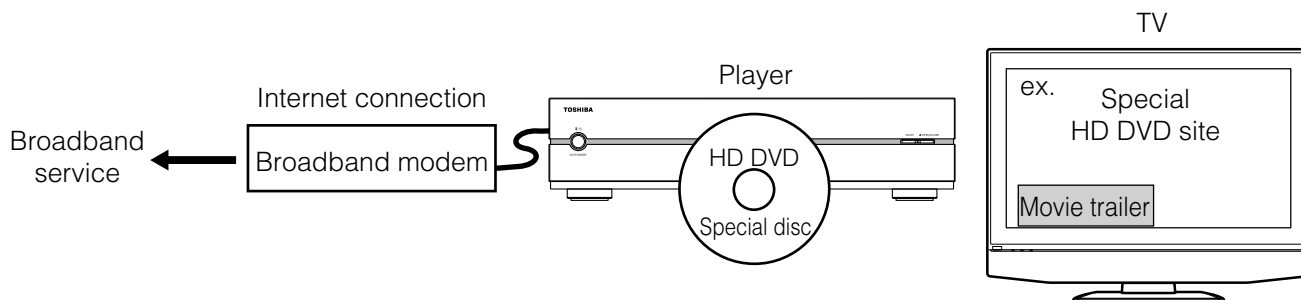

Before using

- Before using this feature, please read and understand the important information in “Notes”.
- This feature requires always-on broadband internet connection.
- An HD DVD disc compatible with this feature (commercially available) is required. Not all HD DVD discs are compatible.

Connection requirement

Always-on internet broadband internet connection.

Note

- The above requirement may change without advance notice. In addition, all operations are not guaranteed.

Notes

- Toshiba is not responsible for any malfunction of the player and/or the internet connection feature due to communication errors/malfunctions associated with your broadband internet connection, or other connected equipment.
- Toshiba is not responsible for any trouble in your internet connection.
- If you use a wireless ethernet network, you will need to use a wireless LAN ethernet adapter to connect the player to the network.
- The features of HD DVD discs made available through the Internet Connection feature are not created or provided by Toshiba, and Toshiba is not responsible for their functionality or continued availability. Some disc related material available by the Internet Connection may not be compatible with this player. If you have questions about such content, please contact the producer of the disc.
- Some internet contents may require a higher bandwidth connection.

- Even if the player is properly connected and configured, some internet contents may not operate properly because of internet congestion, the quality or bandwidth of your internet service, problems at the provider of the content or compatibility issues.
- The communication features of this player comply with the Institute of Electrical and Electronic Engineers (IEEE) 802.3.
- Some internet connection operations may not be possible due to certain restrictions set by the Internet service provider (ISP) supplying your broadband Internet connection.
- Any fees charged by an ISP including, without limitation, connection charges are your responsibility.
- A 10 Base-T or 100 Base-TX LAN port is required for connection to this player. If your internet service does not allow for such a connection, you will not be able to connect the player.
- ADSL modem is required to use DSL service and a cable modem is required to use cable modem service. Depending on the access method of and subscriber agreement with your ISP, you may not be able to use the internet connection feature contained in this player or you may be limited to the number of devices you can connect at the same time. (If your ISP limits subscription to one device, this player may not be allowed to connect when a PC is already connected.)
- The use of a "Router" may not be allowed or its usage may be limited depending on the policies and restrictions of your ISP. For details, contact your ISP directly.

Internet connection feature (Preparation)

HD DVD

Connect the player to the Internet via an always-on broadband connection. In addition to accessing special HD DVD sites, this function is used when updates are available for the control program (firmware) of the player.

Connection

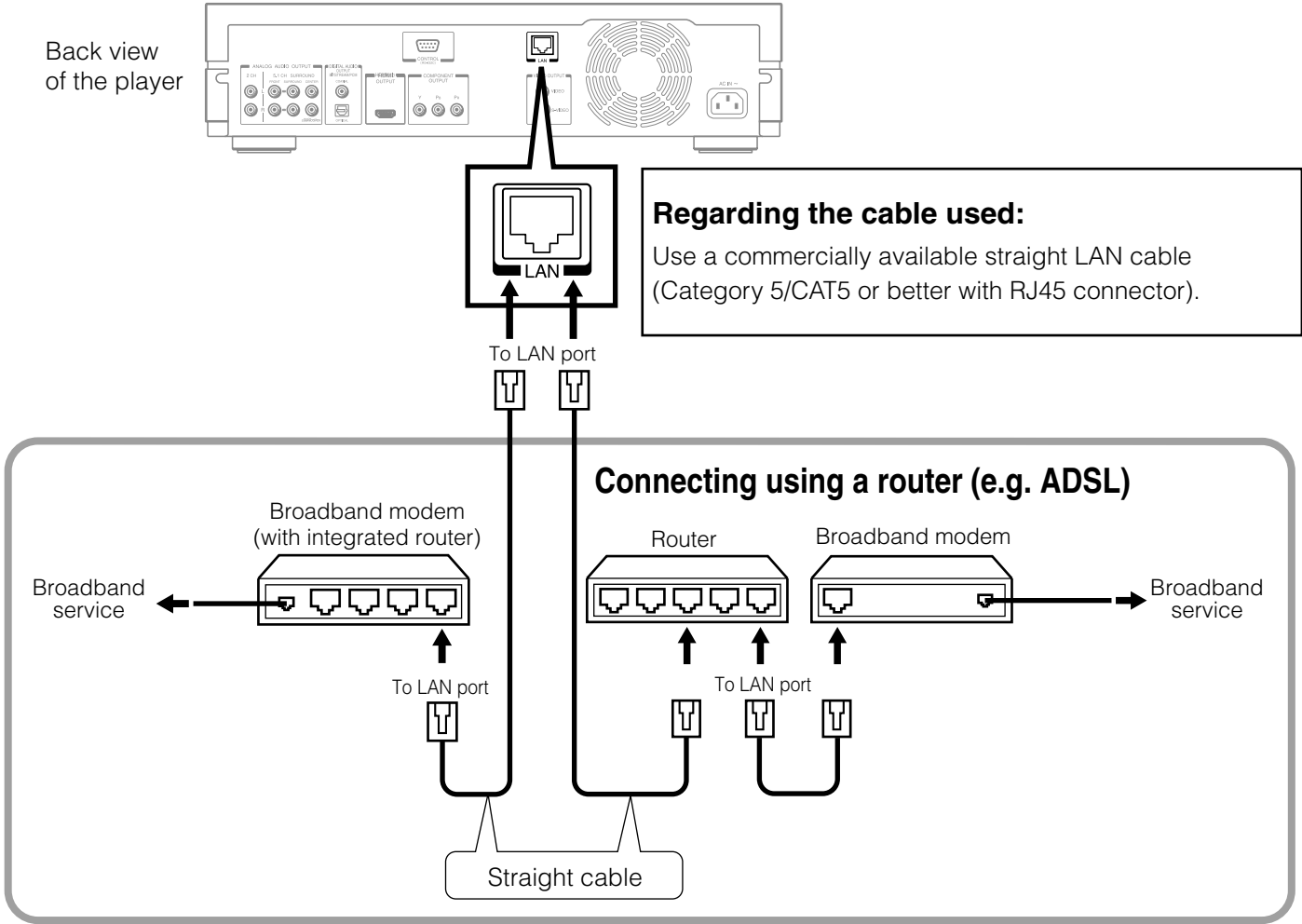

Caution

- When plugging or unplugging the LAN cable, hold the plug portion of the cable. When unplugging, do not pull on the LAN cable but unplug while pressing down on the lock.
- Do not connect the modular phone cable to the LAN port.
- Since there are various connection configurations, please follow the specifications of your telecommunication carrier or internet service provider.

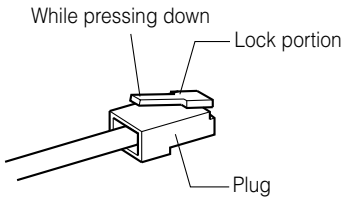

Note

- Depending on the internet service provider (ISP), the number of devices that can receive internet service may be limited by the applicable terms of service. For details, contact your ISP.

Internet connection setting procedure (Outline)

1st DHCP Setting

- Set "DHCP" to "On".
The network information is automatically set.
- Set "DNS" to "On".
The DNS server is obtained automatically from the DHCP server.

If a connection cannot be established even if "DHCP" is set to "On".

- Set "DHCP" to "Off".
Set "IP Address", "Subnet Mask", and "Gateway" manually.
- Set "DNS" to "Off".
Set the DNS server address manually.

2nd Proxy Setting

If the provider you are using requires a proxy setting to be configured, set the corresponding proxy server address.

3rd NTP Server Setting

The player automatically accesses an internet server to adjust its clock via the network time protocol.

1st DHCP Setting

- 1 Press SETUP button.
"SETUP MENU" appears.
- 2 Press ▲/▼ buttons to select "Ethernet", then press OK button.
- 3 On "Ethernet" menu, press ▲/▼ buttons to select "DHCP" then press OK button.
- 4 Set "DHCP" to "On", then press OK button.

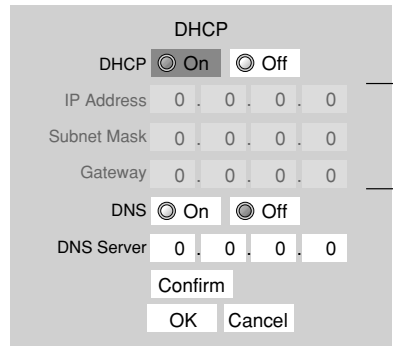

- 5 Set "DNS" to "On", then press OK button.

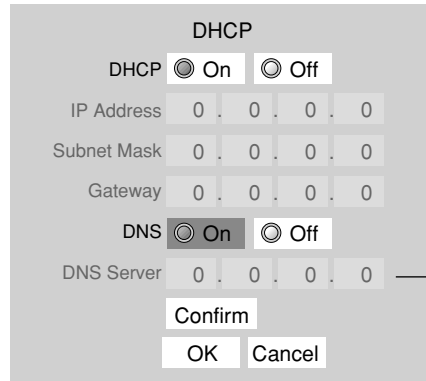

- 6 Select "Confirm", then press OK button.
Confirming starts.
If the setup is successful, an IP address appears.
Press OK button.

If the setup is not successful:

- a) Set "DHCP" to "Off" then press OK button.
- b) Input the addresses into "IP Address", "Subnet Mask" and "Gateway" using the number buttons.

IP Address	This sets a different address within the same subnet of the PC on your network. e.g.: If the IP address of the PC is 192.168.1.10, set 192.168.1.15 (or some other unused address).
Subnet Mask	This sets the subnet mask of the network environment that will be connected. e.g.: 225.255.255.0
Gateway	This sets the gateway used by the player (e.g.: 192.168.11).

- c) Set "DNS" to "Off" then press OK button.
- d) Input the address into "DNS Server".
This sets the DNS server to be used by the player.
e.g.: 192.168.1.1
- e) Press OK button.

Internet connection feature (Preparation) (Continued)

2nd Proxy Setting

Enter the proxy server address when your provider requires proxy setting.

- 1 On "Ethernet" menu, press ▲/▼ buttons to select "Proxy setting" then press OK button.
- 2 Set "Proxy" to "On" then press OK button.

Proxy Setting

Proxy On Off

Server

Port

User

Password

OK Cancel

- 3 Press ▲/▼/◀/▶ buttons to input.
 - Server: Enter the specified data from the provider.
 - Port: Enter the specified data from the provider.
 - User: Enter the specified data from the provider.
 - Password: Enter the specified data from the provider.
- 4 Select "OK" then press OK button.

3rd NTP Server Setting (Clock adjustment setting)

- 1 On "Ethernet" menu, press ▲/▼ buttons to select "NTP Server" then press OK button.
- 2 Select "On" or "Off" by pressing ▲/▼ buttons.

On	The player automatically accesses an internet server to adjust time protocol.
Off	The player does not access an internet server to adjust its clock.

- 3 Select "OK" then press OK button.

Notes

- Please contact the router manufacturer when the router DHCP feature is not operating properly (in such a case, an error will occur since the default gateway and the DNS server IP address cannot be obtained).
- The firmware in this player is updateable. See ➡ page 57 for information.

User information setting

Although not directly related to the Internet connection, some HD DVD discs may require the following settings to be configured.

- 1 On "Ethernet" menu, press ▲/▼ buttons to select "User Information" then press OK button.

User information

User

Password

OK Cancel

- 2 Select "User" then press OK button.
- 3 Input characters by pressing ▲/▼ buttons. To shift the position, press ◀/▶ buttons. Press OK button.
- 4 Select "Password" then press OK button. Input your password in the same manner as step 3. Press OK button.
- 5 Select "OK" then press OK button.
 - Use a password that others cannot easily guess.

Mac Address

Displays the MAC address of the player. It cannot be changed.

- 1 On "Ethernet" menu, press ▲/▼ buttons to select "MAC Address" then press OK button. The MAC address appears.

Internet connection feature (Operation)

HD DVD

Some HD DVD discs enable you to access special HD DVD sites. If an HD DVD site includes content such as movie trailers, you can watch the content on the player via the Internet if your internet connection provides sufficient bandwidth.

Preparation

Connect and configure the player to access the Internet beforehand (➡ pages 44 to 46).

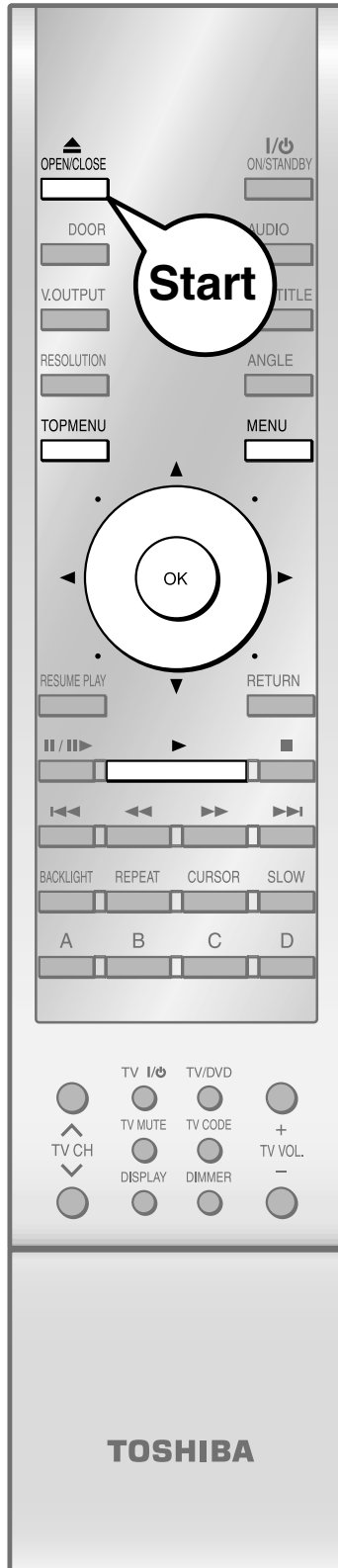

1

Insert the HD DVD disc and close the tray.

The disc begins to play.

If the disc does not begin to play, press .

2

Select an item from the menu.

- If the menu does not appear, press or .
- To select an item, use the direction buttons to select the item and press .
- Use the cursor function for some discs (➡ page 38).

For example, you can watch the latest trailers on the player via the Internet.

For details on actual operations, also refer to the operations guide for the disc.

6 Others

This chapter includes details on setting items and information on troubleshooting problems.

Customizing the function settings

Language code list

Output sound conversion table

Before calling service personnel

Specification

Limited United States Warranty

CANADIAN WARRANTY INFORMATION

INFORMATION ON CUSTOMER SUPPORT

Customizing the function settings

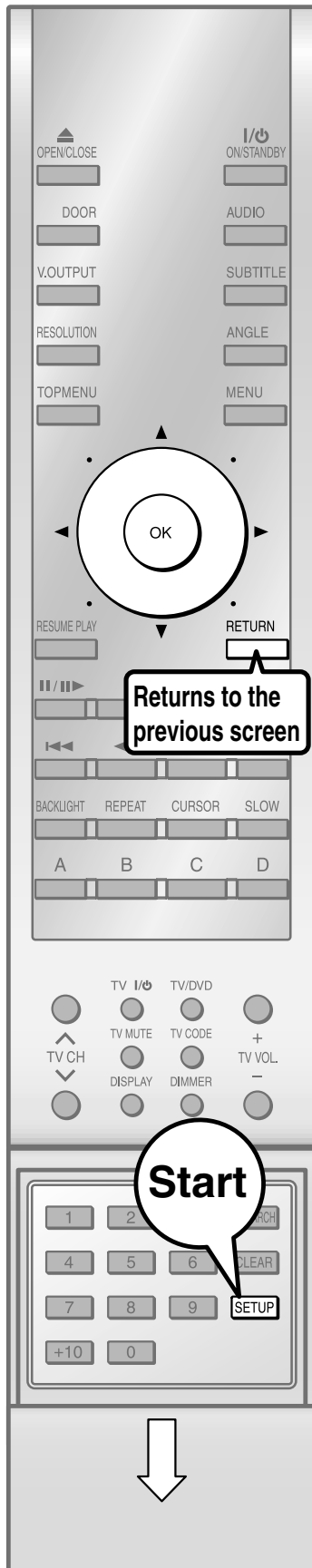

You can change the default settings to customize performance to your preference.

1 During stop, press **SETUP**.

“SETUP MENU” appears.

2 Press **▲/▼** to select the group that contains a desired item, then press **OK**.

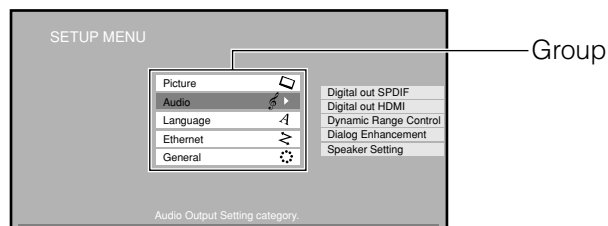

3 Press **▲/▼** to select the setting item, then press **OK**.

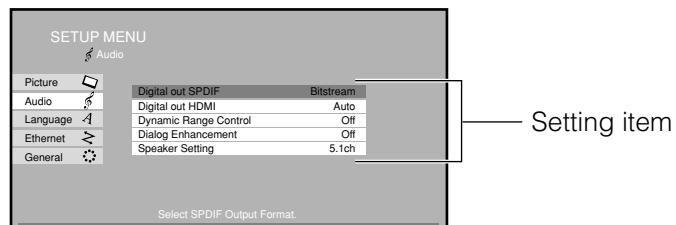

4 Refer to the explanations on pages beginning from 52, to change the selection by **▲/▼** or other buttons, then press **OK**.

5 Repeat step 3 and 4 to set other items if necessary.

6 Press **SETUP**.

“SETUP MENU” disappears and the setting is completed.

Group	Setting	Disc	Details	Page
Picture	TV Shape	HD DVD DVD Video CD DVD-RAM DVD-RW DVD-R	To select a picture size according to the aspect ratio of your TV.	52
	Enhanced Black Level	HD DVD DVD Video DVD-RAM DVD-RW DVD-R	To select the black level of playback pictures.	52
	Picture Mode	HD DVD DVD Video DVD-RAM DVD-RW DVD-R	To select the system of output signal corresponding to playback source. (Only when connected to a PROGRESSIVE TV.)	52
Audio	Digital out SPDIF	HD DVD DVD Video CD DVD-RAM DVD-RW DVD-R CD-RW (CD-DA) CD-R (CD-DA)	To select the output sound format when connecting the DIGITAL AUDIO OUTPUT jack.	53
	Digital out HDMI	HD DVD DVD Video CD DVD-RAM DVD-RW DVD-R CD-RW (CD-DA) CD-R (CD-DA)	To select the output sound format when connecting the HDMI OUTPUT jack.	53
	Dynamic Range Control	HD DVD DVD Video DVD-RAM DVD-RW DVD-R	To turn on or off a function that makes faint sounds easier to hear even if you lower the volume during late-hour playback.	53
	Dialog Enhancement	HD DVD DVD Video CD DVD-RAM DVD-RW DVD-R CD-RW (CD-DA) CD-R (CD-DA)	To turn on or off a function that increases dialog volume of a DVD video disc playback.	53
	Speaker Setting	HD DVD DVD Video CD DVD-RAM DVD-RW DVD-R CD-RW (CD-DA) CD-R (CD-DA)	To select various parameters for the analog 5.1ch output.	54
Language	Disc Menu Language	HD DVD DVD Video	To select a preferred language for disc menus.	54
	Subtitle Language	HD DVD DVD Video	To select a preferred language for subtitles.	54
	Audio Language	HD DVD DVD Video	To select a preferred language for the sound track.	55
	On Screen Language	HD DVD DVD Video CD DVD-RAM DVD-RW DVD-R CD-RW (CD-DA) CD-R (CD-DA)	To select a preferred language for on-screen displays.	55
Ethernet	DHCP	HD DVD	To select the method to acquire network information.	46
	Proxy Setting	HD DVD	To enter the proxy server address when your provider requires proxy setting.	46
	Mac Address	HD DVD	To display the MAC address of the player.	46
	User Information	HD DVD	To set a user name and a password to prevent improper access.	46
	NTP Server	HD DVD	To turn on or off a function that the player automatically accesses to the server to adjust its clock.	46
General	Parental Lock	HD DVD DVD Video	To turn the parental lock function on or off.	56
	Clock Set	HD DVD DVD Video CD DVD-RAM DVD-RW DVD-R CD-RW (CD-DA) CD-R (CD-DA)	To set the clock of the player.	57
	OSD On/Off	HD DVD DVD Video CD DVD-RAM DVD-RW DVD-R CD-RW (CD-DA) CD-R (CD-DA)	To activate or deactivate the operational status display on the TV screen.	57
	Remote Controller Sound	HD DVD DVD Video CD DVD-RAM DVD-RW DVD-R CD-RW (CD-DA) CD-R (CD-DA)	To turn on or off the confirmation beeper announcing when each remote command is received.	57
	Screen Saver	HD DVD DVD Video CD DVD-RAM DVD-RW DVD-R CD-RW (CD-DA) CD-R (CD-DA)	To turn on or off the screen saver (screen protection to prevent image burn).	57
	Skin	HD DVD DVD Video CD DVD-RAM DVD-RW DVD-R CD-RW (CD-DA) CD-R (CD-DA)	To select the pattern of the on screen controls.	57
	Maintenance	HD DVD DVD Video CD DVD-RAM DVD-RW DVD-R CD-RW (CD-DA) CD-R (CD-DA)	To select the player conditioning options, such as initializing of settings or firmware download.	57

Customizing the function settings (Continued)**Picture****TV Shape****16:9**

Select when a 16:9 wide TV is connected.

4:3

Select when a standard 4:3 TV is connected.

Displays pictures cropped to fill your TV screen. Either or both of the picture's sides are cut off.

4:3Letter Box

Select when a standard 4:3 TV is connected.

Displays theatrical images with masking bars above and below the picture.

Notes

- When an HD DVD disc or a DVD video disc has a particular available picture shape, the contents may not be compatible with other picture shapes.
- DVD video discs containing 4:3 picture only always display 4:3 pictures regardless of this setting.
- If "16:9" is selected while connecting a 4:3 TV, playback pictures may be distorted horizontally or shrink vertically. Make this setting according to your TV shape.
- Actual picture shape may depend on signal types of broadcasts or input sources, or settings on the connected TV. Refer to the owner's manual of your TV.

Enhanced Black Level

You can adjust the black level of the output signal.

On

To display deeper, richer black than in "Off" setting. (0 IRE)

Off

Normal black level. (7.5 IRE)

Picture Mode

There are two types of source content in pictures recorded in DVD video discs: film content (pictures recorded from films at 24 frames per second) and video content (video signals recorded at 30 frames per second). Make this selection according to the type of content being viewed.

Film

The player converts film content pictures in the progressive output format appropriately. Suitable for playback of film content pictures.

Video

The player filters video signal, and converts it in the progressive output format appropriately. Suitable for playback of video content pictures.

Auto

Select this position normally. The player automatically detects source content, film or video, of playback source, and converts that signal in the progressive output format in an appropriate method.

Note

- Depending on a disc, "Auto" setting may not be able to detect source content. If pictures may be doubled, roughened, or may show other abnormality, "Film" or "Video" selection is recommended for possible improvement.

Audio

Digital out SPDIF

Selects the output sound format when an audio device such as an amplifier to the DIGITAL AUDIO OUTPUT BITSTREAM/PCM jack on this player.

For details about output sound selection, see ➡ page 59.

Bitstream

Select this when an amplifier equipped with built-in Dolby Digital, DTS or MPEG decoder is connected to this player. When you play a disc recorded in Dolby Digital or DTS format, digital audio signal (bitstream audio) is output.

PCM

Select this when a 2 channel digital stereo amplifier is connected to this player.

When you play an HD DVD or DVD video disc recorded in Dolby Digital, Dolby Digital Plus, Dolby TrueHD, DTS or DTS-HD format, sound is converted into PCM (2 channel) format to output.

Digital out HDMI

Select the output sound format when a device equipped with an HDMI terminal is connected to the HDMI OUTPUT jack on this player.

For details about output sound selection, see ➡ page 59.

Auto

Select this when an HDMI device equipped with built-in Dolby Digital, DTS, MPEG or linear PCM decoder is connected to this player.

When you play a disc recorded in Dolby Digital or DTS format, digital audio signal (bitstream audio) is output.

If a connected HDMI device does not support Dolby Digital, DTS or MPEG, sound is converted into linear PCM to output.

Bitstream

Select this when an HDMI device equipped with built-in Dolby Digital, DTS or MPEG decoder is connected to this player.

When you play a disc recorded in Dolby Digital, DTS or MPEG format, digital audio signal (bitstream audio) is output.

PCM

Select this when an HDMI device which has multi channel output is connected to this player.

When you play an HD DVD or DVD video disc recorded in multi channel in Dolby Digital, Dolby Digital Plus, Dolby TrueHD, DTS or DTS-HD format, the sound is decoded and output in multi channel in linear PCM format.

Downmixed PCM

Select this when a 2 channel digital stereo amplifier is connected to this player.

When you play a DVD video disc recorded in Dolby Digital, DTS, MPEG1 or MPEG2 format, sound is converted into PCM (2 channel) format to output.

Dynamic Range Control

To turn on or off a function that makes faint sounds easier to hear even if you lower the volume during late-hour playback.

On

This function is activated.

Off

This function is disabled.

Notes

- This function is effective only in playback of Dolby Digital recorded HD DVD or DVD video discs.
- The effect level of this function vary depending on the disc.

Dialog Enhancement

To turn on or off a function that increases dialog volume of a DVD video disc playback.

On

This function is activated.

Off

This function is disabled.

Notes

- This function is effective only in playback of Dolby Digital recorded HD DVD or DVD video discs.
- This function is effective only when "Speaker Setting" is set to "2ch".
- The effect level of this function vary depending on the disc.

Customizing the function settings (Continued)

Audio

Speaker Setting

To select various parameters for the analog 5.1 channel output.

5.1ch

When a 5.1 channel surround system is connected to this player.

Go to the next step (see below) for detailed selections.

2ch

When a 2 channel stereo system is connected to this player.

When you selected "5.1ch":

Set the speaker sizes, distance to each speaker and the crossover frequency.

- 1 Select a speaker by pressing ▲/▼/◀/▶ buttons, and press OK button.
- 2 Select the size by pressing ▲/▼ buttons, and press OK button.

Front Left / Front Right

Small: Select if the speaker cannot output low frequency.

Large: Select if the speaker can output low frequency.

Center / L Surround / R Surround

Small: Select if the speaker cannot output low frequency.

Large: Select if the speaker can output low frequency.

None: When the speaker is not connected.

Subwoofer

Use: When a subwoofer is connected.

Don't Use: When a subwoofer is not connected.

Crossover Setting

Low frequency under which you set here will be of a subwoofer. Select one from 80 Hz/100 Hz/120 Hz.

Ft

Select a distance to each speaker from the listening position.

- 3 Select "Next" by pressing ▲/▼/◀/▶ buttons, and press OK button.

The next screen appears.

- 4 Select "Automatic Test Tone" by pressing ▲/▼/◀/▶ buttons, and press OK button.

A test signal is sent to each speaker. Adjust each of the volumes by pressing ▲/▼, selecting speakers by ◀/▶, so that each speaker can sound at the same volume.

For further adjustment, check the channel balance on the amplifier.

- 5 When complete, select "OK" and press OK button.

Language

Disc Menu Language

To select a preferred language for disc menus.

English

To display disc menus in English.

French

To display disc menus in French.

Japanese

To display disc menus in Japanese.

Others

To make a further language choice.

After pressing OK button, follow steps 1) – 4) below.

- 1) Obtain the language code of the preferred language from the Language code list (➡ page 58).
- 2) Select the first character by pressing ▲/▼ buttons.
- 3) Press ◀/▶ buttons to shift. Select the second character by pressing ▲/▼ buttons.
- 4) Select "OK" and press OK button.

Note

- Some discs may be played in a different language from that you selected. A prior language may be programmed by the disc.

Subtitle Language

To select a preferred language for subtitles.

None

To disable subtitles.

English

To display subtitles in English.

French

To display subtitles in French.

Japanese

To display subtitles in Japanese.

Others

To make a further language choice.

After pressing OK button, follow steps 1) – 4) below.

- 1) Obtain the language code of the preferred language from the Language code list (➡ page 58).
- 2) Select the first character by pressing ▲/▼ buttons.
- 3) Press ◀/▶ buttons to shift. Select the second character by pressing ▲/▼ buttons.
- 4) Select "OK" and press OK button.

Ethernet

See the “Internet connection” chapter (➡ page 42).

Notes

- Some discs may be set to display subtitles in a different language from that you selected. A prior subtitle language may be programmed by the disc.
- Some discs allow you to change subtitle selections only via the disc menu. In this case, press MENU button and choose the appropriate subtitle language from the selection on the disc menu.

Audio Language

To select a preferred language for the sound track.

English

To display sound tracks recorded in English.

French

To display sound tracks recorded in French.

Japanese

To display sound tracks recorded in Japanese.

Others

To make a further language choice.

After pressing OK button, follow steps 1) – 4) below.

- 1) Obtain the language code of the preferred language from the Language code list (➡ page 58).
- 2) Select the first character by pressing ▲/▼ buttons.
- 3) Press ◀/▶ buttons to shift. Select the second character by pressing ▲/▼ buttons.
- 4) Select “OK” and press OK button.

Note

- Some discs may be played in a different language from that you selected. A prior language may be programmed by the disc.

On Screen Language

To select a preferred language for on-screen displays.

English

To view on-screen display in English.

French

To view on-screen display in French.

Japanese

To view on-screen display in Japanese.

Customizing the function settings (Continued)

General

Parental Lock

HD DVD and DVD video discs equipped with the Parental Lock function have a predetermined limitation level. The limitation level or limitation method may differ depending on the disc. For example the whole contents of a disc may not be played back, or an extreme violent scene may be cut or replaced automatically by another scene.

Important

Depending on discs, it may not be evident whether the disc is compatible with Parental Lock function. Make sure that Parental Lock function you set is activated correctly.

- 1 Enter a 4-digit password by using the number buttons, then press OK button.**

When you use the player for the first time, set a new password of 4-digit. If you make a mistake entering your password, press CLEAR button before pressing OK button, and re-enter the correct password.

- 2 Set the details.**

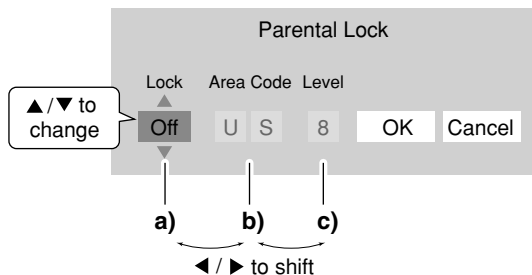

- a) Select "On" or "Off" by pressing ▲/▼ buttons.**

On

Select this to activate Parental Lock function or to change the setting.

Off

Deactivate the Parental Lock function.
Skip step 3.

- b) Press ▲/▼ buttons to enter the code of a country/area whose standards were used to rate a disc, referring to the list below.**

Country/Area	Code
AUSTRALIA	AU
BELGIUM	BE
CANADA	CA
CHINA	CN
CHINA HONG KONG	HK
DENMARK	DK
FINLAND	FI

FRANCE	FR
GERMANY	DE
INDONESIA	ID
ITALY	IT
JAPAN	JP
MALAYSIA	MY
NETHERLANDS	NL
NORWAY	NO
PHILIPPINES	PH
RUSSIAN FEDERATION	RU
SINGAPORE	SG
SPAIN	ES
SWEDEN	SE
SWITZERLAND	CH
TAIWAN	TW
THAILAND	TH
UNITED KINGDOM	GB
UNITED STATES	US

- c) Select the desired limitation level by pressing ◀/▶ buttons.**

Unless the Parental Lock function is set to "Off", a disc that has a higher limitation level than your selected limitation level cannot be played back. For example, if you select level 7, discs exceeding level 8 are locked and cannot be played back.

When "US" is selected, its limitation level corresponds to the following settings.

Level 7 : NC-17	Level 3 : PG
Level 6 : R	Level 1 : G
Level 4 : PG13	

- 4 Select "OK" then press OK button.**

■ To change the limitation level of Parental Lock function

Follow step 1 - 3 above.

■ To change the password

- 1 At step 1, press STOP button 4 times then press OK button.**

The password is cleared.

- 2 Enter a new 4-digit password by using the number buttons.**

- 3 Press OK button.**

Clock Set

To set the clock of the player.

- 1 Press ▲/▼/◀/▶ buttons to select the input area.

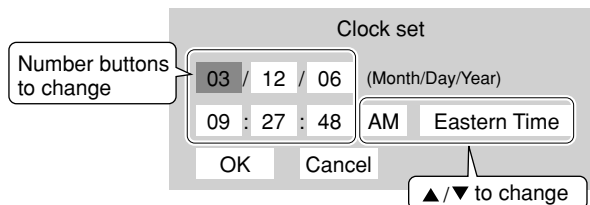

- 2 Press the number buttons to change the digit to set the date and time.
- 3 Press ▲/▼ buttons to select “AM” or “PM” and your time zone.
- 4 Select “OK” and press OK button.

The clock starts.

OSD On/Off

To activate or deactivate the operational status display on the TV screen.

On

Activates the operational status display (e.g., ►) on the TV screen.

Off

Deactivates the operational status display (e.g., ►) on the TV screen.

Remote Controller Sound

To turn on or off the confirmation beeper announcing when each remote command is received.

On

Turns on the beep sound.

Off

Turns off the beep sound.

Screen Saver

To turn on or off the screen protection function to prevent image burn caused by prolonged still picture.

Auto Power Off

Turns the player off if picture pausing continues for about 20 minutes.

On

Activates the screen saver if picture pausing continues for about 20 minutes.

Off

Deactivates the screen saver.

Note

- Toshiba does not guarantee that this function protects the TV screen by all means.

Skin

To select the pattern of the on screen controls.

1:2:3**Maintenance (including internet firmware update)****Initialize**

To reset all the settings listed on ► page 51 to factory set default.

Press ◀/▶ buttons to select “Yes” then press OK button.

Update (Firmware update)

You can use Ethernet communication to connect to the Internet and download the latest firmware from the Toshiba server.

Before you can use this function, the player needs to be connected to the Internet via an always-on broadband connection. For details on connecting, refer to the “Internet connection” chapter.

To update the firmware, select “Yes” and press OK. If there is no update available (in which case your player likely has the latest firmware), a message appears and the process is canceled after you select “Yes”. Please check the support section of the Toshiba website for information about firmware updates (including information on how to obtain updates on disc rather than using the Internet Connection feature of the player).

Caution

- Do not unplug, turn off or use any other feature of the player during the download. The writing of the software being downloaded will be halted and the player may no longer work properly. If the player stops working, contact Toshiba Customer Service.

Language code list

Abbreviation	Language	Abbreviation	Language	Abbreviation	Language
---	No alternate language	GN	Guarani	PT	Portuguese
CHI (ZH)	Chinese	GU	Gujarati	QU	Quechua
DUT (NL)	Dutch	HA	Hausa	RM	Rhaeto-Romance
ENG (EN)	English	HI	Hindi	RN	Kirundi
FRE (FR)	French	HR	Croatian	RO	Rumanian
GER (DE)	German	HU	Hungarian	RU	Russian
ITA (IT)	Italian	HY	Armenian	RW	Kinyarwanda
JPN (JA)	Japanese	IA	Interlingua	SA	Sanskrit
KOR (KO)	Korean	IE	Interlingue	SD	Sindhi
MAY (MS)	Malay	IK	Inupiak	SG	Sango
SPA (ES)	Spanish	IN	Indonesian	SH	Serbo-Croatian
AA	Afar	IS	Icelandic	SI	Singhalese
AB	Abkhazian	IW	Hebrew	SK	Slovak
AF	Afrikaans	JI	Yiddish	SL	Slovenian
AM	Amharic	JW	Javanese	SM	Samoan
AR	Arabic	KA	Georgian	SN	Shona
AS	Assamese	KK	Kazakh	SO	Somali
AY	Aymara	KL	Greenlandic	SQ	Albanian
AZ	Azerbaijani	KM	Cambodian	SR	Serbian
BA	Bashkir	KN	Kannada	SS	Siswati
BE	Belorussian	KS	Kashmiri	ST	Sesotho
BG	Bulgarian	KU	Kurdish	SU	Sundanese
BH	Bihari	KY	Kirghiz	SV	Swedish
BI	Bislama	LA	Latin	SW	Swahili
BN	Bengali, Bangla	LN	Lingala	TA	Tamil
BO	Tibetan	LO	Laotian	TE	Telugu
BR	Breton	LT	Lithuanian	TG	Tajik
CA	Catalan	LV	Latvian, Lettish	TH	Thai
CO	Corsican	MG	Malagasy	TI	Tigrinya
CS	Czech	MI	Maori	TK	Turkmen
CY	Welsh	MK	Macedonian	TL	Tagalog
DA	Danish	ML	Malayalam	TN	Setswana
DZ	Bhutani	MN	Mongolian	TO	Tongan
EL	Greek	MO	Moldavian	TR	Turkish
EO	Esperanto	MR	Marathi	TS	Tsonga
ET	Estonian	MT	Maltese	TT	Tatar
EU	Basque	MY	Burmese	TW	Twi
FA	Persian	NA	Nauru	UK	Ukrainian
FI	Finnish	NE	Nepali	UR	Urdu
FJ	Fiji	NO	Norwegian	UZ	Uzbek
FO	Faroese	OC	Occitan	VI	Vietnamese
FY	Frisian	OM	(Afan) Oromo	VO	Volapük
GA	Irish	OR	Oriya	WO	Wolof
GD	Scottish Gaelic	PA	Panjabi	XH	Xhosa
GL	Galician	PL	Polish	YO	Yoruba
		PS	Pashto, Pushto	ZU	Zulu

Output sound conversion table

Disc	Audio Format		Analog out 5.1ch/2ch	Digital out SPDIF		
				Bitstream	PCM	
HD DVD Video Standard contents	DD plus		5.1ch/2ch	Bitstream	2ch PCM	
	True HD	48kHz	2ch/2ch	2ch PCM	2ch PCM	
		96kHz	2ch/2ch	2ch PCM*1	2ch PCM*1	
		192kHz	2ch/2ch	2ch PCM*1	2ch PCM*1	
	dts-HD		5.1ch/2ch	Bitstream	2ch PCM	
L-PCM	48k	Yes	2ch PCM	2ch PCM		
	96k	Yes	2ch PCM*1	2ch PCM*1		
	192k	2ch/2ch	2ch PCM*1	2ch PCM*1		
Advanced con.			5.1ch/2ch	DTS Bitstream	2ch PCM	
DVD-Video	DD		5.1ch/2ch	Bitstream	2ch PCM	
	L-PCM	48k	2ch/2ch	2ch PCM	2ch PCM	
		96k	2ch/2ch	2ch PCM*1	2ch PCM*1	
	dts		5.1ch/2ch	Bitstream	2ch PCM	
MPEG		2ch/2ch	Bitstream	2ch PCM		
CD	L-PCM	44.1kHz	Yes	2ch PCM	2ch PCM	
	dts		44.1kHz	Yes	Bitstream	2ch PCM
	MP3		2ch/2ch	2ch PCM	2ch PCM	
	WMA		2ch/2ch	2ch PCM	2ch PCM	
DVD-VR	DD		Yes	Bitstream	2ch PCM	
	L-PCM		Yes	2ch PCM	2ch PCM	
	MPEG		Yes	Bitstream	2ch PCM	

Disc	Audio Format		Digital out HDMI			
			Auto	Bitstream	PCM	Downmixed PCM
HD DVD Video Standard contents	DD plus		Depend on HDMI receiver	Bitstream*2	upto 5.1ch PCM*3	2ch PCM
	True HD	48kHz	Depend on HDMI receiver	2ch PCM	2ch PCM	2ch PCM
		96kHz	Depend on HDMI receiver	2ch PCM	2ch PCM	2ch PCM*1
		192kHz	Depend on HDMI receiver	2ch PCM	2ch PCM	2ch PCM*1
	dts-HD		Depend on HDMI receiver	Bitstream*2	upto 5.1ch PCM*3	2ch PCM
	L-PCM	48k	Depend on HDMI receiver	2ch PCM	Multi PCM	2ch PCM
96k		Depend on HDMI receiver	2ch PCM*1	Multi PCM	2ch PCM*1	
192k		Depend on HDMI receiver	2ch PCM*1	2ch PCM	2ch PCM*1	
Advanced con.	MPEG		Depend on HDMI receiver	Bitstream	2ch PCM	2ch PCM
DVD-Video	DD		Depend on HDMI receiver	Bitstream	Multi PCM	2ch PCM
	L-PCM	48k	Depend on HDMI receiver	2ch PCM	2ch PCM	2ch PCM
		96k	Depend on HDMI receiver	2ch PCM*1	2ch PCM	2ch PCM*1
	dts		Depend on HDMI receiver	Bitstream	Multi PCM	2ch PCM
MPEG		Depend on HDMI receiver	Bitstream	2ch PCM	2ch PCM	
CD	L-PCM	44.1kHz	2ch PCM	2ch PCM	2ch PCM	2ch PCM
	dts		44.1kHz	Bitstream	Multi PCM	2ch PCM
	MP3		2ch PCM	2ch PCM	2ch PCM	2ch PCM
	WMA		2ch PCM	2ch PCM	2ch PCM	2ch PCM
DVD-VR	DD		Depend on HDMI receiver	Bitstream	Multi PCM	2ch PCM
	L-PCM		2ch PCM	2ch PCM	2ch PCM	2ch PCM
	MPEG		Depend on HDMI receiver	Bitstream	2ch PCM	2ch PCM

*1: Downsampling PCM.

*2: Bitstream audio output is possible only when the connected HDMI device has bitstream decoding function. If not, sound is output in PCM (48k) format.

*3: Multi channel PCM audio output is possible only when the connected HDMI device has multi channel decoding function.

Notes

- Some discs allow you to change audio selections only via the disc menu. If this is the case, press MENU button and choose the appropriate language from the selections on the disc menu.
- When you turn on the player or replace a disc, the player returns to the initial default setting. (▶ page 55)
Depending on a disc, a specific type of audio the disc has is output.
- Immediately after you have switched sounds, there may be a temporary discrepancy between the display and actual sound.
- The BITSTREAM/PCM jack may not output SAP sound you select. In this instance, set "Digital out SPDIF" to "PCM".

Before calling service personnel

If you experience any of the following difficulties while using this unit, check the list below before consulting your nearest Toshiba dealer.

Symptom	Remedy
■ No power.	→ Is the power plug disconnected? Check the power connection.
■ No picture.	→ Is the cable for connecting the player and TV disconnected or not connected properly? Check the connections (➡ page 20 – 23) → Switch the input of the connected TV to the signal from the player. → When the TV is connected via the component jacks or HDMI jacks, images from the player may temporarily not be able to be displayed because of the selected output and resolution. Use the V.OUTPUT and RESOLUTION buttons to change the output and resolution (➡ pages 21 and 22).
■ No sound.	→ Is the audio cable disconnected? (➡ page 20) → Is the volume of the device turned down to the minimum level? Check the volume. → Switch the audio input of the device connected by the audio cable to the input from the player. → Set “Digital out SPDIF” or “Digital out HDMI” (➡ page 53) properly in accordance with the connected device and connection procedure. → The volume level is set to the minimum. Adjust the volume. (➡ page 54) → Is the HDMI output selected? To listen to HDMI audio, press V.OUTPUT and select HDMI output.
■ Multi channel sound is not output.	→ Set “Speaker Setting” (➡ page 53) to “5.1ch.”
■ The disc does not play.	→ Make sure the disc type can be played with the player (➡ page 26). → Is the disc dirty or scratched? Check or clean the disc. (➡ page 27) → If the disc is a DVD-RW or DVD-R disc, finalize the disc before attempting to play it with the player. → If the disc includes parent lock support, playback is restricted while the parent lock of the player is set. Cancel Parental Lock (➡ page 56) or change the restriction level.
■ Playback picture has noise.	→ If video from the player is watched via a video recorder or on a TV with a built-in video recorder, the copy guard may prevent images from being displayed properly. Be sure to connect the player directly to the TV.
■ The remote control does not work.	→ Are the batteries of the remote control dead? Replace the batteries. (➡ page 16) → Make sure the remote control is within range and pointed in the correct direction.
■ Screen freezes and no buttons work.	→ Pressing the ON/STANDBY button on the player for approximately ten seconds forces the player to turn off. Turn the player off and then on again.

Specification

■ Power requirement

90.0W

■ Power supply

120V AC 60Hz

■ Mass

8.9kg

■ External dimension

Width 437 x Height 115 x Depth 354mm

■ Signal system

Standard NTSC Color TV system

■ Laser

Semiconductor laser, Wavelength: 405nm/650nm/
780nm

■ VIDEO output

1.0Vp-p (75Ω), Sync signal negative,
Pin jack x 1 system

■ S-VIDEO output

(Y) 1.0Vp-p (75Ω), Sync signal negative,
(C) 0.286Vp-p (75Ω), 1 at rear
Mini DIN4 Pin x 1 systems

■ Component output (Y, P_B P_R)

Y output (green), 1.0Vp-p (75Ω),
Sync signal negative, Pin jack x 1 system
P_B, P_R output (blue, red), 0.7Vp-p (75Ω),
Pin jack x 1 system each

■ Analog audio output

2.0V (rms), 2.2kΩ or below, pin jack
(L, R) x 2 systems
2.0V (rms), 2.2kΩ or below, pin jack
Pin jack x 6

■ Digital audio output (BITSTREAM/PCM jack)

Optical connector x 1 system
Coaxial pin jack x 1 system, 0.5Vp-p (75Ω)

■ LAN port

100BASE-TX/10BASE-T x 1

■ EXTENSION port

EXTENSION port x 2 systems

■ RS-232C connector

DSUB 9 pin

■ HDMI output

19 pin

■ Remote control

Wireless remote control (SE-R0200)

■ Operating conditions

Temperature: 41°F ~ 95°F (5°C ~ 35°C),
Position: Horizontal

■ Clock accuracy

Quartz (monthly deviation: approximately ±30
seconds)

- This model complies with the above specifications.
- Designs and specifications are subject to change without notice.
- This model may not be compatible with features and/or specifications that may be added in the future.
- The Illustrations and screens described in this manual may be exaggerated or simplified for easy recognition and may be slightly different from the actual unit.

Limited United States Warranty

Digital Audio Video ("DAV") Product-Depot Repair Warranty

Toshiba America Consumer Products, L.L.C., ("TACP") makes the following limited warranties to original consumers in the United States. THESE LIMITED WARRANTIES EXTEND TO THE ORIGINAL CONSUMER PURCHASER OR ANY PERSON RECEIVING THIS DAV PRODUCT AS A GIFT FROM THE ORIGINAL CONSUMER PURCHASER AND TO NO OTHER PURCHASER OR TRANSFEREE.

DAV PRODUCTS PURCHASED IN THE U.S.A. AND USED ANYWHERE OUTSIDE OF THE U.S.A., INCLUDING, WITHOUT LIMITATION, CANADA AND MEXICO, ARE NOT COVERED BY THESE WARRANTIES.

DAV PRODUCTS PURCHASED ANYWHERE OUTSIDE OF THE U.S.A., INCLUDING, WITHOUT LIMITATION, CANADA AND MEXICO, AND USED IN THE U.S.A., ARE NOT COVERED BY THESE WARRANTIES.

Limited Ninety (90) Day Warranty on Labor*

TACP warrants this DAV Product and its parts against defects in materials or workmanship for a period of ninety (90) days after the date of original retail purchase. DURING THIS PERIOD, TACP WILL, AT TACP'S OPTION, REPAIR OR REPLACE A DEFECTIVE PART WITH A NEW OR REFURBISHED PART WITHOUT CHARGE TO YOU FOR PARTS OR LABOR.

Limited One (1) Year Warranty on Parts*

TACP further warrants the parts in this DAV Product against defects in materials or workmanship for a period of one (1) year after the date of original retail purchase. DURING THIS PERIOD, TACP WILL, AT TACP'S OPTION, REPAIR OR REPLACE A DEFECTIVE PART WITH A NEW OR REFURBISHED PART WITHOUT CHARGE TO YOU FOR THE PART, PROVIDED THAT IF A DEFECTIVE PART IS REPAIRED OR REPLACED AFTER NINETY (90) DAYS FROM THE DATE OF ORIGINAL RETAIL PURCHASE, THE CONSUMER SHALL PAY ALL LABOR CHARGES INVOLVED IN THE REPAIR OR REPLACEMENT THEREOF.

*Rental Units

The warranty for DAV Product rental units begins on the date of the first rental or thirty (30) days after the date of shipment to the rental firm, whichever comes first.

*Commercial Units

DAV Products sold and used for commercial purposes have a limited warranty for all parts and labor, which warranty begins on the date of original retail purchase and ends on the date that is ninety (90) days thereafter.

Owner's Manual and Product Registration Card

Read this owner's manual thoroughly before operating this DAV Product.

Complete and mail the enclosed product registration card or register your DAV Product on-line at www.tacp.toshiba.com/service as soon as possible. By registering your DAV Product you will enable TACP to bring you new products specifically designed to meet your needs and help us to contact you in the unlikely event a safety notification is required under the Consumer Product Safety Act. Failure to complete and return the product registration card does not diminish your warranty rights.

Your Responsibility

THE ABOVE WARRANTIES ARE SUBJECT TO THE FOLLOWING CONDITIONS:

- (1) You must retain your bill of sale or provide other proof of purchase.
- (2) All warranty servicing of this DAV Product must be made by the Depot Warranty Repair Center specified by the TACP Consumer Solutions Center.
- (3) The warranties from TACP are effective only if the DAV Product is purchased and operated in the United States or Puerto Rico.
- (4) Labor service charges for set installation, setup, adjustment of customer controls and installation or repair of antenna systems are not covered by this warranty. Reception problems caused by inadequate antenna systems are your responsibility.
- (5) Warranties extend only to defects in materials or workmanship as limited above and do not extend to any DAV Product or parts that have been lost or discarded by you or to damage to DAV Product or parts caused by fires, misuse, accident, Acts of God, such as lightning or fluctuations in electric power, improper installation, improper maintenance or use in violation of instructions furnished by TACP; use or malfunction through simultaneous use of this DAV Product and connected equipment; or to units that have been modified or had the serial number removed, altered, defaced, or rendered illegible.

How to Obtain Warranty Services

If, after following all of the operating instructions in this manual and checking the section “Before calling service personnel”, you find that service is needed:

- (1) For instructions on how to obtain warranty service for your DAV Product, contact TACP’s Consumer Solution Center toll-free at 1-800-319-6684.
- (2) You must include a copy of original bill of sale or other proof of purchase along with the entire DAV Product to the Depot Warranty Repair Center specified by the TACP Consumer Solutions Center. You are responsible for all inbound transportation and insurance charges for the DAV Product to the Depot Warranty Repair Center specified by the TACP Consumer Solutions Center.

For additional information, visit TACP’s web site:
www.tacp.toshiba.com.

ALL WARRANTIES IMPLIED BY THE LAW OF ANY STATE OF THE U.S.A., INCLUDING THE IMPLIED WARRANTIES OF MERCHANTABILITY AND FITNESS FOR A PARTICULAR PURPOSE, ARE EXPRESSLY LIMITED TO THE DURATION OF THE LIMITED WARRANTIES SET FORTH ABOVE. WITH THE EXCEPTION OF ANY WARRANTIES IMPLIED BY THE LAW OF ANY STATE OF THE U.S.A. AS HEREBY LIMITED, THE FOREGOING WARRANTY IS EXCLUSIVE AND IN LIEU OF ALL OTHER WARRANTIES, GUARANTEES, AGREEMENTS, AND SIMILAR OBLIGATIONS OF TACP WITH RESPECT TO THE REPAIR OR REPLACEMENT OF ANY PARTS. IN NO EVENT SHALL TACP BE LIABLE FOR CONSEQUENTIAL OR INCIDENTAL DAMAGES (INCLUDING, BUT NOT LIMITED TO, LOST PROFITS, BUSINESS INTERRUPTION, OR MODIFICATION OR ERASURE OF RECORDED DATA CAUSED BY USE, MISUSE OR INABILITY TO USE THIS DAV PRODUCT).

No person, agent, distributor, dealer or company is authorized to change, modify or extend the terms of these warranties in any manner whatsoever. The time within which an action must be commenced to enforce any obligation of TACP arising under the warranty or under any statute, or law of the United States or of any state thereof, is hereby limited to ninety (90) days from the date you discovered or should have discovered, the defect. This limitation does not apply to implied warranties arising under state law.

THIS WARRANTY GIVES YOU SPECIFIC LEGAL RIGHTS AND YOU MAY ALSO HAVE OTHER RIGHTS WHICH MAY VARY FROM STATE TO STATE IN THE U.S.A. SOME STATES OF THE U.S.A. DO NOT ALLOW LIMITATIONS ON HOW LONG AN IMPLIED WARRANTY LASTS, WHEN AN ACTION MAY BE BROUGHT, OR THE EXCLUSION OR LIMITATION OF INCIDENTAL OR CONSEQUENTIAL DAMAGES, SO THE ABOVE PROVISIONS MAY NOT APPLY TO YOU UNDER SUCH CIRCUMSTANCES.

TOSHIBA

- IMPORTANT - CANADIAN WARRANTY INFORMATION GARANTIE CANADIENNE

STANDARD WARRANTY TYPE OF SET

DVD Player
DVD/VCR Combination
Home Theatre in a Box
DVD Recorder
Portable DVD

WARRANTY PERIOD 12 MONTHS

GARANTIE NORMALE TYPE D'APPAREIL

Lecteur DVD
DVD/magnétoscope combo
Cinéma maison dans une boîte
Enregistreur DVD
DVD Portatif

DURÉE DE LA GARANTIE: 12 MOIS

CANADIAN WARRANTY

Toshiba of Canada Limited (TCL) makes the following limited warranties to original consumers in Canada.

Please retain your "Bill of Sale" as proof of purchase.

To obtain a "Canadian Warranty" please register online at www.toshiba.ca.

GARANTIE CANADIENNE

1) Toshiba du Canada Limitée (TCL) offre au Canada les garanties limitées suivantes aux consommateurs originaux.

Veillez conserver votre « facture » comme preuve d'achat.

Pour obtenir une garantie canadienne, veuillez vous inscrire en ligne à www.toshiba.ca

Canadian Warranty Information

Should service be required on this unit during the one year warranty period, TCL's option will be to repair or exchange the defective unit. It will be necessary to follow this procedure:

Contact: Toshiba of Canada Limited at the Consumer Electronics Group, customer support line.

Phone: 1-800-268-3404

Email: ceg_customer_support@toshiba.ca

All in-warranty repairs must be made by an authorized TCL service centre.

For service exchange TCL will arrange to have the unit picked up by courier and a replacement unit will be returned via same courier. (Note: A major credit card number will be required as a charge of \$25.00 will apply if no fault is found with the unit.)

During the first 3 months of ownership, a new unit will be supplied as a replacement. During the remainder of the warranty period a service-renewed unit will be supplied. The original "Bill of Sale" must be provided as proof of purchase (it will be returned with the replacement unit.)

This 12-month warranty will be strictly adhered to.

Out of warranty units should be repaired by a TCL authorized service centre.

Note: It is the responsibility of the owner to ensure proper packaging. Should damage in shipping occur, due to poor packaging, a charge back for the repair will result. This warranty applies to the original purchaser only and is not transferable.

This warranty does not apply to sets that have been subjected to misuse, neglect, accident, physical damage or acts of nature.

Sets with the serial number removed, altered, replaced or defaced will not be covered by this warranty.

The warranties from TCL are effective only if the product is purchased in Canada from an authorized TCL dealer and operated in Canada.

Products utilized for rental or commercial purposes are not covered by this warranty.

This warranty is in lieu of all other warranties, guaranties or agreements, whether expressed or implied, and no person, agent distributor, dealer, service centre or company is authorized to change, modify or extend its terms in any manner whatsoever.

Information sur la garantie Canadienne

Si vous avez besoin de service sur cet appareil au cours de l'année de garantie, Toshiba du Canada Limitée aura l'option de réparer ou échanger l'appareil défectueux. Vous devrez suivre la procédure suivante:

Contact: Toshiba du Canada Limitée au Groupe Électronique aux consommateurs, service à la clientèle.

Tél: 1-800-268-3404

Courriel: ceg_customer_support@toshiba.ca

Toutes les réparations au cours de la garantie doivent être faites par un centre de service autorisé Toshiba.

Pour un échange TCL s'assurera qu'un service de courrier ramassera l'unité et qu'un appareil de remplacement soit expédié par le même service de courrier.

(Note: Un numéro de carte de crédit sera requis car une charge de 25,00\$ sera appliquée si toutefois l'appareil n'avait aucun problème de fonctionnement.)

Une nouvelle unité sera fournie comme remplacement durant les premiers 3 mois de propriété. Par contre durant la balance de la garantie une unité remise à neuf sera fournie.

La «facture originale doit être fournie comme preuve d'achat (elle vous sera retournée avec l'unité de remplacement.)

Cette garantie de 12 mois sera strictement adhérente.

Les unités hors de garantie devraient être réparées par un centre de service autorisé Toshiba.

Note: C'est la responsabilité du propriétaire de s'assurer que l'emballage est adéquat. Vous serez facturé pour toutes réparations causées par des dommages encourus à cause d'un emballage non adéquat.

Cette garantie est octroyée à l'acheteur initial et n'est pas transférable. Cette garantie ne s'applique pas aux appareils qui ont été sujets aux abus, négligences, accidents, dommages physiques ou actes naturels.

Les appareils dont le numéro de série a été enlevé, altéré, remplacé ou barbouillé ne sont pas couverts par cette garantie. Les garanties de TCL sont valides seulement sur les unités qui sont achetées et utilisées au Canada d'un marchand autorisé TCL.

Cette garantie ne couvre pas les produits de location ou à usage commercial. Cette garantie remplace toutes autres garanties ou ententes exprimées ou sous-entendues. Aucune personne, agent, distributeur, concessionnaire ou compagnie n'est autorisé à changer, modifier ou prolonger les termes de cette garantie de quelque façon que ce soit.

MEMO

MEMO

MEMO

INFORMATION ON CUSTOMER SUPPORT

HD DVD is a new and evolving format, so changes and improvements are possible. To obtain updated information about HD DVD and this product, as well as customer support information about this product, please contact Toshiba Customer Support:

* In the U.S., please call 1 (800) 319-6684 or visit
www.tacp.com/customersupport.

* In Canada, please call 1 (800) 268-3404 or visit www.toshiba.ca and click on support.

TOSHIBA



Printed on 100% Recycled Paper

ⓂPM0023604010

Free Manuals Download Website

<http://myh66.com>

<http://usermanuals.us>

<http://www.somanuals.com>

<http://www.4manuals.cc>

<http://www.manual-lib.com>

<http://www.404manual.com>

<http://www.luxmanual.com>

<http://aubethermostatmanual.com>

Golf course search by state

<http://golfingnear.com>

Email search by domain

<http://emailbydomain.com>

Auto manuals search

<http://auto.somanuals.com>

TV manuals search

<http://tv.somanuals.com>