

TOSHIBA



DVD VIDEO RECORDER

D-R1SU

OWNER'S MANUAL



OPERATIONS

Read "INSTALLATION GUIDE" first.



Introduction

Recording

Playback

Editing

Library

Function setup

Others

Table of Contents

Introduction

■ Caution for safety	4
■ About this product	5
■ Compatible discs	6
■ Index to Parts and Controls	12
Front panel and top panel	12
Rear Panel	14
Remote control	16
Display	18
■ Before operating this recorder	20

Recording

■ Before Recording	26
Initializing a DVD-RAM/RW disc (Logical Format) ...	28
DVD-RAM Physical Format	29
Entering characters	30
■ Recording a TV program	32
■ Recording an external source	36
■ Programming a recording (REC MENU)	39
■ VCR Plus+ Recording	46
Reservation Disc (Program Record Lock)	48
To delete recorded content	49
To protect recorded content	49
Technical Information	50

Playback

■ Information on playback	52
■ Playing recorded contents (CONTENT MENU)	53
■ Playing a DVD video disc	59
Locating a title using the top menu	60
■ Pausing a TV broadcast to resume later	61
■ Playing a TV program currently being recorded	62
■ Playing at various speeds	63
Playing in fast reverse or fast forward	63
Skipping to the next/previous chapter or track	64
Playing in slow-motion	64
Playing frame by frame	65
Viewing still pictures (Playing a disc that contains still pictures)	65

■ Locating by entering the number	66
Locating by entering the number of a desired section	66
Locating a specific point by entering its elapsed time (Time Search)	67
■ Using the graphic remote control (Virtual Remote)	68
Technical Information	66
■ Watching a TV broadcast in the sub window (P in P Playback)	69
■ Selecting the camera angle	70
■ Selecting Subtitles	71
■ Zooming a picture	72
■ Selecting the Sound	73
■ Checking the current status and settings	76
Operational status and setting details	76
Using the time bar	77
■ Functions in a Quick Menu	78

Editing

■ Before Editing	82
■ Creating Chapters	85
■ Playlist Editing (Collecting desired scenes)	90
■ Creating Thumbnails (Changing the picture on the CONTENT MENU)	95
■ High Speed Library Dubbing (Dubbing only a specified part)	98
■ Delete Selected Items (Deleting specified parts together)	100
■ Combine Original Titles (Combine two titles into one)	102
■ DVD-Video finalizing process	104
■ DV Recording (Recording from a digital video camera)	108

Library

■ Using Library data	112
Basic operation of the Library system	112
Checking remaining space on discs	113
Searching for a disc	113
Maintenance of Library data	114

Function Setup

■ Customizing the Function Settings	118
DVD Player Settings	122
Picture/Audio Settings	125
Display Settings	127
Operational Settings	128
DVD Recorder Operation	129
Management Settings	131
Setting of picture and sound quality for recording	131

Others

■ Troubleshooting	134
■ Error codes on the display window	137
■ Recording duration	138
■ Language Code List	139
■ Specification	140
■ LIMITED WARRANTY DVD VIDEO RECORDER	142

Caution for safety

Read “SAFETY PRECAUTIONS”, “IMPORTANT SAFETY INSTRUCTIONS”, “Precautions” and others of the “INSTALLATION GUIDE” first.



About this product

Digital AV equipment

This recorder is operated by sophisticated software and is different from other conventional AV equipment. Within the recorder, a DVD-RAM/R/RW drive is installed. The hardware and software work by way of an operating system (OS), which requires some time to start up after turning on the power. Also, some commands, such as erasing recorded contents may take time to execute.

Playback Restriction

This owner's manual explains the basic instructions for this recorder. Some DVD video discs are produced in a manner that allows specific or limited operation during playback. As such, the recorder may not respond to all operating commands. This is not a defect in the recorder. Refer to the instruction notes of discs.

“” may appear on the TV screen during operation. “” means that the operation is not permitted by the recorder or the disc.

Recording Restriction

Copy-protected contents of DVD-Video disc, VIDEO CDs or audio CDs on the market cannot be copied on this recorder.

Contents without copy protection can be copied or edited only for personal use. Contents that permit single copying (copy once contents) can be recorded onto DVD-RAM discs, with some dubbing and editing restrictions. DVD-R/RW discs cannot record these contents.



Compatible discs

There are many types and formats in discs. Confirm the compatibility of selected disc to insure proper performance.

Notes

- Handle the disc according to the disc instruction manual.
- Depending on the data recording method or the disc status, playback or recording on this recorder may not be possible, even if the disc is labeled as below. In such a case please contact the sales agency of the disc.

For recording / playback

Disc	Mark	Specification	Remarks
DVD-RAM		<ul style="list-style-type: none"> • Single sided 4.7GB (12cm (4³/₄ in.)) • Double sided 9.4GB (12cm (4³/₄ in.)) • Single sided 1.4GB (8cm (3¹/₄ in.)) • Double sided 2.8GB (8cm (3¹/₄ in.)) 	<p>Read carefully the section “On DVD-RAM discs” (➡ page 8).</p> <p>When using an 8cm (3¹/₄ in.) DVD-RAM disc, Remove it from the cartridge. For details, refer to the instructions of the disc.</p>
DVD-R		<ul style="list-style-type: none"> • 4.7GB For General Ver.2.0 (12cm (4³/₄ in.)) 	<p>Read carefully the section “On DVD-R discs” (➡ page 9).</p> <p>Depending on the disc or the recording equipment, playback of the disc may not be possible on this recorder.</p>
DVD-RW		<ul style="list-style-type: none"> • Ver. 1.1 or later (12cm (4³/₄ in.)) 	<p>Read carefully the section “On DVD-RW discs” (➡ page 9).</p> <p>Depending on the disc or the recording equipment, playback of the disc may not be possible on this recorder.</p>

Select a DVD-RAM disc that shows a statement on its package such as “this disc can be used with video recorders and drives compatible with 4.7GB DVD-RAM discs” or “this disc can copy images that permit single copying.”

Using different disc types for different purposes

Use DVD-RAM discs for your personal library.

DVD-RAM discs comply with the global standard DVD-VR (Video Recording) format, and are optimized for recording of TV programs. You can rewrite repeatedly without any deterioration, erase unnecessary parts, divide a chapter, or specify playback area by frame. Its cartridge is suitable for a long-term storage and family use, and its large capacity of 9.4 GB double sided disc is space saving.

Use DVD-R discs when creating your own original discs for distribution.











DVD-R discs comply with the global standard DVD-Video format, and can be recorded only once. DVD-R discs are convenient when you edit your original content (recorded personal events such as a wedding party) with your PC, and send them to your friends or relatives. The discs can be played on other DVD players. DVD-RW discs, which are rewriteable can be used as well.



* This format is not suited for recording TV programs. According to DVD-Video format, recording and dividing into chapters must be by 15 frames. Possibly an unnecessary part may remain even after editing. Also, you cannot record programs that include a scene with bilingual sounds, and programs that permit copying only once.

* This recorder records on a DVD-R/RW disc in DVD-Video format only. In DVD-VR format, recording is not possible.

We cannot guarantee that DVD-RAM/R/RW discs recorded on this recorder will be playable on all DVD players. Similarly, there is no guarantee that all DVD-RAM/R/RW discs recorded on other recorders will be playable on this player.

For playback only

Disc	Mark	Specification	Remarks
DVD video disc	 	<ul style="list-style-type: none"> • 12cm (4³/₄ in.) / 8cm (3¹/₄ in.) • Region number  or  • Color system: NTSC 	The region number of this DVD recorder is 1. If region numbers, corresponding to a specific playable area, are printed on your DVD video disc and you do not find  or  , disc playback will not be allowed by the recorder.
DVD-RW		<ul style="list-style-type: none"> • 12cm (4³/₄ in.) • DVD-VR mode 	It is not possible to play contents recorded from programs which are not copy-free. Depending on the disc, playback may not be possible.
VIDEO CD		<ul style="list-style-type: none"> • 12cm (4³/₄ in.) / 8cm (3¹/₄ in.) • Color system: NTSC • Version 1.0 and 2.0 	
Audio CD		<ul style="list-style-type: none"> • 12cm (4³/₄ in.) / 8cm (3¹/₄ in.) 	
CD-R		<ul style="list-style-type: none"> • 12cm (4³/₄ in.) • CD-DA (audio CD) format 	Depending on the disc, playback may not be possible.
CD-RW			

- This recorder uses the NTSC color system, and cannot play DVD video discs recorded in any other color system (PAL, SECAM, etc.), even if they have region marks  or .
- There may be some DVD discs designed for this market that cannot be played on this recorder. If you encounter please contact TOSHIBA customer service.

On DVD-RAM discs

■ Use only DVD-RAM discs that comply with DVD-RAM standard Version 2.0 or 2.1.

The recorder cannot record on a disc formatted in any other standard. When using such a disc, initialize it using the disc-format function of the recorder.

- The recorder may not record, dub, or edit some DVD-RAM discs, because they are edited/recorded with another manufacture's equipment or PC, contain a large number of titles, or have little remaining capacity. Also, a DVD-RAM disc may not be edited or recorded if its title contains still pictures.
- DVD-RAM discs formatted in UDF2.0 on a PC are not compatible with this recorder. Before using these discs, initialize them on this recorder.
- This recorder complies with current copyright protection technology and can copy a disc only when the disc permits copying once. When there is no indication on the disc, copying will not be allowed. Such an indication on a disc is required also for the Library Management database.

■ DVD-RAM discs with cartridges are recommended for recording.

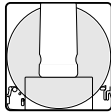
- Two types of DVD-RAM discs are available: ones with cartridges and ones without cartridges. You can use either of them with this recorder, but the former ones are recommended. 
- In order to record highly detailed data, make sure the disc is clean. DVD-RAM discs with cartridges are easier to handle in this regard.
- Do not open the cartridge shutter. The disc may not play, or may not be recorded or edited once it becomes dirty.
- There are two types of DVD-RAM cartridges; removable (TYPE 2/4) and not removable (TYPE 1). It is recommended you do not remove the disc even when you can. Refer to the instruction manual that comes with the disc if it is absolutely necessary to remove the disc.
- Some commercially available cartridge discs cannot be recorded or edited once the inside discs are removed.

● To protect recorded contents

Slide the write-protect tab to "PROTECT" with something sharp. The disc can play, but cannot be edited or erased. Refer to the instructions that come with the disc.

- The resuming function (▶ page 56) will not work if the write-protect tab is set to "PROTECT".

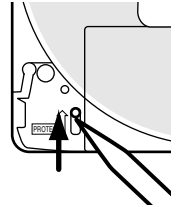

■ When using a disc without a cartridge (commercially available discs)

- Discs without cartridges can easily attract fingerprints and dust, which is the reason they are not recommended. If you cannot avoid using them, handle with proper care.
- When you write in a title column on a disc, use a pen with a soft tip. Do not use a pen with a hard tip, such as a ballpoint pen.

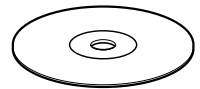

Recommended discs

The following discs have been tested with this recorder:

- 9.4 GB double-sided cartridge: Panasonic LM-AD240U
- 4.7 GB single-sided cartridge: Panasonic LM-AB120U

- The company does not hold any responsibility to compensate the contents which should have been recorded, and any losses or damages (e.g. losses of business profit, or business intermission) that may arise from malfunction of this recorder (not recording/editing as intended). Problems arising in the following situations are included.
 - When a DVD disc recorded on this recorder is used in a DVD recorder of another manufacturer, or used (insertion, playback, recording or editing) in a personal computer DVD drive.
 - When a DVD that has been used as above is used again in this recorder.
 - When a DVD disc recorded in a DVD recorder of another manufacturer, or in a personal computer DVD drive.
- Some functions such as Library may not work with PC discs.

On DVD-R discs

■ Standards

- DVD-R for General Ver.2.0/2.1 discs can be used for recording and playback.
- Discs compatible with 2X speed recording (labeled Ver.2.1/2X etc.) and discs compatible with 4X speed recording (labeled Ver.2.1/4X etc.) can also be used.
- Select discs labeled “for video,” “for recording,” “120 min.” etc.
- DVD-R for authoring Ver.1.1 cannot be used.

■ Recording conditions

- Images for which copying is prohibited or restricted (copy once or copy prohibited) cannot be recorded. Even if the disc is labeled as CPRM compatible, this recorder can only be used to record copy-free material.

■ Recommended discs

Panasonic LM-RF120 (4.7GB/120 min.).

On DVD-RW discs

■ Standards

- Discs labeled DVD-RW Ver.1.1 can be used.
- Discs compatible with 2X speed recording (labeled Ver.1.1/2X etc.) can also be used.
- Select discs labeled “for video,” “for recording,” “120 min.” etc.

■ Recording conditions

- Images for which copying is prohibited or restricted (copy once or copy prohibited) cannot be recorded. Even if the disc is labeled as CPRM compatible, this recorder can only be used to record copy-free material.
- DVD-VR mode recording is not possible.





■ Recommended discs*

Victor/JVC VD-RW120B
Victor/JVC VD-RW120D

*Operation has been confirmed with recommended discs, but some other discs may not be usable.

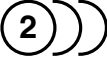
Marks on DVD video discs

The following are examples of marks and the meanings.

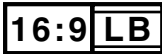
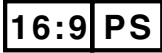
Mark	Meanings
	Number of audio streams recorded in the disc. (2 streams such as English and Japanese in this example.)
	Number of subtitle languages recorded in the disc. (2 subtitle languages are recorded in this example.)
	Number of camera angles recorded in the disc. (3 camera angles are recorded in this example.)
	Pictures are recorded in the standard picture size (4:3 aspect ratio).
	Pictures are recorded in the letter box picture size (4:3 aspect ratio with horizontal black bars in the top and bottom of pictures).
	Pictures are recorded in the 16:9 wide picture size. TVs with 4:3 aspect ratio will display them in the letter box style.
	Pictures are recorded in the 16:9 wide picture size. TVs with 4:3 aspect ratio will display them in the pan scan style (one or both sides of pictures are cut).
	Actual picture size may vary depending on the aspect ratio or mode selection of the TV.

Compatible discs (Continued)

Structure of disc contents

Normally, DVD video discs are divided into titles, and the titles are subdivided into chapters.

VIDEO CDs/audio CDs are divided into tracks.

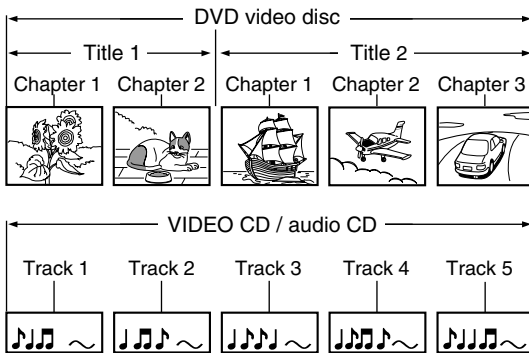

Title: Divided contents of a DVD video disc. Roughly corresponds to a story title in short stories.

Chapter: Divided contents of a title. This corresponds to a chapter in a story.

Track: Divided contents of a VIDEO CD or an audio CD.

Each title, chapter, or track is assigned a number, which is called "title number", "chapter number", or "track number" respectively.

Some discs may not have these numbers.

When you record on a DVD-RAM/R/RW disc, one recording will always equal one title.

On handling discs

- Do not touch the playback side of the disc.

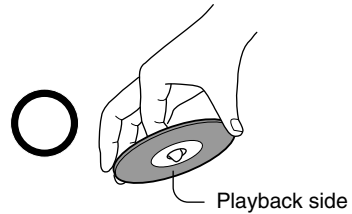

- Do not stick paper or tape to discs.



On cleaning discs

- Fingerprints and dust on the disc cause picture and sound deterioration. Wipe the disc from the center outwards with a soft cloth. Always keep the disc clean.

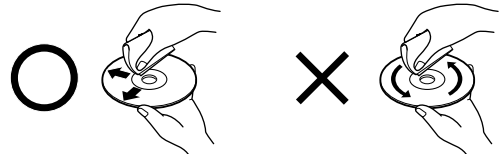

- If you cannot wipe off the dust with a soft cloth, wipe the disc lightly with a slightly moistened soft cloth and finish with a dry cloth.
- Do not use any type of solvent such as thinner, benzene, commercially available cleaners or antistatic spray for vinyl LPs. It may damage the disc.

On storing discs

- Do not store discs in a place subject to direct sunlight or near heat sources.
- Do not store discs in places subject to moisture and dust such as a bathroom or near a humidifier.
- Store discs vertically in a case. Stacking or placing objects on discs outside of their case may cause warping.

Discs and purposes

The table shows main functions which are available on this recorder per disc category. This will help you choose discs.

	DVD-RAM disc	DVD-RW disc	DVD-R disc
Characteristics on this recorder	Suitable for repeat use of the disc, and data storage for video library. Copy once contents can be recorded using a compatible disc.	Suitable for saving data in DVD-Video format to play on compatible devices. You can erase recorded contents to use the disc repeatedly.	Suitable for saving data in DVD-Video format to play on compatible devices. Once you execute DVD-video finalize process on a recorded disc so that it can be played on other players, you cannot make addition, correction and deletion of contents on the disc.
For the first use	No preparatory steps required, however initializing is recommended.	Initialize the disc.	No preparatory steps required.
Recording a TV program	○	○	○
Erasing recorded contents	○	○ If the disc has been executed DVD-Video finalize process, first cancel the process then delete contents.	○ Deleting contents cannot restore the disc space. <u>After you execute DVD-video finalize process on a recorded disc, you cannot delete contents of the disc.</u>
Recording additionally on a recorded disc	○	○	○ <u>After you execute DVD-video finalize process on a recorded disc, you cannot add contents to the disc.</u>
Indexing recorded contents Naming a title Creating a thumbnail	○ ○	○ ○	○ ○
Collecting favorite scenes (Playlist Editing) Making a new title from a Playlist containing favorite scenes (Copy within the same disc)	X X	X X	X X
Playing contents recorded on this player, on other devices	Contents can be played on any devices compatible with DVD-RAM discs. Follow the instruction of the device to play.	Execute DVD-Video finalize process on this recorder. This process makes the disc playable on other devices compatible with DVD-Video format. (Some models excepted.)	Execute DVD-Video finalize process on this recorder. This process makes the disc playable on other devices compatible with DVD-Video format. (Some models excepted.)
When a message appears and the loaded disc cannot be used:	Initialize the disc. If it is still unusable, try to execute DVD-RAM Physical Format.	Initialize the disc.	-

Index to parts and controls

See pages with arrows for details.

Front panel and top panel

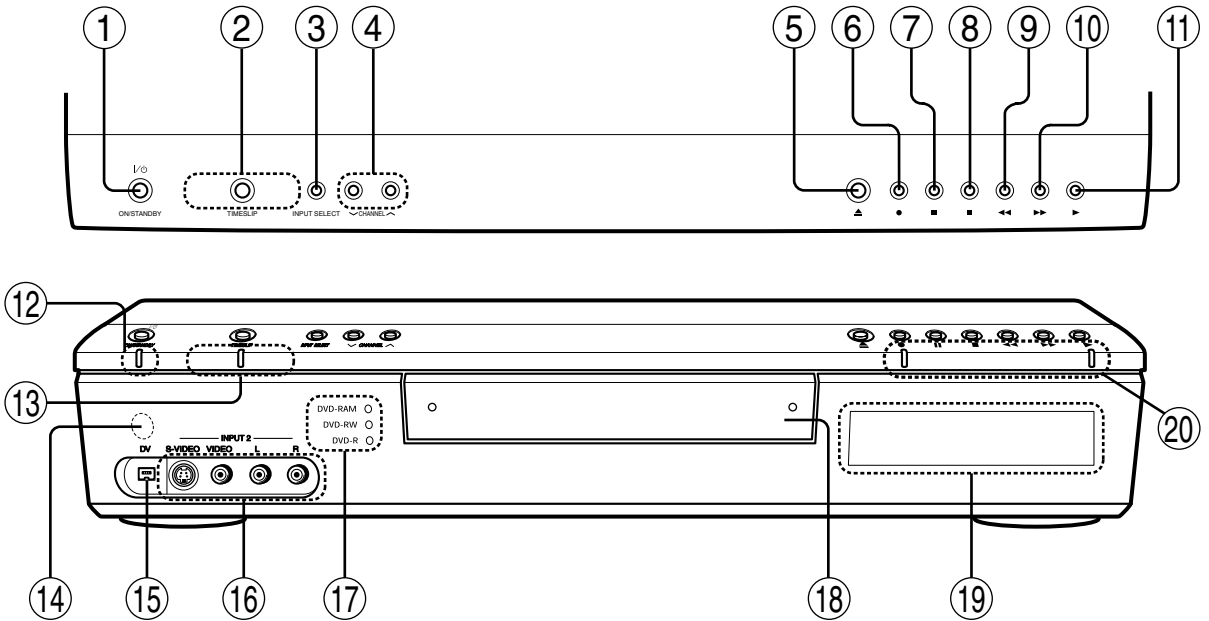

- ① **ON/STANDBY button** ➔ page 20, 21
Turns the power on/restores the unit in the standby mode.
- ② **TIMESLIP button** ➔ page 63, 64
Selects the time slip mode.
- ③ **INPUT SELECT button** ➔ page 38
Pressing repeatedly selects between various input sources.
- ④ **CHANNEL buttons** ➔ page 20, 33
Selects the channel.
- ⑤ **▲ (OPEN/CLOSE) button** ➔ page 20, 21
Opens and closes the disc tray.
- ⑥ **● (REC) button** ➔ page 34
Starts recording.
- ⑦ **|| (PAUSE) button** ➔ page 35, 56
Stops playback or recording momentarily.
- ⑧ **■ (STOP) button** ➔ page 35, 56
Stops playback or recording.
- ⑨ **◀◀ (PICTURE SEARCH) button** ➔ page 65
Scans the picture backwards.
- ⑩ **▶▶ (PICTURE SEARCH) button** ➔ page 65
Scans the picture forward.
- ⑪ **▶ (PLAY) button** ➔ page 61
Starts playback.

- ⑫ **ON/STANDBY indicator** ➡ **page 20, 21**
Displays the operational state of the recorder.
- ⑬ **TIMESLIP indicator**
Lights up in the time slip mode.
- ⑭ **Remote sensor** ➡ **page 12 in “INSTALLATION GUIDE”**
- ⑮ **DV input connector** ➡ **page 110**
Use this when recording from a digital video device such as a digital video camera.
- ⑯ **INPUT 2 jacks** ➡ **page 37**
Use this when recording from other input source such as a VCR or a camcorder.
- ⑰ **Media indicator**
Indicates the current media.
- ⑱ **Disc tray** ➡ **page 20**
Loads a disc into the disc drive.
- ⑲ **Front panel display** ➡ **page 18**
- ⑳ **Operational status indicator**
Indicates the operational status of the recorder.
- □ : Illuminates when recording.
 - ▶
□ : Illuminates when playing.
 - ▶
□□ : Illuminates when copying within a disc.

Rear Panel

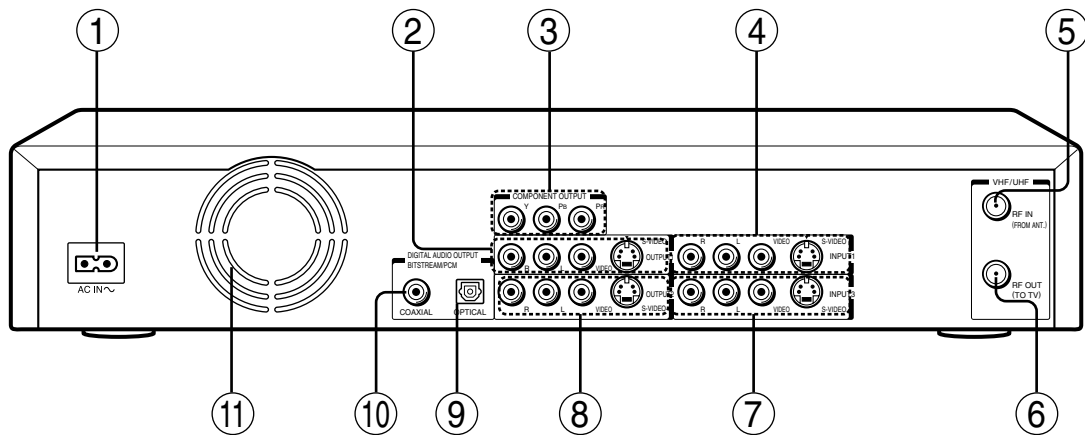

- ① **AC IN socket** ➔ page 15 in “INSTALLATION GUIDE”
Connects the supplied power cord.
- ② **OUTPUT 1 jacks** ➔ page 15, 19 in “INSTALLATION GUIDE”
Outputs video and audio signals to a connected TV or amplifier.
- ③ **COMPONENT OUTPUT jacks** ➔ page 19 in “INSTALLATION GUIDE”
Outputs video signals to a connected TV or monitor.
Connects to a TV or monitor equipped with component video jacks.
- ④ **INPUT 1 jacks** ➔ page 37
Use this to connect the recorder to output jacks of external devices such as another player or camcorder.
- ⑤ **VHF/UHF RF IN (FROM ANT.) input socket** ➔ page 14 in “INSTALLATION GUIDE”
Connects to an antenna or cable signal.
- ⑥ **VHF/UHF RF OUT (TO TV) output socket** ➔ page 14 in “INSTALLATION GUIDE”
Connects the supplied coaxial cable to a TV.
- ⑦ **INPUT 3 jacks** ➔ page 37
Use this to connect the recorder to the output jacks of external devices such as another player or camcorder.
- ⑧ **OUTPUT 2 jacks** ➔ page 15, 19, 21 in “INSTALLATION GUIDE”
Outputs video and audio signals to a connected TV or amplifier.
- ⑨ **DIGITAL AUDIO OUT/OPTICAL jack** ➔ page 21, 22, 23 in “INSTALLATION GUIDE”
Use this to connect the recorder to an audio receiver equipped with an optical digital audio input jack.
When connecting the optical digital cable, remove the cap and fit the connector into the jack firmly.
When not using the jack, keep the cap inserted to protect it from dust intrusion.

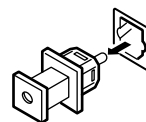

- ⑩ **DIGITAL AUDIO OUT/COAXIAL jack** ➞ page 21, 22, 23 in “INSTALLATION GUIDE”
Use this to connect the recorder to an audio receiver equipped with a coaxial digital audio input jack.

- ⑪ **Ventilation fan**

Remote control

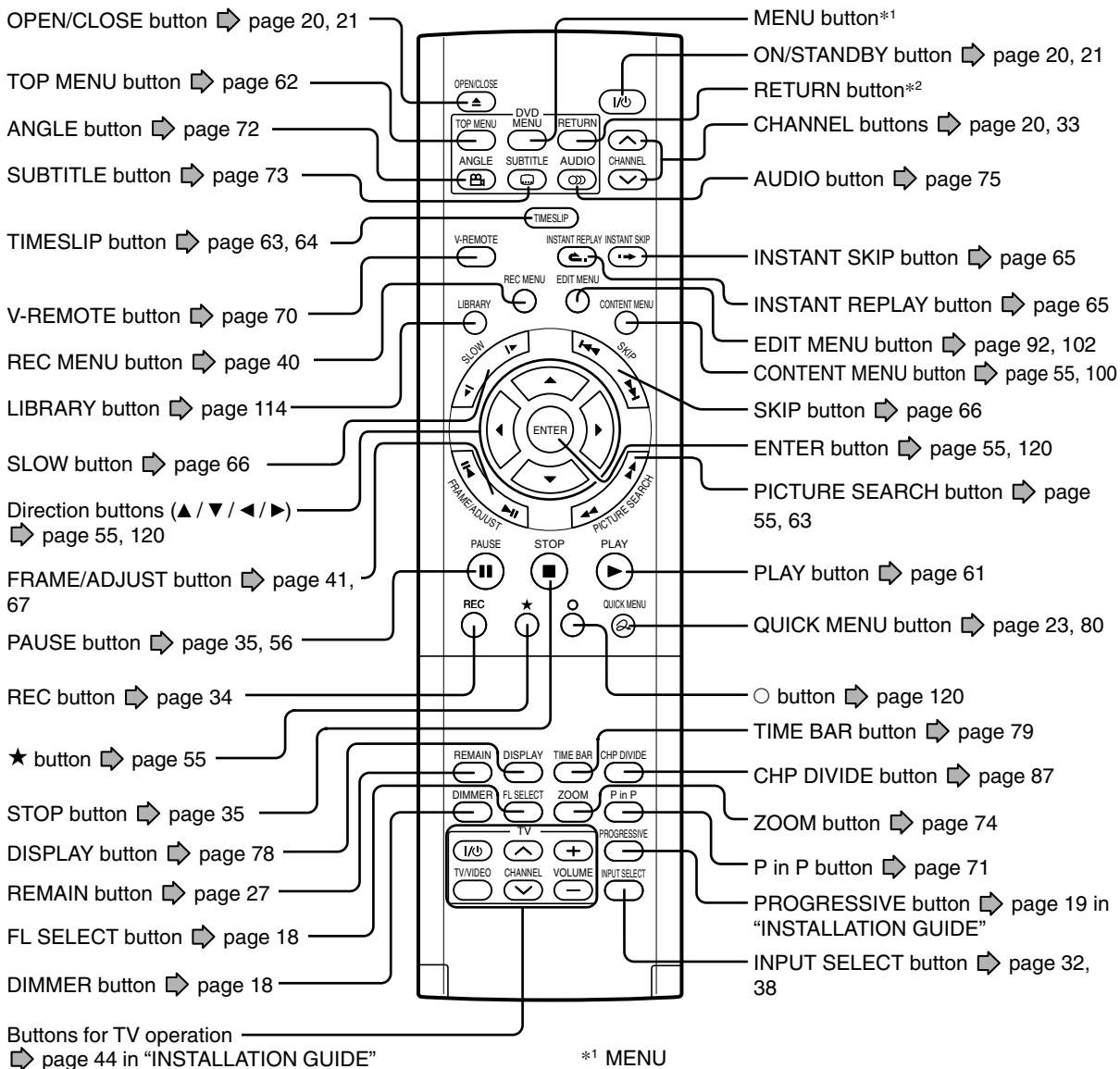

*1 MENU

Use this to display a menu screen that is recorded on a DVD video disc.

Operate the menu screen as the same manner as "Locating a title using the top menu (➔ page 62)". A menu screen is not recorded on some discs.

*2 RETURN

Returns to the previous screen (the screen may be specified depending on the disc).

Refer to the instructions of the disc.

Under the lid

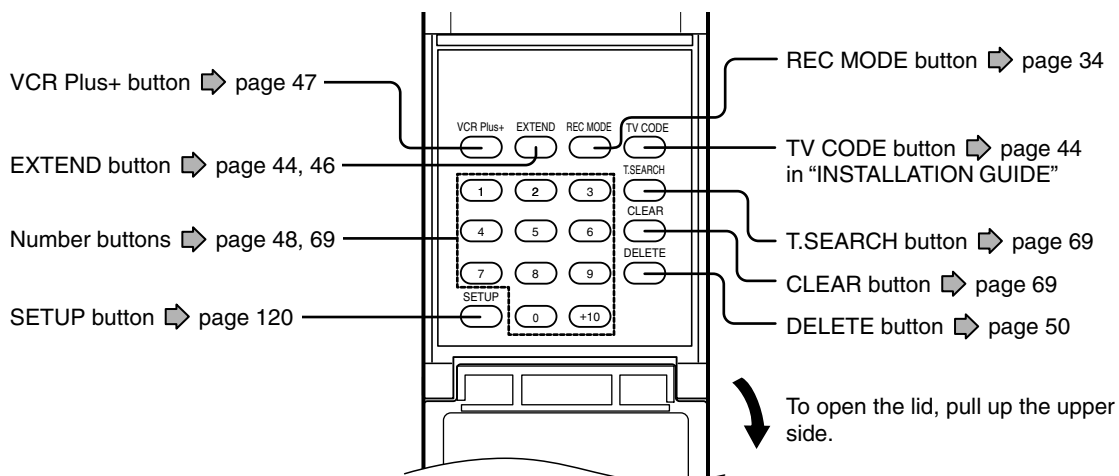

Display

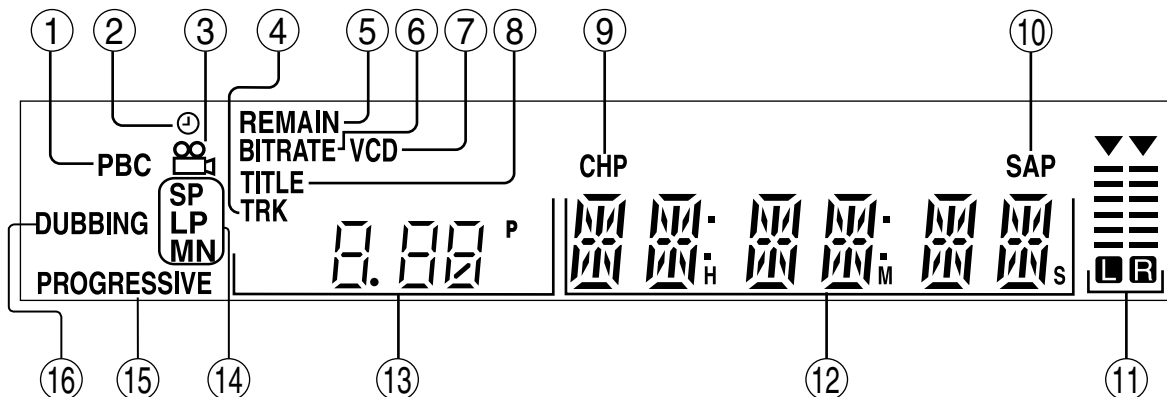

- ① **PBC indicator**
Illuminates when PBC function is "On" (➔ page 126) and a PBC-controllable VIDEO CD is loaded.
- ② **Program recording indicator**
Illuminates when the recorder holds a timer program.
- ③ **Angle icon** ➔ page 72
Illuminates when playing a scene recorded with multi angles.
- ④ **TRK (Track) indicator**
Illuminates when a track number is displayed.
- ⑤ **REMAIN (Remaining space) indicator**
Illuminates when an available recording time is displayed.
- ⑥ **Bit rate indicator**
Illuminates when displaying the bit rate selected for recording, or when displaying the actual bit rate.
- ⑦ **VCD/CD indicator**
VCD : Illuminates when a VIDEO CD is loaded.
CD : Illuminates when an audio CD is loaded.
- ⑧ **Title indicator**
Illuminates when a title number is displayed.
- ⑨ **CHP (Chapter) indicator**
Illuminates when a chapter number is displayed.

■ Dimming the display

Pressing the DIMMER button on the remote control changes the brightness of the display (normal/dimmed/off).

■ Switching the display

Every time you press the FL SELECT button, the display changes between the channel, title number, and time.

The display may not change, depending on the disc or recording conditions.

⑩ SAP indicator

Illuminates when receiving a SAP broadcast.

⑪ Analog output level indicator

Displays the analog output level.

L+R: Stereo and bilingual (left (main) channel and right (sub) channel)

L: Left (main) channel

R: Right (sub) channel

Off: Mono

Level indicator may not show exact sound level. It only shows the average level.

⑫ Multi display

Displays the current time, elapsed time, remaining time, starting time of programmed recording, chapter number or message, etc.

⑬ Channel indicator

Displays the current channel or other numbers such as a title number, track number, bit rate or input selection.

⑭ Picture quality mode indicator ➡ page 135

The current picture quality mode lights up.

The modes are: MN (Manual)/SP (Standard Play)/LP (Long Play)/SP+LP+MN (Auto)

⑮ PROGRESSIVE indicator

Illuminates when video signals are output in the progressive format.

⑯ DUBBING indicator

Illuminates when copying.

Before operating this recorder

■ Is your recorder ready?

- Refer to the supplied "INSTALLATION GUIDE" manual and finish the necessary preparations.
- Turn on the connected equipment such as a TV or audio system and select the input from the recorder.

■ Turning the power on

(This owner's manual instructions are based on the assumption that all proper connections have been completed and the TV is turned on.)

Press the ON/STANDBY button on the front panel of the recorder or on the remote control.

ON/STANDBY button

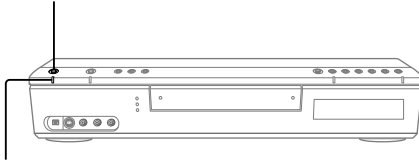

ON/STANDBY indicator

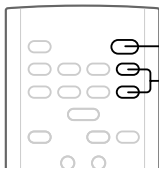

ON/STANDBY button

CHANNEL buttons

When the power turns on, the ON/STANDBY indicator changes from red (standby mode) to green (operation). After a few seconds, a start-up screen appears. The following icon appears at the top right corner of the screen.



When this icon disappears, the recorder is ready to operate. If the disc drive contains a disc, it takes a little longer to start up.

■ Viewing TV channels through this recorder

After turning the power on, the recorder will output TV channel signals to the connected TV (also in the stop mode).

You can select a desired channel by pressing the CHANNEL buttons.

■ Loading a disc

Check disc compatibility beforehand (➡ page 6, 7) and use a proper playable disc.

Caution

- Keep your fingers well clear of the disc tray. Neglecting this may cause serious personal injury. Keep a close watch on children.
- Do not use a cracked, deformed, or repaired disc.

1 Open the disc tray.

Press the  button on the front panel or the OPEN/CLOSE button on the remote control.

button

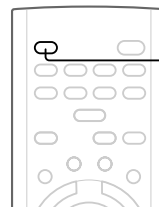
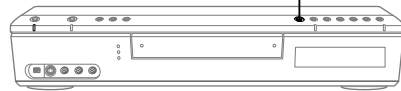

OPEN/CLOSE button

2 Insert a disc.

Disc without a cartridge

Insert with the playback side down.

Disc size varies depending on the disc. Place a disc to fit the guide. If a disc is out of the guide, it may result in damage to the disc or malfunction.

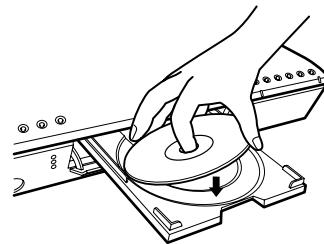

Place a disc in the inside hollow.

DVD-RAM disc with cartridge (TYPE1/TYPE2/TYPE4)

Single sided

Turn the printed side up, and insert the cartridge into the tray frame following the direction of the arrow on the cartridge.

Double sided

Turn a desired recording/playback side up, and insert the cartridge into the tray frame following the direction of the arrow on the cartridge.

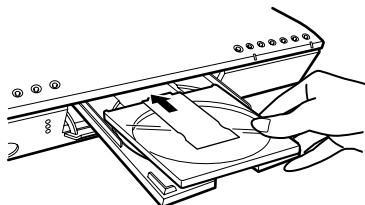

3 Close the disc tray.

Press the ▲ button on the front panel or the OPEN/CLOSE button on the remote control.

Notes

- Use the button on the front panel or the remote control to open and close the disc tray. Do not push or hold the disc tray while it is moving. Doing so may cause the recorder to malfunction.
- Do not insert a disc which is unplayable, or any object other than a playable disc.
- Do not apply downforce to the disc tray. Doing so may cause the recorder to malfunction.
- If the disc tray stops while closing, the mechanical protection system of this recorder will open it. Do not force it to close. Doing so may cause malfunction.
- If the disc tray will not open, turn the recorder off, and press the ▲ button on the front panel or the OPEN/CLOSE button on the remote control. This may turn the recorder on and open the disc tray. If it still won't open, contact your nearest TOSHIBA dealer.

■ Turning the power off

Press the ON/STANDBY button on the front panel of the recorder or on the remote control.

The "Unloading" icon appears at the top right corner of the screen, and the ON/STANDBY indicator turns red, then the power turns off.

Caution

- If the power fails or the power cord is disconnected from a wall outlet while the recorder is in operation (ON/STANDBY indicator lit in green), the loaded disc may become recording disabled. In such a case, executing an initialization of the disc using the formatting function of the recorder may refresh it. However, all contents stored on the disc will be completely erased by this initialization process.
- This recorder may indicate alert messages with some DVD-RAM discs right after insertion. If such a disc is used for playback or recording on other equipment, all data in the disc may be damaged and the disc will not be played. By executing an initialization of the disc using the formatting function of the recorder, the disc will be able to work.
- If the recorder freezes and does not respond at all, leave it alone for about 15 minutes or longer. This may restore the recorder. After the recorder has recovered, turn it off once and turn it on again to use as usual. If the recorder is still inoperable after more than 15 minutes have passed, press and hold the ON/STANDBY button on the front panel or the remote control for about 10 seconds or longer. The recorder is forced to quit and the power turns off. Turn the recorder on again and use it as usual. (This is an emergency measure, which may cause losses and/or damages of data. Avoid casual use of this measure.) (This 15-minute measure is available only when "Screen Protector" is set to "On." (▶ page 129))

Note

- If there are any performance malfunctions of the disc drive, immediately discontinue use of this recorder, and disconnect the power cord from a wall outlet, then contact your dealer. Continuous use of the recorder in such a condition will aggravate the condition and result in increased cost and repair time.

■ Disc tray lock

You can lock the disc tray.

Press and hold ■ on the front panel or PAUSE on the remote control for longer than about 3 seconds.

To unlock, during stop press the button for longer than about 3 seconds.

Note

- Turning the power off also unlocks the disc tray.

Before operating this recorder (Continued)

■ Using the GUI (Graphical User Interface)

The recorder provides you with a variety of GUI (Graphical User Interface) applications to assist your operation of most functions such as customizing of setting, playback or recording. Refer to the operation guide on the bottom on each GUI. This will indicate proper button selection for desired action.

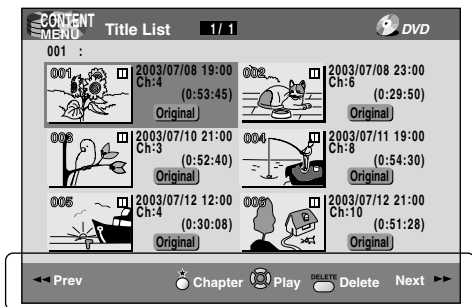

Operation guide

Example of the icon

Function

	Direction buttons	To select an item.
	ENTER button	To confirm (register) a selected item or setting.
	★ button	To change the category of contents
	PICTURE SEARCH ◀◀ button	To return to the previous page.
	PICTURE SEARCH ▶▶ button	To proceed to the next page.
	FRAME/ADJUST button	To enter numerical digits or change the value.
	Number buttons (Open the lid of the remote control.)	To enter numerical digits.
	DELETE button (Open the lid of the remote control.)	To delete the selected program.
	SETUP button (Open the lid of the remote control.)	To display/exit the Setting menu.

■ If a message appears

The recorder will display messages related to operational status. Respond accordingly, as below:

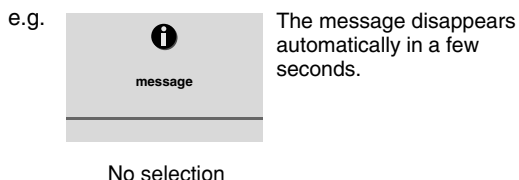
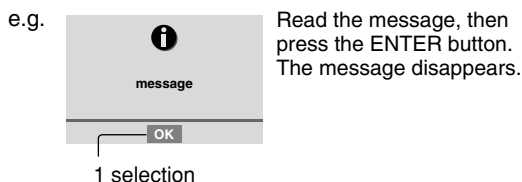
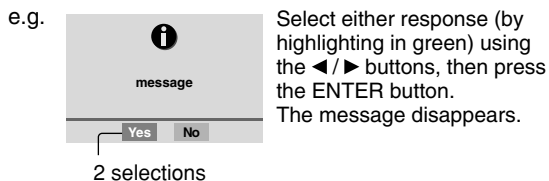
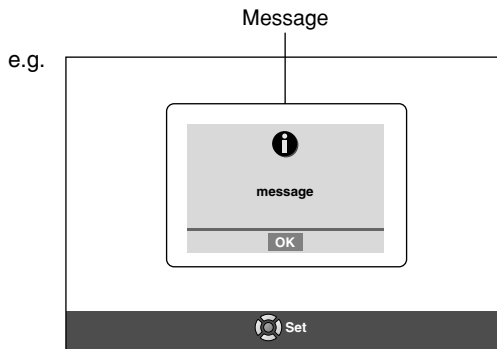

■ Quick Menu operation

To access various optional functions of this recorder, open the Quick Menu. The Quick Menu displays a list of selections relevant to your current mode.

● Opening a Quick Menu

1) Press the QUICK MENU button.

The following menu ("Quick Menu") appears.
(Actual selections vary depending on operational status.)

e.g.

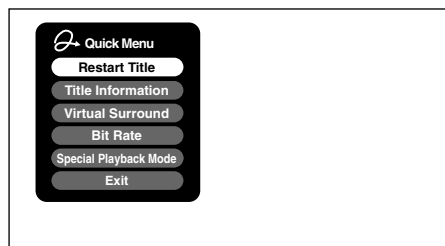

2) Press the ▲ / ▼ buttons to select an item, then press the ENTER button.

● To exit the Quick Menu

Press the QUICK MENU button again.

Alternatively

Select "Exit" with the ▲ / ▼ buttons, then press the ENTER button.

■ Status display

Each time you operate the recorder, the following displays appear on the TV screen to indicate the status of the recorder.

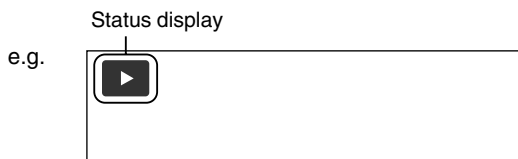

Main on-screen displays

(Depending on the disc, some of these may not appear.)

- ▶ : Playback
- ⏸ : Pause
- : Stop
- ⏩ : Fast-forward
- ⏮ : Fast-reverse
- ⏭ : Forward skip*
- ⏪ : Reverse skip*
- ▶x1/2 : Forward slow-motion
- ◀x1/2 : Reverse slow-motion
- ⏮ : Forward frame by frame playback
- ⏭ : Reverse frame by frame playback
- : Recording
- ⏸ : Recording pause
- Title End : When title playback is completed
- ➡ : Instant skip
- ↶ : Instant replay
- Chapter Divide : Chapter division
- 1/20 : Forward skip by 1/20
- 1/20 : Reverse skip by 1/20

* Accompanied with the followings:

DVD-RAM **DVD-R** **DVD-RW** :

Title number/title name and chapter number/
chapter name

DVD-VIDEO :

Title number and chapter number

VCD **CD** :

Track number

Notes

- To disable the status display, set "On Screen Display" (▶ page 129) to "Off."
- You can add the current status of the settings to this display. See ▶ page 78.

Before operating this recorder (Continued)

■ Start-up/Shutdown (closing) icons

These icons are displayed at the top right corner of the screen when startup or finishing. While they are flashing, the recorder is operating as follows:



Start-up, reading a disc, finishing the recording



unloading a disc, finishing the operation



Opening a disc tray



Closing a disc tray

■ System software update service

Because of problems and errors that can occur during the creation of DVD software and/or the manufacture of DVD discs, Toshiba America Consumer Products cannot guarantee that this recorder will play every feature of every DVD bearing the DVD logo. As one of the creators of DVD technology, Toshiba DVD recorders are manufactured to the highest standards of quality and, as a result, such incompatibilities are very rare. If you have any questions, or if you happen to experience any difficulty playing a DVD on a Toshiba DVD recorder, please feel free to call our Customer Service Hotline at 1-800-319-6684.

Hint on reading this manual

The following icons show the playable discs for each function described on this instruction manual.

DVD-RAM : DVD-RAM disc

DVD-RW : DVD-RW disc

DVD-R : DVD-R disc

DVD-VIDEO : DVD video disc

VCD : VIDEO CD

CD : Audio CD

Most instructions are based on remote control operation, unless otherwise noted. You can use the buttons on the remote control and those on the main unit as well when they have the same function.

If copy protection signal is detected during recording on this recorder, the recording automatically pauses and a message appears. In this case, the PAUSE button cannot release the recording. (It is possible to end the recording by pressing the STOP button.) If the copy protection signal continues, the recording will terminate.

Recording

Recording variations for many types of programs or situations.

- **Before recording**
- **Recording a TV program**
- **Tips on recording**
- **Recording an external source**
- **Programing a recording (REC MENU)**
- **VCR Plus+ recording**
- **Others**

Before recording

Please be sure to read this critical background information prior to making a recording.

Conventional video cassette recorders have required tapes to record, while this recorder enables recording on a DVD-RAM/R/RW disc whenever you want, without selecting an available tape and confirming a point to start a recording from. Further, if you use DVD-RAM discs, you can collect necessary scenes and store them in it to make your own video library.

■ Is your DVD recorder ready?

Before recording a TV program on this recorder, insure that channels you want to record are correctly tuned in on this recorder. If not tuned in, read the separate "INSTALLATION GUIDE" volume again, and confirm all the necessary connections and settings have been done. Also, insure the clock is set precisely for program recording. Set the clock using the Initial Settings menu (➡ page 30, INSTALLATION GUIDE).

■ Disc initializing

Whenever you use a new DVD-RAM/RW disc on this recorder, be sure to initialize the disc. For DVD-RAM disc, initialization is indispensable to the database system of this recorder.

DVD-R discs can be used on this recorder without initializing.

For details of initialization of DVD-RAM/RW discs, see ➡ page 28.

If an initialized DVD-RAM disc is still unusable, it may become usable by executing "DVD-RAM Physical Format" in the Initial Settings menu.

For "DVD-RAM Physical Format", see ➡ page 29.

■ Note on recording on a DVD-RAM disc

Confirm disc compatibility and prepare an available DVD-RAM disc to record on (➡ page 6, 8).

Some discs may need to be formatted for use on this recorder. A message will appear asking you to execute disc formatting. Follow the procedure displayed on-screen to format the DVD-RAM disc compatible with this recorder.

Some DVD-RAM discs formatted on a PC may not be usable.

Note

- This recorder records on a DVD-RAM disc if it complies with DVD-RAM standard Version 2.0 or 2.1. However, you may not record on some DVD-RAM discs that have complicated contents (often, to protect the recorded data). When you select a DVD-RAM disc that has already been recorded, check that the disc is suitable for recording or the remaining time of the disc is displayed. It is recommended to use a new DVD-RAM disc for an important recording.

■ Note on recording on a DVD-RW disc

Confirm disc compatibility and prepare an available DVD-RW disc to record on (➡ page 6, 9).

Some discs may need to be initialized for use on the recorder. A message will appear asking you to execute disc initializing. Follow the procedure displayed on-screen for initialize the DVD-RW disc compatible with this recorder.

Some DVD-RW discs initialized on a PC may not be usable.

To play a DVD-RW disc recorded on this recorder on other devices, finalize the DVD-RW disc on this recorder. (➡ page 106)

The finalization disables the disc's rewritability. To rewrite a finalized DVD-RW disc, cancel the finalization. (➡ page 109).

- On DVD-RW discs recorded on other devices, you cannot execute DVD-Video finalize process or cancel the finalize process, or add recordings on this recorder.
- You cannot rewrite or edit a DVD-RW disc if recorded in DVD-VR mode.
- DVD-RW discs which are recorded on other devices and not finalized yet, cannot be read on this recorder. Do not rush to initialization. Check that the contents can be erased or not.

■ Note on recording on a DVD-R disc

Confirm disc compatibility and prepare an available DVD-R disc to record on (➡ page 6, 9).

To play a DVD-R disc recorded on this recorder on other devices, finalize the DVD-R disc on this recorder. (➡ page 106)

The finalization permanently disables the disc's rewritability. (Canceling the finalization is not possible.)

- DVD-Video finalize process cannot be canceled if once executed on a DVD-R disc.
- On DVD-R discs recorded on other devices, you cannot execute DVD-Video finalize process or add recordings on this recorder.

■ To check space remaining on a disc

1) Press the REMAIN button.

The current capacity is displayed at the bottom of the screen and on the front panel display.

2) After checking the capacity, press the button again to turn off the display.

Note

- You can also check the capacity of the disc by selecting "Disc Budget Calculation" from the Quick Menu on the REC MENU (➡ page 45).

■ Programmed recording and operational status

The recorder gives priority to programmed recordings in every operating mode. Even if the recorder is playing, recording or editing, or even in standby mode, at a starting time of a programmed recording the recorder will make itself ready or stop those operations and start the recording.

■ When the programmed settings overlap

Before the first recording is completed, the second program is scheduled to begin recording. When using a DVD-RAM disc, the recording of the previous program stops 15 seconds before the next program starts.

When using a DVD-R or DVD-RW disc, the recording of the previous program stops about 2 minutes before the next program starts, to complete data process. In this 2 minutes, you cannot operate the loaded DVD-R or DVD-RW disc.

■ On a programmed recording across the change-over of Daylight-saving time

- When the clock gains across Daylight-saving time during a programmed recording, it means that the recording completion time is consequently set one-hour earlier. In this case, set the programmed recording one-hour longer in advance. If not set accordingly, the programmed recording stops one-hour shorter.
- When the clock loses across Daylight-saving time during a programmed recording, it means that the recording completion time is consequently set one-hour later. In this case, as the programmed recording continues one-hour longer, delete unnecessary chapters by chapter dividing after the completion of recording.

Notes

- The "Loading" icon appears in the top right of the screen after recording. This indicates that the unit is executing the final recording process (writing managing information). Operations other than changing channels cannot be done until this icon disappears. The time for executing this process differs depending on the recording time or capacity of the disc.
- Note that all recording content may be deleted if the unit is disconnected from a wall outlet, or a power failure occurs, during recording.
- If a power failure occurs within five minutes prior to the programmed recording start time, the programmed recording may not be executed.
- A programmed recording may not be executed correctly if scheduled when Daylight-Saving time starts or ends.

Initializing a DVD-RAM/RW disc (Logical Format)

Be sure to read this section prior to using a DVD-RAM/RW disc on this recorder for the first time. For DVD-R, initializing is not necessary.

A disc should be initialized in the following cases: (The recorder may display a message to request you to do so.)

e.g.

- When you use a DVD-RAM/RW disc on this recorder for the first time.
- If data fragments produced by repeated recording or erasing have accumulated.
- If a disc error has occurred.
- When you want to record on a DVD-RAM disc for PC. (➡ page 8)

Initializing formats a disc logically and insures that it will perform to its full capability. However, this erases all data on the disc, so make sure that it does not matter if data on the disc is erased whenever you initialize a disc.

■ How to initialize a disc

To initialize a DVD-RAM disc, load it in the recorder. See ➡ page 20 for loading a disc.

1) During stop, press the QUICK MENU button.

The following menu appears. (The actual contents depends on the operational status of the recorder.)

e.g.

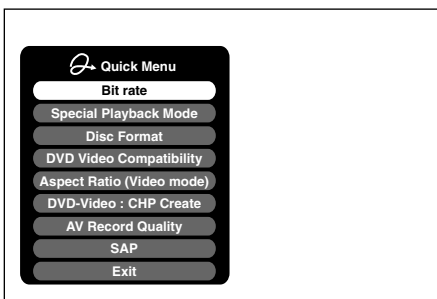

2) Press the ▲ / ▼ buttons to select “Disc format,” then press the ENTER button.

A sub menu appears on the right side.

e.g.

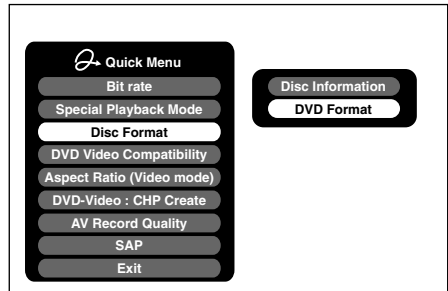

3) Press the ▲ / ▼ buttons to select “DVD Format,” then press the ENTER button.

e.g.

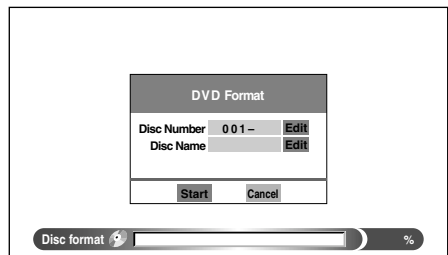

Numbering a disc

The recorder automatically numbers discs when initializing. However, you can assign a desired number (using 3 digits) and designate sides A and B on a double-sided disc. (DVD-RW discs cannot be numbered.)

- (1) Press the ▲ / ▼ buttons to select “Edit” of “Disc Number” then press the ENTER button.
- (2) Press the ▲ / ▼ buttons to select a digit.
- (3) Press the ◀ / ▶ buttons to shift.
- (4) Repeat steps (2) and (3).
- (5) Press the ENTER button.

Naming a disc

You can name a disc.

- (1) Press the ▲ / ▼ buttons to select “Edit” of “Disc Name,” then press the ENTER button. The character input window appears.
- (2) Enter a disc name following the procedure of “Entering characters” (➡ page 30).
- (3) Press the ★ button to eliminate the window.

- 4) Press the ◀/▶ buttons to select “Start,” then press the ENTER button.

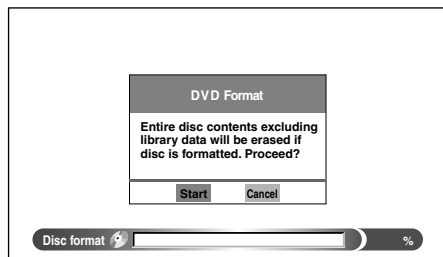

- 5) Press the ◀/▶ buttons to select “Start,” then press the ENTER button.
Initialization starts.

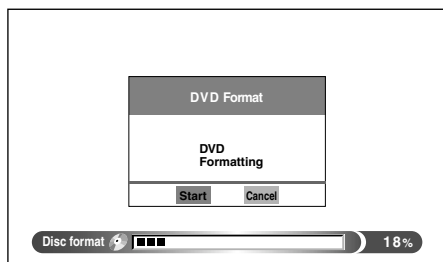

When initialization is completed, the setup window disappears.

DVD-RAM Physical Format

Physical formatting is a simple execution for a disc which cannot be used or read (or which is becoming hard to read). It may refresh such a disc for recording and playback. (There is no guarantee that all such discs will be recovered.)

“DVD-RAM logical format” process only rewrites certain data on file system and management information, however, “DVD-RAM physical format” rewrites all data on a disc, therefore it takes a much longer time to complete. For a 4.7GB single sided DVD-RAM, about 70 minutes will be necessary. While processing, all recorder operations and functions including program recording will not work until the process is finished. Also this process erases all data stored on the DVD-RAM disc.

- 1) During stop, press the SETUP button.
2) Press the ◀/▶ buttons to select “Management Settings” then press the ENTER button.

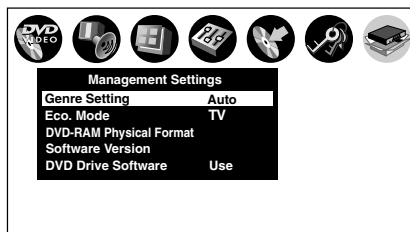

- 3) Press the ▲/▼ buttons to select “DVD-RAM Physical Format,” then press the ENTER button.
4) Press the ◀/▶ buttons to select “Yes,” then press the ENTER button to execute.

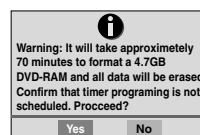

To cancel, select “No”, then press the ENTER button.

- 5) Read the message, and press the ◀/▶ buttons to select “Yes” or “No”, then press the ENTER button.

Notes





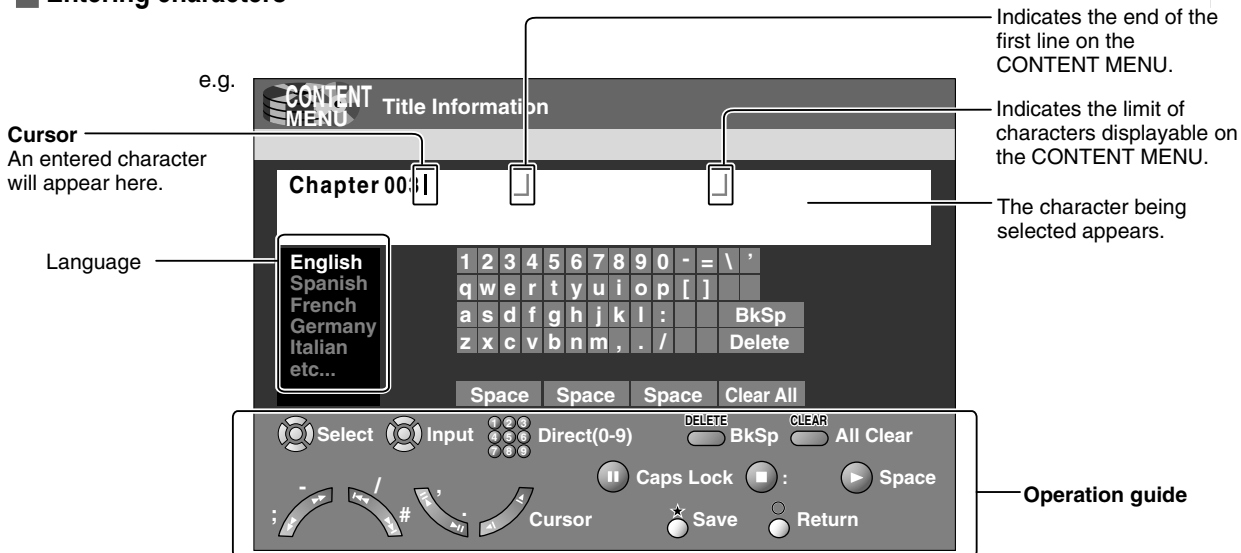



- The physical format process may fail if executed to a dirty DVD-RAM disc. Also, the disc may be difficult to record, even if it finished. Before executing DVD-RAM physical format process, be sure to confirm the disc is not dirty. Clean it if necessary. If the disc has scratches or dust beyond cleaner’s efficacy, do not execute DVD-RAM physical format process on the disc.
- The following DVD-RAM discs require physical formatting:
 - A disc which is not formatted correctly.
 - The disc which has errors during writing because of dirt on the disc, and cannot be further recorded, or cannot initialize normally.
- You need to start physical formatting from the first step again when you use a failed disc.
- Physical formatting does not work if the disc contains a lot of void beyond limitation of this recorder.
- If an error occurs in physical formatting, “ERR-01” appears in the front panel display. To turn off the message, press the DISPLAY button.

Entering characters



■ Operation guidance of the remote control

To enter the character, normally use the direction ▲ / ▼ / ◀ / ▶ buttons on the remote. About the other buttons to be used are shown on the operation guide.

-  : Shifts a cursor.
-  : Enters the number.
-  : Erases one character immediately to the left side of the cursor.
-  : Erases all the characters on the input column.
-  : Caps Lock
-  : Saves the changes on the input column and returns to the previous screen.
-  : Cancels the changes on the input column and returns to the previous screen.
-  : Enters a space.
-  : Enters a symbol.

■ Switching a language

Before entering a character, move a cursor to the language selection area by pressing the ◀ / ▶ buttons. Then press the ▲ / ▼ buttons to select a language, then press the ENTER button.

■ Entering characters

The cursor may be followed by unwanted characters. You can erase them if necessary by either of the following measures:

Erasing characters

- Erasing all the characters on the writing board
Select "Clear All" by pressing the ▲/▼/◀/▶ buttons, then press the ENTER button.
Alternatively, open the lid of the remote control and press the CLEAR button.
- Erasing one character before the cursor
Select "BkSp" by pressing the ▲/▼/◀/▶ buttons, then press the ENTER button.
Alternatively, open the lid of the remote control and press the DELETE button.

- (1) Press the **||** button to select an input mode.
- (2) Press the ▲/▼/◀/▶ buttons to select a character, then press the ENTER button.
The selected character is input on the cursor.
- (3) Repeat steps 1 and 2 to enter characters.
- (4) When finished, press ★ to save the characters.
The characters you entered appears.

Notes

- You can enter up to 64 characters.
- When unnecessary information appears, or when you want to alter the input character, press the CLEAR button to erase all, or press the DELETE button to erase an unnecessary character.

Recording a TV program

To record a TV program currently being broadcast, follow the procedures of this chapter.

■ Preparation

- Load a DVD-RAM/R/RW disc into the recorder.
 - Load a disc which has sufficient space available to record the program.
 - Make sure the loaded disc is not write-protected.
- If you record on a DVD-R or a DVD-RW disc, set "DVD Video Compatibility" (➡ page 132) to "Main" or "SAP." In DVD-R/RW recording, "Off" setting is regarded as "SAP."
- If you record on a DVD-R or DVD-RW disc, set "Aspect Ratio (Video mode)" (➡ page 132) according to recording sources.



1 Press INPUT SELECT repeatedly to select a recording source.



Each time you press the button, the indicator alternates.

Ch-: To record a TV program or CATV program.

L-1: To record a source connected to the INPUT1 jacks on the rear panel (➡ page 37).

L-2: To record a source connected to the INPUT2 jacks on the front panel (➡ page 37).

L-3: To record a source connected to the INPUT3 jacks on the rear panel (➡ page 37).

To record a program from a connected cable box or satellite receiver, set the channel to "Ch-3", "Ch-4", or "L-1" according to the connection (the same as ➡ page 39 on "INSTALLATION GUIDE").

Select the proper channel on the cable box or satellite receiver to receive the desired program.



Open the lid.

CHANNEL

2 Press the number buttons to select a channel to record.

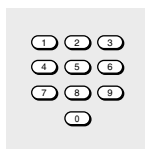

e.g. To select channel 6.

0 → 0 → 6

To select channel 12.
(Press in series.)

0 → 1 → 2

The CHANNEL buttons (↖↗) are also available.

3 Press QUICK MENU to display the Quick Menu.

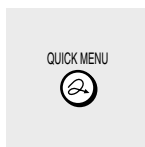

4 Press ▲ / ▼ to select “AV Record Quality,” then press ENTER.

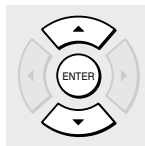

5 Press ADJUST to select the setting number.



e.g.

AV Record Quality			
DVD Setting 1 SP 4.6 DD D / M1			
Custom Setting			
Setting	Mode	Rate	Audio Quality
1	Manual	6.6	L-PCM
2	SP	4.6	DD D / M1
3	LP	2.2	DD D / M1
4	Manual	6.0	DD D / M2
5	Manual	3.2	DD D / M1

Total Recording Time: approx. 71 min.
(with 4.7 GB unused)

See ⇨ page 41 for details on “Mode”, “Rate” and “Audio Quality”.

(Continued)

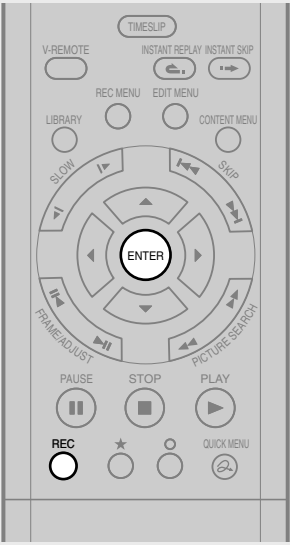

(Continued)

6 Press ENTER.

The menu disappears.

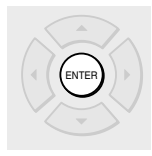

7 Press REC.

Recording starts.

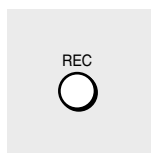

■ Selecting the recording mode

Before recording, you can select the setting of picture and sound quality. During stop mode, press the REC MODE button. By pressing the button repeatedly, you can select one from 5 settings of “AV Record Quality” appearing in the front panel display.

Notes

- During recording, you cannot change the recording parameters, such as modes, channels, etc.
- The number of titles cannot exceed 99 for any disc.
- During normal recording, you can set the programmed recording using the REC MENU.
- You cannot start recording immediately before a programmed recording starts.
- During monaural sound recording, the same sound is recorded on both the left and right channels.
- When “Audio” is set to “L-PCM”, multi-channel sound is recorded as stereo sound. When playing this recorded sound, you will hear MTS and SAP sounds simultaneously. Press the AUDIO button to select a desired sound.
- When “DVD Video Compatibility” is set to “Main” or “SAP”, the unit records the same sounds on both the left and right channels when receiving monaural sound. When receiving the bilingual sound, the selected sound, Main or SAP, is recorded on both the left and right channels.
- Depending on the disc contents, pressing the REC button may take longer time to start recording.
- When a starting time of a programmed recording comes, a recording in execution is stopped and the programmed recording starts. If you want not to stop the recording, cancel the timer program before it starts.
- Even if you set “Aspect Ratio (Video mode)” to “16:9”, images are recorded in 4:3 aspect ratio when using a DVD-R or DVD-RW disc with “Rate” set to “1.4” (Mbps).
- Be careful of a programmed recording across the change-over of Daylight-saving time (➡ page 27).

■ To stop recording

Press the **STOP** button.

■ To pause recording (to omit an unnecessary portion)

During recording, press the **PAUSE** button.

To resume recording, press it again.

Note

- Pausing recording automatically creates a new chapter division at that point.

■ To change a TV channel to be recorded

- 1) During recording, press the **PAUSE** button.
Recording pauses.
- 2) Press the **CHANNEL** buttons to change the channel.
- 3) Press the **PAUSE** button to resume recording.

■ To view a TV program while recording another

- 1) Start recording on this recorder.
- 2) On a connected TV, select the **TV** mode.
- 3) Using the channel selector of the TV, select a desired channel on the TV.

■ To reduce noise on recordings (Rec DNR)

Before recording, set "Rec DNR" (➡ page 129).

■ To set an end time of a recording which is in progress

- 1) During recording, press the **QUICK MENU** button.
The Quick Menu appears.
- 2) Press the **▲ / ▼** buttons to select "End Time" then press the **ENTER** button.
The display changes as follows:

e.g.



- 3) Press the **◀ / ▶** buttons to select an item then press the **ADJUST** button to change the value.
- 4) Press the **ENTER** button.

Notes

- By setting an end time, it is memorized as a programmed one, and the  indicator in the front panel display illuminates to indicate that the recorder holds a timer program of recording.
- The programmed end time must be set for after 5 minutes from the current time.

■ To play a title recorded on a DVD-RAM disc while recording another on it (Recorded Title Play) **DVD-RAM**

During recording, you can play a title recorded on the same disc.

- 1) While recording on a DVD-RAM disc, press the **CONTENT MENU** button.
- 2) Press the **▲ / ▼ / ◀ / ▶** buttons to select a desired title, then press the **ENTER** button.
Playback of the selected title starts.

Pressing the **STOP** button stops playback, and the content currently recorded returns. If you press the **PLAY** button, playback resumes from the location you last stopped.

Notes

- While you are using this function, the following operations/functions are not available.
 - Programmed playback (repeat playback, intro scan etc.)
 - Editing (Playlist programming, dubbing, title/chapter naming, title thumbnail setting, etc.)
- Depending on the data condition, playback may pause.

■ Creating chapters while recording

Press the **CHP DIVIDE** button.

The content is divided into two chapters at the point you pressed the button.

Note

- If you want to divide into chapters at desired points on DVD-R/RW discs, use this method. On those discs, you cannot create chapters after recording.

■ Creating chapters automatically at regular intervals

Set "DVD-Video:CHP Create" (➡ page 130).

Recording an external source

You can record programs from connected equipment on a DVD-RAM/R/RW disc.

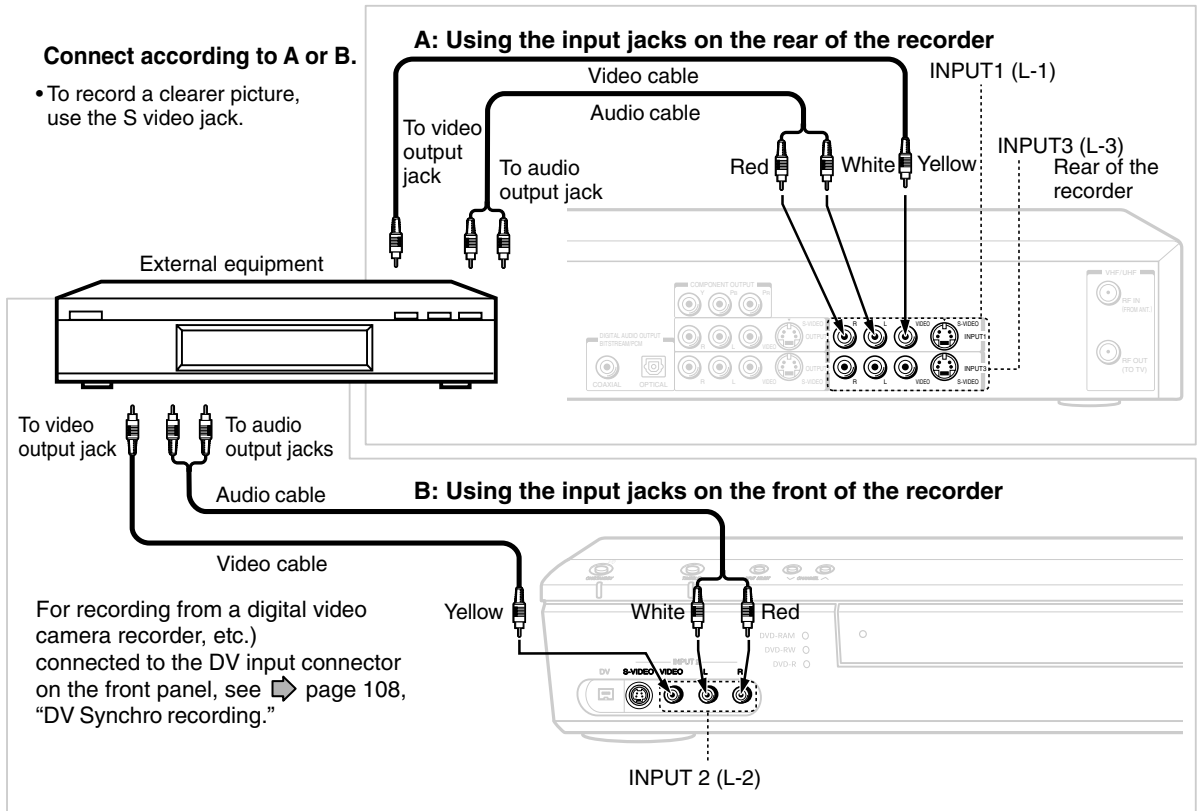

■ Preparation

- Load a DVD-RAM/R/RW into the recorder.
 - Load a disc which has sufficient remaining space to record the program.
 - Make sure the loaded disc is not write-protected.

Notes

- The audio format of the recorder does not support DVD audio discs, etc. If equipment that can play DVD audio or other high resolution discs is connected to this recorder, this unit records audio that is within the frequency range of regular audio CD's. Refer to the instructions of the connected equipment.
- When you record an external source onto a DVD-R/RW disc, set the connected equipment to output sound you want to record (if selectable such as multiplex broadcasting), as the recorder records sounds of external source in stereo onto a DVD-R/RW disc, neglecting the setting of “DVD Video Compatibility” ([page 130](#)).
- DVD-R/RW discs cannot record contents with copy restriction signal embedded (copy-protected or copy on demand contents), DVD-RAM discs can record copy once contents.
- Some satellite programs via a connected tuner may contain both 4:3 pictures and 16:9 pictures. DVD-R/RW discs cannot record such contents, under restriction of DVD-Video standard. To record them, use DVD-RAM discs.



1 Press INPUT SELECT repeatedly so that “L-1,” “L-2,” or “L-3” appears on the front panel display.

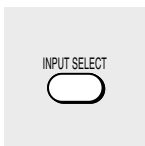

Each time you press the button, the indicator changes.

L-1: To record pictures from equipment connected to the INPUT 1 jacks on the rear panel.

L-2: To record pictures from equipment connected to the INPUT 2 jacks on the front panel.

L-3: To record pictures from equipment connected to the INPUT 3 jacks on the rear panel.

2 Start playback of the source content on the connected equipment.

3 Press REC of this recorder to start recording.

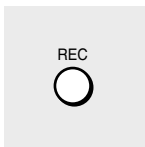

4 When recording is completed, press STOP.

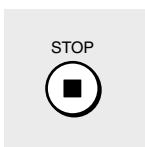

■ Notes on recording from a connected VCR or camcorder

● Check the condition of the source equipment before playing.

Set the equipment in good condition, e.g. clean the head or adjust the tracking, etc. to obtain optimum playback. Bad condition may produce noises in playback. These noises may be detected as copy protection signals, resulting in stop of recording on this recorder.

Play a source in usual mode. Avoid using any correcting or enhancing features, as they may add signals which can be detected as copy protection signals.

Source quality or tape condition beyond adjustments on the source equipment may stop a recording on this recorder.

● Do not operate the source equipment during recording on this recorder.

Operations such as pausing, resuming, fast-forwarding (CUE) and fast-reversing (REVIEW), etc. may produce noises, which may be detected as copy protection signals. Therefore, first start playback on the source equipment to confirm that the desired source can be played properly, and then start recording on this recorder.

Do not operate the source equipment during recording. After completing the desired scene, stop the recording on the recorder, and then stop the playback on the source equipment. Delete unnecessary scenes using editing functions (➡ page 100). If you want to operate the source equipment during recording, pause or stop the recording. After operating the source equipment, resume the recording as above.

● When recording from a camcorder

Follow the above notes. Be sure to power the camcorder by its AC adapter, not batteries.

Programming a recording (REC MENU)

Use the REC MENU to program a recording. It will take less time to prepare, as it provides all necessary information for recording, including estimated disc space remaining.

For more information, see “Before recording” (➡ page 26).

Be careful when you program a recording across the change-over of Daylight-saving time (➡ page 27).

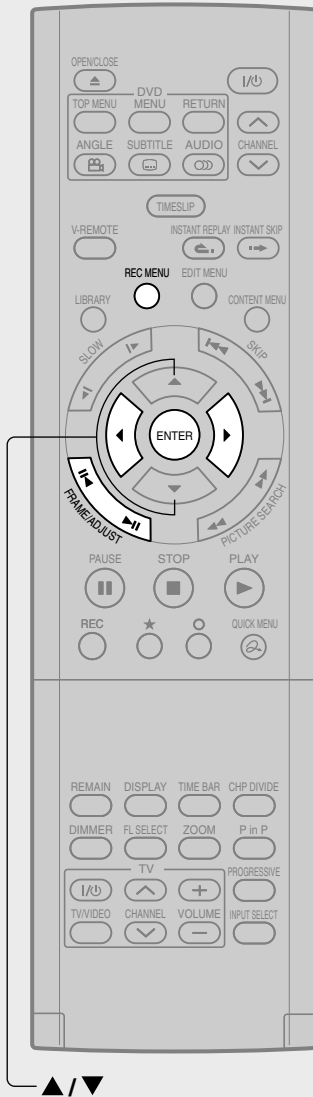

1 During stop, press REC MENU.



The REC MENU appears.

e.g.

Exec	CH	Date	Start	End	Media	Mode	Rate	Audio	Disc
---	-----	--:--	--:--	--:--	DVD	SP	4.6	DDIM1	

2 Press ENTER.



“CH” is ready for setting.

Exec	CH	Date	Start	End	Media	Mode	Rate	Audio	Disc
✓	---	-----	--:--	--:--	DVD	SP	4.6	DDIM1	

3 Select an item by pressing ◀/▶, then press ADJUST (◀/▶) to set the item.



- Refer to the setting items on the next page.
- You can also set the item by pressing the ▲/▼ button.

Exec	CH	Date	Start	End	Media	Mode	Rate	Audio	Disc
✓	1	7/9 (We)	--:--	--:--	DVD	SP	4.6	DDIM1	

4 When complete, press ENTER.



To program another recording, press the ▶ button to move to the top of the next line, then repeat steps 2 to 4.

5 Press REC MENU to exit.

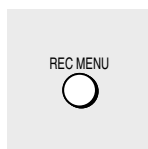

Your program is entered.

- If you want to turn off the power, press the ON/STANDBY button.

Programming a recording (REC MENU) (Continued)

Notes

- The disc tray does not close automatically, even when the recording start time comes. Set the recorder loaded an available DVD-RAM/R/RW disc beforehand.
- When there are little time before a programmed recording starts, you may not be able to start another recording.
- DVD-RAM disc playback pauses when a programmed recording starts.
- Confirm the “DVD Video Compatibility” setting. “Main” or “SAP” records main sound or sub-sound of multiplex broadcasts respectively, and does not record the other. Therefore, select “Main” or “SAP” only when you record onto a DVD-R/RW disc.
- When recording onto a DVD-R/RW disc, set “DVD Video Compatibility” (➡ page 130) to the desired recording sound for each timer program.

■ Setting items

* If you set summer time on the clock of the recorder, see the notes on ➡ page 31 in the “INSTALLATION GUIDE”.

Exec	√	A timer program with this mark will be executed. To disengage, put it off.
CH	1-125, L1-L3	Select a channel you want to record.
Date	Every Sunday to Saturday, Monday to Thursday, Monday to Friday, Monday to Saturday, everyday.	Select a date of a TV program you want to record.
Start*	0:00 – 30:59	Enter a starting time of recording. (An initial setting is 10 minutes later.) You can also use the number buttons under the lid.
End*	0:00 – 30:59	Enter an end time. (Set the timer to begin recording no sooner than 2 minutes past the current time.) You can also use the number buttons under the lid.
Media	DVD	Fixed. (Unselective.)
Mode (Picture Quality)	SP	Standard setting of recording time and picture quality. (Not applicable when “L-PCM” is selected.)
	LP	For longer recording, but inferior to “SP” in picture quality. (Not applicable when “L-PCM” is selected.)
	Manual	Customized setting of rate (bit rate).
	Auto	To set a rate automatically according to the remaining volume of the disc. (If the disc does not have room for the TV program, the program cannot be recorded to the end.)
Rate (Bit Rate)	1.4, 2.0-9.2	Not applicable when “SP”, “LP” or “Auto” is selected. You can set a rate at intervals of 0.2Mbps from 2.0 to 9.2. (The upper limit of the value depends on the “Sound Quality” setting.)
Audio	□□ D /M1	Standard setting.
	□□ D /M2	Superior to □□ D /M1. Recommended for recording music programs.
	L-PCM	Uncompressed original digital audio. Equal quality to audio CD, but recordable time will be shorter.
Disc		A programmed recording onto a Reservation Disc is marked with an icon.

The digital recording technology for consumer products of Dolby Laboratories is used for □□ D /M1 and □□ D /M2. Dolby Digital 192 kbps is set for □□ D /M1 and Dolby Digital 384 kbps for □□ D /M2.

Notes

- “Start” and “End” accept time up to 30:59. If you enter a time over 24:00 and press the ENTER button. “Date” will gain one day, and the time will be corrected to 0:00 - 6:59.
- See ➡ page 50 for details on “Mode”, “Rate”, and “Audio”.
- VCR Plus+ programming is also available. See ➡ page 46.
- If you record with setting “Rate” to about 4.0 Mbps or below, the recorded pictures may not be played properly if change the playback speed. There will be noise, and the picture quality is lower than other rate settings.
- Do not change the “TV/CATV” selection of the Initial Settings while a recording is programmed. If you want to change it, cancel the program recording. After then, make the programing again if necessary.

■ Suggestions for the picture quality setting

- **For normal recording or when you cannot decide which mode to choose.**
Select "SP."
- **When you do not have to preserve the recorded content longer.**
Select "LP." Inferior to "SP" in picture quality, but it can record longer.
- **To record a high picture quality**
Select "Manual" to set a desired bit rate. The higher the bit rate, better the picture quality is, but shorter the recording length becomes. We recommend that you set about 6.0 Mbps to 6.8 Mbps.
- **To fill the disc**
Select "Auto." A bit rate is calculated automatically according to the remaining volume of the disc. Some contents may not be recorded on the disc even if you select this function. This is not the function to make full use of the remaining space capacity.

■ Setting the details for every timer program

You can specify detail items for each of your timer program.

1) Press the QUICK MENU button at step 3 on

➡ page 39.

The Quick Menu is displayed.

e.g.

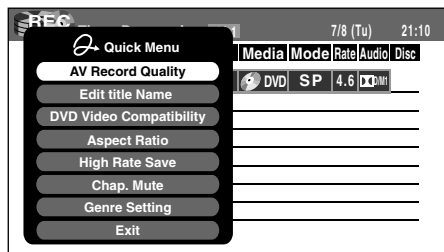

2) Use the ▲ / ▼ buttons to select an item and press ENTER.

For details, see "Quick menu items."

3) Use the ▲ / ▼ buttons to make a selection, and press ENTER.

The selection you have made for the timer program is shown at the bottom of the display.

Quick menu items

AV Record Quality

Select an item from registered selections (1-5) for the picture and audio quality.

Edit Title Name

Enter a name for the timer program.

Use the input screen to enter a name (➡ page 30).

DVD Video Compatibility

DVD-RW

DVD-R

When recording onto a DVD-R/RW disc, make this selection (➡ page XXX) for each timer program. "Off" setting is neglected and regarded as "Main" in DVD-R/RW recording.

Aspect Ratio

DVD-RW

DVD-R

Select the aspect ratio when recording onto a DVD-R/RW disc. (➡ page 130)

High Rate Save

Use this feature when you want to save space while using the best picture quality rate for recording. You can normally use 9.2 Mbps for recording and reduce the rate temporarily for the portion where the high rate is not required if the picture is fairly constant.

Off : This feature is disabled and the normal recording is performed.

On : This feature is enabled.

Notes

- When the audio quality is set to "L-PCM", the picture quality is set to "Manual 8.0 Mbps". When the audio quality is set to any other selection, the picture quality is set to "Manual 9.2 Mbps".
- While this is set to "On," you cannot change the mode or rate.
- The space availability may not change, depending on the picture contents.

Chap. Mute

DVD-RAM

This feature automatically creates divisions for chapters when no audio (no audible sound) portion is found.

For example, when you have recorded a programme of music clips, you can use this feature to jump to the beginning of a clip during playback. It does not create completely independent chapters or automatically divide into chapters when no audio portion is found.

Off : This feature is disabled.

On : Division for chapters when no audio portion is found.

Notes

- Divisions for chapters may not be created, depending on the contents of the programme or the condition of no audio portion, or it may be created at different positions. A division for a chapter may be created within a music clip.
- Depending on the specification made for the recording sound level, a division for a chapter may not be created or it may be created at different positions.
- Setting "On" may create many chapters, and their number may reach the maximum. No more chapters cannot be created in any way. In this case, decrease the chapters, for example by combining chapters (➡ page 102).
- This feature is not available on DVD-R/RW discs. To create chapters automatically during recording on DVD-R/RW discs, set "DVD-Video:CHP Create." (➡ page 130).

Genre Setting

You can set a genre before setting programmed recording.

To see the registered list, refer to Genre Setting (➡ page 131).

Set the genre according to recording contents.

■ Shifting a time period of a recording (Time Shift)

If a prior TV program extends beyond its scheduled time and into one that you programmed, you can shift the programmed start and end time of the recording.

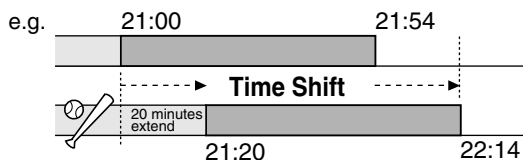

- 1) Press the **REC MENU** button.
The REC MENU appears.
- 2) Press the **▲ / ▼** buttons to select a timer program you want to shift the time period.
- 3) Open the lid of the remote control and press the **EXTEND** button.
“Start Time” and “End Time” are ready to be input.
- 4) Press the **EXTEND** button repeatedly.
Each time you press the button, “Start Time” and “End Time” is shifted in 10 minutes intervals to, up to 60 minutes later.
- 5) Press the **ENTER** button.
- 6) Press the **REC MENU** button to exit.

Note

- After having shifted the time of a timer program which will be repeated daily or weekly, restore the time if necessary.

■ Adding a timer program

- 1) Press the **REC MENU** button.
The REC MENU appears.
- 2) Press the **▼** button to select a blank line, then press the **ENTER** button.
- 3) Press the **◀ / ▶** buttons to select the item, then press the **ADJUST** button to set the item.
- 4) When complete, press the **ENTER** button.
- 5) Press the **REC MENU** button to exit.

Note

- While the recorder is preparing for or executing a programmed recording, you cannot add a timer program which will start within 5 minutes and 15 seconds from the current time.

■ Deleting a timer program

- 1) Press the **REC MENU** button.
The REC MENU appears.
- 2) Press the **▲ / ▼** buttons to select a timer program you want to delete.
- 3) Press the **QUICK MENU** button.
The Quick Menu appears.
- 4) Press the **▲ / ▼** buttons to select “Program Cancel”, then press the **ENTER** button.
Check the message, then delete the entry.
- 5) Press the **REC MENU** button to exit.

Note

- You cannot delete a timer program while another is executed.

■ Correcting a timer program

- 1) Press the **REC MENU** button.
The REC MENU appears.
- 2) Press the **▲ / ▼** buttons to select a timer program you want to change, then press the **ENTER** button.
- 3) Press the **◀ / ▶** button to select an item, then press the **ADJUST** button to set the item.
- 4) Press the **ENTER** button.
The modification is registered.
- 5) Press the **REC MENU** button to exit.

Important

- You cannot correct a timer program within 5 minutes before the recording start time. You can only delete the timer program.

Note

- You can program a timer recording whose start time has already passed, unless the other program recording will start within 5 minutes. A portion of the program before the recording starts cannot be saved.

■ Remaining volume

1) Press the REC MENU button.

The REC MENU appears.

2) Press the QUICK MENU button.

The Quick Menu appears.

3) Press the ▲ / ▼ buttons to select “Disc Budget Calculation” then press the ENTER button.

The Disc Budget Calculation menu appears.

4) Press the ▲ / ▼ buttons to select a timer program, then press the ENTER button or press the ADJUST button.

The recorder calculates on a bar graph how much a specific program (identified by a check mark) will occupy on the disc.

Pressing the ADJUST button can display or remove the check mark.

e.g.

CH	Date	Start	End	Media	Mode	Rate	Audio	Result
3	7/8(Tue)	11:30	11:50	DVD	MN	6.0	□□□□□	○
10	7/8(Wed)	21:30	22:00	DVD	MN	6.0	□□□□□	○
42	7/11(Fri)	22:30	23:30	DVD	LP	2.2	□□□□□	○
4	7/12(Sat)	20:30	23:30	DVD	SP	4.4	□□□□□	✕

Legend: Elapsed Selected (current) Available

Selected entry

Available disc volume

When the entry item is marked X, the recording does not end. Change the setting.

5) Correct the parameters of the timer program if necessary.

(Skip to step 7 if you do not need this.)

You can change “Mode”, “Rate”, and “Audio”.

Select an item you want to modify and press the ENTER button. The item will be ready to be altered. Press the ADJUST button to modify. When complete, press the ENTER button.

6) Press the ★ button.

Program modification is registered.

7) Press the REC MENU button to exit the GUI.

Notes

- When a Reservation disc is inserted in the recorder (▶ page 48), you cannot check the remaining volume of other discs.
- The nearest 8 programs are calculated at a time.
- While the recorder is preparing for or executing a programmed recording, any program modification cannot be registered.
- Available disc volume is not displayed for a DVD-R/RW disc on which DVD-Video finalize process was executed.

■ To stop a programmed recording

To finish,

Press the ■ button on the front panel twice.

When you press it once, a message appears. While the message is displayed, press the ■ button once again.

To pause recording,

Press the || button on the front panel.

To resume recording, press it again.

■ Turning the power off automatically after completing a programmed recording

1) While executing a programmed recording, press the QUICK MENU button.

The Quick Menu appears.

2) Press the ▲ / ▼ buttons to select “Auto Power Off” then press the ENTER button.

■ Keeping the power on even after the programmed recording finished

If the recorder turns itself on to execute a programmed recording, it will turn itself off after finishing the recording. You can restrict this and keep the recorder powered on.

1) While executing a programmed recording, press the QUICK MENU button.

2) Press the ▲ / ▼ buttons to select “Continue Power On” then press the ENTER button.

■ Delaying the end time of a programmed recording while executing it

While executing a programmed recording, open the lid of the remote control and press the EXTEND button.

The first press displays the programmed end time (in the front panel display).

Each time you press the button, it is delayed 10 minutes, up to 60 minutes.

Notes

- Pressing a button except EXTEND in the above procedure will set the currently selected delay.
- You cannot delay the end time of a programmed recording which will end within 1 minute from the current time.
- Even if you delay the end time of a programmed recording, the recording will stop when the disc is exhausted.

VCR Plus+ Recording

You can program a recording simply by entering the corresponding PlusCode® numbers.

■ Preparation

- Make sure that "Time & Date Setting", "TV/CATV", "Channel Setting" and "Guide Channel Setting" are set correctly (▶ page 28, "INSTALLATION GUIDE").
- Load a DVD-RAM/R/RW disc in the recorder.
 - Load a disc which has space available to record the program.
 - Make sure the loaded disc is not write-protected.

For cable box or DSS® satellite receiver users:

- Finish the Cable Box/DSS® Setting (▶ page 38, "INSTALLATION GUIDE"), and turn on the cable box or DSS® satellite receiver.

5PM (FAM) POPEYE — Cartoon 725692

(HBO) MAKING OF A CHAMPION 237945

A look at gymnast and Olympic hopeful Kim Zmeskal from novice to seasoned competitor.

(NIK) HEY DUDE — Children (793571)

One of Ted's teachers stays at the ranch.

(USA) MY TWO DADS — Comedy (586858)

5:35 (TBS) GOOD TIMES — Comedy 2261858

PlusCode®
number

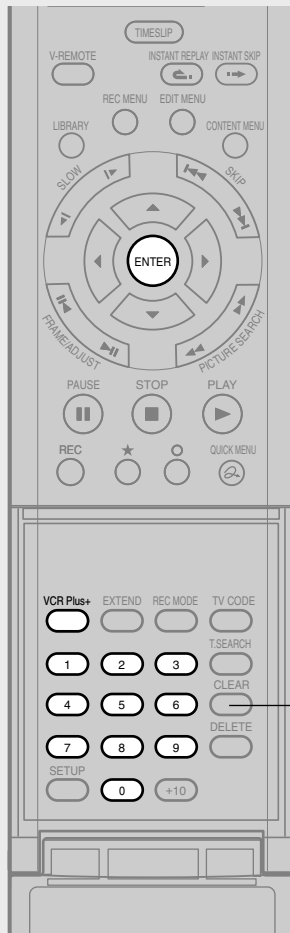

Open the lid.

CLEAR

1 Open the lid of the remote control, and press VCR Plus+.

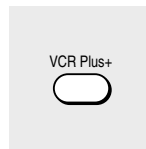

The REC MENU and VCR + setting display appear.

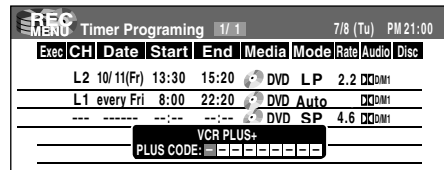

2 Press the appropriate number buttons to enter the PlusCode.

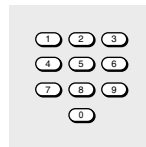

- Refer to newspapers or TV magazines to obtain PlusCodes.
- To correct entered digits, press the CLEAR button to erase them and press the number buttons to re-enter again.

Note

- When you enter the number starting from 0, a 9-digit number is entered.

3 Press ENTER.



The entered program is highlighted.



4 Select an item by pressing ◀/▶, then press ADJUST (◀▶) to set the item, if necessary.



For details about items, see ➤ page 41.

Note

- If "Cable Box/DSS" is set to "Use" (➤ page 38, "INSTALLATION GUIDE"), "3", "4" or "L1" is automatically entered in "CH" according to your setting of "Output Channel". To record a desired channel, be sure to change the "CH" setting to it.

5 Press ENTER.

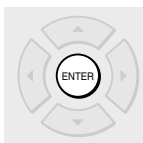

6 To enter another program, repeat steps 1 to 5.

7 After completing all your entries, press REC MENU.



The REC MENU disappears.

Notes

- The maximum timer program capacity is 32. Any new program will be rejected if the recorder is full. To enter a new program, you must cancel an existing one (➤ page 43).
- Depending on the program, an actual recording may continue a few minutes longer than programmed.
- Entries made under the following conditions will be rejected.
 - when an entry is for a non existing program.
 - when the digit order of an entry is in error.
 - when the guide channel has not yet been set.
- To erase a timer program, press the QUICK MENU button to display a Quick Menu on the REC MENU. For details, see "Deleting a timer program" (➤ page 43).
- While displaying the REC MENU, the VCR Plus+ programming is not available.
- When recording onto a DVD-R/RW disc, set "DVD Compatible Mode" (➤ page 41) to the desired recording sound for each timer program.
- In the event of a broadcast delay, the next program starts even if when the start time arrives prior to the end of the previous program.

Others

Reservation Disc (Program Record Lock)

DVD-RAM

This function is convenient when you wish to record multiple serial related programs on the same disc.

The disc on which you write the reservation data is called "Reservation Disc." A Reservation Disc may contain only one reservation.

Once a Reservation Disc is created, you cannot use other discs to record the same serial program. The Reservation Disc can be used only for recording a program reserved for the Reservation Disc.

As an example, if you create a Reservation Disc for a serial broadcast from 9 pm to 10 pm on Monday, then you can use that disc only for that program. When you attempt to make a reservation or record that serial, the recorder will ask you to insert that Reservation Disc.

1) Load a DVD-RAM disc.

2) Press the REC MENU button.

The REC MENU appears.

3) Press the ▲ / ▼ button to select the program you want to record.

4) Press the QUICK MENU button.

The Quick Menu appears.

5) Press the ▲ / ▼ buttons to select "Program Record Lock" then "Yes" and press the ENTER button.

After the recording data is entered, a Reservation disc icon appears on the REC MENU.

If the Reservation Disc is not loaded, the entry data and icon are displayed in gray.

● To cancel the Resevaion Disc setting

Load the disc you want to cancel and select the recording option on the REC MENU. Press the QUICK MENU button to select "Unlock Program Record" then "Yes", and press the ENTER button.

● To delete the information of a Reservation Disc

If you lose a Reservation Disc, delete the information of the Reservation Disc.

Press the QUICK MENU button to select the program of which data you want to delete, and press the QUICK MENU button. Select "Program Record Unlock" and then "Cancel Selecting List."

If no programmed recording is set on the loaded disc, press the QUICK MENU button to select "Program Record Unlock" and then "Unlock Selected Program".

If you schedule a date for programmed recording on the Reservation Disc, the recording information is automatically deleted after the programmed recording is completed.

● To stop the Reservation Disc recording

Press the STOP button on the front panel once. The message appears.

While it is displayed, press the STOP button again. Recording stops.

■ If the start time of a programmed recording of a Reservation Disc comes while recording

The currently executed recording has priority. The programmed recording of the Reservation Disc does not start.

To delete recorded content

DVD-RAM DVD-RW DVD-R

Important note

Any deleted title/chapter (original) cannot be restored. Before deleting, be sure to check contents on the disc.

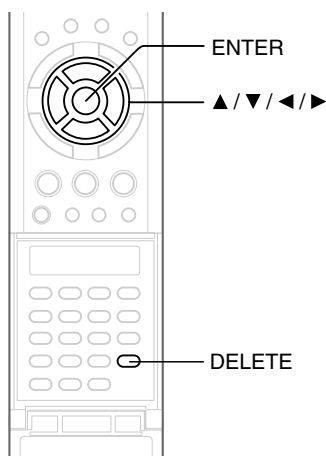

- 1) Perform steps 1 and 2 in “Playing recorded contents (CONTENT MENU)” (➡ page 53) to select a title (chapter).
- 2) Open the lid of the remote control and press the **DELETE** button.
Alternate method:
Press the **QUICK MENU** button, then press the ▲ / ▼ buttons to select “Title Delete” (“Chapter Delete”) and press the **ENTER** button.
- 3) Read the message and press the ◀ / ▶ buttons to select “Yes,” then press the **ENTER** button.

Notes

- Deleting a title (a chapter) decreases the numbers of the succeeding titles (chapters).
- A chapter of about 5 seconds or shorter may not be deleted. Deleting a short chapter may not change the display of the available disc volume.
- Deleting a playlist (➡ page 82) title/chapter does not affect the original title/chapter.
- Deleting an original (➡ page 82) title/chapter affects all the corresponding playlist title/chapters.
- Deleting all chapters in a title erases the title itself.
- Chapters in a title which contains still pictures cannot be deleted.
- On a DVD-R/RW disc, deleting is not possible if the disc is finalized (➡ page 104).
- Chapters in a DVD-R/RW disc cannot be deleted.
- On a DVD-RW disc, only a title last recorded can restore the disc capacity by being deleted.
- On a DVD-R disc, deleting cannot restore the disc capacity.

To protect recorded content

DVD-RAM

You can protect recorded content from unexpected deletion.

Protection is provided for each title (original).

- 1) Perform steps 1 and 2 in “Playing recorded contents (CONTENT MENU)” (➡ page 53) to select a title.
- 2) Press the **QUICK MENU** button, and press the ▲ / ▼ buttons to select “Title Information”. Then press the **ENTER** button.
- 3) Press the **QUICK MENU** button, and press the ▲ / ▼ buttons to select “Lock” and then press the **ENTER** button.
The mark  appears.

Notes

- To cancel protection, repeat this procedure.
- Disc initialization erases all titles on a disc even if they are protected.

Technical Information

● About recording time

The recording time of a typical VCR (Video Cassette Recorder) is determined by the length of a video tape and recording speed (SP, LP, etc.). Video tapes with various recording times are available in the market. On the other hand, the recording time of a DVD-RAM/R/RW depends on the bit rate (Mbps: amount of data transmitted per second), which can be varied in MPEG2 (Moving Picture Experts Group2) compression technology.

As an example, when you pour water into a bucket from a faucet, the more you turn it on to make water flow, the sooner the bucket is filled with water. On the other hand, the less you turn it on, the more slowly the bucket is filled. The DVD-RAM/R/RW is, so to speak, such a bucket, and the degree you turn the faucet is bit rate, the time required to fill the bucket with water is the recording time available for a disc. The higher you set the bit rate (making much more water flow), the sooner a disc is filled. Consequently, the recording time becomes shorter. The lower you set the bit rate, the longer time it takes to fill a disc.

● About picture quality (SP, LP, Auto, Manual mode)

The higher you set the bit rate, the more the volume of information for the picture. The lower the bit rate, the less the volume of picture information. However a high bit rate does not always mean that the picture quality is high. The difference between the 1.4 Mbps and 9.2 Mbps is obvious, but when comparing similar bit rates, the difference may be insignificant. Generally when you set the bit rate low for longer recording time, the data volume shortage will result in a lack of detail information. As a result, the picture quality is decreased (more noticeable with dynamically moving images). For example, square noises (block noise) may occur in a scene with fast action or a scene with light and shadows, such as a water surface.

This recorder has two settings, 2 hour recording at "SP" mode or 4 hour recording at "LP" mode (both assume a blank 4.7 GB DVD-RAM). It is recommended to consider the "SP" mode as a standard mode and use the "LP" mode when you want to record for long time regardless of the picture quality. If you want to record for about 2 hours or are uncertain which one to select, select the "Auto" mode.

On a blank 4.7 GB DVD-RAM disc, the "Auto" mode automatically sets the appropriate bit rate corresponded to the recording time from about 1 hour to up to 2 and a half hours so that you can achieve the best picture quality. If a part of a DVD-RAM disc has already been recorded, the "Auto" mode sets the bit rate suitable for the remaining space on the disc. (The picture quality is determined referring the remaining space just before recording. When the remaining space is scarce in the disc, the picture quality may decrease from what you set beforehand or the recording may stop halfway.) "Auto" mode is available also on DVD-R/RW recordings.

When you want to record a music program or animation with high picture quality, it is recommended that you select the "Manual" mode. If you select more than 6 Mbps, you can usually record with considerably higher picture quality. However the higher you set the bit rate, the shorter the recording time.

● D /M1, D /M2

Sound recording format onto DVD-RAM discs. When recording, sounds are converted into digital signals and compressed. In playback, they are extracted to the original sound. The standard differentiates D /M1 and D /M2 in data volume to use. D /M1 and D /M2 are applied the digital recording technology for consumer products of Dolby Laboratories. Dolby Digital 192 kbps is set for D /M1 and Dolby Digital 384 kbps for D /M2.

● L-PCM (Linear PCM)

Sound recording format, like Dolby Digital. However, sounds are converted into digital signals and recorded as they are without compression. This process requires more data than Dolby Digital.

Playback

Play your favorite contents.

- **Introduction and notes**
- **Playing recorded contents (CONTENT MENU)**
- **Playing a DVD video disc**
- **Pausing a TV broadcast to resume later**
- **Playing a TV program currently being recorded**
- **Playing at various speeds**
- **Locating by entering the number**
- **Using the graphic remote control (Virtual Remote)**
- **Watching a TV broadcast in the sub window (P in P Playback)**
- **Selecting the camera angle**
- **Selecting Subtitles**
- **Zooming a picture**
- **Selecting the Sound**
- **Checking the current status and settings**
- **Functions in a Quick Menu**

Information on playback

The operation procedure depends on the kind of disc. See the respective pages for basic procedure to play the disc.

■ To play contents recorded onto a DVD-RAM disc

Playing recorded contents (CONTENT MENU) (➡ page 53)

■ To play a DVD video disc

Playing a DVD video disc (➡ page 59)

■ To play a DVD-R/RW disc

DVD-R/RW discs recorded on this recorder

Playing recorded contents (CONTENT MENU) (➡ page 53)

DVD-R/RW discs recorded on other devices

Playing a DVD video disc (➡ page 59)

DVD-R/RW discs in DVD-VR mode

Playing a DVD-RW disc recorded in DVD-VR mode (➡ page 58)

■ To switch the picture to view TV broadcasts

Press the STOP button to stop playback.

■ To start recording

Press the STOP button to stop playback.

Then press the REC button to start recording.

■ Screen Protection

If you pause playback or display a menu and leave it still for about 15 minutes, the recorder switches the output picture source to a TV broadcast or connected equipment.

A still picture may be displayed after all titles are played. In this case, the screen protection activates after about 10 seconds.

Notes

- Do not move the recorder during playback. It may damage the disc.
- Occasionally the picture may stop at the last scene, or the main menu may appear after playing. If you display a still picture such as the main menu on the TV screen for a prolonged period, the TV may be damaged (image burn). To prevent this, press the STOP button to stop playback.
- A still picture for about 15 minutes while the TIMESLIP indicator illuminates, will return to normal playback. If the playback is completed, a still picture of the title end will continue unless you press the TIMESLIP button.

Playing recorded contents (CONTENT MENU)

Titles and chapters recorded on a DVD-RAM/RW disc are displayed in thumbnail view, so that you can easily locate a desired one.

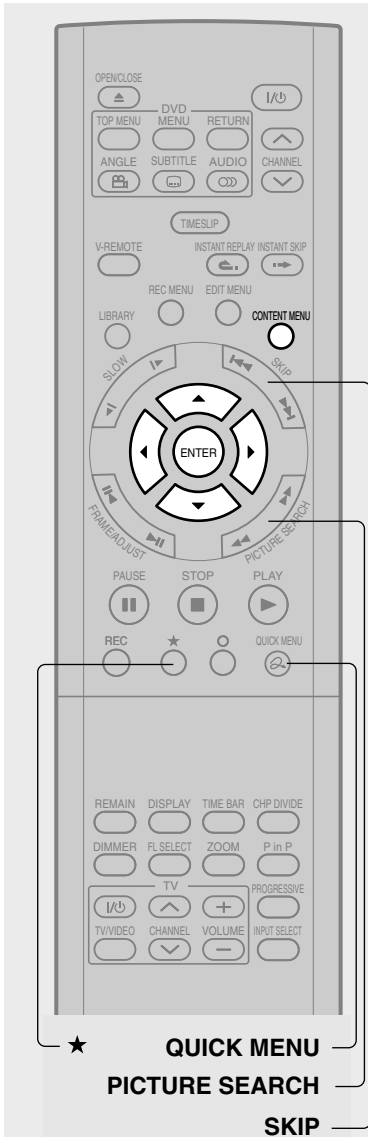

1 During stop or playback, press CONTENT MENU.

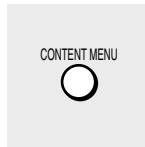

The following CONTENT MENU (Title List) appears.

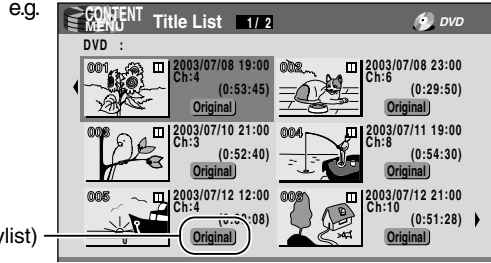

Attribution
(original/playlist)
➡ page 82

2 Press ▲ / ▼ / ◀ / ▶ to select a title (chapter).

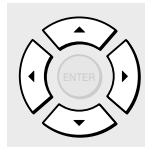

You can view succeeding or prior pages by pressing the PICTURE SEARCH (◀◀ / ▶▶) button.

To select a chapter, select a title and press the ★ button.

The Chapter List appears.

By pressing the ★ button again, you can return to the Title List.

3 Press ENTER.



Playback starts from a selected title (chapter).

Notes

- In a CONTENT MENU, titles (Original) precede titles (Playlist), in order from the oldest one respectively.
- To turn off the CONTENT MENU, press the CONTENT MENU button. Absence of operations for longer than about 15 minutes also turns off the CONTENT MENU.
- The mark **||** is displayed in every thumbnail when "Title Play" (➡ page 128) is set to "Title Resume". When set to "Serial Playback", it is displayed in a thumbnail last operated.
- You can change a thumbnail picture. See ➡ page 95.
- You cannot display the CONTENT MENU for DVD-R/RW discs recorded on other devices.
- For playing a recorded title while recording another, see ➡ page 35.
- A black thumbnail with "Recording" means that the title is being recorded or its recording will start within 15 seconds. This thumbnail cannot start playback.

■ To stop playback

Press the STOP button.



■ To pause playback (still playback)

Press the PAUSE button.



To resume normal playback, press the PLAY button or the PAUSE button.

Note

- Sound is muted during still mode.

■ Resuming playback from the location last stopped (Title Resume)

The recorder memorizes the location you last stopped playback to resume there.

To use this function, set "Title Play" (➡ page 128) to "Title Resume." The recorder will memorize the location you last stopped at in each title, so you can resume playback there. For example, if there are 6 titles, you can start each of them as if you had stored 6 video tapes in the recorder.

- **To return to the beginning of the title**
During playback, press the QUICK MENU button, then press the ▲ / ▼ buttons to select "Restart Title," then press the ENTER button.
- **To play another title**
Press the CONTENT MENU button to display "CONTENT MENU Title List," then select a title.

You can make the recorder memorize only the very last point, regardless of the number of titles. Set "Title Play" (➡ page 128) to "Serial Playback."

- **To return to the beginning of the title**
Press the SKIP (⏮) button repeatedly until the beginning of the title appears.
- **To play the other title**
Press the SKIP (⏮ / ⏭) button repeatedly.

Notes

- Depending on the status or the contents, playback may not start from the location last stopped, but instead another location. For example, from the beginning of the disc or title.
- Depending on the disc, there may be a slight difference between the location the recorder memorized and the actual location where playback starts.

■ Playing the digest (Skip Search)

DVD-RAM

This feature repeats playback of about 5 seconds and skip of 1 minute from the beginning to the end of a recorded title, so that you can view the digest of it.

- 1) **Perform steps 1 and 2 on ➡ page 53, and select a title that you want to view the digest.**
- 2) **Press the QUICK MENU button.**
The Quick Menu is displayed.
- 3) **Press the ▲ / ▼ buttons to select "Special Playback Mode", then press the ENTER button.**
- 4) **Press the ▲ / ▼ buttons to select "Skip Search", then press the ENTER button.**
The Skip Search starts.

Notes

- This feature can be used only one title (original) recorded on a DVD-RAM disc.
- While using this feature, you cannot use speed-related functions such as fast forward or fast reverse.
- If you press the ENTER button while using this feature, the normal playback starts.
- To cancel this feature, press the STOP button twice.

■ Viewing the first scenes of titles (Original) (Intro Scan) DVD-RAM

- 1) After step 1 on  page 53, press the **QUICK MENU** button.
The Quick Menu appears.
- 2) Press the **▲ / ▼** buttons to select “Special Playback Mode”, then press the **ENTER** button.
- 3) Press the **▲ / ▼** buttons to select “Intro Scan”, then press the **ENTER** button.
The recorder plays the first 5 seconds of each title beginning from title 1.
You can go forward or back by pressing the **SKIP** buttons.
▶▶ : to go to the next title.
◀◀ : to go back to the current title.
Press twice to go back to the previous title.
- 4) When you find a desired title, press the **ENTER** button.
The selected title is played.

Notes

- To stop Intro Scan, press the **STOP** button twice.
- This feature can be used only titles (Original) recorded on a DVD-RAM disc.

■ Playing all titles (original/playlist) in a disc (All ORG Title Play) DVD-RAM

Set “Title Play” ( page 128) to “Serial Playback”. You can play all titles in a DVD-RAM disc in the order of the thumbnails on the **CONTENT MENU**, as if they were recorded in one video tape.

■ Playing all titles (original) in a disc (All ORG Title Play) DVD-RAM

You can play all original titles in a DVD-RAM disc in the order of the thumbnails on the **CONTENT MENU**, as if they were recorded in one video tape.

- 1) During stop, press the **QUICK MENU** button.
The Quick Menu appears.
- 2) Press the **▲ / ▼** buttons to select “Special Playback Mode”, then press the **ENTER** button.

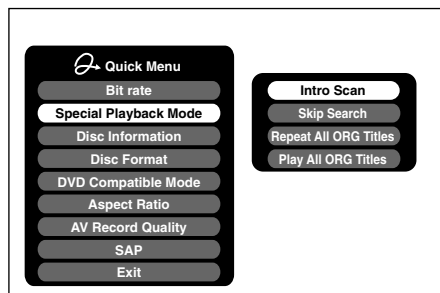

- 3) Press the **▲ / ▼** buttons to select “Play All ORG Titles”, then press the **ENTER** button.

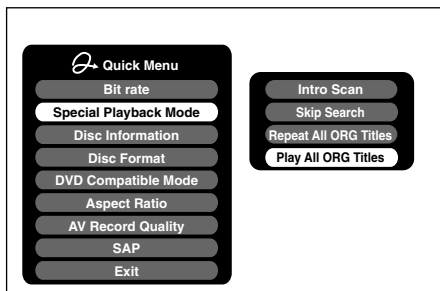

Playback starts from the beginning of title 1.

Notes

- To stop All ORG Title Play, press the **STOP** button twice. (However, doing this when you are playing a title recorded in a DVD-RAM disc while recording on the DVD-RAM disc ( page 35) will stop the recording.) Alternatively, press the **QUICK MENU** button to display the quick menu, and press the **▲ / ▼** buttons to select “Quit All ORG Title Play” and press the **ENTER** button.
- When the last title is complete, All ORG Title Play stops.
- If you select “Repeat All ORG Titles” at step 3), All ORG Title Play repeats.
- A location where you last stopped All ORG Title Play is memorized. Playback will resume from there.

Playing recorded contents (CONTENT MENU) (Continued)

■ **Checking the background information on a selected title**

- 1) **At step 2 on page 53, select a title (chapter) then press the QUICK MENU button.**

The Quick Menu appears.

- 2) **Press the ▲ / ▼ buttons to select “Title Information”, then press the ENTER button.**

Detailed information of a selected title (chapter) appears.

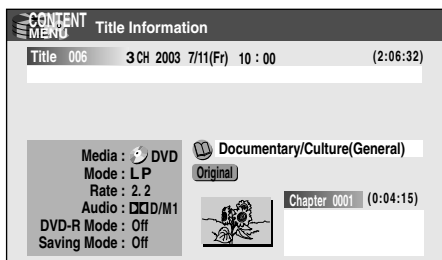

Changing the title information:

- 1) **While the “CONTENT MENU Title Information” is displayed, press the QUICK MENU button.**

The Quick Menu appears.

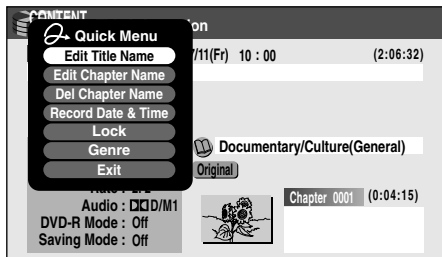

- 2) **Press the ▲ / ▼ buttons to select an title, then press the ENTER button.**

Edit Title Name:

The text entry screen is displayed.

Following the procedure on page 30, enter a new name for the title.

Edit Chapter Name:

(First press the PICTURE SEARCH (◀◀/▶▶) button to display the chapter you want, then select this item.)

The text entry screen is displayed.

Following the procedure on page 30, enter a new name for the chapter.

Del Chapter Name:

(First press the PICTURE SEARCH (◀◀/▶▶) button to display the chapter you want, then select this item.)

Record Date & Time:

The recording date is highlighted so that you can correct the digits.

Lock:

Set the protection for the currently selected title. The protection icon “🔒” appears. (page 49)

Genre:

The submenu appears.

Press the ▲ / ▼ buttons to select a genre, then press the ENTER button.

A name of the selected genre and the icon appear.

Notes

- To change the title information, be sure to load a DVD-RAM/R/RW disc which contains the desired title.
- You may not be able to change the title name, etc. of a DVD-R disc, if the disc is in a certain condition such as a scanty remaining space.
- You cannot set the protection of titles in DVD-R/RW discs.
- By pressing the O button, you can return to the previous display.
- To exit these steps, press the CONTENT MENU button.

■ Viewing information of a loaded disc

- 1) Press the **CONTENT MENU** button.
The CONTENT MENU appears.
- 2) Press the **QUICK MENU** button.
The Quick Menu appears.
- 3) Press the **▲ / ▼** buttons to select “Disc Information”, then press the **ENTER** button.
You can view information on a loaded disc.

e.g.

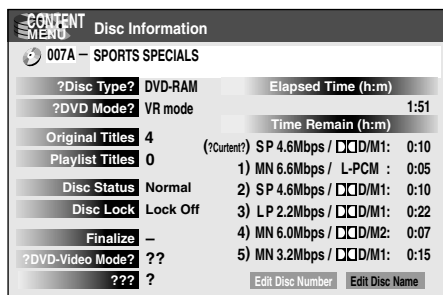

Changing the disc information:

You can change the number or name of a DVD-RAM disc.

- 1) Press the **◀ / ▶** buttons to select “Edit Disc Number” or “Edit Disc Name”, then press the **ENTER** button.
- 2) Following the procedure on page 30, enter a new name for the disc.
To change the disc number, press the **ADJUST** button.

Notes

- You cannot change the disc name of a blank DVD-R disc. After recording, change the disc name.
- You may not be able to change the disc name of a DVD-R disc, if the disc is in a certain condition such as a scanty remaining space.

■ Changing the order of the titles

You can change the order or sort the titles by genre.

- 1) Press the **CONTENT MENU** button.
The CONTENT MENU appears.
- 2) Press the **QUICK MENU** button.
The Quick Menu appears.
- 3) Press the **▲ / ▼** buttons to select “Display Changeover”, then press the **ENTER** button.
e.g.

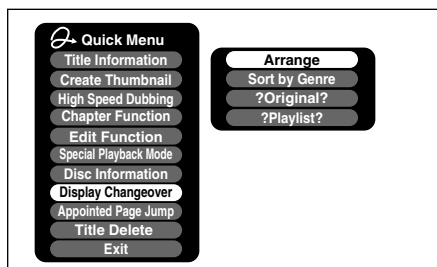

- 4) Press the **▲ / ▼** buttons to select the item, then press the **ENTER** button.
 - **Arrange**
The titles are rearranged along with the selected order.
Press the **▲ / ▼** buttons to select the order, then press the **ENTER** button.
 - **Genre**
Titles of the selected genre are sorted.
Press the **▲ / ▼** buttons to select the genre, then press the **ENTER** button.
 - **?Original?**
Titles (Original) are sorted.
 - **?Playlist?**
Titles (Playlist) are sorted.

Notes

- Quitting the CONTENT MENU restores the order and sorting.
- To restore the sorted titles by “?Original?” or “?Playlist?”, select “Title List Summary” from the Quick Menu.

■ **Jumping to a specified page**

- 1) **Press the CONTENT MENU button.**
The CONTENT MENU appears.
- 2) **Press the QUICK MENU button.**
The Quick Menu appears.
- 3) **Press the ▲ / ▼ buttons to select “Appointed Page Jump”, then press the ENTER button.**
- 4) **Enter the page number you want by pressing the ADJUST, ▲ / ▼ or the number buttons.**

e.g.

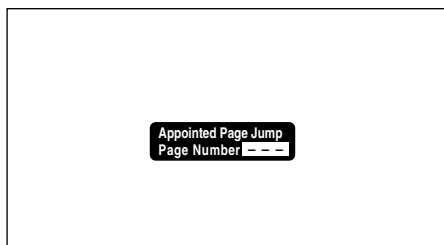

To clear the number, press the CLEAR button.

- 5) **Press the ENTER button.**
The specified page appears.

■ **Playing a DVD-RW disc recorded in DVD-VR mode** DVD-RW

See ➡ page 59.

Notes

- Some disc's conditions or discs which contain copy once contents may not permit proper playback.
- Title Resume" (➡ page 128) is not available.

Playing a DVD video disc

You can also play VIDEO CDs, audio CDs or finalization processed DVD-R/RW discs in the same manner. To play recorded contents, follow the instructions on [page 53](#).

■ Preparation

- Turn on a TV or audio system and select the corresponding input source that the recorder is connected to.
- Load a disc you want to play. ([page 20](#).)

**STOP
PAUSE**

1 Press PLAY.

Playback starts.

PLAY

- Depending on the disc, playback starts automatically by loading the disc.
- The recorder may take a short time to start playback. This occurs because the recorder is reading the data of a disc.

■ To stop playback

Press the STOP button.



■ To pause playback (still playback)

Press the PAUSE button.



To resume normal playback, press the PLAY button or the PAUSE button.

Note

- Sound is muted during still mode.

Note

- DVD video disc provides high resolution pictures and a lot of information. Because of this, you may notice some fine picture noises on TV screen, which you have never seen with regular broadcast TV program. While the amount of noise depends on the TV you use with the recorder, you should generally reduce the sharpness adjustment on your TV when viewing DVD video discs.

■ Resuming playback from the location last stopped (Resume Play)

DVD-RW DVD-R DVD-VIDEO VCD CD

You can resume playback from the location where you stopped.

If you press the PLAY button after stopping playback, playback resumes from the location you have stopped.

If you stop playback by pressing the STOP button twice, the resume playback feature will be cancelled.

Notes

- Resume feature cannot function when:
 - you select a disc menu language (➡ page 122) or change the parental lock setting (➡ page 123).
 - you play a PBC-featured VIDEO CD while “PBC” (➡ page 124) is set to “On”.
 - you open the disc tray.
 - you cancel the DVD-Video finalizing process of a DVD-RW disc.
- There may be a difference in the location where playback resumes depending on the disc.
- While the recorder retains a location in memory, initial setting changes with GUI may function only after the memory is cleared.

Locating a title using the top menu

DVD-RW DVD-R DVD-VIDEO

Some DVD video discs may include a top menu, on which you can view the structure of contents or select a scene. Most of the top menus automatically appear in certain scenes, and also are displayed on demand. Actual operation of the top menu depends on the disc. This section explains a general example of how to operate a top menu. Also refer to the instructions of the disc itself.

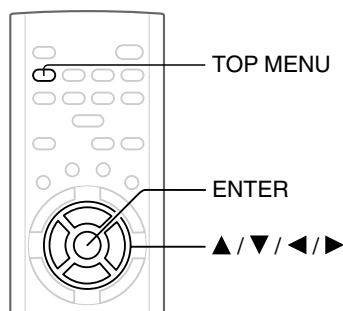

- 1) Press the TOP MENU button.
- 2) Press the ▲ / ▼ / ◀ / ▶ buttons to select the title you want.
 - If the titles in the top menu are assigned a number, you can directly locate a specific title by pressing its designated number with the number buttons.
- 3) Press the ENTER button.

Notes

- The instructions above describe basic procedures which may vary depending on the contents of the DVD video disc. If different instructions appear on the TV screen, follow those instructions.
- If you display the top menu during playback and press the TOP MENU button again without selecting any title, the recorder may resume playback from the point where you first pressed the TOP MENU button. (depending on the actual DVD video disc.)
- This method of locating a title is available only on a disc that contains a top menu.
- Instruction notes of discs may refer to the button that displays the top menu as the TITLE button.

Pausing a TV broadcast to resume later

This function enables you to pause a TV broadcast and resume viewing at a later, more convenient time, by storing the TV broadcast temporarily on a DVD-RAM disc.

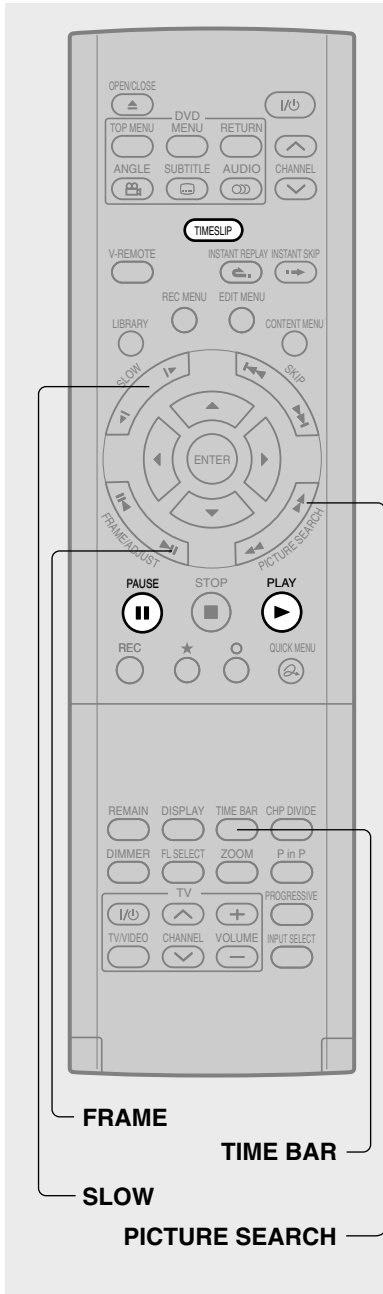

1 While viewing a TV broadcast via this recorder or immediately before it starts, press **TIMESLIP**.



The current picture pauses.
The recorder begins to store the broadcast on a DVD-RAM disc the moment you press the TIMESLIP button.

2 Resume playback by pressing **PAUSE** or **PLAY**.



- You can confirm how far you are from the current broadcast by pressing the TIME BAR button.
- Playback may not resume immediately after you press the PLAY or PAUSE button.

3 Locate a scene you want by the following methods.

Fast-forward/fast-reverse:

Press the PICTURE SEARCH button.

Forward/reverse Slow-motion:

Press the SLOW button.

Forward/reverse frame by frame play:

First press the PAUSE button then press the FRAME button.

- To resume normal playback, press the PLAY button.
- You can play in fast-forward to within 10 seconds prior to the current broadcast.

4 Press **TIMESLIP** to exit this mode.



The recorder stops storing the broadcast on a DVD-RAM disc.
A message appears and asks you whether you will save the stored data or erase it.
Press the ◀/▶ buttons to select, then press the ENTER button.

Notes

- This function is not available during recording.
- Pause TV recording stops when the DVD-RAM disc is filled up. It will not begin if a DVD-RAM disc is full.
- If you pause a picture immediately after the recorder begins to store the broadcast, you will take more time to resume playback.
- While using this pause TV recording, you cannot program a recording.
- While the TIMESLIP indicator is on, you cannot obtain sound at “▶▶” speed (▶▶ page 63).

Playing a TV program currently being recorded

You can begin playback from the beginning of a program currently being recorded.

You will find this function of great advantage on long programs, as you do not have to wait for the end of recording to begin playback.

1 While recording a TV program on a DVD-RAM disc, press TIMESLIP.

The recorder displays a TV program as it is being recorded.

2 Go back to the beginning of the TV program using SKIP.

When you go back to the beginning, playback starts automatically.

You can confirm how far you are from the current broadcast by pressing the TIME BAR button.

3 Locate a scene you want through the following operations if necessary.

Fast-forward/fast-reverse:
Press the PICTURE SEARCH button.

Forward/reverse Slow-motion:
Press the SLOW buttons.

Forward/reverse frame by frame play:
First press the PAUSE button then press the FRAME button.

- To resume normal playback, press the PLAY button.
- You can play in fast-forward to within 10 seconds prior to the current broadcast.

4 Press TIMESLIP to exit.

The current broadcast returns.

Notes

- Time slip recording/playback stops when the DVD-RAM disc is filled up. You can play up to a location where the recorder stopped the recording. The time slip recording/playback cannot begin if a DVD-RAM disc is full.
- Time slip recording/playback is not available immediately after a recording starts.
- The playback location will never be identical to the record location in the program. It will always trail the record location by a few seconds.
- While using time slip recording/playback, you cannot program a recording.
- While the TIMESLIP indicator is on, you cannot change the setting of the feature that turns off the recorder after a programmed operation has finished.
- Even while "Auto Power Off" is selected, the recorder does not turn off if the recording end time comes during playback of a program being recorded.
- Playback may pause depending on the data recording condition.

Playing at various speeds

Playing in fast reverse or fast forward

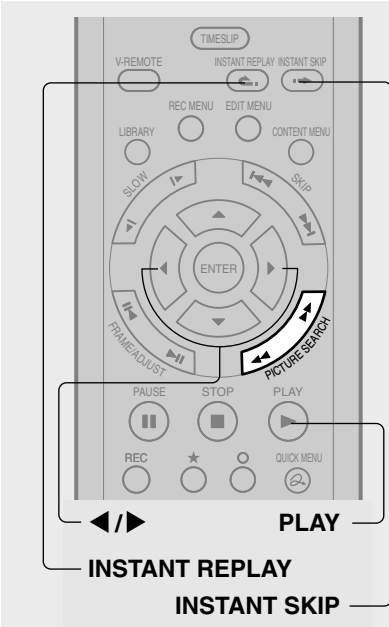

1 During normal playback, press PICTURE SEARCH.

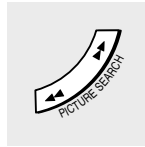

- ▶▶ : Fast forward playback
- ◀◀ : Fast reverse playback

Each time you press the button, the playback speed changes.

During fast forward playback at “▶▶” speed, sound is reproduced.

(Not available on VIDEO CD and audio CD.)

- This function is not available when you play a title recorded on a DVD-RAM disc while recording another.

Notes

- The playback speed may vary depending on the disc.
- Noise may be heard during fast forward playback.

■ To resume normal playback

Press the **PLAY** button.

■ To skip the contents for a while

During playback, press the **INSTANT SKIP** button.

Each time you press the button, you can skip by the specified time.

You can select the interval per press of the button. See “Instant Skip Interval” of “Operational Settings” (➡ page 128).

■ To skip by 1/20

During playback, press the **◀/▶** buttons.

Each time you press the button, you can skip by 1/20 of the current title or track if it is longer than 1 minute.

■ Time bar display

Fast-forward or fast-reverse playback automatically displays a time bar.

e.g.

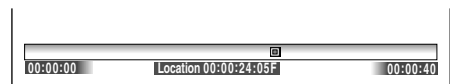

For details, see ➡ page 77.

■ To skip back momentarily

During playback, press the **INSTANT REPLAY** button.

Each time you press the button, you can go back by the specified time to resume playback.

You can select the interval per press of the button. See “Instant Replay Interval” of “Operational Settings” (➡ page 128).

Notes

- Some discs may not permit this operation.
- Depending on disc structure, some operations may be limited.
- Depending on playback status, some operations may not work.

Skipping to the next/previous chapter or track DVD-RAM DVD-RW DVD-R DVD-VIDEO VCD CD

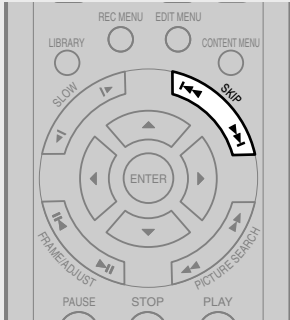

1 Press SKIP (◀◀/▶▶) repeatedly until the chapter or track number you want appears.

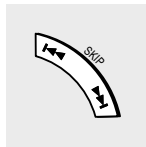

Playback starts from the selected chapter or track.

▶▶ : Playback starts from the beginning of the next chapter or track.

◀◀ : Playback starts from the beginning of the current chapter or track.

When you press twice, playback starts from the beginning of the previous chapter or track.

Notes

- Some titles may not display chapter numbers.
- When playing a DVD-RAM disc, you can access chapters only in the current title if “Title Play” (➡ page 128) is set to “Title Resume”. To access chapters in other titles, set to “Serial Playback”.
- When playing a DVD video disc or a DVD-R/RW disc, you can locate chapters only in the current title if “DVD Title Stop” (➡ page 124) is set to “On”. To access chapters in other titles, set to “Off”. However, in this instance even though you press the SKIP button (◀◀) to go back to the previous title, playback starts not from the last chapter of the title but from the first chapter.

Playing in slow-motion DVD-RAM DVD-RW DVD-R DVD-VIDEO VCD

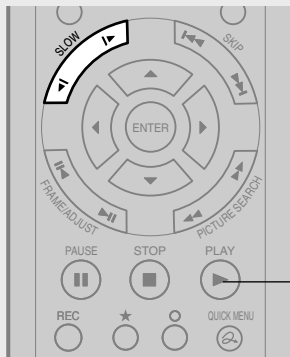

PLAY

1 Press SLOW during playback.



▶▶ : Forward slow-motion

◀◀ : Reverse slow-motion

Each time you press the SLOW button, the slow-motion speed changes.

Notes

- Slow-motion does not provide smooth playback.
- When playing a VIDEO CD, reverse slow-motion playback is not available.
- The speed level displayed is approximate.

■ To resume normal playback Press the PLAY button.

Playing frame by frame DVD-RAM DVD-RW DVD-R DVD-VIDEO VCD

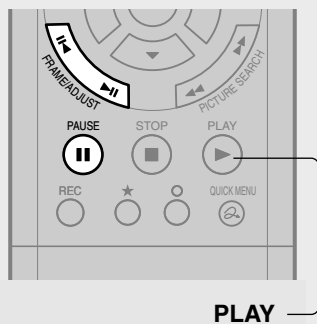

1 During playback, press PAUSE.

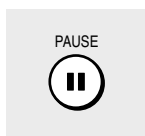

A still picture is displayed.

2 Press FRAME (II</>II).



▶▶ : Playback direction
 ◀◀ : Opposite direction

- To resume normal playback
 Press the PLAY or PAUSE button.

Notes

- Sound is muted during frame by frame playback.
- Frame by frame playback cannot provide smooth playback.
- Picture may advance more than 1 frame at a time.
- Depending on the scene, some frames may not be played.
- When playing a VIDEO CD, frame by frame playback is not available.

Viewing still pictures (Playing a disc that contains still pictures) DVD-RAM DVD-VIDEO

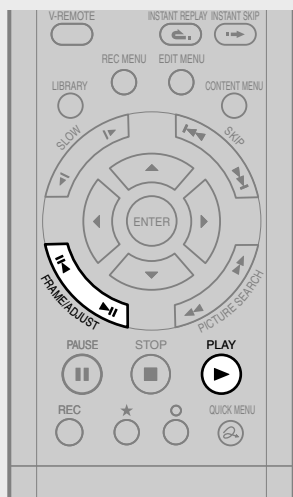

1 Press PLAY.



The first still picture on a disc is displayed.

Some DVD video discs may allow you to change the pictures using the PLAY, ENTER or SKIP button.

2 Press FRAME (II</>II).



▶▶ : Displays the next still picture.
 ◀◀ : Displays the previous still picture.

Locating by entering the number

Locating by entering the number of a desired section

Normally titles, chapters, and tracks are numbered. By entering these numbers, you can access a desired section.



Open the lid.

CLEAR

1 Press T.SEARCH.



If you are using a VIDEO CD/audio CD, skip step 2.
e.g.



2 Press ▲ / ▼ to select a section (title or chapter) you want to locate.

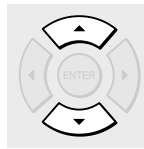

e.g. When you want to locate a chapter.

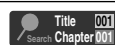

3 Press the number buttons to enter a number of the section.

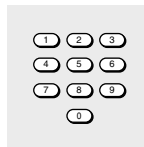

e.g. To enter 25, press "2", then press "5".

4 Press ENTER.



Playback starts from the selected location.

Notes

- Pressing the CLEAR button resets the numbers. To clear the display, press the T.SEARCH button several times (depending on the disc).
- This method of locating a title is available only on a disc that contains title numbers.
- If a title is erased, the numbers of the following titles decrease respectively.
- When you record a new title (Original) on a DVD-RAM disc, it is added prior to current titles (Playlist), and each following title (Playlist) reference number will advance by a factor of 1.

Locating a specific point by entering its elapsed time (Time Search)

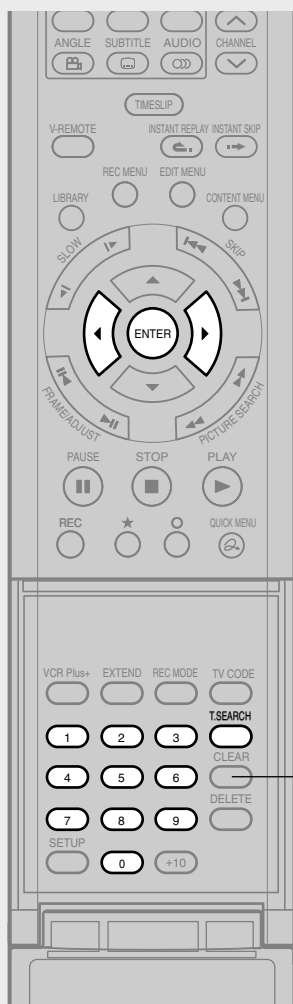

Open the lid.

CLEAR

1 Press T.SEARCH.



You may have to press repeatedly, depending on the disc. Press the button until the following display appears.

e.g.



2 Press the number buttons and ◀/▶ to enter the desired time location on the disc.



e.g. To enter 1 hour, 25 minutes, and 30 seconds

“0” → “1” → “▶” → “2” → “5” → “▶” → “3” → “0”
hour minute second

3 Press ENTER.



Playback starts from the selected location.

Notes

- Some discs may not respond to this process.
- Some scenes may not be accessed precisely as you specified.
- This method for accessing specific locations is available only within the current title of a DVD-RAM/R/RW/DVD video disc or within a current track of a VIDEO CD/audio CD.
- Pressing the CLEAR button resets the numbers.

Using the graphic remote control (Virtual Remote)

A graphics based on-screen remote control enables direct playback, without manipulating many multiple buttons.



1 During playback, press V-REMOTE.



The Virtual Remote appears.

e.g.

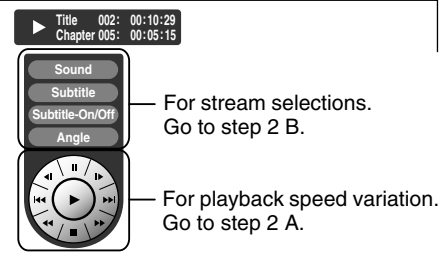

For stream selections.
Go to step 2 B.

For playback speed variation.
Go to step 2 A.

2 A Press ▲ / ▼ / ◀ / ▶ to select the speed and direction, then press ENTER.

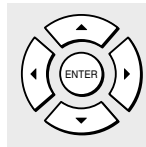

- ⏸ : To pause playback / to resume
- ▶ : To start playback
- ▶▶ : To begin slow-motion playback
- ▶▶▶ : To skip to succeeding chapters or tracks
- ▶▶▶▶ : Fast-forward
- ◀◀ : Reverse slow-motion
- ◀◀◀ : Fast-reverse
- ◀◀◀◀ : To skip in reverse direction
- : To stop playback

B Press ▲ / ▼ to select “Sound”, “Subtitle”, “Subtitle-On/Off”, or “Angle”, then press ENTER.



The current setting of the selected item appears. Press the ADJUST button to make selections, then press the ENTER button. For details, see the following respective pages.

- Sound: ➡ page 73
- Subtitle: ➡ page 71
- Subtitle-On/Off: ➡ page 71
- Angle: ➡ page 70

Notes

- Some discs may not permit this operation.
- The V-REMOTE button can work only in playback mode.

■ To turn off the Virtual Remote

Press the V-REMOTE button or stop playback.

Watching a TV broadcast in the sub window (P in P Playback)

During playback, you can watch a TV broadcast in the sub window. (P in P : Picture in Picture)



CHANNEL

1 During playback, press P in P.

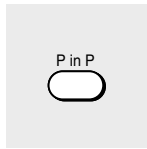

A sub window (program on the air or on the recording) appears.

e.g.

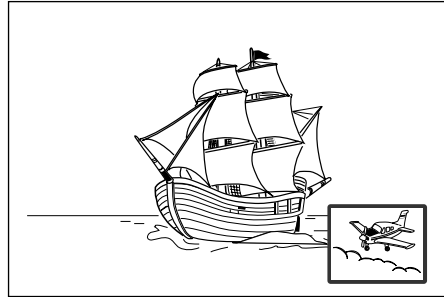

2 Press ▲ / ▼ / ◀ / ▶ to select the position of the sub window.

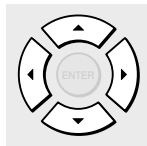

You can shift the sub window in following 4 directions.

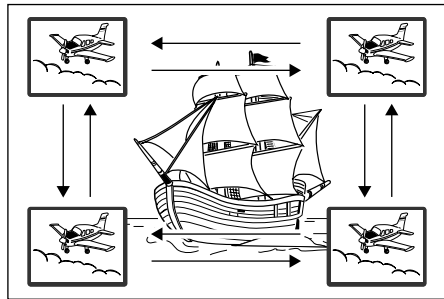

↑ / ↓ / ← / → is the moving range.

To turn off the sub window, press the P in P button.

Notes

- You can change the channel of the sub window by pressing the CHANNEL \vee / \wedge button.
- The P in P function is available only during playback.
- You cannot swap the playback picture with the picture within the sub window, or change the audio settings.
- Press the P in P button during "Chase Play" or "Pause TV", the actual broadcast appears on the sub window in real time.
- If this function is stopped after shifting the sub window, before you press the P in P button again, the sub window will appear in the last position you set. However, if you turn off the power, the sub window re-appears in the lower right (default) position.

Selecting the camera angle

If the scene was recorded with multiple angles, you can easily change the camera angle of the scene you are watching.

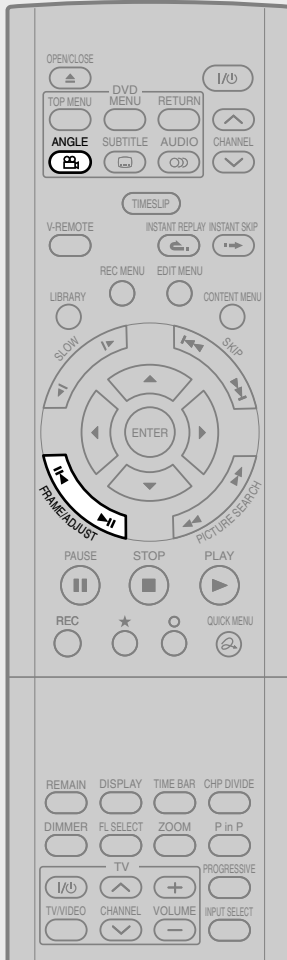

1 Press ANGLE while playing a scene recorded with multiple angles.



While playing a scene recorded with multiple angles, the angle icon appears on the TV screen and on the front panel. Press the ANGLE button while the angle icon is flashing.

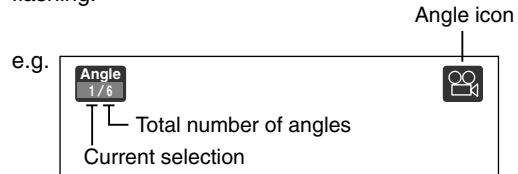

2 Press ADJUST while the angle number is displayed on the TV screen.



You can also select the camera angle by pressing the ANGLE button several times.



- The angle icon disappears after about 3 seconds if no further selections are made.

Notes

- You can change the camera angle during still playback. The camera angle changes to the new setting when you resume normal playback.
- If you pause a picture immediately after changing a camera angle, the resumed playback picture may not display the new camera angle.
- Depending on the disc, the camera angle may not change even though the angle number changes.

■ To turn off the angle icon

Set "On Screen Display" in the setup menu to "Off" (➡ page 127).

Most of the on-screen display including the angle icon will not appear.

While the angle icon is flashing on the front panel, you can change the camera angle.

Selecting Subtitles

You can display subtitles on the TV screen and select a subtitle language from those included on the disc.



1 Press SUBTITLE during playback.



The current subtitle setting appears.

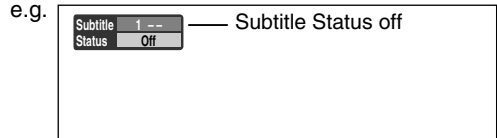

The language code appears instead of the language name. Refer to the list of languages and their abbreviations. (➡ page 136)

2 Press ▼ to select "Status," then press ADJUST to select "On."

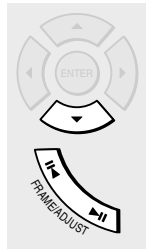

Skip to step 3 if "On" is already displayed.

3 Press ▲ to select "Subtitle," then press ADJUST to select a language.

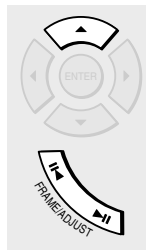

The subtitles of recorded languages appear.



The display turns off after about 3 seconds if you do not make a selection.

Notes

- Some DVD video discs are set to display subtitles automatically.
- Depending on the scene, subtitles may not appear immediately after you set the subtitle function to on.
- Some DVD video discs will allow you to change subtitle languages and turn subtitles on or off only via the disc menu.

■ To turn the subtitles on or off

At step 2, select "Off" by pressing the ADJUST button.

Zooming a picture

You can magnify areas within a picture.

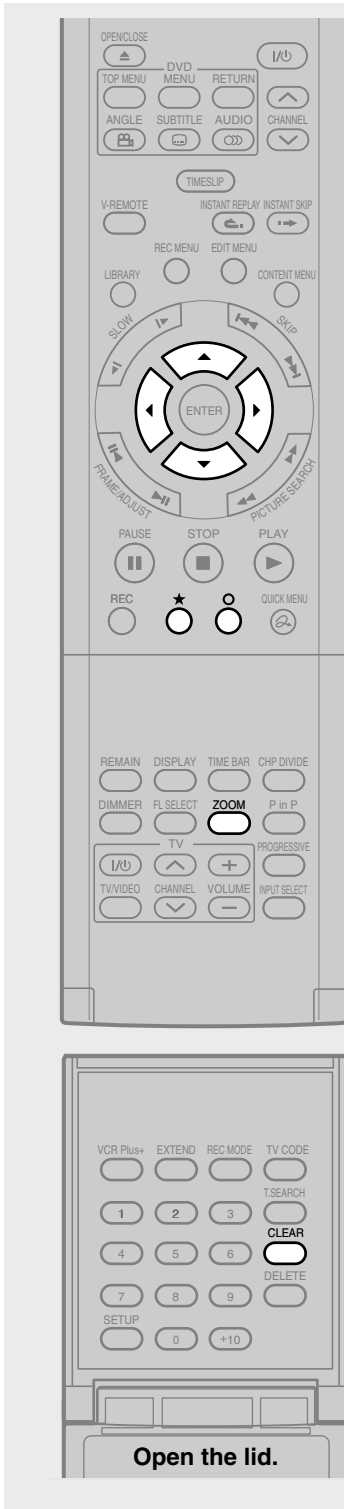

Open the lid.

1 Press ZOOM.



A zoom scope appears.

e.g.

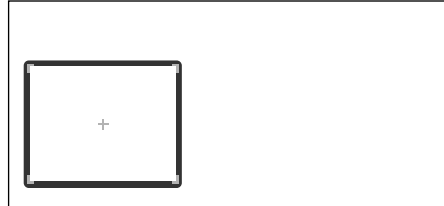

2 Select a zoom point and magnification level.

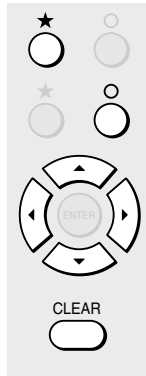

★: Raises the magnification level.

○: Lowers the magnification level.

▲/▼/◀/▶: Moves the zoom point.

CLEAR: Returns the zoom point to the center of the picture.

Notes

- Some discs may not respond to zoom feature.
- During some scenes, the buttons may not work as described.
- The zoom feature is canceled when the disc menu is operated.
- The magnification level varies depending on the picture size you select (➔ page 42, "INSTALLATION GUIDE").
- The zoom feature is not available while displaying a GUI.
- The zoom feature is canceled when you stop playback or start playback.

- **To cancel the zoom**
Press the ZOOM button.

Selecting the Sound

You can select a preferred language and a sound format.

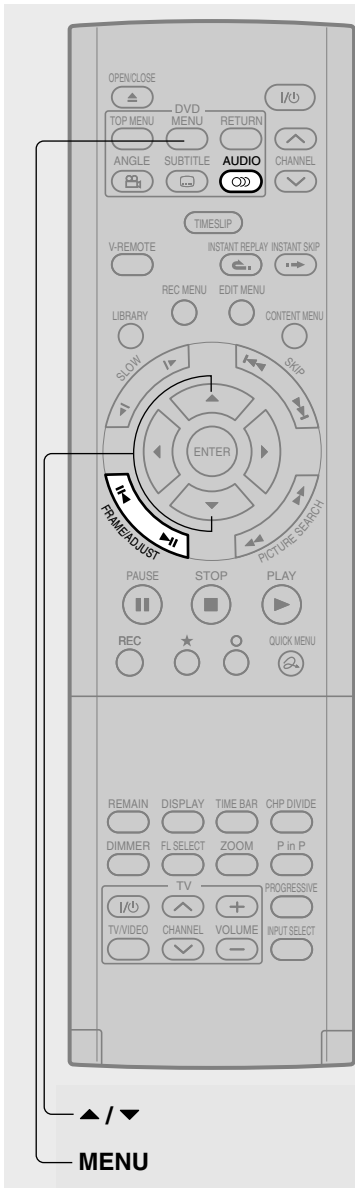

1 Press AUDIO during playback or while receiving a broadcast.



The current audio setting appears.

The language code appears instead of the language name. Refer to the list of languages and their abbreviations. (➡ page 136)

2 Press ADJUST while the audio setting is displayed on the TV screen.

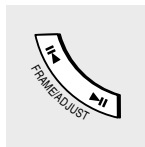

Variation of channels depends on the disc or the type of TV broadcast.

• **DVD-RAM** **DVD-RW** **DVD-R**, TV channel signals

Stereo sound

- "Stereo" (left (main) channel and right (sub) channel)
- "Stereo L" (left (main) channel)
- "Stereo R" (right (sub) channel)
- (→ Back to "Stereo")

SAP sound

"Main" → "SAP" → "Main + SAP" (→ Back to "Main")

DVD-RW **DVD-R** **DVD-VIDEO**

Language name / sound recording system / No. of channels

e.g.



• **VCD**

"Stereo" → "Stereo L" → "Stereo R" (→ Back to "Stereo")

The display turns off if you do not operate for more than 3 seconds.

If you press the ▲ / ▼ buttons to select "Output," you can select the audio output setting (➡ page 126) by using the ADJUST buttons.

■ MTS Broadcast Compatibility

This recorder can receive or record MTS (Multichannel TV sound) broadcast. By connecting the recorder to your stereo system or stereo TV, you will experience the SAP or stereo sound.

SAP (Second Audio Program broadcast)

A separate audio program, usually broadcast in a second language with the main language.

Sounds in playback

You can play SAP and/or stereo broadcasts with this recorder. Refer to steps 1 and 2 to select a desired audio.

Desired sound	L, R indicators on the front panel	Sound output
SAP sound	R (right) is on.	SAP
Stereo sound	Both R (right) and L (left) are on.	Stereo Sound

Selecting the Sound (Continued)

Recorded sounds

According to your setting of “SAP” on the setup menu screen, (▶ page 126), the sound is recorded onto different channels of the disc below. Set “SAP” to “On” or “Off” appropriately.

Setting on the setup screen		Type of receiving broadcast	Contents of recorded sound		Type of record
DVD Compatible Mode	SAP		Lch	Rch	
Off	Off	Stereo + SAP	L	R	Stereo
		Mono + SAP	Mono	Mono	Stereo
		Stereo	L	R	Stereo
		Mono	Mono	Mono	Stereo
	On	Stereo + SAP	L + R	SAP	Dual Mono
		Mono + SAP	Mono	SAP	Dual Mono
		Stereo	L	R	Stereo
		Mono	Mono	Mono	Stereo
Main	Off	Stereo + SAP	L	R	Stereo
		Mono + SAP	Mono	Mono	Stereo
		Stereo	L	R	Stereo
		Mono	Mono	Mono	Stereo
	On	Stereo + SAP	L + R	L + R	Stereo
		Mono + SAP	Mono	Mono	Stereo
		Stereo	L	R	Stereo
		Mono	Mono	Mono	Stereo
SAP	Off	Stereo + SAP	L	R	Stereo
		Mono + SAP	Mono	Mono	Stereo
		Stereo	L	R	Stereo
		Mono	Mono	Mono	Stereo
	On	Stereo + SAP	SAP	SAP	Stereo
		Mono + SAP	SAP	SAP	Stereo
		Stereo	L	R	Stereo
		Mono	Mono	Mono	Stereo

Notes

- Some discs allow you to change audio selections only via the disc menu. If this is the case, press the MENU button and choose the appropriate language from the selections on the disc menu.
- When you turn on the recorder or replace a disc, the recorder returns to the initial default setting. (➡ page 122)
Depending on the disc, the sound that is specified the disc is played back.
- Immediately after you have switched sounds, there may be a temporary discrepancy between the display and actual sound.
- The BITSTREAM/PCM jack may not output SAP sound you select. In this instance, set “Audio Out Select” to “PCM”. (➡ page 126)
- You cannot change SAP sound if recorded with “DVD Video Compatibility” (➡ page 130) set to “On”. Even when “DVD Video Compatibility” (➡ page 130) is set to “Off,” the recorder regards it as “Main” when recording to a DVD-R/RW disc.

■ Output sound conversion table

Disc	Sound format	Audio setting (➡ page 126) and output in the default setting display					
		Bitstream		Analog 2ch		PCM	
		BITSTREAM/ PCM jack	Analog (L/R) jacks	BITSTREAM/ PCM jack	Analog (L/R) jacks	BITSTREAM/ PCM jack	Analog (L/R) jacks
DVD-video disc*	Dolby Digital	Bitstream	48 kHz/20 bit	Bitstream	48 kHz/20 bit	48 kHz/16 bit	48 kHz/20 bit
	Linear PCM	48 kHz/16 bit	48 kHz/16 bit	48 kHz/16 bit	48 kHz/16 bit	48 kHz/16 bit	48 kHz/16 bit
		48 kHz/20 bit	48 kHz/16 bit	48 kHz/20 bit	48 kHz/16 bit	48 kHz/20 bit	48 kHz/16 bit
		48 kHz/24 bit	48 kHz/16 bit	48 kHz/24 bit	48 kHz/16 bit	48 kHz/24 bit	48 kHz/16 bit
		96 kHz/16 bit	48 kHz/16 bit	48 kHz/16 bit	—	96 kHz/16 bit	48 kHz/16 bit
		96 kHz/20 bit	48 kHz/16 bit	48 kHz/20 bit	—	96 kHz/20 bit	48 kHz/16 bit
	96 kHz/24 bit	48 kHz/16 bit	48 kHz/24 bit	—	96 kHz/24 bit	48 kHz/16 bit	
DTS	Bitstream	—	Bitstream	—	—	—	
MPEG2	Bitstream	48 kHz/16 bit	Bitstream	48 kHz/16 bit	48 kHz/16 bit	48 kHz/16 bit	
VIDEO CD	MPEG1	44.1 kHz/16 bit	44.1 kHz/16 bit	44.1 kHz/16 bit	44.1 kHz/16 bit	44.1 kHz/16 bit	44.1 kHz/16 bit
Audio CD	Linear PCM 44.1 kHz/16 bit	44.1 kHz/16 bit	44.1 kHz/16 bit	44.1 kHz/16 bit	44.1 kHz/16 bit	44.1 kHz/16 bit	44.1 kHz/16 bit
	DTS	Bitstream	(Noise)	Bitstream	(Noise)	Bitstream	(Noise)
DVD-RAM/RW	Dolby Digital	Bitstream	48 kHz/20 bit	Bitstream	48 kHz/20 bit	48 kHz/16 bit	48 kHz/20 bit
	Linear PCM 48 kHz/16 bit	48 kHz/16 bit	48 kHz/16 bit	48 kHz/16 bit	48 kHz/16 bit	48 kHz/16 bit	48 kHz/16 bit
	MPEG2	Bitstream	48 kHz/16 bit	Bitstream	48 kHz/16 bit	48 kHz/16 bit	48 kHz/16 bit

* “DVD video disc” above does not include DVD-R/RW discs recorded on this recorder. Virtual Surround playback is possible (➡ page 126)

- Do not select a connection or setting indicated as “Noise” in the above list.

Manufactured under license from Dolby Laboratories. “Dolby”, “Pro Logic” and the double-D symbol are trademarks of Dolby Laboratories. Confidential unpublished works. Copyright 1992-1997 Dolby Laboratories. All rights reserved.

Checking the current status and settings

You can confirm operational status and setting details.

Operational status and setting details



1 Press DISPLAY.

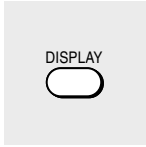

The following on-screen display appears. (The actual display varies depending on the disc.)

e.g. while playing a DVD-RAM disc

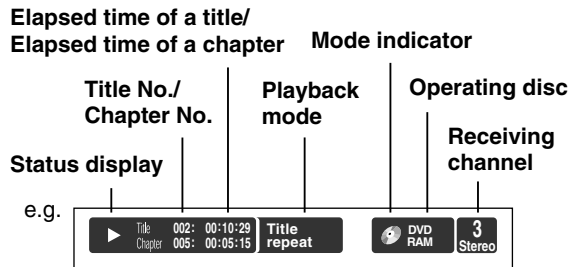

2 Press DISPLAY again.

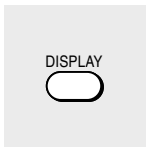

An expanded display appears. (Actual display varies depending on the disc.)

e.g.



3 Press DISPLAY again to turn the display off.

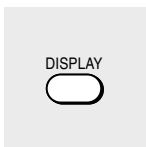

Using the time bar

The time bar shows the current progress in playback or recording.

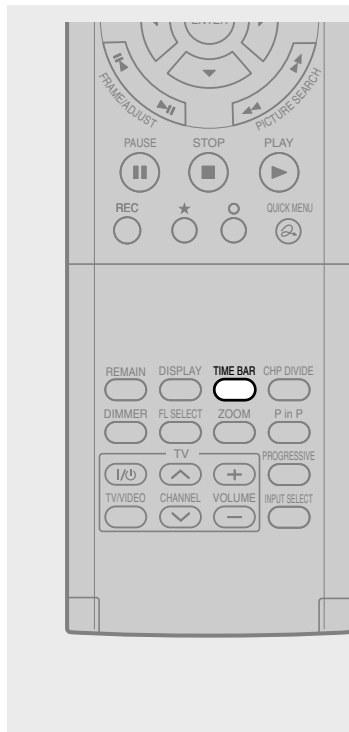

1 During playback or recording, press TIME BAR.

The time bar appears. (The actual display varies depending on the disc.)

TIME BAR



e.g. Playback Locator (Shows the current location.)

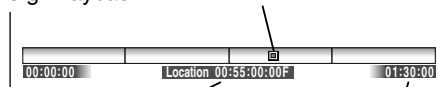

Elapsed time

Total playing time of a current title
(In the case of a VIDEO CD or audio CD, it shows the total playing time of the disc.)

e.g. Recording Locator (Shows the current location.)



Elapsed time

Elapsed recording time (per 30 minutes)
(Recording end time if it comes within 30 minutes.)

Note

- Time display is an approximation.

■ Changing the location of the time bar

While the time bar is displayed, press the ▲ / ▼ buttons.

The time bar shifts up and down.

■ Turning off the time bar

Press the TIME BAR button.

Functions in a Quick Menu

Besides these examples, various other ones are introduced on respective pages for your convenience. See  page 23 on how to operate the Quick Menu.

■ To play repeatedly (Repeat playback)

DVD-RAM | DVD-RW | DVD-R | DVD-VIDEO | VCD | CD

You can repeat a desired section.

- 1) During playback, press the QUICK MENU button.
- 2) Press the **▲ / ▼** buttons to select “Special Playback Mode”, then press the ENTER button.

Special Playback Mode

The sub menu appears. Select the next item by pressing the **▲ / ▼** buttons and the ENTER button.

A-B Repeat

You can designate a portion in a title or track to repeat continuously.

If you select “A-B Repeat” and press the ENTER button, the following display appears. Perform steps 1 and 2 below.

e.g.



To cancel the procedure, press the **○** button.

- 1) Press the ENTER button at the beginning of the segment (point A) you want to repeat.

The location of point A is memorized.
The display changes to “Set B”.

- 2) Press the ENTER button at the end of the segment (point B).

The location of point B is memorized, and repeat playback begins between point A and B.

Title repeat

To repeat the same title.

Chapter repeat

To repeat the same chapter.

Track repeat **VCD | CD**

To repeat the same track.

Disc repeat **DVD-RW | DVD-R**

To repeat the entire disc.

Repeat All ORG Titles **DVD-RAM**

To repeat all original titles in a disc.

Repeat All PL Titles **DVD-RAM**

To repeat all playlist titles in a disc.

Cancel repeat

To resume normal playback.

Playback of a DVD-RAM disc stops.

Notes

- Some discs may not permit repeat operation.
- You cannot use repeat playback in conjunction with Random play.
- If you press the STOP button during repeat playback, this operation is canceled.
- While you are performing repeat playback on a DVD-RAM disc, other operations ( pages 63 to 65) except pause play are not available.

■ To play in random order (Random play)

DVD-RW | DVD-R | DVD-VIDEO | VCD | CD

You can play sections in random order.

- 1) During playback or stop, press the QUICK MENU button.
- 2) Press the **▲ / ▼** buttons to select “Special Playback Mode”, then press the ENTER button.

Special Playback Mode

The sub menu appears. Select the next item by pressing the **▲ / ▼** buttons and the ENTER button.

Title random

Plays all titles in a loaded disc in random order.
Each title is played beginning from chapter 1.

Chapter random

Plays all chapters in a current title in random order.

Track random

Plays all tracks on a loaded disc in random order.

Cancel random : (in Random play mode)

Resumes normal playback.

Notes

- Some discs may not permit random playback operation.
- You cannot use the random playback function in conjunction with the memory playback function.
- You cannot use the random playback function in conjunction with the repeat playback function.
- Pressing the STOP button during operation cancels random playback.

■ To play in favorite order (Memory playback)

DVD-RW | DVD-R | DVD-VIDEO | VCD | CD

You can select 30 titles, chapters, or tracks and play them in favorite order.

(To play contents in a DVD-RAM disc in favorite order, make a playlist. For details, see “Editing” on  page 82.)

- 1) During playback or stop, press the **QUICK MENU** button.
- 2) Press the **▲ / ▼** buttons to select “Special Playback Mode”, then press the **ENTER** button.

Special Playback Mode

The sub menu appears. Select the next item by pressing the **▲ / ▼** buttons and the **ENTER** button.

Memory list

If you select this and press the **ENTER** button, the following display appears. Perform the steps below.

e.g.

01 T	CT	011 T	CT	021 T	CT
02 T	CT	012 T	CT	022 T	CT
03 T	CT	013 T	CT	023 T	CT
04 T	CT	014 T	CT	024 T	CT
05 T	CT	015 T	CT	025 T	CT
06 T	CT	016 T	CT	026 T	CT
07 T	CT	017 T	CT	027 T	CT
08 T	CT	018 T	CT	028 T	CT
09 T	CT	019 T	CT	029 T	CT
10 T	CT	020 T	CT	030 T	CT

- 1) Input numbers of a titles, chapters, or tracks by using the number buttons, in favorite order.

Input each 3-digit number.

To input a 1- or 2-digit number, first input 0.

(e.g. “0”, “0”, “3”.)

To cancel the numbers, press the **CLEAR** button.

To input a chapter number, press the **◀ / ▶** buttons to shift the cursor.

- 2) Press the **▲ / ▼** buttons to select the next box, then perform step 1).

To select another chapter in the same title, you do not need to select the title number.

Repeat these steps if necessary.

You can program up to 30 selections into memory.

- 3) Press the **ENTER** button.

Memory playback starts.

Memory : (in normal playback mode)

To display an entry box for one program selection.

Memory release : (in memory playback mode)

To resume normal playback.

Memory repeat : (in memory playback mode)

To repeat a current memory playback.

Notes

- Some discs may not permit memory playback operation.
- Inputting numbers of titles, chapters or tracks that a disc does not contain will result in error.
- You cannot program/change selections during memory playback. To change selections, cancel memory playback by pressing the **STOP** button.
- When you turn off the power, the selected memory is erased.
- You can exit the memory playback display by pressing the **O** button.

■ **To display the current bit rate**

DVD-RAM | DVD-RW | DVD-R | DVD-VIDEO

- 1) During playback, press the QUICK MENU button.
- 2) Press the ▲ / ▼ buttons to select “Bit Rate”, then press the ENTER button.

Bit rate

Note

- To turn off the bit rate display, select this item again.

■ **To check information on a title**

DVD-RAM | DVD-RW | DVD-R

- 1) During playback, press the QUICK MENU button.
- 2) Press the ▲ / ▼ buttons to select “Title Information”, then press the ENTER button.

Title Information

■ **To exit the Quick Menu**

DVD-RAM | DVD-RW | DVD-R | DVD-VIDEO | VCD | CD

Press the QUICK MENU button again.

or

Press the ▲ / ▼ buttons to select “Exit”, then press the ENTER button.

Exit

Editing

You can create your own movie from your assembled scenes.

- **Before Editing**
- **Creating Chapters**
- **Playlist Editing**
- **Creating Thumbnails**
- **High Speed Library Dubbing**
- **Delete Selected Items**
- **Combine Original Titles**
- **DVD-Video Finalizing**
- **DV Recording**

Before Editing

This section describes information for editing of contents recorded on a DVD-RAM disc. Be sure to read before performing any editing.

Basic steps of editing

Creating chapters → Programming a Playlist → Dub (Copy) the Playlist (this will create an Original title of the desired scenes)

Editing is executed by a title and a chapter. Titles and chapters are classified into “Original” and “Playlist.” First, specify a desired scene by dividing a title (Original) into chapters. Then compile the necessary chapters (Original) in desired order by programming a Playlist. Then dub (copy) the Playlist on the same disc. This creates a title (Original). Refer to the following examples about “Playlist” and “Original.”

Example: Creating your own music compilation by collecting songs from music programs you record from Monday to Friday.

● You can create one title for one recording.

In the example above, five titles are created, as you recorded programs five times from Monday to Friday. **The content you recorded** is called “**Title (Original)**”
All chapters in a title (Original) are chapters (Original).



● Specify the range (a favorite song) you need in each title (Original).

To specify the range, create a chapter. A segment of a song becomes one chapter by creating divisions in a chapter at the beginning and end of a song. In the example to the right, three chapters (Original) are created in one title (Original).



● Compile chapters in a desired order.

You can select any chapter or order of chapters, as you want. Also you can assign a title to multiple chapters.

Each element to be compiled is called a part. In the example to the right, the three chapters in Wednesday, Friday, and Monday are the parts. When compiled, the source chapter (Original) remains as it is in the title (Original).

A new part is not created copying the source chapter (Original). It does not contain actual recorded content but only exists as an informational sub-set of the chapter name and the playback order (in the right example, the chapter names are “Monday, Wednesday, and Friday” and the playback order is “Wednesday→Friday→Monday”).

For actual playback, the contents of the source chapter (Original) are played.

You can create a part from the Original as many times as you want and you can make different titles with the same parts by changing the combination or order.

For parts, you can use not only chapters like in the example, but also titles (Original) and other Playlist.

You can play the actual recorded content, such as titles (Original) and chapters (Original), or by managing the Originals and parts, you can virtually create a variety of titles without increasing the use of disc space.

These **virtual titles or chapters** are called “**Title (Playlist)**” or “**Chapter (Playlist)**” respectively.

In order to differentiate titles (Playlist) from titles (Original), an Original is displayed on screen as “ORG” and a Playlist is displayed as “PL”.

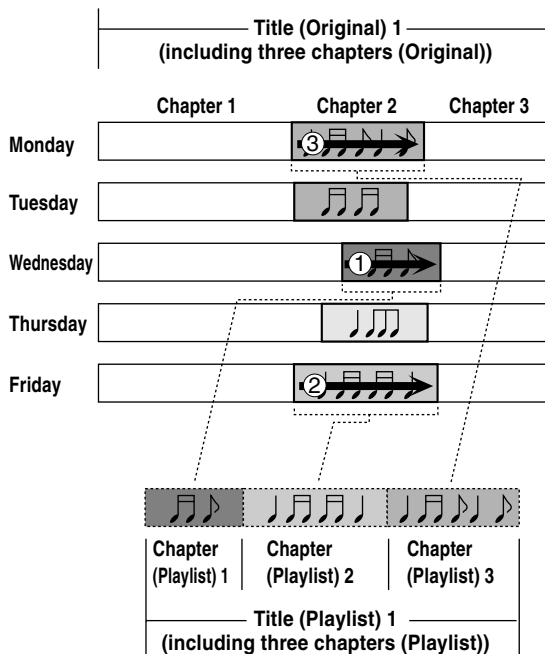

When title (Playlist) 1 is played, ①, ② and ③ are played in order.

● **Make the compiled chapters into a title (Original). (Dubbing)**

If you just want to play the compiled chapters in desired order, you only play the Playlist. If you want to delete a title (Original) which contains unnecessary chapters, be sure to dub (copy) the Playlist and make it into a title (Original).

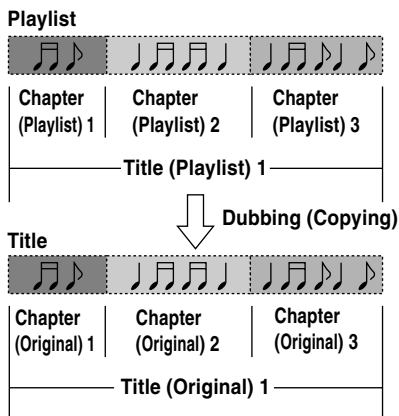

Notes

- A title (Playlist) or a chapter (Playlist) is based on a title (Original) or a chapter (Original). Therefore changing or deleting a title (Original) or a chapter (Original) will affect the related title (Playlist) or chapter (Playlist).
- Some recorded content cannot be edited (for example, a title including still images).
- The boundary of the title with unnecessary part deleted and titles (Playlist) having different parts cannot be played back seamlessly (without break).

Proceed to the practical operations.

See “Creating Chapters” (➡ page 85) and “Playlist Editing (collecting desired scenes)” (➡ page 90).
 For the dubbing procedure, see “High Speed Library Dubbing” (➡ page 98).

Creating Chapters

A recording makes 1 title, which includes 1 chapter. By dividing it into several chapters, it will be easier to access a desired scene, and your editing or playback will be much easier.

To create chapters in a title, insert a chapter mark. Use the frame advance and pause to locate a point where you want to divide, then press the **CHP DIVIDE** button. You can insert a chapter mark also while recording, by pressing the PAUSE button to pause the recording or by pressing the **CHP DIVIDE** button.

The point divides the chapter (into two). You can create multiple chapters by repeating the above operation.

Notes

- Chapters cannot be created in the following modes:
Dubbing / Fast-reverse, Fast-forward / Slow-motion
- You cannot divide a title of a DVD-R/RW disc into chapters. It is possible to create chapters in a DVD-R/RW disc by pressing the CHP DIVIDE button during recording at the desired points, or by selecting an option that inserts chapter marks automatically during recording at regular intervals. (▶ page 130)

If you want to modify the chapter division, or want to place a chapter mark more precisely monitoring the frame counter, follow the procedures below.

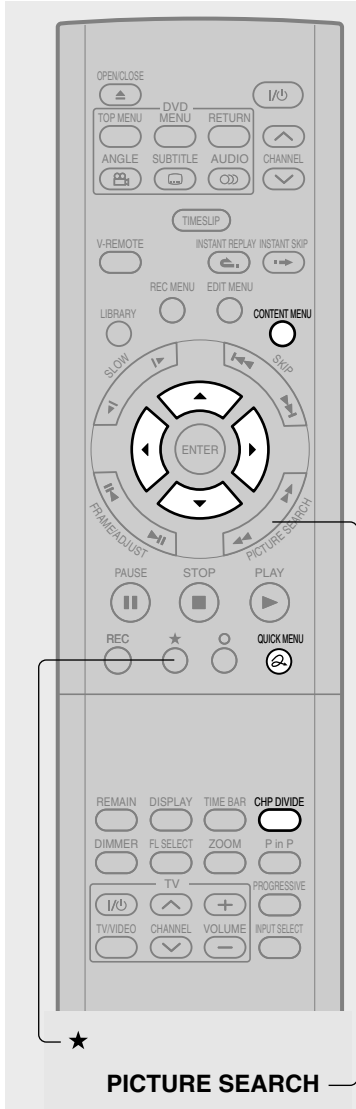

1 During stop, playback or recording, press CONTENT MENU.

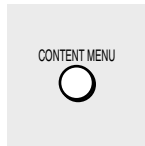

The CONTENT MENU Title List appears.

2 Press ▲ / ▼ / ◀ / ▶ to select a title.

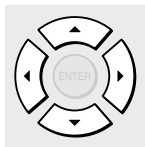

- To go to the next or previous page, press the PICTURE SEARCH (◀◀ / ▶▶) button.
 - To select a chapter, first highlight the title that contains the chapter you want, then press the ★ button. The display changes to “CONTENT MENU Chapter List”.
- To go back to the title display, press the ★ button again.

3 Press QUICK MENU.

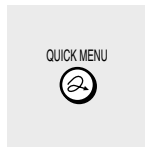

The Quick Menu appears.

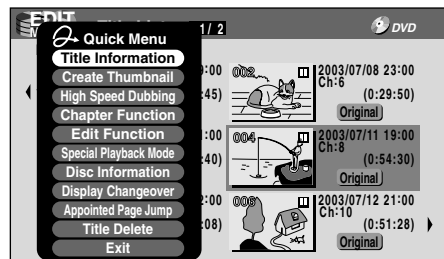

(Continued)

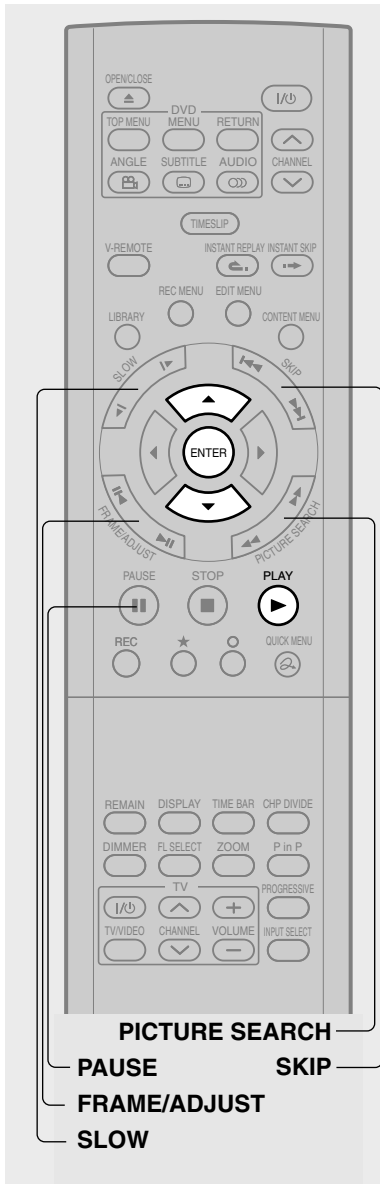

(Continued)

4 Press ▲ / ▼ to select “Chapter Function”, then press ENTER.

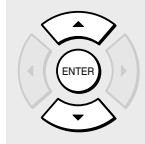

The Submenu appears.

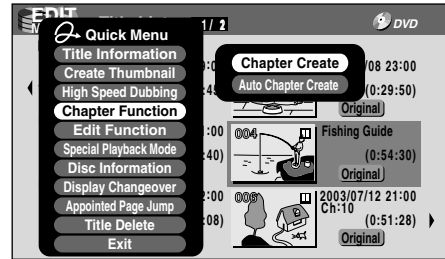

5 Press ▲ / ▼ to select “Chapter Create”, then press ENTER.

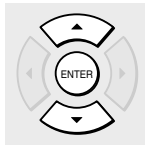

The EDIT MENU Chapter Create display appears.

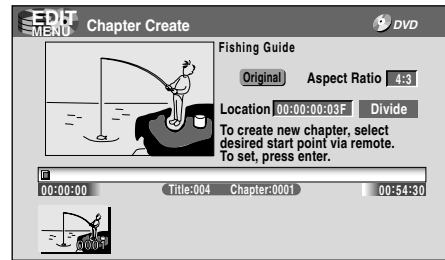

6 Press PLAY to start playback.



Locate a scene where you want to insert a chapter mark.

You can use the following buttons.
PICTURE SEARCH, SLOW, SKIP, PAUSE,
FRAME/ADJUST, etc.

The locator shows the current position on the time bar.

- To access other chapters:
Press the ▲ / ▼ buttons to move to the thumbnail display, then press the ◀ / ▶ buttons to select a desired thumbnail.
To go to the next page, press the PICTURE SEARCH button.
- You can confirm the first and last scenes of a chapter.
Select a thumbnail and press the ENTER button.
3 seconds of the first and last scenes are played.



7 At a point where you want to make a chapter division, press PAUSE.



The picture pauses.

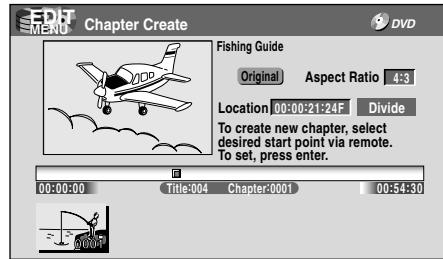

8 Press ▲/▼/◀/▶ to select “Divide,” then press ENTER.

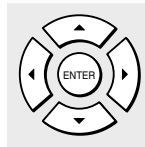

A chapter division is created at the selected location, and the first scene of the new chapter is registered as a chapter thumbnail.

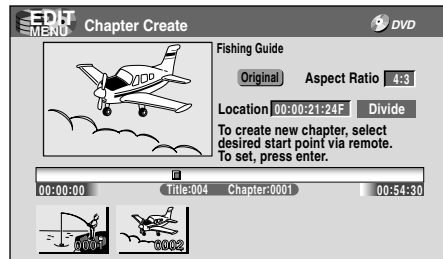

9 Repeat steps 6 to 8.

Locations of chapter division are indicated by the markers on the time bar.

To erase a chapter division, see “Merging chapters” (➡ page 89).

10 When all chapter divisions have been made, press O.

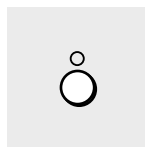

The recorder displays a message, and starts saving the chapter divisions on the time bar.

When complete, the CONTENT MENU returns.

Notes

- This recorder supports a limited number of chapters on a disc. If exceeded, a message appears. In this event, reduce the number of chapters by merging chapters. (▶ page 89)
- The EDIT MENU Chapter Create can also be viewed by selecting “Chapter Editing” from the EDIT MENU Main Menu.

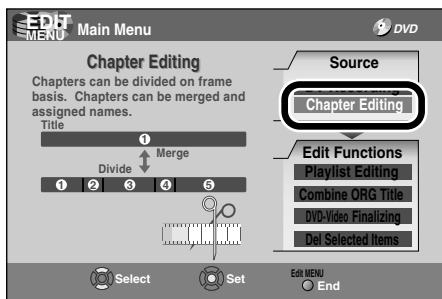

- To exit the EDIT MENU Main Menu, press the EDIT MENU button.
- Making chapters in a title (Original) does not affect the related titles (Playlist).
- There may be a small difference between a location you marked and a chapter division actually played.
- Pausing a recording automatically creates a chapter division.

■ Creating chapters automatically when recording

You can create chapter marks from the beginning of a title at regular intervals automatically. (Chapter marks are added to those already existing.)

This is convenient for long programs, such as live sports games.

- 1) Perform steps 1 to 4 on ▶ pages 85 to 86.
- 2) Press the ▲ / ▼ buttons to select “Auto Chapter Create”, then press the ENTER button.
- 3) Press the ▲ / ▼ buttons to select a chapter division interval, then press the ENTER button. Chapter divisions are automatically marked at the selected intervals.

■ Shifting the chapter mark

You can adjust positions of chapter marks. You can shift the beginning of a chapter currently selected.

- 1) Perform steps 1 to 5 on ▶ page 85 to 86.
- 2) Press the QUICK MENU button.
- 3) Press the ▲ / ▼ buttons to select “??Shift Chapter??”, then press the ENTER button.
- 4) Press the ▲ / ▼ buttons to select the item, then press the ENTER button.

“Frame Shift” (for DVD-VR format)

The chapter mark shifts by one frame.

“GOP Shift” (for DVD-Video format)

The chapter mark shifts by a GOP (about 0.5 second), which is a unit of editing in DVD-Video format.

- 5) Press the ◀ / ▶ buttons to select a chapter whose beginning you want to shift.
- 6) Press the FRAME (II◀ / ▶II) buttons repeatedly until a desired scene appears. Select a point while monitoring the thumbnail, which changes as you press the button. To operate other chapters, press the ◀ / ▶ buttons to select another, then follow the above steps.
- 7) When complete, press the QUICK MENU button, and select “??Cancel Frame Shift” or “Cancel GOP Shift” then press the ENTER button. You can exit this mode.

Notes

- You cannot shift a chapter mark beyond the adjacent chapter marks or a logical gap on recorded data within a chapter.
- Shifting a chapter mark restores a thumbnail to the beginning of a chapter. This may occur also on the previous chapter depending on the data condition.

■ Merging chapters

- 1) Perform steps 1 to 5 on  pages 85 to 86, to view the EDIT MENU Chapter Create display.
- 2) Press the \blacktriangle / \blacktriangledown / \blacktriangleleft / \blacktriangleright buttons to select a chapter.

Pressing the PICTURE SEARCH button can access preceding or following pages.

- 3) Press the QUICK MENU button.

e.g.

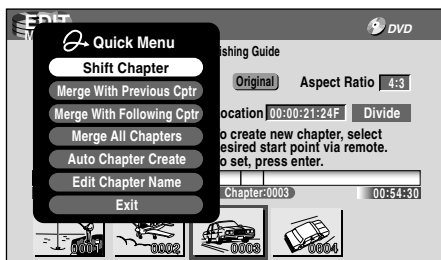

- 4) Press the \blacktriangle / \blacktriangledown buttons to select an item.

Merge With Previous Cptr:

To delete the chapter division between the selected chapter and the previous one.

Merge With Following Cptr:

To delete the chapter division between the selected chapter and the succeeding one.

Merge All Chapters:

To merge all chapters in the title.

- 5) Press the ENTER button.

e.g. When "Merge With Previous Cptr" is selected: The selected chapter is merged into the previous chapter and its thumbnail is erased.

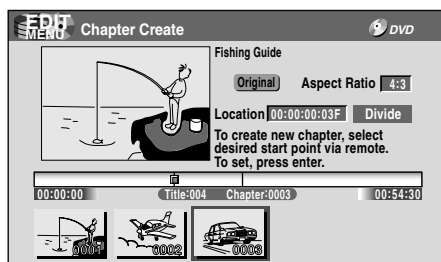

Notes

- To turn off the EDIT MENU Main Menu, press the EDIT MENU button.
- When chapters are merged, the numerical value of following chapters will decrease correspondingly.
- Merging chapters does not affect the related titles (Playlist). You can also merge chapters in the title (Playlist). In this case, the title (Original) is not affected.
- You can access the feature of merging chapters also from the Quick Menu on the CONTENT MENU Chapter List.

■ Naming a chapter

- 1) From the EDIT MENU Chapter Create, select a chapter which you want to name.
- 2) Press the QUICK MENU button.
- 3) Press the \blacktriangle / \blacktriangledown / \blacktriangleleft / \blacktriangleright buttons to select "Edit Chapter Name", then press the ENTER button.

A keyboard appears.

Enter a name following the on-screen icon guides.

e.g.

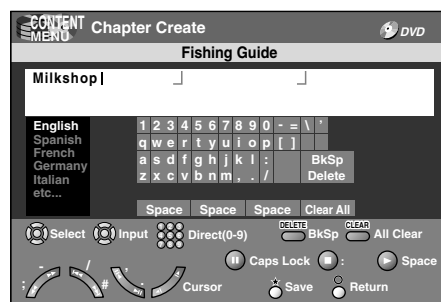

Notes

- There is a limit to the number of chapters which can be named. If exceeded, a message appears.
- You can also access the keyboard to enter a chapter name by selecting a chapter with the PICTURE SEARCH button on the CONTENT MENU Title Information, and by selecting "Edit Chapter Name" from the Quick Menu on the CONTENT MENU Chapter List.
- You can change chapter names also on a DVD-R/RW disc, if the disc is not finalized yet.

Playlist Editing (Collecting desired scenes)

Create a "Playlist" to omit unnecessary scenes for dubbing, or compile desired scenes.

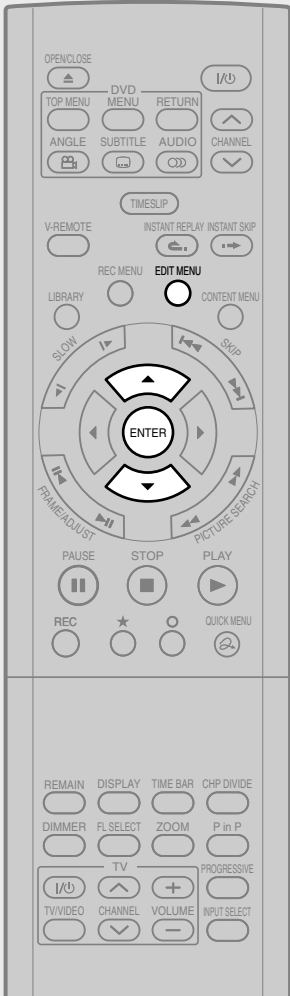

1 During stop, playback or recording, press EDIT MENU.



The EDIT MENU Main Menu appears.

2 Press ▲ / ▼ to select "Playlist Editing".

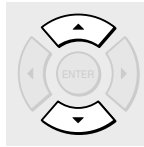

e.g.

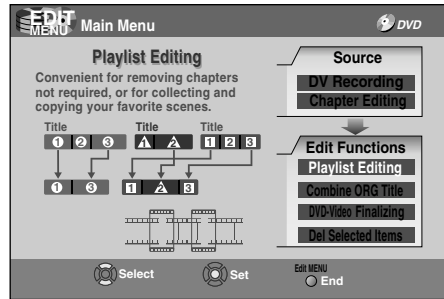

3 Press ENTER.



The EDIT MENU Playlist Editing appears.

e.g.



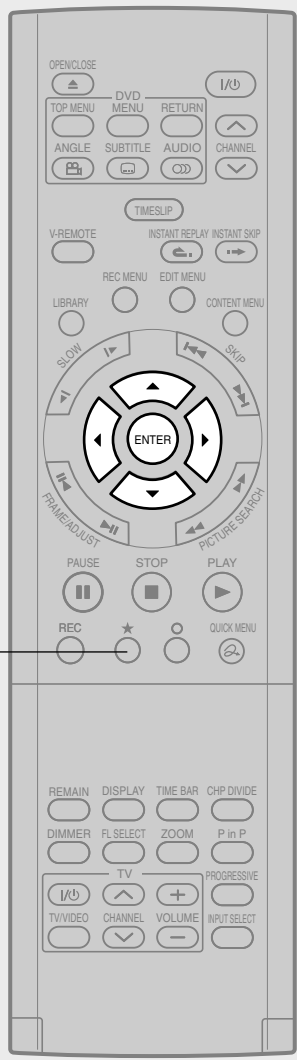

4 Press ▲ / ▼ / ◀ / ▶ to select a title or chapter as part.

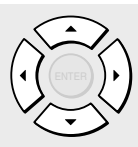

To select between titles and chapters, press the ★ button.

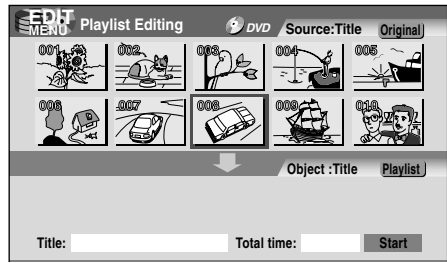

5 Press ENTER.



A cursor appears, indicating the point where the selected item will be inserted.



(Continued)

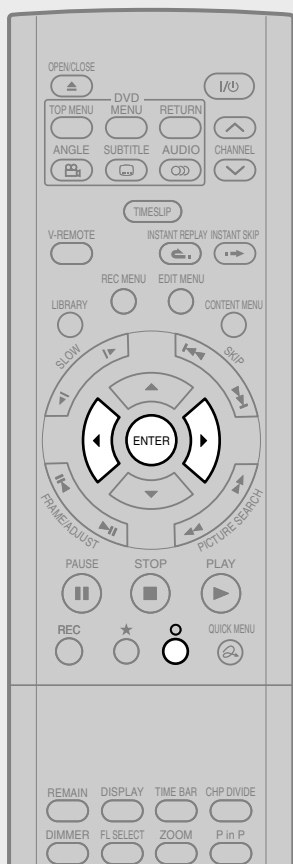

(Continued)

6 Press ◀/▶ to select a point where you want to insert the item, then press ENTER.



If there are no parts in the lower area, leave the cursor to the left and press the ENTER button.

The selected part is inserted at the location of the cursor.



7 Repeat steps 4 to 6 to insert items.

To cancel the selection, see “Canceling selection of a part” (▶ page 93).

8 When all items have been inserted, press O.

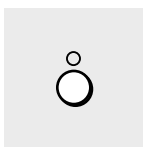

The recorder displays a message, and starts saving the Playlist.

When complete, the EDIT MENU returns.

Notes

- You can access the EDIT MENU Playlist Editing also by selecting “Edit Function” from the Quick Menu on the CONTENT MENU.
- If you delete titles and chapters (Original), the corresponding titles and chapters (Playlist) are also deleted. Contrarily, if you delete titles and chapters (Playlist), the corresponding titles and chapters (Original) are not deleted.
- Playback may pause if a gap between the content is played.
- There may be a small difference between the chapter boundary and the actual playback picture.
- A title or chapter which is being edited cannot be selected as an item.
- You cannot add a title of still pictures, or a title or a chapter which contains both still and moving pictures, to a playlist.
- By copying (dubbing) a Playlist, a title (Original) of the same contents is created.
- You cannot program a Playlist of contents recorded on a DVD-R/RW disc.
- A black thumbnail with “Recording” means that the title is being recorded or its recording will start within 15 seconds. This thumbnail cannot start playback.

■ Canceling selection of a part

- 1) From the **EDIT MENU Playlist Editing**, press the **▲ / ▼ / ◀ / ▶** buttons to select a part to cancel.
- 2) Press the **QUICK MENU** button.
The Quick Menu appears.
- 3) Press the **▲ / ▼** buttons to select “**Cancel Selected**”, then press the **ENTER** button.
The part you have selected is canceled.

■ Confirming the first and last scenes of a part or a Playlist

You can play the first and last scenes for 3 seconds (Preview). (If a title contains several chapters, the first and last scenes of the chapters are also played.)

Preview of a part:

- 1) At step 4 on  page 91, select a title or a chapter, then press the **QUICK MENU** button.
- 2) Press the **▲ / ▼** buttons to select “**Preview**”, then press the **ENTER** button.

Preview of all parts:

- 1) Move the cursor to an any part (in the lower area), then press the **QUICK MENU** button.
- 2) Press the **▲ / ▼** buttons to select “**Playlist Preview**”, then press the **ENTER** button.

■ Confirming the title information

- 1) At step 4 on  page 91, select a title or a chapter, then press the **QUICK MENU** button.
- 2) Press the **▲ / ▼** buttons to select “**Title Information**” then press the **ENTER** button.

■ Correcting a Playlist

You can add or delete parts to correct a Playlist.

- 1) From the **CONTENT MENU**, select a **Playlist** to correct.
- 2) Press the **QUICK MENU** button.
- 3) Press the **▲ / ▼** buttons to select “**Playlist Re-editing**” and then press the **ENTER** button.
The **EDIT MENU Playlist Editing** appears.

Follow the procedure from steps 4 on  page 91, add or delete parts as necessary.

Note

- You cannot edit a title (Playlist) of still pictures, or a title (Playlist) which contains both still and moving pictures.

■ Using a part in a Playlist also in another Playlist

- 1) In play or stop mode of a **Playlist** title, press the **EDIT MENU** button.
The **EDIT MENU Main Menu** appears.
- 2) Press the **▲ / ▼ / ◀ / ▶** buttons to select “**Playlist Editing**,” then press the **ENTER** button.
The **EDIT MENU Playlist Editing** appears.
- 3) Press the **▲ / ▼ / ◀ / ▶** buttons to select “**Start**” then press the **ENTER** button.
The areas of title name and part selection become blank.
- 4) Following the procedures outlined on  page 91, make a **Playlist**.

■ Naming a title (Playlist)

- 1) Move a cursor to the lower side (selected parts) then press the **QUICK MENU** button.
- 2) Press the **▲ / ▼** buttons to select “**Edit Title Name**,” then press the **ENTER** button.
A keyboard appears.
- 3) Following the procedures outlined on  page 30, enter a title name.

Note

- You can name a title also while viewing its information. From the **CONTENT MENU Title List**, select a title and press the **QUICK MENU** button then select “**Title Information**” by the **▲ / ▼** buttons and the **ENTER** button. Further press the **QUICK MENU** button, and select “**Edit Title Name**” by the **▲ / ▼** buttons and the **ENTER** button.

■ **Making a Playlist of recorded contents of which starting times are the same**

This will help to sort serials.

1) From the **CONTENT MENU Title List**, press the **QUICK MENU** button.

2) Press the **▲ / ▼** buttons to select “**Edit Function**”, then press the **ENTER** button.

3) Press the **▲ / ▼** buttons to select the item.

“**XXXXX**”

To sort out programs recorded on the same time of the same day of the week to make a Playlist.

“**YYYYY**”

To sort out programs recorded on the same time on Monday to Friday to make a Playlist.

4) Press the **ENTER** button.

Notes

- Only titles (Original) can be sorted.
- The maximum number of sorted titles is 99.
- If you modify the recording start time or date of one of the recorded serials, the title will not be sorted out. Contrarily, any program can be sorted if its channel, recording start time and date are modified as the same as others.
- “**YYYYY**” can sort titles even if they are not complete 5 collections of Monday to Friday, on condition that they have the same channel and recording start time, and any recording date except Saturday and Sunday.

Creating Thumbnails (Changing the picture on the CONTENT MENU)

You can register your favorite scene as a thumbnail displayed on the CONTENT MENU.
On a finalized DVD-R/RW disc, this feature is not available.

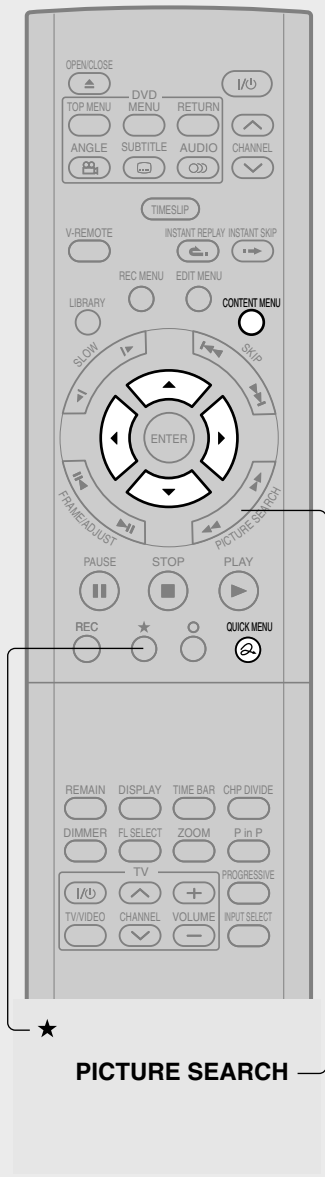

PICTURE SEARCH

1 During stop or playback, press CONTENT MENU.

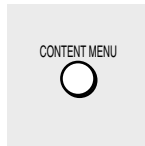

The CONTENT MENU Title List appears.

e.g.

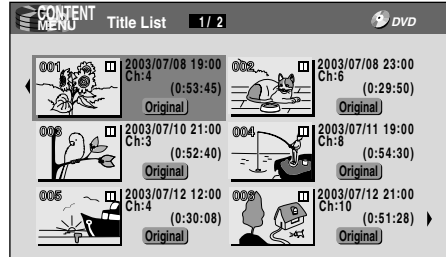

2 Press ▲ / ▼ / ◀ / ▶ to select a title whose thumbnail you want to change.

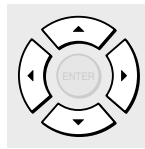

- To go to the next or previous page, press the PICTURE SEARCH (◀◀ / ▶▶) button.
- To select a chapter, select a title and press the ★ button. The Chapter List appears. By pressing the ★ button again, you can return to the Title List.

3 Press QUICK MENU.

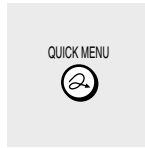

The Quick Menu appears.

e.g.

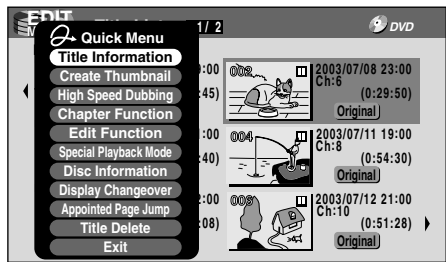

(Continued)

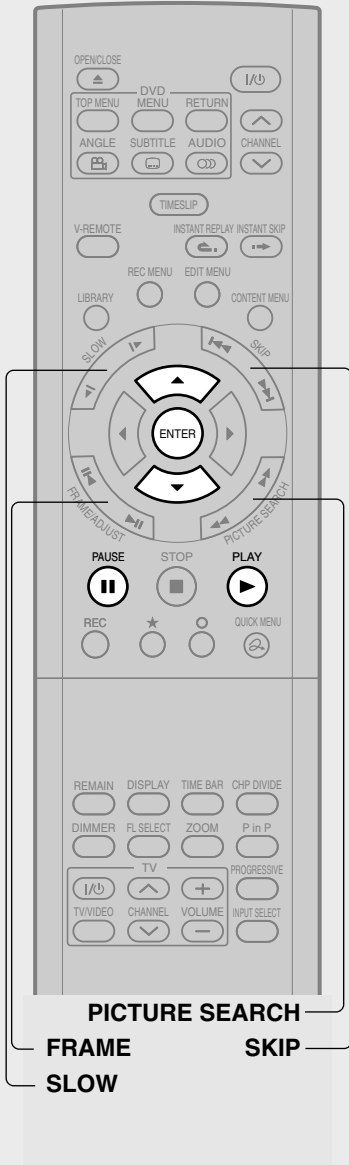

Note

- There may be a small difference between a thumbnail made on the Create Thumbnail display and that displayed in the CONTENT MENU. Operation with the PICTURE SEARCH button may extend the difference.

(Continued)

4

Press ▲ / ▼ to select “Create Thumbnail” (or “Create CHP Thumbnail” if selected a chapter at step 2), then press ENTER.

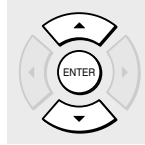

The Content Menu Create Thumbnail display appears. e.g.

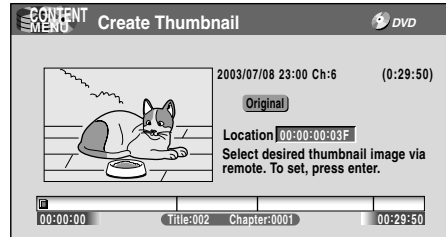

5

Press PLAY to start playback.



Locate a scene you want to capture as a thumbnail. You can use the following buttons. PICTURE SEARCH, FRAME, SLOW, SKIP, PAUSE, etc.

6

At the point where you want to capture a thumbnail image, press PAUSE.

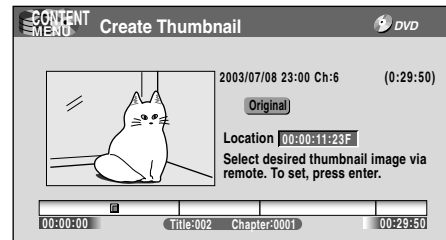

7

Press ENTER.



The CONTENT MENU returns. The selected scene is displayed as a thumbnail.

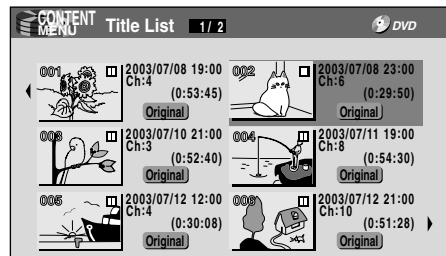

Notes

- You cannot create thumbnails of chapters in a title that contains a still picture.
- If you create a chapter thumbnail, and then shift the chapter mark (▶ page 88) or record or edit the disc on other devices, the chapter thumbnail may return to the top of the chapter.

Introduction

Recording

Playback

Editing

Library

Function setup

Others

High Speed Library Dubbing (Dubbing only a specified part)

This section explains how to copy a title or chapter recorded on a DVD-RAM disc within the same disc at high speed (high speed: in a shorter time than actual playing time of the title or chapter). Follow this procedure when you reproduce a title (Original) from a title (Playlist).

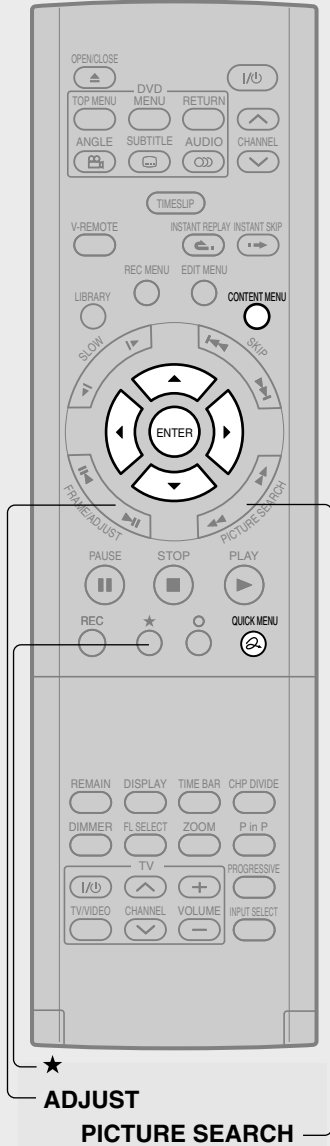

1 During playback or stop, press CONTENT MENU.

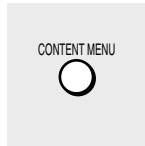

The CONTENT MENU Title List appears.

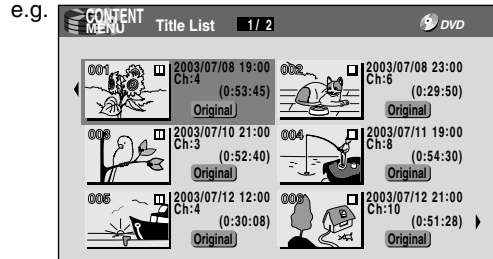

2 Press ▲/▼/◀/▶ to select a part (a title or chapter) to copy or move.

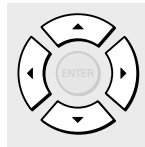

- You can go forward/back to pages by pressing the PICTURE SEARCH (◀◀/▶▶) button. You can jump to a page by specifying the page number. Press the QUICK MENU button, select “Appointed Page Jump”. Use the ADJUST button to change the page number.
- To select a chapter, highlight a title and press the ★ button. If you press the button again, the title list reappears.

3 Press QUICK MENU then select “High Speed Dubbing” pressing the ▲/▼ buttons from the Quick Menu, then press ENTER.



The CONTENT MENU High Speed Library Dubbing appears.

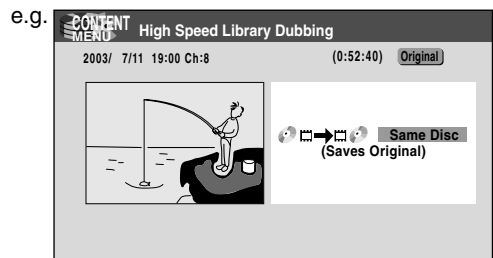

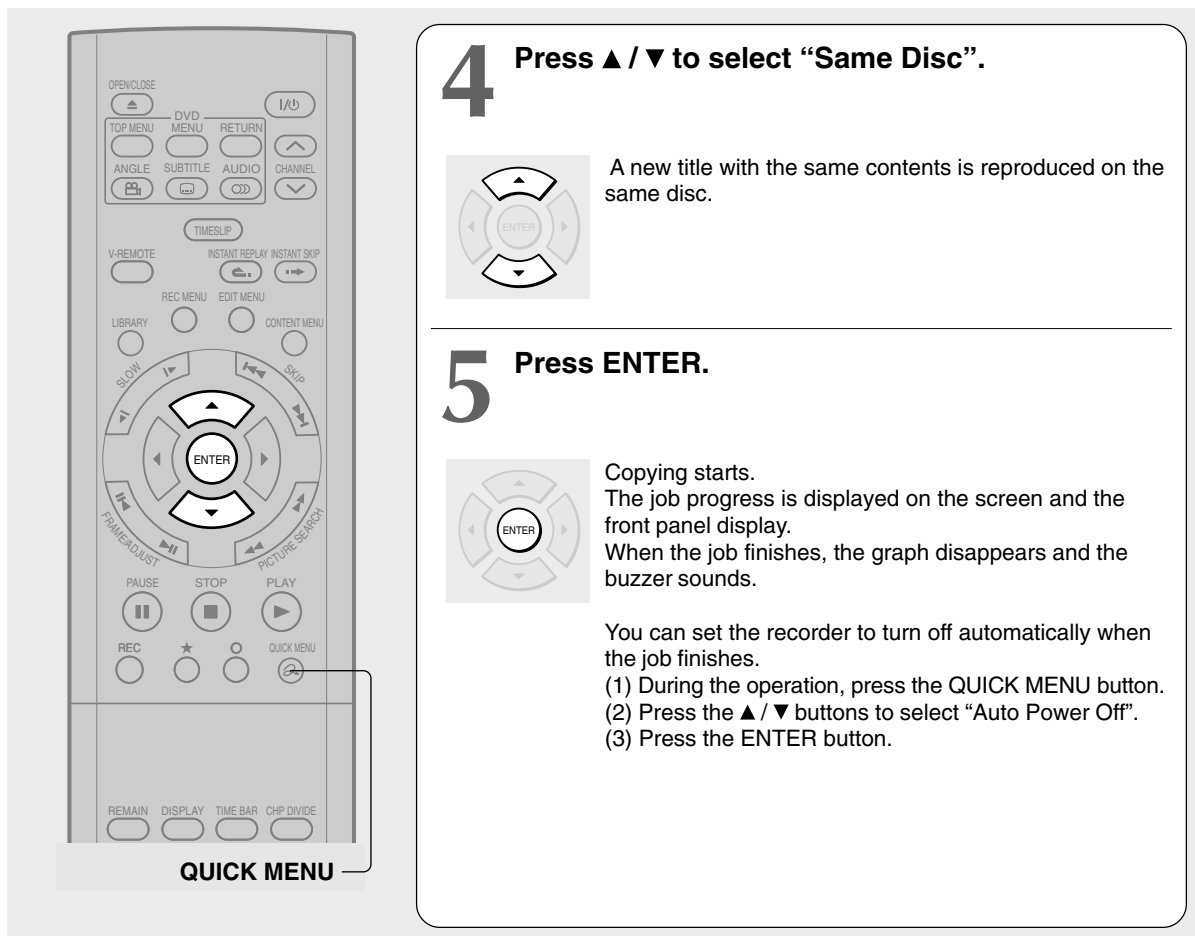

4 Press ▲ / ▼ to select “Same Disc”.

A new title with the same contents is reproduced on the same disc.

5 Press ENTER.

Copying starts.
The job progress is displayed on the screen and the front panel display.
When the job finishes, the graph disappears and the buzzer sounds.

You can set the recorder to turn off automatically when the job finishes.
(1) During the operation, press the QUICK MENU button.
(2) Press the ▲ / ▼ buttons to select “Auto Power Off”.
(3) Press the ENTER button.

QUICK MENU

Notes

- Copying a Playlist makes an Original, leaving the Playlist as it is.
- A title or a chapter becomes a title by being copied.
- Copying is interrupted when a programme recording is about to start.
- Copying using a DVD video disc, VIDEO CD, audio CD, CD-R, CD-RW, DVD-R or DVD-RW disc is not possible.
- If copying is not allowed due to some conditions, such as lack of disc space, etc., a message will appear. Follow the procedure indicated there.
- Depending on the contents, some reference information or appendix data may not be copied.
- A title that contains a still picture cannot be copied.

■ To cancel copying halfway through the operation

- 1) During copying, press the QUICK MENU button.
The Quick Menu appears.
- 2) Press the ▲ / ▼ buttons to select “Cancel Dubbing”, then press the ENTER button.

Note

- Cancellation of a copying operation will result in deletion of a portion of the title or chapter already copied.

Delete Selected Items (Deleting specified parts together)

This section explains how to simultaneously delete unnecessary titles, or unnecessary chapters. On a finalized DVD-R/RW disc, this feature is not possible.



1 During playback or stop, press EDIT MENU.

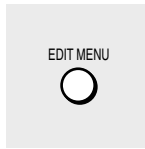

The EDIT MENU Main Menu appears.

2 Press ▲ / ▼ to select “Del Selected Items”.

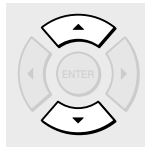

e.g.

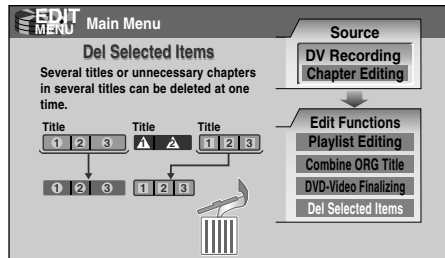

3 Press ENTER.



The EDIT MENU Del Selected Items appears.

e.g.



Thumbnails of the parts in the disc are displayed in the upper area.



QUICK MENU

4 Following steps 4 to 6 on ➡ page 91, 92, assemble the items to delete.

5 Press ▼ repeatedly to select “Start”, then press ENTER.



The recorder begins the deletion process. To cancel deleting, press the ◀/▶ buttons to select “No”, then press the ENTER button.

When the process is finished, the EDIT MENU Main Menu returns.

Notes

- To confirm the first and last scenes of an item, first select an item then press the QUICK MENU button. Press the ▲ / ▼ buttons to select “Preview a Selected Title” (or “Title Information”) then press the ENTER button.
- Titles and chapters show their names for about 2 seconds at the bottom of the screen when they are selected.
- On a DVD-RW disc, deleting can restore the disc space only for the last recorded title.
- Deleting cannot be canceled once started. Be careful to execute the deleting.
- If you select a title for the part to be removed, you cannot select chapters in that title.
- Chapters in DVD-R/RW discs cannot be selected to delete.

Combine Original Titles (Combine two titles into one)

Use this feature to combine two titles into one. The second title is deleted and the second title is added to the end of the first title.

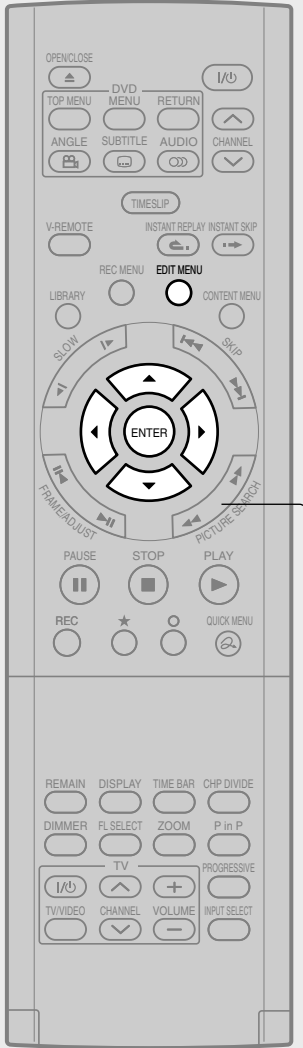

PICTURE SEARCH

1 During playback or stop, press EDIT MENU.



The EDIT MENU Main Menu appears.

2 Press ▲ / ▼ to select “Combine ORG Title”, then press ENTER.

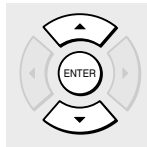

The Combine ORG Title display appears.

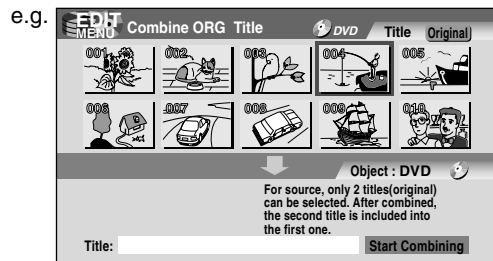

3 Press ◀ / ▶ to select the first title to merge.

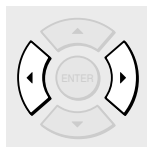

Press the PICTURE SEARCH button to move to the previous or next page.

4 Press ENTER.



The cursor appears in the lower area of the screen (the title to merge to).

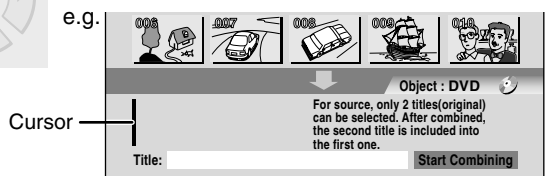

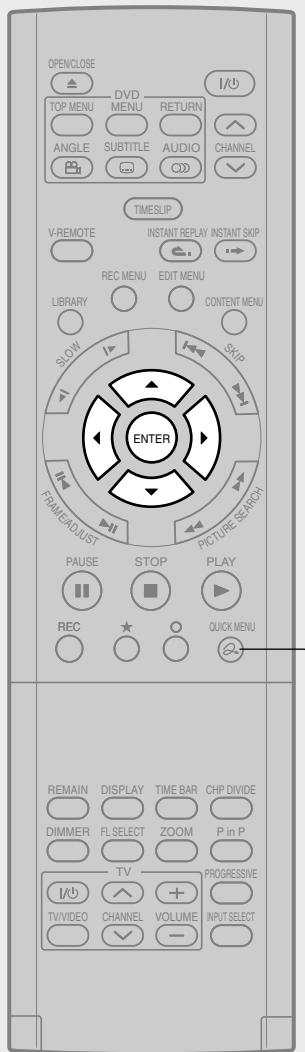

QUICK MENU

5 Press ◀/▶ to select the location to put the part and press ENTER.

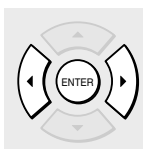

It is fixed at the left side at the beginning. Press the ENTER button. The selected part moved into the location of the cursor.

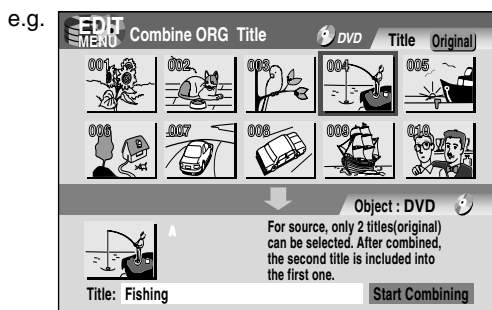

6 Perform steps 3 to 5 and select the second title.

You cannot select the same title.

To cancel the registered part:

- 1) Select the part that you want to cancel, and press the QUICK MENU button to display the Quick Menu.
- 2) Press the ▲ / ▼ buttons to select "Cancel Selected Title" (or "All Clear" for cancelling the selection of multiple items at a time).
- 3) Press the ENTER button.

7 Press ▲ / ▼ to select "Start combining" and press ENTER, then select "Yes" and press ENTER.

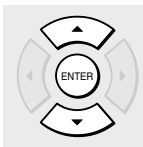

The combining process starts.

Notes

- You cannot stop the combining process after it has started.
- You cannot combine a protected title or a title containing still pictures.
- The title name of the first title is given to the title after combining.
- The second title is combined into the first title, maintaining the chapter divisions and chapter names.
- Titles and chapters show their names for about 2 seconds at the bottom of the screen when they are selected.

DVD-Video finalizing process

The recorder processes recorded data in a DVD-R/RW disc so that it can be played on other compatible devices.

Important

- You cannot rewrite data onto a disc after you execute the DVD-Video finalizing process. However, the disabled rewritability of a DVD-RW disc can be restored by canceling the process of the disc. (▶ page 107) On DVD-R discs, canceling of the DVD-Video finalizing process is not available.

■ Preparation

- Load a DVD-R/RW disc you want to execute the finalizing process.



1 During playback or stop, press EDIT MENU.



The EDIT MENU Main Menu appears.

2 Press ▲ / ▼ to select “DVD-Video Finalizing”.

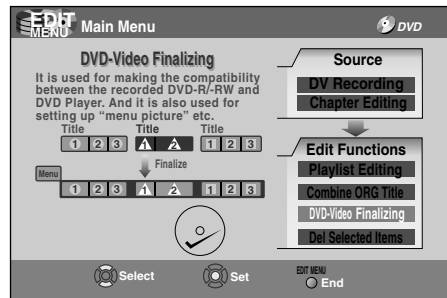
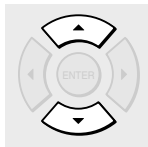

3 Press ENTER.



A display of option settings appears.



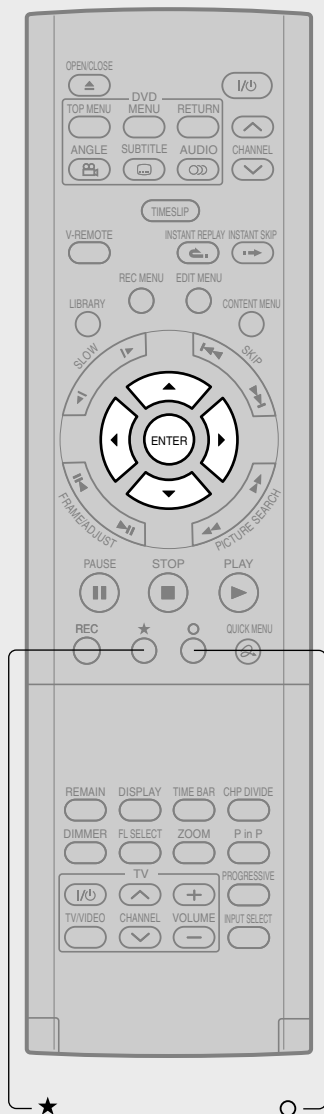

4 Press ▲ / ▼ / ◀ / ▶ to select.

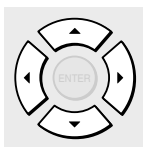

As you select each item, its explanation accompanies.

When “Create Menu” is set to “None”:
“Start Play” and “After play one title” are automatically omitted.

5 Press ▲ / ▼ to select “Next”, then press ENTER.



Information on data to be processed appears.

e.g.

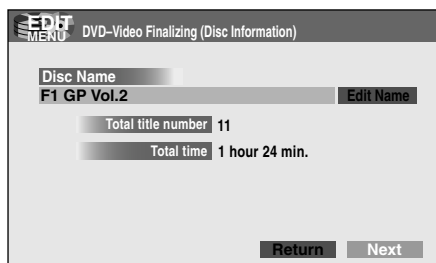

If you press the ▲ button to select “Edit Name” then press the ENTER button, a keyboard appears so that you can enter a title name.

When “Create Menu” is set to “None”:

Select “Writing” at the right bottom by the ▲ / ▼ / ◀ / ▶ buttons and press the ENTER button. Skip to step 10.

6 Press ▼ to select “Next”, then press ENTER.



When “Create Menu” is set to “Both” or “Only Title”, a display of menu color selection for titles appears.

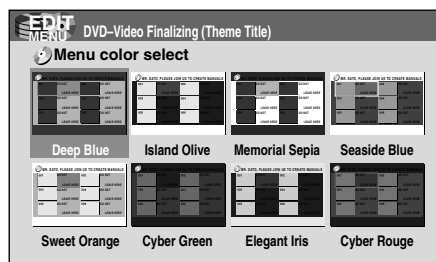

If you press the ★ button, you can preview the selected theme. To return, press the O button.

(Continued)

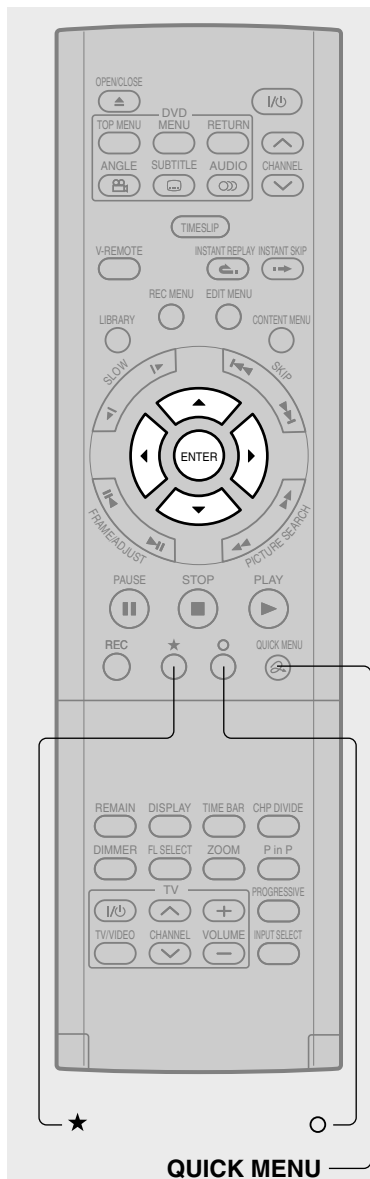

(Continued)

7 Press **▲/▼/◀/▶** to select the menu color of titles, then press **ENTER**.

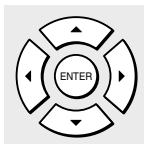

A display of menu color selection for chapters appears.

8 Press **▲/▼/◀/▶** to select the theme of chapter menus.

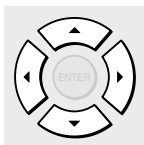

A selected menu color is applied to all chapters. You cannot allocate a menu color to each chapter. If you press the **★** button, you can preview the selected menu color. To return, press the **O** button. If you press the **▼** button during preview, to select "Return" then press the **ENTER** button, you can go to the preview of the selected menu color of titles. To return to that of chapters, press the **▲/▼/◀/▶** buttons to select a number in "Chapter" then press the **ENTER** button.

9 While viewing the "Chapter" display, press **ENTER**, and select "Yes" using **◀/▶**, then press **ENTER**.

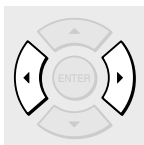

A message appears to ask you if you make the power turn off automatically or not when the process is completed.

10 Press **◀/▶** to select "Yes" or "No" then press **ENTER**.

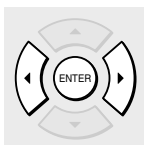

A message disappears and the finalize process starts. The progress is displayed on the screen and in the front panel display on the recorder.

Notes

- DVD-R/RW discs recorded on this recorder may not be recognized on other devices unless you execute DVD-Video finalizing process to them.
- You can record onto a DVD-R disc additionally to the limit of the disc capacity, unless you execute the DVD-Video finalizing process to it. Deleting of recorded titles is also possible, however, the disc space cannot be restored.
- You can record onto a DVD-RW disc additionally to the limit of the disc capacity. Deleting of recorded titles is also possible.
- On DVD-RW discs, it is possible to cancel the DVD-Video finalizing process or to initialize for a new use.

■ To cancel the finalize process **DVD-RW**

You can cancel the DVD-Video finalizing process executed to a DVD-RW disc so that the disc can be recordable again.

1) During stop, press the QUICK MENU button.

A quick menu appears.

2) Press the ▲ / ▼ buttons to select “Disc Format” then press the ENTER button.

3) Press the ▲ / ▼ buttons to select “Cancel Finalizing” then press the ENTER button.

3) Read the message, and press the ◀ / ▶ buttons to select “Yes”, then press the ENTER button.

The process starts.

Notes

- While the recorder is ready to start a programmed recording, you cannot cancel the DVD-Video finalizing process.
- You cannot cancel the DVD-Video finalizing process executed on a DVD-RW disc recorded on other device.
- You cannot cancel the DVD-Video finalizing process executed on a DVD-RW disc if the disc is protected.
- Canceling the DVD-Video finalizing process may shift the thumbnails of titles/chapters.

DV Recording (Recording from a digital video camera)

You can connect a DV format digital video camera to the DV terminal to record from it.

■ Preparation

- Connect a DV format digital video camera to the DV terminal on the front panel.

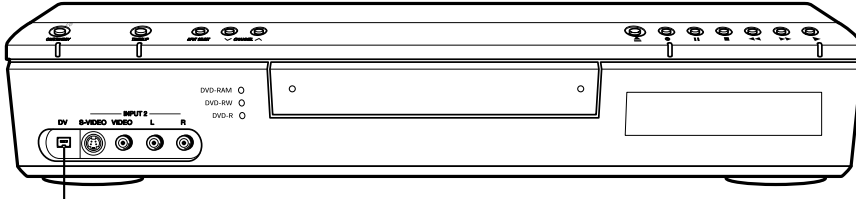

DV terminal



1 During playback or stop, press EDIT MENU.



The EDIT MENU Main Menu appears.

2 Press ▲ / ▼ to select “DV Recording”.

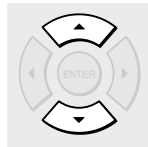

e.g.

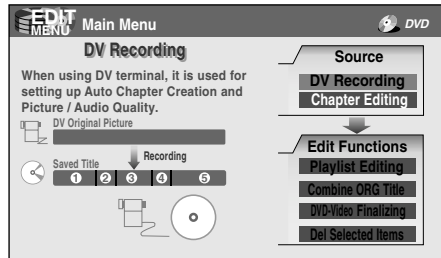

3 Press ENTER.



The DV Recording (Option Setting) display appears.

e.g.

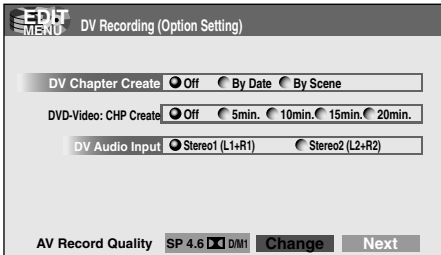

This display appears also when a DV format digital video camera connected to the DV terminal is turned on.

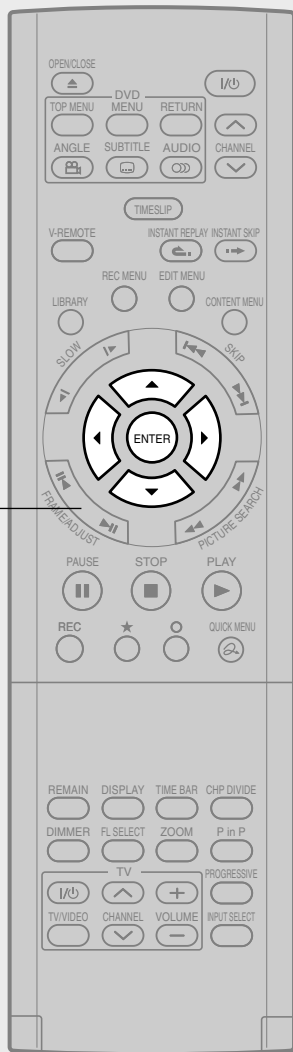

ADJUST

4 Press ▲ / ▼ / ◀ / ▶ to make the settings.

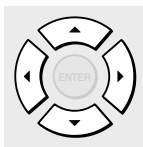

As you select each item, its explanation accompanies.

To change the picture and sound rates:

- 1) Press the ▲ / ▼ buttons to select “Change” then press the ENTER button.
- 2) On the “AV Record Quality” display, press the ADJUST button to select a setting number.
- 3) Press the ENTER button.

5 Press ▲ / ▼ / ◀ / ▶ to select “Next”, then press ENTER.

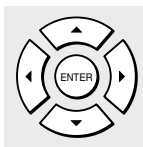

Details on the recording appears.

e.g.

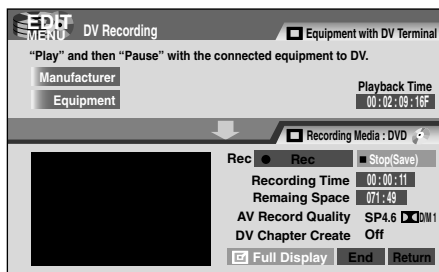

6 Play the connected DV format digital video camera and pause the play at a desired scene.

7 Press ▲ / ▼ / ◀ / ▶ to select “Recording”, then press ENTER.

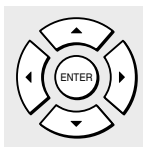

Recording starts.

- To pause the recording, select “Pause” by the ▲ / ▼ / ◀ / ▶ buttons then press the ENTER button.
- To stop the recording, select “Stop (Save)” by the ▲ / ▼ / ◀ / ▶ buttons then press the ENTER button.

Notes

- The DV terminal of this recorder supports only input from a DV format digital video camera. It cannot output to a connected device. Some models of DV format digital video cameras may be not compatible.
- At step 5, you can enlarge a thumbnail by selecting “Full Display”, then pressing the ENTER button.
- If “DV Chapter Create” is set to “Off” and you record onto a DVD-R/RW disc, chapters are automatically made according to the “DVD-Video: CHP Create” setting (➡ page 130). The number of chapters has the limit. Chapters are divided with a margin of about 0.5 second or less according to the DVD-Video standard.
- DV recording does not start in the following cases:
 - While recording or in the time slip mode.
 - While operating a REC MENU, CONTENT MENU or LIBRARY MENU.
 - If the recorder’s clock is not set yet.
 - Within 5 minutes before a programmed recording starts, or during a programmed recording is being executed.
- If a DV recording overlaps with a programmed recording, the DV recording will stop 5 minutes before the programmed recording starts, and the programmed recording will be executed.
- DV recording does not work if the DV terminal is connected equipment other than DV format digital video camera, such as a PC.
- Depending on the connected DV format digital video camera, the display at step 5 may not show “Manufacturer” or “Equipment”.
- If the DV terminal is connected more than one DV format digital video camera, DV recording may not work properly. For proper functioning of DV recording, connect only one device to the DV terminal.
- Keep the DV terminal not connected unless you record from a DV format digital video camera, as it may give influence on the recorder if operated.
- If you start a recording and do not operate for about 15 minutes, the display switches to the full mode, when “Screen Protector” (➡ page 127) is set to “On.” Pressing the ENTER button while “Detail Display” is selected can restore the previous display.
- “DV Chapter Create” is not available when recording to a DVD-RAM disc.
- To record stereo sound from the connected DV format digital video camera, connect it to the INPUT 1 jacks using compatible cables such as supplied audio/video cables.
- To record stereo sound from the connected DV format digital video camera, connect it to the input jacks using compatible cables such as supplied audio and video cables. (➡ page 36)
- If a DV format digital video camera is not recognized, pull out the plug and connect it again.
- Some models of DV format digital video cameras may support a different compression format. From such equipment, recording is not possible.
- Depending on the models of DV format digital video cameras, recording may not work properly or some functions may be disabled.
- On an input source from a DV tape which is partly recorded over, “DV Chapter Create” may not work properly.

Library data

To facilitate your collecting.

- **Using Library data**

Using Library data

The recorder has a database called “Library”. This database provides a list of numbers, names and remaining spaces of all registered DVD-RAM discs. On this list, you will easily find a desired or available disc.

You can utilize Library data as follows.

- To check or change information of disc.
- To check the remaining space of a DVD-RAM disc.

Basic operation of the Library system



1 Press LIBRARY.

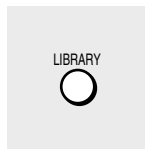

The LIBRARY MENU Title Summary (All Titles) appears.

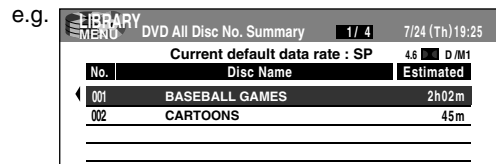

2 Press QUICK MENU.

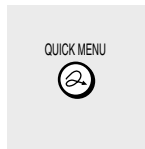

A Quick Menu appears.

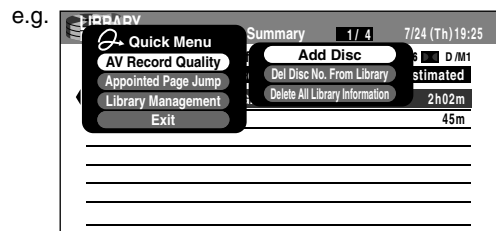

3 Press ▲ / ▼ to select an item, then press ENTER.

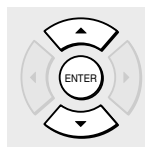

For details on each item, see from the next page.

Notes

- To cancel this procedure, press the LIBRARY button.
- The Library system does not support DVD-R/RW discs.
- The Library system supports DVD-RAM discs that do not show a statement on its package such as “This disc can copy images that permit copying once,” however, once the DVD-RAM disc is operated on other device, the Library data of the disc may not function properly. Use DVD-RAM discs with the said statement.
- The capacity of the database is 60 discs.
- The LIBRARY MENU may not display all characters of a registered name of a disc.

Checking remaining space on discs

- 1) Load a DVD-RAM disc and press the **LIBRARY** button.
- 2) Press the **QUICK MENU** button.
- 3) Press the **▲ / ▼** buttons to select “AV Record Quality” then press the **ENTER** button.

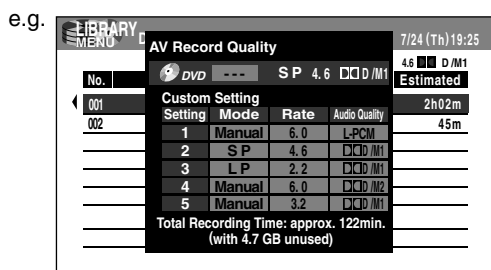

- 4) Press the **ADJUST** button and select the setting (➡ page 129).
- 5) Press the **ENTER** button.

Remaining space is estimated on the condition that you record with the selected setting.

Searching for a disc

- 1) Press the **LIBRARY** button.
- 2) Press the **QUICK MENU** button.
- 3) Press the **▲ / ▼** buttons to select “Appointed Page Jump”, then press the **ENTER** button.

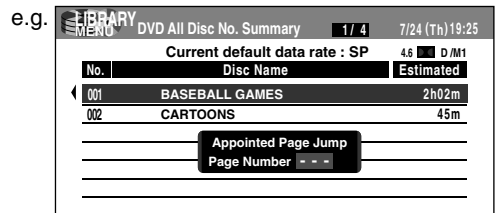

- 4) Press the **▲ / ▼** buttons or the **ADJUST** button to enter the page number.
- 5) Press the **ENTER** button.
The designated page appears.

Maintenance of Library data

The recorder usually controls the Library Management system automatically. However, in the following cases, you must maintain and create data manually.

- When you want to add information about a title, (for example **when you use a DVD-RAM disc recorded on another device, etc.**), to the Library Management system of the recorder.
→ “Registering a disc manually” (➡ page 114).
- When you restart the “Library” database.
→ “Erasing Library data” (➡ page 115).

■ Registering a disc manually

- 1) Load a DVD-RAM disc that contains information you want to add.
- 2) Press the **LIBRARY** button.
- 3) Press the **QUICK MENU** button.
- 4) Press the **▲ / ▼** buttons to select “Library Management”, then press the **ENTER** button.

e.g.

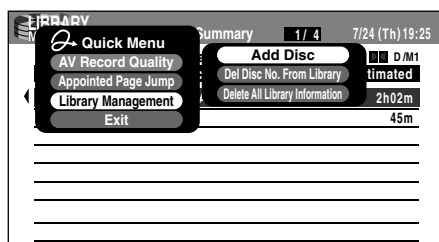

- 5) Press the **▲ / ▼** buttons to select “Add Disc”, then press the **ENTER** button.
- 6) Press the **◀ / ▶** buttons to select “Yes”, then press the **ENTER** button.
All title information is registered.
To cancel, select “No”.

Notes

- To use title information in a DVD-RAM disc recorded on another device, as the Library Management data of the recorder, be sure to follow the procedure of “Registering a disc manually” to add said data to the Library Management system.
- If you record content on a DVD-RAM disc on the recorder and edit the content on the other device, Library data of the disc may be lost or the disc may not function properly.
- When you manually register a disc, several discs in same number consequently may be registered. In such a case, it is recommended to change the disc number (➡ page 57).

■ Forced deletion of disc numbers

A number of an inactive disc can be deleted from the Library Management, so that it can be assigned to a new disc.

- 1) Press the **LIBRARY** button.
- 2) Press the **QUICK MENU** button.
- 3) Press the **▲ / ▼** buttons to select “Library Management”, then press the **ENTER** button.
- 4) Press the **▲ / ▼** buttons to select “Del Disc No. From Library”, then press the **ENTER** button.
- 5) Press the **ADJUST** button to select a number to delete, then press the **ENTER** button.

■ Erasing Library data

You can erase all Library data stored in the recorder to restart the database.

- 1) Press the **LIBRARY** button.
- 2) Press the **QUICK MENU** button.
- 3) Press the **▲ / ▼** buttons to select “Library Management”, then press the **ENTER** button.
- 4) Press the **▲ / ▼** buttons to select “Delete All DVD-RAM Information”, then press the **ENTER** button.
- 5) Press the **ENTER** button.
- 6) Press the **◀ / ▶** button to select “Yes”, then press the **ENTER** button.

Function Setup

You can change the default settings to customize performance to your preference.

- **Customizing the Function Settings**

Customizing the Function Settings

You can change the default settings to customize performance to your preference.

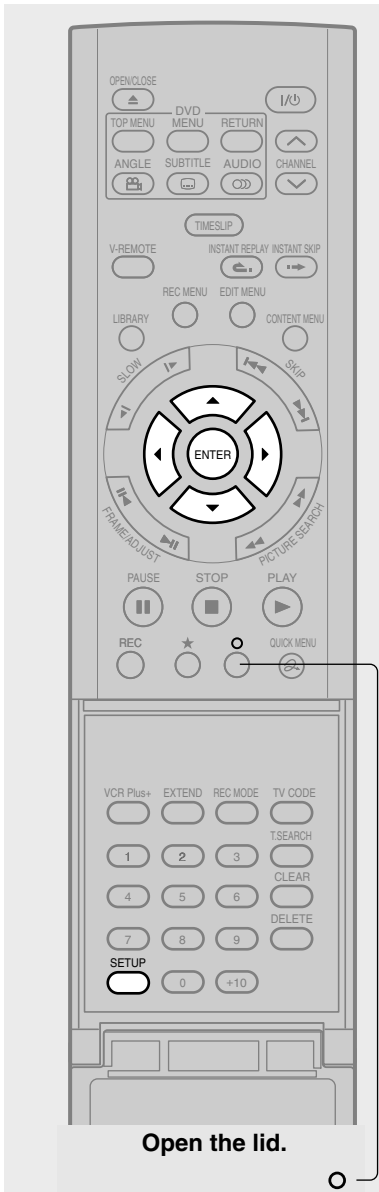

Open the lid.

Notes

- The SETUP button can function even during normal playback. However some items may be grayed out and they cannot be selected. In this case, try again after playback is stopped.
- The SETUP button does not function during recording, Recorded Title Play, Chase Play or Pause TV modes.

1 During stop, press SETUP.



The following setup display appears.



2 Press ◀/▶ to select the icon of a group that contains a desired item, then press ENTER.

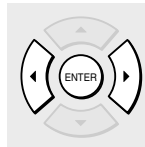

For details on each setting, see the next page.

e.g. When "Display Settings" is selected:

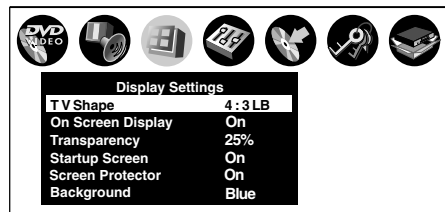

3 Press ▲/▼ to select a desired item, then press ENTER.

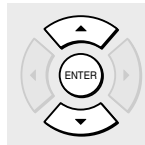

4 Refer to the explanations on pages beginning from 120, to change the selection by ▲/▼ or other buttons, then press ENTER.

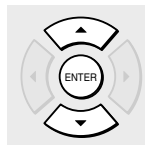

- To select another item in the same group, repeat steps 3 to 4.
- To shift to another group, press the O button then repeat steps 2 to 4.

5 Press SETUP.



The setup display disappears and the setting is completed.

Setting	Details	Page
DVD Player Settings		
DVD Disc Menu Language DVD-VIDEO	To select a preferred language for disc menus.	122
DVD Audio Language DVD-VIDEO	To select a preferred language for the sound track.	122
DVD Subtitle Language DVD-VIDEO	To select a preferred language for subtitles.	122
DVD Dynamic Range Control DVD-RAM DVD-RW DVD-R DVD-VIDEO	To turn on or off a function that makes faint sounds easier to hear even if you lower the volume during late-hour playback.	123
Karaoke vocal DVD-VIDEO	To turn on or off the vocal output during DVD KARAOKE disc playback.	123
DVD Parental Lock DVD-VIDEO	To turn the parental lock function on or off.	123
DVD Title Stop DVD-RW DVD-R DVD-VIDEO	To turn on or off a feature that automatically stops playback after a title has been viewed.	124
PBC VCD	To use the menu screen when playing a PBC-controllable VIDEO CD.	124
Picture/Audio Settings		
Pause/Still DVD-RAM DVD-RW DVD-R DVD-VIDEO	To select the resolution of still pictures. (Field/Frame)	125
Black Level DVD-RAM DVD-RW DVD-R DVD-VIDEO VCD	To select the black level of playback pictures.	125
Custom Picture Select DVD-RAM DVD-RW DVD-R DVD-VIDEO VCD	To select from standard or three customized picture settings.	125
Custom Picture Setting DVD-RAM DVD-RW DVD-R DVD-VIDEO VCD	To customize picture quality settings and store them.	125
Progressive Conversion DVD-RAM DVD-RW DVD-R DVD-VIDEO VCD	To select the system of output signal. (Only when connected to a PROGRESSIVE TV.)	125
Play DNR DVD-RAM DVD-RW DVD-R DVD-VIDEO VCD	To select a setting for playback at a reduced noise level.	126
Audio Out Select DVD-RAM DVD-RW DVD-R DVD-VIDEO VCD CD	To select an output sound format corresponding to your system connection.	126
Virtual surround DVD-RAM DVD-RW DVD-R DVD-VIDEO	To turn on or off expansive virtual surround sound effects from just two speakers.	126
SAP DVD-RAM DVD-RW DVD-R DVD-VIDEO	To monitor and record SAP broadcast.	126

(Continued)

Setting	Details	Page
Display Settings		
TV Shape DVD-RAM DVD-RW DVD-R DVD-VIDEO VCD	To select a picture size according to the aspect ratio of your TV.	127
On Screen Display DVD-RAM DVD-RW DVD-R DVD-VIDEO VCD CD	To turn on or deactivate the operational status display (e.g., ►) on the TV screen.	127
Transparency DVD-RAM DVD-RW DVD-R DVD-VIDEO VCD CD	To select the transparency of the GUI relative to background pictures.	127
Startup Screen	To turn on or off the Start-up Screen setting that makes the background picture appear automatically when turning on the power.	127
Screen Protector DVD-RAM DVD-RW DVD-R DVD-VIDEO VCD CD	To turn the screen saver on or off.	127
Background	To select a display status when no video signals are present.	127
Operational Settings		
Operation Beep DVD-RAM DVD-RW DVD-R DVD-VIDEO VCD CD	To turn on or off the confirmation beeper announcing when each remote command is received.	128
Recording Complete Beep DVD-RAM DVD-RW DVD-R	To select whether or not a buzzer sounds when dubbing and so forth is finished.	128
IR Code	To switch the codes that operate the recorder.	128
Instant Skip Interval DVD-RAM DVD-RW DVD-R DVD-VIDEO VCD CD	To set the width to skip when the INSTANT SKIP button is pressed once.	128
Instant Replay Interval DVD-RAM DVD-RW DVD-R DVD-VIDEO VCD CD	To set the width to go back when the INSTANT REPLAY button is pressed once.	128
Title Thumbnail Point DVD-RAM DVD-RW DVD-R	To select the position of the thumbnail image counting from the beginning of the title that has been recorded.	128
Title Playback DVD-RAM	To activate resume play per title or continuous play.	128
Still Group Interval DVD-RAM	To select an interval of still picture display.	128

Setting	Details	Page
DVD Recorder Operation		
AV Record Quality DVD-RAM DVD-RW DVD-R	To select a set of picture and sound quality settings for manual programme recording.	129
Picture Record Mode DVD-RAM DVD-RW DVD-R	To make further setting setting when you cannot adjust the image quality with “Custom Picture Setting” of the “Picture/Audio Settings”.	129
Audio Input Level DVD-RAM DVD-RW DVD-R	To adjust the level of recorded sound.	129
Aspect Ratio (Video mode) DVD-RW DVD-R	To set the aspect ratio during DVD-R/RW recording.	130
DVD Video Compatibility DVD-RAM DVD-RW DVD-R	To set the audio during DVD-R/RW recording.	130
DVD-Video: CHP Create DVD-RW DVD-R	To set whether or not chapters are to be automatically created at a specified interval during DVD-R/RW recording.	130
Rec DNR DVD-RAM DVD-RW DVD-R	To activate or deactivate the 3D digital noise reduction.	130
3D Y/C Separation DVD-RAM DVD-RW DVD-R	To activate or deactivate the 3D digital filter to execute Y/C (Brightness/Color) separation.	130
Management Settings		
Genre Setting DVD-RAM DVD-RW DVD-R	To register the frequently used genre in the menu.	131
Eco. Mode	To set the front panel display to turn on/off in the standby mode.	131
DVD-RAM Physical Format DVD-RAM	To perform physical formatting of a DVD-RAM disc.	29
Software Version	To display the version of the software. The version is only displayed and cannot be set.	
DVD Drive Software	To display the version of the DVD drive software. The version is only displayed and cannot be set.	
Initial Settings		
For details concerning “Time & Date Setting”, “TV/CATV”, “Channel Setting”, “Guide Channel Setting”, “Cable Box/DSS” and “Output Channel”, see ➤ page 28, “INSTALLATION GUIDE”.		

DVD Player Settings

DVD Disc Menu Language

DVD-VIDEO

English:

To display disc menus in English.

French:

To display disc menus in French.

Spanish:

To display disc menus in Spanish.

Others:

To make a further language choice.

After pressing the ENTER button, follow steps 1) – 4) below.



- 1) Obtain the language code of the preferred language from the Language Code List (➡ page 139).
- 2) Select the first character by pressing the ▲ / ▼ buttons (or the ADJUST button).
- 3) Press the ◀ / ▶ buttons to shift. Select the second character by pressing the ▲ / ▼ buttons (or the ADJUST button).
- 4) Press the ENTER button.

Note

- Some DVD video discs may not include your preset language. In this case, the recorder automatically displays disc menus consistent with the disc's initial language setting.

DVD Audio Language

DVD-VIDEO

English:

To play sound tracks recorded in English.

French:

To play sound tracks recorded in French.

Spanish:

To play sound tracks recorded in Spanish.

Others:

To make further choices.

After pressing the ENTER button, follow steps 1) - 4) below.



- 1) Obtain the language code of the preferred language from the Language Code List (➡ page 139).
- 2) Select the first character by pressing the ▲ / ▼ buttons (or the ADJUST button).
- 3) Press the ◀ / ▶ buttons to shift. Select the second character by pressing the ▲ / ▼ buttons (or the ADJUST button).
- 4) Press the ENTER button.

Note

- Some DVD video discs may be played in a different language from that you selected. A prior language may be programmed by the disc.

DVD Subtitle Language

DVD-VIDEO

English:

To display subtitles in English.

French:

To display subtitles in French.

Spanish:

To display subtitles in Spanish.

No Subtitle:

To disable subtitles.

Others:

To make a further choice.

After pressing the ENTER button, follow steps 1) – 4) below.



- 1) Obtain the language code of the preferred language from the Language Code List (➡ page 139).
- 2) Select the first character by pressing the ▲ / ▼ buttons (or the ADJUST button).

- 3) Press the ◀/▶ buttons to shift. Select the preceding character by pressing the ▲/▼ buttons (or the ADJUST button).
- 4) Press the ENTER button.

Notes

- Some DVD video discs may be set to display subtitles in a different language from that you selected. A prior subtitle language may be programmed by the disc.
- Some DVD video discs allow you to change subtitle selections only via the disc menu. In this case, press the MENU button and choose the appropriate subtitle language from the selection on the disc menu.

DVD Dynamic Range Control

DVD-RAM DVD-RW DVD-R DVD-VIDEO

Turns on or off a function that makes faint sounds easier to hear even if you lower the volume during late-hour playback.

Off:

The DVD Dynamic Range Control does not function.

On:

The DVD Dynamic Range Control functions.

Notes

- This function is available only for a disc recorded in Dolby Digital format.
- Depending on the disc you play back, the actual effect of this function differs.

Karaoke vocal

DVD-VIDEO

Off:

The main vocal sound is not output.

On:

The main vocal sound is output.

Notes

- This function is available only for a DVD KARAOKE disc recorded in Dolby Digital Multi Channel format.
- If you want to enjoy the KARAOKE function, connect an amplifier or other such device to this recorder.

DVD Parental Lock

DVD-VIDEO

DVD video discs equipped with the Parental Lock function have a predetermined limitation level. The limitation level or limitation method may differ depending on the disc. For example the total disc may not be played back, or an extreme violent scene maybe cut or replaced automatically by another scene.

Important

- Depending on discs, it may not be evident whether the disc is compatible with the Parental Lock function. Make sure that the Parental Lock function you set is activated correctly.

On:

Select this to activate the Parental Lock function or to change the setting.

After pressing the ENTER button, follow steps 1) – 3) below.

Off:

Deactivate the Parental Lock function.

After pressing the ENTER button, follow steps 1) below.

- 1) Enter a 4-digit password by using the number buttons, then press the ENTER button.

If you make a mistake entering your password, press the CLEAR button before pressing the ENTER button, and re-enter the correct password.

- 2) Press the ▲/▼/◀/▶ buttons to move the cursor. Then press the ADJUST button to enter the code of a country/area whose standards were used to rate the DVD video disc, referring to the list below.

(Continued)

Country/Area	Code
AUSTRALIA	AU
BELGIUM	BE
CANADA	CA
CHINA	CN
CHINA HONG KONG	HK
DENMARK	DK
FINLAND	FI
FRANCE	FR
GERMANY	DE
INDONESIA	ID
ITALY	IT
JAPAN	JP
MALAYSIA	MY
NETHERLANDS	NL
NORWAY	NO
PHILIPPINES	PH
RUSSIAN FEDERATION	RU
SINGAPORE	SG
SPAIN	ES
SWEDEN	SE
SWITZERLAND	CH
TAIWAN	TW
THAILAND	TH
UNITED KINGDOM	GB
UNITED STATES	US

3) Select the desired limitation level by pressing the ▲ / ▼ buttons, and then press the ENTER button.

e.g.

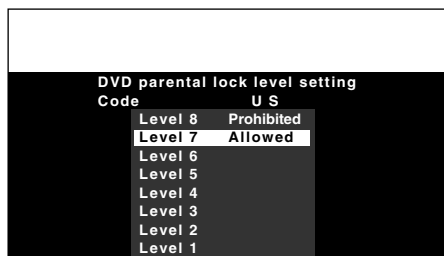

Unless the Parental Lock function is set to “Off”, a disc that has a higher limitation level than your selected limitation level cannot be played back. For example, if you select level 7, discs exceeding level 8 are locked and cannot be played back.

When “US” is selected, its limitation level corresponds to the following settings.

- Level 7 : NC-17 Level 3 : PG
- Level 6 : R Level 1 : G
- Level 4 : PG13

■ To change the limitation level of the Parental Lock function

Follow step 1) - 3) above.

■ To change the password

1) Press the STOP button 4 times after selecting “On” and “Off” in order, and then press the ENTER button.

The password is cleared.

2) Enter a new 4-digit password by using the number buttons.

3) Press the ENTER button.

DVD Title Stop

DVD-RW DVD-R DVD-VIDEO

Off:

Plays back all following titles on the disc after the current title has been viewed.

On:

Recorder is stopped after playback of current title being viewed is completed.

PBC

VCD

Off:

Selects normal playback without using the menu screen of a PBC-controllable VIDEO CD.

On:

Selects playback using the menu screen of a PBC-controllable VIDEO CD.

Picture/Audio Settings

Pause/Still

DVD-RAM DVD-RW DVD-R DVD-VIDEO

Auto:

Normal setting. Pause the moving image without blurring.

Frame:

Displays high resolution still image.

Black Level

DVD-RAM DVD-RW DVD-R DVD-VIDEO VCD

Normal:

Normal black level.

Enhanced:

To display deeper, richer black than in "Normal" setting.

Custom Picture Select

DVD-RAM DVD-RW DVD-R DVD-VIDEO VCD

Select from between 4 picture settings (Normal, Setting 1-3) you stored in the memory.

Custom Picture Setting

DVD-RAM DVD-RW DVD-R DVD-VIDEO VCD

You can adjust fine picture quality and store up to 3 custom picture settings in the memory of the recorder.

- 1) Press the **▲ / ▼** button to select a desired setting from 3 settings, and then press the **ENTER** button.

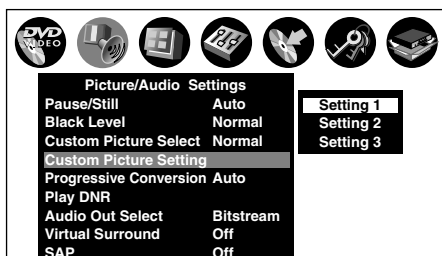

- 2) Press the **▲ / ▼** buttons to select adjustable items, and then press the **◀ / ▶** buttons to select each parameter.

Brightness

(0) Darker ⇔ Brighter (7)

Contrast

(-7) Lower ⇔ Higher (0)

Color

(-7) Duller ⇔ Brighter (0)

Edge Enhance

(OFF) Soft ⇔ Sharp (ON)

- 3) After adjusting the items, press the **ENTER** button.

Progressive Conversion

DVD-RAM DVD-RW DVD-R DVD-VIDEO VCD

There are two types of source content in pictures recorded in DVD video discs: film content (pictures recorded from films at 24 frames per second) and video content (video signals recorded at 30 frames per second). Make this selection according to the type of content being viewed.

Auto:

Select this position normally.

The DVD player automatically detects source content, film or video, of playback source, and converts that signal in the progressive output format in an appropriate method.

Video:

The DVD player filters video signal, and converts it in the progressive output format appropriately. Suitable for playback of video content pictures.

Film:

The DVD player converts film content pictures in the progressive output format appropriately. Suitable for playback of film content pictures. The progressive output feature will be most effective under this selection.

Note

- Depending on the disc, pictures may be cut off or doubled. In this case, select "Video."

Customizing the Function Settings (Continued)

Play DNR

DVD-RAM DVD-RW DVD-R DVD-VIDEO VCD

Selects a setting for playback at a reduced noise level. Press the ▲ / ▼ buttons to select an item then select “On” or “Off” using the ◀ / ▶ buttons.

DNR:

Off:
Not activated.

On:
Reduces the noise levels of brightness signals and color signals present in the video signal during playback.

Mosquito NR:

Off:
Not activated.

On:
Reduces mosquito (flicker) noise occurring in the contour sections of images.

Block NR:

Off:
Not activated.

On:
Reduces noise that appears in the form of blocks (block noise) in a portion of the screen during playback of images with rapid movement.

DNR is the abbreviation for Digital Noise Reduction.

Notes

- DNR effects vary depending on the disc.
- Detailed images may no longer be visible depending on the scene due to the effects of DNR.
- Depending on the disc or scene, “On” may produce undesirable picture artifacts or increase noises on contours. In this instance, select “Off.”
- While you are using the zoom feature to progressive signals, “DNR” does not function.

Audio Out Select

DVD-RAM DVD-RW DVD-R DVD-VIDEO VCD CD

Selects an output sound format corresponding to your audio system connection.

For details about output sound selection, see ➡ page 75.

Bitstream:

Select this when an amplifier equipped with built-in Dolby Digital, DTS or MPEG1 decoder is connected to this recorder.

When you play back a disc recorded in Dolby Digital, DTS or MPEG1 format, digital audio signal is output.

Analog 2ch:

Select this when a TV or other audio device is connected to this recorder via the ANALOG output connectors.

PCM:

Select this when a 2ch digital stereo amplifier is connected to this recorder. When you play back a disc recorded in Dolby Digital or MPEG1 format, the sound is converted to the PCM (2ch) format and output.

Virtual surround

DVD-RAM DVD-RW DVD-R DVD-VIDEO

This lets you playback discs with acoustic effects having greater depth and presence even when using only two speakers.

Off:
Virtual surround effect not activated.

On:
Virtual surround effect activated.

Notes

- This function is only activated when playing back a disc recorded with Dolby Digital.
- This function is only activated when “Audio Out Select” is set to “PCM” if the BITSTREAM/PCM jack of this DVD recorder is connected to an amplifier or similar device.
- When the virtual surround effect is activated, Dolby Progressive Sound may be deactivated or sound differently than usual.
- When the virtual surround effect is activated, the volume may sound differently than usual.
- Set “Virtual surround” to “Off” if the audio sounds distorted.

Manufactured under license from QSound Labs, Inc. U.S. patent Nos. 5,105,462, 5,208,860 and 5,440,638 and various foreign counterpart. Copyright QSound Labs, Inc. 1998-2002. QXpander™ is a trademark of QSound Labs, Inc. All rights reserved.

SAP

SAP (Second Audio Program broadcast) is separate audio program, usually broadcast in a second language with the main language.

Off:
The main sound is received.

On:
SAP sound (second language) is received.

Display Settings

TV Shape

DVD-RAM DVD-RW DVD-R DVD-VIDEO

Select a picture size according to the aspect ratio of your TV.

For details on this setting, see “TV shape setting” (➡ page 42, “INSTALLATION GUIDE”).

On Screen Display

DVD-RAM DVD-RW DVD-R DVD-VIDEO VCD CD

Off:

Deactivates the operational status display (e.g., ►) on the TV screen.

On:

Activates the operational status display (e.g., ►) on the TV screen.

Transparency

DVD-RAM DVD-RW DVD-R DVD-VIDEO VCD CD

Selects the transparency of the GUI and its relationship to the background image.

0% : 25% : 50%

Startup Screen

DVD-RAM DVD-RW DVD-R DVD-VIDEO VCD CD

Off:

The startup screen is not displayed.

On:

The startup screen appears automatically when turning on the power.

Screen Protector

DVD-RAM DVD-RW DVD-R DVD-VIDEO VCD CD

To prevent TV screen damage (image burn), this function disengages the pause mode of a playback image. The display returns to the normal TV screen when the recorder remains idle for more than 15 minutes. In time slip mode, the playback pause is released.

If this function is set to “On”, the recorder, if freezes, may return to the normal by leaving it for about 15 minutes or longer.

Off:

Deactivates the Screen Protector function.

On:

Activates the Screen Protector function.

Background

DVD-RAM DVD-RW DVD-R DVD-VIDEO VCD CD

Selects a screen color when receiving no video signals such as selecting a non-broadcasting channel.

Off:

No color.

Black:

Black is displayed.

Blue:

Blue is displayed.

Important

- Depending on signal reception, the Background setting may be cleared. To prevent this, set this function to “Off”.

Operational Settings

Operation BEEP

DVD-RAM DVD-RW DVD-R DVD-VIDEO VCD CD

Turn on or off a confirmation beeper announcing when a command is received.

Off:

Turns off the beep sound.

On:

Turns on the beep sound.

Note

- You cannot turn off beeps for alerts irrespective of this setting.

Recording Complete BEEP

DVD-RAM

This is used to set whether or not a buzzer sounds when dubbing and so forth is finished.

Off:

Buzzer does not sound.

On:

Buzzer sounds.

Note

- You cannot turn off beeps for alerts irrespective of this setting.

IR Code

Switches the codes to operate the recorder. If you use the second and third TOSHIBA DVD video recorders, set the different remote codes for each recorder to avoid confusion in the response of the recorders.

For details about this setting, refer to "Operating the second and third TOSHIBA DVD video recorders with the remote control of this recorder" (➡ page 46, "INSTALLATION GUIDE").

DR1 : DR2 : DR3

Instant Skip Interval

DVD-RAM DVD-RW DVD-R DVD-VIDEO VCD CD

Sets how much time is skipped when the INSTANT SKIP button is pressed.

5 sec. : 10 sec. : 30 sec. : 5 min.

Instant Replay Interval

DVD-RAM DVD-RW DVD-R DVD-VIDEO VCD CD

Sets how far back is replayed when the INSTANT REPLAY button is pressed.

5 sec. : 10 sec. : 30 sec. : 5 min.

Title Thumbnail Point

DVD-RAM

For recorded titles, sets how far a scene from the start is set as the title thumbnail.

0 sec. : 3 sec. : 10 sec. : 35 sec. : 1 min. : 5 min.

Note

- Thumbnails can also be changed to other scenes. See ➡ page 95.

Title Playback

DVD-RAM

Sets the resume play per title.

Title Resume:

Remembers the point where you stop playback. Allows you to resume the playback from that point.

Serial Playback:

You can play back titles (Original, Playlist) stored in the DVD-RAM continuously. Because there is no division between titles, the recorder remembers only the last point where you stopped playback.

Still Group Interval

DVD-RAM

Sets an interval for display of still pictures (in seconds) when playing back a collection of still images.

1 sec. : 2 sec. : 3 sec. : 5 sec. : 10 sec. : Default

DVD Recorder Operation

AV Record Quality

DVD-RAM | DVD-RW | DVD-R

You can select from 5 combined picture and sound quality recording settings prior to actual recording. Actual selection applied becomes the default setting for the normal recording or programmed recording.

e.g.

Setting	Mode	Rate	Audio Quality
1	Manual	6.6	L-PCM
2	SP	4.6	DCD/M1
3	LP	2.2	DCD/M1
4	Manual	6.0	DCD/M2
5	Manual	3.2	DCD/M1

Total Recording Time: approx. 122min.
(with 4.7 GB unused)

• To make a combination of picture and sound quality settings.

- 1) Press the ▲ / ▼ / ◀ / ▶ buttons to select the desired item (“Mode”, “Rate”, or “Audio Quality”).
- 2) Press the ADJUST button to change the setting of each item.

• To apply the combination of picture and sound quality settings.

- 1) Press the ADJUST button to change the setting.

You can confirm the available recording time for the selected setting on the bottom screen.

- 2) Press the ENTER button.

Notes

- You can change the combination of picture and sound quality settings also by displaying the Quick Menu on a LIBRARY MENU or during stop mode, then selecting “AV Record Quality”. Either of the above methods updates the setting of this recorder.
- If you set “SP” or “LP”, you cannot select “L-PCM”.
- Depending on the sound quality settings, the upper limit for the picture quality setting differs.
- You can adjust the manual rate for picture quality by 0.2 Mbps from 2.0 to 9.2. (You cannot set the rate from 1.4 to 2.0.)

Picture Record Mode

DVD-RAM | DVD-RW | DVD-R

Adjusts problems with the brightness of video signals of TV broadcasts or other external input. (Only use this setting when you cannot adjust the brightness satisfactorily with the Custom Picture Setting in the Picture/Audio Settings (➡ Page 125) of this recorder.)

Important:

- This setting changes the video signal to record and the recorded signal is not returned to the original state even when this setting is changed after recording. When duplicating from VHS tape, if you can check the video recording state beforehand, we recommend first playing back for a while and checking the overall brightness tendency, then setting an appropriate mode.

Standard:

The brightness of signals received with this recorder and external input signals is adjusted automatically. This is normally the setting to use.

Mode 1:

This setting is used to record the signals darker when the screen is too bright.

Mode 2, 3, 4:

As the number rises, the signals are recorded brighter. Use these modes to adjust the brightness.

Audio Input Level

DVD-RAM | DVD-RW | DVD-R

Sets the audio input level of recorded sound. Press the ▲ / ▼ buttons to select the desired item, and then press the ◀ / ▶ buttons to adjust the input level.

TV/CATV (L):

Sets the input level for the left channel.

(R):

Sets the input level for the right channel.

Line1, 2, 3 (L):

Sets the input level for the left channel of the external input connectors.

(R):

Sets the input level for the right channel of the external input connectors.

Aspect Ratio (Video Mode)

DVD-RW DVD-R

To set the aspect ratio when recording onto a DVD-R/RW disc.

4:3:

Fixes the aspect ratio at 4:3.

16:9:

Fixes the aspect ratio at 16:9.

Note

- When "Mode" on "AV Record Quality" is set to "1.4(Mbps)", pictures are recorded in 4:3 aspect ratio even if "16:9" is selected.

DVD Video Compatibility

DVD-RAM DVD-RW DVD-R

To set whether or not recording is to be performed in the format for which recording is allowed by the DVD-Video standard (video, audio and other data) during recording.

Off:

When recording on a DVD-RAM disc, both the main and sub sounds are recorded.
When recording on a DVD-R/RW disc, this is ineffective. The recorder will automatically regard this as "Main," and record sound of the main channel only in stereo. Select "Main" or "Sub" for a DVD-R/RW recording.

Main:

Records sound of the main channel only in stereo.

SAP:

Records sound of the sub channel only in stereo.

Notes

- When you change the manual rate of the picture quality to from 3.0 to 3.8 and set this mode to "Main" or "SAP", the picture quality may become lower than when you set this mode to "Off".
- You can change the setting from the Quick Menu.

DVD-Video: CHP Create

DVD-RW DVD-R

To set whether chapters are to be automatically created at a selected interval during DVD-R/RW recording.

Off:

Chapters are not set.

5 min. : 10 min. : 15 min. : 20 min.

To set the interval at which chapters are automatically created to 5, 10, 15 or 20 minutes.

Note

- The number of chapters has the upper limit, which varies depending on the disc condition. If the number reaches it, no more chapters are created.

Rec DNR

DVD-RAM DVD-RW DVD-R

Selects the level of 3D digital noise reduction that can reduce noises in a picture via the S-video input.

Off:

Deactivates the 3D digital noise reduction.

On:

Sets the normal level.

Expanded:

Increases digital noise reduction.

Notes

- "Rec DNR" works only on S video input. No effects on receiving broadcasts or composite video input.
- If you want to avoid an afterimage in the picture, set this setting to "Off".

3D Y/C Separation

DVD-RAM DVD-RW DVD-R

The 3D digital comb filter executes Y/C (Brightness/Color) separation to reduce the color irregularity or cross color interference.

Off:

Deactivates this function.
In an area where the broadcast reception is poor, select this mode.

On:

Activates this function.
In normal conditions, select this.

Notes

- While "Off" selected, the logical comb filter executes Y/C separation.
- "3D Y/C Separation" works only on receiving broadcasts and composite video input. No effects on S video input.

Management Settings

Genre Setting

DVD-RAM DVD-RW DVD-R

This registers a frequently used genre name onto the menu. Genre names registered here are displayed in the “Genre” on the Quick Menu.

- 1) Press the ▲ / ▼ buttons to select a position in the “Current Genre List” you want to change, then press the ENTER button.

A list of genres appears.

You can turn the pages using the ► button.

- 2) Press the ▲ / ▼ buttons to select a genre, then press the ENTER button.

A list of genre names appears.

- 3) Press the ▲ / ▼ buttons to select a genre name, then press the ENTER button.

The selected genre name replaces the previous one of the position you selected at step 1).

- 4) Repeat steps 1) to 3) to register genre names.

- 5) When genre names are registered, press the O button to return to the “Management Settings” menu.

Eco. Mode

To set the front panel display to turn on/off in the standby mode.

Off:

Sets the front panel display to turn on in the standby mode.

On:

Sets the front panel display to turn off in the standby mode.

DVD-RAM Physical Format

DVD-RAM

See ➞ page 29.

Setting of picture and sound quality for recording

Picture quality setting	Sound setting		
	<input type="checkbox"/> D /M1	<input type="checkbox"/> D /M2	L-PCM
SP	<input type="radio"/>	<input type="radio"/>	X
LP	<input type="radio"/>	<input type="radio"/>	X
MN	<input type="radio"/>	<input type="radio"/>	<input type="radio"/>
Auto	<input type="radio"/>	<input type="radio"/>	<input type="radio"/>

Others

- Troubleshooting
- Language Code List
- Specification

Troubleshooting

If you experience any of the following difficulties while using this unit, check the list below before consulting your nearest Toshiba dealer.

Power

- **The power is not turned on.**
 - The AC power cord is not connected securely.
→ Connect the AC power cord securely.

Connection to your TV

- **There is no TV picture.**
 - The video cable to this unit and your TV is not connected securely.
→ Connect the video cable to this unit and your TV securely.
 - The input select on your TV is not set properly.
→ Select the input to which this recorder is connected.

TV reception

- **There is no picture.**
 - The antenna cable is not connected securely.
→ Reconnect the antenna cable securely.
- **There is poor reception.**
 - Channel settings and channel adjustments are not completed.
→ Set the channel settings and adjustments again.
 - The antenna cable is not connected securely.
→ Reconnect the antenna cable securely.
 - Antenna signal is poor.
→ Adjust the location of the antenna or use an optional antenna booster.

Playback

- **A DVD or CD does not play.**
 - The format of the recorded data does not correspond to this unit, or the region number is neither "1" nor "ALL".
→ Check the disc.
 - A defective or dirty disc is inside.
→ Change the disc.
- **During playback, picture noise appears.**
 - Picture noise may appear in the following cases. It is not a malfunction.
 - There is picture noise in the original recording.
 - Weather, reception conditions may cause noise.
 - The data transmission rate is set to low.
 - The image data processing of this unit cannot follow dynamic movement on the screen. (Low video data rate)
 - A physical error has occurred on the DVD-RAM disc. Consult the nearest Toshiba dealer.

If an error occurs during reading data of a disc, block-noises may be produced there. Repeated reading of this location where the error occurred(retry) can decrease the generation of block noise. However, it can also raise the possibility of unintended delays or stops of playback. In order to prevent them, the recorder limits the number of times of retry.

Recording

■ Data cannot be recorded on a DVD-RAM disc.

- The disc is protected from deleting data.
→ Set the write-protect tab to the opposite of "PROTECT" (➡ page 8).
- The free area of the disc is not sufficient.
→ Delete unwanted data (➡ page 49) or prepare a new disc.
- The disc is not initialized.
→ Initialize the disc (➡ page 28).
- The disc may be damaged, dirty, and scratched.
→ Complete the physical format on the disc (➡ page 29).
- The physical format on the disc is not completed.
→ Complete the physical format on the disc (➡ page 29).

Program

■ Timer programming cannot be completed.

- Clock setting has not been completed.
→ Complete the clock setting (➡ page 30, "INSTALLATION GUIDE").
 - The programs list is full.
→ Cancel unwanted programs (➡ page 43).
- ### ■ VCR Plus+ Recording does not work properly.
- Guide channel setting is not completed.
→ Complete the Guide channel setting (➡ page 36, "INSTALLATION GUIDE").
 - TV/CATV setting is not completed.
→ Complete TV/CATV setting (➡ page 16, "INSTALLATION GUIDE").

Remote control

■ The remote control does not work.

- The batteries in the remote control are exhausted.
→ Replace all the batteries in the remote control (➡ page 12, "INSTALLATION GUIDE").
- The light emitter of the remote control is not pointed at the receptor of this unit.
→ Point the emitter of the remote control at the receptor of this unit.
- The receptor of this unit is located too far away from the remote control.
→ Operate the remote control within 7 meters (23 ft) from the receptor of this unit.
- There are obstacles between the remote control and this unit.
→ Remove any obstacles.
- The receptor is disturbed by sunlight or fluorescent light.
→ Change the place of this unit or shield the light.
- The remote mode is not appropriate.
→ Adjust the remote mode of the remote control and this unit (➡ page 46, "INSTALLATION GUIDE").

Clock

■ The clock blinks.

- Complete the initial setting again (➡ page 46, "INSTALLATION GUIDE").

■ The clock does not keep time.

- Set the Time and Date Setting manually (➡ page 32, "INSTALLATION GUIDE").
- Set Summer Time or Time Zone correctly (➡ page 30, "INSTALLATION GUIDE").

Error Codes on the display window

The recorder display shows error codes in addition to the message screen.

Main examples are as follows.

The "***" in the "ERR - ***" message indicates an error code. To delete this display, press the DISPLAY button on the remote control.

Error code	Description	
ERR-01	Error detected in the physical format.	
ERR-04	Failure detected in reading/recording of Library data.	
ERR-2E	Error detected in encoding or creating of menu	<ul style="list-style-type: none"> • During recording onto DVD-R/RW discs. • During recording onto DVD-RAM discs.
ERR-2F	Overflow of the menu size detected.	
ERR-30	Exceeded maximum number of menus detected.	
ERR-31	Recovery of writing executed, depending on conformity of disc and drive.	
ERR-32	No compatibility of disc format detected.	
ERR-33	Write-protection information on a disc detected.	
ERR-34	Copy-restricted data or control information error detected.	
ERR-35	Exceeded volume detected before recording.	
ERR-36	Failure in recording. (title not saved)	
ERR-37	Failure in recording. (title saved)	
ERR-38	Failure in copying. (title not saved)	
ERR-39	Failure in copying. (title saved)	
ERR-3A	Unexpected error.	

Note

- If you find an error code other than listed above, consult your nearest TOSHIBA dealer.

Recording duration

Sound rate Picture quality rate	D D /M1(192kHz)		D D /M2(384kHz)		L-PCM		Remarks
	DVD-RAM		DVD-RAM		DVD-RAM		
	Hour	Minute	Hour	Minute	Hour	Minute	
1.4	06	07	05	28	03	21	
2.0	04	22	04	02	02	44	Picture quality rate for LP with D D /M2.
2.2	04	01	03	44	02	36	Picture quality rate for LP with D D /M1.
2.4	03	43	03	28	02	28	
2.6	03	27	03	14	02	21	
2.8	03	14	03	02	02	14	
3.0	03	02	02	52	02	08	
3.2	02	51	02	42	02	03	
3.4	02	42	02	34	01	58	
3.6	02	33	02	26	01	53	
3.8	02	26	02	19	01	49	
4.0	02	19	02	13	01	45	
4.2	02	13	02	07	01	41	
4.4	02	07	02	02	01	38	Picture quality rate for SP with D D /M2.
4.6	02	02	01	57	01	35	Picture quality rate for SP with D D /M1.
4.8	01	57	01	52	01	32	
5.0	01	52	01	48	01	29	
5.2	01	48	01	44	01	26	
5.4	01	44	01	41	01	24	
5.6	01	40	01	37	01	21	
5.8	01	37	01	34	01	19	
6.0	01	34	01	31	01	17	
6.2	01	31	01	28	01	15	
6.4	01	28	01	26	01	13	
6.6	01	26	01	23	01	11	
6.8	01	23	01	21	01	09	
7.0	01	21	01	19	01	08	
7.2	01	18	01	16	01	06	
7.4	01	16	01	14	01	05	
7.6	01	14	01	13	01	03	
7.8	01	12	01	11	01	02	
8.0	01	11	01	09	01	00	Manual maximum setting for L-PCM.
8.2	01	09	01	07			
8.4	01	07	01	06			
8.6	01	06	01	04			
8.8	01	04	01	03			
9.0	01	03	01	01			
9.2	01	01	01	00			Maximum value for the manual mode.

- The recording duration listed above is not guaranteed.
- This recording duration applies to the DVD-RAM disc in its initialized condition. The display may vary depending on the disc.
- If you subtract the actual recording duration from the duration listed in this table, the calculated time period does not represent the remaining time.
- The consumption of space may vary depending on the picture and sound conditions of the recorded content.
- Use the remaining disc space display feature to see the remaining space in the DVD-RAM disc.

For D D /M1 and D D /M2, the digital recording technology for consumer products of Dolby Laboratories is used. Setting 1 (D D /M1) records in Dolby Digital at 192 kbps, and Setting 2 (D D /M2) records at 384 kbps.

Language Code List

Table of languages and their abbreviations

Abbreviation	Language	Abbreviation	Language	Abbreviation	Language
---	No alternate language	GN	Guarani	PT	Portuguese
CHI (ZH)	Chinese	GU	Gujarati	QU	Quechua
DUT (NL)	Dutch	HA	Hausa	RM	Rhaeto-Romance
ENG (EN)	English	HI	Hindi	RN	Kirundi
FRE (FR)	French	HR	Croatian	RO	Rumanian
GER (DE)	German	HU	Hungarian	RU	Russian
ITA (IT)	Italian	HY	Armenian	RW	Kinyarwanda
JPN (JA)	Japanese	IA	Interlingua	SA	Sanskrit
KOR (KO)	Korean	IE	Interlingue	SD	Sindhi
MAY (MS)	Malay	IK	Inupiak	SG	Sango
SPA (ES)	Spanish	IN	Indonesian	SH	Serbo-Croatian
AA	Afar	IS	Icelandic	SI	Singhalese
AB	Abkhazian	IW	Hebrew	SK	Slovak
AF	Afrikaans	JI	Yiddish	SL	Slovenian
AM	Amharic	JW	Javanese	SM	Samoan
AR	Arabic	KA	Georgian	SN	Shona
AS	Assamese	KK	Kazakh	SO	Somali
AY	Aymara	KL	Greenlandic	SQ	Albanian
AZ	Azerbaijani	KM	Cambodian	SR	Serbian
BA	Bashkir	KN	Kannada	SS	Siswati
BE	Belorussian	KS	Kashmiri	ST	Sesotho
BG	Bulgarian	KU	Kurdish	SU	Sundanese
BH	Bihari	KY	Kirghiz	SV	Swedish
BI	Bislama	LA	Latin	SW	Swahili
BN	Bengali, Bangla	LN	Lingala	TA	Tamil
BO	Tibetan	LO	Laotian	TE	Telugu
BR	Breton	LT	Lithuanian	TG	Tajik
CA	Catalan	LV	Latvian, Lettish	TH	Thai
CO	Corsican	MG	Malagasy	TI	Tigrinya
CS	Czech	MI	Maori	TK	Turkmen
CY	Welsh	MK	Macedonian	TL	Tagalog
DA	Danish	ML	Malayalam	TN	Setswana
DZ	Bhutani	MN	Mongolian	TO	Tongan
EL	Greek	MO	Moldavian	TR	Turkish
EO	Esperanto	MR	Marathi	TS	Tsonga
ET	Estonian	MT	Maltese	TT	Tatar
EU	Basque	MY	Burmese	TW	Twi
FA	Persian	NA	Nauru	UK	Ukrainian
FI	Finnish	NE	Nepali	UR	Urdu
FJ	Fiji	NO	Norwegian	UZ	Uzbek
FO	Faroese	OC	Occitan	VI	Vietnamese
FY	Frisian	OM	(Afan) Oromo	VO	Volapük
GA	Irish	OR	Oriya	WO	Wolof
GD	Scottish Gaelic	PA	Panjabi	XH	Xhosa
GL	Galician	PL	Polish	YO	Yoruba
		PS	Pashto, Pushto	ZU	Zulu

Specification

■ Power requirement during operation

29W

■ Power requirement at standby

2.6W or below (Eco mode: off)

0.7W or below (Eco mode: on)

■ Power supply

120V AC, 60 Hz

■ Mass

4.2kg

■ External dimension

Width 430 x Height 78 x Depth 325mm

■ Incoming channels

TV: 2-69CH, CATV:1-125CH

■ Antenna input/output terminal

VHF/UHF: 75Ω, F Connector

■ Demodulation input/output terminal

0.67Vp-p (75Ω) Unbalanced, Pin jack

■ Signal system

Standard NTSC Color TV system

■ Laser

Semiconductor laser, Wavelength: 650nm/780nm

■ Format

DVD-VR format

DVD-Video format

■ Image recording system

MPEG2

■ Sound recording system

Dolby digital M1, M2, Linear PCM

■ Disc for recording images

DVD-RAM disc (4.7GB for one side, 9.4GB for both sides)

DVD-RW disc (4.7GB for one side)

DVD-R disc (4.7GB for one side)

■ Image input

1.0Vp-p (75Ω), Synchronization negative, Pin jack x 2 systems, 2 at rear, 1 in front

■ Image output

1.0Vp-p (75Ω), Synchronization negative, Pin jack x 2 systems, 2 at rear

■ S Image input

(Y) 1.0Vp-p (75Ω), Synchronization negative, Mini DIN4 Pin x 3 systems

(C) 0.286Vp-p (75Ω), 2 at rear, 1 in front

■ S Image output

(Y) 1.0Vp-p (75Ω), Synchronization negative, Mini DIN4 Pin x 2 systems

(C) 0.286Vp-p (75Ω), 2 at rear

■ Component image output (Y, P_B, P_R)

Y output (green), 1.0Vp-p (75Ω), Synchronization negative, Pin jack x 1 system

P_B, P_R output (blue, red), 0.7Vp-p (75Ω), Pin jack x 1 system each

■ Sound input

2.0V (rms), 50kΩ or below, pin jack

(L, R) x 3 systems

2 at rear, 1 in front

■ Sound output

2.0V (rms), 200Ω or above, pin jack

(L, R) x 2 systems

2 at rear

■ Sound output (bit stream/PCM optical terminal)

Optical connector x 1 system

■ Sound output (bit stream/PCM coaxial terminal)

0.5Vp-p (75Ω), pin jack x 1 system

■ DV input

4-pin x 1 in front

■ Remote control

Wireless remote control (SE-R0105)

■ Operating conditions

Temperature: 41°F ~ 95°F (5°C ~ 35°C),

Position: Horizontal

■ Clock display

24 hour digital display

■ Clock accuracy

Quartz (monthly deviation: approximately ± 30 seconds)

- The design and specifications may change without prior notice.
- The Illustrations and screens described in this manual may be exaggerated or simplified for easy recognition and may be slightly different from the actual unit.

LIMITED WARRANTY DVD VIDEO RECORDER

Toshiba America Consumer Products, Inc. ("TACP"), Toshiba Hawaii ("THI") and Toshiba Canada Limited ("TCL") make the following limited warranties. These limited warranties extend to original purchaser or any person receiving this set as a gift from the original purchaser and to no other purchaser or transferee.

Limited Ninety (90) Day Warranty

TACP/THI warrant this product against defects in materials or workmanship for a period of ninety (90) days after the date of original retail purchase. During this period, TACP/THI will repair or replace a defective product or part, at their option, with a new or refurbished product or part without charge to you. You must deliver the entire product to a TACP/THI Authorized Service Station. You are responsible for all transportation and insurance charges for the unit to and from the Authorized Service Station. If you live in the U.S.A. you may, at your option, return your DVD Unit to:

Toshiba America Consumer Products Inc.
Returns Center
1420C Toshiba Dr.
Lebanon, TN 37087

Upon receipt we will, at our option, exchange the DVD Unit with a new or refurbished unit. **Canadian consumers are requested to contact TCL. In Hawaii consumers are requested to contact THI.**

Limited One (1) Year Warranty

TACP/THI further warrant the parts in this product against defects in materials or workmanship for a period of one (1) year after the date of original retail purchase. During this period, TACP/THI will repair or replace a defective product or part, at their option, with a new or refurbished product or part without charge to you, except that if a defective part is replaced after ninety (90) days from the date of the original retail purchase you pay labor charges involved in the replacement. You must also deliver the entire product to a TACP/THI Authorized Service Station. You are responsible for all transportation and insurance charges for the unit to and from the Authorized Service Station. If you live in the U.S.A. you may, at your option, return your DVD Unit to:

Toshiba America Consumer Products Inc.
Returns Center
1420C Toshiba Dr.
Lebanon, TN 37087

Upon receipt we will, at our option, exchange the DVD Unit with a new or refurbished unit. **Canadian Consumers are requested to contact TCL. In Hawaii consumers are requested to contact THI.**

Rental Units

The warranty for rental units begin with the first rental or thirty (30) days from the date of shipment to the rental firm, whichever comes first.

Commercial Units

Products sold and used for commercial use have a limited ninety (90) day warranty for all parts and labor.

Owner's Manual

You should read the owner's manual thoroughly before operating this product. You should complete and mail the enclosed Demographic card within ten (10) days after you, or the person who has given you this product as a gift, purchased this product. This is one way to enable TACP to provide you with better customer service and improved products. Failure to return the card will not affect your rights under this warranty.

Your Responsibility

The above warranties are subject to the following conditions:

- (1) You must retain your bill of sale or provide other proof of purchase.
- (2) You must notify a TACP/THI/TCL /Authorized Service Station within thirty (30) days after you discover a defective product or part.
- (3) All warranty servicing of this product must be made by a TACP/THI/TCL Authorized Service Station.
- (4) U.S.A. warranties are effective only if the product is purchased and operated in the Continental U.S.A. or Puerto Rico.
- (5) Labor service charges for set installation. Set up, adjustment of customer controls and installation or repair of antenna systems are not covered by this warranty. Reception problems caused by inadequate antenna systems are your responsibility.
- (6) Warranties extend only to defects in materials or workmanship as limited above and do not extend to any product or parts which have been lost or discarded by you or to damage to products or parts caused by misuse, accident, damage caused by Acts of God, such as lighting or fluctuations in electric power, improper installation, improper maintenance or use in violation of instructions furnished by us or to units which have been altered or modified without authorization of TACP/THI/TCL or to damage to products or part thereof which have had the serial number removed, altered, defaced or rendered illegible.
- (7) Should you elect to return your DVD Unit to TACP after the ninety (90) days and within one (1) year, or after the warranty period has expired: Call (800)-631-3811 to receive information concerning an exchange price. Payment must be enclosed with product in the form of a certified check or money order including reason for return.
- (8) Physically damaged DVD Units are not acceptable for repair or exchange whether in or out of warranty and will be returned as received.

How to Obtain Warranty Service

- (1) Refer to the troubleshooting guide in your owner's manual. This check list may solve your problem.
- (2) In the U.S.A., only call the TACP toll free number 800-631-3811, or if in Hawaii or Canada see listing below within (30) days after you find a defective product or part.
- (3) Arrange for the delivery of the product to the TACP/THI/TCL Authorized Service Station or TACP Return Center. Products shipped to the Service Station must be insured and safely and securely packed, preferably in the original shipping carton, and a letter explaining the defect and also a copy of the bill of sale or other proof of purchase must be enclosed.

In the Continental United States contact:



In Hawaii contact:

Toshiba Hawaii Inc.
327 Kamakee Street
Honolulu, HA 96814
(808)-521-5377

In Canada contact:

Consumer Electronics Group
191 McNabb Street
Markham, Ontario L3R 8H2
(905)-470-5400

Consumer Electronics Group
22171 Fraserwood Way
Richmond, B.C. V6W 1J5
(604)-303-2500

Consumer Electronics Group
1643 North Service Road
Droval, QC H9P 1J1
(514)-856-4100

All warranties implied by state law, including the implied warranties of merchantability and fitness for a particular purpose, are expressly limited to the duration of the limited warranties set forth above. With the exception of any warranties implied by state law as hereby limited, the foregoing warranty is exclusive and in lieu of all other warranties, guarantees, agreements and similar obligations of manufacturer or seller with respect to the repair or replacement of any parts. In no event shall TACP/THI be liable for consequential or incidental damages.

No person, agent, distributor, dealer or company is authorized to change, modify or extend the terms of these warranties in any manner whatsoever. The time within which an action must be commenced to enforce any obligation of TACP/THI arising under the warranty or under any statute, or law of the United States or any state thereof, is hereby limited to ninety (90) days from the date you discover or should have discovered, the defect. This limitation does not apply to implied warranties arising under state law.

This warranty gives you specific legal rights and you may also have other rights which may vary from state to state. Some states do not allow limitation on how long an implied warranty lasts, when an action may be brought, or the exclusion or limitation of incidental or consequential damages, so the above provisions may not apply to you.

ATTENTION CANADIAN CONSUMERS:

Canadian consumers are requested to complete the special Canadian "Warranty Registration Form" enclosed, and forward this completed form with a copy of bill of sale to TOSHIBA OF CANADA to "Register and Validate" their warranty. Product must be purchased from an Authorized Canadian Dealer. Products purchased in the U.S.A. and used in Canada are not covered by these warranties.

IMPORTANT: PACKING AND SHIPPING INSTRUCTION

When you send the product to a Service Station, you must use the original carton box and packing material, then insert the original carton box containing the unit into another carton using more packing material.

TOSHIBA

Free Manuals Download Website

<http://myh66.com>

<http://usermanuals.us>

<http://www.somanuals.com>

<http://www.4manuals.cc>

<http://www.manual-lib.com>

<http://www.404manual.com>

<http://www.luxmanual.com>

<http://aubethermostatmanual.com>

Golf course search by state

<http://golfingnear.com>

Email search by domain

<http://emailbydomain.com>

Auto manuals search

<http://auto.somanuals.com>

TV manuals search

<http://tv.somanuals.com>