

surveillix

XVS - DVS - HVS Digital Video Recorder

User Manual

model no.

XVS4-120-X

XVS16-240-X

XVS16-240V-X

DVS8-240-X

DVS8-240H-X

DVS16-480-X

DVS16-480H-X

DVS32-240-X

DVS32-480-X

HVS16-240-X

HVS16-480-X

HVS16-480H-X

HVS32-240-X

HVS32-480-X

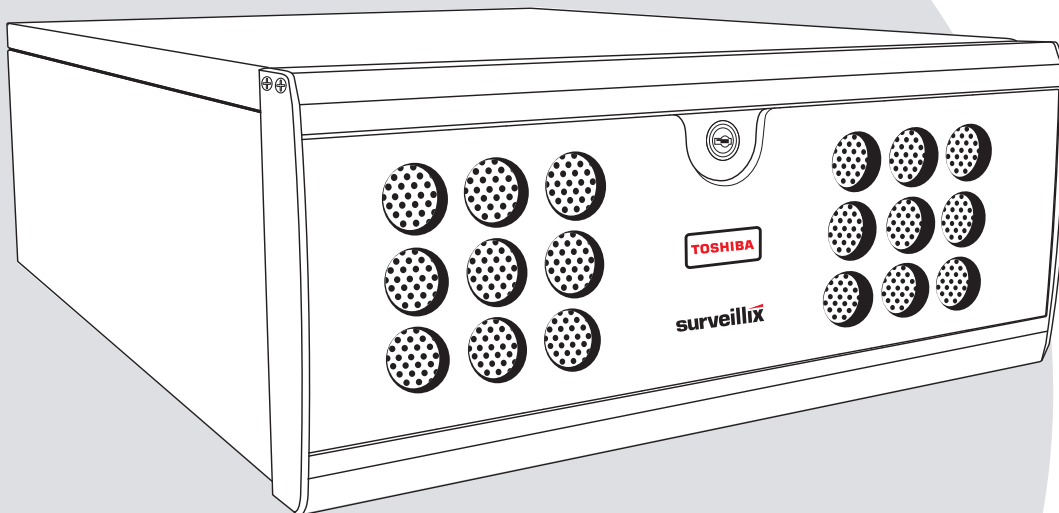

Please carefully read these instructions before using this product.
Save this manual for future use.

TOSHIBA

Surveillix™ XVS/DVS/HVS
User Manual

Manual Edition 29100AD – MAY 2009

Printed in USA

No part of this documentation may be reproduced in any means, electronic or mechanical, for any purpose, except as expressed in the Software License Agreement. Toshiba shall not be liable for technical or editorial errors or omissions contained herein. The information in this document is subject to change without notice.

THE INFORMATION IN THIS PUBLICATION IS PROVIDED “AS IS” WITHOUT WARRANTY OF ANY KIND. THE ENTIRE RISK ARISING OUT OF THE USE OF THIS INFORMATION REMAINS WITH RECIPIENT. IN NO EVENT SHALL TOSHIBA BE LIABLE FOR ANY DIRECT, CONSEQUENTIAL, INCIDENTAL, SPECIAL, PUNITIVE, OR OTHER DAMAGES WHATSOEVER (INCLUDING WITHOUT LIMITATION, DAMAGES FOR LOSS OF BUSINESS PROFITS, BUSINESS INTERRUPTION OR LOSS OF BUSINESS INFORMATION), EVEN IF TOSHIBA HAS BEEN ADVISED OF THE POSSIBILITY OF SUCH DAMAGES AND WHETHER IN AN ACTION OR CONTRACT OR TORT, INCLUDING NEGLIGENCE.

This software and documentation are copyrighted. All other rights, including ownership of the software, are reserved to DVR Support Center. TOSHIBA, and Surveillix are registered trademarks of TOSHIBA CORPORATION in the United States and elsewhere; Windows, and Windows XP are registered trademarks of Microsoft Corporation. All other brand and product names are trademarks or registered trademarks of the respective owners.

The following words and symbols mark special messages throughout this guide:

WARNING: Text set off in this manner indicates that failure to follow directions could result in bodily harm or loss of life.

CAUTION: Text set off in this manner indicates that failure to follow directions could result in damage to equipment or loss of information.

LIMITED WARRANTY DIGITAL VIDEO RECORDER

The Imaging Systems Division of Toshiba America Information Systems, Inc. ("ISD") makes the following limited warranties. These limited warranties extend to the Original End-User ("You[r]").

Limited Two (2) Year Warranty of Labor and Parts

The Imaging Systems Division of Toshiba America Information Systems warrants this product and parts against defects in material or workmanship for a period of two years from the date of original retail purchase by the end-user. During this period, ISD will repair or replace a defective product or part with a new or refurbished item. The user must deliver the entire product to the Surveillix DVR Repair Facility. The user is responsible for all transportation and insurance charges for the product to the DVR Repair Facility. ISD reserves the right to substitute Factory Refurbished Parts and / or Factory Refurbished Product in place of those in need of repair.

Step-by-step Procedures – How to Obtain Warranty Service

[1] Verify operation of the unit by checking the instruction manual and web site for the latest updates at

www.toshibasecurity.com

[2] If there is a defect in material or workmanship, contact the Surveillix DVR Support Center at (877) 855-1349 [877-855-1-FIX] to speak to a technical support representative and schedule service.

[3] Arrange for delivery of the product to the Surveillix DVR Repair Facility. Products must be insured and securely packed, preferably in the original shipping carton. A letter explaining the defect and a copy of the bill of sale or other proof of purchase must be enclosed with a complete return street address and daytime telephone number. The Tracking Number should also be indicated on your documents. Charges for transportation and insurance must be prepaid by the end-user.

Critical Use Disclaimer

The product is not designed for any "critical applications." "Critical applications" means life support systems, exhaust or smoke extraction applications, medical applications, commercial aviation, mass transit applications, military applications, homeland security applications, nuclear facilities or systems or any other applications where product failure could lead to injury to persons or loss of life or catastrophic property damage. Accordingly, Toshiba disclaims any and all liability arising out of the use of the product in any critical applications.

Your Responsibilities

The above warranty is subject to the following conditions:

[1] You must retain the bill of sale or provide other proof of purchase.

[2] You must schedule service within thirty days after you discover a defective product or part.

[3] All warranty servicing of this product must be made by the Surveillix DVR Repair Facility.

[4] The warranty extends to defects in material or workmanship as limited above, and not to any products or parts that have been lost or discarded by user. The warranty does not cover damage caused by misuse, accident, improper installation, improper maintenance, or use in violation of instructions furnished by ISD. The warranty does not extend to units which have been altered or modified without authorization of ISD, or to damage to products or parts thereof which have had the serial number removed, altered defaced or rendered illegible.

ALL WARRANTIES IMPLIED BY STATE LAW, INCLUDING THE IMPLIED WARRANTIES OF MERCHANTABILITY AND FITNESS FOR A PARTICULAR PURPOSE, ARE EXPRESSLY LIMITED TO THE DURATION OF THE LIMITED WARRANTIES SET FORTH ABOVE. Some states do not allow limitations on how long an implied warranty lasts, so the above limitation may not apply. WITH THE EXCEPTION OF ANY WARRANTIES IMPLIED BY STATE LAW AS HEREBY LIMITED, THE FOREGOING EXPRESS WARRANTY IS EXCLUSIVE AND IN LIEU OF ALL OTHER WITH RESPECT TO THE REPAIR OR REPLACEMENT OF ANY PRODUCTS OR PARTS. IN NO EVENT SHALL ISD BE LIABLE FOR CONSEQUENTIAL OR INCIDENTAL DAMAGES. Some states do not allow the exclusion or limitation of incidental or consequential damages so the above limitation may not apply.

No person, agent, distributor, dealer, service station or company is authorized to change, modify or extend the terms of these warranties in any manner whatsoever. The time within which an action must be commenced to enforce any obligation of ISD arising under this warranty or under any statute, or law of the United States or any state thereof, is hereby limited to one year from the date you discover or should have discovered, the defect. This limitation does not apply to implied warranties arising under state law. Some states do not permit limitation of the time within which you may bring an action beyond the limits provided by state law so the above provision may not apply to user. This warranty gives the user specific legal rights, and user may also have other rights, which may vary from state to state.

TOSHIBA AMERICA INFORMATION SYSTEMS, INC.
Imaging Systems Division

Copyright © 2007 Toshiba America Information Systems, Inc. All rights reserved.

TOSHIBA

IMPORTANT SAFEGUARDS

1. **Read Owner's Manual** – After unpacking this product, read the owner's manual carefully, and follow all the operating and other instruction
2. **Power Sources** – This product should be operated only from the type of power source indicated on the label. If you are not sure of the type of power supply to your home or business, consult your product dealer or local power company
3. **Ventilation** – Slots and openings in the cabinet are provided for ventilation and to ensure reliable operation of the product and to protect it from overheating, and these openings must not be blocked or covered. The product should not be placed in a built-in installation such as a bookcase or rack unless proper ventilation is provided or the manufacturer's instructions have been adhered to.
4. **Heat** – The product should be situated away from heat sources such as radiators, heat registers, stoves, or other products that produce heat.
5. **Water and Moisture** – Do not use this product near water. Do not exceed the humidity specifications for the product as detailed in this manual.
6. **Cleaning** – Unplug this product from the wall outlet before cleaning. Do not use liquid cleaners or aerosol cleaners. Use a damp cloth for cleaning.
7. **Power Cord Protection** – Power-supply cords should not be routed so that they are not likely to be walked on or pinched by items placed against them, paying particular attention to cords at plugs, convenience receptacles, and the point where they exit from the product.
8. **Overloading** – Do not overload wall outlets; extension cords, or integral convenience receptacles as this can result in a risk of fire or electrical shock.
9. **Lightning** – For added protection for this product during storm, or when it is left unattended and unused for long periods of time, unplug it from the wall outlet. This will prevent damage to the product due to lightning and power line surges.
10. **Object and Liquid Entry Points** – Never insert foreign objects into the NVR, other than the media types approved by Honeywell, as they may touch dangerous voltage points or short-out parts that could result in a fire or electrical shock. Never spill liquid of any kind on the product.
11. **Accessories** – Do not place this product on an unstable cart, stand, tripod, bracket, or table. The product may fall, causing serious personal injury and serious damage to the product.
12. **Disc Tray** – Keep fingers clear of the disc tray as it is closing. Neglecting to do so may cause serious personal injury.
13. **Burden** – Do not place a heavy object on or step on the product. The object may fall, causing serious personal injury and serious damage to the product.
14. **Disc** – Do not use a cracked, deformed, or repaired disc. These discs are easily broken and may cause serious personal injury and product malfunction.
15. **LAN Port** - This equipment is for indoor use and all the communication wirings are limited to inside of the building.

IMPORTANT SAFEGUARDS, continued

16. **Damage Requiring Service** – Unplug the unit from the outlet and refer servicing to qualified service personnel under the following conditions:
 - a. When the power-supply cord or plug is damaged.
 - b. If liquid has been spilled, or objects have fallen into the unit.
 - c. If the unit has been exposed to rain or water.
 - d. If the unit does not operate normally by following the operating instructions. Adjust only those controls that are covered by the operating instructions as an improper adjustment of other controls may result in damage and will often require extensive work by a qualified technician to restore the unit to its normal operation.
 - e. If the unit has been dropped or the enclosure has been damaged.
 - f. When the unit exhibits a distinct change in performance - this indicates a need for service.
17. **Service** – Do not attempt to service this product yourself as opening or removing covers may expose you to dangerous voltage or other hazards. Refer all servicing to qualified personnel.
18. **Replacement Parts** – When replacement parts are required, be sure the service technician has used replacement parts specified by the manufacturer or have the same characteristics as the original part. Unauthorized substitutions may result in fire, electric shock or other hazards.
19. **Safety Check** – Upon completion of any service or repairs to this unit, ask the service technician to perform safety checks to determine that the unit is in proper operating condition.

BATTERY EXPLOSION CAUTION STATEMENT

CAUTION: Risk of Explosion if Battery is replaced by an Incorrect Type.
Dispose of Used Batteries According to the Instructions

NOTES ON HANDLING

Please retain the original shipping carton and/or packing materials supplied with this product. To ensure the integrity of this product when shipping or moving, repackage the unit as it was originally received from the manufacturer.

Do not use volatile liquids, such as aerosol spray, near this product. Do not leave rubber or plastic objects in contact with this product for extended periods of time. Rubber or plastic objects left in contact with this product for extended periods of time will leave marks on the finish.

The top and rear panels of the unit may become warm after long periods of use. This is not a malfunction.

NOTES ON LOCATING

Place this unit on a level surface. Do not use it on a shaky or unstable surface such as a wobbling table or inclined stand.

If this unit is placed next to a TV, radio, or VCR, the playback picture may become poor and the sound may be distorted. If this happens, place the DVR away from the TV, radio, or VCR.

NOTES ON CLEANING

Use a soft dry cloth for cleaning.

For stubborn dirt, soak the cloth in a weak detergent solution, wring well and wipe. Use a dry cloth to wipe it dry. Do not use any type of solvent, such as thinner and benzene, as they may damage the surface of the DVR.

If using a chemical saturated cloth to clean the unit, follow that product's instructions.

NOTES ON MAINTENANCE

This DVR is designed to last for long periods of time. To keep the DVR always operational we recommend regular inspection maintenance (cleaning parts or replacement). For details, contact the nearest dealer.

NOTES ON MOISTURE CONDENSATION

Moisture condensation damages the DVR. Read the following information carefully.

Moisture condensation occurs during the following cases:

When this product is brought directly from a cool location to a warm location.

When this product is moved to a hot and humid location from a cool location.

When this product is moved to a cool and humid location from a warm location.

When this product is used in a room where the temperature fluctuates.

When this product is used near an air-conditioning unit vent

When this product is used in a humid location.

Do not use the DVR when moisture condensation may occur.

If the DVR is used in such a situation, it may damage discs and internal parts. Remove any CD discs, connect the power cord of the DVR to the wall outlet, turn on the DVR, and leave it for two to three hours. After two to three hours, the DVR will warm up and evaporate any moisture. Keep the DVR connected to the wall and moisture will seldom occur.

WARNING

TO REDUCE THE RISK OF ELECTRICAL SHOCK, DO NOT EXPOSE THIS APPLIANCE TO RAIN OR MOISTURE.
DANGEROUS HIGH VOLTAGES ARE PRESENT INSIDE THE ENCLOSURE.
DO NOT OPEN THE CABINET.
REFER SERVICING TO QUALIFIED PERSONNEL ONLY.

CAUTION

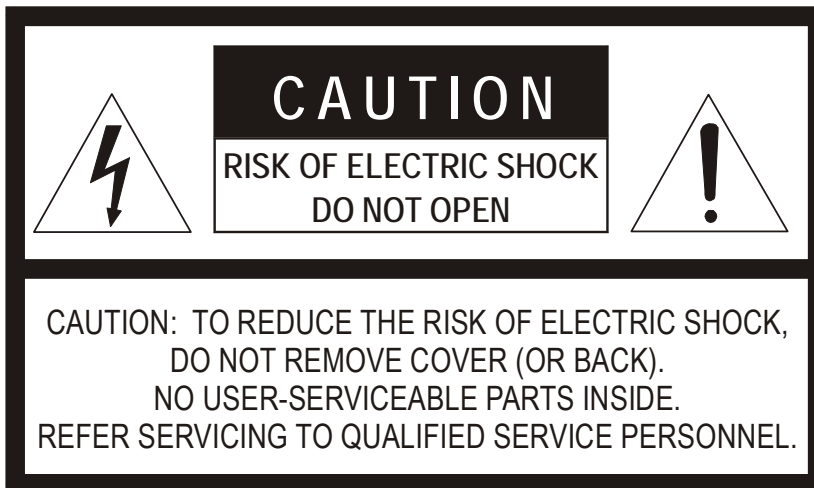

RACK MOUNT INSTRUCTIONS

Elevated Operating Ambient – If installed in a closed or multi-unit rack assembly, the operating ambient temperature of the rack environment may be greater than room ambient. Therefore, consideration should be given to installing the equipment in an environment compatible with the maximum ambient temperature (T_{ma}) specified by the manufacturer.

Reduced Air Flow – Installation of the equipment in a rack should be such that the amount of airflow required for safe operation of the equipment is not compromised.

Mechanical Loading – Mounting of the equipment in the rack should be such that a hazardous condition is not achieved due to uneven mechanical loading.

Circuit Overloading – Consideration should be given to the connection of the equipment to the supply circuit and the effect that overloading of the circuits might have on over current protection and supply wiring. Appropriate consideration of equipment nameplate ratings should be used when addressing this concern.

Grounding – Grounding of rack-mounted equipment should be maintained. Particular attention should be given to supply connections other than direct connections to the branch circuit (e.g. use of power strips).

FCC STATEMENT

INFORMATION TO THE USER: This equipment has been tested and found to comply with the limits for a Class B digital device, pursuant to Part 15 of the FCC Rules. These limits are designed to provide reasonable protection against harmful interference in a residential installation. This equipment generates, uses and can radiate radio frequency energy and, if not installed and used in accordance with the instructions, may cause harmful interference to radio communications. However, there is no guarantee that interference will not occur in a particular installation. If this equipment does cause harmful interference to radio or television reception, which can be determined by turning the equipment off and on, the user is encouraged to try to correct the interference by one or more of the following measures:

- Reorient or relocate the receiving antenna.
- Increase the separation between the equipment and receiver.
- Connect the equipment into an outlet on a circuit different from that to which the receiver is connected.
- Consult the dealer or an experienced radio/TV technician for help.

USERS OF THE PRODUCT ARE RESPONSIBLE FOR CHECKING AND COMPLYING WITH ALL FEDERAL, STATE, AND LOCAL LAWS AND STATUTES CONCERNING THE MONITORING AND RECORDING OF VIDEO AND AUDIO SIGNALS. HONEYWELL VIDEO SYSTEMS SHALL NOT BE HELD RESPONSIBLE FOR THE USE OF THIS PRODUCT IN VIOLATION OF CURRENT LAWS AND STATUTES.

UL NOTICE

Underwriters Laboratories Inc. has not tested the performance or reliability of the security or signaling aspects of this product. UL has only tested for fire, shock and casualty hazards as outlined in UL's Standard for Safety UL 60950-1. UL Certification does not cover the performance or reliability of the security or signaling aspects if this product. UL MAKES NO REPRESENTATIONS, WARRANTIES OR CERTIFICATIONS WHATSOEVER REGARDING THE PERFORMANCE OR RELIABILITY OF ANY SECURITY OR SIGNALING RELATED FUNCTIONS OF THIS PRODUCT.

CE NOTICE

This product is in conformity with the following European Directives:

ELECTROMAGNETIC COMPATIBILITY DIRECTIVE, 89/336/EEC
(as amended by 92/31/EEC and by Article 5 of 93/68/EEC)

per the provisions of:

EN55022:2006	EN61000-4-2:1995+A1+A2:2001	EN61000-4-6:1996+A1:2001
EN55024:1998+A1:2001+A2:2003	EN61000-4-3:1995+A1:2002	EN61000-4-8:1994+A1:2001
EN61000-3-2:2006	EN61000-4-4:1995+A1+A2:2004	EN61000-4-11:2004
EN61000-3-3:1995+A1:2001+A2:2005	EN61000-4-5:1995+A1:2001	

LOW VOLTAGE DIRECTIVE, 73/23/EEC
(as amended by Article 13 of 93/68/EEC)

per the provisions of:

EN 60950-1: 2001

Table of Contents

PREFACE	1
ABOUT THIS GUIDE	1
TECHNICIAN NOTES.....	1
INTRODUCTION	3
PRODUCT DESCRIPTION	3
FEATURES	4
CONTROLS AND CONNECTIONS	5
FRONT PANEL CONTROLS	6
XVS	6
DVS / HVS.....	7
REAR PANEL CONNECTORS	8
XVS	8
16 Channel	8
4 Channel	9
DVS/HVS.....	10
8/16 Channel	10
32 Channel	11
PCI Card Configurations.....	12
120 PCI Configuration.....	12
240V PPS PCI Configuration	12
240 PPS 8/16 Channel PCI Configuration	12
240 PPS 32 Channel PCI Configuration	13
480 PPS 16 Channel PCI Configuration	13
480 PPS 32 Channel PCI Configuration	13
GETTING STARTED	15
IDENTIFYING INCLUDED COMPONENTS.....	16
OPTIONAL COMPONENTS	17
KEYBOARD SETUP	18
MOUSE SETUP	18
MONITOR SETUP	19
POWER SETUP.....	19
MAKING CONNECTIONS ON AN XVS	20
Connecting a Video Source	20
4 Channel	20
16 Channel	20
Connecting Sensors to the XVS	21
4 Channel	21
16 Channel	21
Connecting Control Outputs to the XVS	22
16 Channel	22
4 Channel	22
Looping Outputs	23
Looping Output Termination	23
16 Channel	23

Connecting a PTZ Camera	24
Attaching the 3-Pin PTZ Adapter	24
MAKING CONNECTIONS ON DVS / HVS	25
Connecting a Video Source	25
8 Channel	25
16 Channel	25
32 Channel	25
Connecting Sensors to the DVS / HVS	26
Connecting Control Outputs to the DVS / HVS	26
Looping Outputs	27
Looping Output Termination	28
8/16 Channel	28
Connecting a PTZ Camera	28
Attaching the RS-485 Adapter	28
HARD DRIVE ARRAY (DVS / HVS ONLY)	29
Swapping a Hard Drive	29
TURNING ON THE DVR	30
TURNING OFF THE DVR	30
DVR BASICS	31
SETTING THE TIME AND DATE	32
ACCESSING THE DVR UTILITY	32
Exporting DVR Settings	32
Importing DVR Settings	33
Changing Video Format	33
DISPLAY SCREEN	34
Live Camera Options	34
CAMERA VIEW	35
Recording Status Indicator	35
Special Recording	35
SCREEN DIVISION BUTTONS	36
SETUP OPTIONS	37
SETUP OVERVIEW	38
CAMERA SETUP	39
Set Up New Camera	39
NETWORK VIDEO	40
Connecting a Network Device	40
Connecting Manually	40
Connecting with Camera Finder	41
Assigning a Network Device to a Channel	41
Camera Configuration	42
Displaying More Columns	42
Accessing the Configuration Menu	42
HVR Upgrade and Registration	43
Locating the System ID	43
Obtaining the Unlock Code	43
Unlocking the Upgrade	44
Unlocking New Network Device	44
MOTION SETUP	45

Create a Motion Area	45
Activating an Alarm on a Motion Event.....	46
Regular Interval Recording.....	46
FRAME SETUP OVERVIEW	47
Frame Setup (4 Channel XVS).....	47
Enable Video Out to Spot Monitor	47
Frame Setup (Real Time Models).....	48
Maximum PPS Table.....	49
SCHEDULE SETUP.....	50
Recording Schedule	50
Sensor Schedule	51
Create a Recording Schedule.....	52
Create a Sensor Schedule.....	52
Scheduling Alarm Events.....	52
Emergency Agent Schedule	52
Special Day Schedule	53
Creating/Editing a 'Special Day' Schedule.....	53
Deleting a 'Special Day' Schedule	53
System Restart Setup.....	54
Create System Restart Schedule.....	54
SENSOR SETUP	55
Configure Sensor Response.....	55
Activate PTZ Preset on Sensor	56
GENERAL SETUP	57
Voice Warning	57
Intensive Recording Overview.....	58
Using Intensive Recording.....	58
TV-Out Setup (Analog)	58
TV-Out Setup (Multiplexer).....	59
Configure Sequence Mode.....	59
Control Sequence Mode Display	59
Control Multiplexer Mode Display	60
Connecting to a Wide Screen Display	60
Volume	61
Audio	61
Enabling Audio Recording	61
Enabling Live Audio	61
Auto Sequence Setting.....	62
Create Custom Auto Sequence	62
NETWORK SETUP	63
PAN/TILT SETUP.....	64
INFORMATION	64
ADMINISTRATIVE SETUP	65
Disk Management.....	65
Setting Up DDNS.....	66
Enable DDNS	66
Set the IP Address.....	66
User Management	67

Add a New User.....	67
User Rank.....	68
Changing the Administrator Password	68
Default Administrator Password.....	68
Log Management.....	68
Setup Log Management Options	68
Status Check / Email	69
General.....	69
Users	69
Storage Check.....	70
Recording Data Check.....	70
SMART Information	71
SMART Alert.....	71
Alarm Event	71
INSTANT RECORDING	72
Activate Instant Recording.....	72
Searching 'Instant Recorded' Video	72
SEARCH.....	73
SEARCH OVERVIEW	74
Play Controls	74
Adjust the Brightness of an Image.....	75
Zooming in on an Image.....	75
Zooming in on a Portion of an Image.....	75
Open Video from a Saved Location.....	75
Time Sync.....	75
Clean Image	75
PERFORMING A BASIC SEARCH.....	76
PRINTING AN IMAGE.....	76
DAYLIGHT SAVING TIME	76
SAVE TO JPG OR AVI.....	77
Bookmarks.....	78
Modify Bookmarks	78
Single Clip Backup	79
Single Clip Backup Using Bookmark Data.....	79
INDEX SEARCH	80
Performing an Index Search	80
Index Search Results Display.....	80
PREVIEW SEARCH.....	81
Performing a Preview Search.....	82
GRAPHIC SEARCH.....	82
Performing a Graphic Search	82
OBJECT SEARCH	83
Performing an Object Search	83
MOTION SEARCH.....	84
Performing a Motion Search.....	84
AUDIO PLAYBACK	84
SEARCH IN LIVE.....	85
PAN / TILT / ZOOM	87

PAN / TILT / ZOOM OVERVIEW	88
SETTING UP A PTZ CAMERA	88
Enable the PTZ Settings.....	88
Supported PTZ Protocols	89
ADVANCED PTZ SETUP.....	90
Creating and Viewing Preset Positions.....	90
Creating a Preset.....	90
Viewing a Preset.....	90
PTZ Address Settings.....	91
ACCESSING PTZ MENUS	91
CONTROLLING A PTZ CAMERA	92
Using the Graphical PTZ Controller.....	92
Using the On-Screen Compass	93
UNDERSTANDING TOURS	93
PTZ Tour Schedule	94
Create PTZ Tour Schedule.....	94
BACKING UP VIDEO DATA	95
BACKUP OVERVIEW	96
Nero® Express	96
General Screen Overview.....	97
Performing a General Backup.....	97
Clip Screen Overview	98
Performing a Clip Backup	98
Scheduled Screen Overview	99
Performing a Scheduled Backup	99
Specifying Scheduled Backup Drives	99
LAN / ISDN / PSTN CONNECTIONS	101
LAN OVERVIEW.....	102
CONNECTING TO A LAN USING TCP/IP.....	102
Configuring TCP/IP Settings.....	102
WEB VIEWER.....	103
WEB VIEWER OVERVIEW.....	104
Configuring the Server for Remote Connection.....	105
Connecting to a DVR Using Web Viewer	105
Closing the Web Viewer	105
INCLUDED SOFTWARE SETUP	107
EMERGENCY AGENT OVERVIEW.....	108
Configuring the DVR.....	108
Configuring the Client PC	108
Setup Window	109
EMERGENCY AGENT WINDOW	109
Filter Event List.....	109
Add Items to Alarm Confirm List	110
SEARCH ALARM WINDOW	111
View Recorded Video	111
Export Video.....	111
REMOTE SOFTWARE OVERVIEW	112
Remote Software Setup.....	113

Installing Remote Software	113
Create a New Remote Connection	113
Configuring the DVR	114
Configuring the Server for Remote Connection	114
DIGITAL VERIFIER OVERVIEW	115
Installing the Digital Verifier	115
Using the Digital Verifier	115
BACKUP VIEWER OVERVIEW	116
Installing Backup Viewer.....	116
Loading Video from DVD or Hard Drive.....	116
SCS OVERVIEW	117
Configuring the Server for Remote Connection	117
Connecting to a DVR.....	117
APPENDIX: SPECIFICATIONS.....	119
XVS SPECIFICATIONS	119
DVS/HVS SPECIFICATIONS.....	120

PREFACE

ABOUT THIS GUIDE

This manual is a setup and maintenance guide that can be used for reference when setting up the DVR and for troubleshooting when a problem occurs. Only authorized personnel should attempt to repair this unit.

Toshiba reserves the right to make changes to the DVRs represented by this manual without notice.

The following text and symbols mark special messages throughout this guide:

NOTE: Text set off in this manner indicates topics of interests that can help the user understand the product better.

TIP: Text set off in this manner indicates topics and points of interests that can be helpful when using or settings up the DVR.

TECHNICIAN NOTES

WARNING: Only authorized technicians trained by Toshiba should attempt to repair this DVR. All troubleshooting and repair procedures that may be shown are for reference and minor repair only. Because of the complexity of the individual components and subassemblies, no one should attempt to make repairs at the component level or to make modifications to any printed wiring board. Improper repairs can create a safety hazard. And any indications of component replacement or printed wiring board modifications may void any warranty

WARNING: To reduce the risk of electrical shock or damage to the equipment:

- Do not disable the power grounding plug. The grounding plug is an important safety feature.
 - Plug the power cord into a grounded (earthed) electrical outlet that is easily accessible at all times.
 - Disconnect the power from the computer by unplugging the power cord either from the electrical outlet or the computer.
-

CAUTION: To properly ventilate your system, you must provide at least 3 inches (7.6 cm) of clearance at the front and back of the DVR.

INTRODUCTION

PRODUCT DESCRIPTION

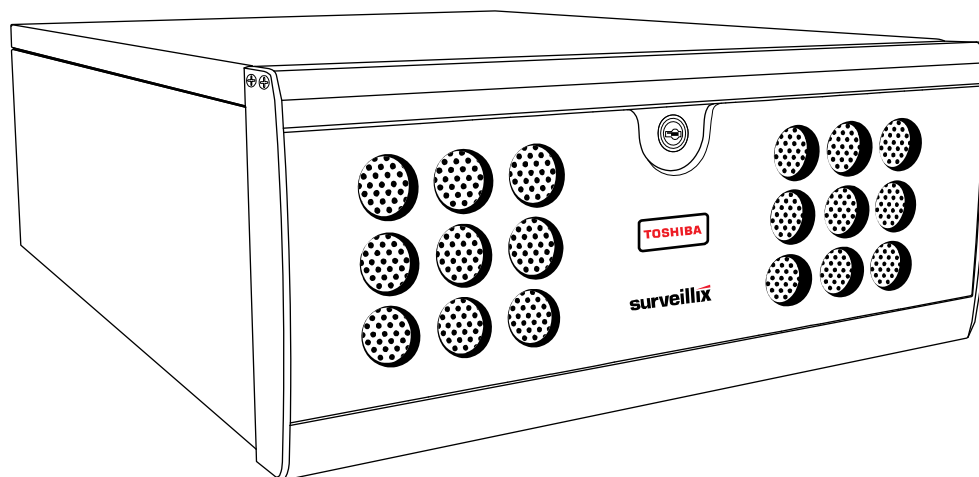

A Surveillix XVS / DVS / HVS is a DVR, a server that performs as a High Definition Digital Recorder. By utilizing the many features of a computer, including processing power, storage capacity, graphics compression, and security features, the DVR is more powerful than the analog recorders of the past.

The Surveillix DVR server software comes pre-configured for fast and seamless integration within your existing IT infrastructure. Designed around Microsoft® Windows XP Embedded, the server software offers unparalleled stability, security, and ease of use. Accordingly, your security investment has never been easier to maintain. Multiple users may simultaneously connect through any network connection for instantaneous live viewing, digital search, and off site video storage. Users can also connect remotely through DSL, Cable Modems, or ISDN. This powerful software enables users to establish recording schedules, create motion detection zones, use PTZ controls, and configure alarm inputs and outputs for each of the system's cameras. With the latest advancements in the DVR Server Software, searching and indexing your video archive has never been easier. Video can now be found, viewed, and exported in a number of file formats with just a few clicks.

The Surveillix DVR is high performance security product ready to meet today's security demands.

FEATURES

Toshiba's Surveillix DVRs include the following new features:

- Optimized and Designed for Microsoft® Windows XP Embedded®
- Up to 32 Camera Inputs
- Supports up to 16 Relay Outputs on Alarm Activation
- Supports up to 16 Sensor Inputs for Alarm Control
- Remote System Operation & Configuration
- Supports Multiple Simultaneous Remote Connections
- PAN / TILT / ZOOM Controls
- Simultaneous Video Search, Playback and Backup
- Video Indexes for Easy Searching
- Multiple Levels of Security Access
- Up to 32 Looping Outputs
- Up to 2 Composite Outputs
- Up to 32 Network Recording Channels
- Up to 8 Audio Inputs
- High Performance, Durable, Rack mount Case
- Output the Video to a NTSC/PAL Display
- Virtually Unlimited Storage Potential
- Digital Signature Support
- Continuous, Motion Detection, Alarm, Pre-Alarm, and Scheduled Recording Modes
- Hardware Watchdog
- Recording Resolution 720x480 / 720x240 / 360x240 NTSC
720x576 / 720x288 / 360x288 PAL

CONTROLS AND CONNECTIONS

This chapter includes the following information:

- Input / Output Connector Locations
- Front Panel Controls and LEDs
- Rear Panel Connectors

FRONT PANEL CONTROLS

The front panel of the DVR contains the devices that will be commonly used for data removal, retrieval, and backup replacement. The most common components and buttons are shown below:

XVS

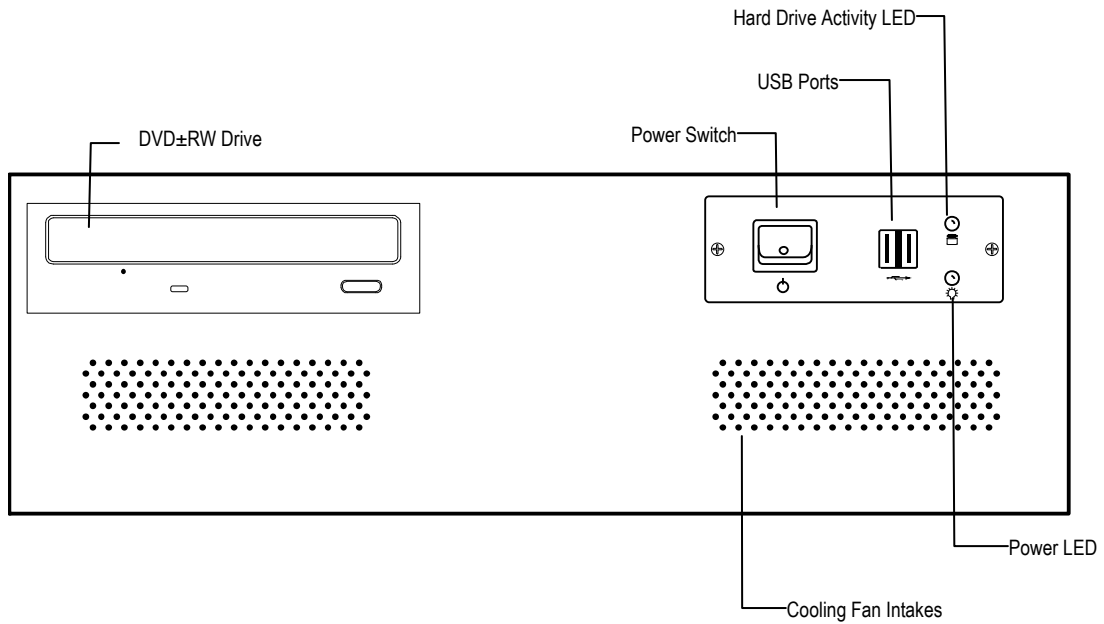

DVS / HVS

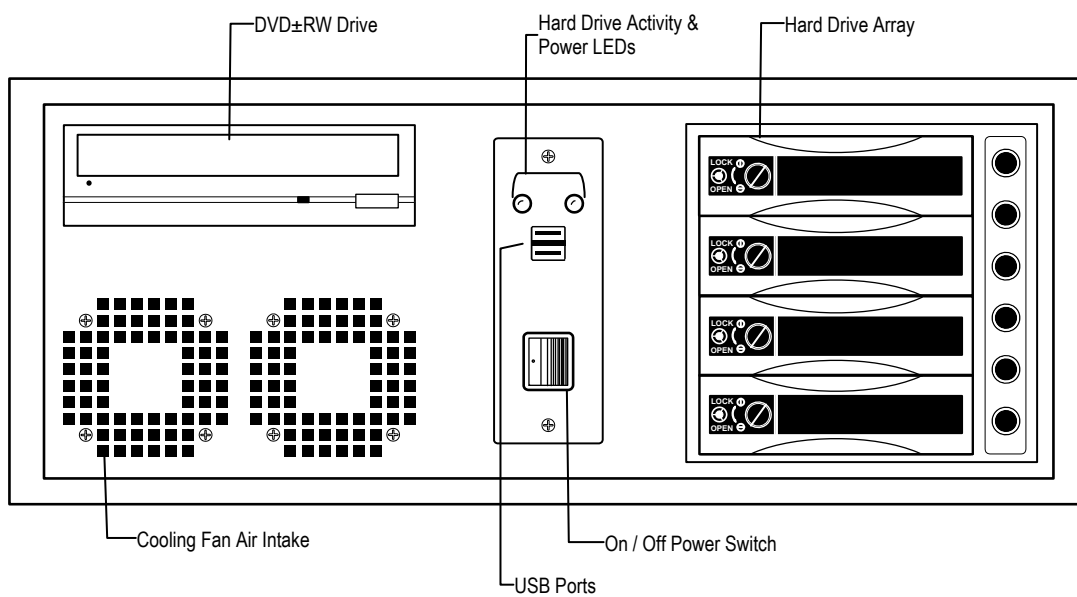

REAR PANEL CONNECTORS

The rear panel of the DVR contains the connectors used to attach cameras, sensors, and relays to the DVR. Below are diagrams that outline the location and description of each connector:

XVS

16 Channel

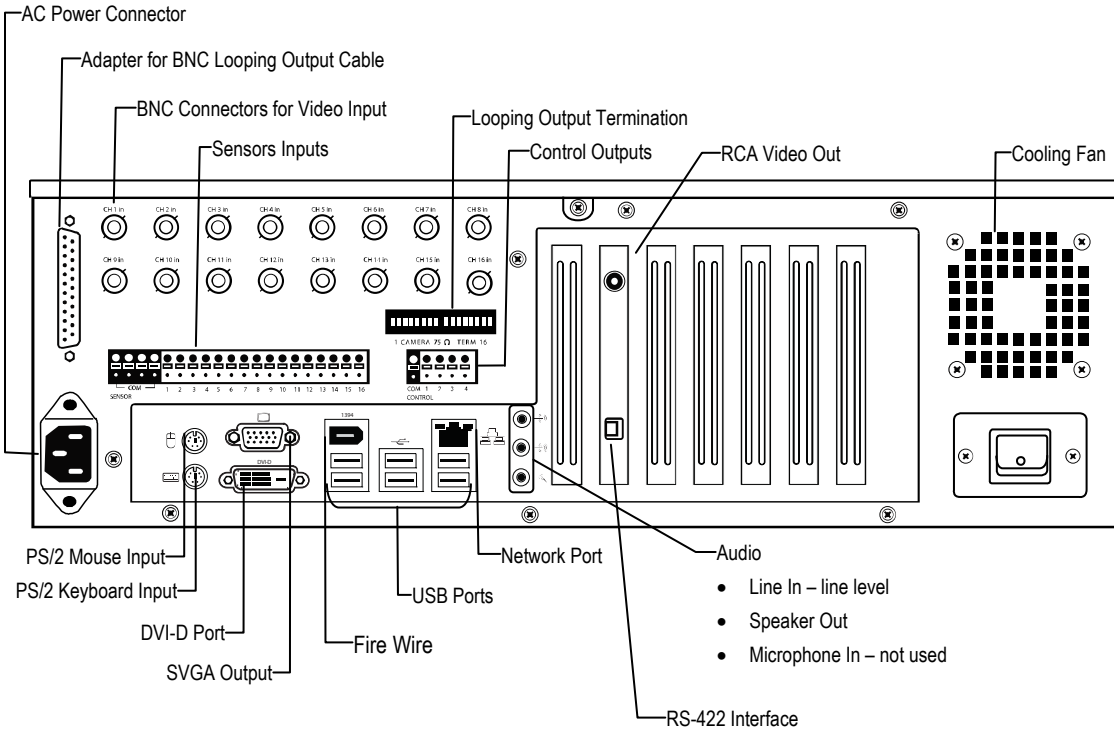

4 Channel

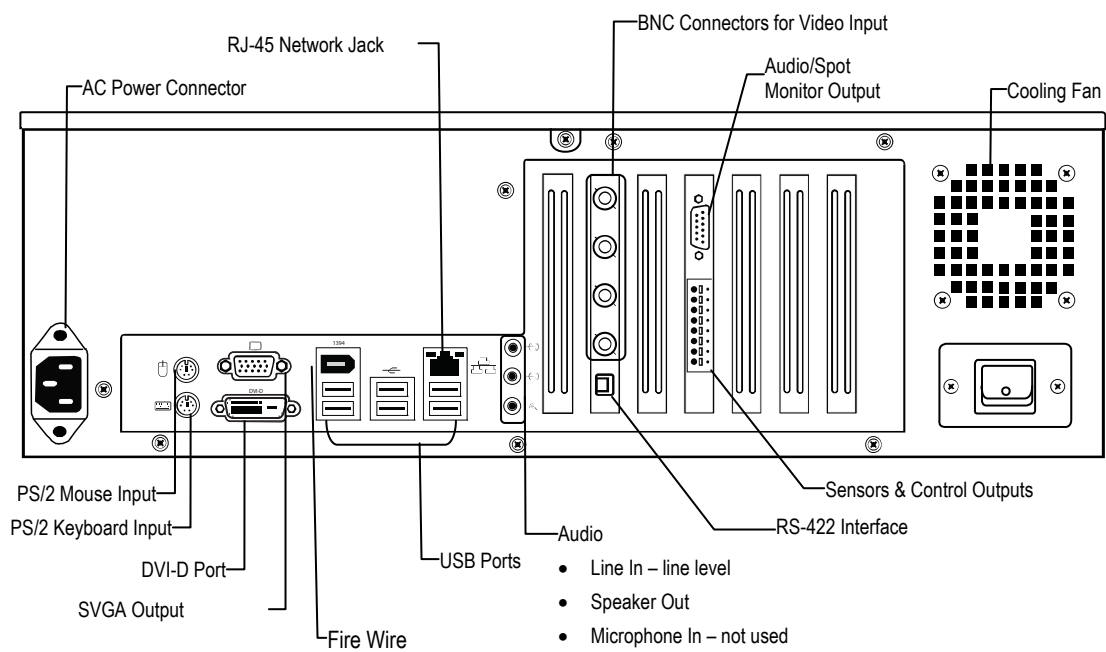

DVS/HVS

8/16 Channel

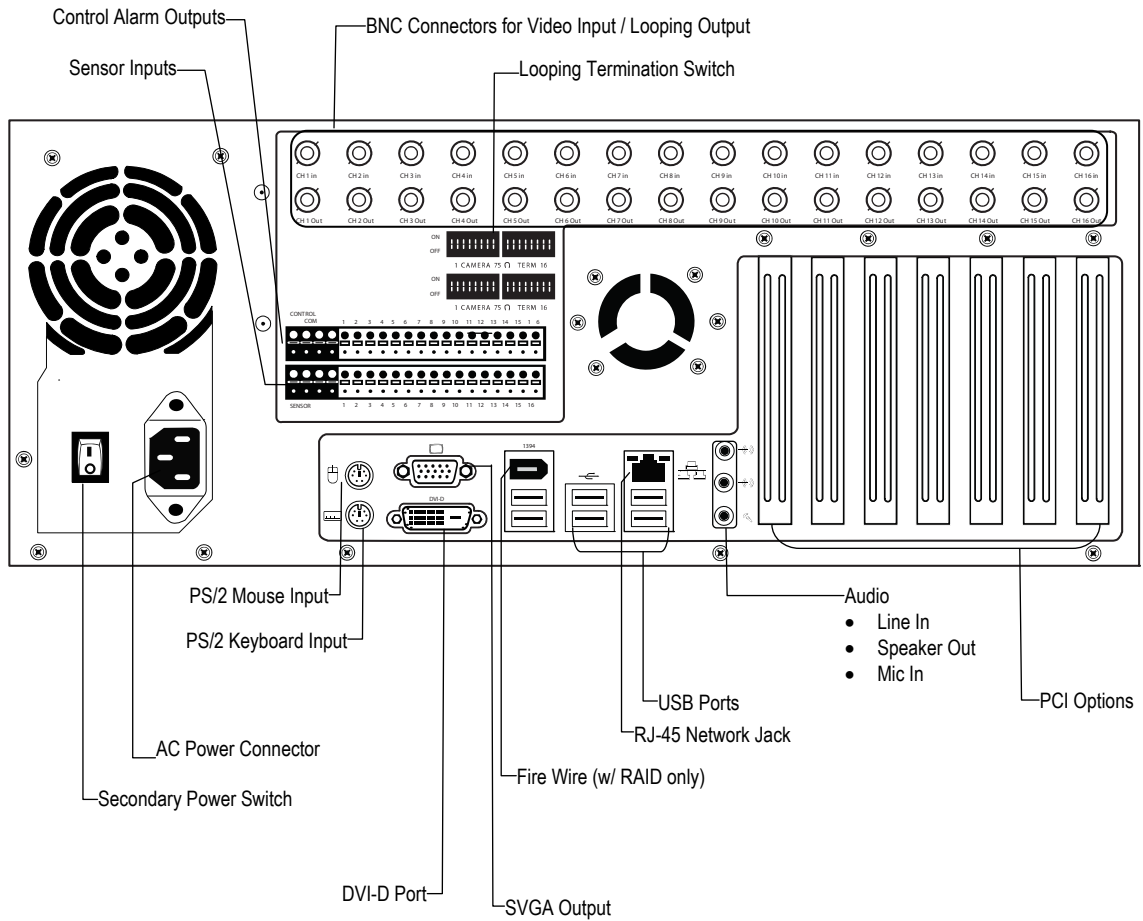

32 Channel

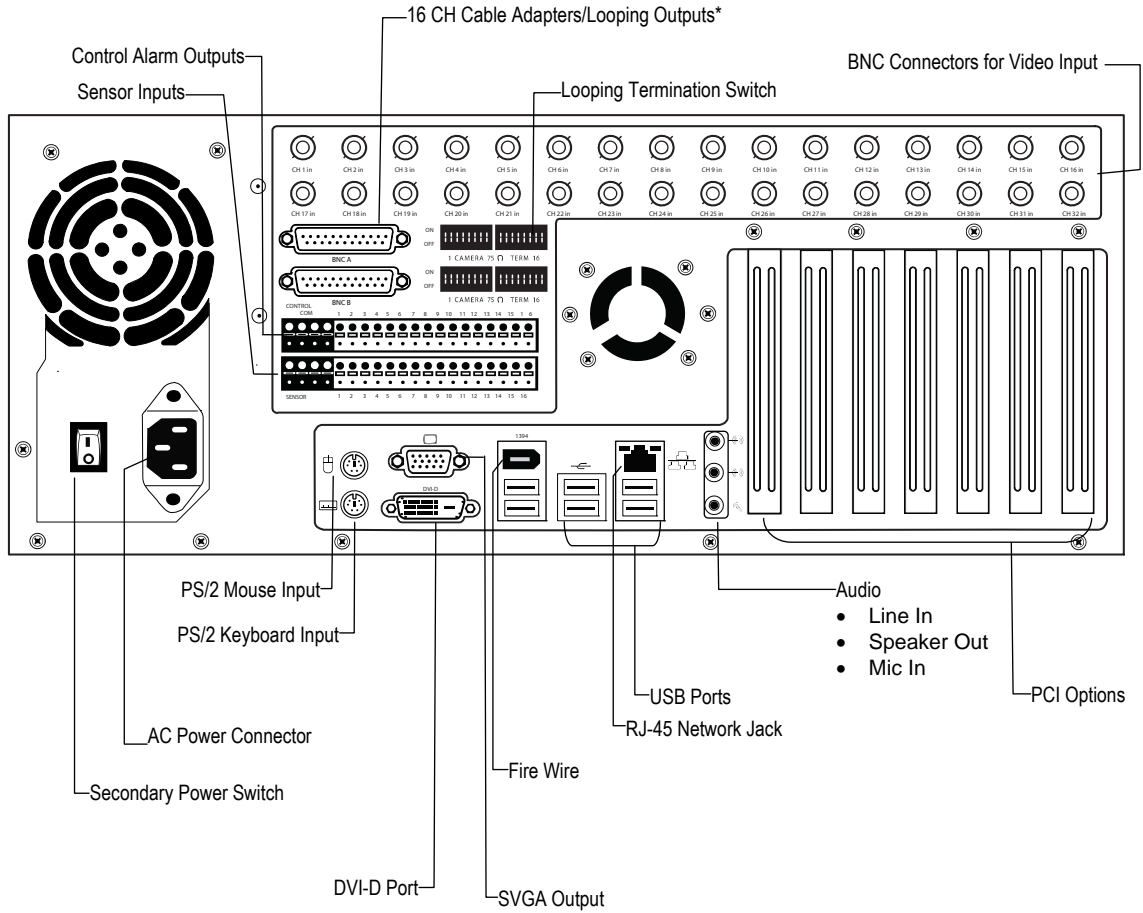

*See Looping Outputs section for illustration.

PCI Card Configurations

120 PCI Configuration

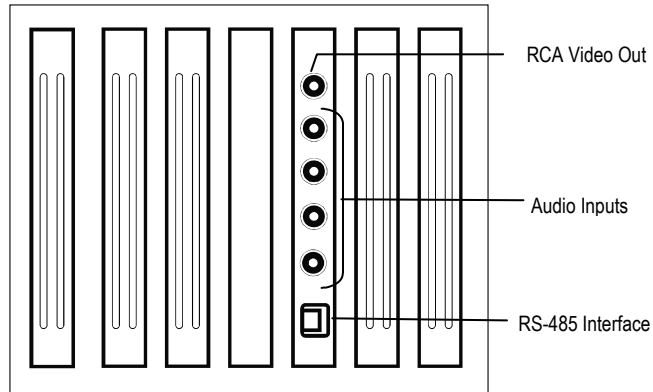

240V PPS PCI Configuration

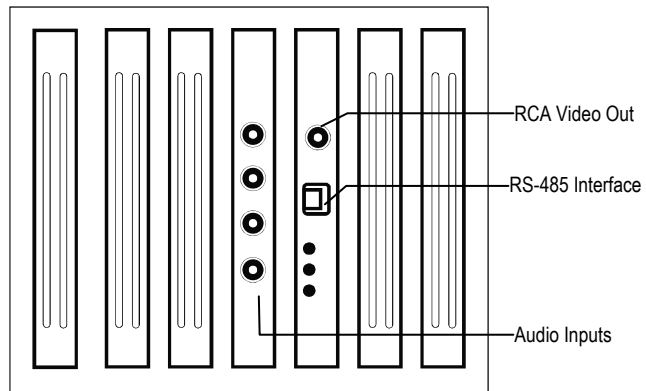

240 PPS 8/16 Channel PCI Configuration

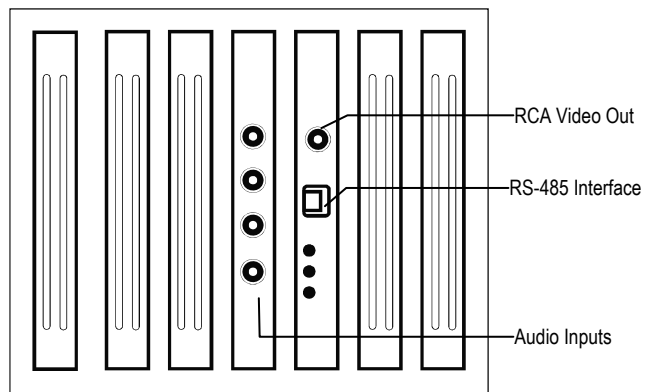

240 PPS 32 Channel PCI Configuration

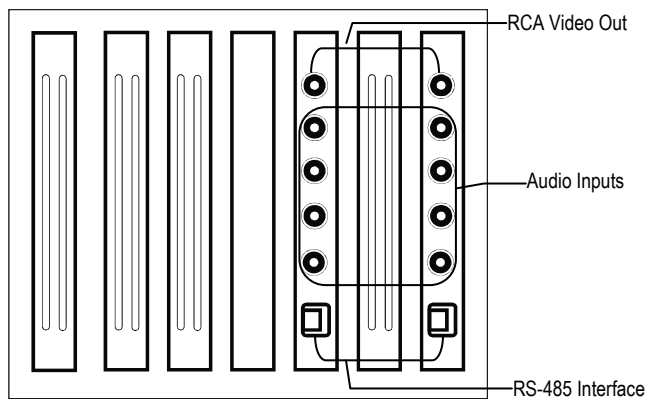

480 PPS 16 Channel PCI Configuration

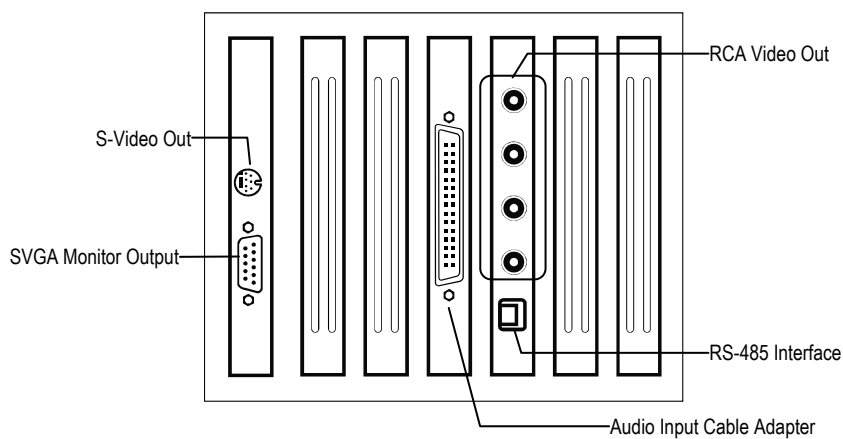

480 PPS 32 Channel PCI Configuration

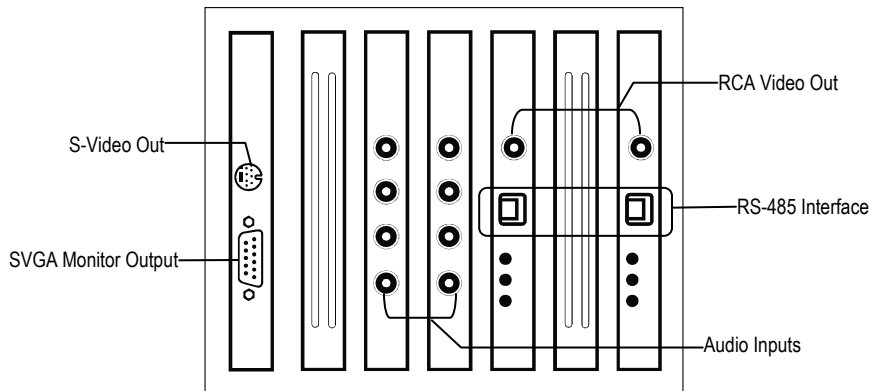

NOTES:

GETTING STARTED

This chapter includes the following information:

- Included Components
- Setting up the DVR Hardware
- Optional Components

IDENTIFYING INCLUDED COMPONENTS

Surveillix™ DVRs come with a mouse, keyboard and selected software and cables. Identify the following components to make sure everything has been properly included with the new DVR. If any of the following items are missing, contact the dealer to arrange a replacement.

 <p>DVR</p>	 <p>Mouse</p>	 <p>Keyboard</p>
 <p>Repair Disc/ Software Disc</p>	 <p>Power Adapter</p>	 <p>PTZ Adapter</p>
 <p>16 Channel Audio Input Cable*</p>	 <p>Audio/Spot Monitor Cable (4 CH XVS Only)</p>	 <p>BNC Connector Cable (16 CH XVS or 32 CH DVS/HVS Only)</p>
 <p>DVR Manual</p>	 <p>RCA to BNC Adapter</p>	 <p>DVR Key</p>

* 16 Channel Audio Input cable included standard with the 16Ch. 480 PPS models (optional 16ch audio card upgrade on other models).

OPTIONAL COMPONENTS

To fully utilize the DVR's potential; several optional Surveillix components are listed below. Contact the dealer for more information.

1 Extra Video Storage Hard Drive

Each DVR has a virtually unlimited storage potential. Add additional Video Data Hard Drives to extend the amount of Video Data the DVR system can store before overwriting older data.

2 UPS UPS Power Backup

UPS Power Backups allow your DVR to remain fully functional even in the event of a power failure. UPS Power Backups also even the fluctuating power current out to provide a consistent, reliable power flow. This creates a stable environment for the DVR and reduces failure.

3 NP-4PKVM 4 Channel KVM Switch

The 4 Channel KVM switch allows you to have multiple boxes (up to 4) using only one keyboard, mouse and monitor. You can simply switch between the DVRs using the keyboard.

4 Hot Swappable Redundant Power Supplies

Every DVR has the option of a dual redundant hot swappable power supply. In the event of a component failure the inoperable power supply may be removed leaving the DVR running so no break in recording occurs. Simply replace the power supply with a new one and you are finished.

5 Raid Controller

A raid controller is available for increased performance or data reliability.

KEYBOARD SETUP

To attach the keyboard to the DVR, plug the end of the Keyboard into the keyboard PS/2 Port located on the back of the machine. The keyboard PS/2 Port can be identified by the purple color. Refer to the Rear Panel Connectors diagram for more information.

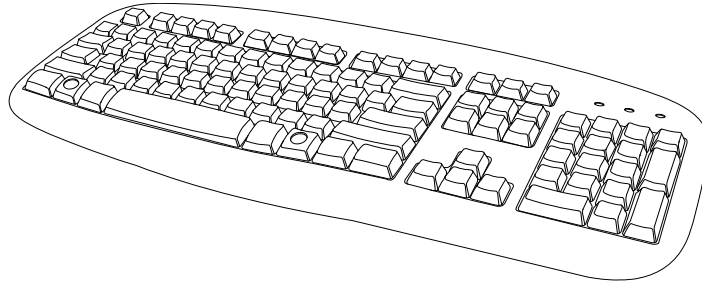

MOUSE SETUP

To attach the mouse to the DVR, plug the end of the mouse into the mouse PS/2 Port located on the back of the machine. The mouse PS/2 Port can be identified by the green color.

The mouse uses a cursor called a pointer. Pointers come in many different shapes but are most commonly shaped like an arrow.

The mouse has two buttons: a left button and a right button. Quickly pressing and releasing one of these buttons is called clicking. Sometimes you will need to double-click – or click the same button twice quickly.

In this manual:

Click means to position the mouse cursor over an item and to single click the left button.

Right click means to position the mouse cursor over an item and to single click the right button.

Double-click means to position the mouse cursor over an item and to click the left button twice.

Select means to position the mouse cursor over a radio button, checkbox, or list item and click on it.

The scroll wheel in between the two buttons is used for added navigation functionality. By moving the wheel with index finger (scrolling), quickly move through multiple pages, lines, or windows. The wheel may also function as a third button allowing the user to quickly click or double-click an icon or a selected item

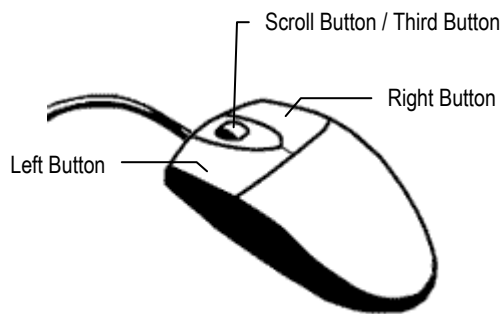

MONITOR SETUP

The DVR has the following connections available to attach a monitor.

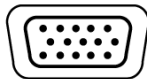

SVGA Output

To VGA Monitor.



DVI-D Output

To TV / Digital Monitor

Attach the monitor or monitors to the rear of the DVR using the cable supplied by the monitor manufacturer. Refer to the monitor manual for detailed information on how to setup and use it.

NOTE: The monitor must be capable of having a screen resolution of 1024 x 768 and display colors of at least 32 Bit

POWER SETUP



WARNING:

To reduce the risk of electrical shock or damage to the equipment:

Do not disable the power grounding plug.
The grounding plug is an important safety feature.

If the electrical plug you are using does not have a ground plug receptacle contact a licensed electrician to have it replaced with a grounded electrical outlet.

Plug the power cord into a grounded (earthed) electrical outlet that is easily accessible at all times.

Disconnect the power from the computer by unplugging the power cord either from the electrical outlet or the computer.

MAKING CONNECTIONS ON AN XVS

Connecting a Video Source

There are different types of Video Sources that can be plugged into the XVS including DVD players, VHS players, and CCTV Cameras. The back of the XVS contains up to 16 video inputs depending on the model. The connectors use the BNC standard.

4 Channel

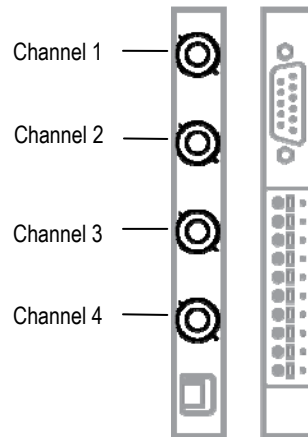

16 Channel

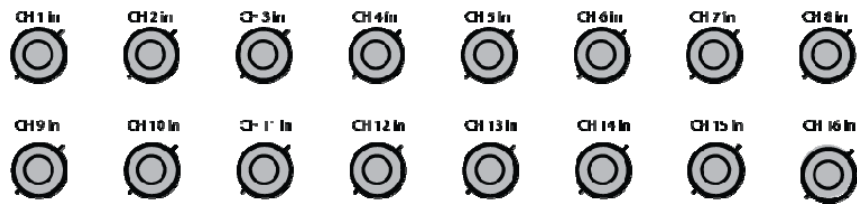

The video inputs are 75 Ω BNC connectors. Plug one end into the video source (DVD, Camera, etc.) and plug the other end into the desired BNC input on the DVR.

Connecting Sensors to the XVS

Each XVS may have up to 16 Sensor inputs. These inputs can be used with devices such as infrared devices, motion device, glass breakage alarms, door and window trips, and many more. The Sensors can be set to Normally Open or Normally Closed inside the software.

There are 4 Common Grounds (-) and 16 sensor inputs (+). There is no power supplied to the ports so an external power supply must be used if power is necessary.

4 Channel

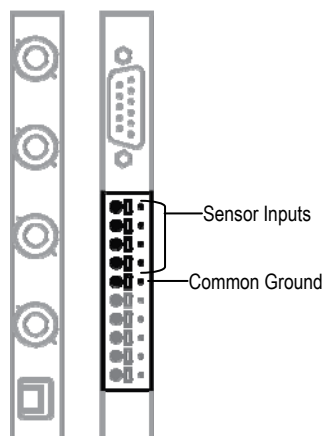

16 Channel

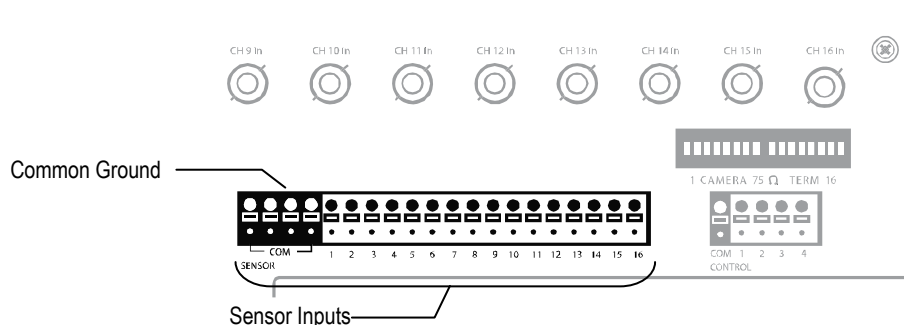

Connecting Control Outputs to the XVS

Each XVS may have up to 4 Control Outputs. These outputs can be used to trigger devices such as Sirens, Phone Dialers, Lights, and any other relay activated device. There is no power supplied to the ports. Use an external power supply if necessary.

16 Channel

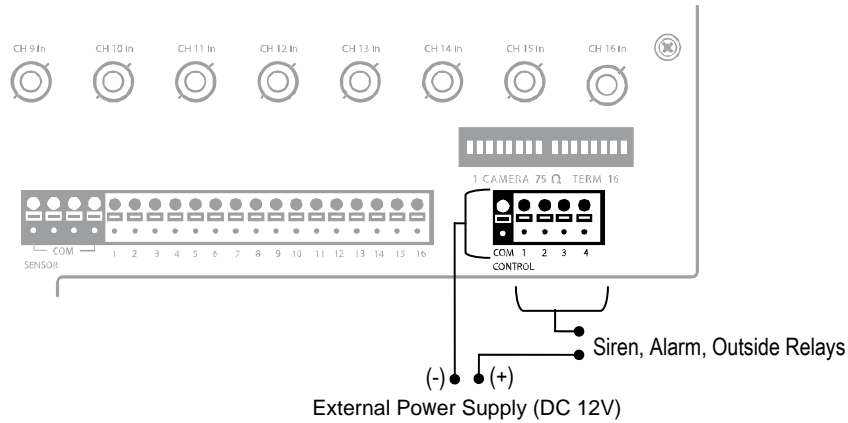

4 Channel

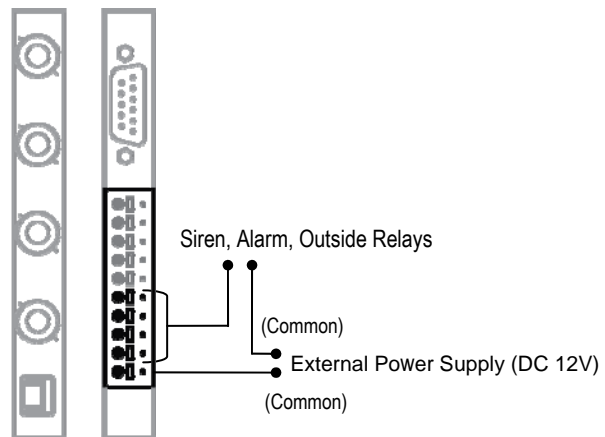

Use 12V, below 300mA. For controlling lights or other devices, use another external relay.

Maximum voltage is 24V AC @ 1 amp

Output uses a Form C Relay

Looping Outputs

The 16 Channel XVS may have up to 16 Looping outputs. Depending on the destination of the outputs, each output may have to be terminated. The outputs are located on the BNC Connector Cable. Attach the cable to the input for the BNC Connector Cable highlighted below.

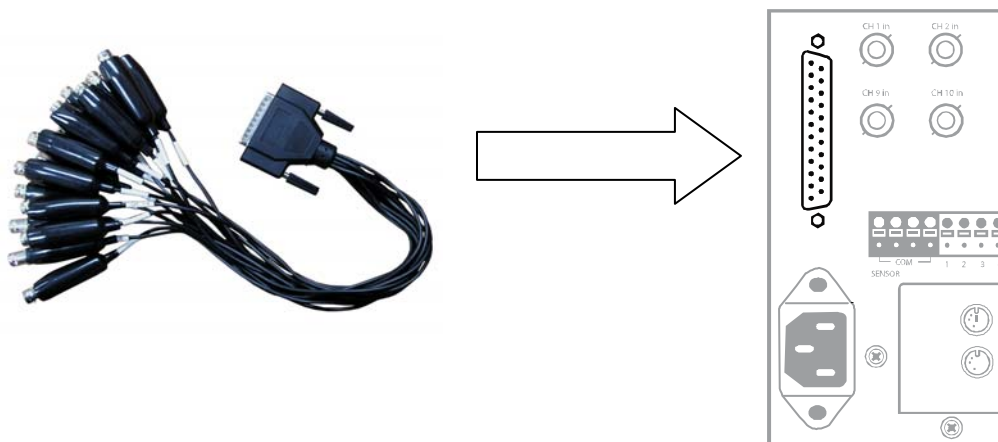

The video inputs are 75 Ω BNC connectors. Make sure there is a video source connected to the input and then connect a cable to the Channel Out on the BNC Connector Cable. The looping outs can be connected to video monitors or combined with adapters to connect to VCR's.

Looping Output Termination

When terminating the outputs becomes necessary, the DVR has built in termination that allows you to select individual outputs to terminate individually. It is not always necessary to terminate the output when using it. It is dependent on the device with which you are connecting it to. As a rule, if the image appears distorted or virtually unviewable, it most likely needs to be terminated.

16 Channel

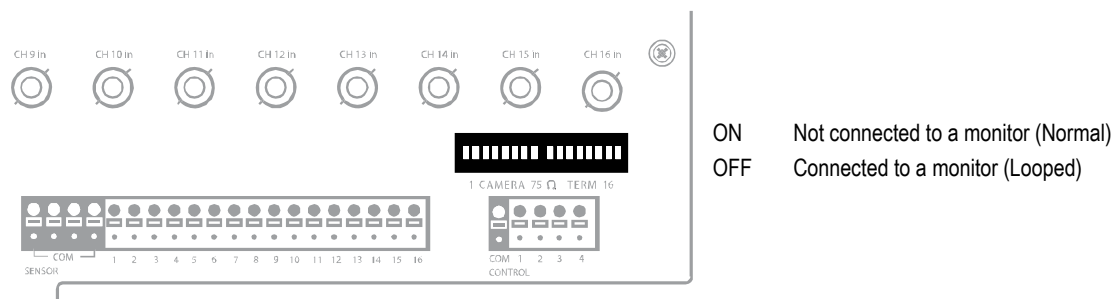

Always leave the dipswitch set to the ON position when the Looping Outputs are not used.

Connecting a PTZ Camera

Setting up a PTZ Camera is simple. The DVR comes preassembled with an internal PTZ adapter. The cabling may be run up to 4,000 ft using 22 Gauge Twisted Pair.

It is important to understand how the PTZ connects to the DVR. The DVR outputs an RS-232 signal and converts in to an RS-485 signal which is then sent to the PTZ camera.

Attaching the 3-Pin PTZ Adapter

1. Locate the PTZ adapter cable.
2. Connect the two wires of the PTZ adapter to the PTZ camera. The red wire on the adapter should connect to the RX+ on the PTZ and the brown wire should connect to the RX-.
3. Connect the other end of the adapter to the DVR as shown.
4. Assign the PTZ camera an ID number in PTZ Setup that coincides with the number assigned to the camera. This is normally done utilizing a dip-switch configuration method on the addressable dome.

Tip It is recommended that the ID of the camera coincide to the input number on the DVR. This will make future troubleshooting and configuration less complex.

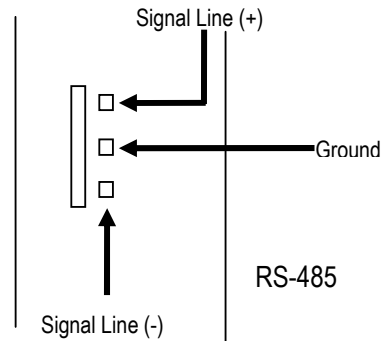

MAKING CONNECTIONS ON DVS / HVS

Connecting a Video Source

There are different types of Video Sources that can be plugged into the DVR including DVD players, VHS players, and CCTV Cameras. The back of the DVR contains up to 32 video inputs depending on the DVR model. The connectors use the BNC standard.

8 Channel

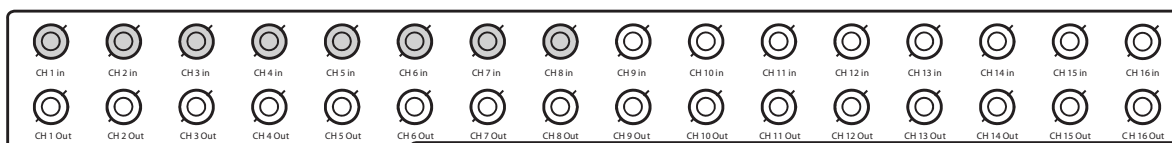

16 Channel

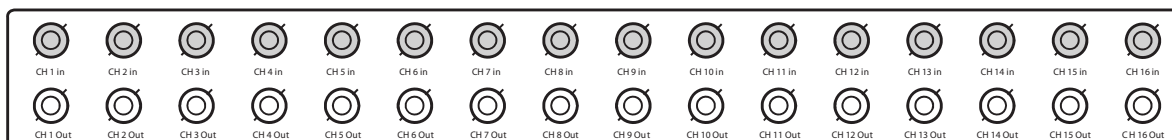

32 Channel

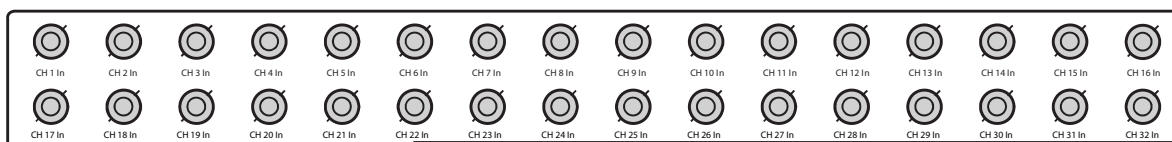

The video inputs are 75 Ω BNC connectors. Plug one end into the video source (DVD, Camera, etc.) and plug the other end into the desired BNC input on the DVR.

Connecting Sensors to the DVS / HVS

Each DVR has up to 16 Sensor inputs. These inputs can be used with devices such as infrared devices, motion device, glass breakage alarms, door and window trips, and many more. The Sensors can be set to Normally Open or Normally Closed inside the software.

There are 4 Common Grounds (-) and 16 sensor inputs (+). There is no power supplied to the ports so an external power supply must be used if power is necessary.

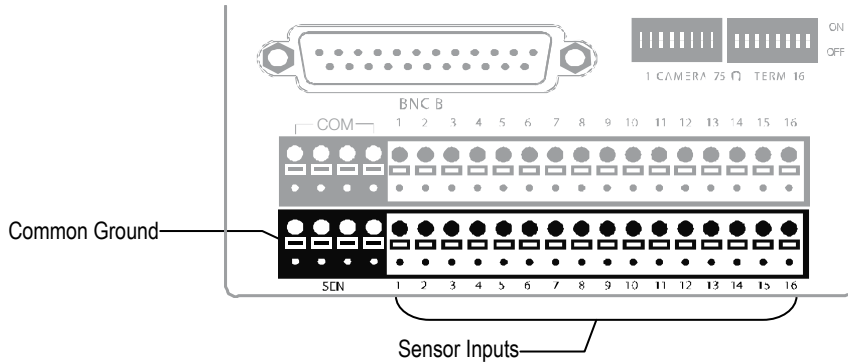

Connecting Control Outputs to the DVS / HVS

Each DVR has up to 16 Control Outputs. These outputs can be used to trigger devices such as Sirens, Phone Dialers, Lights, and any other relay activated device. There is no power supplied to the ports. Use an external power supply if necessary.

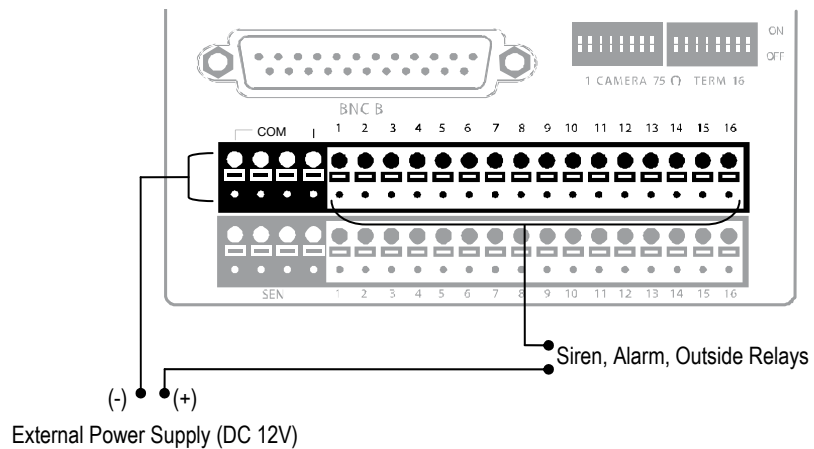

Use 12V, below 300mA. For controlling lights or other devices, use another external relay.

Maximum voltage is 24V AC @ 1 amp

Output uses a Form C Relay

Looping Outputs

The 8/16 Channel DVS / HVS has up to 16 looping outputs. Depending on the destination of the looping outputs, each one may have to be terminated.

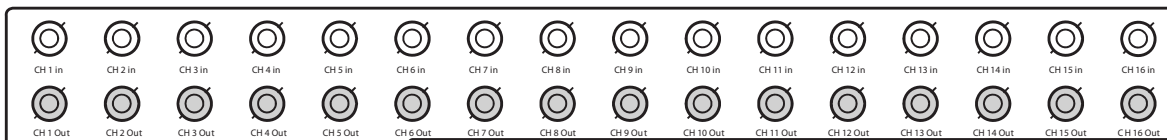

The 32 Channel DVS / HVS has up to 32 looping outputs. Connect the included 16 Channel BNC Connector Cables to the 16 Channel Cable Adapter ports.

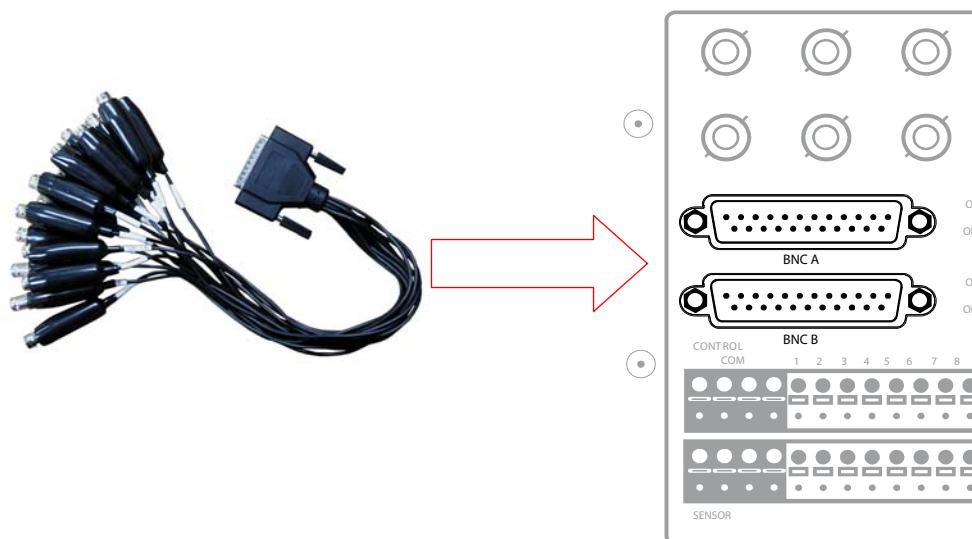

The video inputs/outputs are 75 Ω BNC connectors. Make sure there is a video source connected to the input and then connect a cable to the Channel Out on the BNC Connector Cable. The looping outs can be connected to video monitors or combined with adapters to connect to VCRs.

Looping Output Termination

When it is necessary to terminate a looping output, the DVR has built in termination that allows users to select individual outputs. It is not always necessary to terminate the output; it depends on the device to which you are connecting. As a rule, if the image appears distorted or virtually unviewable, it likely needs to be terminated.

8/16 Channel

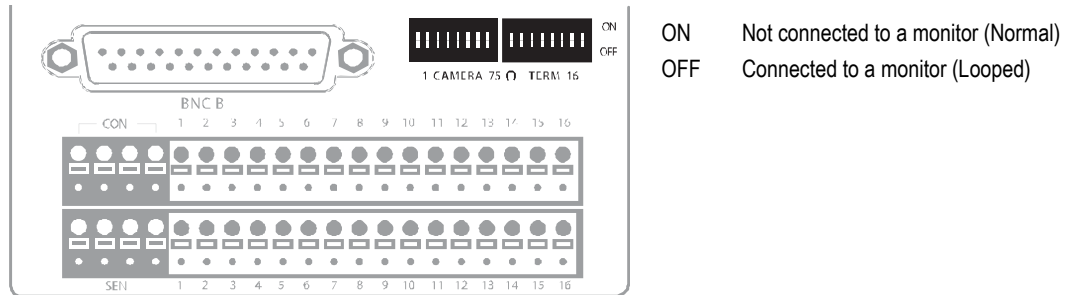

Always leave the dipswitch set to the ON position when the Looping Outputs are not used.

Connecting a PTZ Camera

Setting up a PTZ Camera is simple. The DVR comes preassembled with an internal PTZ adapter. The cabling may be run up to 4,000 ft using 22 Gauge Twisted Pair.

It is important to understand how the PTZ connects to the DVR. The DVR outputs an RS-232 signal and converts in to an RS-422/485 signal which is then sent to the PTZ camera.

Attaching the RS-485 Adapter

1. Locate the PTZ adapter cable.
2. Connect the two wires of the PTZ adapter to the PTZ camera. The red wire on the adapter should connect to the RX+ on the PTZ and the brown wire should connect to the RX-.
3. Connect the other end of the adapter to the DVR as shown.
4. Assign the PTZ camera an ID number in PTZ Setup that coincides with the number assigned to the camera. This is normally done utilizing a dip-switch configuration method on the addressable dome.

Tip Toshiba recommends that the ID of the camera coincide to the input number on the DVR. This will make future troubleshooting and configuration less complex.

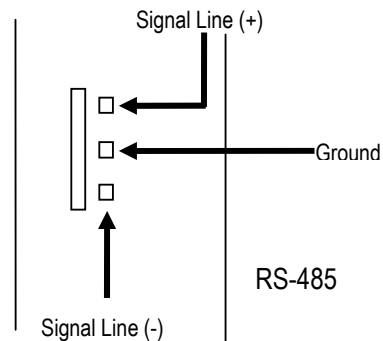

HARD DRIVE ARRAY (DVS / HVS ONLY)

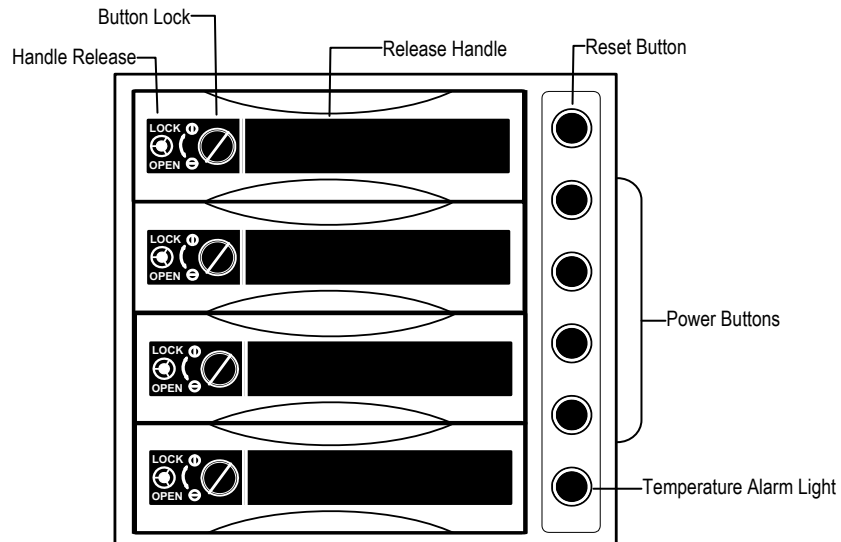

Swapping a Hard Drive

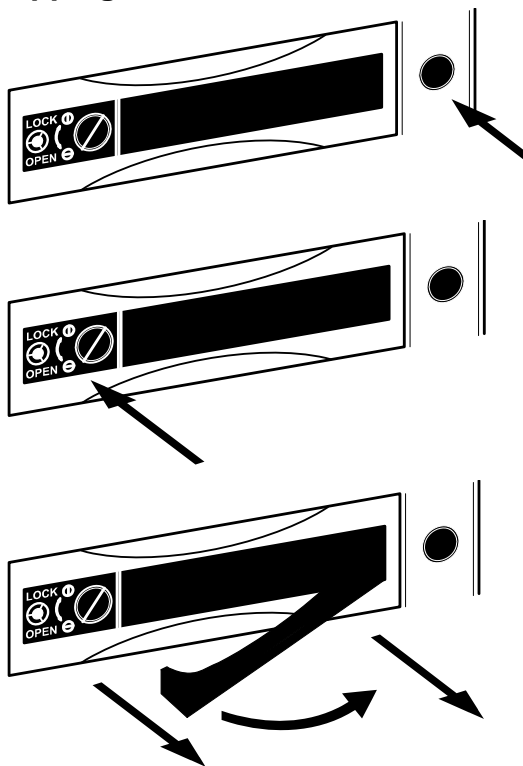

1. Press the Hard Drive Power Button to turn off power to the hard drive being removed.

2. Turn the Button Lock to the open position and push the Handle Release Button

3. Pull the Release Handle outward while removing the hard drive. Reverse steps to install.

TURNING ON THE DVR

Once the cables and adapters have been properly connected it is time to turn on the power. To turn on the power follow these steps:

1. Turn on the monitor and any external peripherals (ex. Printers, External Storage Devices, etc.) connected to the DVR.
2. Turn on the Secondary Power Switch located in the rear of the DVR.
3. Turn on the main power switch located on the front of the DVR.

The DVR will run a series of self-tests. After two or three minutes a series of messages may be displayed as the various hardware and software subsystems are activated. Under normal circumstances you should not be asked to respond to these messages. If you are asked to respond to the messages (adding a Printer, Monitor, etc for the first time) follow the instructions carefully.

After this finishes, the Surveillix DVR software should load automatically and bring you to the main screen.

TURNING OFF THE DVR

To turn off the DVR, select the Exit button on the main screen and select Power Off. The DVR will safely shutdown, it may take several minutes to shut down completely.



CAUTION: Always be sure to follow the proper procedures when turning off the power to the DVR. NEVER disconnect the power to the DVR while it is still running or in the process of shutting down. Doing so can cause data loss, file corruption, system instability and hardware failure

DVR BASICS

This chapter includes the following information:

- Turning the DVR on and off
- Becoming familiar with the Display screen
- Defining Screen Divisions

SETTING THE TIME AND DATE

1. Exit to Windows by clicking the Exit button from the Display screen and selecting Restart in Windows Mode. (See the Display screen section later in this chapter)
2. Open Windows Explorer. Do this by right-clicking the My Computer Icon (located on the top left hand corner of the Desktop) and select Explore.
3. Click on Control Panel to open it. If you do not see Control Panel listed, Click My Computer to expand the folder tree.
4. Double Click on Date and Time inside Control Panel.
5. Adjust the Date and Time.
6. When finished, close all open windows and restart the DVR. Do this by clicking the Start button (Located on the lower left hand side of the Desktop) and selecting Shut Down

ACCESSING THE DVR UTILITY

Exporting DVR Settings

Exporting DVR settings can help configure multiple DVRs quickly or reconfigure a unit that has failed. Some things must be kept in mind when using this feature.

You cannot use this function on:

- DVRs that are different models.
- When upgrading from certain software versions. (This feature cannot be used when upgrading from v2.x to v3.x)

1. Exit to Windows by clicking the Exit button on the Display screen then and select Restart in Windows Mode. (See the Display screen section later in this chapter)
2. Click Start > Programs > Surveillix > VFormat.
3. Click the Export button in the System Settings tool section.
4. Select a location to save the settings file and click Save. The DVR Utility will export the DVR settings and automatically close.
5. Click the OK button to close the VFormat Utility.

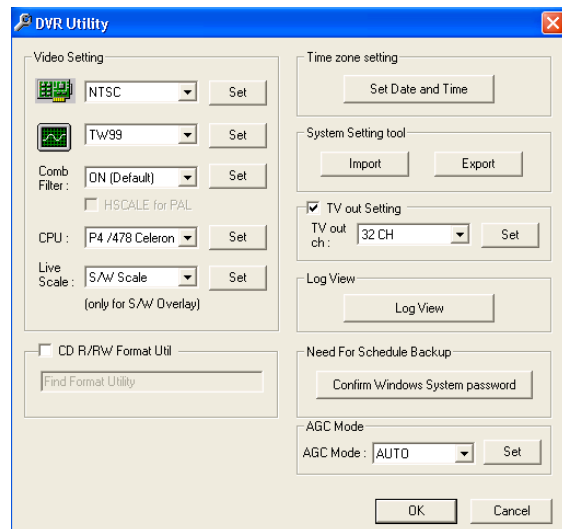

Importing DVR Settings

1. Exit to Windows by clicking the Exit button on the Display screen and selecting Restart in Windows Mode. (See the Display screen section later in this chapter)
2. Click Start > Programs > Surveillix > VFormat.
3. Click the Import button in the System Settings Tool section.
4. Select the location of the settings file to import and click Open.
5. Click Yes to import the data file.
6. Click the OK button to close the VFormat Utility.

Changing Video Format

1. Exit to Windows by clicking the Exit button on the Display screen and selecting Restart in Windows Mode. (See the Display screen section later in this chapter).
2. Click Start > Programs > Surveillix > VFormat.
3. Select the appropriate video setting from the list in the Video Setting Section – NTSC or PAL..
4. Click Set.
5. Click the OK button to close the VFormat Utility.

DISPLAY SCREEN

Each time the DVR starts, the program defaults to the Display screen. The following diagram outlines the buttons and features used on the Display screen. You should become familiar with these options as this is the screen that will be displayed the majority of the time.

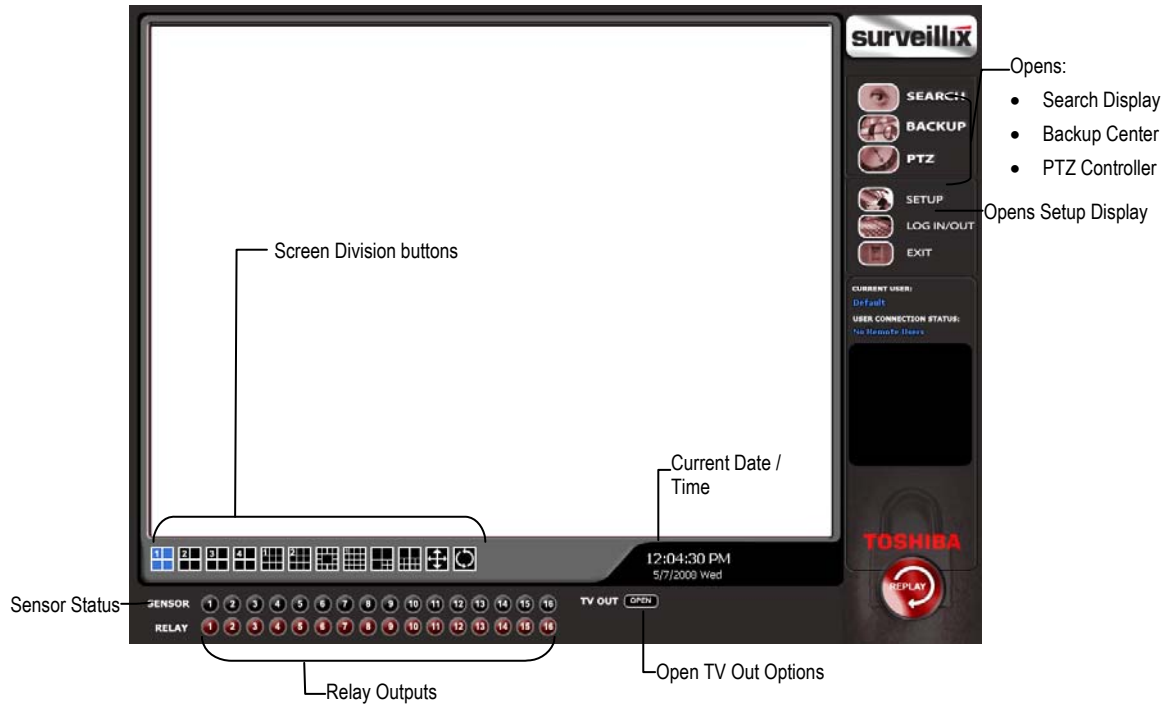

Live Camera Options

Right-click a camera on the Display screen to display these options:

- Full Screen
- Instant Recording
- Search In Live





CAMERA VIEW



Recording Status Indicator

The camera status for each camera is displayed in the upper right corner on the Video Display Area. The following are the different states for each camera:

- | | | |
|---|-------------------------|---|
|  | Recording | Displayed when the camera is currently being recorded to the DVR. |
|  | Motion Detection | Displayed when a camera (set up for motion detection) detects motion. |
|  | Display | Displayed when the camera is currently not being recorded to the DVR. |

Special Recording

There are two types of DVR Special Recording. Text is displayed on the camera indicating what type of Special Recording is activated.

- | | |
|----------------|---|
| SENSOR | Sensor is displayed when a sensor, associated with a given camera, is activated. |
| INSTANT | Instant Recording is a manual activation of the recording for the selected camera. Regardless of the recording method, Instant Recording will start the camera recording and also flag the video for future searches using the Index Search feature. INSTANT is displayed when a user activates the instant recording option. Double Right-Click the video display to activate and deactivate the Instant Recording option. |

SCREEN DIVISION BUTTONS

The Screen Division menu allows you to view cameras in groups such as two by two, three by three and four by four. The button options are shown below.



1st Four Cameras View – Displays cameras 1-4 in the Video Display Area. To return to a different Multi-Camera View, select a different Screen Division option from the Screen Division menu.



2nd Four Cameras View – Displays cameras 5-8 in the Video Display Area. To return to a different Multi-Camera View, select a different Screen Division option from the Screen Division menu.



3rd Four Cameras View – Displays cameras 9-12 in the Video Display Area. To return to a different Multi-Camera View, select a different Screen Division option from the Screen Division menu.



4th Four Cameras View – Displays cameras 13-16 in the Video Display Area. To return to a different Multi-Camera View, select a different Screen Division option from the Screen Division menu.



1st Nine Cameras View – Displays cameras 1-9 in the Video Display Area. To return to a different Multi-Camera View, select a different Screen Division option from the Screen Division menu.



2nd Nine Camera View – Displays cameras 8-16 in the Video Display Area. To return to a different Multi-Camera View, select a different Screen Division option from the Screen Division menu.



Multi-Camera View – Displays a group of cameras within the Video Display Area.



All Camera View – Displays all 16 cameras within the Video Display Area.



Multi-Camera View – Displays a group of cameras within the Video Display Area.



Multi-Camera View – Displays a group of cameras within the Video Display Area.



Full Screen – The Full Screen Option allows you to view the Video Display Area using the entire viewable area on the monitor. When this is selected, no menu options are visible. You can activate the Full Screen Option by clicking on the Full Screen button within the Screen Division menu. You can deactivate Full Screen mode by right clicking on the screen.



Auto Sequence – Sequences through the Screen Divisions sets. For example, selecting the 1A and then the Loop button will sequence through 1A, 2A, 3A, 4A and then repeat. This option is not available for the 7, 10 and 13 screen divisions.

SETUP OPTIONS

This chapter includes the following information:

- Setup Overview
- Camera Setup
- Motion
- Frame Setup
- Schedule
- Sensor
- Network
- Information
- Administrative

SETUP OVERVIEW

The Setup options allow you to optimize your DVR by adjusting things like camera names, reboot schedules, recording schedules and more. It is extremely important that you setup your DVR correctly for several reasons.

- **Recording Schedules** – By optimizing the recording schedule you can increase the amount of pertinent recorded video that is saved on the DVR and keep it longer. You can optimize the type of recording done by adding motion detection to this as well, again increasing the amount of useful video.
- **DVR Access** – By setting up the access passwords you can tightly control the types of access an individual may have. This ensures the security and integrity of the DVR.
- **Camera Naming** – By naming each camera you can easily identify the location and any other pertinent information that may be helpful simply by viewing it on the Video Display Area.
- **Adjusting Camera Color** – By adjusting each camera's color settings you can optimize the clarity and detail that is recorded.



CAMERA SETUP

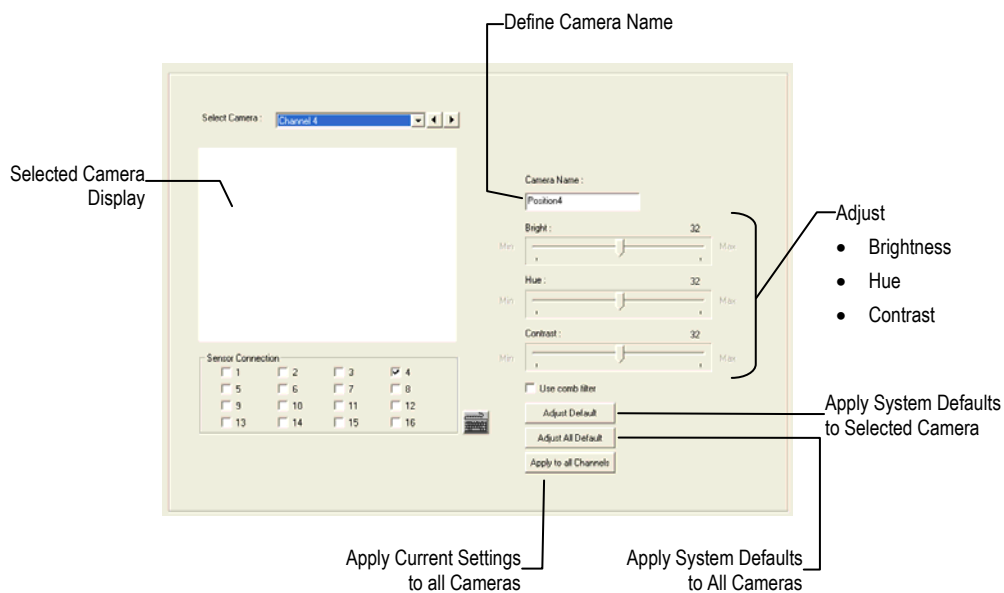

Set Up New Camera

1. Attach camera to the rear of the DVR chassis.
2. Click Setup on the Display screen.
3. Click Camera Setup to open the Camera Setup display.
4. Select the channel that corresponds with the new camera from the Select Camera list.
5. Enter a name for the camera in the Camera Name box.
6. Adjust the Brightness, Hue and Contrast if necessary.
7. Select the appropriate sensors to associate with the camera.
8. Click Apply when finished.

NETWORK VIDEO

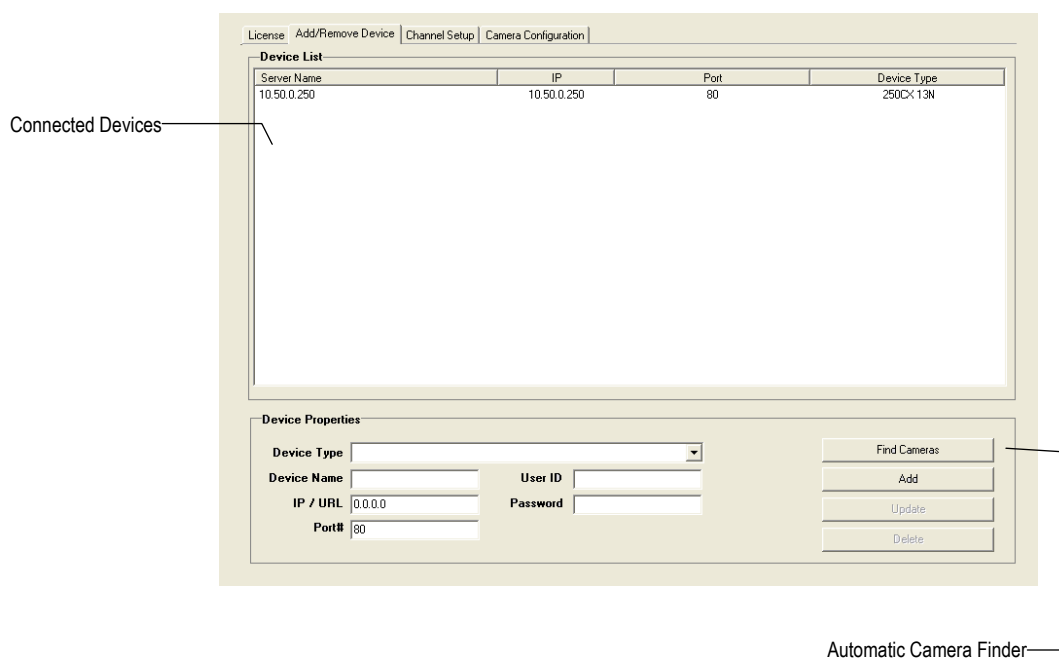

Supported IP Camera Manufacturers

ACTi	Panasonic
Arecont Vision	Pixord
Axis	Samsung
Brans	Securgen
D-Link	Sony
IQeye	Stardot
Lumenera	Toshiba
Mobotix	VivoTek

Connecting a Network Device

Connecting Manually

1. From the Display screen, click Setup.
2. Click Network Video.
3. Click the Add/Remove Device tab.
4. Select your network device from the Device Type list.
5. Type a Device Name.
6. Type the IP/URL address, Port, User ID and Password of the device.
7. Click Add.

Connecting with Camera Finder

1. From the Display screen, click Setup.
2. Click the Network Video tab.
3. Click the Add/Remove Device tab.
4. Click Find Cameras to automatically find all connected Network cameras.
5. Select the check box next to the desired camera.
6. Click Get Device.
7. Type the User ID and Password of the device.
8. Click Update.

Assigning a Network Device to a Channel

1. From the Display screen, click Setup.
2. Click Network Video.
3. Click the Channel Setup tab.
4. Click an available channel on the Channel List.
5. Type the desired Position Name.
6. Select the appropriate network device added previously.
7. If the device has PTZ capabilities, select the PTZ Camera check box to enable.
8. If supported, select the Use Network Camera Motion Detection check box.
9. Click Apply, then click Exit Setup.

Camera Configuration

The Camera Configuration tab displays information on all cameras (analog and network) connected to the Surveillix DVR

Camera Name	Device	Device Channel	Status	Model	IP	Port	Resolution	Frame Rate
<input checked="" type="checkbox"/> Position1	10.0.0.103	Camera 1	Connected	HD4DIP	10.0.0.103	80	704 x 576	1
<input checked="" type="checkbox"/> Position2	10.0.0.35	Camera 1	Connected	HCS554I...	10.0.0.35	80	704 x 288	30
<input checked="" type="checkbox"/> Position3	<None>	<None>	Not Connected					
<input checked="" type="checkbox"/> Position4	<None>	<None>	Not Connected					
<input checked="" type="checkbox"/> Position5	<None>	<None>	Not Connected					
<input checked="" type="checkbox"/> Position6	<None>	<None>	Not Connected					
<input checked="" type="checkbox"/> Position7	<None>	<None>	Not Connected					
<input checked="" type="checkbox"/> Position8	<None>	<None>	Not Connected					
<input checked="" type="checkbox"/> Position9	<None>	<None>	Not Connected					
<input checked="" type="checkbox"/> Position10	<None>	<None>	Not Connected					
<input checked="" type="checkbox"/> Position11	<None>	<None>	Not Connected					
<input checked="" type="checkbox"/> Position12	<None>	<None>	Not Connected					
<input checked="" type="checkbox"/> Position13	<None>	<None>	Not Connected					
<input checked="" type="checkbox"/> Position14	<None>	<None>	Not Connected					
<input checked="" type="checkbox"/> Position15	<None>	<None>	Not Connected					
<input checked="" type="checkbox"/> Position16	<None>	<None>	Not Connected					

Displaying More Columns

The Camera Configuration tab can be customized to display the information you use most. Click **Select Column** to add or remove specific columns.

Capture FPS	IP Address	Codec
Record FPS	Port Number	Quality
Schedule	Resolution	GOP
Manufacturer	Frame Rate	PTZ
Model		

Accessing the Configuration Menu

Use the Surveillix interface to access basic network device menu functions.

1. From the Display screen, click **Setup**.
2. Click **Network Video**.
3. Click the **Channel Setup** tab.
4. Click **Setup Network Device**.
5. Click **Apply**.

HVR Upgrade and Registration

Have the following information available before registering the HVR upgrade.

HVR Software Serial Number: That product Serial Number is the unique number that Toshiba provided with the purchase software.

System ID: The System ID is a number that is generated by the Surveillix unit. This is a unique code generated using the MAC address of the computer running the software. The following steps illustrate how to obtain a unique System ID.

Locating the System ID

1. From the Display screen, click Setup.
2. Click Network Cameras.

License Information

Trial Version - 28 days remaining.

System ID:

License Key:

Channel Connection License

License Key	Total	Used	Free

3. Click the License tab.
4. Click Copy to copy the System ID.

Obtaining the Unlock Code

1. Open an Internet browser and go to: <http://register.surveillixdvr.support.com/>

Product Serial Number

System ID

2. Type the Product Serial Number that was provided by Toshiba.
3. Type the System ID generated by the DVR.
4. Click Submit.

Software Registration

Product Name	01 Channel IP Camera Unlock
Product Serial Number	0000000000000000
System ID	4e000753-00075000
DVR Serial Number:	0000000000000000

Please verify the information and press NEXT to proceed.

5. Verify the information.
6. Click Next if the information provided is correct.
7. Once validated, the user will be provided with the Unlock Code.
8. Print the page and save for later reference.

Software Registration

The following is your unlock code. Keep this number in a safe place as you will need it if you ever reinstall the software.

Unlock Code	00000000-1A8F0E0F00
Product	01 Channel IP Camera Unlock
Product SN	0000000000000000
DVR SN	0000000000000000

NOTE: This unlock code cannot be transferred to a different computer.

Unlocking the Upgrade

1. Return to Setup > Network Cameras > License.
2. Enter the Unlock Code generated by the Surveillix Registration Site into the License Key box.
3. Click Register and confirm that the new License Key is listed in the Channel Connection License box.
4. Click OK.

Unlocking New Network Device

Follow the instructions above for registering the NVR upgrade to unlock any additional network devices.

MOTION SETUP

The DVR allows the user to adjust several different Motion Settings and create motion detection areas.

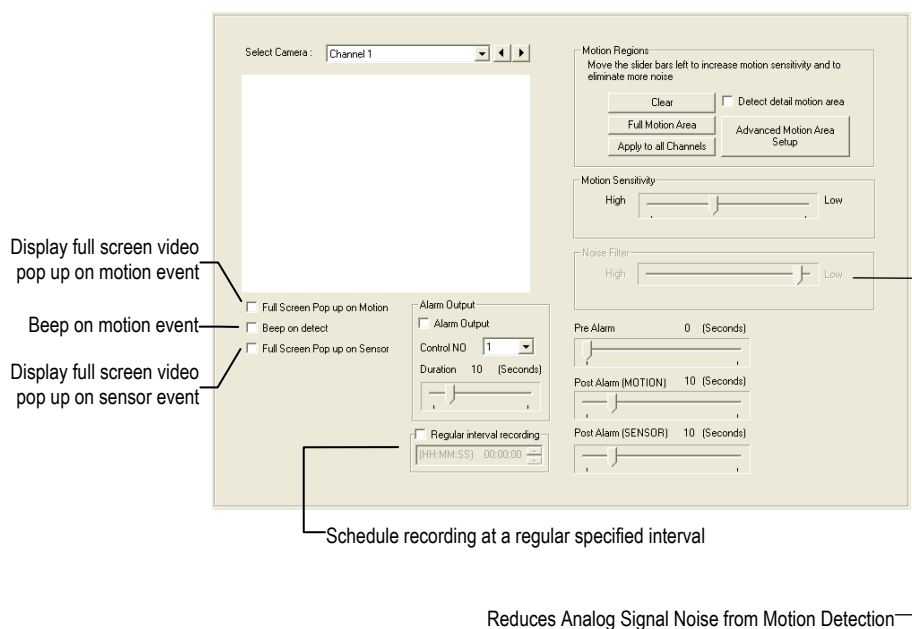

Create a Motion Area

1. Click Motion in Setup.
2. Select a camera from the Select Camera list.
3. Select the Detect Detail Motion Area check box.
4. Click Clear.
5. Click Advanced Motion Area Setup.
6. Click a Motion Detection Area shape button.
7. Drag the mouse over the camera image.

Note To create a polygon shape, click the mouse at each point and double-click to close the shape.

8. Click OK.
9. Move the sliders to adjust motion sensitivity and the noise filter.
10. Define the pre-alarm and post-alarm recording time for a motion event.

Pre Alarm – 0 > 50 Seconds [The number of seconds the DVR records before motion is detected]

Post Alarm (MOTION) – 0 > 50 Seconds [The number of seconds the DVR records after motion is detected]

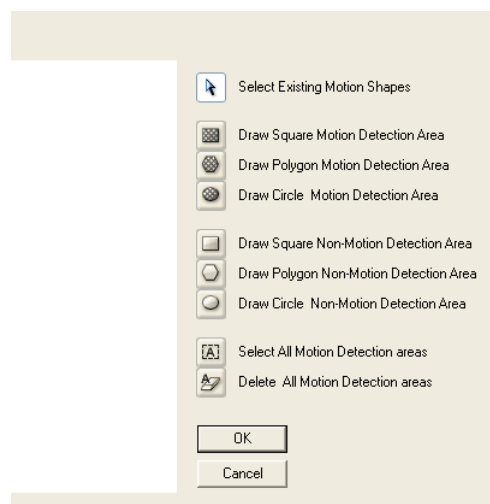

Activating an Alarm on a Motion Event

1. In the Motion Setup window, select a camera to edit from the Camera list.
2. Create a motion area.
3. Select the Alarm Output check box.
4. Select a Control Output to activate for the selected camera.
5. Select an Alarm Duration time when a motion event occurs.

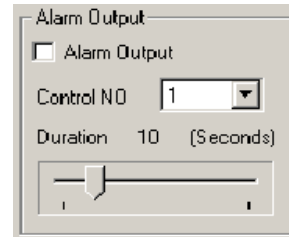

Regular Interval Recording

Regular Interval Recording allows users to record a single frame every few minutes or hours when there is no motion. This option is only available when Motion recording or Sensor recording is selected in the recording schedule.

To enable Regular Interval Recording:

1. Select the Regular Interval Recording check box.
2. Specify how often to take an image when no motion is occurring. Users can go as little as one image per second.

FRAME SETUP OVERVIEW

The Frame Setup menu allows configuration of the PPS, resolution, quality, and sensitivity of camera channels. When configuring the PPS sliders the BLUE slider represents the PPS the DVR will record during intensive recording and have available for transmitting to remotely connected systems. The RED slider represents the PPS that will be recorded by the DVR under normal recording conditions.

The total PPS of all blue sliders may not exceed the recording PPS of the DVR. The PPS of a red slider may not exceed that of the blue slider for the same channel. The dual sliders allow configuration of the DVR to record at a lower PPS while still being able to transmit at a higher PPS to remote connections.

Ex. If a camera channel is set to 25 PPS (blue) and 7 PPS (red), the DVR will record at 7 PPS and users viewing live video remotely can receive up to 25 PPS.

NOTE: The 4 Channel DVR only allows the user to select one frame rate for both recording and remote viewing.

Frame Setup (4 Channel XVS)

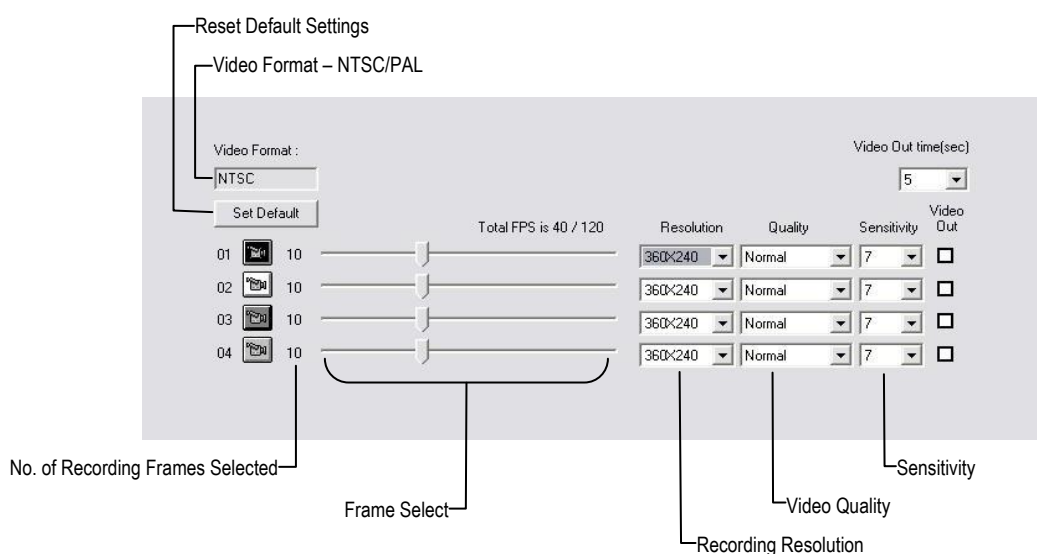

Frame Select	Sets the PPS recorded by the DVR and available for viewing on a remote client PC
Video Quality	Lower quality video has a smaller file size but appears more pixelated
Sensitivity	Sets the Keyframe refresh rate. Adjusting this setting can have negative effects on video quality NOTE: Do not change from default setting unless instructed by a system administrator.

Enable Video Out to Spot Monitor

1. Click Setup on the Display screen.
2. Click Frame Setup.
3. Select the Video Out check box to enable the appropriate channels.
4. Define the Video Out time (seconds to display each channel on spot monitor).
5. Click Apply.

Frame Setup (Real Time Models)

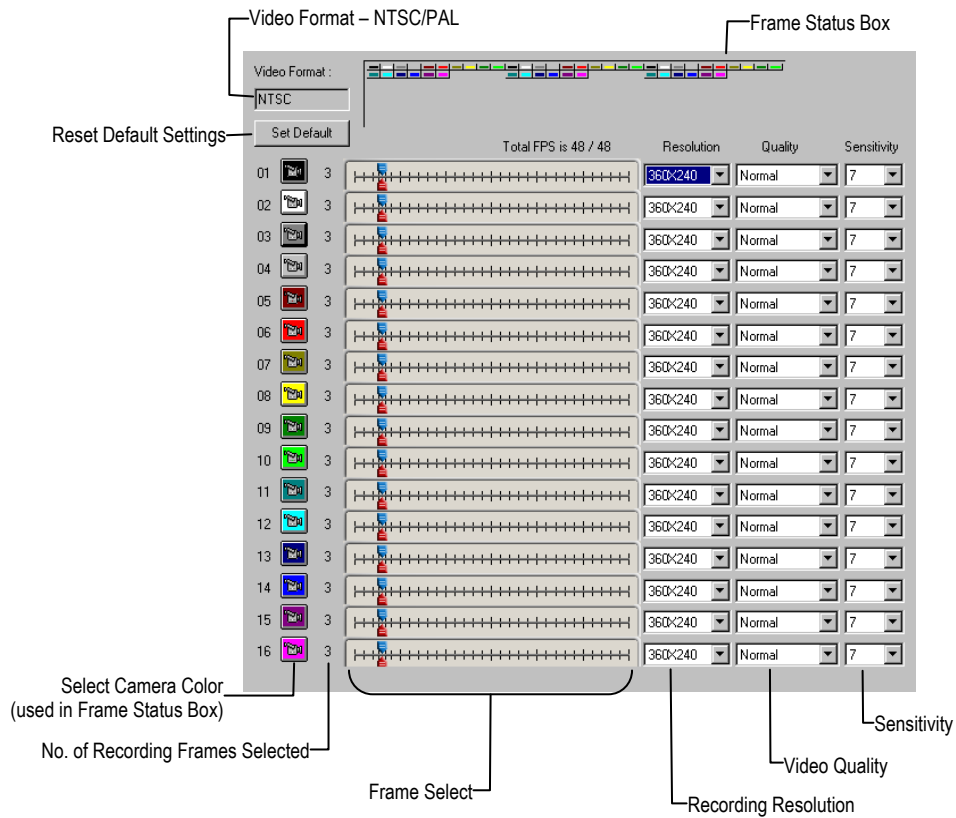

Frame Select	Blue Slider: Sets the PPS recorded during intensive recording and available for viewing on a remote client PC. Red Slider: Sets the PPS recorded by the DVR during normal recording.
Video Quality	Lower quality video has a smaller file size but appears more pixilated.
Sensitivity	Sets the Keyframe refresh rate. Adjusting this setting can have negative effects on video quality. NOTE: Do not change from default setting unless instructed by a system administrator.

Maximum PPS Table

PPS Breakdown for Each Resolution

Resolution	CCTV	x480 model	x240 model
360x240	1CIF	480 PPS	240 PPS
720x240 *	2CIF	240 PPS	120 PPS
720x480 **	4CIF	120 PPS	60 PPS

Resolution	CCTV	x240V model	x120 model
360x240	1CIF	240 PPS	120 PPS
720x240 *	2CIF	120 PPS	120 PPS
720x480 **	4CIF	60 PPS	60 PPS

* Frames recorded in 720x240 are twice the size of the standard 360x240. When recording at 720x240, each frame assigned to the channel will use 2 of the total frames available.

** Frames recorded in 720x480 are four times the size of the standard 360x240. When recording at 720x480, each frame assigned to the channel will use 4 of the total frames available.

32 Channel Frame Allocation

32 Channel models utilize two capture cards. When configuring cameras and allocating frames, the total frame rate for the DVR is split between each capture card. Please reference the chart below for available frames for each grouping of channels.

Resolution	Channels	x240 model	x480 model
360x240	1 to 16	120 frames	240 frames
	17 to 32	120 frames	240 frames
720x240	1 to 16	60 frames	120 frames
	17 to 32	60 frames	120 frames
720x480	1 to 16	30 frames	60 frames
	17 to 32	30 frames	60 frames

SCHEDULE SETUP

Recording Schedule

The Recording Schedule window allows the user to create different recording schedules based on the day, time, and type of recording desired. In addition, this window contains the System Restart options that allow the user to perform basic system maintenance by automatically scheduling the DVR to restart periodically.

The screenshot shows the Recording Schedule Setup window with the following components and annotations:

- Recording Schedule Window:** The main window containing the recording schedule configuration.
- Single Day Selection / Multi Day Selection:** A label pointing to the "Single Day Selection" button.
- Open Restart Setup Window:** A label pointing to the "Restart setup" button.
- Create Special Day Recording Schedules:** A label pointing to the "Normal Day Mode" dropdown menu.
- Recording Mode Options:** A label pointing to the "No recording", "Continuous", and "Motion" buttons.
- Emergency IP Setup:** A label pointing to the "Emergency IP" configuration section.

The window includes the following controls and data:

- Recording/Sensor Mode:** Radio buttons for "Recording" (selected) and "Sensor".
- Day of week:** Checkboxes for SUN, MON, TUE (checked), WED, THU, FRI, SAT.
- Recording schedule table:**

ALL	0	1	2	3	4	5	6	7	8	9	10	11	12
CAM01	Yellow	Yellow	Yellow	Yellow	Yellow	Yellow	Yellow	Yellow	Yellow	Yellow	Yellow	Yellow	Yellow
CAM02	Yellow	Yellow	Yellow	Yellow	Yellow	Yellow	Yellow	Yellow	Yellow	Yellow	Yellow	Yellow	Yellow
CAM03	Yellow	Yellow	Yellow	Yellow	Yellow	Yellow	Yellow	Yellow	Yellow	Yellow	Yellow	Yellow	Yellow
CAM04	Yellow	Yellow	Yellow	Yellow	Yellow	Yellow	Yellow	Yellow	Yellow	Yellow	Yellow	Yellow	Yellow
CAM05	Yellow	Yellow	Yellow	Yellow	Yellow	Yellow	Yellow	Yellow	Yellow	Yellow	Yellow	Yellow	Yellow
CAM06	Yellow	Yellow	Yellow	Yellow	Yellow	Yellow	Yellow	Yellow	Yellow	Yellow	Yellow	Yellow	Yellow
CAM07	Yellow	Yellow	Yellow	Yellow	Yellow	Yellow	Yellow	Yellow	Yellow	Yellow	Yellow	Yellow	Yellow
CAM08	Yellow	Yellow	Yellow	Yellow	Yellow	Yellow	Yellow	Yellow	Yellow	Yellow	Yellow	Yellow	Yellow
CAM09	Yellow	Yellow	Yellow	Yellow	Yellow	Yellow	Yellow	Yellow	Yellow	Yellow	Yellow	Yellow	Yellow
CAM10	Yellow	Yellow	Yellow	Yellow	Yellow	Yellow	Yellow	Yellow	Yellow	Yellow	Yellow	Yellow	Yellow
CAM11	Yellow	Yellow	Yellow	Yellow	Yellow	Yellow	Yellow	Yellow	Yellow	Yellow	Yellow	Yellow	Yellow
CAM12	Yellow	Yellow	Yellow	Yellow	Yellow	Yellow	Yellow	Yellow	Yellow	Yellow	Yellow	Yellow	Yellow
CAM13	Yellow	Yellow	Yellow	Yellow	Yellow	Yellow	Yellow	Yellow	Yellow	Yellow	Yellow	Yellow	Yellow
CAM14	Yellow	Yellow	Yellow	Yellow	Yellow	Yellow	Yellow	Yellow	Yellow	Yellow	Yellow	Yellow	Yellow
CAM15	Yellow	Yellow	Yellow	Yellow	Yellow	Yellow	Yellow	Yellow	Yellow	Yellow	Yellow	Yellow	Yellow
CAM16	Yellow	Yellow	Yellow	Yellow	Yellow	Yellow	Yellow	Yellow	Yellow	Yellow	Yellow	Yellow	Yellow
- Event Selection:** (A) Alarm Event, (R) Central Station, (E) Emergency Agent, Delete Alarm.
- Emergency IP Setup:**

IP	Use	IP
IP 1	<input type="checkbox"/>	0.0.0.0
IP 2	<input type="checkbox"/>	0.0.0.0
- Emergency Time (sec.):** 5
- Special day section:** "Normal Day Mode" dropdown, date "6/28/2005", "Save special day", and "Delete special day" buttons.

Create a Recording Schedule

1. Select a day to begin creating the schedule for -or- click **Single Day Selection**, enabling **Multi Day Selection**, to create the same schedule for multiple days.
2. Highlight the Time-Blocks within the **Recording Schedule** window for the camera(s) selected to schedule. Once the desired Time-Blocks are highlighted, click a **Recording Mode** button. The Time-Blocks should now appear Blue for Motion, Yellow for Continuous and White for No Recording.

Note Leave cameras recording with **Sensor Detection** set to **No Recording** for the specified time block(s).

Create a Sensor Schedule

1. Click **Schedule** and then select the **Sensor** option. Select a single day or click **Single Day Selection** to include multiple days in the schedule.
2. Highlight the Time-Blocks within the **Recording Schedule** window for the sensor(s) to enable and schedule. Once the time blocks are highlighted click **Enable**. The time block will now appear red.

Scheduling Alarm Events

There are three types of Alarm Events:

ALARM EVENT: This option logs the Alarm Events on the local server.

CENTRAL STATION: This option sends a Map Alarm to Central Station software such as SCS Multi-Site Management.

EMERGENCY AGENT: This option sends the Alarm Event to the Emergency Agent software.

Motion can be designated as an alarm event. Often motion does not need to be treated as an Alarm event. Ex: During work hours, motion that occurs is expected and should not be treated as an alarm. However, after business hours, any motion that occurs could be treated as an alarm.

1. Click **Schedule** on the Setup screen.
2. Select either **Recording** or **Sensor**.
3. Highlight time blocks in the schedule that have been set to Motion (or Sensor) and click the desired Event buttons (**Alarm Event**, **Central Station**, **Emergency Agent**). A corresponding letter will display in the selected time blocks.

Emergency Agent Schedule

Video recording triggered by motion or sensor events can be sent to the Emergency Agent software.

1. Enable the **Emergency Agent Event**. (see **Scheduling Alarm Events** above).
2. Enter the IP Address of a PC running the Emergency Agent software under **Emergency IP**.
3. Select the check box next to the IP Address to enable it. Only one IP Address is supported at a time.
4. Enter the recording duration (in seconds) in the **Emergency Time** box.

Tip See the **Emergency Agent** chapter for detailed information on setting up the Emergency Agent software.

Special Day Schedule

The user can create days that have a unique recording schedule. If necessary create these on days that are 'not typical' such as Holidays, Special Events, etc.

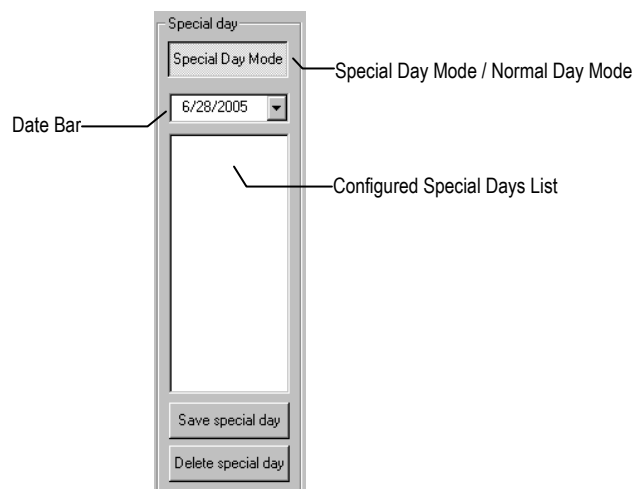

Creating/Editing a 'Special Day' Schedule

1. Click Normal Day Mode to enable the Special Day Mode.
2. Select a day by typing the date or clicking the arrow to the right of the Date Bar.
3. Highlight the time-blocks within the Recording Schedule window for the camera(s) selected. Once the desired Time-Blocks are highlighted, click a Recording Mode button.
4. When finished creating the schedule the Save Special Day.

Note The special day should now appear as a date in the Special Day Schedule.

Deleting a 'Special Day' Schedule

1. Select a date from the Special Days list.
2. Click Delete Special Day.

System Restart Setup

System Restart Setup allows the user to define a schedule wherein the DVR automatically restarts according to specified parameters.

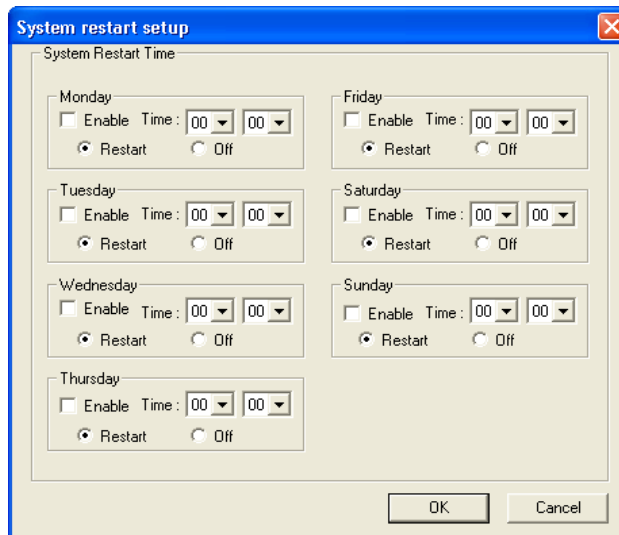

Create System Restart Schedule

1. Click Schedule on the Setup screen.
2. Click Restart Setup.
3. Select the day(s) of the week to schedule an automatic system restart and select the check box to enable shut down.

Note This step alone does not trigger the DVR to restart, only to shut down.

4. Specify the time of day to schedule the system restart.
5. Select the Restart option.

Note If Off is selected, the DVR will shut down at the specified time but not restart.

SENSOR SETUP

The Alarms setup window allows you to enable, disable and configure Sensors and Relays (Control Outputs).

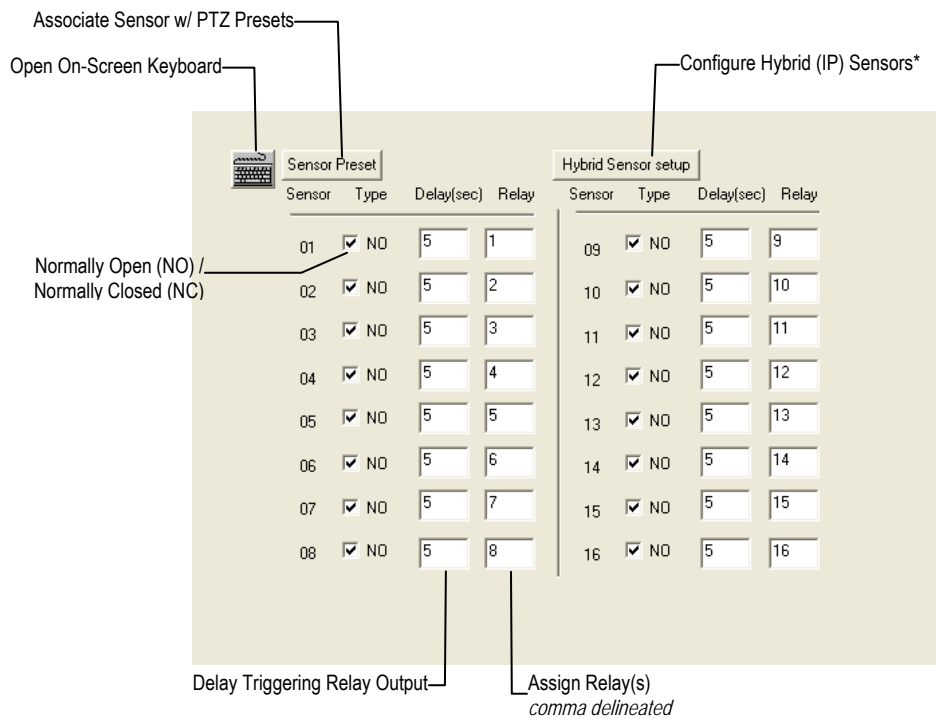

*Requires the HVR Software Upgrade

Configure Sensor Response

1. Click Setup on the Display screen.
2. Click Sensor.
3. Click the NO or NC check box to select Normally Open or Normally Closed for the desired sensor.
4. Enter the Delay time to define the number of seconds after the sensor is tripped until the relay is activated.
5. Enter the Relays to associate with the sensor. Two or more relays can be associated with a single sensor – separate with commas.
6. Click Apply.

Activate PTZ Preset on Sensor

1. Create a PTZ Preset Position. See instructions in the PTZ Setup chapter.
2. Click Setup on the Display screen.
3. Click Sensor.
4. Click Sensor Preset.
5. Select the desired camera from the Channel list.
6. Select the appropriate Sensor from the list.
7. Select the preconfigured PTZ Preset from the list.
8. Click Set. A list of configured Sensor Presets will display in the box below.
9. Repeat for additional sensors.
10. Click OK to close the Sensor Preset window.

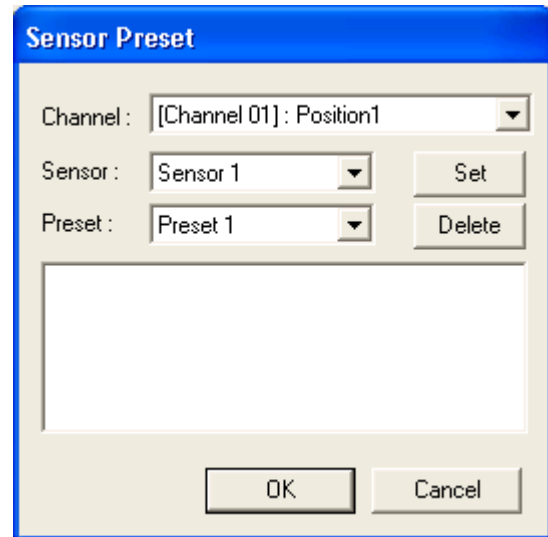

The image shows a software dialog box titled "Sensor Preset". It features three dropdown menus: "Channel" (set to "[Channel 01] : Position1"), "Sensor" (set to "Sensor 1"), and "Preset" (set to "Preset 1"). To the right of the "Sensor" dropdown is a "Set" button, and to the right of the "Preset" dropdown is a "Delete" button. Below these controls is a large, empty rectangular box. At the bottom of the dialog are "OK" and "Cancel" buttons.

GENERAL SETUP

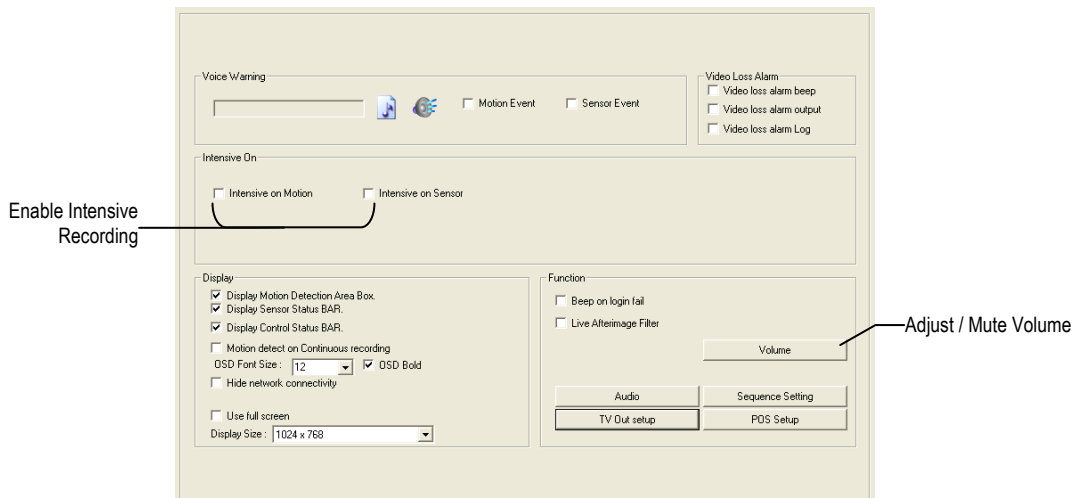

<i>Function</i>	
Beep on Login Fail	Enables the DVR to beep continuously in response to a failed login attempt. Only an authorized login will stop the beeping.
Sequence Setting	Allows the video out picture to automatically cycle through channels at a set speed. Example: .Cycle through channels 1-6 at four-second intervals.
<i>Display Options</i>	
Use Full Screen	Stretch the Surveillix interface to use the full monitor screen.
Display Size	Select from available monitor display sizes. Use to correctly display video on wide screen monitors.

Voice Warning

The DVR allows users to play a sound file when either a Motion event or Sensor event occurs. This file can be a custom created sound file that is unique to the application. The selected WAV file is played through speakers attached to the DVR.

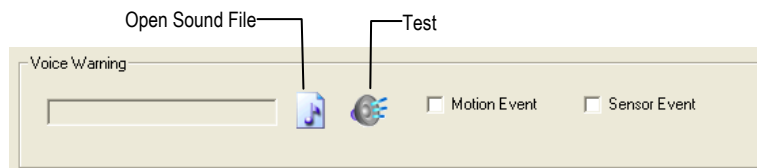

1. Click the Open Sound File icon to browse for a WAV file. The selected file will display in the box on the left.
2. Click the Test icon to verify the audio file.
3. Select Motion Event and/or Sensor Event to trigger the audio file.

Intensive Recording Overview

The Intensive Recording Option allows you to increase the Pictures Per Second of any camera, using sensor or motion activation. See Frame Setup for information on configuring intensive options. This guarantees that the Pictures Per Second and Resolution will be set correctly and not exceed the DVR limitation.

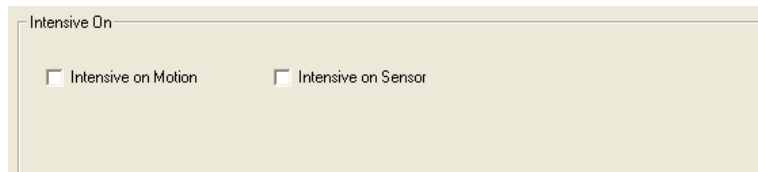

Using Intensive Recording

The Intensive Recording option is set up as 'All or Nothing'. This means that once enabled (associated with sensors); all cameras associated with sensors will activate the Intensive Recording.

To activate the Intensive Recording option, follow these steps.

1. Inside Camera Setup, select the camera to use and enable the sensor to associate with it.
2. Click General. Select the Intensive-on-Sensor and/or Intensive on Motion check boxes.
3. Open Schedule under Setup Options. Select the Sensor option.
4. Enable the sensor by creating a schedule for it.
5. Click Apply and exit setup.

TV-Out Setup (Analog)

The DVR features an optional TV-Out functionality which allows users to output video from any number of cameras, in sequence, to a television or monitor display.

1. Select the TV Out Port to use

Note Each Port must be configured individually, i.e. one after the other.

2. Select the Use check box to enable TV-Out functionality for the selected port.
3. Select each camera to display through the TV-Out port.
4. Select an Event Popup check box if desired.
5. Define the Event Holding Time (the number of seconds the camera displays after an event) for selected event types.
6. Define the Auto Switching Time (the number of seconds between switching of camera) for the selected TV-Out Port.

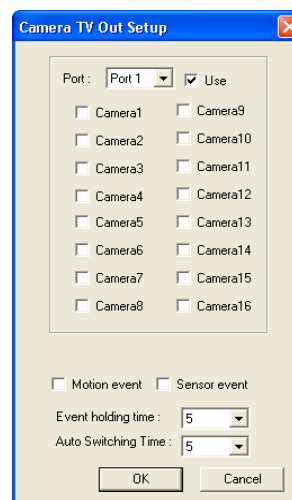

TV-Out Setup (Multiplexer)

The Multiplexer TV Out card is an optional upgrade that allows users to output video in a sequence or a matrix display.

Note IP cameras will not display on the Multiplexer TV Out card.

Configure Sequence Mode

Tip If no cameras are configured in the TV Out Setup, the sequence mode will cycle through all connected camera.

To configure settings for the TV Out sequence mode:

1. On the General screen of Setup, click TV Out Setup.
2. Select the TV Out Port to use from the Port list.

Note Each Port must be configured individually, i.e. one after the other.

3. Select the Use check box to enable TV-Out functionality for the selected port.
4. Select each camera to display in the sequence.
5. Select an Event Popup check box if desired.
6. Define the Event Holding Time (the number of seconds the camera displays after an event) for selected event types.
7. Define the Auto Switching Time (the number of seconds between switching of camera) for the selected TV-Out Port.
8. Click OK and then click Apply.

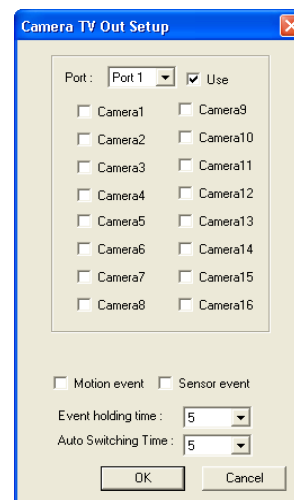

Control Sequence Mode Display

1. Click TV Out on the Display screen.
2. To change the camera that is displayed on the monitor, click the desired camera number in the row that the monitor is connected to.

Tip Port 1 is the top port on the TV Out card.



Sequence Button

3. To stop the Sequence, click Auto.
4. To close the TV Out controls, click Close.

Control Multiplexer Mode Display

1. Click TV Out on the Display screen.
2. Click Multiplexer.
3. To change the camera that is displayed on the monitor, click the desired camera number in the row that the monitor is connected to.

Tip Port 1 is the top port on the TV Out card.

Note Only Ports 1 and 2 can be configured in multiplexer mode. Channel 3 will mimic channel 1, and channel 4 will mimic channel 2.

4. Click the desired screen division to display in multiplex mode.
5. Click the Sequence button to start sequencing through cameras.

Tip When in Multiplexer mode, the display can only sequence through one type of screen division (eg. 4 Channel divisions A – D or 9 Channel divisions A and B on a 16 channel DVR).

6. To close the TV Out controls, click Close.

Connecting to a Wide Screen Display

1. Click Exit on the Display screen and select Exit in Windows Mode.
2. Right-click the Desktop and select Properties.
3. Click the Settings tab.
4. Drag the Screen Resolution bar to the proper resolution of the connected display.

Tip Refer to the display documentation for the proper resolution settings.

5. Click OK and confirm the change.
6. Double-click the Surveillix Server icon on the Desktop.
7. Click Setup on the Display screen and then click General.
8. Under Display Settings, select the Use Full Screen check box and then select the correct resolution from the Display Size list.
9. Click Apply.

Volume

The volume control allows fine tuning of the volume settings on the DVR.

Volume Options:

- **Slider Controls** – Used to adjust the literal volume for the respective devices listed.
- **Mute Check Box** – Select the mute check box to mute volume on any of the device columns or select the Mute All check box to mute all audio on the DVR.

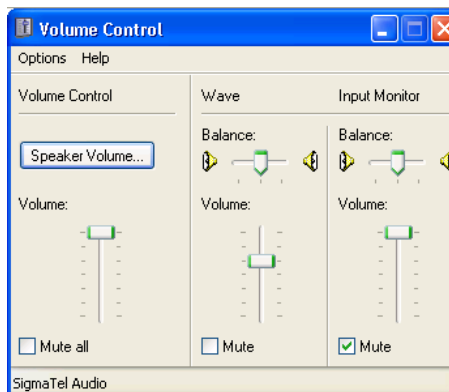

Audio

The Surveillix DVR is capable of recording up to 16 channels of audio depending on the model.

AUDIO FEATURES:

- 8000 Hz playback in Live Mode
- Up to 48000 Hz playback in search mode
- Mono Sampling

DATA SIZE (Per channel)

- 1 Second: 1625 bytes
- 1 Minute: 97,500 bytes
- 10 Minute: 975,000 bytes
- 1 Hour: 5,850,000 bytes
- 1 Day: 140,400,000 bytes (Approx 140MB)

Select the Audio Capture Channels check boxes to enable recording and adjust the Gain to the desired level.

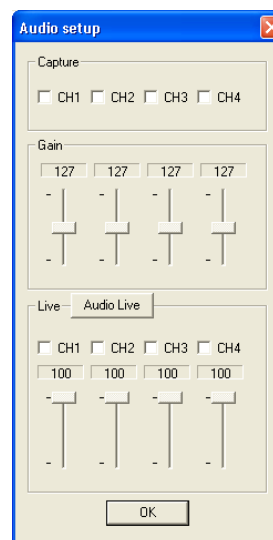

Enabling Audio Recording

1. Click **Audio** on the General setup display.
2. Select an audio channel under **Capture**.
3. Click **OK**.

Enabling Live Audio

1. Click **Audio** on the General setup display.
2. Select an audio channel under **Live**.
3. Click **OK**.

Auto Sequence Setting

Auto Sequencing is available either in the Display screen when Auto Sequencing has been enabled or when a Spot-Monitor out signal is used to display on a spot monitor. Auto Sequencing conveniently displays video channels at specified intervals and sequences through each selected channel.

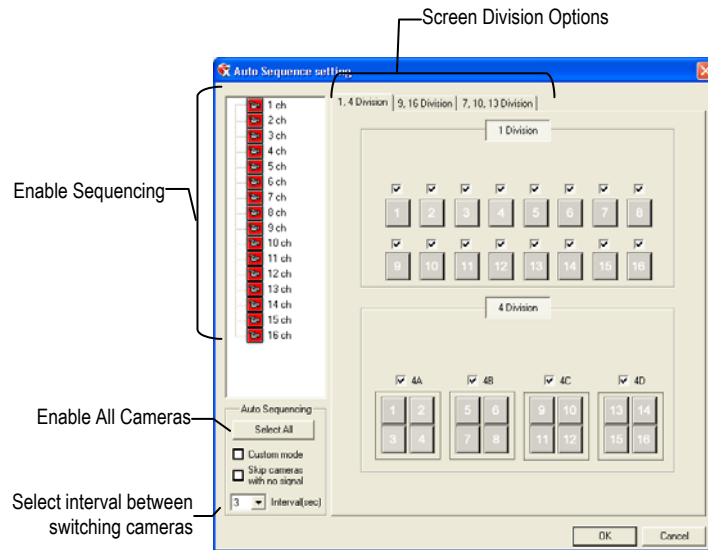

Custom Mode	Create non-standard screen divisions
Skip 0 FPS Channel	Sequence skips cameras with no video signal

Create Custom Auto Sequence

1. Open General setup and click Sequence Setting.
2. Click individual cameras in the left pane or click Select All to include all cameras in the sequence.
3. Select an Interval time (in seconds) to display each screen in the sequence.
4. Select screen division options for appropriate cameras.

NETWORK SETUP

Network Setup allows the user to adjust settings such as Ports, setup emergency PPP information for use with the Emergency Agent and enable Remote Access.

The screenshot shows the Network Setup configuration page. It includes several sections:

- Disable Remote Control:** A checkbox that is currently unchecked.
- View IP address:** A button with a keyboard icon.
- Transport Setup:** Contains dropdown menus for Quality (Normal) and Resolution (Original), a Transport Rate field (100), and an Advanced... button.
- Network Setup:** A box containing fields for TimeOut Value (30), Emergency Port (2001), Center Port (2000), Image Port (2002), and Search Port (2003).
- PPP Setup(Emergency):** A box with a Use PPP checkbox, Password and Confirm fields, a Phone Number field, and a Modem Select dropdown (N/A).
- Web Function:** A section with a Web Viewer(iDVR) checkbox and three port fields: HTTP Port (80), iDVR Port (3001), and Live Port (3100).
- Keyboard Control:** A section with a Use Keyboard Control checkbox and a Setup Keyboard Control button.
- Two-way Audio Communication:** A section with an Enable Audio Communication checkbox and an Audio Port field (3002).

 Annotations with arrows point to specific elements:

- "Settings for Video Sent to Remote Client" points to the Transport Setup section.
- "Use with Remote Connections" points to the Network Setup section.
- "Enable RS-232 Keyboards (PTZ)" points to the Use Keyboard Control checkbox.
- "Use with Emergency Agent" points to the PPP Setup(Emergency) section.
- "Between DVR and Remote Client" points to the Audio Port field in the Two-way Audio Communication section.

Transport Rate

A bandwidth throttle based on percentage of free network.

Web Viewer (iDVR)

Enables/Disables access to the DVR using the Web Viewer interface.

PAN/TILT SETUP

The Pan/Tilt Setup display allows enabling of PTZ cameras, creation of Presets, creation of Tours, and adjustment of camera speed settings. Some options listed here are features only available on selected cameras. Refer to the PTZ chapter in this manual for further information on setting up PTZ cameras and setting PTZ options.

INFORMATION

The Information display allows users to define the site code necessary for connecting to remote software, save comments relative to the DVR and store tech support and contact number information.

The screenshot shows the 'Information' display interface. It is divided into several sections:

- Top Right:** 'Current Server Software Version' with a callout pointing to 'DVR Version 3.6.0'.
- Top Center:** 'Total HDD /Available HDD Space' with a callout pointing to the 'Drive Information' section.
- Left Side (Site Information):**
 - Site Code :
 - Board Serial # :
 - System Serial # :
 - Decoder :
 - Video Format :
 - Notes :
- Right Side (Drive Information):**
 - C: Drive
 - Total Space : 20259 MB
 - Free Space : 17425 MB
 - D: Drive
 - Total Space : 219097 MB
 - Free Space : 219022 MB
 - E: Drive
 - CD Drive
- Bottom Right (Telephone Number):**
 - Contact Number :
 - Tech. Support :

Callouts include 'Enter comments' pointing to the Notes field and 'User-Defined Contact Numbers' pointing to the Contact Number and Tech. Support fields.

Site Code

A user-specified unique identification name used by other DVR software to identify the DVR. (Remote, Emergency Agent, SCS, Digital Signature Verifier)

ADMINISTRATIVE SETUP

ADMINISTRATION - Displays the Log files, Storage Management and User Management.

User Management: Create and configure User accounts. **User Management**

Storage Management: **Disk Management**, **Status Check/Email**

Other Management: **Program Management(ETC)**, **File Information**

System Log

Log Type:

- System Log
- Event Log
- Alarm Log
- Drive Check Log

Export:

- Choose 1-week period to export
- Start Date: 5/13/2008
- End Date: 5/13/2008
- Export log data (Text)**
- Export log data (Raw)**

Pages: Page 1(00001 ~ 01000) * Total log size: 19923.41 KB

NO	Date & Time	Log Contents	Log Value	User
1	5/13/2008 8:54:48...	Current Work drive	D Drive	Default
2	5/13/2008 8:54:59...	Start Site	Ver(3.6.0 [Build : 7]) - Lib(3.516_[5]	Default
3	5/13/2008 8:54:59...	Start Site After Abnormal terminate		Default
4	5/13/2008 8:54:59...	Nero Initialize	7.2.3.3	Default
5	5/13/2008 9:10:55...	Current Work drive	D Drive	Default
6	5/13/2008 9:11:01...	Start Site	Ver(3.6.0 [Build : 7]) - Lib(3.516_[5]	Default
7	5/13/2008 9:11:01...	Start Site After Abnormal terminate		Default
8	5/13/2008 9:11:01...	Nero Initialize	7.2.3.3	Default
9	5/13/2008 9:21:21...	Terminate of Site		Default
10	5/13/2008 9:22:13...	Current Work drive	D Drive	Default
11	5/13/2008 9:22:18...	Start Site	Ver(3.6.0 [Build : 7]) - Lib(3.516_[5]	Default
12	5/13/2008 9:22:18...	Start Site After Normal terminate		Default

Select Date

Log Data Display

Export Log Data (1 to 7 days)

Disk Management

The Disk Management window is a native Windows function. This window displays the partition scheme and health status of the Hard Disk Drives in the DVR. This window is often used to troubleshoot a DVR, or verify the amount of Hard Drive storage installed. For more information about Disk Management, consult a Windows XP manual.

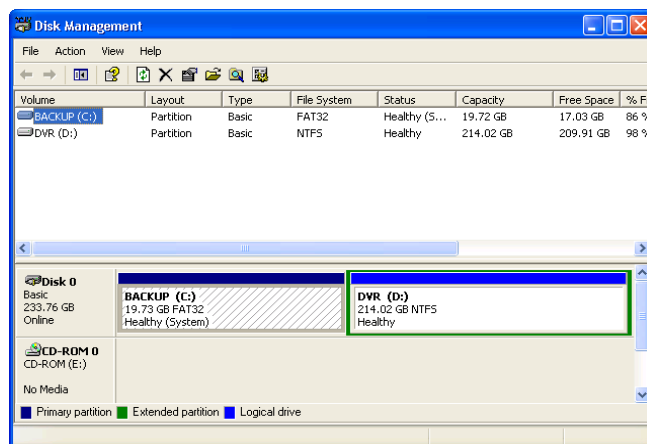

Setting Up DDNS

Dynamic Domain Name System (DDNS) is a service that provides a static address to simplify remote connection to the DVR. This service is most useful for installations where the WAN (public) IP address is dynamic (changes from time to time). Most public IP addresses are dynamic unless a static address has been specifically ordered from the internet service provider.

Enable DDNS

To enable this functionality of the DVR, follow the steps below:

1. Click Setup on the Display screen and log in as Administrator if prompted.
2. Click Administrative.
3. Click Program Management (Etc) and enter the Administrator password when prompted.
4. Click Show to the right of The agent program for DDNS.
5. Select the Enable DDNS check box.
6. Enter the ID, Password, and Hostname specified on the DDNS document shipped with your DVR.

Note Ensure the DVR has an IP address by setting it statically. The Network settings may need to be changed. If you are not sure of the correct values, contact the individual or department responsible for network administration at the site.

Set the IP Address

To set the IP address of the DVR, follow the steps below:

1. On the Display screen, click Exit and choose Restart in Windows Mode.
2. Right-click My Network Places and click Properties.
3. On the General tab, click Internet Protocol (TCP/IP) and then click Properties.
4. Select Use the following IP address.
5. Enter the following values (or as specified by the department responsible for network administration).
 - a. IP Address: The first three sets of numbers should match the router's local IP address and the last set should be a unique number between 1-254.
 - b. Subnet Mask: This should match the router's setting (commonly 255.255.255.0 for 192.X addresses and 255.0.0.0 for 10.X addresses).
 - c. Default Gateway: This is the router's internal IP address. Once DDNS is configured, the router the DVR connects to will need to be configured to forward ports 80 and 4000 to the IP address of the DVR.

For further instruction on this process, visit http://www.portforward.com/english/routers/port_forwarding/routerindex.htm

Select the correct model of router, and follow the instructions. Once DDNS and port forwarding have been configured, the DVR will be accessible from any remote site by entering the HOSTNAME into the address bar of Internet Explorer or the IP Address field in the Remote Software.

User Management

The User Management Console allows the administrator to create, edit, and delete user accounts. Each user account can be assigned different privileges to limit the usage of the DVR system. Users can be given administrator privileges by enabling all rights, however only the true administrator account can log into the User Management Console.

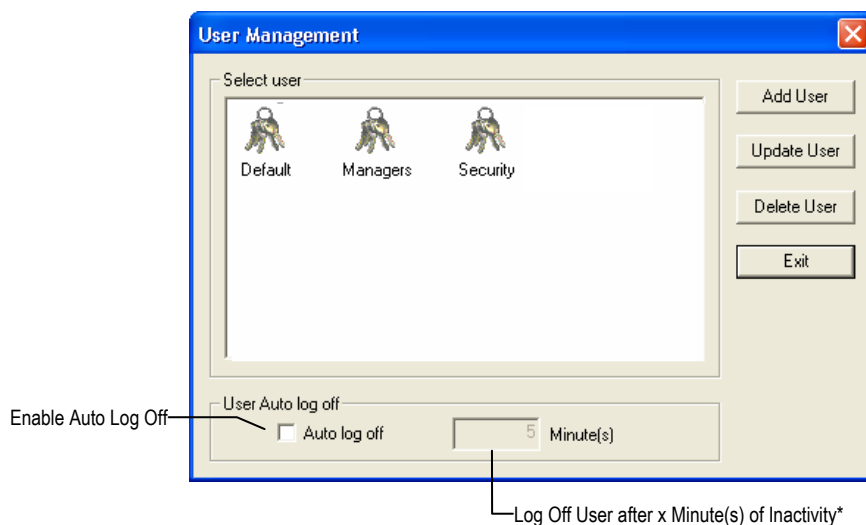

**Auto Log Off affects all users*

Note The Delete User button immediately deletes the user – use cautiously.

Add a New User

1. From the Display screen, click Administrative.
2. Click User Management.
3. Click Add User to open the User window.
4. Enter a User Name and Password.
5. Enable appropriate Permissions.
6. Select Cameras and Audio channels to hide from the user.
7. Assign a User Rank.
8. Click OK to save changes and close the window.

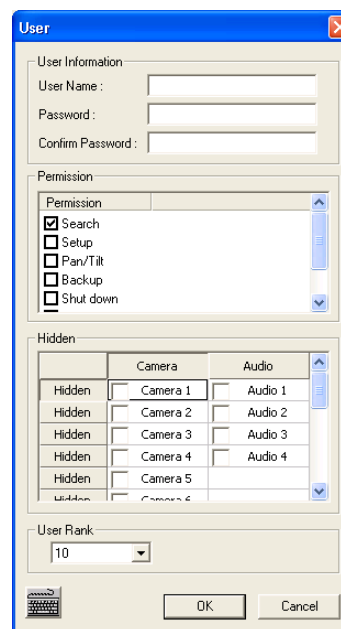

User Rank

The User Ranking structure allows the option to assign a privilege system (1-10 where one has the most rights) to users of the DVR Software. For example. Since only one user is allowed to use the PTZ controls at any one time, an administrator with a higher rank can kick another user out and take control of the PTZ.

The User Rank option affects:

SETUP ACCESS - The DVR Software can only have 1 user accessing Setup at any given time. A user with a higher rank will kick another user out and then open Setup. **NOTE:** User settings will NOT be saved when a user with a higher ranking logs in.

PTZ CONTROL - The DVR SOFTWARE can only have 1 user using the PTZ controls at any given time. A user with a higher rank will kick another user out and then open the PTZ controls.

1. From the Display screen, click Setup.
2. Click Administrative.
3. Click User Management.
4. Enter the Administrator password and click OK.
5. Select a user from the Select User box and click Update User.
6. Set the user's rank using the User Rank list and click OK to save changes.

Changing the Administrator Password

1. Inside Administrative setup, click User Management. When the prompt appears, click Change Password.
2. Enter the new password and click OK.

Default Administrator Password

The default administrator login is:

User: Administrator

Password: <blank>

Log Management

The Log Management window provides the user the options to overwrite log files or schedule log deletion.

Setup Log Management Options

1. From the Administrative setup display click Log Management.
2. Select the check box to enable the Log File Overwrite Option.

Set Log Overwrite

- a. Select Overwrite and define the size of the log file cache.

Set Log Cache Size

- a. Select Do Not Overwrite and define the number of days to maintain log files.

Manually Delete Log Files

- a. Select the type(s) of log file to delete. System Log, Event Log, Alarm Log.
- b. Click Delete All.

3. Click OK to save the settings and close the window.

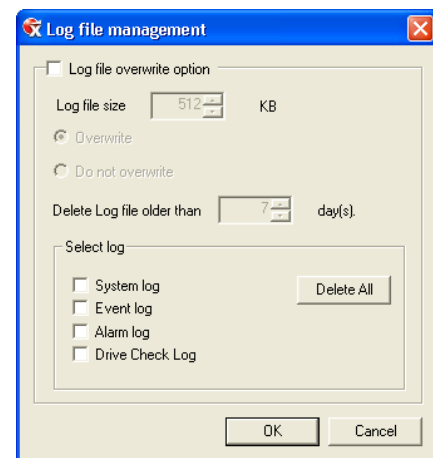

Status Check / Email

General

1. Click Setup on the Display screen.
2. Click Administrative.
3. Click Status Check/Email.
4. Select the Enable Email Alarm check box.
5. Enter a From Name and e-mail Address.

Note This name and address will appear in the From line of the email alert message.

6. Enter the SMTP information for the "From" email account. Contact the email administrator for this information if necessary.
7. If using a secondary email account select the Use Secondary SMTP check box and complete the SMTP information.
8. Click Test to check settings.
9. Click Apply when finished.

The screenshot shows the 'Email Alarm' configuration window with the 'General' tab selected. The window has a title bar with a close button. Below the title bar are four tabs: 'SMART Information', 'SMART Alert', 'Alarm Event', and 'Recording Data Check'. The 'General' tab is active. The main area contains the following elements:

- Enable E-mail Alarm
- Send User section with 'From Name' and 'From Address' text boxes.
- Primary SMTP Setting section with 'Host Address', 'User name', 'Password', and 'Port' (set to 25) text boxes, and a Use Login checkbox and a 'Test' button.
- Use Secondary SMTP section with identical fields to the Primary SMTP Setting section.
- An 'Apply' button at the bottom right.
- A 'Close' button at the bottom center.

Users

1. Set up the General tab first.
2. Click the Users tab.
3. Select the type of Event to send email on.
4. Enter the User Name and E-mail Address of an email recipient.
5. Click Add.
6. Repeat for additional recipients and types of events.

Note A separate email notification for each type of event must be set up for a single recipient to receive notifications for each type of event.

7. Click Apply when finished.

The screenshot shows the 'Email Alarm' configuration window with the 'Users' tab selected. The window has a title bar with a close button. Below the title bar are four tabs: 'SMART Information', 'SMART Alert', 'Alarm Event', and 'Recording Data Check'. The 'Users' tab is active. The main area contains the following elements:

- A table with two columns: 'Name' and 'E-Mail address'.
- An 'Event' section with radio buttons for:
 - HDD Check Alarm Event
 - Recording Data Check
 - Event Alarm
 - SMART Alarm
- A 'Registration User' section with a 'User' text box and an 'E-mail Address' text box.
- 'Add', 'Edit', and 'Delete' buttons below the registration fields.
- An 'Apply' button at the bottom right.
- A 'Close' button at the bottom center.

Storage Check

1. Set up the General and Users tabs first. (see above)
2. Select the Use Storage Check check box.
3. Define the number of minutes.
4. Select an Alert Option, Beep or Popup Message, if desired.
5. Click Apply.

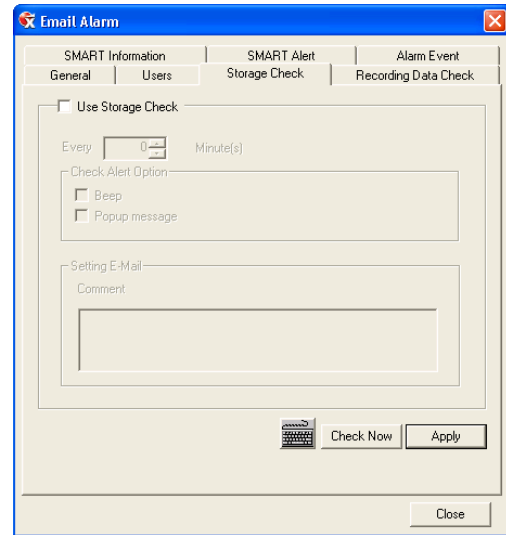

Recording Data Check

1. Setup the General and Users tabs first. (see above)
2. Select the Recording Data Check check box.
3. Define the number of hours between data checks.
4. Select the Action Method.
5. Click Apply.

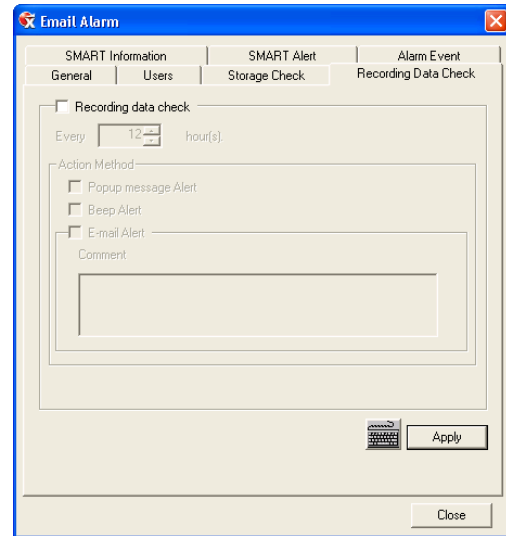

SMART Information

The SMART Information tab displays Hard Drive information.

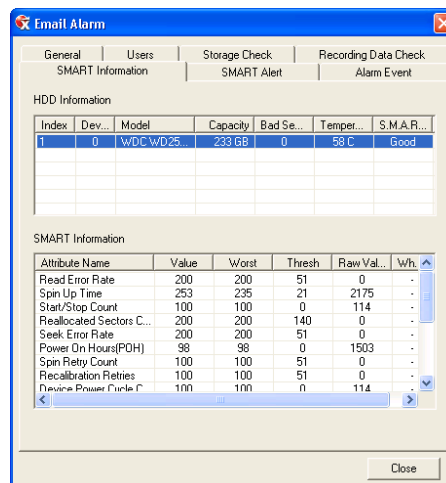

SMART Alert

1. Setup the General and Users tabs first. (see above)
2. Select the Enable SMART Alarm.
3. Define the number hours between SMART checks.
4. Select the type of SMART event to trigger an action.
5. Define the maximum HDD temperature.
6. Select an action method.
7. Click Apply.

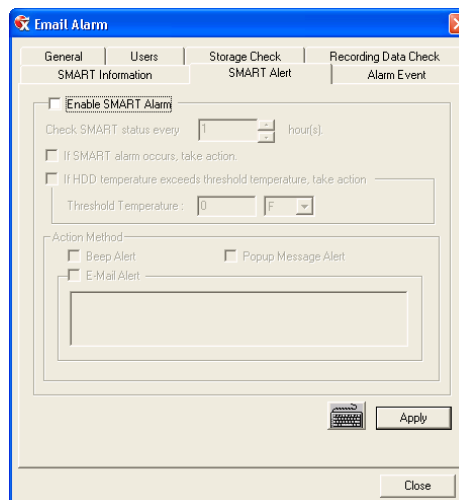

Alarm Event

1. Setup the General and Users tabs first. (see above)
2. Select the Use Email Alarm check box.
3. Define the number of minutes between recording data checks.
4. Select Motion and/or Sensor to send and alert on that type of event.
5. Click Apply.
6. Click Close to return to the Administration tab.

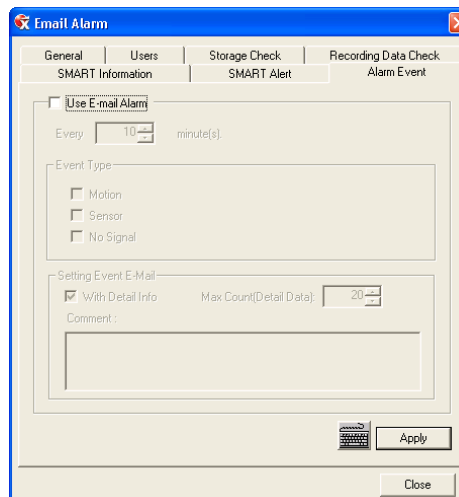

INSTANT RECORDING

The Instant Recording feature allows users to manually initiate recording on a specific camera, overriding the current schedule. When Instant Recording is activated the DVR flags the clip as an event so Instant Recording instances can be found using the Index Search

Instant Recording can be used, for example, when a suspicious object or person is detected and the user wants to flag that section of video for easy retrieval at a later date.

Activate Instant Recording

1. From the Display screen, double right-click the camera on which to enable instant recording. An INSTANT label will be placed on the upper right corner of the video.
2. To turn the Instant Recording option off, double right-click the camera a second time.

Searching 'Instant Recorded' Video

1. From the Display screen click Search.
2. Click Index Search.
3. Select the Instant Recording option. See the Search chapter for more information.

SEARCH

This chapter includes the following information:

- Setup Overview
- Daylight SAVIng Time
- Index Search
- Preview Search
- Graphic Search
- Motion Search

SEARCH OVERVIEW

The DVR has several options that allow the user to easily search through, and find, a particular section of video. From Motion/Sensor indexing to calendar views highlighting days with recorded video; the DVR is equipped to help the user quickly find a specific video or event.

The following chapter describes how to use the DVR Search features.

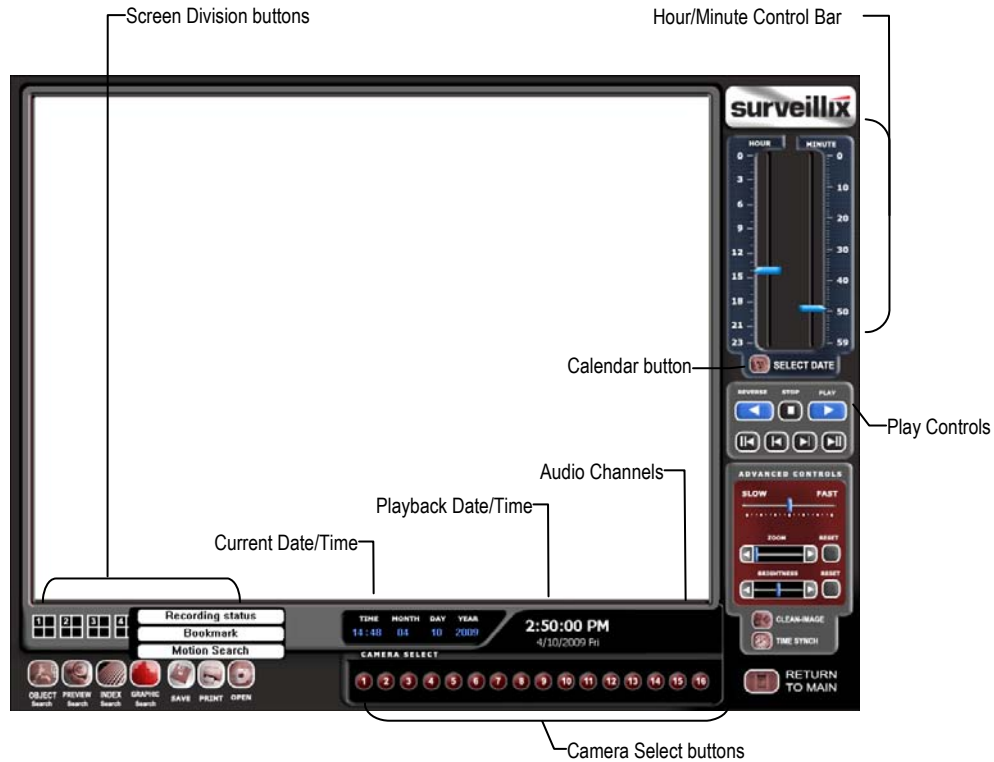

Note Audio Channel buttons are only viewable when one camera is selected.

Play Controls

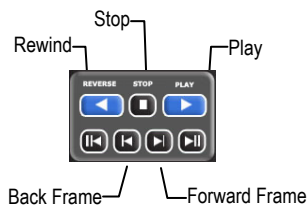

Back Frame	Moves video back one frame
Rewind	Rewinds video
Stop	Stops video playback
Play	Plays video
Forward Frame	Moves video forward one frame

Adjust the Brightness of an Image

1. Select an image to adjust by double-clicking on the desired image. Multiple images cannot be adjusted at one time.
2. Move the Brightness slide bar to the right or left to adjust the brightness.
3. Reset the Brightness by moving the slider back to the center of the bar.

Zooming in on an Image

1. Select an image to adjust by double-clicking on the desired image. Multiple images cannot be adjusted at one time.
2. Move the Zoom slide bar to the right or left to zoom in or out of an image.
3. Reset the Zoom by moving the slider back to its original position on the bar.

Zooming in on a Portion of an Image

1. Right-click the area of interest on the image and select Zoom.
- or - Double-right-click the image.
2. Repeat to zoom in further.
3. Continue clicking the right mouse button and the image zoom will cycle back to the original size.

Open Video from a Saved Location

Previously saved video clips or backup files can be searched for content. Find file by date and time or by name.

1. Click Open to search for the saved file.
2. Select a file from the list of saved clips and backup files or search by start hour.
3. Click OK to open the saved file.

Time Sync

The Time Sync option synchronizes a single channel of video to playback in real time. Ordinarily the video may playback slower or faster depending on several factors, including how many PPS recorded and number of cameras playing at the same time.

1. Select a single image to synchronize by double-clicking on an image.
2. Click Time Sync. The video will now playback in real time.

Clean Image

The DVR is capable of recording video using one of three different resolutions. When using the 720 x 480 resolution, two fields are mixed. Because of the timing gap between the two fields, according to the standardized image rules, after image might occur to high speed moving images. The Surveillix DVR allows the user to remove this by clicking the Clean Image button.

PERFORMING A BASIC SEARCH

There are several different types of searches that can be performed on the DVR. The most basic involves selecting the date, time, camera, and clicking play.

1. Click the Calendar button to select a date.
2. Select a time by clicking the up and down arrows to the right of the time display.
3. Click OK.
4. Select one or more cameras.
5. Click Play. Video can be played forwards, backwards, or frame-by-frame.

PRINTING AN IMAGE

1. Using the Search screen, locate a frame to print.

Note Only one camera can be selected at a time for this function to work.

2. Click Print. A Print Options window appears. Depending on the printer being used, there may be several printing options available. Refer to the printer manual for more information.
3. Click Print to print the selected images.

Note The message "NO DEFAULT PRINTERS INSTALLED" will display if no printer is installed.

DAYLIGHT SAVING TIME

The DVR automatically adjusts for Daylight SAVING Time changes. When the hour "jumps forward" no video is lost because an hour is skipped. However when the hour "falls back" there is a duplicated hour that under normal circumstances would be recorded over. The Surveillix DVR actually records both hours and allows the user to select which hour to play if the need arises.

To access the 'lost hour':

1. From the Search screen, click the Calendar button.
2. Select the date when Daylight SAVING time 'lost' an hour. The Daylight SAVING option appears.
3. To play back the 'lost hour', select the Daylight SAVING check box and enter the repeated hour in the time box.
4. Click OK to confirm the date and begin playing the video using standard search features.

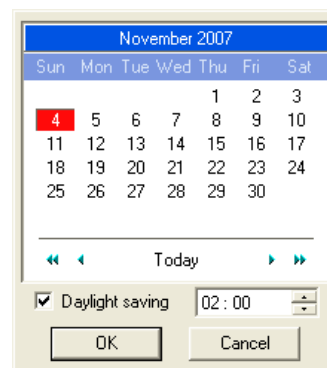

SAVE TO JPG OR AVI

The DVR can export single images in a JPG Image file format and save video clips in an AVI format. Both JPG and AVI file formats are the most commonly used graphical formats today. Virtually every computer offers some type of support for these file formats which make them the most ideal formats to use.

- JPG** Optimized for compressing full-color or grayscale photographic images, JPG images are 24-bit (16.7 million color) graphics. Use JPG to export a single image or frame.
- AVI** AVI image data can be stored uncompressed, but it is typically compressed using a Windows-supplied or third party compression and decompression module called a codec. AVI is used to export a video clip.

1. From the Search screen, click Save.
2. Select the Export Type: Image File (JPG) or AVI File.

Note Different image format types provide different file-sizes, quality and compatibility.

Image File

- a. Select Quality (50>100). When size is not an issue, set the quality to 100.

AVI File

- a. Enter the duration (seconds) to record. Although 100 is the longest time displayed, a longer recording may be entered manually.
- b. Select a Compression Codec. Each codec provides different levels of quality, compatibility and file-size.
- c. Select Quality - 50>100. When size is not an issue, set quality to 100.

3. Click Export to save file. The Cancel button exits the window without exporting file.

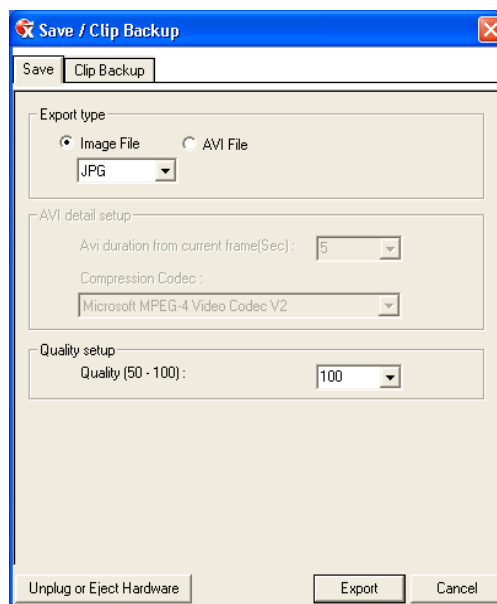

Bookmarks

Use bookmarks to mark a video clip during a search. Export bookmarked data using the Clip Backup feature.

1. Perform a search for the desired video.
2. Stop playback at the beginning of the desired clip.
3. Right-click the video and select **Start Bookmark**.
4. Click the play button to continue playback.
5. Stop playback at the end of the desired clip.
6. Right-click the video at the desired end point and select **End Bookmark**.
7. Type a name to identify the bookmark in the Title box.
8. Enter a memo or notes in the **More Information** box.
9. You may also select additional channels to include video at different locations recorded at the same time.
10. Click Create.

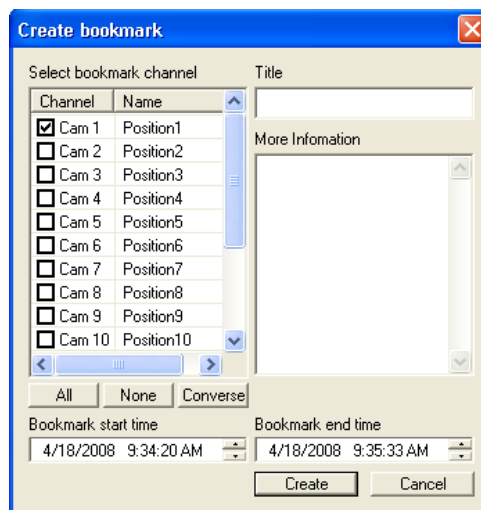

Modify Bookmarks

You can modify a previously created bookmark to change the start or end time of the clip, add additional comments, change the title, or add additional cameras.

1. From the Search screen, click **Graphic Search** and then click **Bookmark**.
2. On the calendar, select the date the desired bookmarks were created.
3. Select the desired bookmark from the list.
4. Make the desired change.
5. Click **Modify**.
6. When the modification is complete, click **Cancel** to close the window.

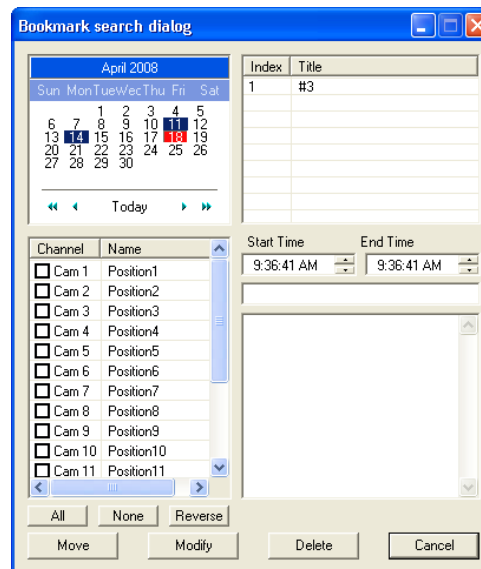

Single Clip Backup

Along with the Save option, a single camera backup option is also included with the Surveillix software. The single Camera or Clip Backup allows the user to backup a single camera without having to backup multiple cameras at a given time. The Clip Backup option gives the users the ability to choose a backup time frame, choose a specific camera, add memos, and even make a copy for the Backup Viewer if needed.

1. From the Search screen, click Save.
2. Select the drive from the file tree to save data to. (Hard disk drive, removable drive (USB), CD/DVD drive)
3. Select cameras from the list.
4. Define the Start and End time of the backup clip.
5. Select the Include Viewer check box to include a copy of the proprietary Backup Viewer Software to view the clip on virtually any Windows machine.
6. Click Add Memo to include additional information.
7. Click Backup to start the backup.

Note If backing up to a removable USB device click the Unplug or Eject Hardware button after backup is complete to safely remove the device.

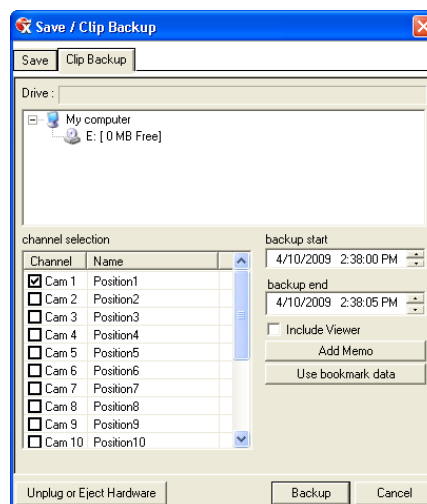

Single Clip Backup Using Bookmark Data

1. From the Search screen, click the Save button.
2. Select the drive from the file tree to save data to. (Hard disk drive, removable drive, CD/DVD drive).
3. Click Use Bookmark Data.
4. On the calendar, select the date the desired bookmarks were created.
5. Select the desired bookmark from the list and click OK.

Note To include multiple bookmarks in a clip backup, select the Multi Backup check box before selecting the desired bookmarks.

6. Select the BV Copy check box to include a copy of the proprietary Backup Viewer software to view the clip on virtually any Windows machine.
7. Click Add Memo to include additional information.
8. Click Backup to start the backup.

Note If backing up to a removable USB device click the Unplug or Eject Hardware button after backup is complete to safely remove the device.

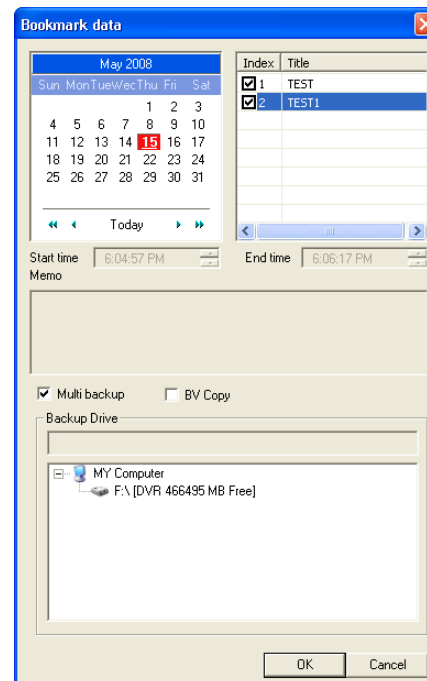

INDEX SEARCH

Using the Index Search can greatly decrease the amount of time spent searching through saved video. The Index Search allows a user to perform a search based on criteria such as Sensor, Motion and Instant Record events

Performing an Index Search

1. Click the Calendar button on the Search screen to select the date to search.
2. Click Index Search.
3. Select the cameras and sensors to include in the search.
4. Select the Select Time check box to define a specific period.
5. Select an event type to search (Sensor, Motion, Instant Record) or select the All Event option.
6. Click OK. There may be a delay while results are returned. Results will be displayed in a column on the left side of the screen – Each line represents a segment of video. If no results are found, "NO IMAGE FOUND" will appear in the column.
7. Once the results are displayed, double-click any one to play the associated video.
8. Once the desired image is found, apply it to the Main Search by clicking the Close button at the bottom of the results column.

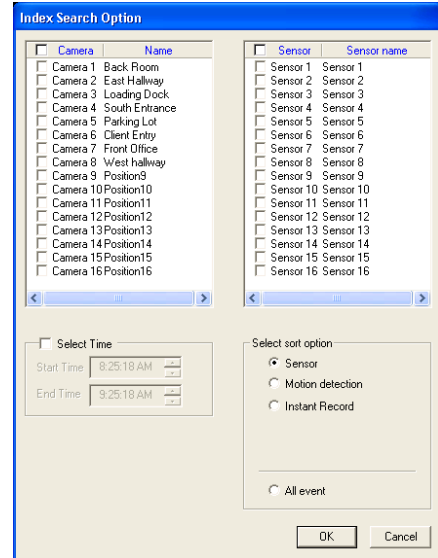

Index Search Results Display

Image Display Area

Event Recorded on Camera #

Time Event Occurred

Event Type:

M – Motion

S – Sensor

I – Instant Record

Time	Camera	Type
08:34:21	C01[Back R	M
08:35:34	C01[Back R	M
08:36:17	C01[Back R	M
08:36:38	C01[Back R	M
08:37:17	C01[Back R	M
08:38:49	C01[Back R	M
08:39:31	C01[Back R	M
08:40:31	C01[Back R	M
08:42:12	C01[Back R	M

PREVIEW SEARCH

Preview Search can be used in a number of circumstances to quickly find an exact moment where an event, such as a theft, occurred. The Preview Search gives a 24 Hour visual overview of a single camera by separating a 24 hour period (1 day) into 24 images, one image for each hour of the day. The search can then be further narrowed down into ten minute increments and one minute increments by selecting one of the images displayed.

These example images show how the Preview Search functions.

The first screen that appears has 24 images displayed. Each image represents the first second of each hour. If there is no image recorded during that period then nothing will be displayed.

When an hour is selected (by double-clicking on the image), a new screen appears with 6 images. Each of these images represents a 10 minute segment of video within the selected hour.

Once a 10 minute segment is selected (by double-clicking on the image) the final screen appears which breaks down that 10 minute segment into 1 minute increments (10 images).

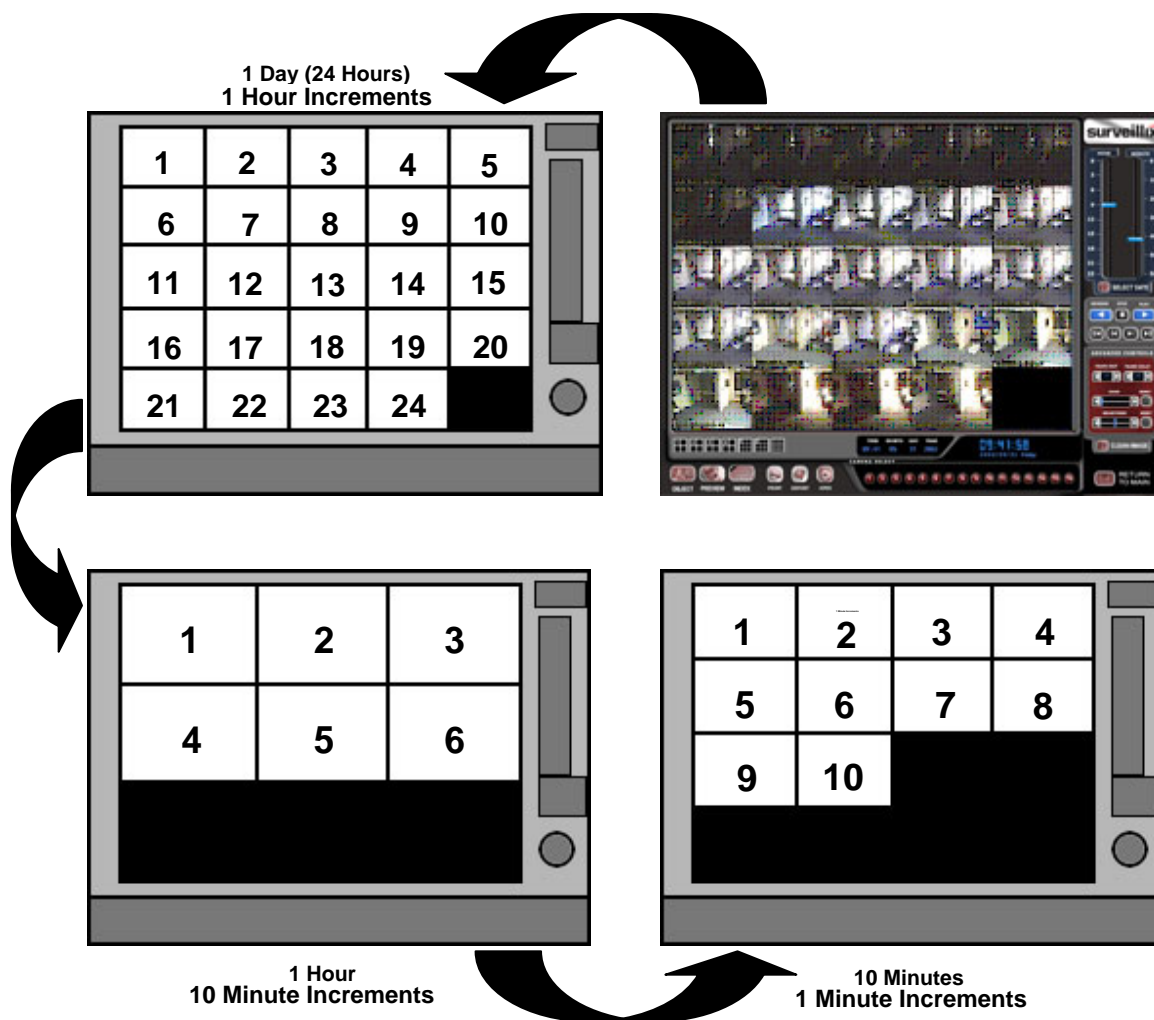

Performing a Preview Search

1. Select a single camera by either turning off all cameras but one or double-clicking a displayed image.
2. Click Preview Search. 24 images display. If there is no recorded video during a portion of the day, "No Image" will be displayed where the image should be.
3. Refine the search by double-clicking on an image to select it. 6 images display. If needed, return to the previous 24-image view by right-clicking on an image.
4. Refine the search by double-clicking on an image to select it. 10 images display. If needed, return to the previous 6-image view by right-clicking on an image.
5. Double-click an image to select the 1-minute segment of video to play. A single image displays. If needed, return to the previous 10-image view by right-clicking on an image.
6. Use the Play controls to play the video of the selected segment.
7. To exit out of the Preview search with the current image still selected, click Preview Search again to clear it.

GRAPHIC SEARCH

The Graphic Search option displays video in graph format.

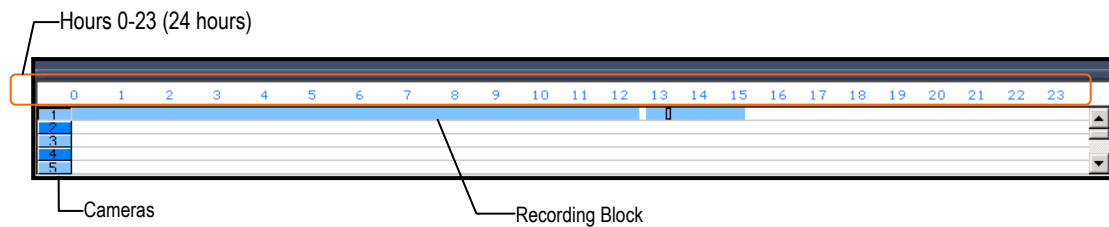

Performing a Graphic Search

1. Click Graphic Search and then click Recording Status on the Search screen.
2. Click the calendar icon to select a day.
3. Click on an area of the blue recording block. Only one camera can be displayed at a time.
4. Recorded video from the corresponding camera and time block will display above.
5. Use the mouse or arrow buttons to move through recording blocks and view video.

OBJECT SEARCH

Object Search is a powerful search utility that is used to search a region on the video for any motion changes. Results are neatly displayed and can be viewed quickly.

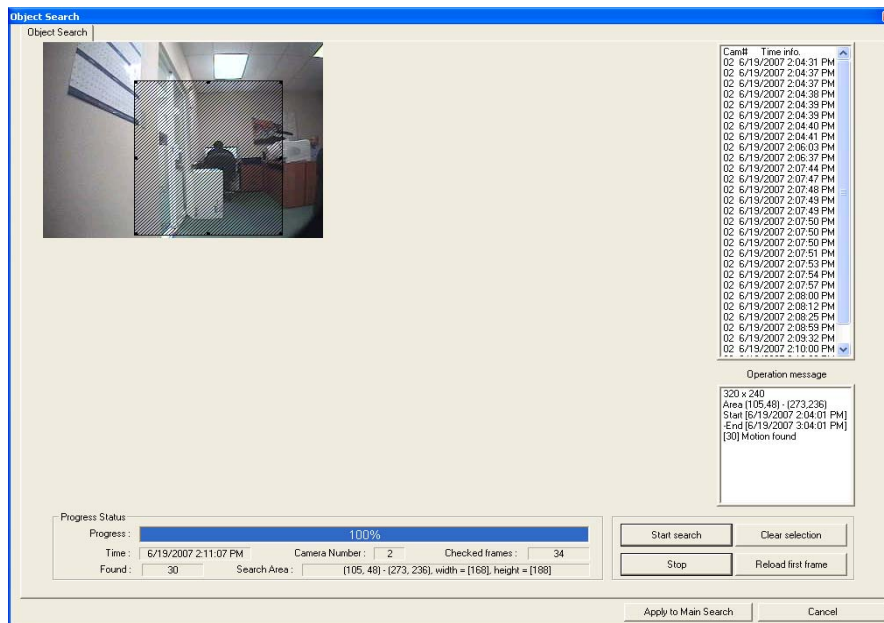

Performing an Object Search

1. Perform a Basic Search. See the instructions on Performing a Basic Search.
2. Select a single camera, either by turning off all cameras but one or by double-clicking a displayed image.
3. Click Object Search on the Search screen.
4. Click and drag the mouse on the video display to define a motion region area. Resize by pulling on the small square boxes located on the outer perimeter of the area.
5. Click Start Search, the Object Search Filter Information window will open
6. Select an End date/time. One hour is the default setting.
7. Adjust the sensitivity if necessary.
8. Click OK.
9. Select a motion event from the search results list displayed on the right
10. Click Apply to Main Search to display the selected image in the main Search screen and to use play controls
11. To start a new object search using the original image, click Reload First Frame.
12. To exit Object Search without selecting an image, click Cancel.

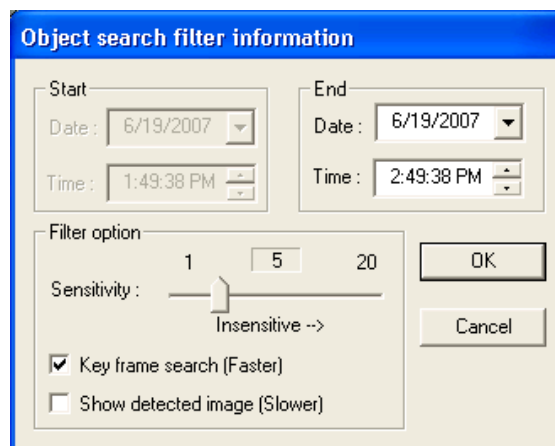

MOTION SEARCH

The Motion Search provides a dynamic display of the levels of motion in recorded video. Adjust the level of motion to only play clips of video at or above that level.

Tip To enable motion data to be saved for Motion search, ensure that you select the following settings:
 On the Motion setup page under Motion Regions, select the Detect Detail Motion Area check box.
 On the General setup page under Display, select the Motion Detect on Continuous Recording check box.

Note Motion Search is only available for newly recorded video; it is not compatible with video recorded prior to version 3.6.

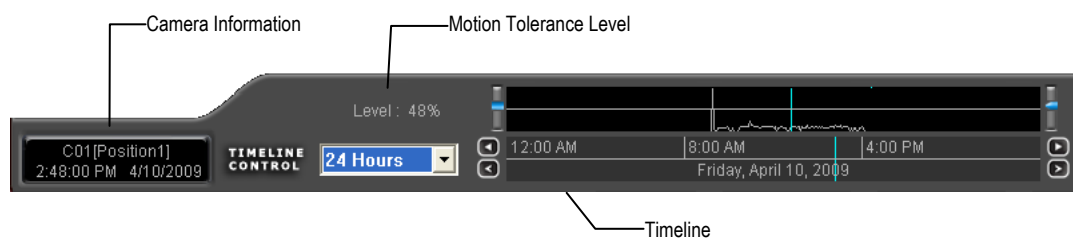

Performing a Motion Search

1. From the Search screen select a camera. Motion Search can only be performed on one camera at a time.
2. Click Graphic Search and then click Motion Search.
3. Click the calendar icon to select a day.
4. Adjust the motion level line.
5. Adjust the timeline display settings.
6. Click the play button to start playback.

Tip You can drag the blue line on the Timeline or motion level box to adjust the time.

AUDIO PLAYBACK

Audio is played back at 48,000Hz.

To play audio with the video:

1. Select a single camera by turning off all cameras but one using the Camera Select buttons. The audio buttons will be displayed.
2. Select a single audio channel to play. When an audio channel is selected, the Time Sync button will be automatically selected.
3. Click Play.

SEARCH IN LIVE

The Search in Live feature allows users to review events immediately while monitoring live video. Pause, rewind, and resume live video within seconds of an alarm event or suspicious activity.

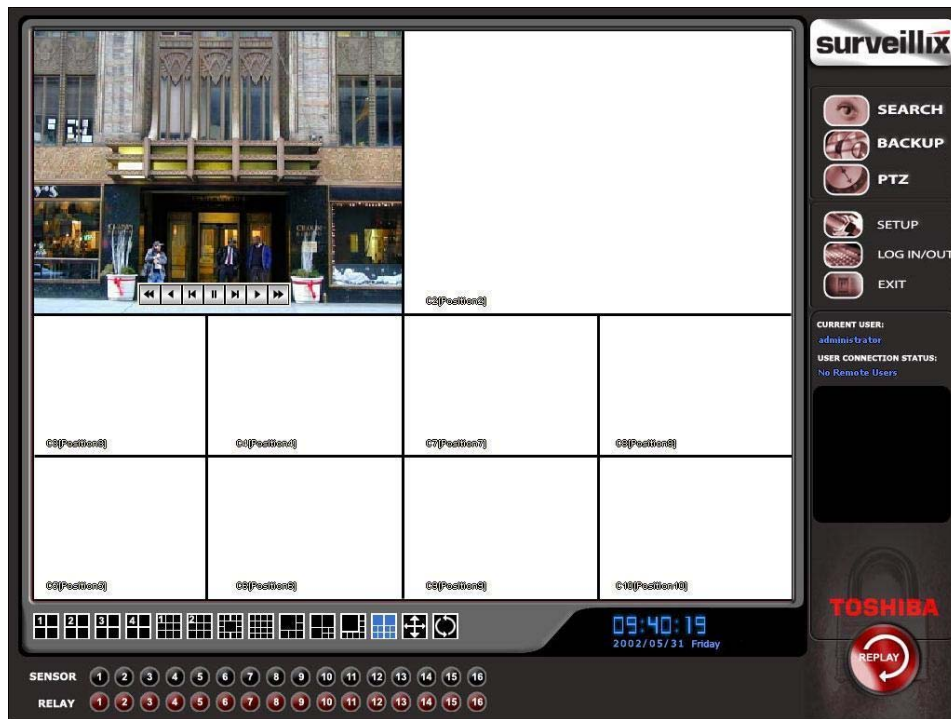

1. Move the mouse cursor over the desired live video display on the Live Display screen.
2. Press the scroll button on the mouse.
3. The search in live Controls will display at the bottom of the image.
4. Use the controls to pause, rewind, move frame-by-frame or resume playing as desired.



NOTES:

PAN / TILT / ZOOM

This chapter includes the following information:

- Overview
- Setting up the PTZ
- Creating and Viewing a Preset Position
- Creating and Viewing a Preset Pattern

PAN / TILT / ZOOM OVERVIEW

The PTZ controls within the DVR allow for powerful control over the cameras. This can be extremely beneficial by increasing the usefulness of the recorded video. Using the PTZ controls you can create custom preset configurations that can continuously sweep across large areas.

SETTING UP A PTZ CAMERA

Setting up a PTZ Camera is simple. The DVR comes preassembled with an internal PTZ adapter. The cabling may be run up to 4,000 ft using 22 Gauge Twisted Pair.

It is important to understand how the PTZ connects to the DVR. The DVR outputs an RS-232 signal and converts it to an RS-485 signal which is then sent to the PTZ camera.

Refer to the Connections section of this manual for information on connecting the PTZ camera to the DVR.

Enable the PTZ Settings

1. Inside the DVR PTZ Setup, select the PTZ camera using the Camera Channel list.
2. Enable the PTZ functions of the camera by selecting the Enable Pan/Tilt check box.
3. Select the appropriate Protocol and set the PTZ Driver Address and Serial Port Settings (See Advanced PTZ Setup in this chapter).

Note The majority of major PTZ manufacture protocols are included in this software. Refer to the Supported Protocols list in this manual.

4. Click Apply and then click Exit.
5. From the Display screen, click PTZ (See the chapter on DVR Basics). The PTZ Controller will open.
6. Select the PTZ camera to control by clicking on its video on the display screen. The camera number will appear inside the PTZ controls.
7. Using the PTZ controls, move the PTZ around.

Supported PTZ Protocols

Protocols are added frequently. The supported list may contain new protocols that are not listed here.

The current supported protocols are:

ADEMCO RAPID DOME	LG (LVC-M300/310)
AMERICAN DYNAMICS	LG MULTIX
BOSCH AUTODOME	LG SPEED DOME
CBC (GANZ)	MERCER
C-BEL	MERIT LI-LIN
CHIPER CPT (V9KR SERIES)	MERIT LI-LIN V6
CLEBO	MIC1-300
CNB-AN102	MOLYNX
CNB-PTZ100	NICECAM
COMPUTAR	NIKO
COVI EVQ-1000	ORX-1000 (KRE-303)
DENNARD RS485	PANASONIC
DMP23-H2	PANASONIC V2
DONG YANG DSC-230/240	PELCO (P PROTOCOL 4800BPS)
DONG YANG SPEEDDOME	PELCO DRD08/DRD14 SERIES
DONG YANG UNITECH (DRX-502A)	PHILIPS (TC8560 & TC700)
DONGYANG (255RXC)	SAE
DVRX-1000	SAMSUNG (DRX-502A)
DYNACOLOR	SAMSUNG (MRX-1000)
ERAEESEEDS (CRX-1401)	SAMSUNG (SCC-641)
ERNITEC	SAMSUNG (SCC-C6407)
EVERFOCUS EPTZ1000	SAMSUNG (SPD-3300P)
FASTRAX II	SANTACHI
FASTRAX IIE	SENSORMATIC SPEEDDOME-AD DELTADOME
FILLTECH (DSC-230/PT-201)	SONY BRC-300
FINE SYSTEM (CRR-1600)	SPD-2500P
FOCVISION (KD1602)	SUNGJIN (SJ2819RX)
GANZ ZC - PT SERIES	SUNGJIN (SJ3000RX)
HONEYWELL (GC-655P)	T TIAT TRX-100
HONEYWELL (HSD-250)	T TIAT TTR-100
HONEYWELL (HSD-251)	TAMRON
HONEYWELL (KDEC-300)	TELEEYE DOME
HONEYWELL HD6	TOA SPEED DOME
HMC-250	TOSHIBA (P PROTOCOL 4800BPS)
HSCP	ULTRAK (KD6)
INTER-M (VSD-640)	VCL
INTER-M(VRX-2101)	VCL- OLD
JAVELIN (ORBITOR)	VICON
JVC TK-C676/C655	VICON SURVEYOR 2000
KALATEL (CYBER DOME)	VIDEOALARM
KDC	VIDEOTREC
KODITEC	VISION TECH
LG (LPT-A100L)	WONWOO
LG (LVC-A70X'S)	WSD-7425D
	YUJIN SYSTEM EPT6000

ADVANCED PTZ SETUP

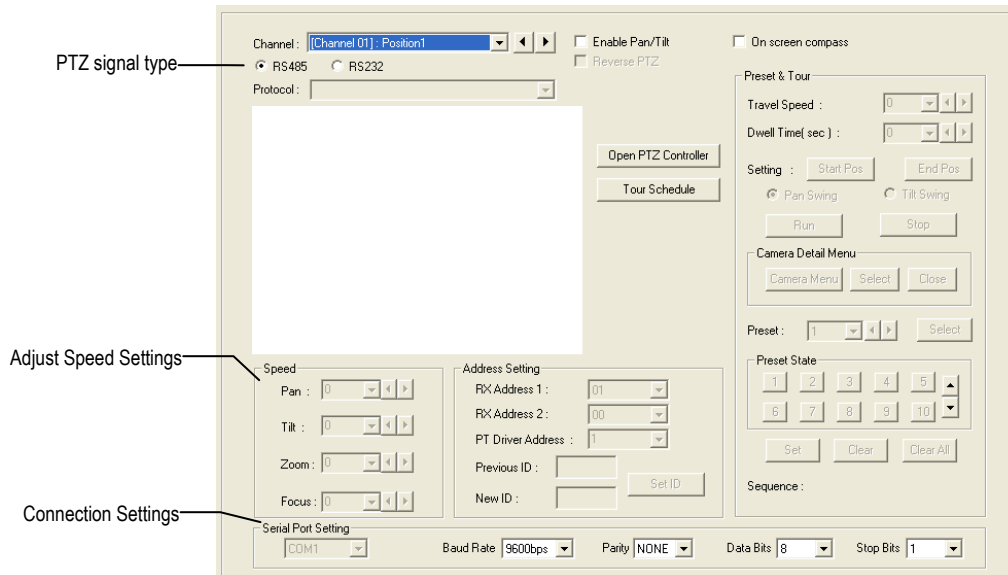

Note Preset and Tour options may vary depending on the camera

Creating and Viewing Preset Positions

A Preset Position is a user-defined location where the camera can be pointed, zoomed in, and focused. Preset positions can be defined and labeled if the camera supports this.

Creating a Preset

1. Inside Setup, click PTZ and select the camera.
2. If the camera is already selected click Open PTZ Controller.
3. Move the selected camera to the desired position using the Pan/Tilt/Zoom/Focus controls.
4. In the Preset & Tour Detail section, choose a Preset # (1-10) using the list or the Right and Left Arrow buttons and click Select.



Note Preset positions can also be created using the advanced buttons on the PTZ graphical controller.

Viewing a Preset

1. From the Display screen select the PTZ camera by clicking on it.
2. Using the keyboard click the number keys corresponding with the Preset Positions. The camera will move to the saved Preset.

PTZ Address Settings

Some protocols support software address settings.

The RX Addresses and ID settings are compatible with a particular line of receivers that support 2 ID addresses.

The PT Driver Address is associated with the PTZ ID address set on the camera. The addresses must match for the DVR to communicate with the proper PTZ camera. This is especially important when a large number of PTZ cameras are connected to the DVR.

Note To select a PT Driver Address of 129-254, manually enter the ID in the box.

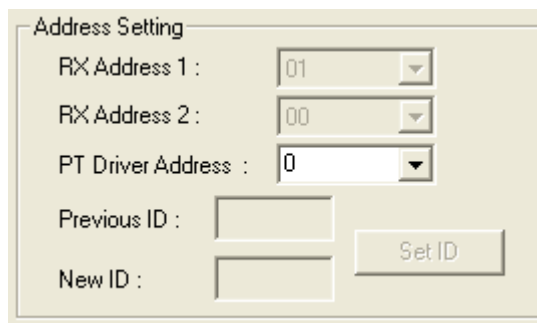

ACCESSING PTZ MENUS

Some protocols support the ability to access the Internal PTZ Onscreen menu.

Since every PTZ camera is different, the functions of these options can vary slightly.

The Surveillix DVR provides an easy way to access the cameras options. For explanations of what those options are please refer to the manual that came with the camera.

Note Use the arrow buttons on the PTZ controller move through the PTZ menu options and/or highlight options.

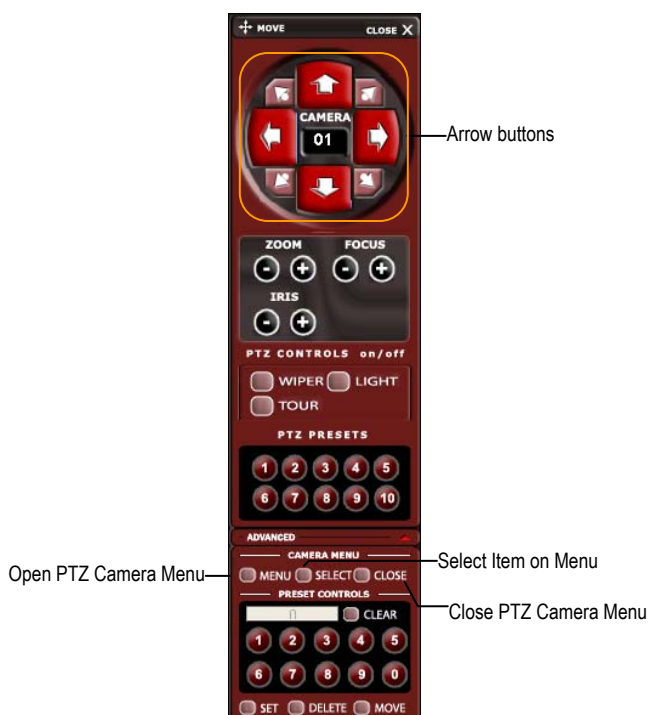

CONTROLLING A PTZ CAMERA

The Surveillix DVRs provide control for a PAN/TILT/ZOOM camera in two different ways.

The first method is to use the Graphical PTZ Controller that appears when the PTZ button is clicked on the Display screen.

The second method is to use the mouse to control the camera directly from the live video display. (On-Screen Compass)

Using the Graphical PTZ Controller

1. Use the Arrow buttons to control the direction of the PTZ camera.
2. To select a new camera, click the video display of a different camera on the Display screen display.

Note Eight directions are available only for select protocols. Only four of the PTZ Control buttons work for all protocols (UP, DOWN, LEFT, RIGHT).

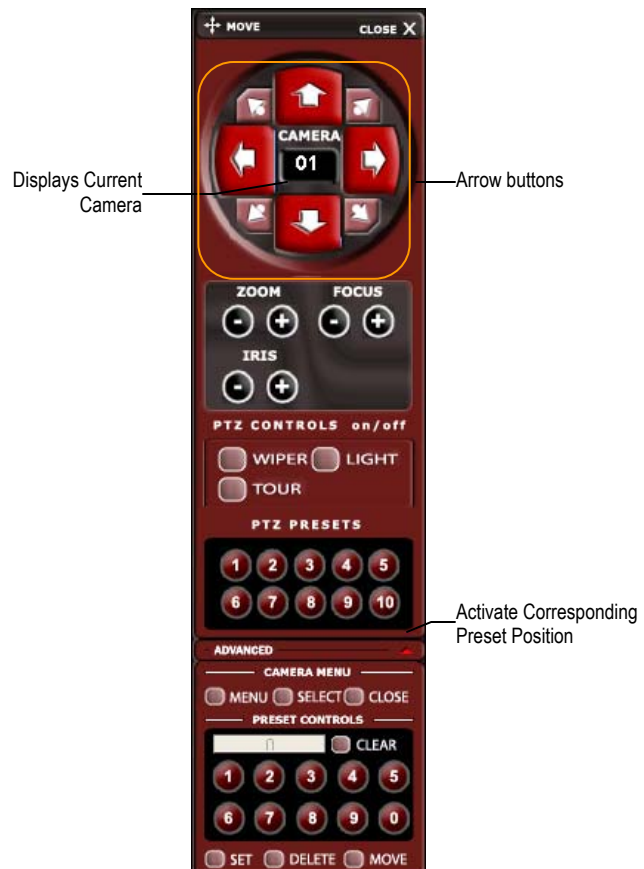

Using the On-Screen Compass

1. Click Setup on the Display screen.
2. Click PTZ.
3. Select the On Screen Compass check box to enable the feature.
4. Click Apply.
5. Click Exit to return to the Display screen.
6. Click PTZ.
7. Control the PTZ by dragging the mouse on the screen in the desired direction.



Note A green line will appear to show the direction the PTZ will move. The shorter the line the less the PTZ will move. The longer the line the more the PTZ will travel in the specified direction.

UNDERSTANDING TOURS

Preset & Tour
 Travel Speed :
 Dwell Time(sec) :
 Setting :
 Pan Swing Tilt Swing

Travel Speed	The speed between one Preset position to the next
Dwell Time	The length of time (in seconds) that a PTZ Tour displays a Preset Position.
Setting: Start Pos / End Pos	Define a Mimic Tour. The Start Position button begins the 'recording' process. The Stop Position button ends it.
Pan Swing / Tilt Swing	This option enables the Horizontal (Pan) or Vertical (Tilt) 'Guard Tours'.
Run / Stop	Runs the selected Pan or Tilt Tour.

PTZ Tour Schedule

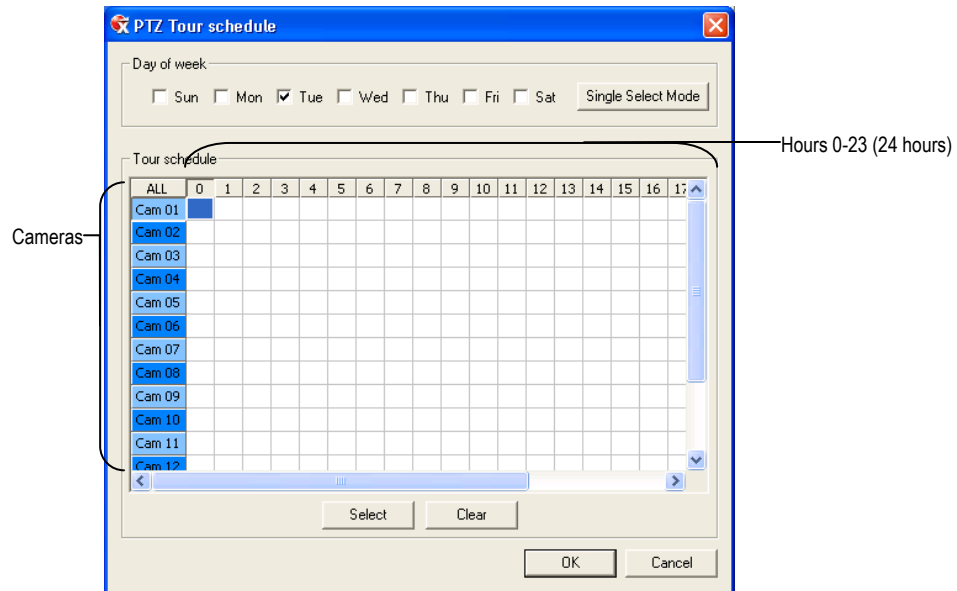

Create PTZ Tour Schedule

1. Click Setup on the Display screen.
2. Click PTZ.
3. Click Tour Schedule to open the PTZ Tour Schedule window.
4. In Single Select Mode select one day of the week to create a schedule for or toggle to Multi Select Mode to select multiple days with the same schedule.
5. Click and drag the mouse cursor to select blocks of time (hours 0-24) and corresponding cameras.
6. Click Select.
7. When finished click OK to save changes and close the window.

BACKING UP VIDEO DATA

This chapter includes the following information:

- Overview
- Saving Video to a DVD
- Saving Video from a Single Camera
- Scheduling Regular Video Backup

BACKUP OVERVIEW

The Backup Center allows you to back up recorded video data from multiple dates and times to one or more locations including the DVD-RW drive, Network Storage Locations, and External Hard Drives.

The DVR can easily backup important video data to an internal or external media location. The most commonly used forms of this are CD-R/RWs, External USB or FireWire Hard Drives, and Network Drives. Every DVR comes equipped with a DVD-RW drive, USB port, and Network Adapter.

The DVR is capable of performing a backup to multiple CD/DVDs when the file sizes exceed the capacity of a single disk. You may also specify multiple locations for backup as well as the order they are recorded to.

The DVR backs up video data using a proprietary compression format that can only be read by the DVR Backup Program. This ensures the integrity of the data.

Throughout the backup process the DVR will continue recording without interruption. This is the result of the tremendous multiplexing power of the DVR, which allows it to perform virtually all functions without disrupting the recording process.

Nero® Express

The DVR uses Windows® XP® Embedded running Nero® Express 7.0 to write data to the DVD-RW Drive. This solution allows the DVR software to read and write data to the DVD-RW Drive without formatting the disk first.



CAUTION: Although many features are available within Nero, it is highly recommended that you do NOT use any features other than those necessary for the standard backup of video data as outlined in this section, loss of information or software instability may result.

General Screen Overview

The General Backup Screen is used for performing bulk backup of video recorded by all cameras for a selected period, or periods, to a specified storage location.

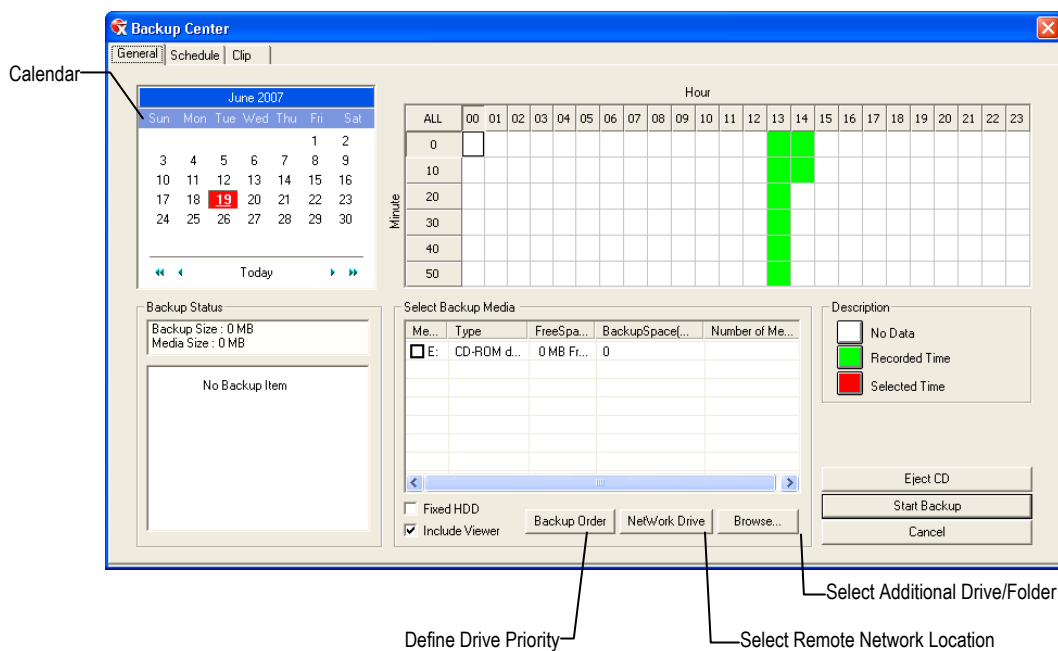

Hour / Minutes	Recording data displays in hourly (24 horizontal columns) and 10-minute (6 vertical cells) segments. Green cells indicate time with recorded video. Red cells indicate time selected for backup.
Backup Status	Displays the size of all video currently selected for backup, the available size of the media currently selected for backup to, and the dates and times of video currently selected for backup.
Fixed HDD	Display all Hard Drives

Performing a General Backup

1. Click Backup on the Display screen.
2. Select the date or dates to back up using the calendar. Dates highlighted in blue contain recorded data.
3. Select the blocks of time to back up using the Hour/Minute grid. Blocks of time with recorded video are highlighted in green. Blocks of time selected for backup are highlighted in red.
4. Select the backup drive or drives under Select Backup Media, or click Network Drive, or Browse. When selecting the CD-RW Drive you must specify the number of CDs to use for backup.
5. Click Backup Order to set the backup order.
6. Select the Include Viewer check box to include the Backup Viewer Application.
7. Click Start Backup to begin the backup process. A progress bar will be displayed in the lower right corner of the Display screen.

Clip Screen Overview

The Clip Screen is used for backing up video recorded by individual cameras for a selected period of time to a specified storage location

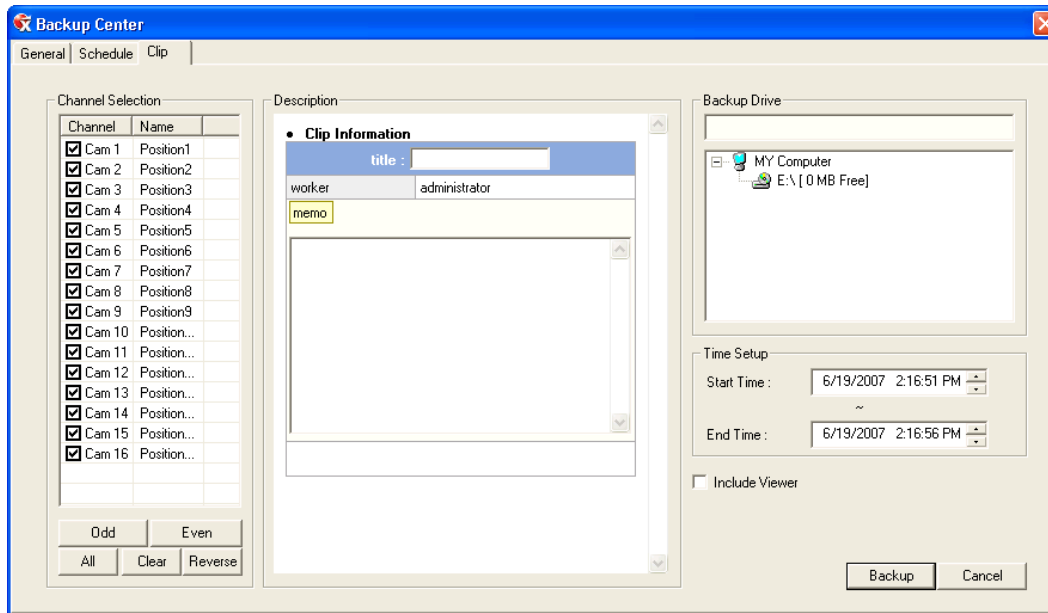

Performing a Clip Backup

1. Click Backup on the Display screen.
2. Click the Clip tab at the top of the Backup Center window.
3. Set the Start Time and End Time under Time Setup.
4. Select the cameras to back up in the Channel Selection box.
5. Select the Backup Drive to save the backup video to.
6. Select the Include Viewer check box to include the Backup Viewer Application.
7. Enter pertinent clip information into the Clip Information section in the Description box.
8. Click Backup to begin the backup process. A progress bar will be displayed in the lower right corner of the Display screen.

Scheduled Screen Overview

The Scheduled Backup Screen is used for performing bulk backup of video recorded by all cameras for a selected period, on a regular scheduled basis (1-24 hours). The Scheduled Backup Screen is similar to the General Backup Screen.

Performing a Scheduled Backup

1. Click Backup on the Display screen.
2. Click the Schedule tab at the top of the Backup Center window.
3. Select the blocks of time to back up using the Hour/Minute Grid. Blocks of time with recorded video are highlighted in green. Blocks of time selected for backup are highlighted in red.
4. Set the Backup Time to perform the backup.
5. Set the Repeat Backup Time to specify the number of hours between backup procedures (between 1 and 24 hours).
6. Select the Backup Drive to save the backup video to using the Select Backup Media menu or the Network Drive button. To save to a local drive or partition you must first rename the location "Backup".
7. Check the Overwrite on Disk Full check box to overwrite previous scheduled backups when the disk becomes full.
8. Click Save Backup Setting to save the current backup setting and return to the Display screen.

Specifying Scheduled Backup Drives

In order to use the Scheduled Backup feature one or more storage drives or partitions connected to the DVR must be labeled as a backup drive.

1. Exit and restart in Windows mode.
2. Double click the My Computer icon on the DVR desktop. A file menu will be displayed.
3. Right click on the drive to specify as a backup drive for Scheduled Backup and click Rename. Rename the drive to 'Backup'. Repeat this process for all drives to use for Scheduled Backup. To remove a drive from use for Scheduled Backup, change its name to something other than 'Backup'.
4. Restart the application and return to the Schedule tab in the Backup Center window.

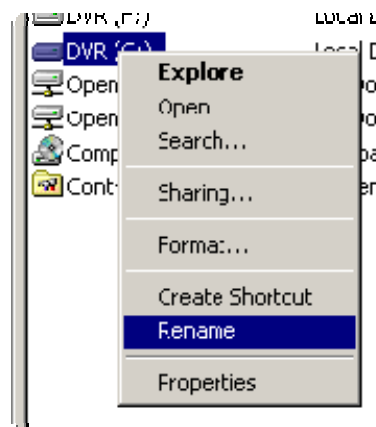

NOTES:

LAN / ISDN / PSTN CONNECTIONS

This chapter includes the following information:

- Overview
- Configuring TCP/IP Settings
- Connecting to a LAN
- LAN / ISDN / PSTN Connections

LAN OVERVIEW

The DVR can be easily connected to a Local Area Network (LAN) and uses Microsoft's® powerful and secure Windows® XP Embedded operating system. This allows for easy and well-documented instructions on setting up LAN connections no matter what type of LAN you want to use.

A LAN is a group of computers and other devices dispersed over a relatively limited area and connected by a communications link that allows one device to interact with any other on the network.

There are many reasons why using Microsoft® Windows® XP Embedded is superior to other platforms when running on a LAN. The number one reason is security. Windows XP Embedded is based on NT technology, which, historically has boasted the most reliable and secure Operating System in the world. Running the DVR on a secure network is important to prevent unwanted users from gaining access to confidential information. Unwanted users can compromise the integrity of the confidential data being stored and viewed, and in extreme circumstances can cause irreparable damage to the network.

Since connecting the DVR to a network can be extremely complex (depending on the network), this Surveillix DVR manual will cover only the basics. It is suggested that the DVR administrator consult the Vendor or IT Administrator before attempting to create or connect to a LAN.

CONNECTING TO A LAN USING TCP/IP

The networking options of the DVR can create and edit all Network settings available on Windows XP Embedded. The DVR comes equipped with a 10/100 Network Interface Card (NIC). This card uses a standard RJ-45 connector.

Configuring TCP/IP Settings

1. On the Display screen, click Exit and select Restart in Windows Mode.
2. Right-click the My Network Places icon located on the desktop and select Properties.
3. Right-click Local Area Connections and select Properties.
4. Select the Internet Protocol (TCP/IP) by clicking on it once. Once it is highlighted, click Properties.
5. Select Use the Following IP Address option. Enter the IP Address and Subnet mask appropriate for the network. It is recommended to contact the Network Administrator for appropriate IP settings.

Example:

- a. Common IP addresses are 10.0.0.25
- b. Common Subnet masks are 255.255.255.0

Note In order to connect to the DVR through a remote LAN connection, a static IP address must be assigned. If the network assigns the IP address automatically (DHCP), contact the Network Administrator for help assigning a static IP address.

6. If the network requires you to specify the DNS information, enter it now by selecting the appropriate DNS options.
7. When finished configuring the TCP/IP settings click OK to close the Internet Protocol (TCP/IP) Properties window.
8. Click OK to close the Local Area Connection Properties window.
9. It may be required to restart Windows for the changes to take effect. Restart windows by clicking START on the desktop and clicking Restart.

WEB VIEWER

This chapter includes the following information:

- Overview
- Configuring the Web Viewer

WEB VIEWER OVERVIEW

The DVR allows you to access video using Microsoft® Internet Explorer® 7.

Highlights:

View Live Video from most computers

Username and Password protected

Easy to use graphical interface

Basics:

75 users can access the Web DVR simultaneously. The Web Viewer is an easy, secure way to view live video from virtually any computer with an internet connection using Microsoft Internet Explorer.

In order to log in to the DVR server, a user account must be made for the user. This ensures that only authorized personnel are allowed to log in. In addition, each user can be assigned different privileges that allow them or deny them access to different functions. For example, a user can be granted access to only view cameras 4, 8 and 16.

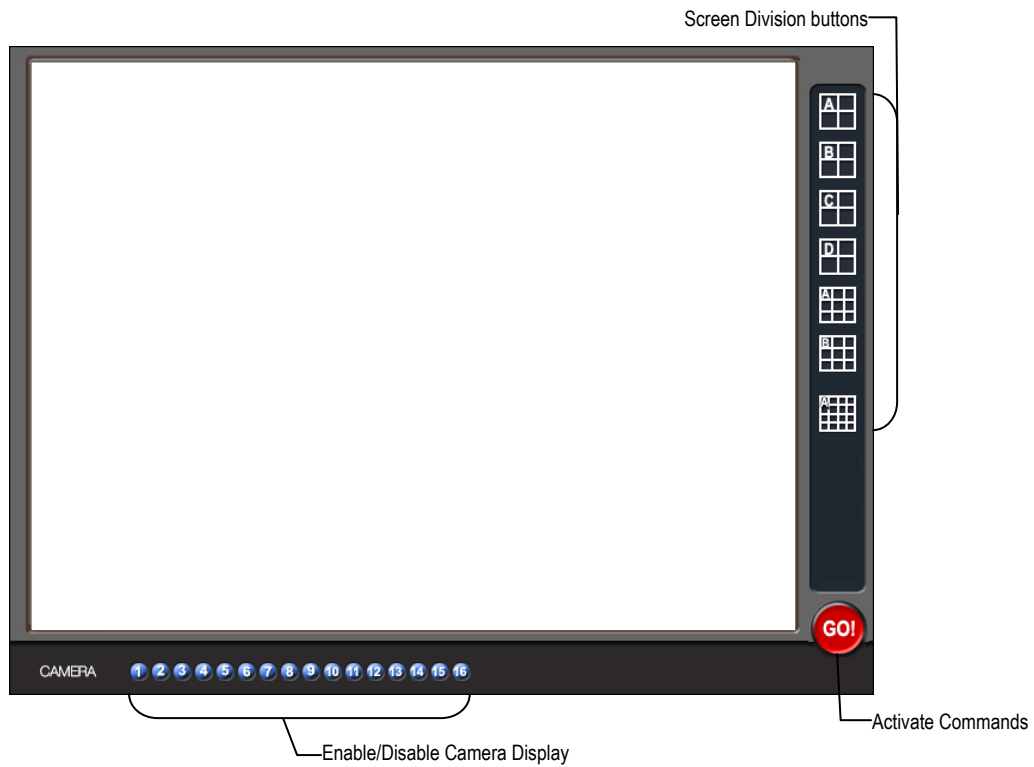

Configuring the Server for Remote Connection

1. Click Setup on the main display screen.
2. Click Network.
3. Clear the Disable Remote Control check box. You should now be allowed to adjust port settings if necessary.

NOTE: If you are using a Firewall, it may be necessary to adjust the port settings on both the DVR and the Firewall. Contact the Network Administrator for more information.

4. Select the Web Viewer (iDVR) check box.
5. Click Apply.
6. Make sure a User account is created. Without a user account, the Administrator account must be used.
7. The DVR server is now ready to receive incoming connections.

Connecting to a DVR Using Web Viewer

1. Open Microsoft Internet Explorer.
2. Enter the IP address of the DVR into the Address Bar.
3. When attempting this for the first time on a computer a window will open and you will be asked to accept an Active X installation. Select Yes to this.

NOTE: If you receive a message saying Internet Explorer® security settings do not allow you to download Active X components then you will need to adjust the browser security settings. One way to do this is to add the IP address of the DVR to the trusted sites list inside Internet Explorer® settings. Contact the System administrator for additional help with adjusting Internet Explorer® settings.

4. When the Web Viewer finishes loading, select one or more cameras (or select a screen division button).
5. Click GO!
6. A login window will appear. Enter the Username and Password of an authorized user.
7. The cameras will display.

Closing the Web Viewer

To exit the Web Viewer close Internet Explorer.

INCLUDED SOFTWARE SETUP

This chapter includes the following information:

- Emergency Agent Overview
- Remote Software Overview
- Digital Verifier
- Backup Viewer
- SCS Multi Site Software Overview

EMERGENCY AGENT OVERVIEW

The Emergency Agent software is a utility that streams video across a Local Area Network to a Client PC when an alarm is detected on the DVR. The video that streams across can be stopped, played forwards and backwards, in slow motion or real speed.

The utility is loaded at startup and placed in the taskbar. It constantly monitors for a signal from the DVR. When an alarm signal is detected the Emergency Agent Image Viewer window opens and starts playing the video from the camera associated to the alarm.

Configuring the DVR

To enable the Emergency Agent on the DVR follow these steps:

1. Enter Setup and confirm you are in the Camera Setup menu.
2. Select a camera and then associate sensor(s) to that camera using the Sensor Connection check boxes.
3. Click the Network Setup button and make sure that Disable Remote Control is cleared.

Note The Emergency Agent uses one port to transfer the data through (the Emergency Port). The port can be adjusted inside the Network Setting menu if necessary. It is recommended that the default setting should be used unless the port must be changed.

4. Click the Schedule Setup button. Enter the IP Address of the computer running the Emergency agent software.
5. Click the box next to the IP Address to enable it.
6. Select the Sensor radio button.
7. Create a schedule for the appropriate sensor
8. Click Apply.

IP	Use	IP
IP 1	<input checked="" type="checkbox"/>	0.0.0.0

Configuring the Client PC

All configurations take place in the Emergency Agent window on the Client PC for descriptions and locations of the buttons and features of the Emergency Agent window refer to the Emergency Agent window section later in this chapter.

1. Open the Emergency Agent window on the Client PC - Start > All Programs > Surveillix > Emergency Agent > Emergency Agent
2. Right Click in the DVR list and select New. Enter the DVR Code, DVR Name, and IP Address of the DVR to connect to in the Site Edit window that opens. Click OK
3. Click the Options menu and select Setup.
4. Confirm that the Network Port in the Setup window is set to the same number as the Emergency Port in Network Settings on the DVR. If the numbers are different adjust the Network Port on the client PC to match the DVR.
5. Click the OK button
6. Restart the Client PC

Setup Window

Network Port	Indicates the port which the Emergency Agent uses to listen for incoming events. This number should be changed to the same number as is set in the Emergency Port in Network Settings on the DVR.
Save Directory	Sets the location that recorded video footage is saved to.
Notice Options	Configuration settings for activating an audible indicator or popup window when the Emergency Agent receives an event.

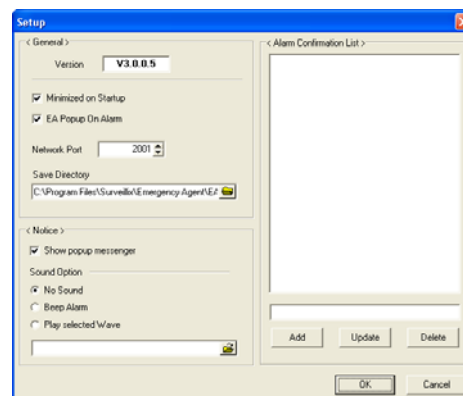

EMERGENCY AGENT WINDOW

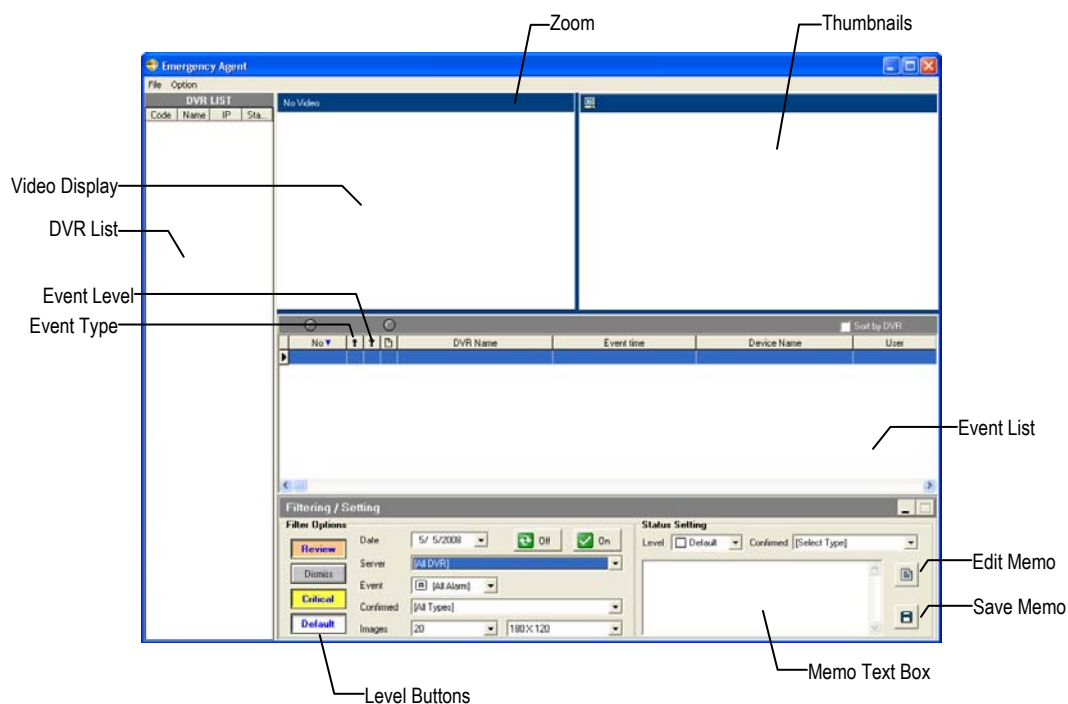

Filter Event List

1. Select a DVR from the DVR List in the Filter Options section.
2. Select the Date to include.
3. Select the type of Events to include.
4. Select the event levels (Review, Dismiss, Critical, Default).
5. Click the On button to display filtered event listings.

Add Items to Alarm Confirm List

1. From the Option menu, click Setup.
2. Type the desired text in the box below the Alarm Confirmation List.

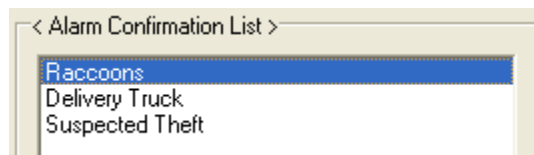

NOTE: The items in the Alarm Confirmation List will be available on a list under Status Setting in main Emergency Agent screen.

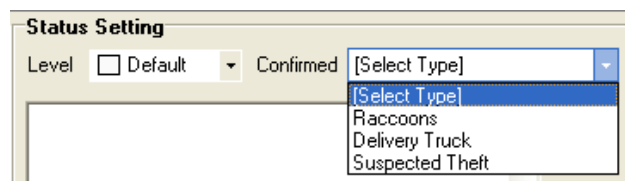

3. Click Add.
4. Click OK to save changes and close the window.

SEARCH ALARM WINDOW

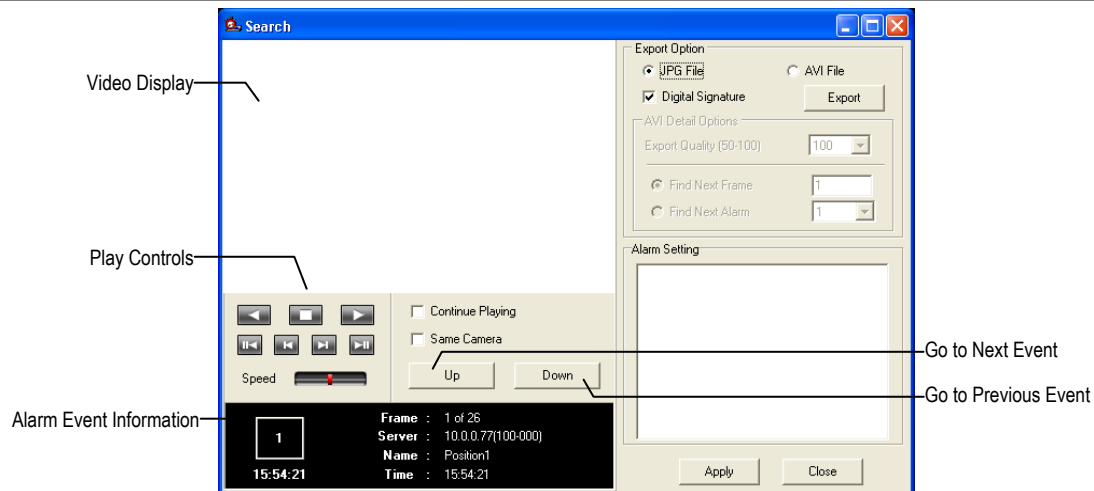

Export Quality

It may be necessary to reduce the overall size of an AVI file; for example, to email to someone. AVI file sizes can be reduced by reducing the image quality. However, reducing the image quality causes the AVI video to appear more pixelated. When size is not an issue, setting quality to 100 is highly recommended.

Digital Signature

Adds a digital signature to the exported JPG image for use with the Digital Signature Verifier to verify integrity of exported images and prevent tampering.

View Recorded Video

1. Double-click an event listing to open the Search Alarm window.
2. Use the play controls to locate the desired video.
3. Select the Continue Playing check box to watch all recorded events. When cleared, playback stops at the end of the alarm event.
4. Select the Same Camera check box to watch all events recorded by a single camera.
5. Click Apply after making any changes.

Export Video

1. Double-click an event listing to open the Search Alarm window.
2. Use the play controls to locate the desired video.
3. Click the Rewind button to return to the beginning or desired spot in the video.
4. Click the Stop button.
5. Select the Export Option – JPG or AVI.

Save JPG:

- a. Select the Digital Signature check box to embed a digital signature in a JPG file.
- b. Click the Export button.

Save AVI

- a. Reduce Export Quality only if necessary to reduce the size of the file.
- b. Click the Export button.

REMOTE SOFTWARE OVERVIEW

The DVR was specifically designed to be fully operated and maintained remotely. It connects using the standard TCP/IP protocol through connection types such as DSL, Cable Mode, T1, ISDN, 56K Modem, LAN, and more. The Surveillix Remote software allows you to view live video, search through archived video, export images and video clips and have virtually full Setup control. Surveillix Remote Software is Microsoft Vista® compatible.

Highlights:

Search archived video

View live video

Export images and video clips

Control relay outputs

Setup administration

Basics:

The DVR can have up to 5 simultaneous remote connections. Each user can perform functions on the DVR and will not affect the other users. The only exceptions to this are accessing Setup and controlling a PTZ camera. Only one user is allowed to access setup or control a PTZ camera at any given time. The pictures per second passed to the Remote Client vary greatly depending on the connection type and speed.

In order to log in to the DVR server, a user account must be made for the user. This ensures that only authorized personnel are allowed to log in. In addition, each user can be assigned different privileges that allow them or deny them access to different functions. For example, a user can be denied Searching and Setup privileges and only granted access to view cameras 4, 8 and 16.



It is highly recommended that users not be granted Setup privileges since this can pose a security risk. Only properly authorized Administrators should have access to Setup.

The Remote software operates virtually the same way as the DVR itself. The appearance of it matches the DVR almost identically; however, there are a few minor differences. Some search features are not available (such as the Index and Object Searches) as well as some Setup options.

Remote Software Setup

Installing Remote Software

1. On the client computer, insert the Surveillix Software CD into the CD-ROM. The CD should play automatically.
2. When prompted, select the Install Remote Software option. Follow the installation instructions carefully.
3. When the software finishes installing, close any open installation windows.

Create a New Remote Connection

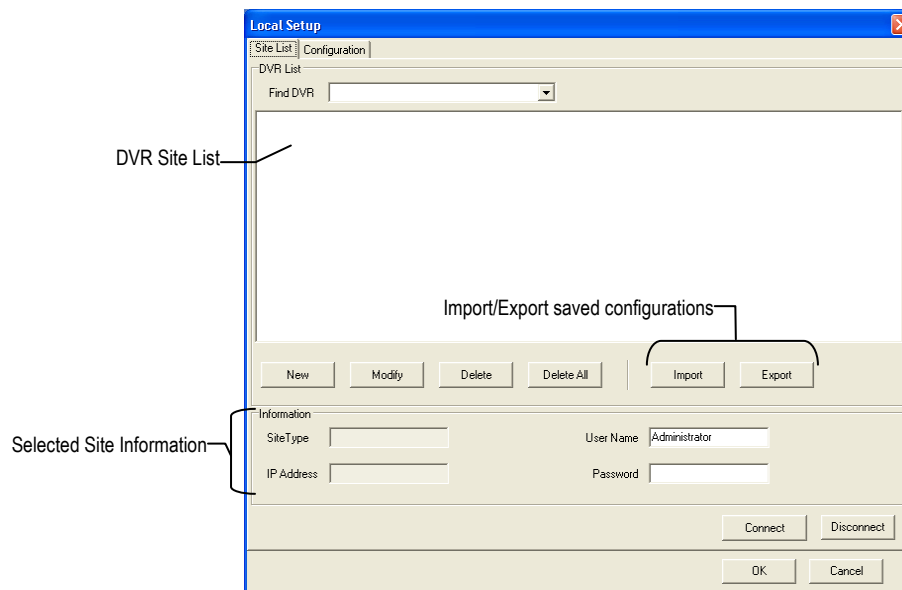

1. Select Start > Programs > Surveillix > Remote > Surveillix Remote Center. The Surveillix Remote Software opens and the Local Connection window opens.
2. Click New to open the Site Info window.
3. Select the Site Type and enter a Site Name. The Site Name will be the name displayed inside the connection box to help identify the unit.
4. Enter the IP Address of the DVR server. By default the DVR is set to connect using DHCP.
5. Enter the Center Port. This setting is specified on the server.
6. Click OK.
7. Click on the newly created connection and enter the login username and password. (case sensitive)
8. Click Connect.

Configuring the DVR

In order to access the DVR remotely, the DVR Server must be setup to allow remote connections.

Time Out Value	Specifies a value (in seconds) to wait for a signal from the Surveillix Remote Client. If a signal is not received by that time, the connection is dropped.
Center Port	Used to transfer the connection data.
Image Port	Used to transfer the image data.
Search Port	Used to transfer the search data.

Disable Remote Control

Transport Setup
 Quality :
 Resolution :

Network Setup
 TimeOut Value :
 Emergency Port :
(1024 - 5000)
 Center Port :
(1024 - 5000)
 Image Port :
(1024 - 5000)
 Search Port :
(1024 - 5000)

Configuring the Server for Remote Connection

1. Enter Setup on the DVR.
2. Click Network to open the Network menu.
3. Clear the Disable Remote Control check box. You should now be allowed to adjust port settings if necessary.

Note If you are using a Firewall, it may be necessary to adjust the port settings on both the DVR and the Firewall. Contact the Network Administrator for more information.

4. Click OK.
5. Make sure a user account is created (See Creating a New User in the Setup Section). Without a user account, the Administrator account must be used.
6. The DVR server is now ready to receive incoming connections.

DIGITAL VERIFIER OVERVIEW

JPG images and AVI video files that are exported from the Digital Video Recorder are automatically embedded with a digital signature. Digital Signatures are a way to verify the authenticity of the images to ensure that they have not been tampered with or edited in any way. Included on the Software Installation DVD supplied with the DVR is the Digital Signature Verification program. This program can be installed on any computer and loads an image in question.

Installing the Digital Verifier

1. Insert the Software Installation CD into the CD-ROM. (Do not install on the DVR.)
2. Select the Digital Verifier option to begin installation.
3. When the Welcome screen appears, click Next.
4. When the Setup Complete window appears click Finish. Installation is complete.

Using the Digital Verifier

1. Open the Digital Verification program by selecting Start > Programs > Surveillix > Digital Verifier > Digital Signature Verifier.
2. Click the Browse button to load the JPG image.
3. Enter the Site Code of the DVR that the image was originally extracted from. (The Site Code is specified in the Information Setup menu)
4. Click Verify to continue or Close to close the window without verifying.

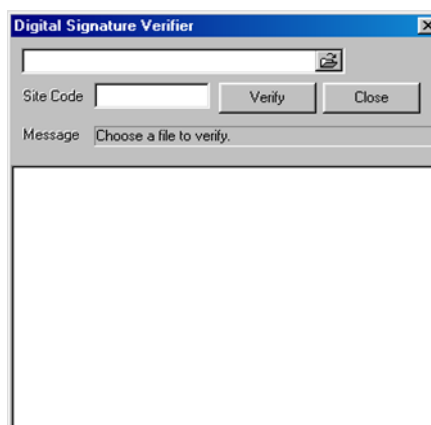

If the image has not been tampered with, a blue square will appear around the image with the message "Original image file."

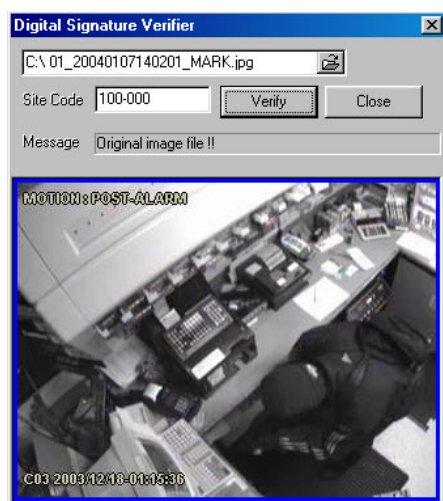

If the image has been tampered with, a red square will appear around the image with the message "Entire image changed or wrong SITE CODE."



BACKUP VIEWER OVERVIEW

The Backup Viewer allows you to play back the exported video in its proprietary format. Video saved in this format is extremely difficult to tamper with and therefore is the ideal solution when law enforcement and the legal department are involved.

This video cannot be read by any other viewer.

The Backup Viewer operates essentially like the Search portion of the DVR software.

For detailed explanations of these functions, refer to the chapter on Search Options in this manual.

Installing Backup Viewer

1. Insert the Software Installation DVD into the DVD-ROM.
(Do not install on the DVR.)
2. Select the **Backup Viewer** option to begin installation.
When the **Welcome** screen opens, click **Next**.
3. Read the License Agreement and select the appropriate radio button to accept the terms of the license agreement.
Click **Next**.
4. Select **Yes** to install the POS component or select **No** for a basic install.
Click **Next**.

Note The POS component is only necessary when connecting to a server running the POS Upgrade.

5. When the **Choose Destination Location** window opens click **Next**.
This will install Backup Viewer in the default destination folder.
6. Select the shortcuts to install, or clear all boxes for no shortcuts.
Click **Next**.
7. When the **InstallShield Wizard Complete** window appears click **Finish**.
Setup is now complete.

Loading Video from DVD or Hard Drive

1. Open the Backup Viewer program: **Start > Programs > Surveillix > Backup Viewer > Backup Viewer**.
2. Click **Open**. The **Total Backup Search** window will open.
 - a. For DVD-ROM data, select the appropriate DVD-ROM drive letter from the **Backup Media** box.
 - b. For hard drive data, select either an attached hard drive from the **Backup Media** box or select the **Open Folder** icon to browse to a specific directory.

Note Once selected, available video data will be displayed in the **Choose Start Hour** box.

3. Click on the desired time to select it.
4. Click **OK**. The video will now load into the Backup Viewer.

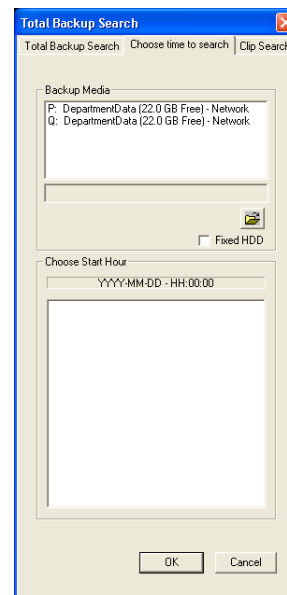

SCS OVERVIEW

SCS software is Network DVR Management Software; a powerful utility that allows 100 or more DVRs to be controlled using one computer. This software allows you to view live video, search saved video, edit and configure setup on each DVR, and import maps of buildings and other locations.

The SCS software was specifically designed as an Enterprise software solution.

Highlights:

View Live Video from most computers

Username and Password protected

Easy to use graphical interface

Basics:

In order to log in to the DVR server, a user account must be made for each user. This ensures that only authorized personnel are allowed to log in. In addition, each user can be assigned different privileges that allow them or deny them access to different functions.

Configuring the Server for Remote Connection

1. Enter Setup on the DVR.
2. Click Network.
3. Clear the Disable Remote Control check box. You should now be allowed to adjust port settings if necessary.

Note If you are using a Firewall, it may be necessary to adjust the port settings on both the DVR and the Firewall. Contact the Network Administrator for more information.

4. Click OK.
5. Make sure a User account is created. Without a user account, the Administrator account must be used.
6. The DVR server is now ready to receive incoming connections.

Connecting to a DVR

Refer to the Setup section of the SCS Manual for information on using the SCS Software. The SCS Manual can be found on the Surveillix Software CD.

NOTES:

APPENDIX: SPECIFICATIONS

XVS SPECIFICATIONS

		4 (120 PPS)	16 (240V PPS)	16 (240 PPS)
CPU		Intel® CPU		
Storage (Hard Drive)		500 GB Standard / 2 TB Maximum		
Storage MAX		Up to 2 HDD with DVD±RW		
RAM		1 GB		
Operating System		Microsoft® Windows® XP Embedded		
Viewing Rate	NTSC	120 PPS	240 PPS	480 PPS
	PAL	100 PPS	200 PPS	400 PPS
Digital Control Output		4	4	4
Sensor Input		4	16	16
Resolution / Recording Rate	NTSC	120 PPS 360x240 120 PPS 720x240 60 PPS 720x480	240 PPS 360x240 120 PPS 720x240 60 PPS 720x480	240 PPS 360x240 120 PPS 720x240 60 PPS 720x480
	PAL	100 PPS 360x288 120 PPS 720x288 50 PPS 720x576	200 PPS 360x288 100 PPS 720x288 50 PPS 720x576	200 PPS 360x288 100 PPS 720x288 50 PPS 720x576
Image Compression		MJPEG		
Average File Size		360x240 – 3~5k		
		720x240 – 4~8k		
		720x480 – 7~12k		
Video Inputs		4 (BNC)	16CH (BNC)	16CH (BNC)
Looping Outputs		0	16CH (BNC) – Each can be terminated (75Ω)	16CH (BNC) – Each can be terminated (75Ω)
Composite Outputs		RCA x1		
Video Outputs		SVGA x1, DVI-D x1		
Max PPS Per Channel		30 Pictures Per Second (PPS) – NTSC / 25 Pictures Per Second (PPS) - PAL		
Motion Detection		Up to 15 Regions Per Channel / Adjustable Sensitivity		
Remote Operation		Full Remote Control Through PSTN, ISDN, ADSL, LAN, and TCP/IP		
Remote Software		Compatible with Microsoft Windows XP, Vista		
PAN / TILT / ZOOM		Built In RS-485 Interface		
Recording Mode		Continuous, Motion Detection, Sensor, Scheduled Recording		
Backup		USB, DVD±RW		
Digital Signature		Supports Digital Signature Verification		
Emergency Agent		Transmitted through TCP/IP – SCS		

DVS/HVS SPECIFICATIONS

		8	16	32
CPU		Intel® CPU		
Storage (Hard Drive)		500 GB Standard / Virtually Unlimited Storage Potential		
Storage MAX		Up to 4 HDD with DVD±RW		
RAM		1 GB		
Operating System		Microsoft® Windows® XP Embedded		
Viewing Rate	NTSC	Max 480 FPS		
	PAL	Max 480 FPS		
Recording Rate	NTSC	240 PPS – Max 240 FPS / 480 PPS – Max 480 PPS		
	PAL	240 PPS – Max 200 FPS / 480 PPS – Max 400 PPS		
Digital Control Output		8	16	16
Sensor Input		8	16	16
Resolution	NTSC	720x480 / 720x240 / 360x240		
	PAL	720x576 / 720x288 / 360x288		
Image Compression		MJPEG		
Average File Size		360x240 – 3~5k		
		720x240 – 4~8k		
		720x480 – 7~12k		
Video Inputs		8CH (BNC)	16CH (BNC)	32CH (BNC)
Looping Outputs		8CH (BNC) – Each can be terminated (75Ω)	16CH (BNC) – Each can be terminated (75Ω)	32CH (BNC) – Each can be terminated (75Ω)
Composite Outputs		RCA x1		
Video Outputs		SVGA x1, DVI-D x1		
Max PPS Per Channel		30 Pictures Per Second (PPS) – NTSC / 25 Pictures Per Second (PPS) - PAL		
Motion Detection		Up to 15 Regions Per Channel / Adjustable Sensitivity		
Remote Operation		Full Remote Control Through PSTN, ISDN, ADSL, LAN, and TCP/IP		
Remote Software		Compatible with Microsoft Windows 2000,XP		
PAN / TILT / ZOOM		Built In RS-485 Interface		
Recording Mode		Continuous, Motion Detection, Sensor, Scheduled Recording		
Backup		USB, DVD±RW		
Digital Signature		Supports Digital Signature Verification		
Emergency Agent		Transmitted through TCP/IP – SCS		

Free Manuals Download Website

<http://myh66.com>

<http://usermanuals.us>

<http://www.somanuals.com>

<http://www.4manuals.cc>

<http://www.manual-lib.com>

<http://www.404manual.com>

<http://www.luxmanual.com>

<http://aubethermostatmanual.com>

Golf course search by state

<http://golfingnear.com>

Email search by domain

<http://emailbydomain.com>

Auto manuals search

<http://auto.somanuals.com>

TV manuals search

<http://tv.somanuals.com>