

surveillix™

Operations Manual

KV-KLR



8GHO44-96

TOSHIBA

Surveillix™ KV-KLR User Guide

Manual Edition 26052AA - June 2004

Printed in USA

No part of this documentation may be reproduced in any means, electronic or mechanical, for any purpose, except as expressed in the Software License Agreement. Toshiba shall not be liable for technical or editorial errors or omissions contained herein. The information in this document is subject to change without notice.

THE INFORMATION IN THIS PUBLICATION IS PROVIDED "AS IS" WITHOUT WARRANTY OF ANY KIND. THE ENTIRE RISK ARISING OUT OF THE USE OF THIS INFORMATION REMAINS WITH RECIPIENT. IN NO EVENT SHALL TOSHIBA BE LIABLE FOR ANY DIRECT, CONSEQUENTIAL, INCIDENTAL, SPECIAL, PUNITIVE, OR OTHER DAMAGES WHATSOEVER (INCLUDING WITHOUT LIMITATION, DAMAGES FOR LOSS OF BUSINESS PROFITS, BUSINESS INTERRUPTION OR LOSS OF BUSINESS INFORMATION), EVEN IF TOSHIBA HAS BEEN ADVISED OF THE POSSIBILITY OF SUCH DAMAGES AND WHETHER IN AN ACTION OR CONTRACT OR TORT, INCLUDING NEGLIGENCE.

This software and documentation are copyrighted. All other rights, including ownership of the software, are reserved to DVR Support Center. TOSHIBA, and Surveillix are registered trademarks of TOSHIBA CORPORATION in the United States and elsewhere; Windows, and Windows 2000 are registered trademarks of Microsoft Corporation. All other brand and product names are trademarks or registered trademarks of the respective owners.

The following words and symbols mark special messages throughout this guide:



WARNING: Text set off in this manner indicates that failure to follow directions could result in bodily harm or loss of life.



CAUTION: Text set off in this manner indicates that failure to follow directions could result in damage to equipment or loss of information.

LIMITED WARRANTY DIGITAL VIDEO RECORDER

Promptly register your product with Toshiba on-line at <http://www.toshiba.com/taisisd>. By registering your product you will be eligible for periodic updates, announcements, and special offers applicable for your product. You will have access to extended warranty options, upgrades (as applicable), useful tips, on-line troubleshooting, and the ability to schedule service on-line if necessary. The Imaging Systems Division of Toshiba America Information Systems, Inc. ("ISD") makes the following limited warranties. These limited warranties extend to the Original End-User ("Your[r]").

Limited Two (2) Year Warranty of Labor and Parts

ISD warrants this product and parts against defects in material or workmanship for a period of two years from the date of original retail purchase by the end-user. During this period, ISD will repair or replace a defective product or part with a new or refurbished item. The user must deliver the entire product to an ISD authorized service center. The user is responsible for all transportation and insurance charges for the product to the Service Center. ISD reserves the right to substitute Factory Refurbished Parts and / or Factory Refurbished Product in place of those in need of repair.

Step-by-step Procedures - How to Obtain Warranty Service

[1] Verify operation of the unit by checking the instruction manual and web site for the latest updates at

www.toshiba.com/taisisd

[2] If there is a defect in material or workmanship, schedule service on-line or contact the Digital Support Center for an individual Tracking Number and the location of the nearest ISD authorized service center. To contact technical support call (866) ASK-4-DVR [866-275-4387].

[3] Arrange for delivery of the product to the ISD authorized service center. Products must be insured and securely packed, preferably in the original shipping carton. A letter explaining the defect and a copy of the bill of sale or other proof of purchase must be enclosed with a complete return street address and daytime telephone number. The Tracking Number should also be indicated on your documents. Charges for transportation and insurance must be prepaid by the end-user.

Your Responsibility, warranties are subject to the following conditions:

[1] You must retain the bill of sale or provide other proof of purchase.

[2] You must schedule service within thirty days after you discover a defective product or part.

[3] All warranty servicing of this product must be made by an ISD authorized service center.

[4] The warranty extends to defects in material or workmanship as limited above, and not to any products or parts that have been lost or discarded by user. The warranty does not cover damage caused by misuse, accident, improper installation, improper maintenance, or use in violation of instructions furnished by ISD. The warranty does not extend to units which have been altered or modified without authorization of ISD, or to damage to products or parts thereof which have had the serial number removed, altered defaced or rendered illegible.

ALL WARRANTIES IMPLIED BY STATE LAW, INCLUDING THE IMPLIED WARRANTIES OF MERCHANTABILITY AND FITNESS FOR A PARTICULAR PURPOSE, ARE EXPRESSLY LIMITED TO THE DURATION OF THE LIMITED WARRANTIES SET FORTH ABOVE. Some states do not allow limitations on how long an implied warranty lasts, so the above limitation may not apply. WITH THE EXCEPTION OF ANY WARRANTIES IMPLIED BY STATE LAW AS HEREBY LIMITED, THE FOREGOING EXPRESS WARRANTY IS EXCLUSIVE AND IN LIEU OF ALL OTHER WITH RESPECT TO THE REPAIR OR REPLACEMENT OF ANY PRODUCTS OR PARTS. IN NO EVENT SHALL ISD BE LIABLE FOR CONSEQUENTIAL OR INCIDENTAL DAMAGES. Some states do not allow the exclusion or limitation of incidental or consequential damages so the above limitation may not apply.

No person, agent, distributor, dealer, service station or company is authorized to change, modify or extend the terms of these warranties in any manner whatsoever. The time within which an action must be commenced to enforce any obligation of ISD arising under this warranty or under any statute, or law of the United States or any state thereof, is hereby limited to one year from the date you discover or should have discovered, the defect. This limitation does not apply to implied warranties arising under state law. Some states do not permit limitation of the time within which you may bring an action beyond the limits provided by state law so the above provision may not apply to user. This warranty gives the user specific legal rights, and user may also have other rights, which may vary from state to state.

TOSHIBA AMERICA INFORMATION SYSTEMS, INC.

Imaging Systems Division

Copyright © 2002 Toshiba America Information Systems, Inc. All rights reserved.

TOSHIBA

Safety Precautions

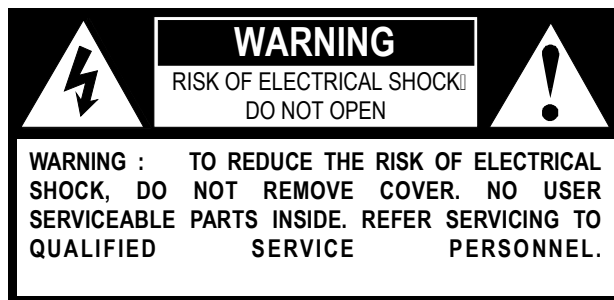

WARNING: TO REDUCE THE RISK OF ELECTRICAL SHOCK, DO NOT EXPOSE THIS APPLIANCE TO RAIN OR MOISTURE. DANGEROUS HIGH VOLTAGES ARE PRESENT INSIDE THE ENCLOSURE. DO NOT OPEN THE CABINET. REFER SERVICING TO QUALIFIED PERSONNEL ONLY.

IMPORTANT SAFETY INSTRUCTIONS

1. Read Owner's Manual

After unpacking this product, read the owner's manual carefully, and follow all the operating and other instructions.

2. Power Sources

This product should be operated only from the type of power source indicated on the label. If you are not sure of the type of power supply to your business or home, consult your product dealer or local power company.

3. Ventilation

Slots and openings in the cabinet are provided for ventilation and to ensure reliable operation of the product and to protect it from overheating, and these openings must not be blocked or covered. The product should not be placed in a built-in installation such as a bookcase or rack unless proper ventilation is provided or the manufacturer's instructions have been adhered to.

4. Heat

The product should be situated away from heat sources such as radiators. Heat registers, stoves, or other products that produce heat.

5. Water and Moisture

Do not use this product near water. Do not exceed the humidity specifications for the product as detailed in the Appendix section in this manual.

6. Cleaning

Unplug this product from the wall outlet before cleaning. Do not use liquid cleaners or aerosol cleaners. Use a damp cloth for cleaning.

7. Power Cord Protection

Power-supply cords should be routed so that they are not likely to be walked on or pinched by items placed against them, paying particular attention to cords at plugs, convenience receptacles, and the point where they exit from the product.

8. Overloading

Do not overload wall outlets, extension cords, or integral convenience receptacles as this can result in a risk of fire or electrical shock.

9. Lightning

For added protection for this product during storm, or when it is left unattended and unused for long periods of time, unplug it from the wall outlet. This will prevent damage to the product due to lightning and power line surges.

10. Object and Liquid Entry Points

Never insert foreign objects into the DVR unit, other than the media types approved by Toshiba, as they may touch dangerous voltage points or short-out parts that could result in a fire or electrical shock. Never spill liquid of any kind on the product.

11. Accessories

Do not place this product on an unstable cart, stand, tripod, bracket, or table. The product may fall, causing serious personal injury and serious damage to the product.

IMPORTANT SAFETY INSTRUCTIONS

12. **Disc Tray**

Keep your fingers well clear of the disc tray as it is closing. Neglecting to do so may cause serious personal injury.

13. **Burden**

Do not place a heavy object on or step on the product. The object may fall, causing serious personal injury and serious damage to the product.

14. **Disc**

Do not use a cracked, deformed, or repaired disc. These discs are easily broken and may cause serious personal injury and product malfunction.

15. **Damage Requiring Service**

Unplug this product from the wall outlet and refer servicing to qualified service personnel under the following conditions.

- When the power-supply cord or plug is damaged.
- If liquid has been spilled, or objects have fallen into the product.
- If the product has been exposed to rain or water.
- If the product does not operate normally by following the operating instructions. Adjust only those controls that are covered by the operating instructions as an improper adjustment of other controls may result in damage and will often require extensive work by a qualified technician to restore the product to its normal operation.
- If the product has been dropped or damaged in any way.
- When the product exhibits a distinct change in performance – this indicates a need for service.

16. **Servicing**

Do not attempt to service this product yourself as opening or removing covers may expose you to dangerous voltage or other hazards. Refer all servicing to qualified personnel.

17. **Replacement Parts**

When replacement parts are required, be sure the service technician has used replacement parts specified by the manufacturer or have the same characteristics as the original part. Unauthorized substitutions may result in fire, electrical shock, or other hazards.

18. **Safety Check**

Upon completion of any service or repairs to this product, ask the service technician to perform safety checks to determine that the product is in proper operating condition.

Notes on Handling

- When shipping the DVR unit, the original shipping carton packing materials come in handy. For maximum protection, repack the unit as it was originally packed at the factory.
- Do not use volatile liquids, such as insect spray, near the DVR unit. Do not leave rubber or plastic products in contact with the DVR unit for long periods of time. They will leave marks on the finish.
- The top and rear panels of the DVR unit may become warm after long periods of use. This is not a malfunction.

Notes on Locating

- Place the DVR unit on a level surface. Do not use it on a shaky or unstable surface such as a wobbling table or inclined stand.
- When you place this DVR unit next to a TV, radio, or VCR, the playback picture may become poor and the sound may be distorted. In this case, place the DVR unit away from the TV, radio, or VCR.

Notes on Cleaning

Use a soft dry cloth for cleaning.

- For stubborn dirt, soak the cloth in a weak detergent solution, wring well and wipe. Use a dry cloth to wipe it dry.
Do not use any type of solvent, such as thinner and benzene, as they may damage the surface of the DVR unit.
- If you use a chemical saturated cloth to clean the unit, follow that product's instructions.

Notes on Maintenance

This DVR unit is designed to last for long periods of time. To keep your DVR unit always operational we recommend regular inspection maintenance (cleaning parts or replacement). For details contact your nearest dealer.

Note on Moisture Condensation

Moisture condensation damages the DVR unit. Please read the following carefully.

Moisture condensation occurs during the following cases.

- When you bring the DVR unit directly from a cold place to a warm place.
- When you use the DVR unit in a room where you just turned on the heater, or a place where the cold wind from the air conditioner directly hits the unit.
- In the summer, when you use the DVR unit in a hot and humid place just after you move the unit from an air conditioned room.
- When you use the DVR unit in a humid place.

Do not use the DVR unit when moisture condensation may occur.

If you use the DVR unit in such a situation, it may damage discs and internal parts. Remove any CD discs, connect the power cord of the DVR unit to the wall outlet, turn on the DVR unit, and leave it for two to three hours. After two to three hours, the DVR unit will have warmed up and evaporated any moisture. Keep the DVR unit connected to the wall and moisture will seldom occur.

Table of Contents

SAFETY PRECAUTIONS	V
PREFACE.....	1
ABOUT THIS GUIDE.....	1
TECHNICIAN NOTES	1
INTRODUCTION	2
WHAT IS A SURVEILLIX® DVR™	2
NEW FEATURES.....	3
DVR DESCRIPTION.....	4
1.1 BASIC FEATURES	5
1.2 FRONT PANEL CONTROLS AND LEDs	6
1.3 REAR PANEL CONNECTORS	7
1.4 SERIAL NUMBER	8
GETTING STARTED.....	9
2.1 IDENTIFYING INCLUDED COMPONENTS.....	10
2.2 KEYBOARD SETUP	11
2.3 MOUSE SETUP.....	11
2.4 MONITOR SETUP	12
2.5 POWER SETUP	12
2.6 CONNECTING A VIDEO SOURCE TO THE DVR.....	12
2.7 CONNECTING SENSORS TO THE DVR	13
2.8 CONNECTING CONTROL OUTPUTS TO THE DVR.....	14
2.9 OPTIONAL COMPONENTS.....	15
DVR BASICS	16
3.1 TURNING ON THE DVR.....	17
3.2 TURNING OFF THE DVR	18
3.3 DISPLAY SCREEN	19
3.4 CAMERA VIEW	20
3.5 RECORDING STATUS INDICATOR	21
3.6 SCREEN DIVISION MENU	21
SETUP OPTIONS.....	23
4.1 SETUP OVERVIEW	24
4.1.1 Setup Screen Overview.....	24
4.2 CAMERA SETUP.....	25
4.3 MOTION.....	26
4.3.1 Creating a Motion Area.....	27
4.3.2 Activating an Alarm Output on a Motion Event	27
4.4 FRAME SETUP	28
4.5 SCHEDULE SETUP (RECORDING).....	29

4.5.1	Schedule Setup (Sensor)	30
4.5.2	Creating a Recording Schedule (Motion and Continuous)	31
4.5.3	Creating a Recording Schedule (Sensor)	31
4.5.4	Scheduling Alarm Events	32
4.5.5	Scheduling Alarm Events to send video to the Emergency Agent	32
4.5.6	Special Day Schedule	33
4.5.7	Creating and Editing a 'Special Day' Schedule	33
4.6	SENSOR	34
4.7	GENERAL	35
4.7.1	Voice Warning	36
4.7.2	Video Loss Alarm	36
4.7.3	Intensive Recording Overview	37
4.7.4	Intensive Recording	37
4.7.5	Audio	38
4.7.5.1	Attaching the Audio Adapter	38
4.8	NETWORK (SETUP FOR REMOTE CONNECTIONS)	39
4.8.1	Two-Way Audio	40
4.9	PTZ SETUP	43
4.10	INFORMATION	43
4.11	ADMINISTRATIVE	44
4.11.1	User Management	45
4.11.2	User Rank	46
4.11.3	Changing the Administrator Password	46
4.12	INSTANT RECORDING	46
4.13	ADJUSTING THE TIME AND DATE	47
SEARCH OPTIONS		48
5.1	SEARCH OVERVIEW	49
5.2	PLAY CONTROLS	50
5.3	HOUR / MINUTE CONTROL BAR	50
5.4	ADVANCED OPTIONS	51
5.5	SEARCH OPTIONS OVERVIEW	52
5.6	PERFORMING A BASIC SEARCH	53
5.6.1	Daylight Savings Time	53
5.7	PRINT/OPEN/EXPORT IMAGES	53
5.7.1	Print	54
5.7.2	Save to JPG or AVI	54
5.8	INDEX SEARCH	55
5.9	PREVIEW SEARCH	56
5.10	OBJECT SEARCH	58
5.11	GRAPHIC SEARCH	60
5.12	AUDIO PLAYBACK	61
PAN / TILT / ZOOM		62
6.1	PAN/TILT/ZOOM OVERVIEW	63

6.2	SETTING UP A PTZ CAMERA	63
6.2.1	<i>Supported Protocols</i>	65
6.3	PTZ SETUP	66
6.4	CREATING AND VIEWING PRESET POSITIONS	67
6.5	PTZ ADDRESS SETTING	68
6.6	ACCESSING PTZ MENU'S	68
6.7	USING THE ONSCREEN COMPASS	69
6.7.1	<i>Using the onscreen controller and Compass</i>	69
6.8	UNDERSTANDING TOURS	70
BACKING UP TO A CD-RW DRIVE		71
7.1	BACKUP OVERVIEW	72
7.2	DIRECTCD [®] FORMAT UTILITY	72
7.3	FORMATTING A CDR OR CD-RW FROM WINDOWS	73
7.4	FORMATTING A CDR OR CD-RW FROM THE BACKUP WINDOW	74
7.5	BACKUP OPTIONS OVERVIEW	74
7.6	SCHEDULED BACKUP OPTIONS OVERVIEW	76
7.7	SPECIFYING SCHEDULED BACKUP DRIVES	77
7.8	CREATING SCHEDULED BACKUP	77
7.9	BACKING UP TO A CD-RW DRIVE OR HARD DRIVE	78
7.10	REMOVING THE DISC FROM THE CD-RW DRIVE	79
7.11	SETTING THE DIRECTCD PATH USING VFORMAT	80
7.12	CONFIRM WINDOWS PASSWORD USING VFORMAT	80
LAN / ISDN / PSTN CONNECTIONS		81
8.1	LAN OVERVIEW	82
8.2	CONNECTING TO A LAN USING TCP/IP	82
DIGITAL SIGNATURE VERIFIER		84
9.1	DIGITAL SIGNATURE OVERVIEW	85
9.2	INSTALLATION	85
9.3	USING THE DIGITAL SIGNATURE VERIFIER	86
BACKUP VIEWER		88
10.1	BACKUP VIEWER OVERVIEW	89
10.2	INSTALLATION	90
10.3	LOADING VIDEO FROM CDROM OR HARD DRIVE	93
EMERGENCY AGENT		94
11.1	EMERGENCY AGENT OVERVIEW	95
11.2	INSTALLING THE EMERGENCY AGENT	95
11.3	CONFIGURING THE DVR	96
11.4	CONFIGURING THE CLIENT PC	97
11.5	EMERGENCY AGENT WINDOW	98
11.6	SEARCH ALARM WINDOW	99
11.7	CONFIGURATION WINDOW	100
WEB VIEWER		101
12.1	WEB VIEWER OVERVIEW	102

12.2	CONFIGURING THE SERVER FOR REMOTE CONNECTION.....	103
12.3	CONNECTING TO A DVR USING WEB VIEWER	103
12.4	CLOSING THE WEB VIEWER.....	103
REMOTE SOFTWARE.....		104
13.1	REMOTE SOFTWARE OVERVIEW.....	105
13.1.1	REMOTE CLIENT MINIMUM REQUIREMENTS	106
13.1.2	REMOTE CLIENT RECOMMENDED REQUIREMENTS.....	106
13.2	REMOTE SOFTWARE SETUP	106
13.2.1	INSTALLING REMOTE SOFTWARE	106
13.2.2	CREATE A NEW REMOTE CONNECTION.....	107
13.3	REMOTE SERVER SETUP	108
13.3.1	CONFIGURING THE SERVER FOR REMOTE CONNECTION.....	108
APPENDIX A		109
APPENDIX A		109
1.1	KV-KLR4 SPECIFICATIONS.....	110
1.1	KV-KLR8 SPECIFICATIONS.....	111
1.3	KV-KLR16 SPECIFICATIONS.....	112

Preface

About this Guide

This manual is a setup and maintenance guide that can be used for reference when setting up the DVR unit and for troubleshooting when a problem occurs. Only authorized personnel should attempt to repair this unit.

Toshiba reserves the right to make changes to the DVR units represented by this manual without notice.

The following text and symbols mark special messages throughout this guide:



WARNING: Text set off in this manner indicates that failure to follow directions could result in bodily harm or loss of life.



CAUTION: Text set off in this manner indicates that failure to follow directions could result in damage to equipment or loss of information.



NOTE: Text set off in this manner indicates topics of interests that can help the user understand the product better.



TIP: Text set off in this manner indicates topics and points of interests that can be helpful when using or settings up the DVR unit.

Technician Notes



WARNING: Only authorized technicians trained by Toshiba should attempt to repair this DVR unit. All troubleshooting and repair procedures that may be shown are for reference and minor repair only. Because of the complexity of the individual components and subassemblies, no one should attempt to make repairs at the component level or to make modifications to any printed wiring board. Improper repairs can create a safety hazard. And any indications of component replacement or printed wiring board modifications may void any warranty.



WARNING: To reduce the risk of electrical shock or damage to the equipment:

- Do not disable the power grounding plug. The grounding plug is an important safety feature.
- Plug the power cord into a grounded (earthed) electrical outlet that is easily accessible at all times.
- Disconnect the power from the computer by unplugging the power cord either from the electrical outlet or the computer.



CAUTION: To properly ventilate your system, you must provide at least 3 inches (7.6 cm) of clearance at the front and back of the DVR unit.

Introduction

What is a Surveillix® DVR™

A Surveillix DVR is simply a server that performs as a High Definition Digital Recorder. By utilizing the many features of a computer, including processing power, storage capacity, graphics compression, and security features, the DVR unit is more powerful than the analog recorders of the past.

The Surveillix DVR server software comes pre-configured for fast and seamless integration within your existing IT infrastructure. Designed around Microsoft® Windows® 2000, the server software offers unparalleled stability, security, and ease of use. Accordingly, your security investment has never been easier to maintain. Multiple users may simultaneously connect through any network connection for instantaneous live viewing, digital search, and off site video storage. Users can also connect remotely through DSL, Cable Modems, ISDN, or 56K dial-up. This powerful software enables users to establish recording schedules, create motion detection zones, use PTZ controls, and configure alarm inputs and outputs for each of the system's cameras. With the latest advancements in the DVR Server Software, searching and indexing your video archive has never been easier. Video can now be found, viewed, and exported in a number of file formats with just a few clicks.

The Surveillix DVR is high performance security product ready to meet today's security demands.

New Features

Toshiba's Surveillix KV-KLR DVRs include the following new features:

- Optimized and Designed for Microsoft® Windows® 2000
- Supports 4 Digital Control Outputs on Alarm Activation
- Supports up to 16 Sensor Inputs for Alarm Control
- Remote System Operation & Configuration
- Supports Multiple Simultaneous Remote Connections
- PAN / TILT / ZOOM Controls
- Simultaneous Video Search, Playback and Backup
- Video Indexes for Easy Searching
- Multiple Levels of Security Access
- Up to 2 Audio Inputs
- Optional POS and ATM Support
- 1 Composite Output (KV-KLR4 Excluded)
- Up to 16 Camera Inputs
- High Performance, Durable, Rackmount Chassis (KV-KLR4 Excluded)
- Output the Video to a NTSC/PAL Display
- Virtually Unlimited Storage Potential
- Supports Digital Signatures
- Video Loss Alarm Functionality
- Continuous, Motion Detection, Alarm, Pre-Alarm, and Scheduled Recording Modes
- Hardware Watchdog

CHAPTER **1**

DVR Description

This chapter includes the following information:

- Input/Output connector locations
- Front Panel Controls and LEDs
- Rear Panel Connectors
- Drive Positions
- Serial Number Location

1.1 Basic Features

Surveillix™ state-of-the-art High Definition Digital Recorders are housed in a high performance and versatile 4U Aluminum Rack-Mount case allowing easy storage of multiple DVRs for enterprise applications. Every Surveillix DVR Unit comes equipped with the latest technology:

- Intel® Pentium® IV Processor
- 10/100 Network Interface Card (NIC)
- 256 MB of System Memory
- 32 MB Video Card
- CD-RW Recorder
- 3.5" Floppy Drive
- Full Duplex High-Fi Sound Functionality

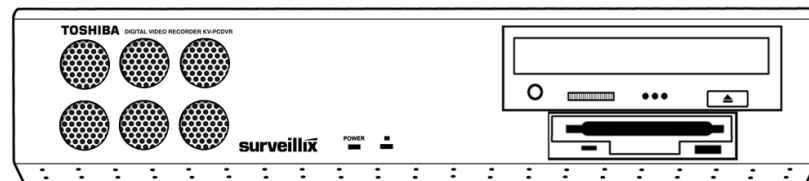

1.2 Front Panel Controls and LEDs

The front panel of the DVR unit contains the devices that will be commonly used for data removal, retrieval, and backup replacement. The most common components and buttons are shown below:

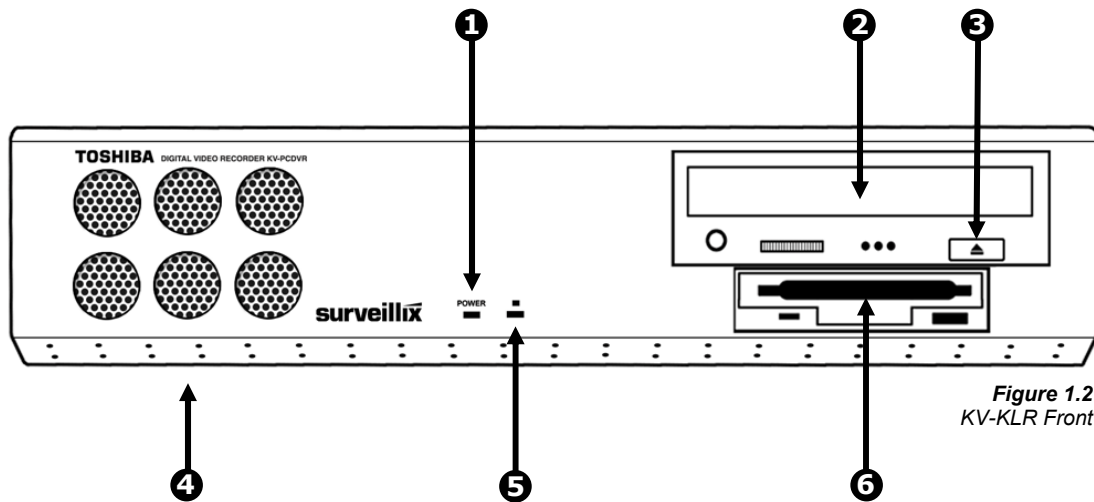

Figure 1.2
KV-KLR Front

Figure 1.2		
1	Power LED Display	Displays When the DVR is on.
2	CD-RW Drive	Used to backup video, install updates, and play previously backup-up video.
3	CD-RW Open Tray Button	Opens the CDROM Tray.
4	Cooling Fan Air Intake	Used to intake air to keep the DVR unit from overheating. NOTE - DO NOT OBSTRUCT THIS AIR VENT.
5	Hard Drive Activity LED Display	Displays the Hard Drive activity.
6	3.5" Floppy Disk Drive	Used to save images and small video clips.

1.3 Rear Panel Connectors

The rear panel of the DVR unit contains virtually all of the connectors you will be using. Below is a diagram that outlines the location and description of each connector:

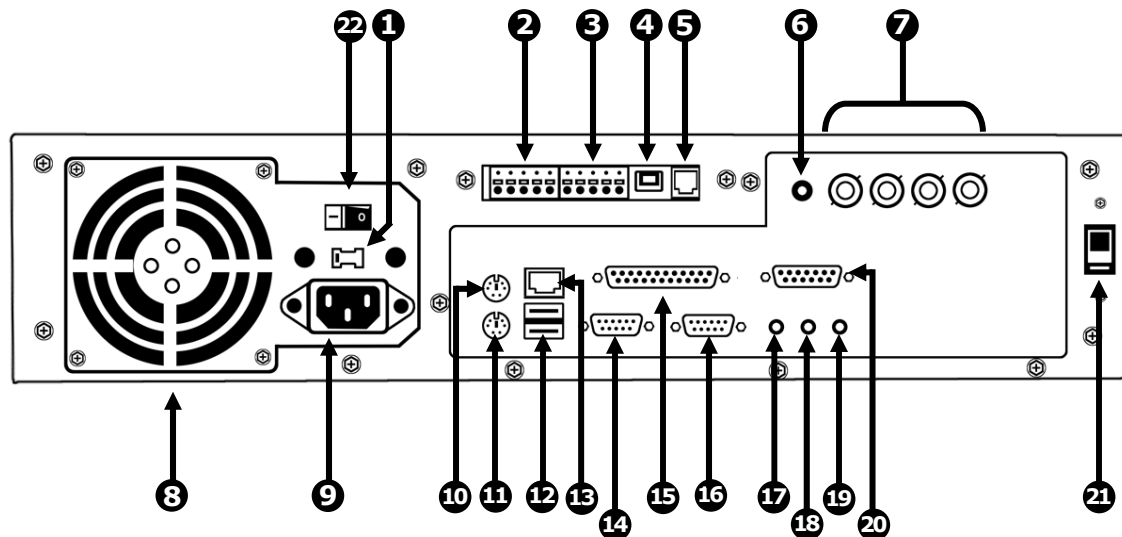

Figure 1.3
KV-KLR Rear

Figure 1.3		
1	110V / 220V Switch	For switching between 110V and 220V power supplies.
2	Alarm Outputs	There are 4 Alarm (Relay) Outputs on this DVR
3	Sensor Inputs	There are 4 Sensor Outputs on this DVR
4	RS-422 Interface	For connecting to a PAN/TILT/ZOOM camera.
5	RS-232 Interface	For connecting to a PAN/TILT/ZOOM camera.
6	RCA Video OUT	Composite out.
7	RG 59 Connector for Camera - Input and Looping Outputs	These BNC Connectors are used to connect the Live Output from a camera to the DVR unit.
8	Power Supply Fan	Supplies Ventilation to the DVR unit.
9	AC Power Adapter	For connecting to an external power supply.
10	PS/2 Mouse Input (Mini-Din 6)	For connection to a Computer Mouse.
11	PS/2 Keyboard Input (Mini-Din 6)	For connection to a Keyboard.
12	USB Ports 1 and 2	For connection to USB Devices such as a Printer.
13	RJ-45 Network Jack	For connecting the unit to a network.
14	DB-9 Serial Input 1	Used for connection to a POS device.
15	LPT Parallel Printer Port	For connecting the unit to a Printer.
16	DB-15 SVGA Monitor Output	For connecting to a SVGA Monitor.
17	Audio Speaker Out	For a connecting to a Speaker.
18	Audio Microphone In	NOT USED
19	Audio Line In	For accepting audio inputs. Attach Audio Adapter here.
20	DB-15 Serial Port	For Connecting to Serial devices.
21	Power Switch	Turns the power to the DVR ON and OFF.
22	Secondary Power Switch	Turns off the power to the Power Supply

1.4

Serial Number

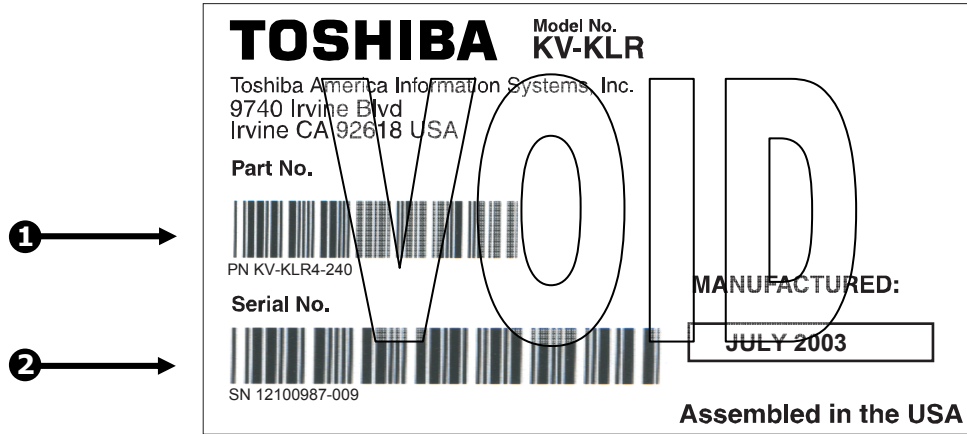

Figure 1.4

Figure 1.4

-
- 1 Part Number** – You can find your part number located on the side of the DVR unit as shown in *Figure 1.4*.
 - 2 Serial Number** – You can find your serial number located on the side of the DVR unit as shown in *Figure 1.4*.
-

! NOTE: Be sure and keep your serial number written down and accessible. Your serial number is required when contacting Technical Support.

CHAPTER 2

Getting Started

This chapter includes the following information:

- Included Components
- Setting up your DVR Hardware
- Optional Components

2.1 Identifying included components

Surveillix™ DVRs come with a mouse, keyboard and selected software and cables. Identify the following components to make sure everything has been properly included with your new DVR unit. If any of the following items are missing, contact your dealer to arrange a replacement.

Included Component List:

1. DVR Unit
2. Mouse
3. DVR Key (Does not apply to KV-KLR4)
4. Manual
5. Repair CD / Software Installation CD
6. Audio Adapter
7. Keyboard
8. PTZ Adapter
9. RCA to BNC Adapter (Does not apply to KV-KLR4)
10. Rackmount Attachments with Screws (Does not apply to KV-KLR4)
11. Power Cable
12. RS-422 to RS-232 converter for PTZ (Serial-RJ11)

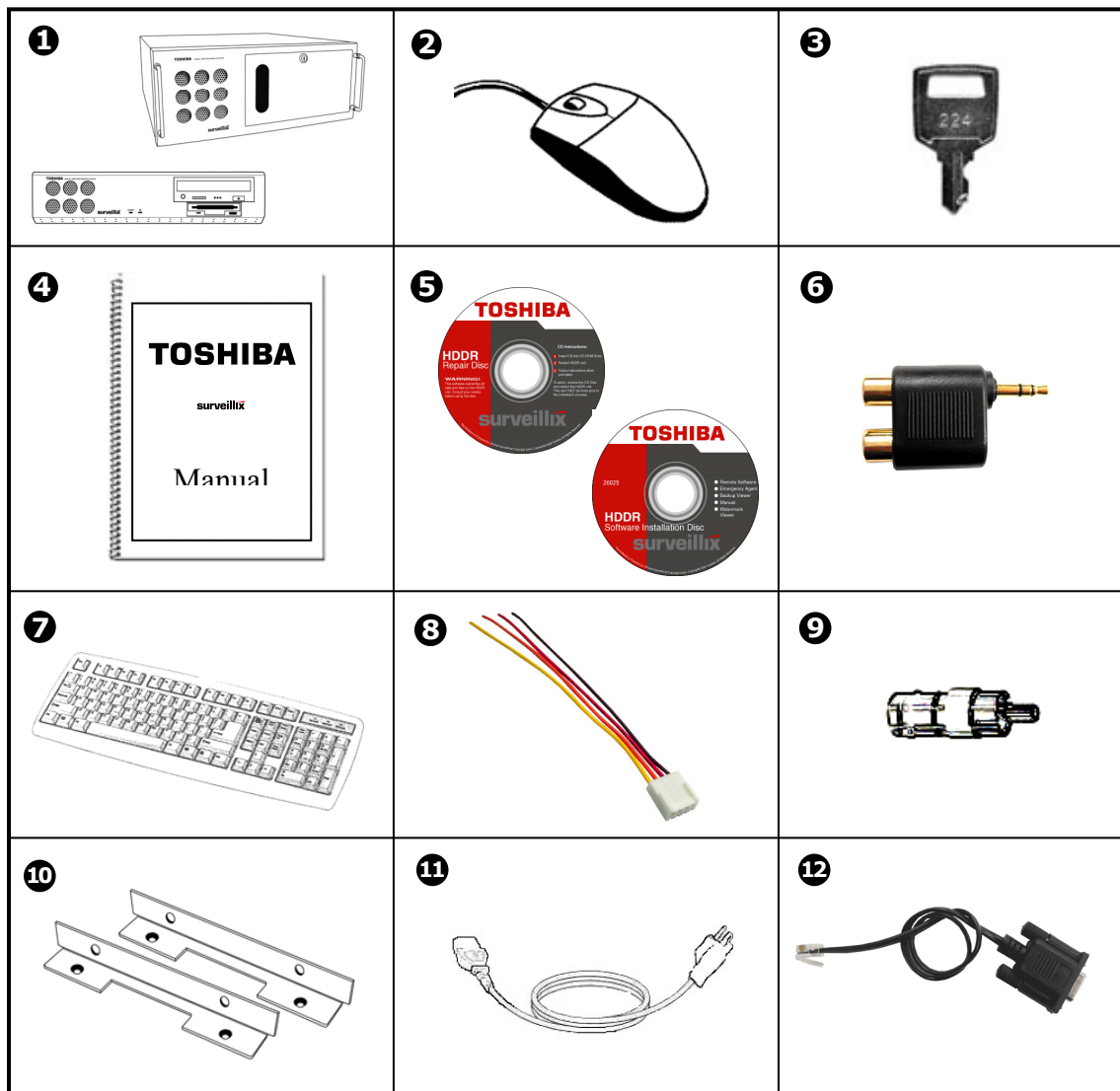

2.2 Keyboard Setup

To attach the keyboard to the DVR unit, plug the end of the Keyboard into the keyboard PS/2 Port located on the back of the machine. The keyboard PS/2 Port can be identified by the purple color. Refer to the Rear Panel Connectors diagram for more information.



2.3 Mouse Setup

To attach the mouse to the DVR unit, plug the end of the mouse into the mouse PS/2 Port located on the back of the machine. The mouse PS/2 Port can be identified by the green color. Refer to the Rear Panel Connectors diagram for more information.

The mouse uses a cursor called a pointer. Pointers come in many different shapes but are most commonly shaped like an arrow.

Your mouse has two buttons: a left button and a right button. Quickly pressing and releasing one of these buttons is called clicking. Sometimes you will need to double-click – or click the same button twice quickly.

In this manual, click means to position your mouse point on an icon and to single click the left button. When a right click is required, this is stated clearly. Double-click also refers to the left button.

The ratchet wheel in between the two buttons is added to provide easier scrolling capability. By simply moving the wheel with your index finger, you can quickly move through multiple pages, line, or windows. The wheel may also function as a third button allowing you to quickly click or double-click an icon or a selected item.

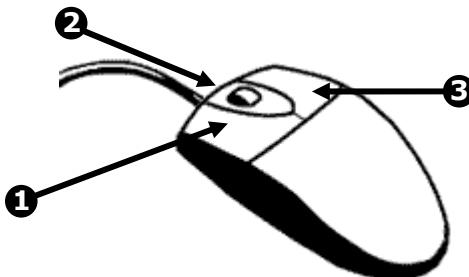

Figure 2.3

Figure 2.3

1	Left Button	3	Right Button
2	Scroll button / Third Button		

2.4 Monitor Setup

Attach the Monitor to the Rear of the DVR unit using the VGA cable supplied by the Monitor Manufacturer. Refer to your monitor manual for detailed information on how to setup and use it.

! NOTE: The monitor you use must be capable of having a screen resolution of 1024 x 768 and display colors of at least 24 Bit

2.5 Power Setup

Attach the AC power cable to the rear of the DVR Unit. See Rear Panel Connectors for more information.



WARNING: To reduce the risk of electrical shock or damage to the equipment:

- Do not disable the power grounding plug. The grounding plug is an important safety feature.
- Plug the power cord into a grounded (earthed) electrical outlet that is easily accessible at all times.
- Disconnect the power from the computer by unplugging the power cord either from the electrical outlet or the computer.

2.6 Connecting a Video Source to the DVR

KV-KLR8 and KV-KLR16

There are different types of Video Sources that can be plugged into your DVR unit including DVD players, VHS players, and CCTV Cameras. The back of the DVR unit contains up to 16 video inputs depending on the DVR model. The connectors use the BNC standard. On the KV-KLR8 (8 Channel) the 9-16 inputs will be unusable.

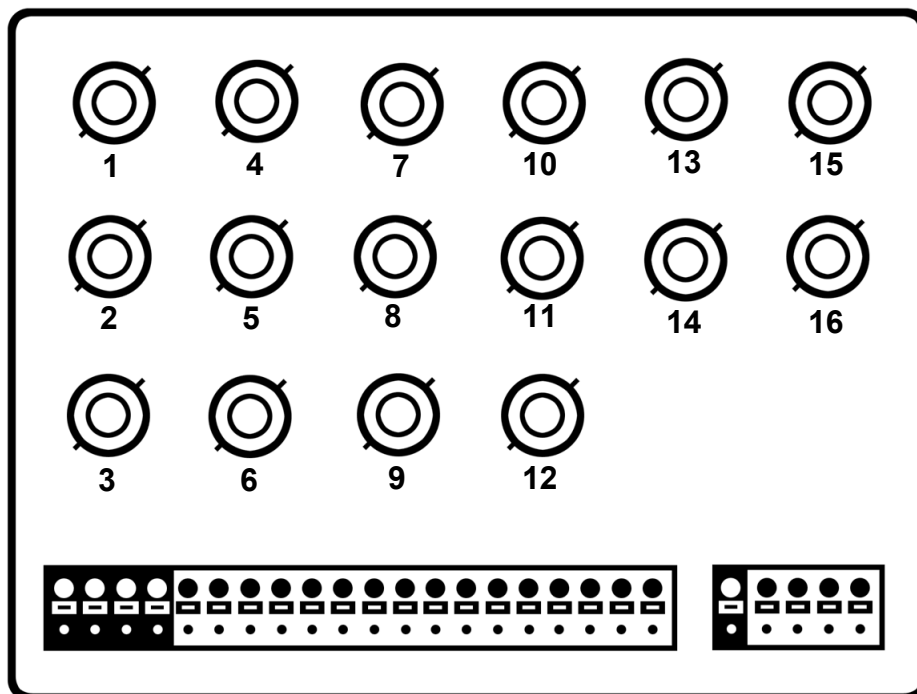

Figure 2.6
KV-KLR16 Shown

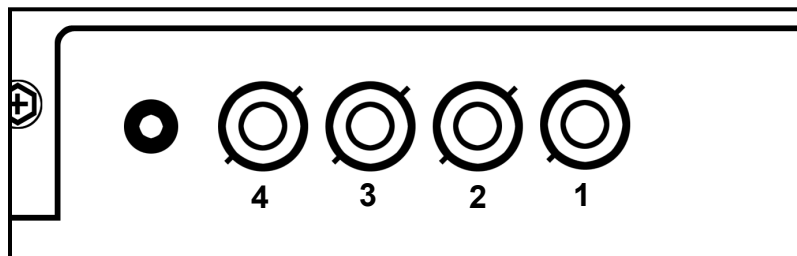

Figure 2.6b
KV-KLR4 Shown

2.7

Connecting Sensors to the DVR

Each DVR unit may have up to 4 Sensor inputs. These inputs can be used with devices such as Infrared devices, motion devise, glass breakage alarms, door and window trips, and many more. The Sensors can be set to Normally Open or Normally Closed inside the software.

There are 4 Commons (-) and 16 inputs (+). There is no power supplied to the ports so an external power supply must be used if power becomes necessary.

Sensor Input

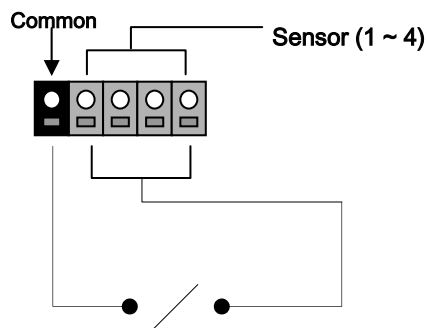

- Normally Open or Normally Closed option is available inside the DVR Software.
- There is no power supplied to the ports. Use an external power supply if necessary.

2.8 Connecting Control Outputs to the DVR

Each DVR unit may have up to 16 Control Outputs. These outputs can be used to trigger devices such as Sirens, Phone Dialers, Lights, and any other relay activated device.

Control Output

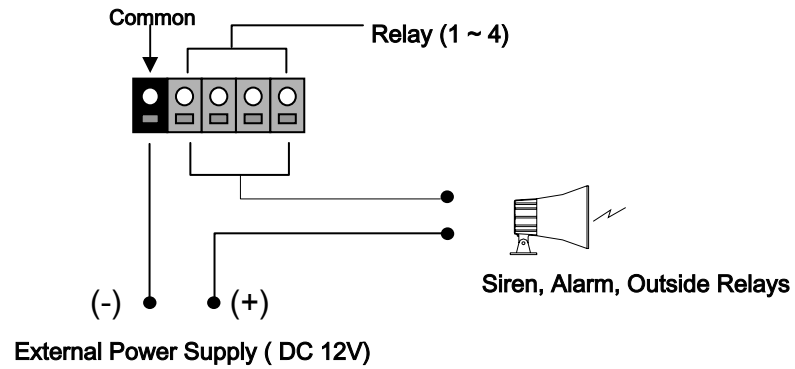

- Use 12V, below 300mA. For controlling lights or other devices, use another external relay.
- Maximum voltage is 24V AC @ 1 amp
- Output uses a Form C Relay

2.9

Optional Components

To fully utilize your DVR unit's potential, several optional Surveillix components are listed below. Contact your dealer for more information.

- | | | |
|----|---------------------------------------|--|
| 1) | Extra Video Storage Hard Drive | – Each DVR unit has a virtually unlimited storage potential. By adding additional Video Data Hard Drives you can extend the amount of Video Data your DVR system can store before overwriting older data. |
| 2) | NP-FM56USB | 56K External Modem – This 56K modem allows you to connect the DVR to a standard phone line. Using this modem you can either connect the unit to the Internet or allow a direct DVR to computer connection. |
| 3) | PW-UPS | UPS Power Backup – UPS Power Backups allow your DVR unit to remain fully functional even in the event of a power failure. UPS Power Backups also even the fluctuating power current out to provide a consistent, reliable power flow. This creates a stable environment for the DVR unit and reduces failure. |
| 4) | NP-4PKVM | 4 Channel KVM Switch – The 4 Channel KVM switch allows you to have multiple boxes (up to 4) using only one keyboard, mouse and monitor. You can simply switch between the DVR units using the keyboard. |
| 5) | MO-F50L | 15" LCD Monitor – 15" Flat screen monitor. |
| 6) | MO-F70L | 17" LCD Monitor – 15" Flat screen monitor. |
| 7) | MO-T17 | 17" CRT Monitor – 17" Standard CRT monitor. |
| 8) | MO-T19 | 19" CRT Monitor – 19" Standard CRT monitor. |

CHAPTER 3

DVR Basics

This chapter includes the following information:

- Turning the DVR on and off
- Becoming familiar with the Display screen
- Defining Screen Divisions

3.1 Turning on the DVR

Once the cables and adapters have been properly connected (See Chapter 2) it is time to turn on the power. To turn on the power follow these steps:

KV-KLR8 and KV-KLR16

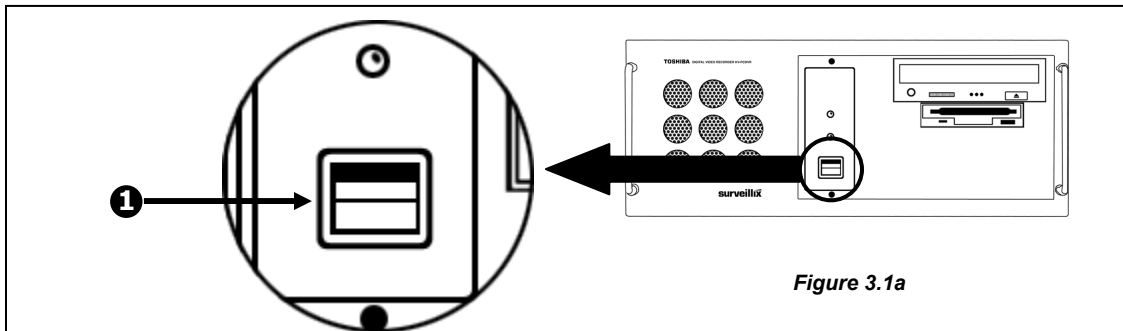

Figure 3.1a

Turning the DVR unit ON

- 1) Turn on the monitor and any external peripherals (ex. Printers, External Storage Devices, etc.) connected to the DVR unit.
- 2) Turn on the Secondary Power Switch located in the rear of the DVR unit.
- 3) Turn on the main power switch located on the front of the DVR unit as shown in *Figure 3.1a*. The DVR will run a series of self-tests. After two or three minutes a series of messages may be displayed as the various hardware and software subsystems are activated. Under normal circumstances you should not be asked to respond to these messages. If you are asked to respond to the messages (adding a Printer, Monitor, etc for the first time) follow the instructions carefully.

After this finishes, the Surveillix DVR software should load automatically and bring you to the main screen.

KV-KLR8

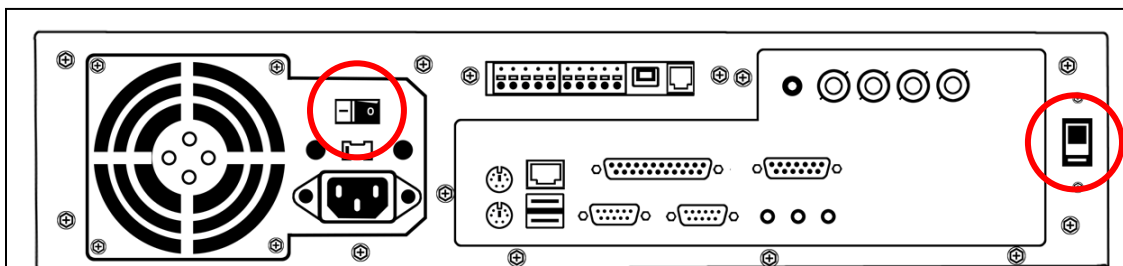

Turning the DVR unit ON

- 1) Turn on the monitor and any external peripherals (ex. Printers, External Storage Devices, etc.) connected to the DVR unit.
- 2) Turn on the Secondary Power Switch located in the rear of the DVR unit (next to the Power Supply Fan).
- 3) Turn on the main power switch located on the rear of the DVR unit as shown in *Figure 3.1a*. The DVR will run a series of self-tests. After two or three minutes a series of messages may be displayed as the various hardware and software subsystems are activated. Under normal circumstances you should not be asked to respond to these messages. If you are asked to respond to the messages (adding a Printer, Monitor, etc for the first time) follow the instructions carefully.

After this finishes, the Surveillix DVR software should load automatically and bring you to the main screen.

3.2 **Turning off the DVR**

Turning the DVR unit OFF

-
- 1) To turn off the DVR unit, select the Exit button from the main screen. This will prompt you whether you wish to exit the program or not. Select yes. The DVR unit will shut itself off automatically once this is done. The DVR unit may take several minutes to shut down completely.
-



CAUTION: Always be sure to follow the proper procedures when turning off the power to the DVR unit. NEVER disconnect the power to the DVR unit while it is still running or in the process of shutting down. Doing so can cause data loss, file corruption, system instability and hardware failure.

3.3 Display Screen

Each time the DVR is restarted, the program defaults to the Display screen. The following diagram outlines the buttons and features used on the Display screen. You should become familiar with these options as this is the screen that will be displayed the majority of the time.

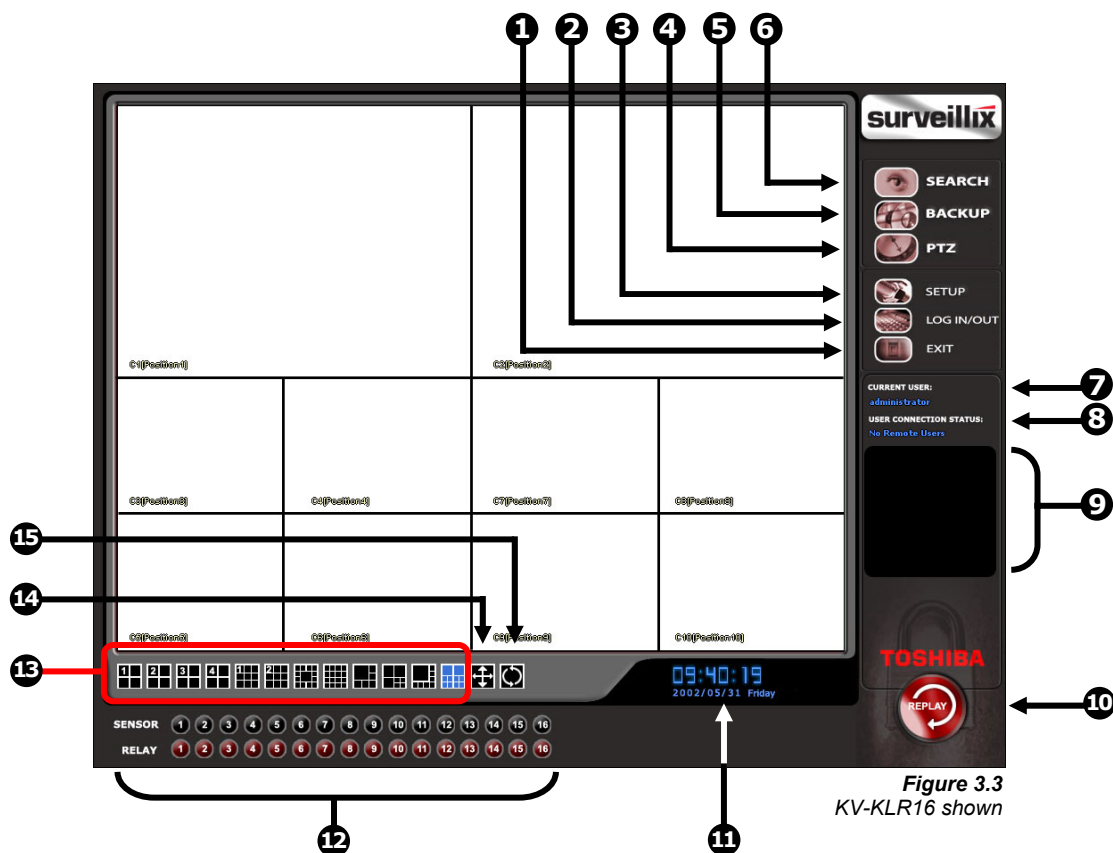

Figure 3.3
KV-KLR16 shown

Figure 3.3

-
- 1** **Exit Button** – The exit button brings up several options, including Shut Down, Restart, Log On, Log Off and Restart in Windows Mode.

 - 2** **Log In / Log Out** – This button Logs the current user off and allows you to Log in using a different user account.

 - 3** **Setup** – This Brings up the setup menu from which all customizable settings can be edited.

 - 4** **PTZ** – Opens the PAN / TILT options for controlling PTZ enabled Cameras.

 - 5** **Backup Button** – Brings up the Backup options.

 - 6** **Search Button** – Displays search features that allow you to search through previously recorded video.

 - 7** **Current User** – Displays the name of the user currently logged in to the DVR.

 - 8** **Network Information** – Displays whether a Remote User is logged in.

- 9 Remote User Display** – Displays the users connected to the DVR.

- 10 Instant Replay** – This button is a shortcut that instantly jumps into Search Mode and begins playing the video backwards.

- 11 Date/Time** – Displays the current time and date. This date and time is stamped into the recorded video and is displayed whenever the video is played back.

- 12 Sensor Status Bar** – Displays the Sensor status for each camera that is setup to use Sensors.

Control Output Status and Activation Bar – The Relay buttons fire the Output Relays. The Output Relays can be hooked up to external alarms, set to trigger an audio alarm, send a phone call, etc.

- 13 Screen Division Buttons** – The Screen Division buttons allow you to view one or more sets of cameras at a time.

KV-KLV4: The KV-KLR4 does not have any split screen display options. This is due to the fact that there are only 4 cameras. You may still view each camera separately full screen,

- 14 Full Screen** – Displays the video full screen.

- 15 Auto Sequence** – Pressing the Auto Sequence button sequences through the Screen Divisions sets. For Example, selecting the 1A and then the Loop button will sequence through 1A,2A,3A,4A and then repeat. This option is not available for the 7,10 and 13 screen divisions.

KV-KLV4: The Auto Sequence button works on the KV-KLR4 model by sequencing through individual cameras only.

3.4

Camera View

The Camera status for each camera is displayed next to the Camera number (or name) on the Video Display Area. The following are

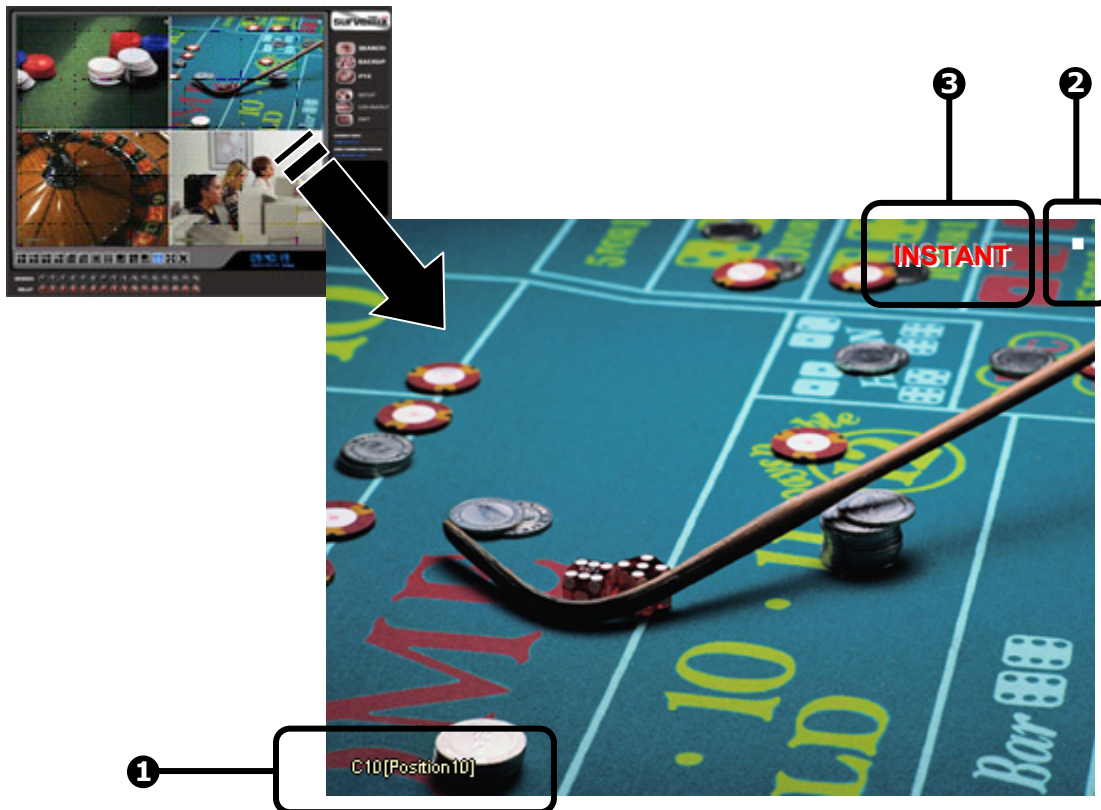

Figure 3.4



Figure 3.4

- | | |
|----------|---|
| 1 | Camera Number and Name – Displays the camera number and the custom name given to the camera. |
| 2 | Recording Status – Displays the current recording status of the camera using symbols. (See Section 3.5) |
| 3 | Special Recording – Displays text relating to the type of recording that is occurring. (See Section 3.5) |

3.5

Recording Status Indicator

The Camera status for each camera is displayed next to the Camera number (or name) on the Video Display Area. The following are the different states for each camera:

- | | |
|---|--|
|  | Recording – A red light is displayed when the camera is currently being recorded to the DVR unit. |
|  | Motion Detection – A green light is displayed when a camera (set up for motion detection) detects motion. |
| <input type="checkbox"/> | Display – This is displayed when the camera is currently not being recorded to the DVR unit. |

There are several different types of DVR 'Special Recording'. When this happens text is displayed on the camera indicating what kind it is. These are as follows:

SENSOR – Sensor is displayed when a sensor, associated with a given camera, is activated.

INSTANT – Instant Recording is a manual activation of the recording for the selected camera. Regardless of the recording method, Instant Recording will start the camera recording and also flag the video for future searches using the Index Search feature. INSTANT is displayed when a user activates the instant recording option. Double Right-Click to activate and deactivate the Instant Recording option.













3.6

Screen Division Menu

The Screen Division menu allows you to view cameras full screen by rotating one by one, four by four, eight by eight or by viewing four, eight or 16 at a time. The button options are shown below.

! **NOTE:** The following screen divisions are not available for all KV-KLR models. Each model, depending on the number of cameras, may vary slightly.

- | | |
|----------|--|
| 1 | 1st Four Cameras View – Displays cameras 1-8 in the Video Display Area. To return to a different Multi-Camera View, select a different Screen Division option from the Camera View Option. |
| 2 | 2nd Four Cameras View – Displays cameras 5-8 in the Video Display Area. To return to a different Multi-Camera View, select a different Screen Division option from the Camera View Option. |
| 3 | 3rd Four Cameras View – Displays cameras 9-12 in the Video Display Area. To return to a different Multi-Camera View, select a different Screen Division option from the Camera View Option. |
| 4 | 4th Four Cameras View – Displays cameras 13-16 in the Video Display Area. To return to a different Multi-Camera View, select a different Screen Division option from the Camera View Option. |
| 5 | 5rd Four Cameras View – Displays cameras 17-20 in the Video Display Area. To return to a different Multi-Camera View, select a different Screen Division option from the Screen Division menu. |

	6th Four Cameras View – Displays cameras 21-24 in the Video Display Area. To return to a different Multi-Camera View, select a different Screen Division option from the Screen Division menu.
	7rd Four Cameras View – Displays cameras 25-28 in the Video Display Area. To return to a different Multi-Camera View, select a different Screen Division option from the Screen Division menu.
	8th Four Cameras View – Displays cameras 29-32 in the Video Display Area. To return to a different Multi-Camera View, select a different Screen Division option from the Screen Division menu.
	1st Eight Cameras View – Displays cameras 1-9 in the Video Display Area. To return to a different Multi-Camera View, select a different Screen Division option from the Screen Division menu.
	2nd Eight Cameras View – Displays cameras 10-16,8,9 in the Video Display Area. To return to a different Multi-Camera View, select a different Screen Division option from the Screen Division menu.
	1st Sixteen Cameras View – Displays cameras 1-8 in the Video Display Area. To return to a different Multi-Camera View, select a different Screen Division option from the Screen Division menu.
	2nd Sixteen Camera View – Displays cameras 9-16 in the Video Display Area. To return to a different Multi-Camera View, select a different Screen Division option from the Screen Division menu.
	Multi-Camera View – Displays a group of cameras within the Video Display Area.
	Multi-Camera View – Displays a group of cameras within the Video Display Area.
	Multi-Camera View – Displays a group of cameras within the Video Display Area.
	Full Screen – The Full Screen Option allows you to view the Video Display Area using the entire viewable area on the monitor. When this is selected, no menu options are visible. You can activate the Full Screen Option by clicking on the Full Screen Button within the Screen Division Menu. You can deactivate Full Screen mode by right clicking on the screen.
	Loop – Pressing the Loop button rotates through the Screen Divisions.

CHAPTER 4

Setup Options

This chapter includes the following information:

- Setup Overview
- Channels
- Color
- Schedule
- Speed
- Motion Detect
- Password
- Pan/Tilt
- Audio

4.1 Setup Overview

The Setup options allow you to optimize your DVR unit by adjusting things like camera names, reboot schedules, recording schedules and more. It is extremely important that you setup your DVR correctly for several reasons.

- **Recording Schedules** – By optimizing the recording schedule you can increase the amount of pertinent recorded video that is saved on the DVR *and* keep it longer. You can optimize the type of recording done by adding motion detection to this as well, again increasing the amount of useful video.
- **DVR Access** – By setting up the access passwords you can tightly control the types of access an individual may have. This ensures the security and integrity of the DVR unit.
- **Camera Naming** – By naming each camera you can easily identify the location and any other pertinent information that may be helpful simply by viewing it on the Video Display Area.
- **Adjusting Camera Color** – By adjusting each camera's color settings you can optimize the clarity and detail that is recorded.

4.1.1 Setup Screen Overview

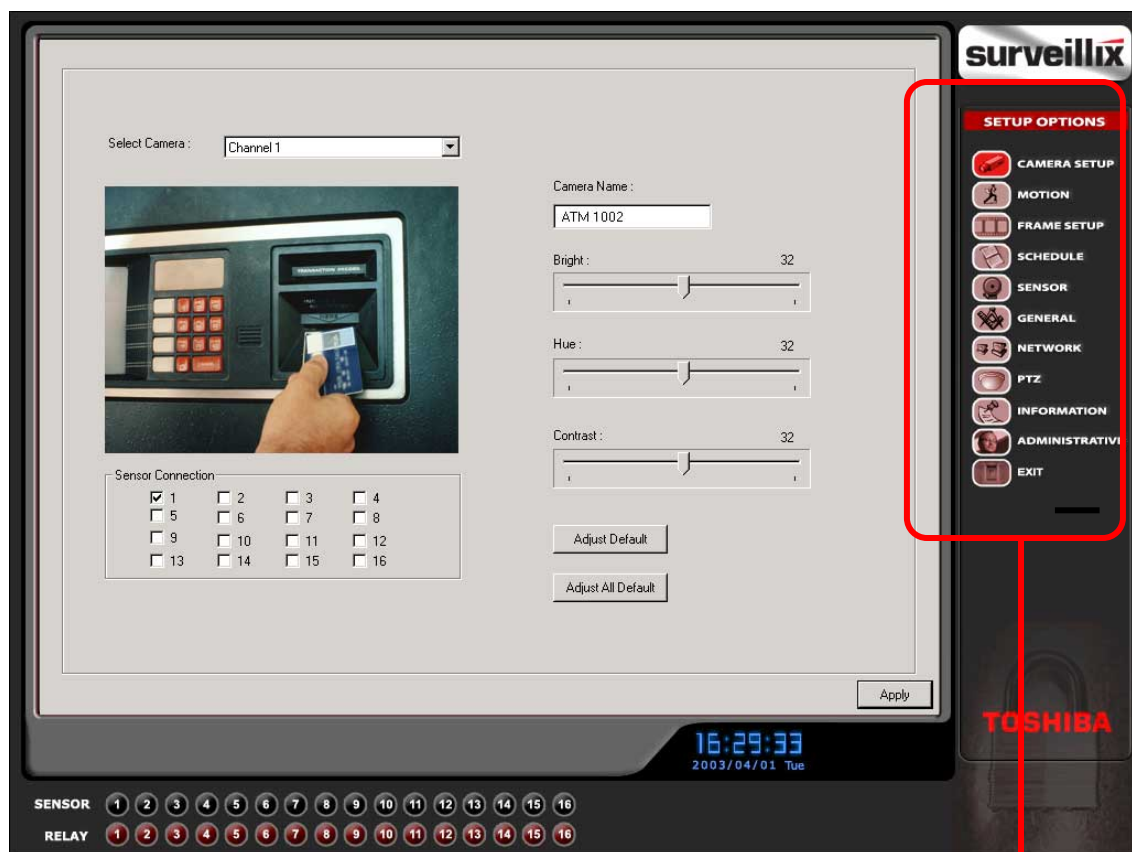

Figure 4.1.1
KV-KLR16 Shown

Figure 4.1.1

- 1 **Setup Options** – Allows you to toggle between different setup screens.

4.2

Camera Setup

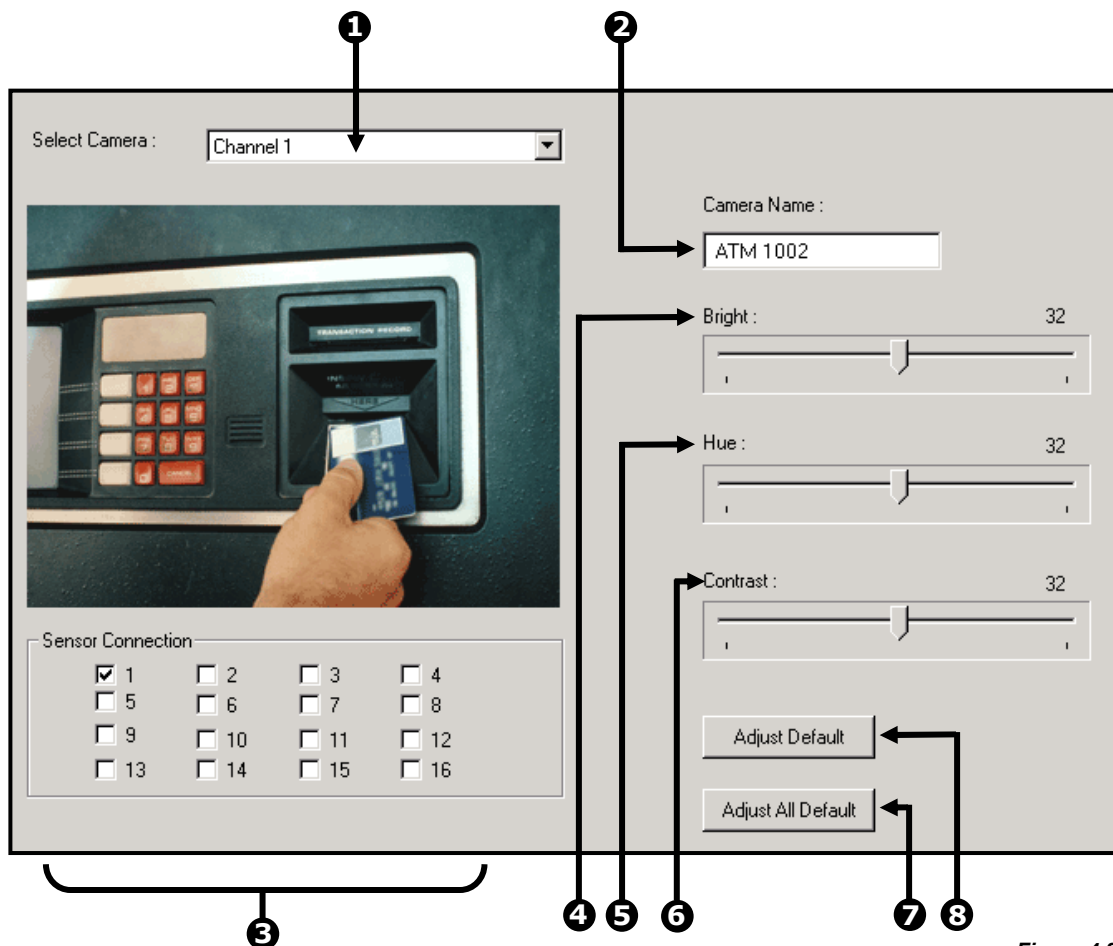

Figure 4.2
KV-KLR16 Shown

Figure 4.2

-
- 1** **Select Camera** – Selects the current camera to be edited.
-
- 2** **Camera Name** – Allows you to specify a name for each camera.
-
- 3** **Sensor Connections** – Allows you to attach one or more sensor connections to each camera. You can connect one or more Sensors to the selected camera by checking the box next to the sensor(s). Connecting a sensor to the camera allows you to activate both Standard Recording and Intensive Recording
-
- 4** **Bright** – Adjusts the Brightness of the selected camera.
-
- 5** **Hue** – Adjusts the Hue of the selected camera.
-
- 6** **Contrast** – Adjusts the Contrast of the selected camera.
-
- 7** **Adjust Default** – Adjust the color settings for the selected camera back to the System default.
-
- 8** **Adjust All Default** – Adjusts the color settings for ALL cameras to the System default.
-

4.3 Motion

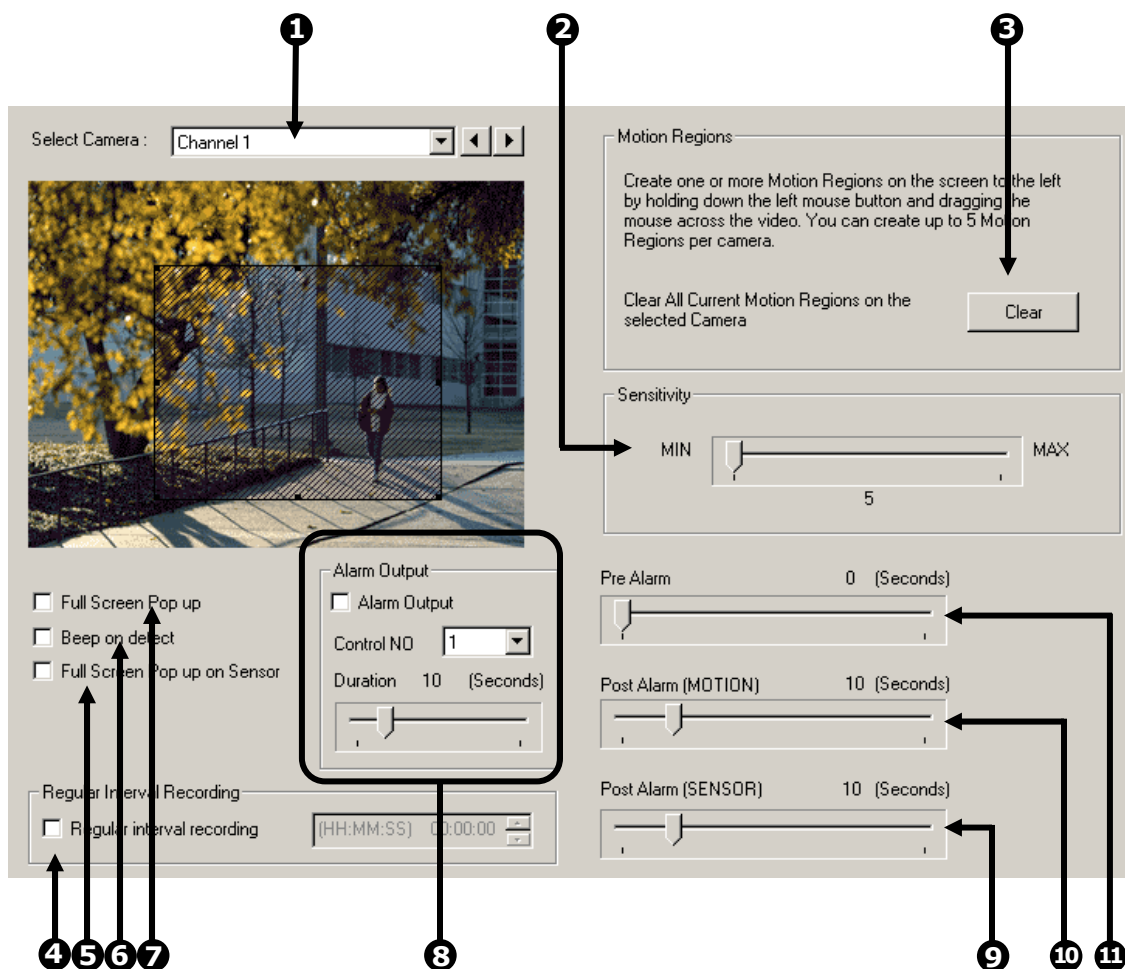

Figure 4.3

1. **Select Camera** – Selects the current camera to be edited.
2. **Sensitivity** – Adjusts the sensitivity within the designated Motion Areas.
3. **Clear** – Clears all Motion Areas for the selected camera.
4. **Regular Interval Recording** – This option allows you to record a single frame every few minutes or every few hours to show that the DVR is still functioning even when motion is not taking place. This option only works when Motion recording or Sensor recording is selected.
5. **Full Screen Pop-Up on Sensor** – When Sensor (alarm input) is detected, the camera will display full screen. The video will not automatically return to normal view. This option will require a user reset the screen to normal view.
6. **Beep on Detect** – When motion is detected, an internal speaker on the DVR will sound an alarm.
7. **Full Screen Pop-Up** – When Motion is detected, the camera is displayed full screen. The video will not automatically return to normal view. This option will require a user reset the screen to normal view.
8. **Alarm Output** – Allows you to activate a specified control output when Motion is detected.
9. **Post Alarm (SENSOR)** – Allows you to record video after a Sensor event has ceased for a specified period of time. This option will only work for cameras set to record from a Sensor Event.
10. **Post Alarm (MOTION)** – Allows you to record video after Motion has stopped for a specified period of time. This option will only work for cameras set to record using Motion Detection.
11. **Pre-Alarm** – Allows you to record a section of video just prior to Motion or Sensor activation.

4.3.1 Creating a Motion Area

Creating a Motion Area

- 1) Place the mouse pointer at the upper left hand corner of the area you want to designate, press and hold down the left mouse button, drag the mouse. Let go of the button when the Motion Area is the size you want it to be.
- 2) Continue creating as many Motion Areas as you wish. You can resize them and move them by dragging the sides and corners of the Motion Area.



Figure 4.2.2.1

4.3.2 Activating an Alarm Output on a Motion Event

Enabling Alarm Output on a Motion Event

- 1) From the Motion Setup window, select a camera to edit.
- 2) Configure the camera for Motion.
- 3) Check the Alarm Output box.
- 4) Select a Control Output to activate for the selected camera.
- 5) Select the duration you wish the Control Output to be activated for. When a Motion event occurs.

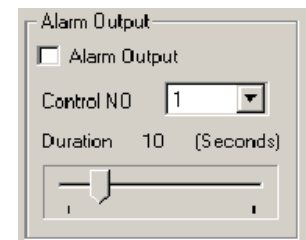

Figure 4.3.2

4.4 Frame Setup

The Frame Setup menu allows you to adjust both the resolution and the number of images per second each camera will record. The frames are adjusted in a structured manner. The DVR automatically detects the number camera inputs and then divides the total number of frames by these cameras. You may then adjust the FPS accordingly. For Example: If there are 3 cameras attached to a KV-KLR4 30 FPS DVR, each camera would receive the option of recording UP TO 10 FPS (30FPS divided by 3 cameras = 10FPS each). You cannot record 28FPS on one camera and 1 FPS on the other two cameras. This is due to the fact that the number of images displayed when viewing is directly tied to the number of images being recorded. In order to maintain a consistent look to the live view, this function was implemented.

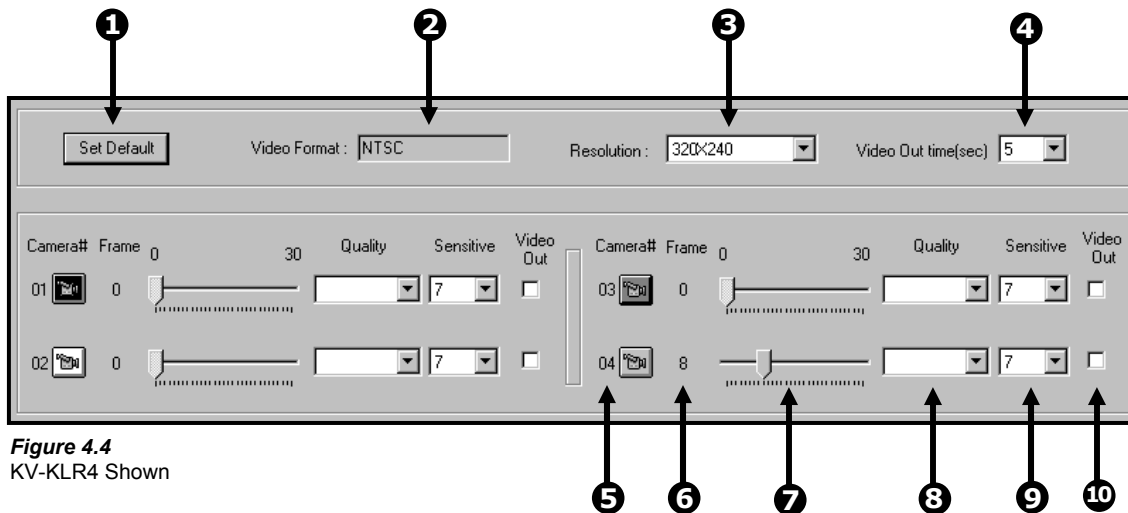

Figure 4.4
KV-KLR4 Shown

Figure 4.4

1. **Set Default** – Selecting this option resets all camera Frames and resolutions to the default settings.
2. **Video Format** – Displays the Video Format (NTSC/PAL).
3. **Resolution** – Displays the available Resolution options.
4. **Video Out Time (Seconds)** – Allows you to adjust the sequencing delay time when using the composite output.
5. **Camera Number** – The cameras are given different colors to help distinguish themselves when viewing the Frame Status. You can adjust the recorded Frames per Second by sliding the bar to the left and right.
6. **Number of Frames** – Displays the number of frames that are selected for each camera.
7. **Frame Select** – Adjusts the frames for each camera.
8. **Quality** – This setting affects the quality of the video. Increasing the quality of the camera can reduce the amount of pixilation within the image considerably, but also increases the file size.
9. **Sensitivity** – The Sensitivity adjusts the rate at which the Keyframe refreshes. This option directly affects the codec being used to record the video. Adjusting this setting can have drastic negative effects on the quality of the video. It is highly recommended that this setting always be left at the default setting unless so instructed by a system administrator.
10. **Video Out** – Allows you to select which cameras you want to send to the composite output.

4.5 Schedule Setup (Recording)

The Recording Schedule Window allows you to create different recording schedules based on the day, time, and type of recording you wish to use. In addition this window also contains the System Restart options that allow you to perform basic system maintenance by automatically scheduling the DVR to restart itself periodically

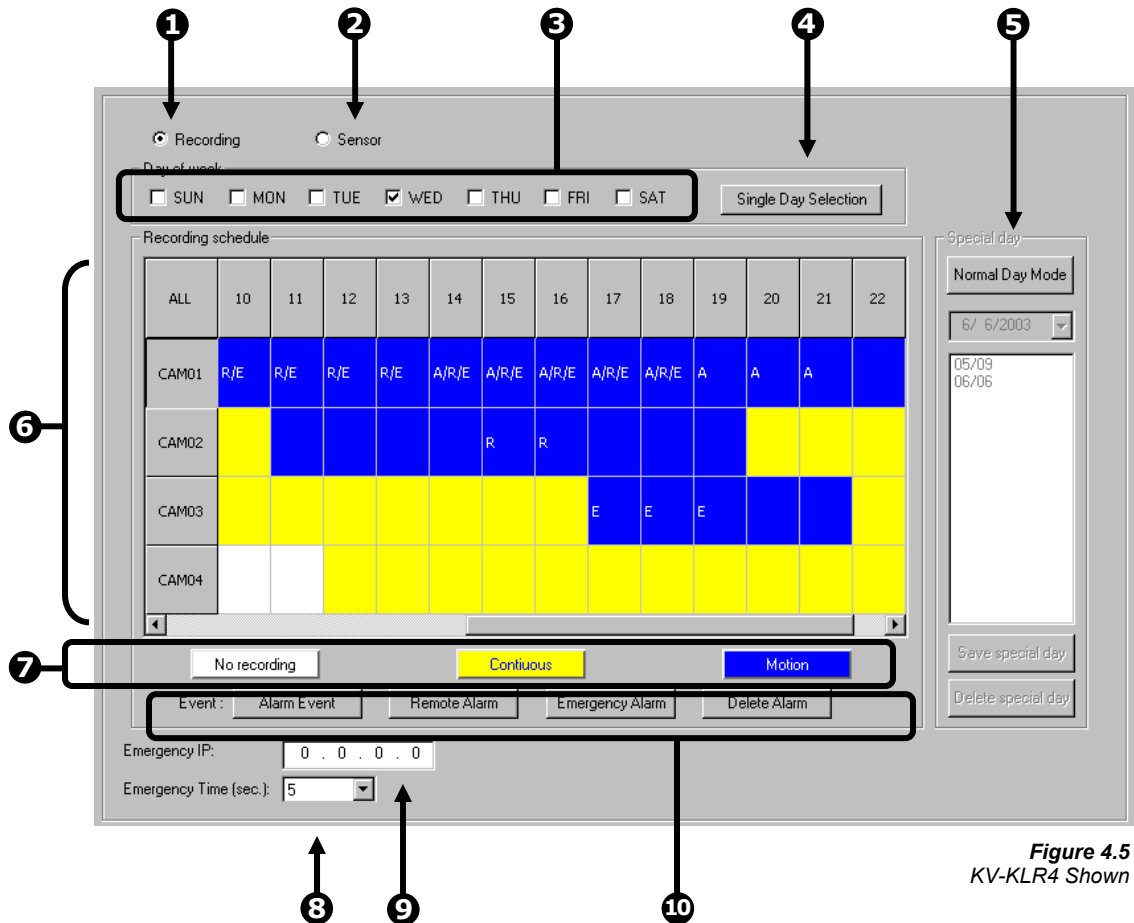

Figure 4.5
KV-KLR4 Shown

Figure 4.5

1. **Recording** – Toggles to the Recording Window (default).
2. **Sensor** – Toggles to the Sensor Window. This window allows you to create schedules for the sensors attached to the DVR.
3. **Day of the Week** – Selects the day of the week for the schedule being made.
4. **Single Selection Mode** – Selects all days of the week at once.
5. **Special Day Recording** – Allows you to create special recording schedules for specific days.
6. **Recording Schedule Window** – Displays and allows you to edit the current Recording Schedule.
7. **Recording Mode** – Selects the Recording Mode. The Recording Modes are 'NO RECORDING' 'CONTINUOUS RECORDING' and 'MOTION RECORDING'.
8. **Emergency Time** – Specifies the amount of time (in seconds) to transmit the video in the Emergency Agent Software.
9. **Emergency IP** – Specifies the IP Address to the send the Emergency Agent video to.
10. **Event** – Allows you to define Motion as an Alarm Event, whether to transfer the Alarm Event to the SMS Multi-site Software, and/or whether to send the video to the Emergency Agent software.

4.5.1 Schedule Setup (Sensor)

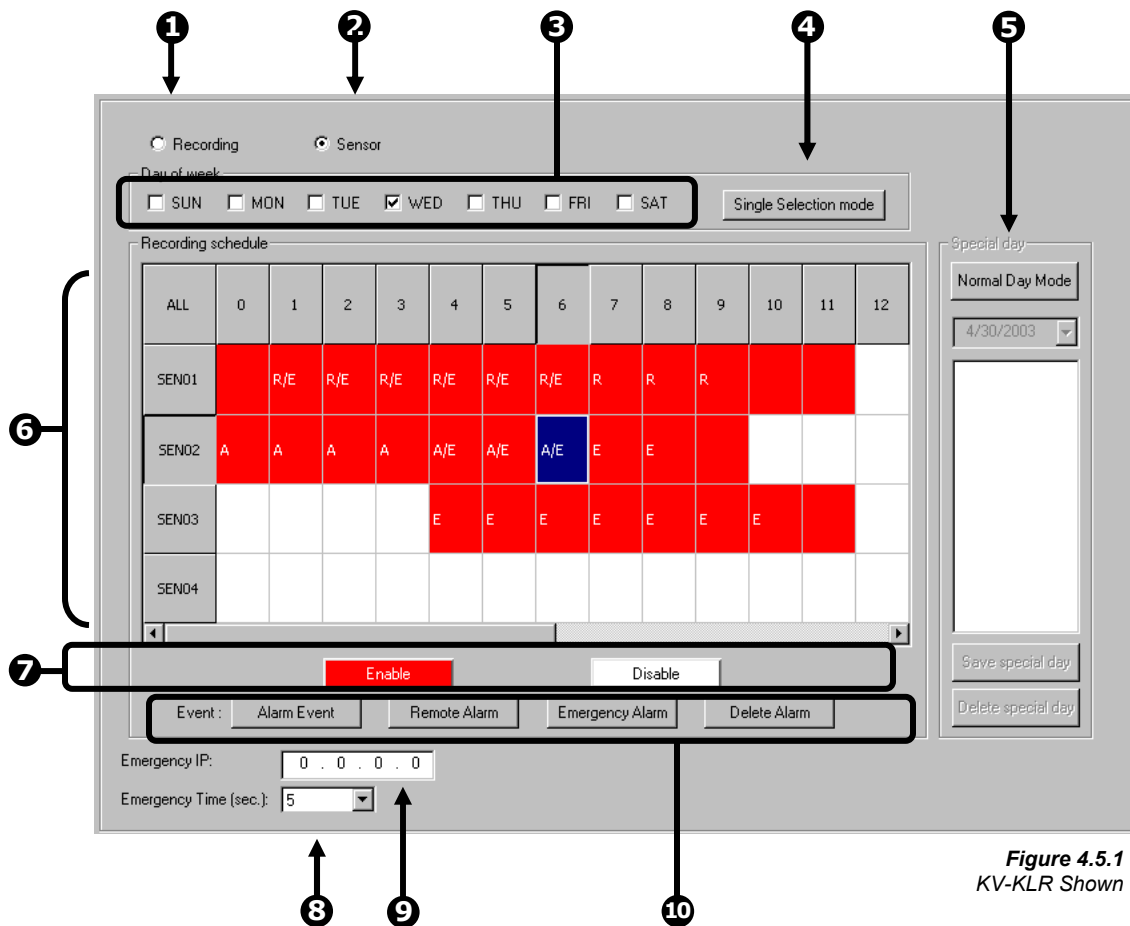

Figure 4.5.1
KV-KLR Shown

Figure 4.5.1

1. **Recording** – Toggles to the Recording Window (default).
2. **Sensor** – Toggles to the Sensor Window. This window allows you to create schedules for the sensors attached to the DVR.
3. **Day of the Week** – Selects the day of the week for the schedule being made.
4. **Single Selection Mode** – Selects all days of the week at once.
5. **Special Day Recording** – Allows you to create special recording schedules for specific days.
6. **Recording Schedule Window** – Displays and allows you to edit the current Recording Schedule.
7. **Enable/Disable** – Enabled the selected Sensor for the time period specified.
8. **Emergency Time** – Specifies the amount of time (in seconds) to transmit the video in the Emergency Agent Software.
9. **Emergency IP** – Specifies the IP Address to the send the Emergency Agent video to.
10. **Event** – Allows you to define Motion as an Alarm Event, whether to transfer the Alarm Event to the SMS Multi-site Software, and/or whether to send the video to the Emergency Agent software.

4.5.2 **Creating a Recording Schedule (Motion and Continuous)**

Creating a Recording Schedule Based on Motion & Cont

- 1) Select the Schedule Menu option.
- 2) Select a single day to begin creating the schedule for -or- Select the SINGLE SELECTION MODE button to create the schedule for all the days of the week at once.
- 3) Highlight the time-blocks within the Recording Schedule Window for the camera(s) you wish to schedule. Once the desired Time-Blocks are highlighted, press a RECORDING MODE button.
The Time-Blocks should now appear Blue for Motion, Yellow for Continuous and White for No Recording.

4.5.3 **Creating a Recording Schedule (Sensor)**

Creating a Recording Schedule Based on a Sensor Alarm

- 1) Select the Schedule Menu option and press the SENSOR button. This will open the Sensor Recording Schedule Window.
- 2) Select a single day to begin creating the schedule for -or- Select the SINGLE SELECTION MODE button to create the schedule for all the days of the week at once.
- 3) Highlight the time-blocks within the Recording Schedule Window for the Sensor(s) you wish to enable and schedule. Once the desired Time-Blocks are highlighted, press the ENABLE button.
The Time-Blocks should now appear Red.

The Sensors will supercede all other types of recording modes (MOTION, CONTINUOUS, NO RECORDING). This means that regardless of what the cameras are currently set to, if a Sensor Event occurs and it is linked to one or more cameras, the linked cameras will begin recording as a Sensor Event. Sensor Recordings will be 'flagged' and will be easily searchable using the Index Search Mode option.

You can associate cameras to Sensors inside the CAMERA SETUP menu.

4.5.4 Scheduling Alarm Events

You can designate Motion or Sensor Events to be 'Alarm' events. Often times you may not want motion to be treated as an Alarm event. For Example: During work hours Motion that occurs is expected and would not want to be treated as an Alarm. However, after business hours are over, any motion that occurs should be treated as an Alarm.

There are three different types of Alarm Events:

ALARM EVENT:	This option logs the Alarm Events on the local server.
CENTRAL STATION:	This option sends the Alarm Events to Central Station software.
EMERGENCY AGENT:	This option sends the Alarm Event to the Emergency Agent software.

Scheduling Alarm Events (MOTION)

- 1) Select the Schedule Menu option. (Select either RECORDING or SENSOR)
- 2) Highlight any schedule that has been set to MOTION (or SENSOR) and press one of the EVENT button (ALARM EVENT, CENTRAL STATION, EMERGENCY AGENT). A letter should now be placed within the select time.

4.5.5 Scheduling Alarm Events to send video to the Emergency Agent

You can designate Motion or Sensor Events to send video from Alarm Events to the Emergency Agent software.

Scheduling Alarm Events to send video to the Emergency Agent Software

- 1) Enable an Emergency Agent Event (See SCHEDULING ALARM EVENTS).
- 2) Enter an IP address to send the video to into the IP ADDRESS field. (Only one IP address is supported)
- 3) Enter the duration inside the EMERGENCY TIME field.

See the EMERGENCY AGENT chapter for detailed information on setting up the Emergency Agent software.

4.5.6 Special Day Schedule

You can create days that have a unique recording schedule. You may wish to create these on days that are 'not typical' such as Holidays, Special Events, etc.

Figure 4.5.6

- 1** **Special Day (Enter/Exit Edit Mode)** – Enters / Exits the Special Day Mode. Once in Special Day Mode you can create, edit and delete Special Days.
- 2** **Calendar** – Displays the current day in a red circle.
- 3** **Special Day Schedules** – Displays the current saved.
- 4** **Save Special Day** – Saves the selected Special Day Schedule.
- 5** **Delete Special Day** – Deletes the selected Special Day Schedule.

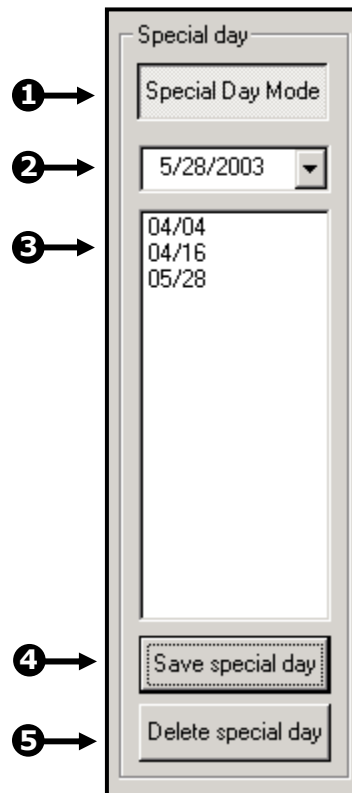

Figure 4.5.6
Special Day

4.5.7 Creating and Editing a 'Special Day' Schedule

Creating a 'Special Day' Schedule

- 1) Press the 'NORMAL DAY MODE' button to enable the 'SPECIAL DAY MODE'.
- 2) Select a day from the calendar by clicking on the CALENDAR drop down list.
- 3) Highlight the time-blocks within the Recording Schedule Window for the camera(s) you wish to schedule. Once the desired Time-Blocks are highlighted, press a RECORDING MODE button.
- 4) When you have finished creating the schedule press the 'SAVE SPECIAL DAY' button. The special day should now appear as a date within the Special Day Schedules.

Deleting a 'Special Day' Schedule

- 5) Select a Special Day from the Special Day Schedules List and press the 'DELETE SPECIAL DAY' button.

4.6 Sensor

The Sensor Window allows you to enable, disable and configure Sensors.

The figure shows a configuration window for sensors. It contains a table with four columns: Sensor, Type, Delay(sec), and Relay. There are four rows of sensor configurations. Above the table, three numbered arrows point to the Type, Delay, and Relay columns respectively.

Sensor	Type	Delay(sec)	Relay
01	<input checked="" type="checkbox"/> NO	5	1
02	<input checked="" type="checkbox"/> NO	5	2
03	<input checked="" type="checkbox"/> NO	5	3
04	<input checked="" type="checkbox"/> NO	5	4

Figure 4.6
Sensor

Figure 4.6

-
- 1** **Type** – Selects whether the Sensor will be Normally Open (NO) or Normally Closed (NC).
 - 2** **Delay (sec)** – Adjusts the amount of time (in seconds) to ignore the sensor if it is continuously activated.
 - 3** **Relay** – Selects the Control Output to activate once the Sensor has been tripped.
-

4.7

General

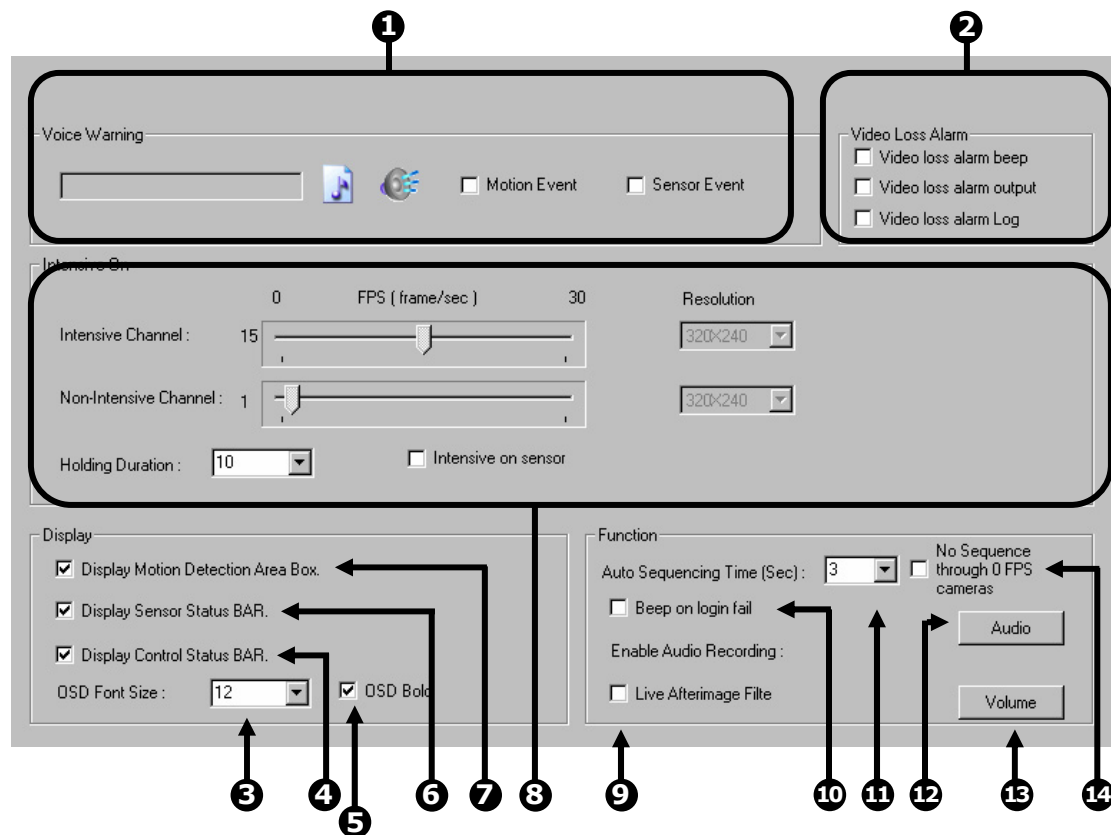

Figure 4.7

1. **Voice Warning** Allows you to use an audible warning (.wav Sound Clip) for when Motion or Sensors are activated.
2. **Video Loss Detection** These options allow video loss to be designated as an alarm.
3. **OSD Font Size** This option allows you to adjust the On Screen Display Font size for cameras.
4. **Display Control Status Bar** Enables/Disables Control Status Bar on the Main Display Screen.
5. **OSD Bold** This option makes the OSD Font Bold.
6. **Display Sensor Status BAR** Enables/Disables the Sensor Status Bar on the Main Display Screen. (See section 3.3).
7. **Display Motion Detection Area Box** Displays the Motion area box on the Main Screen whenever motion occurs.
8. **Intensive Recording** The Intensive Recording option increases the FPS recording of a cameras that is experiencing an alarm event.
9. **Live After Image Filter** When recording at 720 x 480 if digital blur occurs selecting this option may remedy the problem. For more information on this reference the Afterimage section in this manual.
10. **Beep on Log-in fail** – This option activates an audio alarm when a user enters incorrect login information 3 times.
11. **Auto Sequencing Time (sec)** When the Loop button is activated, the Auto Sequencing Time specifies the amount of time that elapses before switching to the next Screen Division group.
12. **Audio** Opens the Audio ENABLE/DISABLE options.
13. **Volume** – Opens the Volume controls that affect the Audio Recording levels.
14. **No Sequencing though 0 FPS Cameras** – Does not sequence through cameras that have 0 FPS specified.

4.7.1 Voice Warning

The DVR unit allows you to play a sound file when either a Motion event or Sensor event occur. This file can be a custom created sound file that is unique to your application. The selected WAV file is played through speakers attached to the DVR unit.

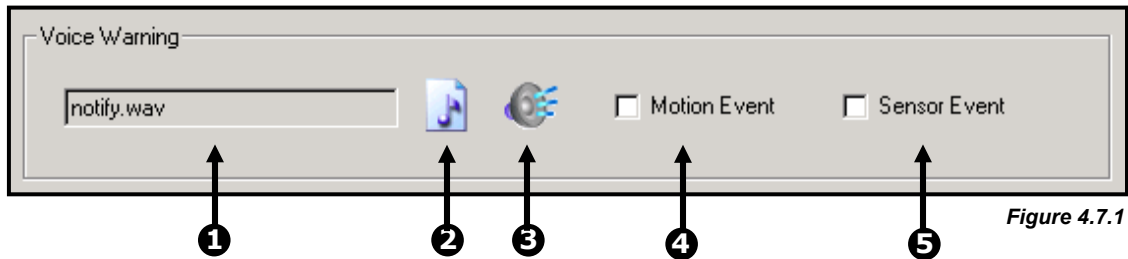

Figure 4.7.1

Figure 4.7.1

- 1** **Display File to Use** – Displays the Audio file that will be used during the Voice Warning Event.
- 2** **Open** – Allows you to select the location of the WAV file to use. Note – Only WAV files are supported.
- 3** **Play Selected WAV** – Plays the selected WAV file.
- 4** **Motion Event** – Enables the Voice Warning on Motion Events.
- 5** **Sensor Event** – Enables the Voice Warning on Sensor Events

4.7.2 Video Loss Alarm

The DVR supports a Video Loss Alarm function which allows an Alarm Event to occur when a camera loses signal. The lost signal can be due to Power failure to the camera, the camera cable being cut or unplugged, or the camera being damaged in some way.

In order to use Video Signal Loss detection, cameras must either be turned 'ON' or 'OFF'. This is because the DVR needs to know which cameras it should expect to receive signals from. To turn camera(s) 'ON', open FRAME SETUP, and set the Frames Per Second to anything above zero. By designating zero frames per second you are essentially saying that the camera is not going to be used by the DVR.

Figure 4.7.2

- 1** **Video Loss Alarm Beep** – When Video Loss occurs an internal speaker on the DVR will sound an alarm.
- 2** **Video Loss Alarm Output** – When Video Loss occurs, the Alarm Output is activated.
- 3** **Video Loss Alarm Log** – Records the Video Loss Alarm events to the Log Files.

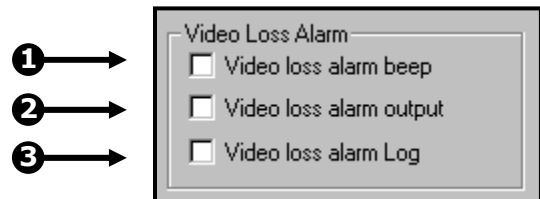

Figure 4.7.2

4.7.3 Intensive Recording Overview

The Intensive Recording Option allows you to increase the Pictures Per Second of a camera during an alarm event. When the intensive recording is activated, the resolution of the remaining cameras is immediately reduced to 320x240. This is done to guarantee that the Pictures Per Second and Resolution will not exceed the DVR limitation during the increased frame rate recording.

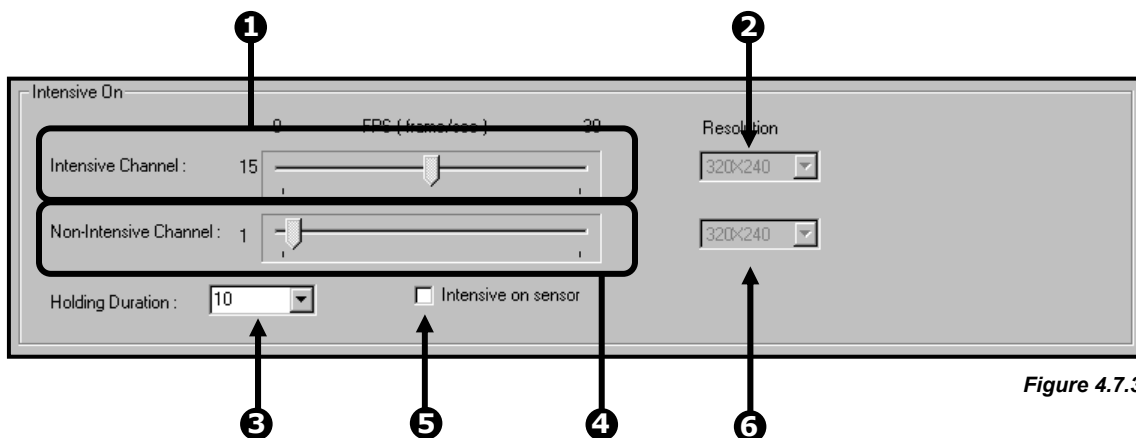

Figure 4.7.3

Figure 4.7.3

- | | |
|----------|---|
| 1 | Intensive Channel – Increases the frame rate to the maximum number frames per second allowed per each channel. |
| 2 | Intensive Channel Resolution – Adjusts the Resolution for the Intensive Channel. |
| 3 | Holding Duration – Adjusts the amount of time to hold the Intensive Recording active. |
| 4 | Non-Intensive Channel – Adjusts the Frame Rates for the Non-intensive Channels (the channels will drop their current settings and be forced to use this setting) |
| 5 | Intensive On-Sensor – This setting enables the association of Intensive Recording to sensors. |
| 6 | Non-Intensive Channel Resolution –The DVR automatically adjusts the Non-Intensive Channels down to the system default. This setting cannot be changed. |

4.7.4 Intensive Recording

The Intensive Recording option is setup as an 'All or Nothing'. This means that once enabled (associated with sensors), all cameras that are associated with sensors will activate the Intensive Recording.

To activate the Intensive Recording option, follow these steps.

Activating Intensive Recording

- 1) Inside Setup, select the camera you wish to use and then enable the appropriate sensor you wish to associate to it.
- 2) Open the Intensive Recording Options. Enable the Intensive-On-Sensor option. You can also adjust the holding duration for the Intensive Channel.

- 3) Save the Intensive Recording settings by selecting the APPLY button.
- 4) Open the Schedule Menu and press the SENSOR button to open the Sensor Schedule window.
- 5) Enable the sensor you associated with the Intensive Recording by creating a schedule for it.
- 6) Press the APPLY button and exit out of setup

4.7.5 Audio

The Surveillix KV-KLR DVR is capable of recording up to 2 channels of audio.

AUDIO FEATURES:

- 8000 Hz playback in Live Mode
- Audio input level should be 1 Vpp
- Up to 48000 Hz playback in search mode
- Mono Sampling
- Line-In type (Requires Amplification)

DATA SIZE (Per channel)

- 1 Second: 1625 bytes
- 1 Minute: 97,500 bytes
- 10 Minutes: 975,000 bytes
- 1 Hour: 5,850,000 bytes
- 1 Day: 140,400,000 bytes (Approx 140MB)

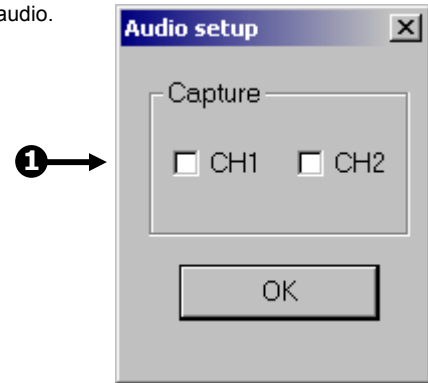

Figure 4.7.5
Audio

Figure 4.15

- 1** Audio Enable/Disable – Enables the audio recording.

Since there is no way to create a schedule for audio recording, when audio is enabled, the audio will record continuously.

4.7.5.1 Attaching the Audio Adapter

The Audio adapter is attached to the LINE-IN on the motherboard. Once attached, there are two RCA inputs available for use.

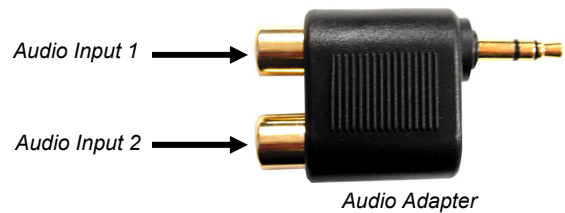

KV-KLR4

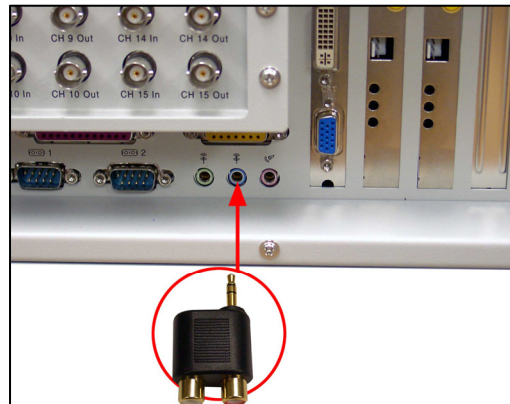

KV-KLR8 and KV-KLR16

4.8 Network (Setup for Remote Connections)

The Network Setup allows you to adjust settings such as Ports, IDVR Access.

The screenshot shows the Network Setup configuration page with the following settings and callouts:

- 1**: Disable Remote Control
- 2**: Quality: NORMAL
- 3**: Resolution: 360*240
- 4**: TimeOut Value: 60
- 5**: Emergency Port: 4001 (1024 - 5000)
- 6**: Center Port: 4000 (1024 - 5000)
- 7**: Image Port: 4002 (1024 - 5000)
- 8**: Search Port: 4003 (1024 - 5000)
- 9**: Web Function: Web Viewer(iDVR), iDVR Port: 4004
- 10**: View IP address button
- 11**: Transport Rate: 100
- 12**: PPP Setup(Emergency): Use PPP, Password, Confirm, Phone Number, Modem Select: N/A
- 13**: Two-way Audio Communication: Enable Audio Communication, Audio Port: 3002

Figure 4.8
Network Setup

Figure 4.8

- | | |
|----------|---|
| 1 | Disable Remote Control – This setting enables or disables access to the DVR from remote connections. |
| 2 | Quality – Adjusts the resolution quality when transferring video to a remote client. |
| 3 | Resolution – Adjusts the resolution of the images being sent to remote clients. By setting the resolution low, the images will be sent faster, however, the image quality will be reduced considerably. |
| 4 | Time Out Value – When a user attempts to connect to the DVR and the connection does not succeed during the timeout period designated, the connection will be terminated. |
| 5 | Emergency Port – The Emergency Port is the port used to connect with the Emergency Agent software. If connecting through a firewall, this port must be opened to incoming and outgoing traffic. |
| 6 | Center Port – The Center Port is the port used to connect to the Remote Software. This is the Port that must be specified inside the Remote software to connect to the DVR. If connecting through a firewall, this port must be opened to incoming and outgoing traffic. |

-
- 7 Image Port** – The Image Port is the port used to transfer the video to the Remote Software. If connecting through a firewall, this port must be opened to incoming and outgoing traffic.

 - 8 Search Port** – The Search Port is the port used to transfer the Search information to the Remote Software. If connecting through a firewall, this port must be opened to incoming and outgoing traffic.

 - 9 Web Function** – Enables the use of the IDVR Web interface as well as defines users who can access it.

 - 10 View IP Address** – This option allows you to view the IP configuration of the DVR.

 - 11 Transport Rate** – This option is used to throttle the bandwidth on the DVR. This option is based on percentages of images sent across.

 - 12 PPP Setup (Emergency)** – Defines the modem and PPP information to dial to a remote client when the an Emergency Agent Event is activated.

 - 13 Two Way Audio** – This option enables the two-way audio functionality and allows you to specify which port the connection will use.
-

4.8.1 Two-Way Audio

The Two-Way Audio feature allows a computer running the Remote software to connect to a DVR and communicate to each other. This feature requires a Microphone and a Speaker at both the Remote side and Server side.

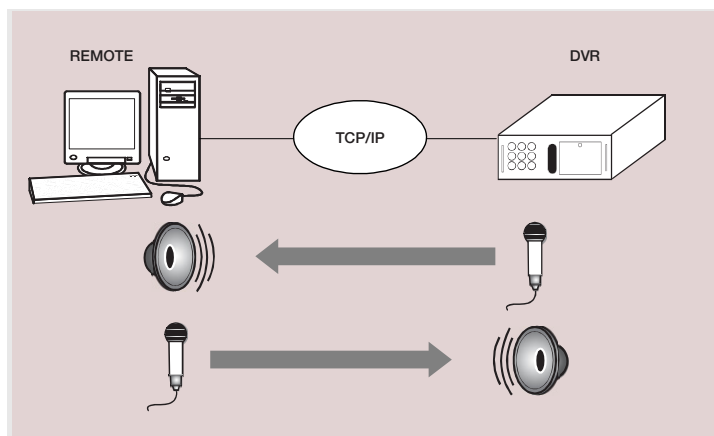

The remote client always initiates the connection. The DVR sits waiting for a request from the remote.

Enabling 2-Way Audio

-
- 1) Enable the 'ENABLE AUDIO CONNECTION' checkbox inside SETUP>NETWORK.
-

Activating a 2-Way Audio Connection (from the Remote Software)

If you are running this feature for the first time see ACTIVATING A 2-WAY AUDIO CONNECTION FOR THE FIRST TIME following this section.

-
- 1) Press the 2 WAY AUDIO button from the main screen.



- 2) If you are running this feature for the first time see the ACTIVATING A 2-WAY AUDIO CONNECTION FOR THE FIRST TIME section following this section.

- 3) Press the DISCONNECT button to Disconnect the 2-Way Audio.



Activating a 2-Way Audio Connection For The First Time

If you are running this for the first time you may see a setup window. This will walk you through setting up your audio and adjusting volume levels.

- 1) Press NEXT when the WELCOME TO THE SOUND HARDWARE TEST WIZARD window appears.



- 2) Press next when the hardware test has completed.

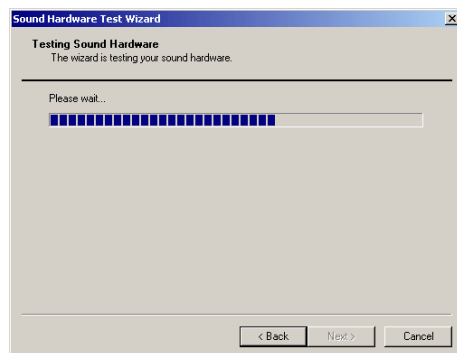

- 3) Make sure the microphone is plugged in and follow the onscreen directions. Press NEXT when finished.

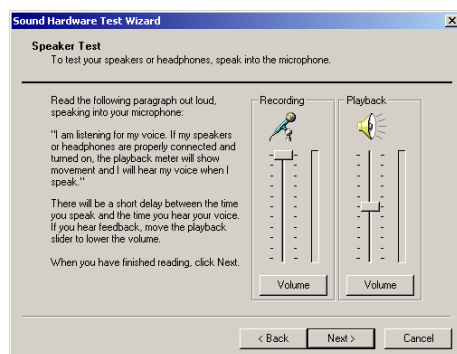

4) Press FINISH to complete the setup. The software is now ready to connect to a DVR.



4.9 PTZ Setup

Refer to the PTZ chapter in this manual.

4.10 Information

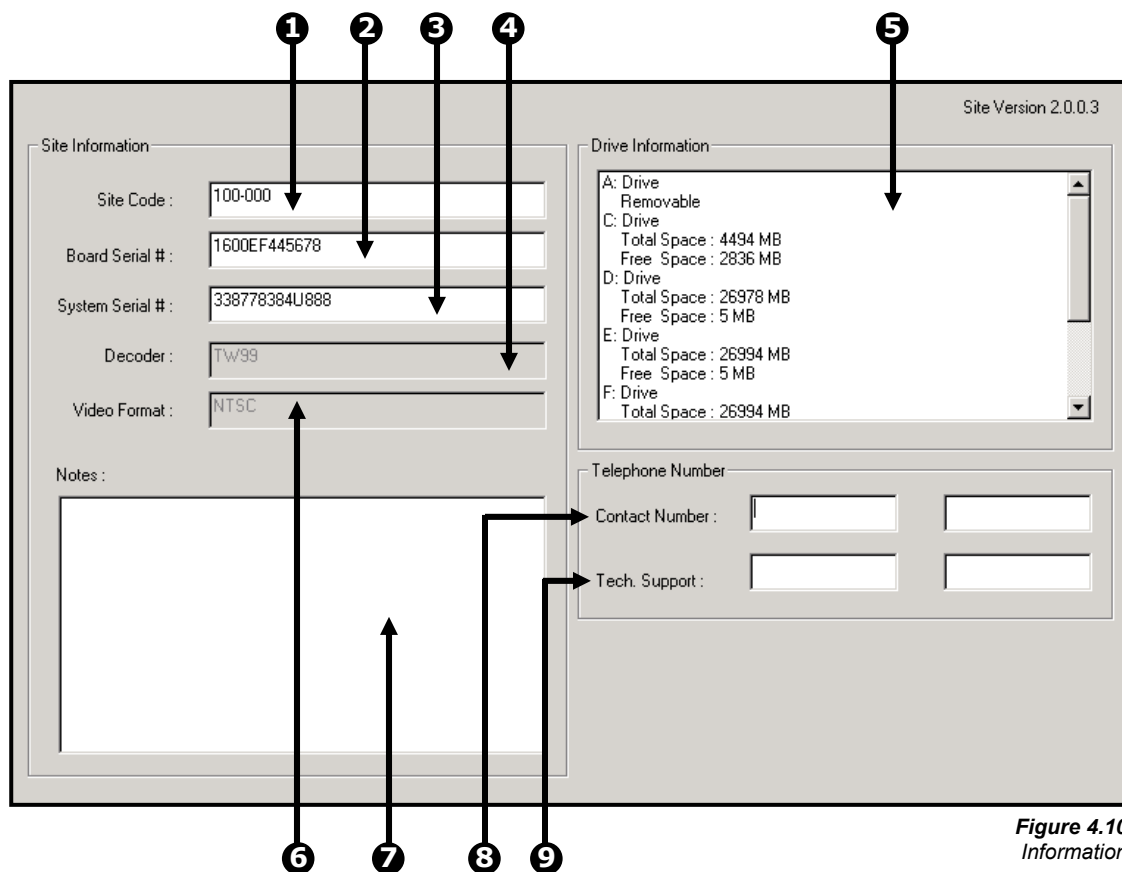

Figure 4.10
Information

Figure 4.10

-
- 1** **Site Code** – A user-specified unique identification name that is used by other DVR software to connect to the DVR. (Remote, Emergency Agent, NDMS).

 - 2** **Board Serial Number** – Displays the Serial Number of an internal hardware component of the DVR.

 - 3** **System Serial Number** – Displays the Serial Number of the DVR.

 - 4** **Decoder** – Displays decoder information.

 - 5** **Drive Information** – Displays the Total Space and Free Space of the Drives installed in the DVR.

 - 6** **Video Format** – Displays the Video Format of the DVR (NTSC or PAL).

 - 7** **Notes** – This is a place to type in any notes you may want to make about the DVR.

8 **Contact Number** – Displays a user specified Contact Phone Number.

9 **Tech Support** – Displays the Tech Support Phone Number.

4.11 Administrative

The Administrative option contains Use Management and the Log Viewer. The Log Viewer displays detailed information about the DVR, including Shut Down / Restart information, User Logins and Recording problems and failures. This can be a valuable tool to Administrators.

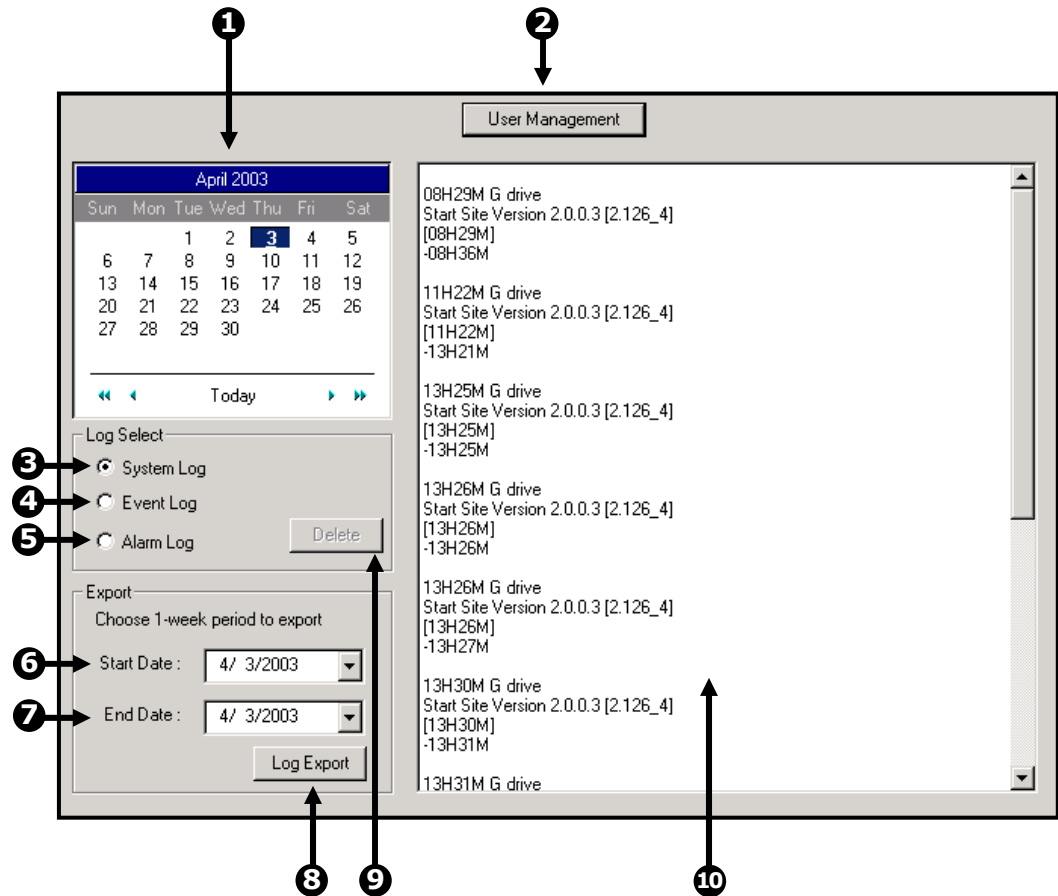

Figure 4.11

1 **Calendar** – Displays the days with Log information in a bold format.

2 **User Management** – This option opens the User Management Window. User Management allows you to create, edit and delete DVR user accounts.

3 **System Log** – Displays the Hardware Log file information which includes Scan Disks, and system recording successes and failures.

4 **Event Log** – Displays information pertaining to User Logins, DVR reboots and other related information.

5 **Alarm Log** – Displays information pertaining to Alarm Events.

6 **Start Date** – Specifies a date to begin the Log Export function.

7 **End Date** – Specifies a date to end the Log Export function..

- 8** **Log Export** – Allows the log files to be exported in week increments.
- 9** **Delete** – This option deletes the selected Log Files.
- 10** **Log Display Window** – Displays the Log Files of the selected day.

4.11.1 User Management

The User Management Console allows you to create, edit, and delete user accounts. Each user account can be assigned different privileges that limit their usage of the DVR system. Users can be given administrator privileges by enabling all rights, however only the true administrator account can log into the User management Console.

Figure 4.11.1

- 1** **User Information** – Enter the User Information, and Password.
- 2** **Permission** – Allows you to specify the types of permissions a user may perform on the DVR.
- 3** **Hidden Camera** – The Hidden Camera feature allows an administrator to hide certain cameras from a user. The user will not be able to view the cameras in Live Mode.

NOTE: Every DVR comes with an Administrative account and Default account loaded on them. The Default account should not be used as the primary account. Upon a reboot of the unit for any reason the Default account will automatically be loaded. For applications where maximum security is essential, it is recommended that all privileges be stripped from the Default user account and all cameras be set to Forbidden.

Figure 4.11.1

4.11.2 User Rank

The User Ranking structure allows the option to assign a privilege system (1-10 where one has the most rights) to users of the DVR. For example. Since only one user is allowed to use the PTZ controls at any one time, an administrator with a higher rank can kick another user out and take control of the PTZ.

The User Rank option affects:

SETUP ACCESS	Each DVR can only have 1 user accessing Setup at any given time. A user with a higher rank will kick another user out and then open Setup.
PTZ CONTROL	Each DVR can only have 1 user using the PTZ controls at any given time. A user with a higher rank will kick another user out and then open the PTZ controls.

4.11.3 Changing the Administrator Password

Changing the Administrator Password

- 1) Inside Setup, open the user management console. An administrator login will appear with a 'Change Password' button near the bottom right
- 2) Select the button, enter the new password and press OK to finish.

4.12 Instant Recording

Instant Recording is a feature that allows manual starting of a camera recording, superseding the current schedule. When Instant Recording is activated on a camera it also flags the specified video so that an Index Search can be performed at a later date to bring up all the Instant Recording instances.

This can be used, for example, when a suspicious object or person is being recorded and you want to flag that section of video for easy retrieval at a later date.

Activate Instant Recording

- 1) 1. From the Live View screen, double right-click on the camera on which to enable instant recording. An INSTANT label will be placed on the upper right corner of the video.
- 2) To turn the Instant Recording option OFF, double right-click the video a second time.

Searching 'Instant Record' Video

1. Enter the Search Mode, press the INDEX SEARCH button, and then select the INSTANT RECORDING option.

4.13 Adjusting the Time and Date

To adjust the Time and Date follow these steps:

- 3) Begin by exiting to Windows. Do this by pressing the EXIT button from the Main Display Screen and selecting Restart in Windows Mode. (See Section 3.3)
- 4) Open Windows Explorer. Do this by right-clicking on the My Computer Icon (located on the top left hand corner of the Desktop) and select Explore.
- 5) Double click on CONTROL PANEL to open it. If you do not see CONTROL PANEL listed, double-click MY COMPUTER to expand the folder tree.
- 6) Double Click on DATE/TIME inside Control Panel. (See Figure 4.10a)
- 7) Adjust the Date and Time.
- 8) When finished, close all open windows and restart the DVR unit. DO this by pressing the START button (Located on the lower left hand side of the Desktop) and selecting SHUT DOWN.

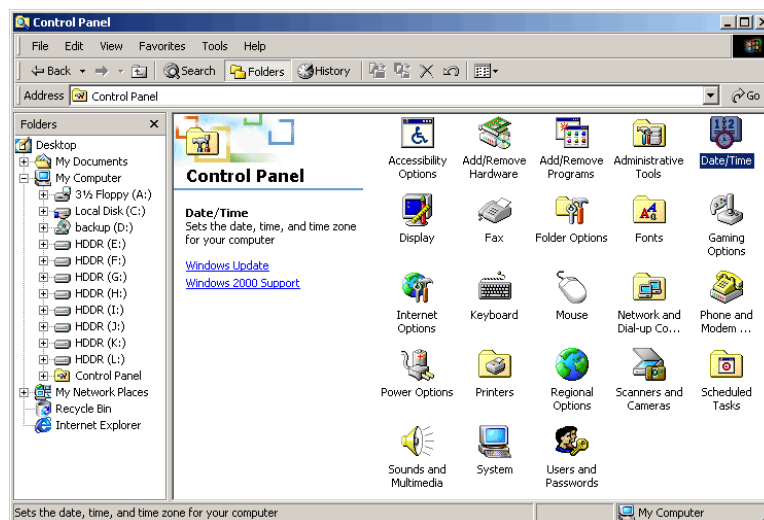

CHAPTER 5

Search Options

This chapter includes the following information:

- Setup Overview
- Channels
- Color
- Schedule
- Speed
- Motion Detect
- Password
- Pan/Tilt
- Quit to Explorer

5.1 Search Overview

The DVR unit has several options that allow you to easily search through, and find, a particular section of video. From Motion indexing and Sensor indexing to calendar views showing which days have recorded video, the DVR unit is equipped to help you quickly find what you're looking for.

The following chapter will describe in detail how to use the DVR Search features.

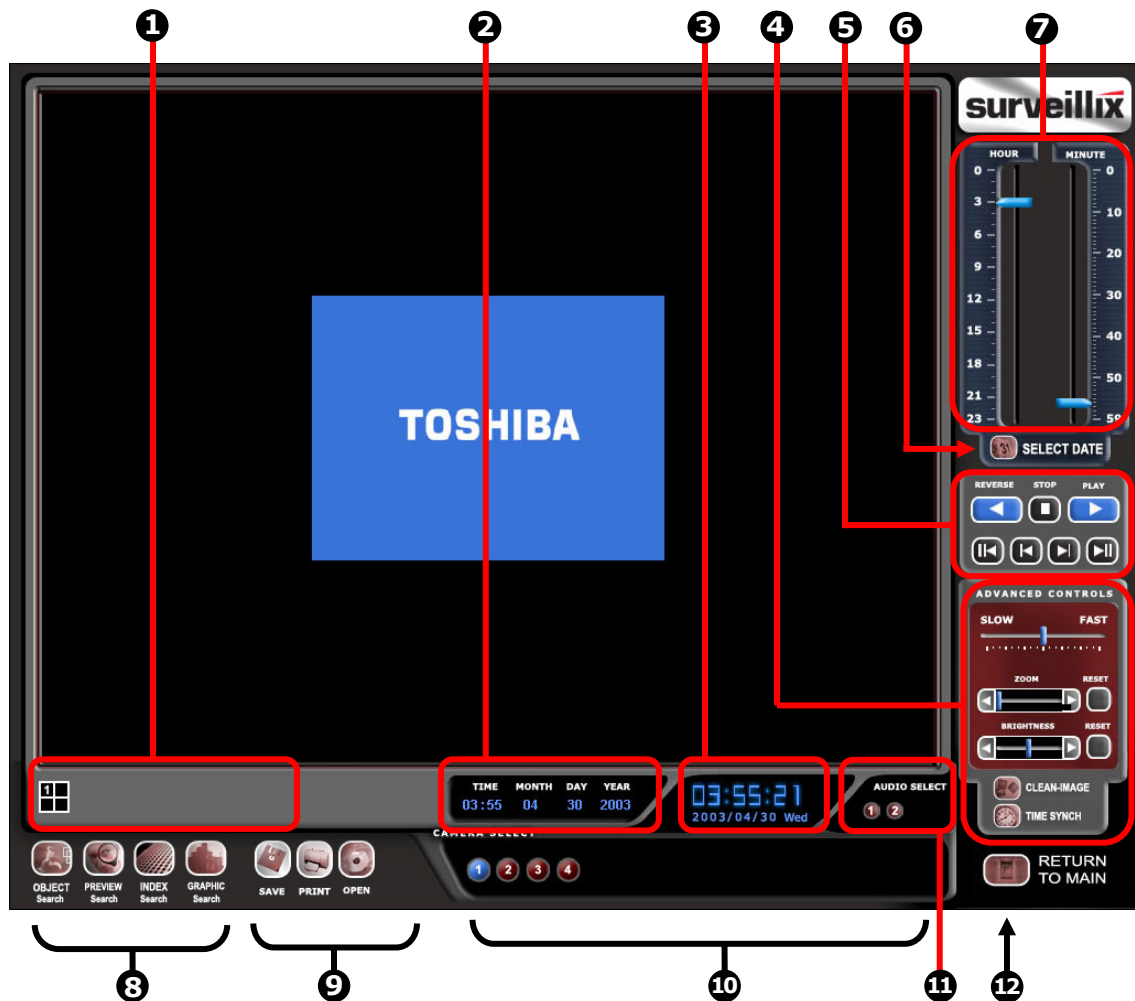

Figure 5.1

Figure 5.1

- ① **Screen Division Buttons** – The Screen Division buttons allow you to view one or more sets of cameras at a time. They are organized in several different groups such as.
- ② **Search Date and Time** – Displays the Date and Time of the video being played.
- ③ **Date/Time** – Displays the current time and date. This date and time is stamped into the recorded video and is displayed whenever the video is played back.
- ④ **Advanced Controls** – Allows you to perform operations such as adjusting the speed, brightness, and zooming.
- ⑤ **Play Controls** – The options allow you to view selected video Frame by Frame, Normal Speed, and Fast Forward.
- ⑥ **Select Date** – Opens a calendar window and allows you to select a day to perform a search on.
- ⑦ **Hour / Minute Control Bar** – Allows you to select the hour and minute by adjusting the sliding bar.

- 8 Search Options** – The search options are a set of functions that allow you to easily find the specific video clips you want and to export them to a usable format.
- 9 Print/Open/Export/POS Options** – These options allow you to print images, save single images to disk and load saved video from disk.
- 10 Camera Select Buttons** – The Camera Select buttons enable cameras for searching.
- 11 Audio Channels** – Displays the Audio channel buttons. Selecting these allows you to playback the audio.
! NOTE: The Audio buttons are only viewable when one camera is selected.
- 12 Return to Main** – The Return to Main button exits out of search and returns you to the Main Display Screen.

5.2 Play Controls

The Play Controls allow you to play the video Frame by Frame, Normal Speed, and Reverse.

Figure 5.2

- 1 Stop** – This option stops any video that is currently playing.
- 2 Play (Normal Speed)** – This option plays the video at normal speed.
- 3 Jump to End** - This option when pressed jumps to the end of the recorded video.
- 4 Play (Frame by Frame)** – This option plays the video one frame at a time (One frame each time the button is pressed).
- 5 Play Reverse (Frame by Frame)** – This option plays the video one frame at a time in reverse (One frame each time the button is pressed).
- 6 Jump to Beginning** – This option when pressed jumps to the beginning of the recorded video.
- 7 Play Reverse** – This option plays the video at normal speed in Reverse.

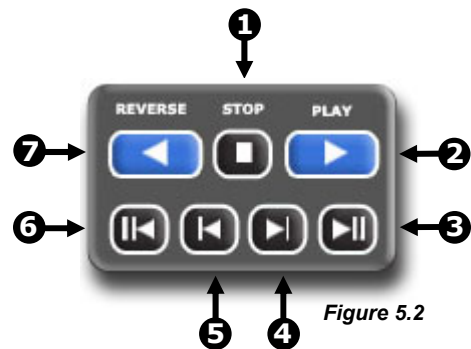

Figure 5.2

5.3 Hour / Minute Control Bar

The Hour/Minute Control Bar allows you to select the Hour and Minute using an easy-to-use slide bar. You can control the slide bar not only by clicking and dragging the slider but also using the Wheel on the Scroll Mouse.

Figure 5.3

- 1 Hour Selector** – The Hour Selector displays the hours for a given day 0 to 24. Move the Slide Bar Selector up and down to select an hour.
- 2 Slide Bar Selector** – The Slide Bar can be moved up and down to select the hour and minute.
! TIP: By using the Wheel on the mouse, you can easily move the Slide Bar Selector up and down. Simply click on the Slide Bar Selector with the Mouse and then begin moving the Wheel up and down.
- 3 Minute Selector** – The Minute Selector displays the minutes for a selected hour 0 to 60.
- 4 Select Date** – Opens a calendar window and allows you to select a day to perform a search on.

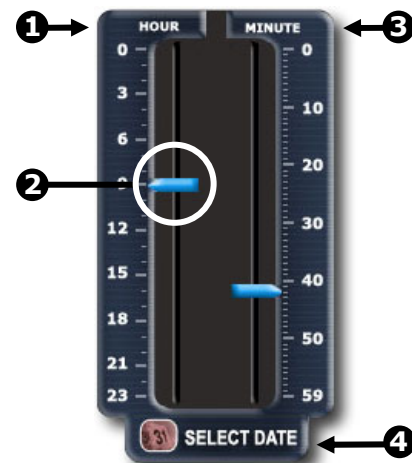

Figure 5.3

5.4 Advanced Options

The Advanced Controls allow you to get the most out of your search. Using the Brightness you can brighten up an image to get more detail. Using the Zoom feature you can not only bring the image up full screen, but you can also Zoom into a particular area of the image.

Figure 5.4a

- 1** **Slow/Fast** – This option increases and decreases the playback speed.
- 2** **Zoom** – The Zoom Selector allows you to Zoom in on an image.
- 3** **Brightness** – The Brightness selector allows you to adjust the Brightness of an image.
- 4** **Clean Image** – Often times, extensive motion can create a 'digital blur' that can interfere with the quality of an image. By selecting the Clean Image option, two frames are interwoven to create a smooth, detailed image. This option only pertains to the 720x480 resolution.
- 5** **Time Synch** – This option allows you to sync a single channel of video to the real time.

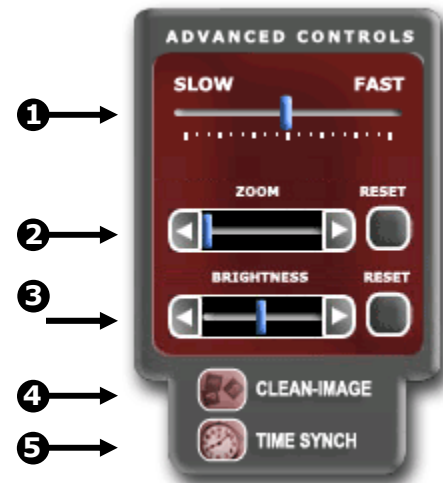

Figure 5.4a
Advanced Controls

Adjusting the Brightness of an Image

- 1) Select a single image to adjust by double-clicking the left mouse button on the desired image. You cannot adjust multiple images at one time.
- 2) Using the Bright Slide Bar, move the bar to the right or the left. To reset the Brightness press the Reset Button

Zooming in on an image

- 1) Select a single image to adjust by double-clicking on an image with the left mouse button. You cannot adjust multiple images at one time.
- 2) Using the Zoom Slide Bar, move the bar to the right or the left. To reset the Zoom, press the Reset Button.

Zooming in on a portion of an image

- 3) Using the Mouse Pointer, point to an area on the image where you would like to zoom in on and press the Right-Mouse Button.
- 4) Keep pressing the Right-Mouse Button to zoom in further. After a certain number of clicks, the image will revert back to its original size.

Synchronizing the Video to the 'Real Time'

- 1) Select a single image to synchronize by double-clicking on an image with the left mouse button.
- 2) Press the TIME SYNCH button. The video will now playback in real time.

Clean Image

- 1) The DVR unit is capable of recording video using one of three different resolutions. When using the 720 x 480 resolution, two fields are mixed. Because of the timing gap between the two fields, according to the standardized image rules, a little afterimage might occur to high speed moving images. The Surveillix™ DVR unit allows you to remove this by pressing the CLEAN IMAGE button.

The images below demonstrate the filtered screen.



Figure 5.4b
Filtering Display playback



5.5

Search Options Overview

The Search Options allow you to find what you want quickly, enhance the image quality, and export the video or images in a number of ways.



Index Search – This option allows you to perform a search based on Motion detection, Sensor activation, and ATM/POS transactions. This search allows you to quickly narrow down large amounts of recorded video based on that criterion.



Preview Search – The Preview search is a Search option that allows you to narrow down recorded video in a 24 Hour period. It breaks down a single day into 24 images, one image for each hour of the day (The images are taken from the first second of each hour). When an image is selected, the 'hour' chosen is then broken down into 6 images, one image for every 10 minute increment. Finally when another image is selected, 10 images are displayed, one for every minute within the 10 minute period. From this point, the selected image can be applied to the Main Search.



Object Search – The Object Search allows you to specify a region on an image and perform a search based on any motion that has occurred within that region.



Graphic Search – The Graphic Search displays recorded video in a color coded format that allows you to easily select the portion of video you wish to play.

5.6 Performing a Basic Search

There are several different types of searches that can be performed on the DVR unit. The following section will cover the most basic of these. This involves simply selecting the date, the time, the camera, and pressing play.

Performing a Basic Search

- 1) Begin by selecting a Date. Do this by opening the Calendar (See Section 5.3) and selecting a day.
- 2) Select a Time. Do this by adjusting the Hour and Minute Slide Bars (See Section 5.3).
- 3) Select a One or More Cameras (See Section 5.1).
- 4) Press the Play Button (See Section 5.2).

You can now play the Video Forwards, Backwards, and Frame by Frame (See Section 5.2).

5.6.1 Daylight Savings Time

The DVR automatically adjusts for Daylight Savings Time changes. When the hour jumps forward no video is lost because an hour is simply skipped. However when the hour falls back, there is a duplicated hour that under normal circumstances would be recorded over. The Toshiba Surveillix KV-KLR actually records both hours and allows you to select which hour to play if the need arises. The following steps explain how to access the Daylight Savings Time option.

Accessing the Daylight Savings Time 'lost' hour:

- 1) From the Search Screen, select the SELECT DATE button (Section 5.3).
- 2) Select the date when Daylight Savings Time lost an hour. An option should now appear that says Daylight Savings Time. (See Figure 5.6.1)
- 3) To play back the 'lost' hour, simply select the DAYLIGHT SAVINGS option.
- 4) Press OK to confirm the date and begin playing the video using the standard Search features.

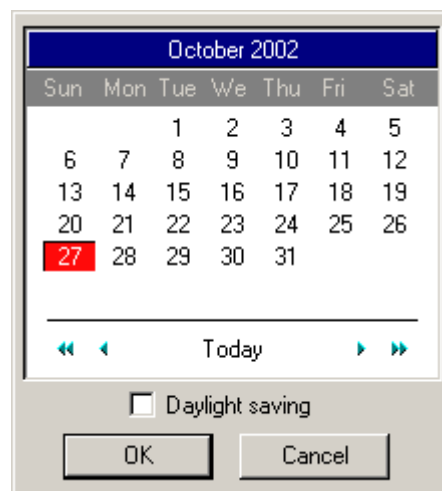

Figure 5.6.1

5.7 Print/Open/Export Images

Once you find the video you are looking for you can Print it, Save it as a single image or Save it as a video clip. In addition you can also open and play video that has previously been saved to a disc or hard drive.



Print – This option allows you to output a selected image to an attached printer.



Save – This option allows you to save a selected image as a JPG file or to save a video clip in an AVI format.



Load – The Load Option allows you to search and view video that has been saved to media such as a CDR, CD-RW, or External Hard Disk Drive.

5.7.1 Print

The DVR unit allows you to print a recorded image to a local or network printer.

To print an image, follow these steps:

- 5) From the Search Screen, stop on the image you wish to print. Make sure only one camera is selected by double-clicking on the image you want. (Only one camera should be displayed)

! **NOTE:** Only one camera can be selected at a time for this function to work.

- 6) Select the Print Button. A Print Options window should appear.
- 7) Depending on the printer you are using you may have several printing options available to you. (Refer to your printer manual for more information)
- 8) Press the 'Print' button to print the selected images.

If you do not have a printer installed, the 'NO DEFAULT PRINTER INSTALLED' message will appear.

5.7.2 Save to JPG or AVI

The DVR unit can export single images in the .JPG file format, save video clips in the .AVI format. The JPG and AVI file formats are extremely common, with virtually universal computer support, making them ideal formats to use. A digital signature is also attached to every .JPG and .AVI file exported by the DVR for use with the bundled Digital Verifier application. This function is unique to the DVR and its Verification software and should not interfere with viewing the files using other applications.

Definition

JPG: (Joint Photographic Experts Group) - The name of the committee that designed the photographic image-compression standard. The format (.jpg) is optimized for compressing full-color or grayscale photographic images. JPG images are 24-bit (16.7 million color) graphics.

AVI: (Audio/visual interleaved) files are one of the more popular animated image formats in use today. They are most often used for video playback, though they are also used for more simple things such as the Windows "file copy" and "search" animations. AVI image data can be stored uncompressed, but it is typically compressed using a Windows-supplied or third party compression and decompression module called a codec.

Figure 5.7.2

1. **JPG File** – Saving to a JPG File allows you to export a single image (or frame).
2. **AVI File**– Saving to an AVI File allows you to save a video clip.
3. **AVI Duration** – Allows you to enter a duration to record the AVI for (in seconds). Although 100 Seconds is the longest displayed, you can manually enter a longer time.
4. **Image Quality** – Often times it is necessary to reduce the overall size of an AVI file (When you wish to email it to someone for example). You can do this by reducing the image quality. By reducing the image quality, the AVI video appears more Pixilated. When size is not an issue setting the quality to 100 is highly recommended.
5. **Export** – The Export button begins the saving process.

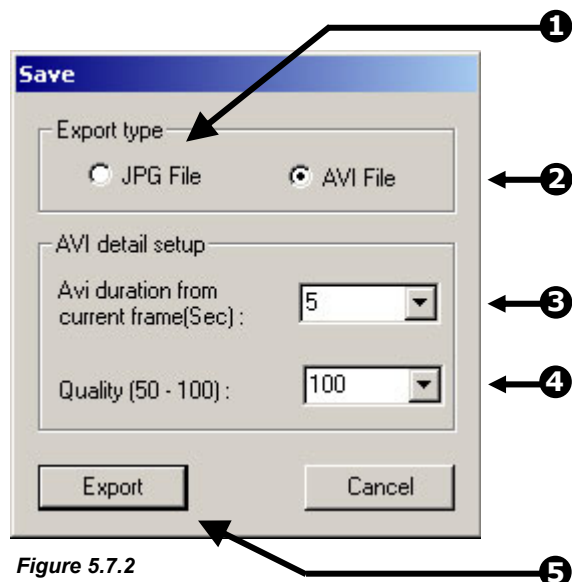

Figure 5.7.2

5.8 Index Search

Using the Index Search can greatly decrease the amount of time spent searching through saved video. The Index Search allows you to perform a search based on criteria such as Sensor, Motion and Instant Record events.

Figure 5.8a

1. **Select Camera** – Allow you to either select a single camera to search or select all the cameras at once.
2. **Select Time** – The default search time is 24 Hours. If this option is select then a Start Time and End Time must be entered.
3. **Start Time** – Specifies the Start Time for the Index Search.
4. **End Time** – Specifies the End Time for the Index search.
5. **Sensor** – Searches by all sensor events on the selected camera(s).
6. **Motion Detection** – Searches by all Motion events on the selected camera(s).
7. **Instant Record** – Searches by all Instant Recording events on the selected camera(s).
8. **All Event** – Searches on all events for the selected camera(s) (Sensor, Motion, and Instant Recording).

Performing an Index Search

- 1) Begin by Selecting the Index Search Button. The Index Search Option Box should open.
- 2) Select a single camera or select the ALL cameras option.
- 3) Select the SELECT TIME option to specify a specific time to search or leave it unchecked to default to the current day.
- 4) Select an Event to search on. (Sensor, Motion, Instant Record, or ATM/POS). If you select ATM/POS you have the option to enter a specific transaction number. If no transaction number is entered all transaction will be displayed.

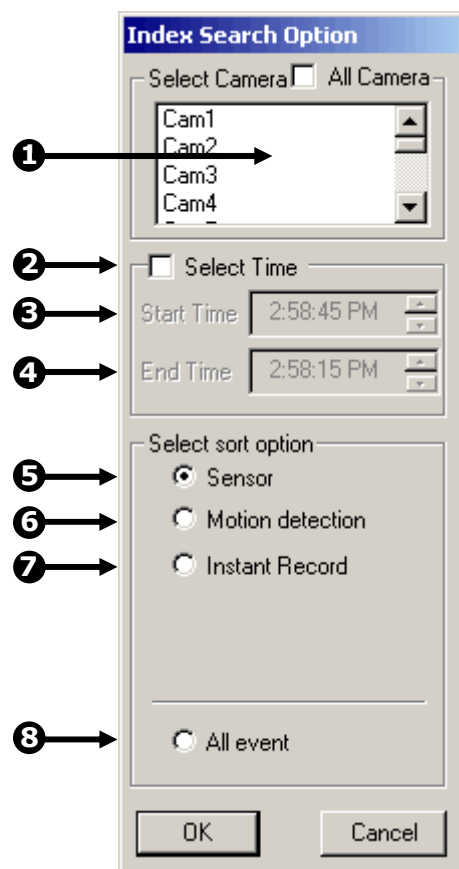

Figure 5.8a

- 5) Press the 'OK' Button. (It may take a minute or two to return the results)
 If there are results, they will be displayed in a column on the left side of the screen (See Figure 5.8b).
 If there are no results found, 'No Images Found' will appear in the column.
- 6) Once the results are displayed you can search through them by simply double-clicking any one of the results.
- 7) Once you have found the image you are looking for, apply it to the Main Search by selecting the 'Close' Button located at the bottom of the results column.

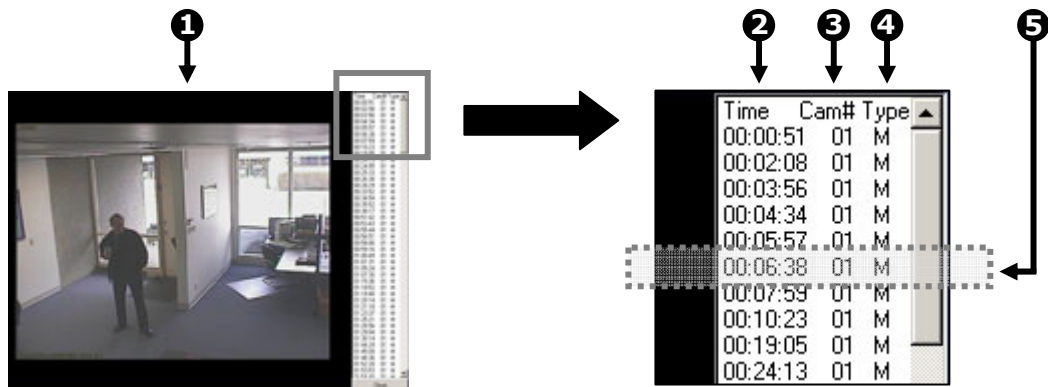

Figure 5.8b

Figure 5.8b

- 1** **Image Display Area** – The Image Display Area is where the Search Results Images are displayed.
- 2** **Time** – Displays the Time of the result.
- 3** **Camera Number** – Displays the Camera Number for the returned result.
- 4** **Type** – Displays the Event Type.
 M Motion
 S Sensor
 IR Instant Record
- 5** **Search Results** – Displays the results of the search. Each line represents a segment of video.

5.9

Preview Search

The Preview Search can be used in a number of circumstances to quickly find an exact moment where an event such as a theft occurred. The Preview Search basically gives a 24 Hour visual overview of a single camera by separating a 24 hour period (1 day) into 24 images, one image for each hour of the day. The search can then be further narrowed down into ten minute increments and one minute increments by simply selecting one of the images displayed.

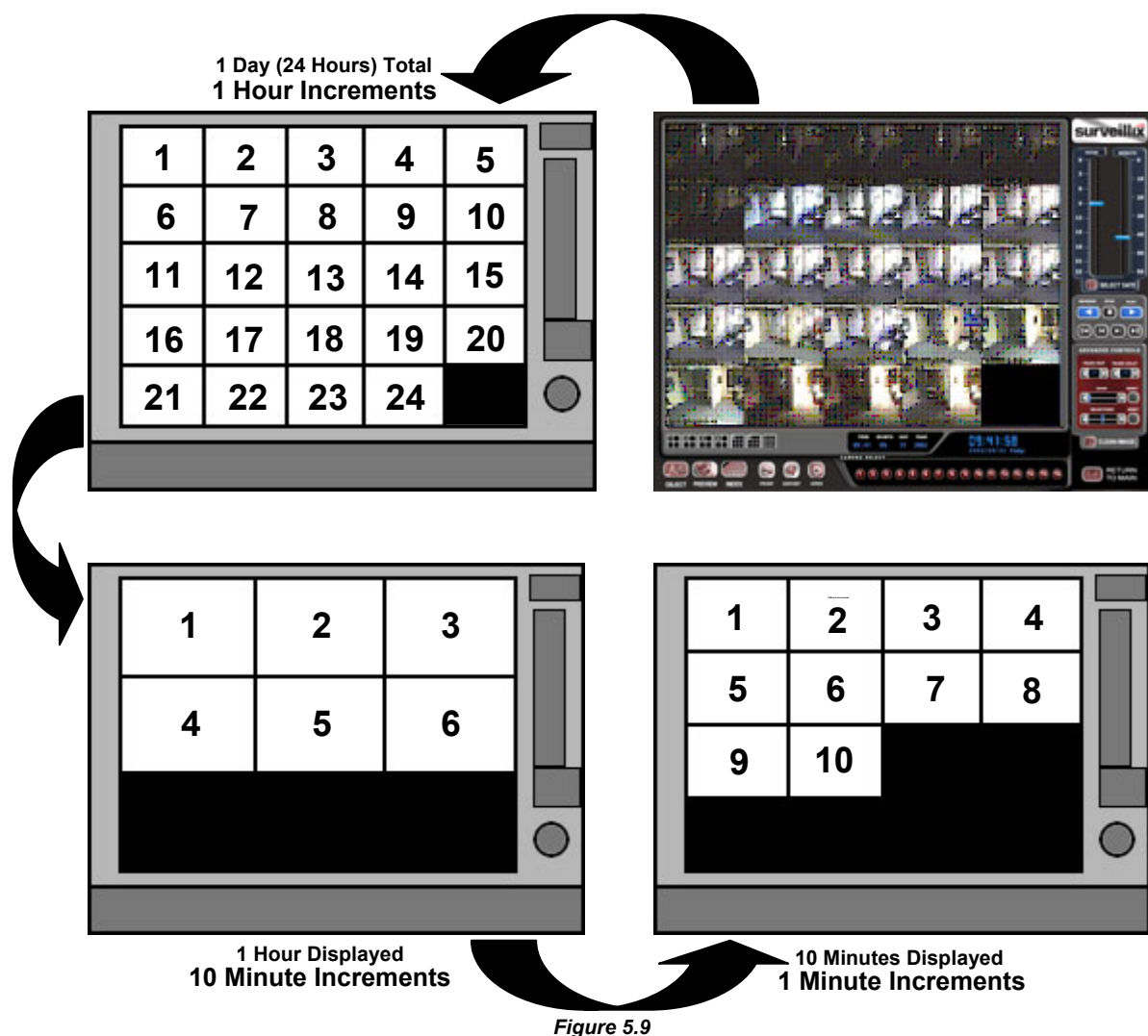

The images in Figure 5.9 show how the Preview Search functions. The first screen that appears has 24 images displayed. Each image represents the first second of each hour. If there is no image recorded during that period then nothing will be displayed. When an hour is selected (by double clicking on the image) then a new screen appears with 6 images. Each of these images represents a 10 minute segment of video. Once a 10 minute segment is selected (by double-clicking on the image) the final screen appears which breaks down that 10 minute segment into 1 minute increments (10 images).

Performing a Preview Search

- 1) Begin by selecting a single camera. You can do this either by turning off all cameras but one, or by double clicking a displayed image (it will then be the only image displayed on the screen)
- 2) Select the Preview Search Button.
24 Images should now be displayed. If there is no recorded video during a portion of the day then a 'No Image' will be displayed where the image(s) should be.
- 3) Refine the search by selecting an image. Do this by double-clicking on the image.
6 Images should now be displayed. You can move back to the previous 24 image view by right clicking on an image.
- 4) Refine the search by selecting an image. Do this by double-clicking on the image.
10 Images should now be displayed. You can move back to the previous 6 image view by right clicking on an image.

- 5) To select a displayed 1 minute segment of video to begin playing it, simply double-click on the image.
A single image should now be displayed. You can move back to the previous 10 image view by right clicking on an image.
- 6) You can now use the Play controls (See Section 5.2) to play the video.
- 7) To Apply the current image to the Main Search, that is, exit out of Preview search with the current image still selected, simply deselect the Preview Search Button.

5.10 Object Search

The Object Search is a powerful Search utility that allows you to search a region on the video for any motion changes. The Results are neatly displayed and allows you to view them quickly.

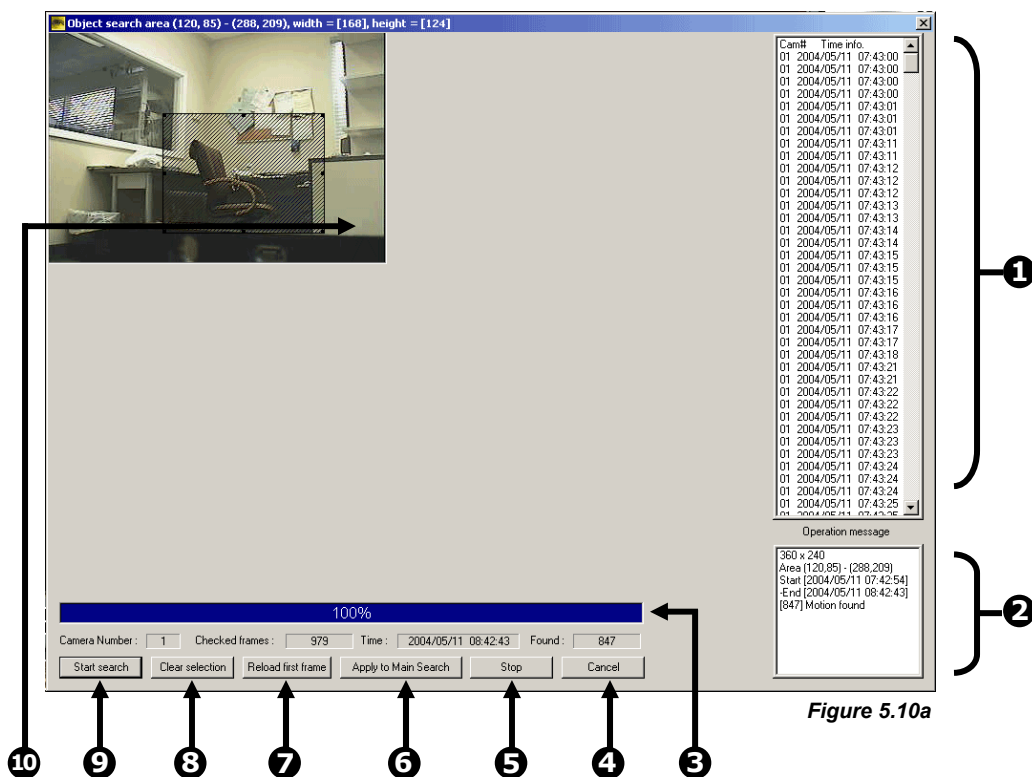

Figure 5.10a

Figure 5.10a

- 1 **Search Results** – The Search Results are displayed in this column. The results are listed by date and time. When the search is complete you can view the results by double-clicking on one of the results or by using the Up and Down arrow keys on the keyboard.
- 2 **Search Information** – The Search Information box displays brief information on the overall search.
- 3 **Progress Bar** – This bar displays the percentage complete when performing an Object Search.
- 4 **Cancel** – Selecting the Cancel button exits the Object Search.
- 5 **Stop** – The Stop option stops the current search.
- 6 **Apply to Main Search** – Apply to Main Search exits the Object Search but takes the selected result (the current image displayed) and displays it inside the Main Search. From that point you can use the Play Controls.
- 7 **Reload First Frame** – This option reloads the initial Key Frame image, that is, the image used to start the search.

-
- 8 Clear Selection** – This option clears the current Motion Region Box from the Keyframe Image.

 - 9 Start Search** – This option Begins the search.

 - 10 Motion Region Box** – The Motion Region Box is the user defined area of the Keyframe image. You create the Motion Region Box by clicking inside the image and dragging the mouse. The Motion Region Box can be resized by pulling on the little square boxes located on the outer perimeter of the Box.
-

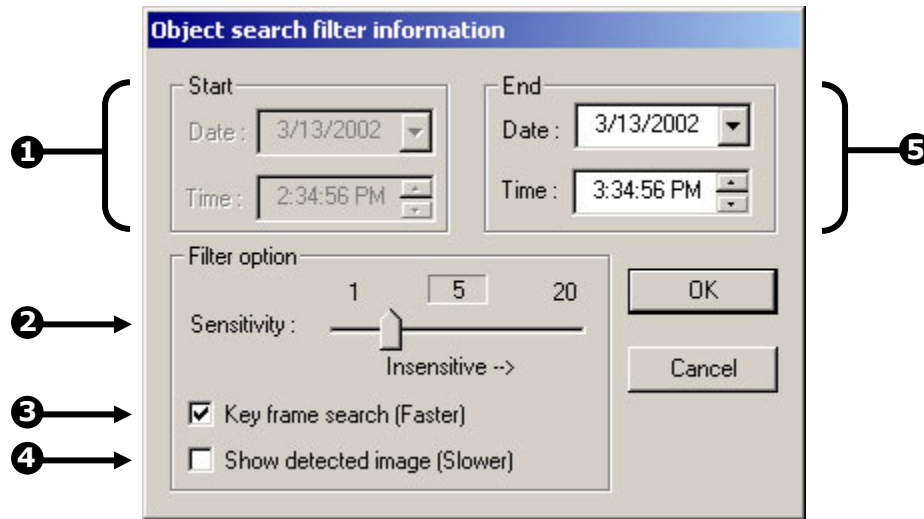

Figure 5.10b

Figure 5.10b

-
- 1 Start** – This displays the time and date of the initial Key Frame.

 - 2 Sensitivity** – The Sensitivity option allows you to control sensitivity of the motion that will be detected. Often times poor lighting conditions can be interpreted as motion. The sensitivity can compensate for this.

 - 3 Key Frame Search** – Selecting the Cancel button exits the Object Search.

 - 4 Show Detected Image** – This option, when selected, displays the results as it finds them. Using this option slows the search process slightly and therefore may not be ideal when searching large periods of time.

 - 5 End** – This option allows you designate an end time. The default is one hour.
-

Performing an Object Search

-
- 1) Begin by selecting a single camera. You can do this either by turning off all cameras but one, or by double clicking a displayed image (it will then be the only image displayed on the screen)

 - 2) Select the Object Search Button.
The Object Search window will open.

 - 3) Create a Motion Region Box on the image. Do this by clicking inside the image and, while holding the left mouse button down, drag the pointer. When the desired shape is created, simply let go of the mouse-button. Only One Motion Region Box can be created. To delete the Motion Region Box press the Clear Selection button.

 - 4) Press the Start Search button.
The Object Filter Search Information window should open.

 - 5) Select an end time. One hour is the default setting.

 - 6) Adjust the Sensitivity if necessary.
-

- 7) Press the OK button.
The Search will begin. When results are found they will be displayed in the column to the right. If no results are found the search will end and 'No Images Found' will be displayed in the column.
To stop a search, press the STOP button.
- 8) When the Search has ended double-click on one of the results. Use the Up and Down arrow keys to scroll through the results quickly.
- 9) When you have found the image you are looking for, select the APPLY TO MAIN SEARCH button.
You can now use the Play Controls.

5.11 Graphic Search

The Graphic Search option displays video in graph format.

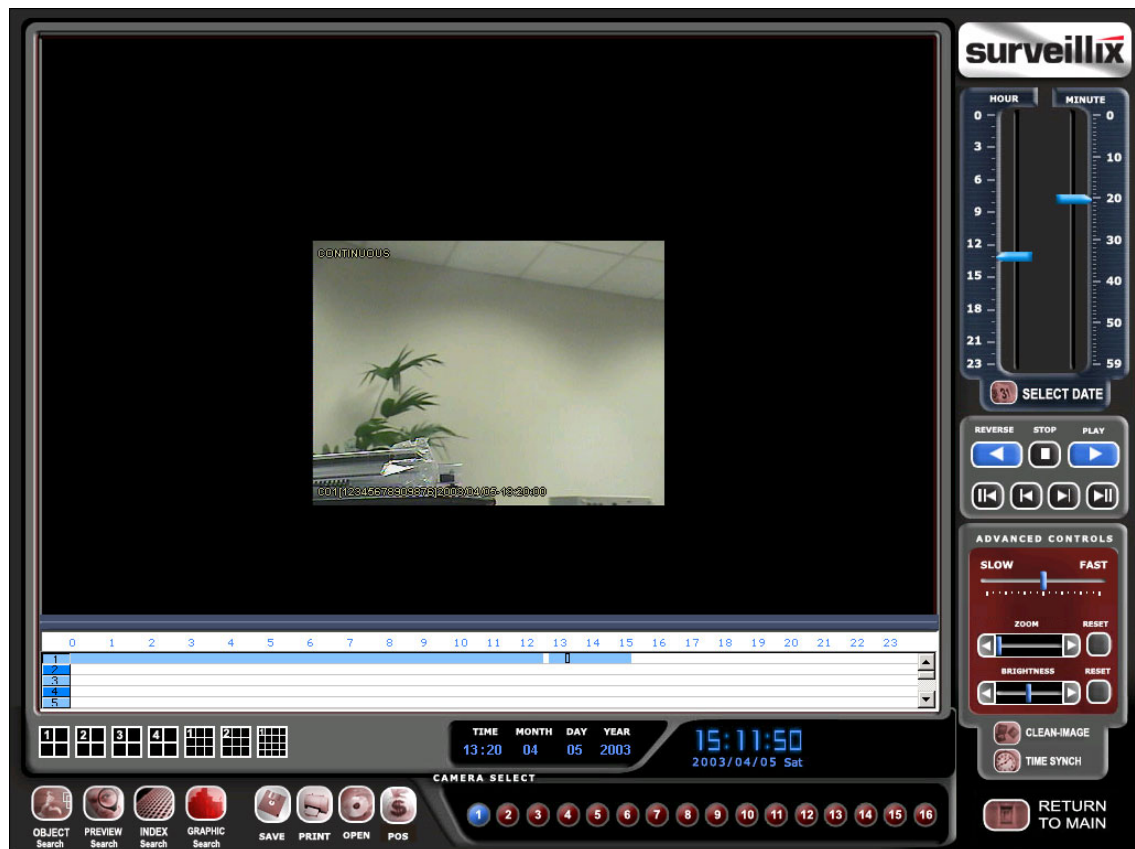

Figure 5.11a
KV-KLR16 Shown

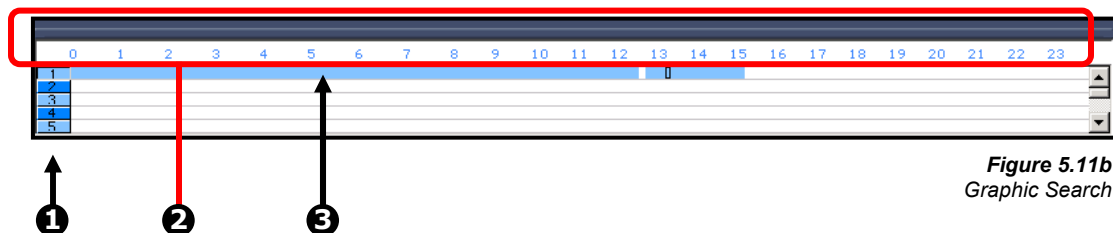

Figure 5.11b
Graphic Search

Figure 5.11b

- 1) **Camera** – This displays the cameras in a linear format. You can scroll down using the scroll bar on the right.
- 2) **Hours** – The hours 0-23 are listed (24 hours).
- 3) **Recording Block** – This displays where video is recorded in blue. No recording will be displayed in white.

Performing a Graphic Search

- 1) Begin by selecting the Graphic Search button. The Graphic Search window will open.
- 2) With the mouse, click on an area of the blue recording block. Only one camera can be displayed at a time.

5.12

Audio Playback

The audio is played back at 48,000 Hz.

Playing Audio with the Video

- 1) Begin by selecting a single camera. Do this by turning off all cameras but one using the CAMERA SELECT buttons.
The audio buttons will be displayed.
- 2) Select a single audio channel to play.
When an audio channel is selected, the TIME SYNCH button will automatically be selected.
- 3) Press the Play button.

- ! **NOTE:** When you playback video footage continuously from non-audio section to an audio section, you must first
 - STOP and then press PLAY or the audio will not play.

CHAPTER 6

Pan / Tilt / Zoom

This chapter includes the following information:

- Overview
- Setting up the PTZ
- Creating and Viewing a Preset Position
- Creating and Viewing a Preset Pattern

6.1 PAN/TILT/ZOOM Overview

The PTZ controls within the DVR unit allow for powerful control over the cameras. This can be extremely beneficial by increasing the usefulness of the recorded video. Using the PTZ controls you can create custom preset configurations that can continuously sweep across large areas.

6.2 Setting Up a PTZ Camera

Setting up a PTZ Camera is simple. The DVR unit comes preassembled with an internal PTZ adapter. The cabling may be run up to 10,000 ft using 22 Gauge Twisted Pair.

It is important to understand how the PTZ connects to the DVR. The DVR takes an RS-422/485 connection and converts it into an RS-232 connection. The RS-232 connection cable must be attached before the PTZ camera will be controllable by the DVR.

Attaching the RS-232 adapter

- 1) Locate the RS-232 adapter from the contents shipped within the DVR. (See Figure 6.2a)
- 2) Connect the RJ-11 end to the RJ-11 jack on the back of the DVR and the other end to the Serial Port on the back of the DVR.

When connected, it should look like Figure 6.2b.



Figure 6.2a

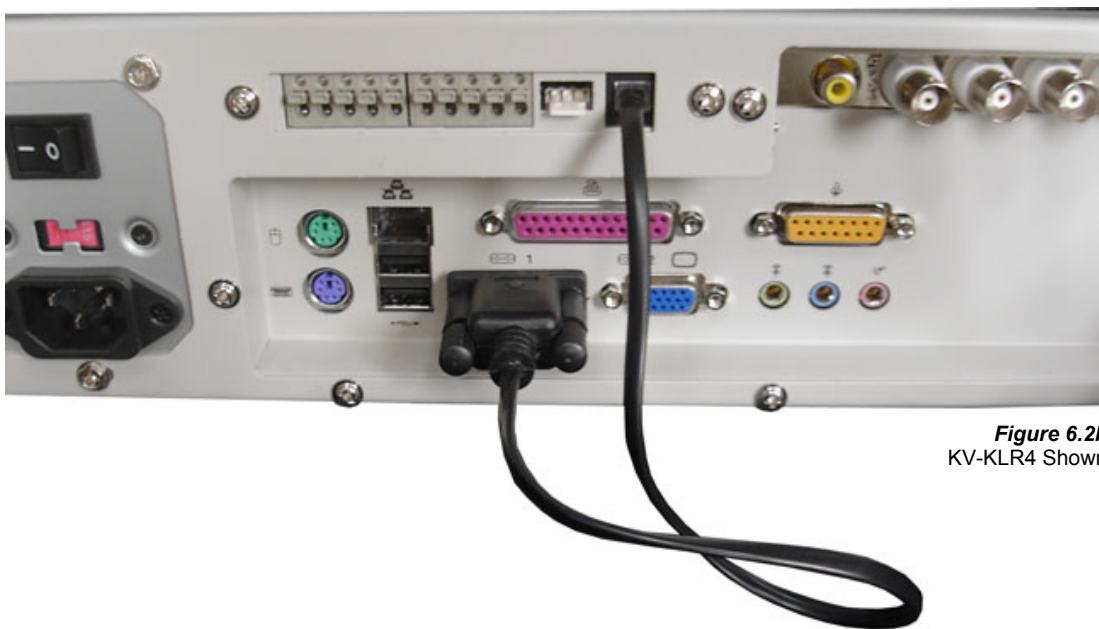

Figure 6.2b
KV-KLR4 Shown

Setting up a PTZ Camera

- 3) Locate the PTZ adapter (Figure 6.2c).
- 4) Connect the two wires of the included PTZ adapter to the PTZ camera (See Figure 6.2a). Since each camera is different, refer to your PTZ camera manual for detailed instructions.
- 5) Connect the other end of the adapter to the DVR unit (See Figures 6.2D and 6.3E)
- 6) Assign the PTZ Camera an ID number that coincides with the number assigned to it by the DVR unit. For Example: If you have the camera plugged into Input #5 on the DVR then you must set the PTZ unit to ID #5.
- 7) Inside the DVR setup, select the PTZ menu option and select the desired camera number.
- 8) Select RS-232 as the default connection type. **THIS IS IMPORTANT.** Even though the PTZ camera is expecting an RS-422/485 connection you must still select the RS-232.
- 9) Enable the PTZ functions of the camera by placing a check in the PAN/TILT CONENCTION checkbox.
- 10) Once enabled, the Protocol can be edited. Select the appropriate Protocol.

! **NOTE:** Protocols are a set of instructions written by the manufacture of the PTZ cameras that allow software programs such as this DVR to control their functions. The majority of the major PTZ manufacture protocols are included in this software.
- 11) Press the APPLY button and exit Setup.
- 12) From the Main Display Screen select the PTZ button. The PTZ Control options will open.
- 13) Select the PTZ camera to control by clicking on its video on the main display screen. The camera number should appear inside the PTZ controls.
- 14) Using the PTZ controls, you should now be able to move the PTZ around.

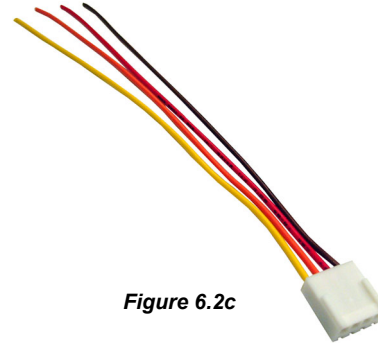

Figure 6.2c

Use the Brown and Red Wires



Figure 6.2d

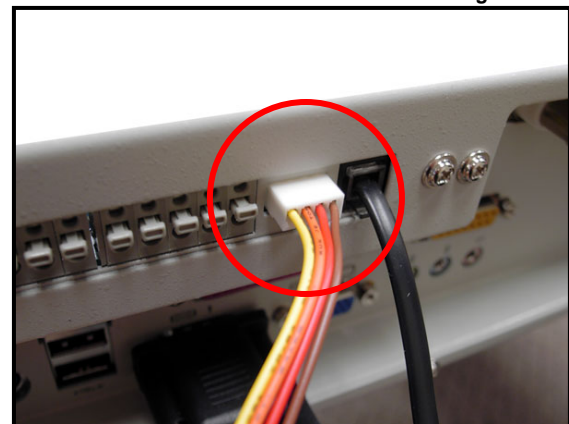

Figure 6.2e

6.2.1 Supported Protocols

Protocols are added frequently. The actual supported list most likely contains new protocols that are not listed here.

The current supported protocols are:

Ademco Rapid Dome	HSCP	Sensormatic SpeedDome
American Dynamics	Honeywell (HSD-250)	SPD-2500P
CBC (GANZ)	Inter-M(VRX-2101)	SungJin (SJ2819RX)
C-BEL	Javelin (Orbitor)	Toshiba (P protocol 4800bps)
Chiper CPT (V9KR Series)	Kalatel (Cyber Dome)	Ultrak (KD6)
CNB-AN102	KDC	VCL
CNB-PTZ100	LG (LVC-A70x's)	VCL- LEGACY
Computar	LG SD-110	Vicon
Dennard	LG (LPT-A100L)	Vicon Speeddome
DMP23-H2	Merit LI-LIN	Vicon Surveyor 2000
Dong Yang Unitech (DRX-502A)	Merit LI-LIN V6	Videoalarm
DVRX-100	NiceCam	Vision Tech
DY-255RXC	Panasonic	WonWoo
Dynacolor	Pelco D	
Ernitec	Pelco (P protocol 4800bps)	
Fastrax II	Philips (TC8560 & TC700)	
FillTech	SAE	
Fine System (CRR-1600)	Samsung (DRX-502A)	
Focvision (KD1602)	Samsung (SCC-641)	
HMS-250	SANTACHI	

6.3 PTZ Setup

The PTZ Setup allows you to enable PTZ cameras, create Presets, Tours, and also adjust speed settings. Many options listed here are features only available on selected cameras.

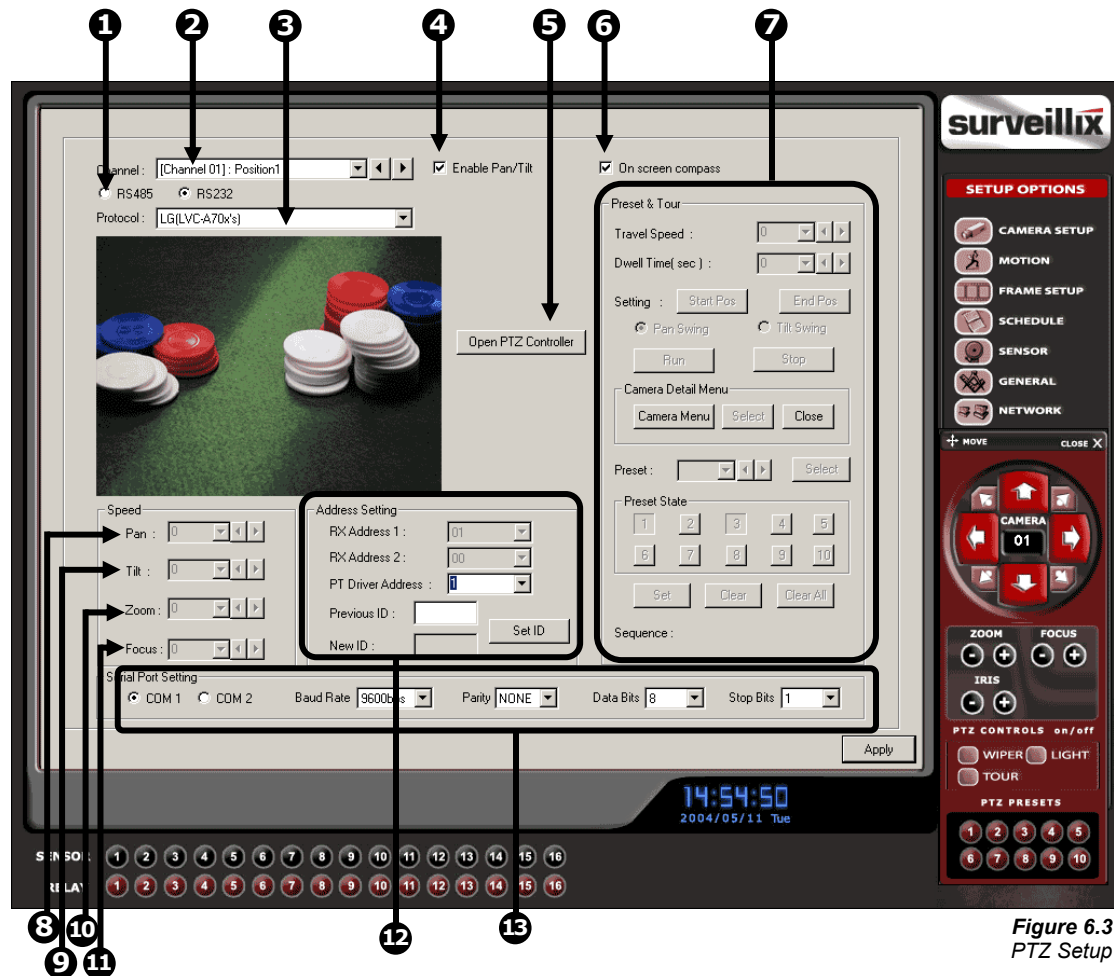

Figure 6.3
PTZ Setup

Figure 6.3

- 1 **RS485 / RS232** – Defines how to send the PTZ signal to the camera.
- 2 **Select Camera** – Selects the current camera to be edited.
- 3 **Protocol** – Selects the protocol to use for the selected camera. The protocol is the unique set of instructions that allows the DVR to communicate with the PTZ camera.
- 4 **Enable Pan/Tilt** – Enables the DVR to control the PTZ camera.
- 5 **Open PTZ Controller** – This option opens the PTZ controller allowing you to move the PTZ camera.
- 6 **On Screen Compass** – This option allows on-screen PTZ Control. This allows you to move the PTZ camera by simply clicking on the video itself instead of using the controller.
- 7 **Preset and Tour** – These options allow you to create Presets and Tours for the PTZ camera. Since each camera creates these in a different way, there can be multiple ways to do this.
- 8 **Pan Speed** – This option increases or decreases the Pan speed.

- 9 Tilt Speed** – This option increases or decreases the Tilt speed.
- 10 Zoom Speed** – This option increases or decreases the Zoom speed.
- 11 Focus Speed** – This option increases or decreases the Focus speed
- 12 Address Setting** – These options are only available on select PTZ cameras
- 13 Serial Port Settings** – Defines the specific settings to transmit to the PTZ.

6.4

Creating and Viewing Preset Positions

A Preset Position is a user defined location where the camera can be pointed, zoomed in, and focused. You can define up to 10 preset positions per camera.

Creating a Preset:

- 1) Inside Setup, select the PTZ setup option and select the camera you wish to edit.
- 2) Inside the Pan Tilt Detail Setup select a Preset (1-10) using the Preset Select buttons. (See Figure 6.4)
- 3) Move the selected camera to the desired position using the Pan/Tilt/Zoom/Focus controls.
- 4) Once you have the camera in the desired position, press a Preset State button (1-10).
- 5) Select a Preset Position by clicking on a preset number (Presets 1-12).
The Preset is now saved.



Figure 6.4

Viewing a Preset:

- 1) From the Main Display Screen select the PTZ camera by clicking on it.
- 2) Using the keyboard press the number keys corresponding with the Preset Positions.
The Camera will move to the saved Preset.

6.5 PTZ Address Setting

Some protocols support software address settings. The following section explains these settings.

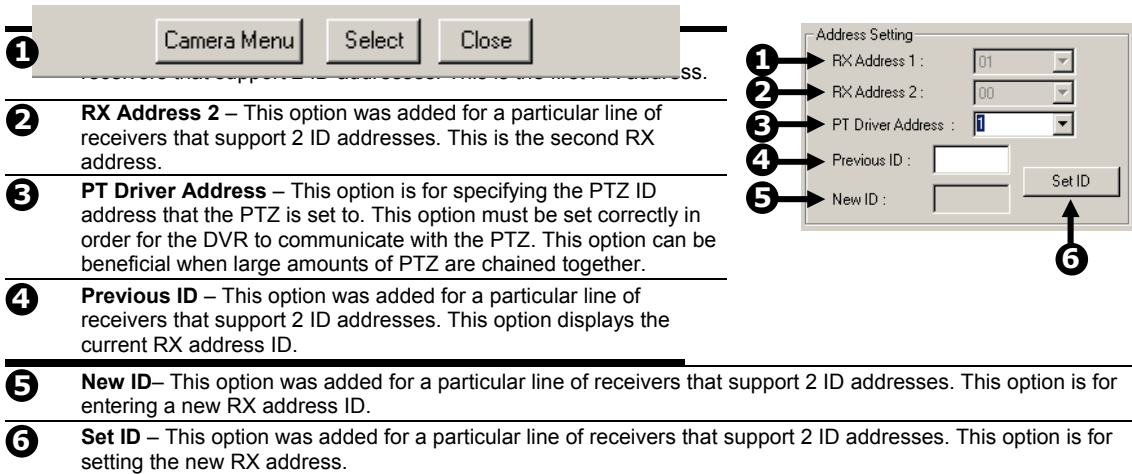

The screenshot shows a 'Camera Menu' with 'Select' and 'Close' buttons. Below it is the 'Address Setting' window with the following fields and callouts:

- 1**: Camera Menu button
- 2**: RX Address 1 dropdown (value: 01)
- 3**: RX Address 2 dropdown (value: 00)
- 4**: PT Driver Address dropdown (value: 1)
- 5**: Previous ID text box
- 6**: New ID text box
- 6**: Set ID button

2 **RX Address 2** – This option was added for a particular line of receivers that support 2 ID addresses. This is the second RX address.

3 **PT Driver Address** – This option is for specifying the PTZ ID address that the PTZ is set to. This option must be set correctly in order for the DVR to communicate with the PTZ. This option can be beneficial when large amounts of PTZ are chained together.

4 **Previous ID** – This option was added for a particular line of receivers that support 2 ID addresses. This option displays the current RX address ID.

5 **New ID**– This option was added for a particular line of receivers that support 2 ID addresses. This option is for entering a new RX address ID.

6 **Set ID** – This option was added for a particular line of receivers that support 2 ID addresses. This option is for setting the new RX address.

6.6 Accessing PTZ Menu's

Some protocols support the ability to access the Internal PTZ Onscreen Menu

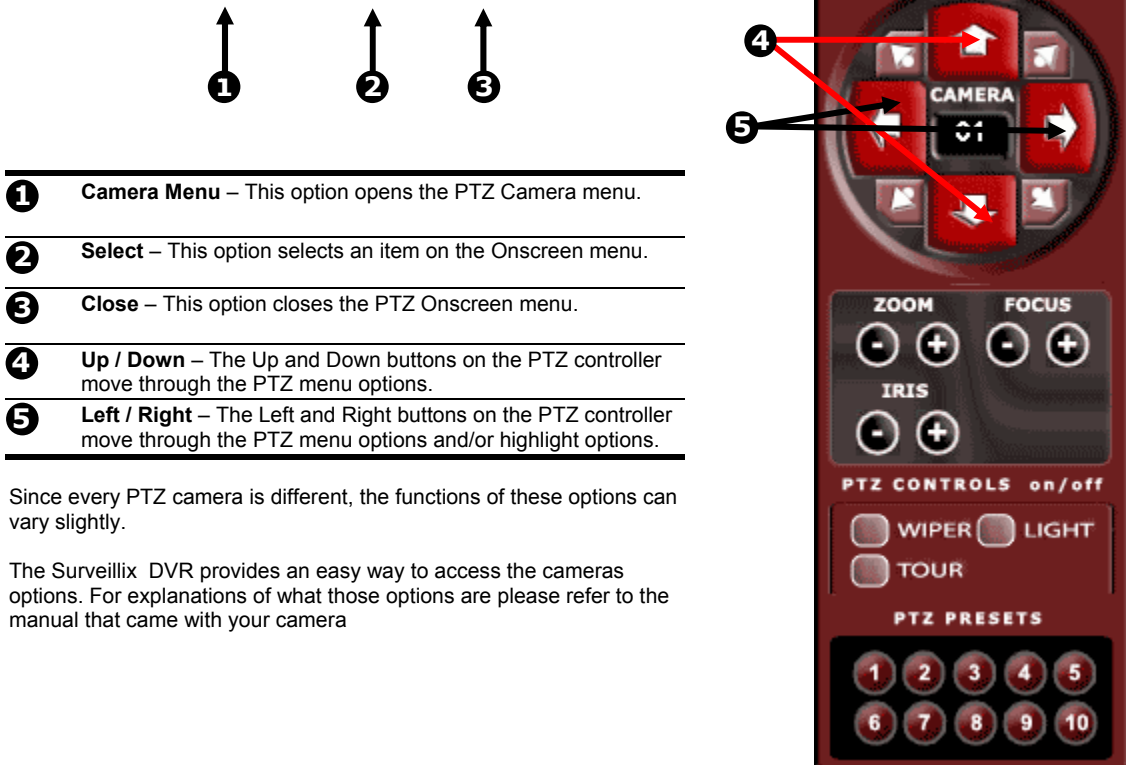

The diagram shows three arrows pointing up to callouts 1, 2, and 3. The screenshot of the PTZ Onscreen Menu has the following callouts:

- 1**: Camera Menu button
- 2**: Select button
- 3**: Close button
- 4**: Up and Down buttons
- 5**: Left and Right buttons

1 **Camera Menu** – This option opens the PTZ Camera menu.

2 **Select** – This option selects an item on the Onscreen menu.

3 **Close** – This option closes the PTZ Onscreen menu.

4 **Up / Down** – The Up and Down buttons on the PTZ controller move through the PTZ menu options.

5 **Left / Right** – The Left and Right buttons on the PTZ controller move through the PTZ menu options and/or highlight options.

Since every PTZ camera is different, the functions of these options can vary slightly.

The Surveillix DVR provides an easy way to access the cameras options. For explanations of what those options are please refer to the manual that came with your camera

6.7 Using the onscreen Compass

The Surveillix DVRs provide control for the PAN/TILT camera in two different ways.

- 1) Using the Graphical PTZ controller that appears when the PTZ button is pressed on the main screen.
- 2) Clicking on the video itself. This second option is a much more powerful way to control the Camera. (NOTE: The PTZ button on the main screen must still be selected to use this option.

Using the Onscreen Compass:

- 1) Press the PTZ Button on the main screen.
- 2) Control the PTZ by dragging the mouse on the screen in the desired direction. A green line will appear to show the direction the PTZ will move. The shorter the line the less the PTZ will move. The longer the line the more the PTZ will travel in the specified direction



6.7.1 Using the onscreen controller and Compass

- 1) **Camera Number** – This displays the camera number you are currently controlling. To change the camera, simply click on the video of the camera you wish to control.
 - 2) **Zoom** – This option Zooms the camera in and out.
 - 3) **Iris** – This option adjusts the Iris on the PTZ.
 - 4) **Wiper** – This option activate a Wiper on the PTZ camera.
 - 5) **Tour** – This option activates the Tour function.
 - 6) **PTZ Presets** – These buttons activate the corresponding PTZ Preset.
 - 7) **PTZ Controls** – There are 8 directions buttons that move the PTZ.
- NOTE:** Only 4 of the buttons work for all protocols (UP, DOWN, LEFT, RIGHT). 8 Directions are available only for select protocols.
- 8) **Focus** – This option focuses the PTZ camera.
 - 9) **Light** – This option activates the Light on the PTZ.

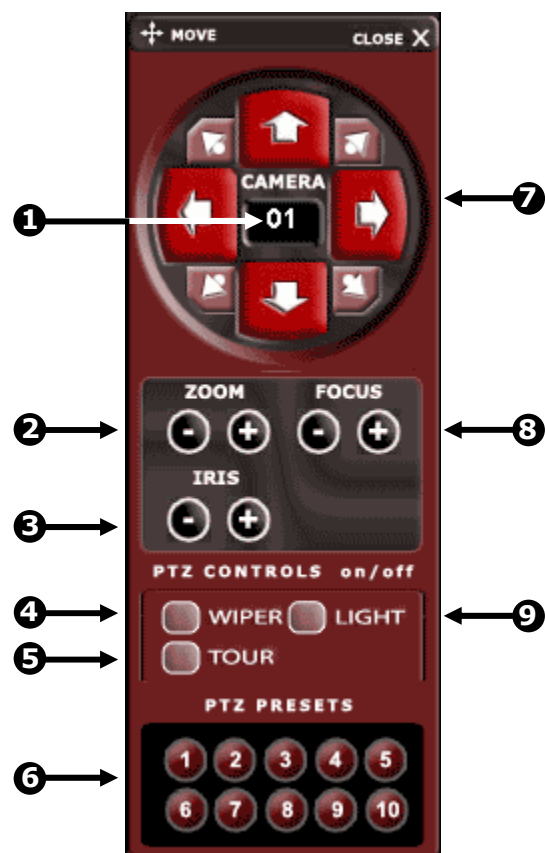

6.8

Understanding Tours

1 **Travel Speed** – This option defines the speed at which a PTZ moves from one Preset position to the next (when using Preset Tour 2).

2 **Dwell** – This option defines the length of time (in seconds) that a PTZ Tour stays on a Preset Position. Moves from one Preset position to the next (when using Preset Tour 2).

3 **Setting – Start Pos / End Pos** – These options describe how to define a Mimic Tour. The Start Position button begins the 'recording' process. The Stop Position button ends it.

4 **Pan Swing / Tilt Swing** – This option enables the Horizontal (Pan) or Vertical (Tilt) 'Guard Tours'.

5 **Run / Stop** –Runs the selected Pan or Tilt Tour.

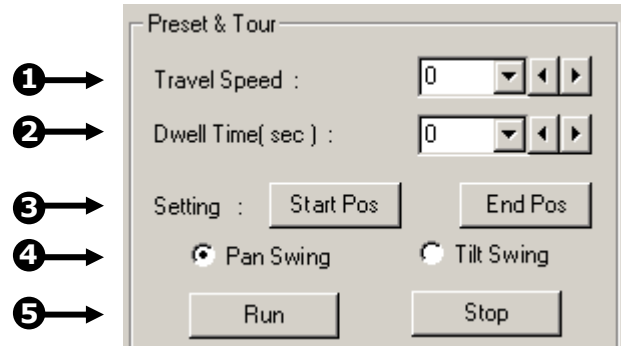

CHAPTER 7

Backing up to a CD-RW Drive

This chapter includes the following information:

- Overview
- Enabling Backup Features
- Overview of DirectCD®
- Formatting a CDR or CD-RW Disc
- Saving Video to a CD-RW Drive
- Removing the Disc from the Drive

7.1 Backup Overview

The DVR unit can easily backup important video to an internal or external media location. The most commonly used are CD-RW drives and Hard Drives. Since the DVR unit comes standard equipped with a CD-RW drive, this section covers backing up using the CD-RW drive as well as by using a Hard Drive.

The DVR unit backs up using a proprietary compression format that can only be read by the DVR Backup program. This ensures the integrity of the data. In addition the CD-RW also uses a proprietary format in which it stores the information. This format, called UDF, can only be read by a Computer which has the UDF reader software installed. A copy of Roxio® UDF Reader is on the Software Installation CD shipped with the DVR unit. A copy is also available for download from Roxio® direct (<http://www.roxio.com>).

During the backup process the DVR unit will never stop recording. The DVR unit is a multiplexing unit that can perform virtually all functions without having to stop the recording process.

In addition, you can now backup to multiple CDs when the file sizes exceed the size of one CD. Also, you can specify multiple locations to save to. For example you can save 1/3 the data to a CD, 1/3 the data to the local Drive and 1/3 the data to a network drive.

7.2 DirectCD® Format Utility

The Surveillix DVR unit uses DirectCD® 5.0 to save the data to a CD-RW Drive. This allows the DVR to use the CD-RW just as it would any other attached Hard Drive, both reading and writing to it. CDR and CD-RW discs must be formatted in the DirectCD 5.0 UDF standard for the DVR unit to recognize them. It is recommended that CDR discs, NOT CD-RW discs, be used in the DVR unit only because of the format time and cost difference between the two. It can take 45 minutes to an hour to format a CD-RW disc but only 15 to 30 seconds to format a CDR disc. In addition, CDR discs are generally considerably less expensive than CD-RW discs.

There are two ways to open the DirectCD format utility. The first is by exiting to windows. The second is by opening the Backup Window and pressing the Format CD button.

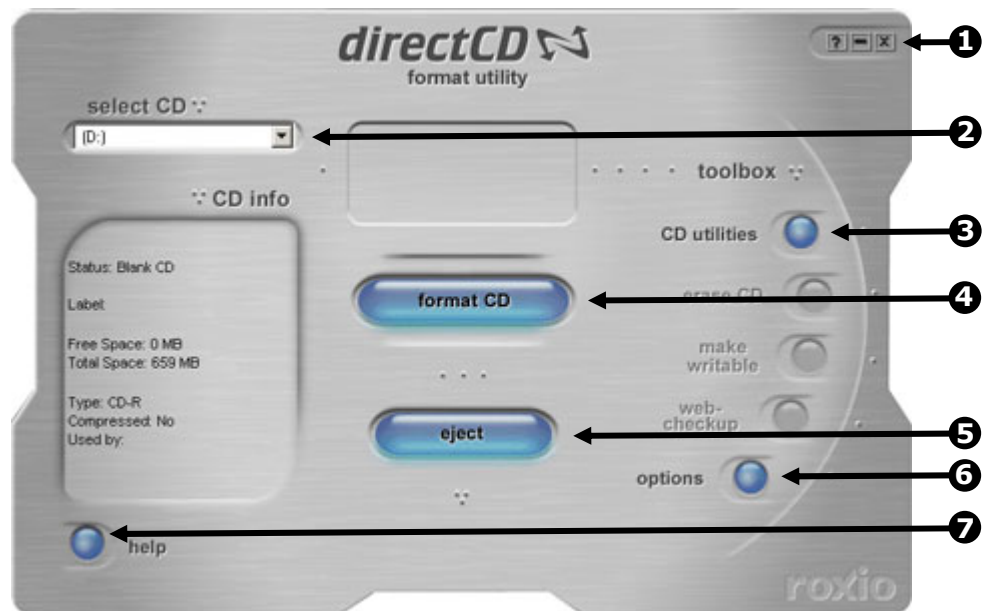

Figure 7.2
DirectCD® Format Utility

- 1 Window Control Buttons** – These buttons allow you to close or minimize the DirectCD format Utility window as well as bring up the Help screen.



CAUTION: Even though many features are available within DirectCD, it is highly recommended that you do NOT use any features within DirectCD other than those necessary for the standard exportation of video as outlined in this chapter. Loss of information or software instability could result

- 2 **CD Select** – Use this Dropdown Selection box to choose the CD-RW drive attached to the DVR unit. Generally it is defaulted to the proper CD-RW drive.
- 3 **CD Utilities** – Allows you to do repairs on discs that have become unstable or failed completely.
- 4 **Format CD** – Use this option to format a CDR or CD-RW so that it can be read by the DVR unit.
- 5 **Eject CD**– This option allows you to remove the CD from the drive after specifying how you would like to end the recording session.
- 6 **Options** – This button allows you to adjust options pertaining to the operation of DirectCD.
- 7 **Help** – This option opens the DirectCD help file.

7.3

Formatting a CDR or CD-RW from Windows

To format a blank CDR or CD-RW disc to be used by the DVR follow these steps:

WE STRONGLY RECOMMEND NOT USING CD-RW DISCS. CD-RW DISCS CAN TAKE UP TO 30 MINUTES OR MORE TO FORMAT AND HAVE COMPATIBILITY PROBLEMS.

Format a CDR or CD-RW Disc on the DVR unit

- 1) Exit and Restart in Windows Mode.
- 2) Insert a blank CDR or CD-RW disc into the CD-RW drive.
WE STRONGLY RECOMMEND NOT USING CD-RW DISCS. CD-RW DISCS CAN TAKE UP TO 30 MINUTES OR MORE TO FORMAT AND HAVE COMPATIBILITY PROBLEMS.
- 3) Double-Click the DirectCD icon located on the Desktop.
- 4) Press the FORMAT CD button.

The Disc should now be formatting. A CDR Disc will take anywhere from 15 to 30 Seconds to format and a CD-RW disk will take anywhere from 45-60 Minutes. When finished the CD READY window will open.

- 5) Press the OK button.
- 6) When finished Double-Click the DVR Icon located on the Desktop. This will open the DVR software.





Figure 7.3
DirectCD® CD Ready Window

7.4 Formatting a CDR or CD-RW from the Backup Window

To format a blank CDR or CD-RW disc to be used by the DVR follow these steps:

WE STRONGLY RECOMMEND NOT USING CD-RW DISCS. CD-RW DISCS CAN TAKE UP TO 30 MINUTES OR MORE TO FORMAT AND HAVE COMPATIBILITY PROBLEMS.

Format a CDR or CD-RW Disc on the DVR unit

1. Insert a blank CDR or CD-RW disc into the CD-RW drive.
2. Enter **Backup** and click the  button.
3. Click the  button in the DirectCD window which opens. The CD begins formatting. A CDR disc will take anywhere from 15 to 30 Seconds to format and a CD-RW disc will take anywhere from 45-60 Minutes. When finished, Direct CD will indicate it is ready for reading and writing.
4. Close the DirectCD window to return to **Backup**.

7.5 Backup Options Overview

The BACKUP OPTIONS window allows you to select the video you wish to save and also the location of where to save it.

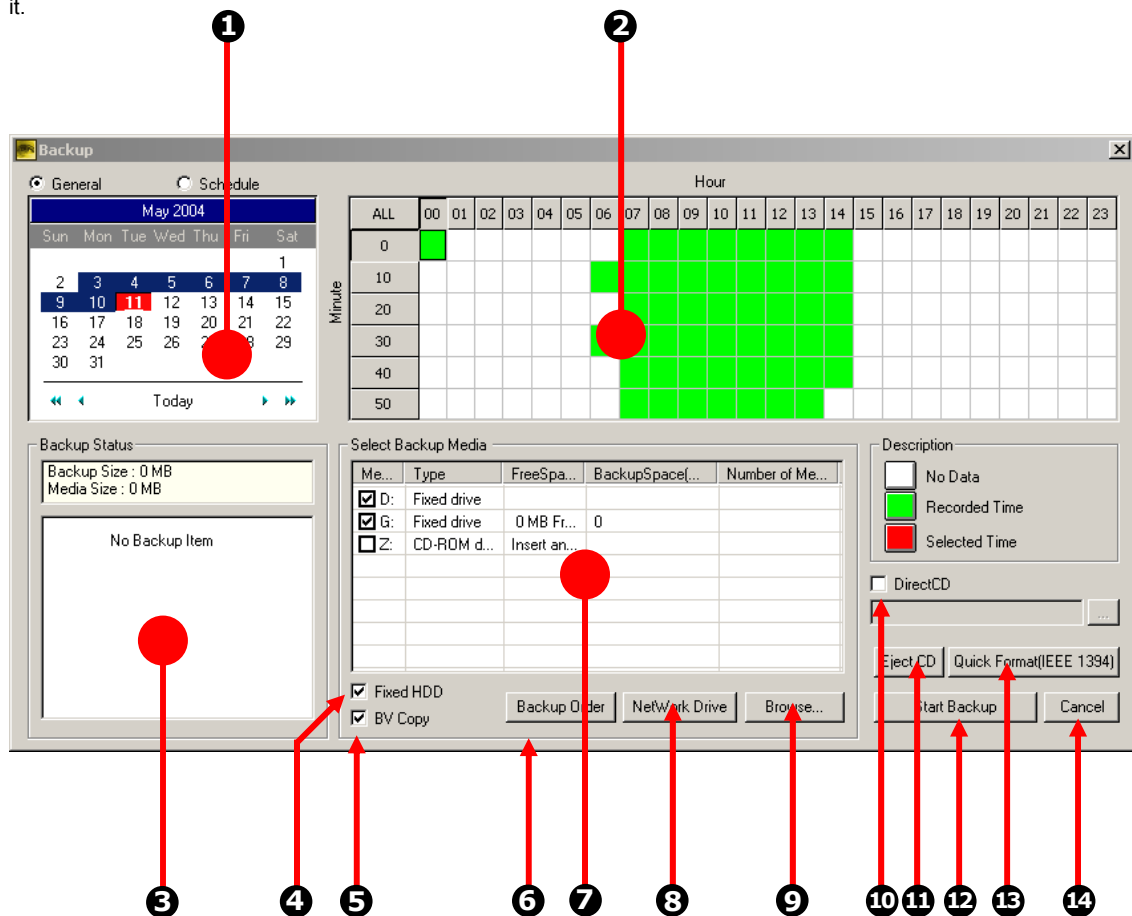

Figure 7.5
Backup Options Window

Figure 7.5

-
1. **Select Day** – The Select Day is a Calendar that allows you to select the day. If video is recorded on a given day the day will be highlighted. The Current day is always highlighted in red.

 2. **Hour/Minute** – The overall time displayed in the Hour/Minute chart is 24 Hours. This is broken down into 10 minute increments. The color coded boxes represent either, No data, Recorded Data, or Selected Data (See the Description Box). You can select a time by clicking on one the boxes. To deselect it, simply click on the box again.

 3. **Currently Selected Items** – This area will display time periods that are selected to be recorded. It will also display brief information about each selected time period. .

 4. **Fixed HDD** – By checking this box, all the available Hard Drives will be displayed inside the SELECT BACKUP MEDIA box.

 5. **BV Copy** – This option copies the Backup viewer onto the CDROM drive and also makes the CD Autoplay.

 6. **Backup Order** – This options allows you to specify the order of the drives you wish to backup to. This option would be used if you have a large amount of data that must be spread across several drives.

 7. **Backup Media Selection** – This area allows you to select the location you want to backup the data to. Select a location by placing a check in the appropriate box.

 8. **Network Drive** –This option allows you to select a Network location to save the data to.

 9. **Browse** – This option allows you to select a location to save the video. You would select this if the drive you wish to save it to is not displayed in the Backup Media Selection Window.

 10. **Direct CD** – This option allows you to select the location of Roxio's Direct CD® on the DVR. This option would be used when using multiple CDs to backup. When a asked to insert another CD an option will also be given at that time to forma the CD first.

 11. **Eject CD** – This option ejects the current CD from the DVR.

 12. **Start Backup** – Once the location and video has been selected, the Backup button begins the Backup process

 13. **Quick Format IEEE (1394)** – This option performs a quick format of the attached IEEE (1394) device

 14. **Cancel Backup** –This option cancels the current Backup procedure
-

7.6 Scheduled Backup Options Overview

The SCHEDULED BACKUP OPTIONS window allows the creation of a scheduled daily backup of selected times to a specified storage location.

NOTE: Available storage locations exclude CD-R and CD-RWs and are limited to hard disks specifically identified as backup space (see the specifying scheduled backup drives section in this chapter).

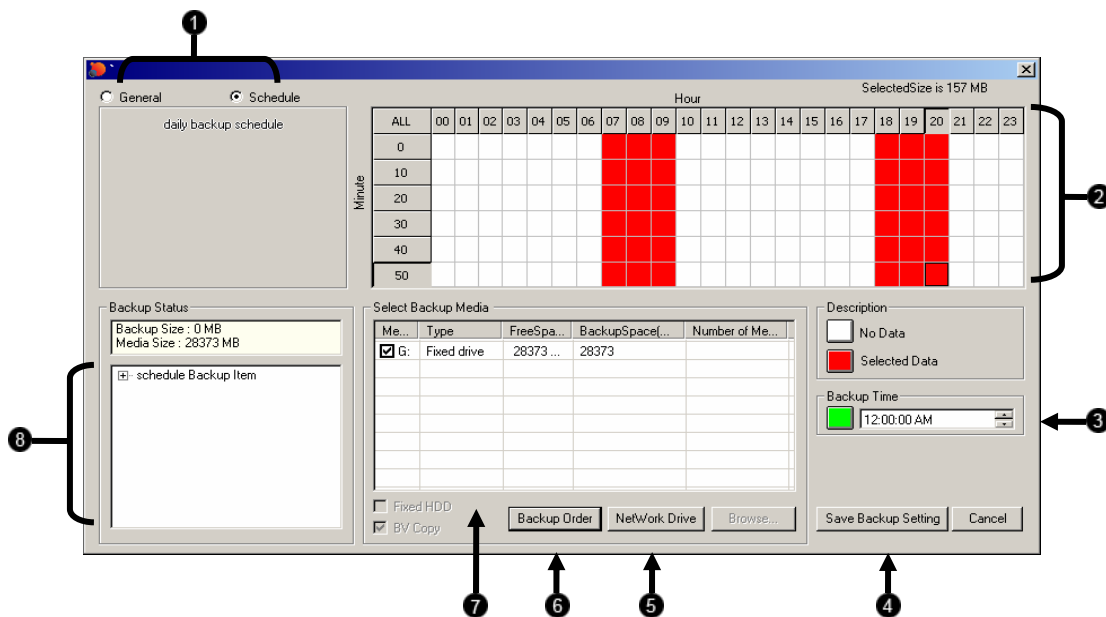

1. **General / Schedule** Switches between the General Backup window and the Scheduled Backup window.
2. **Hour/Minute** Displays a 24 hour time period in 10 minute increments. Color coded boxes represent "No data," "Recorded data," or "Selected data." Select a time by clicking on one of the boxes; deselect it by clicking on it again.
3. **Backup Time** Specifies at what time the Backup Schedule is executed.
4. **Save Backup Setting** Saves the current settings for scheduled backup. The current recording schedule if any will now be executed daily.
5. **Network Drive** Used to connect to a drive over a network.
6. **Backup Order** Used to specify the order in which multiple drives are used to record backup video to.
7. **Select Backup Media** Displays available storage drives. Use this window to select the drives you wish to save video files to.
8. **Backup Items** Displays the dates and times of events currently selected to backup.

7.7 Specifying Scheduled Backup Drives

In order to use the Scheduled Backup feature one or more storage drives or partitions connected to the DVR must be labeled as a backup drive.

Specifying Scheduled Backup Drives

1. Exit and restart in Windows mode.
2. Double click the **My Computer** icon on the DVRs desktop. A file menu will be displayed.
3. Right click on the drive you wish to specify as a backup drive for Scheduled Backup and select rename. Rename the drive to 'Backup'. Repeat this process for all drives you wish to use for Scheduled Backup. To remove a drive from use for Scheduled Backup change its name back to DVR.
4. Restart the DVR and return to the **Scheduled Backup** window.

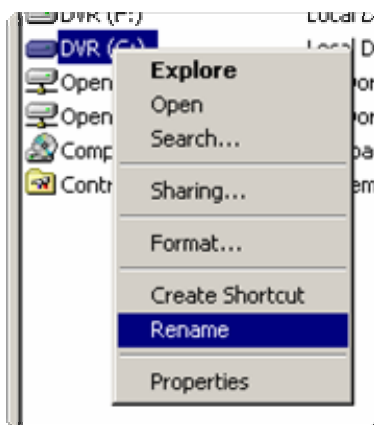

7.8 Creating Scheduled Backup

Creating Scheduled Backup

1. Enter **Backup** and select the **Schedule** radio button at the top of the window.
2. Select the times to backup by clicking on the desired blocks. The blocks will turn red when selected. Click a block again to deselect it.
3. Set the time to run Scheduled Backup in the provided space under Backup Time.
4. Specify the drive or drives to save the backup video to and set backup order.
5. Click . The window will automatically save and close.

NOTE: Only one daily Scheduled backup is allowed. To overwrite the existing schedule simply reenter the Scheduled Backup window set a new schedule and save.

7.9 Backing up to a CD-RW Drive or Hard Drive

To Backup video files to a CD-RW drive, or to a Hard Drive, follow these steps:

Backing up to a CD-RW Drive or Hard Drive

1. From the Main Display Screen select the BACKUP button. The Backup Options window displays.
2. From the Backup Options window, use the calendar to select a date.
3. Select the time(s) to backup by clicking on the desired blocks. The blocks will turn red when selected. To deselect the blocks, click on them again.
4. To backup to CD media, insert a blank CD and follow the instructions for formatting a blank disk outlined in this chapter. Click on the corresponding CD-R/W drive that is displayed inside the Select Backup Media box and when prompted indicate the number of CDs needed to store the backup video (eg. 980MB of video / 600MB of storage per disk = 1.63 so 2 disks would be needed) . Click the button.

To backup to a hard drive, check the box for Fixed HDD. Select the correct hard drive from the Select Backup Media box, then press the button.

If the amount of video exceeds the storage capacity of the media being used then an error message will be displayed inside the error message box. If this happens, reduce the amount of video that is being exported, increase the compression, select another media device, or span the file over multiple disks/drives.

Once the button is pressed, the Backup Options window will close.

The status of the recording process can be monitored by viewing the Backup Progress bar. This can be seen on the Main Display screen.

The Backup will be completed successfully when the Backup Progress Bar disappears from the Main Display Screen.

7.10 Removing the Disc from the CD-RW Drive

To remove the disc from the CD-RW drive follow these steps.

Removing the Disc from the CD-RW Drive

- 1) Press the Open button on the CD-RW drive.

The Eject CD Window should appear on the screen.

- 2) Select the LEAVE AS IS option to continue using the disc for future Backing Up by the DVR unit. You may not be able to read the disk in other CDROM drives if this is selected unless the
Select the CLOSE TO READ ON ANY COMPUTER option to close and allow the data to be read in most CDROM drives.
- 3) Press OK.

The CD-RW drive door should open. Remove the disc and place in a protective sleeve or case.

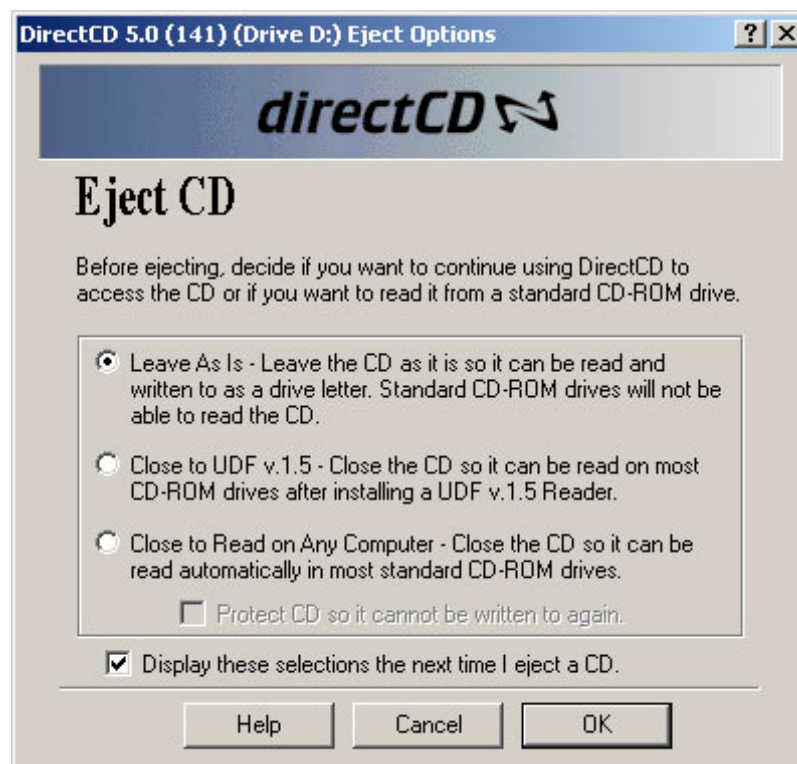

Figure 7.10
Remove Disc from Drive

7.11 Setting the DirectCD Path using vFormat

It may be necessary under some circumstances to reset the file path to the DirectCD executable. If the format button in the Backup window is not displayed follow the instructions below. (See the section on the Backup window in this chapter for the location of the Format button)

Setting the DirectCD Path using vFormat

1. Exit to Windows.
2. Click **Start** → **Programs** → **Surveillix** → **vFormat**.
3. Select the DirectCD check box. Locate the Directcd.exe file in the window which opens and click Open.
4. Click OK and restart the DVR.

Note: The default location of Directcd.exe is `C:\Program Files\Roxio\Easy CD Creator 5\DirectCD\Directcd.exe`

7.12 Confirm Windows Password using vFormat

It may be necessary under some circumstances to confirm the Windows system password in order for the **Scheduled Backup** function to work. If the **Scheduled Backup** radio button is grayed out and cannot be selected follow the instructions below. (See the section on the Backup window in this chapter for the location of the Scheduled Backup radio button)

Confirm Windows Password using vFormat

1. Exit to Windows.
2. Click **Start** → **Programs** → **Surveillix** → **vFormat**.
3. Click the **Confirm Windows System Password** Button.
4. Enter the Windows System Password and click **OK**.
5. Click **OK** and restart the DVR.

Note: The default Windows System ID is 'DVRadmin' and Password is 'dvr4321'.

CHAPTER 8

LAN / ISDN / PSTN Connections

This chapter includes the following information:

- Overview
- Configuring TCP/IP
- Setting up a PSTN Connection
- Creating Users for PSTN Connections

8.1 LAN Overview

The DVR unit can easily be connected to a Local Area Network. The DVR unit uses Microsoft's powerful and secure Windows® 2000 operating system. This allows for easy and well documented instructions on setting up LAN connections no matter what type of LAN you want to use.

A Local Area Network is a group of computers and other devices dispersed over a relatively limited area and connected by a communications link that allows one device to interact with any other on the network. Local Area Network is also called LAN.

Examples of LAN connections include Ethernet, Token Ring, cable modems, DSL, FDDI, IP over ATM, IrDA (Infrared), wireless, and ATM-emulated LANs. Emulated LANs are based on virtual adapter drivers such as the LAN Emulation Protocol.

There are a vast amount of reasons why using Microsoft® Windows® 2000 is far superior to other platforms when running on a LAN. The number one reason is security. Windows 2000 is based on NT technology, which, historically has boasted the most reliable and secure Operating System in the world. Running the DVR on a secure network is important to prevent unwanted users from gaining access to confidential information. Unwanted users can compromise the integrity of the confidential data being stored and viewed, and in extreme circumstances can cause irreparable damage to the network.

Since connecting the DVR unit to a network can be extremely complex (depending on the network), this Surveillix™ DVR™ manual will cover only the basics. It is suggested that you consult your Vendor or IT Administrator before attempting to create or connect to a LAN.

8.2 Connecting to a LAN using TCP/IP

The DVR unit allows you to fully create and edit all Network settings available on Windows 2000. The DVR unit comes equipped with a 10/100 Network Interface Card (NIC). This card uses a standard RJ-45 connector.

The DVR unit comes preconfigured with an IP Address of [10.0.0.130] and a subnet mask of [255.255.255.0]. These IP settings will work for many users. If these IP settings are sufficient then you will not need to Configure TCP/IP.

Configuring TCP/IP Settings

- 1) Exit and Restart in Windows Mode (See Section 3.3).
- 2) Right-click on the MY NETWORK PLACES Icon located on the desktop and select PROPERTIES.
You should now see the NETWORK AND DIAL UP CONNECTIONS Window appear.
- 3) Right-Click on LOCAL AREA CONNECTION and select PROPERTIES.
You should now see the LOCAL AREA CONNECTION PROPERTIES Window appear..
- 4) Select the INTERNET PROTOCOL (TCP/IP) by clicking on it once. Once highlighted, select the PROPERTIES button.
The INTERNET PROTOCOL (TCP/IP) PROPERTIES Window should open.
- 5) Select USE THE FOLLOWING IP ADDRESS option. Enter the IP Address and Subnet mask appropriate for your network. It is recommended that you contact your Network Administrator for appropriate IP settings.
Example: Common IP addresses are 10.0.0.25 – Common Subnet masks are 255.255.255.0

! **NOTE:** In order to connect to the DVR unit through a remote LAN connection, you must assign the DVR a static IP address. If you are on a network that assigns the IP address automatically (DHCP), contact your Network Administrator for help assigning a static IP address.
- 6) If your network requires you to specify your DNS information, enter it now by selecting the appropriate DNS options.
- 7) When you have finished configuring your TCP/IP settings close the INTERNET PROTOCOL (TCP/IP) PROPERTIES Window by clicking the OK button.
- 8) Close the LOCAL AREA CONNECTION PROPERTIES Window by clicking the OK button.

-
- 9) You may need to restart Windows for the changes to take effect. Do this by pressing the START button on the Desktop and selecting Shut Down.
-

Connect the DVR to a LAN

- 1) Using a standard RJ-45 Cable, plug one end into a Hub (or Network Jack ultimately connected to a hub) and the other end into the DVR unit. (See Section 1.3)
-

CHAPTER 9

Digital Signature Verifier

This chapter includes the following information:

- Overview
- Using the Digital Signature Verifier

9.1 Digital Signature Overview

JPG and AVI files that are exported from the DVR are automatically embedded with a Digital Signature. These Digital Signatures are a way to verify the authenticity of the image to ensure that they have not been tampered with or edited in any way. Included on the Software Installation disc supplied with the DVR unit is the Digital Signature Verifier program. This program can be installed on any computer and verifies an image in question.

9.2 Installation

Installing the Digital Signature Verifier

- 1) Insert the Software Installation Disc into the CDROM. (Do not install on the DVR unit)
- 2) Select the Digital Signature Verifier option to begin installation. When the WELCOME screen appears, select NEXT.

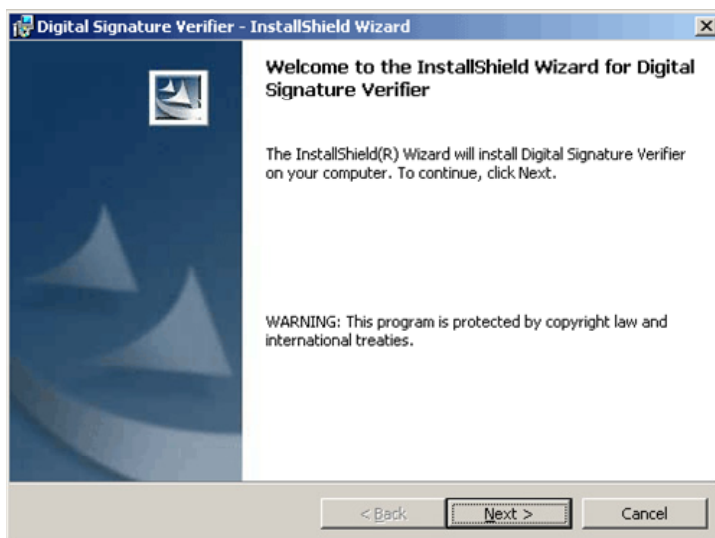

- 3) When the SETUP COMPLETE window appears select FINISH.

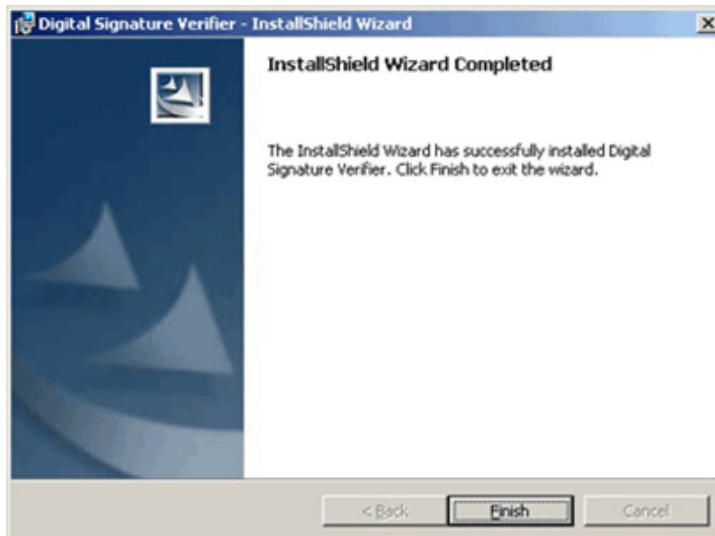

9.3 Using the Digital Signature Verifier

- 1) Open the Digital Signature verification program by selecting START>PROGRAMS>DVR>DIGITAL VERIFIER>DIGITAL SIGNATURE VERIFIER.

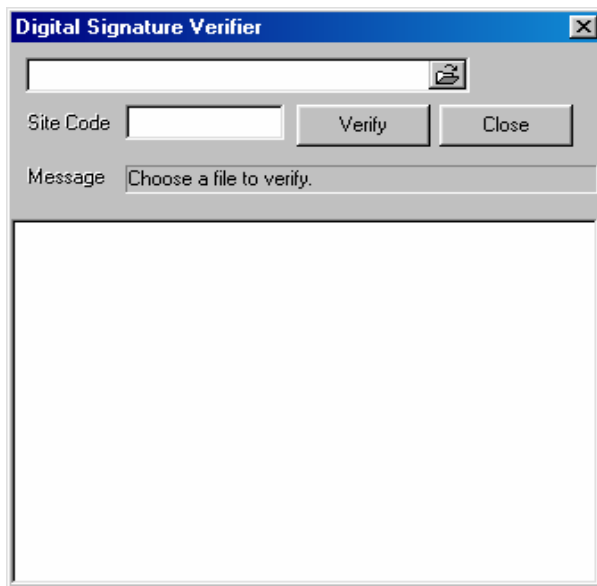

- 2) Select the BROWSE button to load the JPG or AVI image.
- 3) Enter the SITE CODE of the DVR unit that the image was originally extracted from.
- 4) Press the VERIFY button.

If the image has not been tampered with, the program will display a message that says "Original image file."

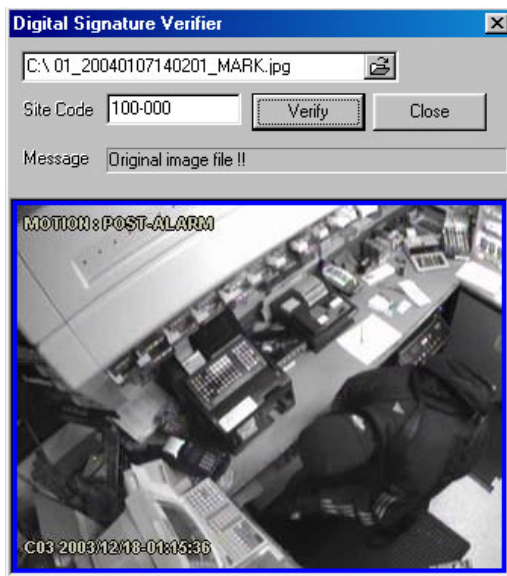

If the image has been tampered with, then a red square will be drawn around the image and a message will appear saying "Entire image changed or wrong SITE CODE."

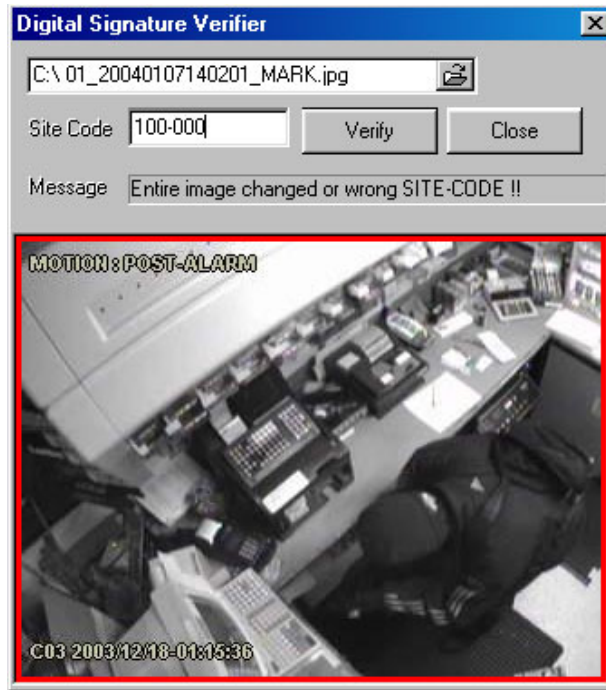

CHAPTER **10**

Backup Viewer

This chapter includes the following information:

- Overview
- Using the Backup Viewer

10.1 Backup Viewer Overview

The Backup Viewer allows you to play back the exported video in its proprietary format. Video saved in this format is extremely difficult to tamper with and therefore is the ideal solution when law enforcement and the legal department are involved. This video cannot be read by any other viewer.

The Backup Viewer is essentially the search portion of the DVR software. For Detailed explanation of these functions, refer to Chapter 5.

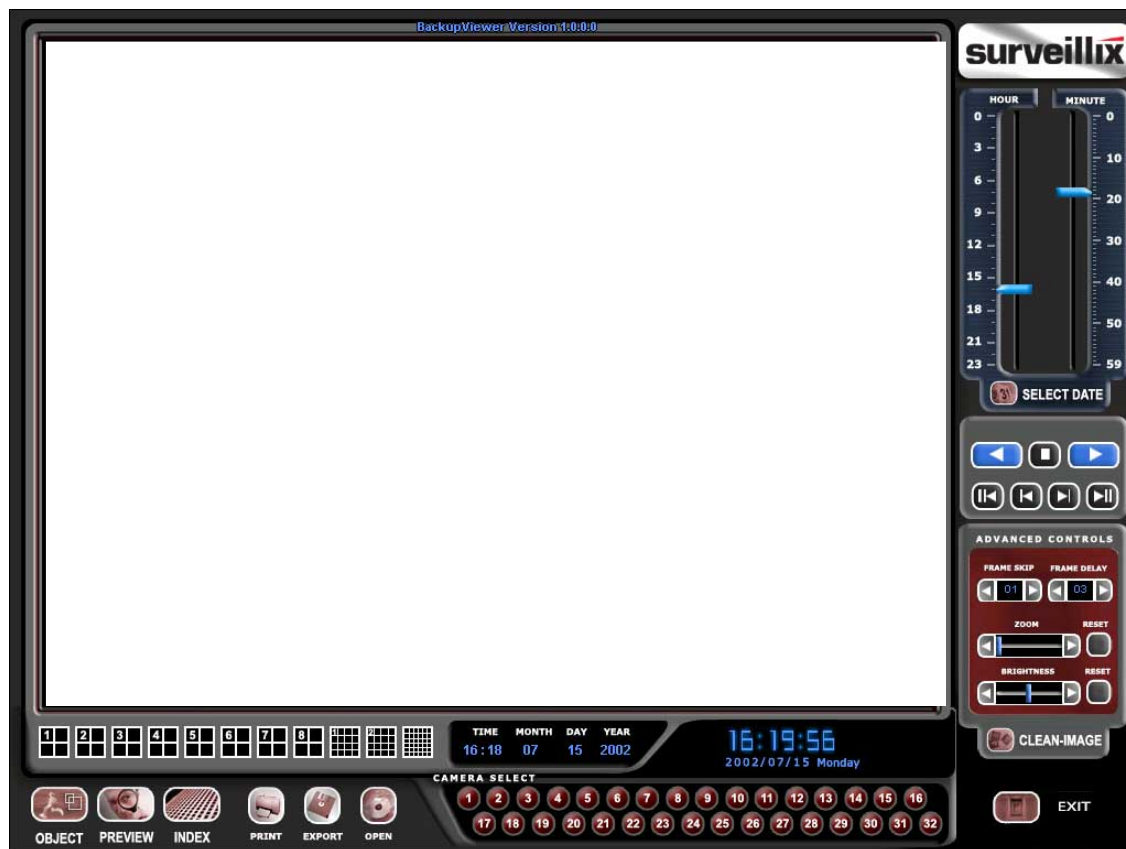
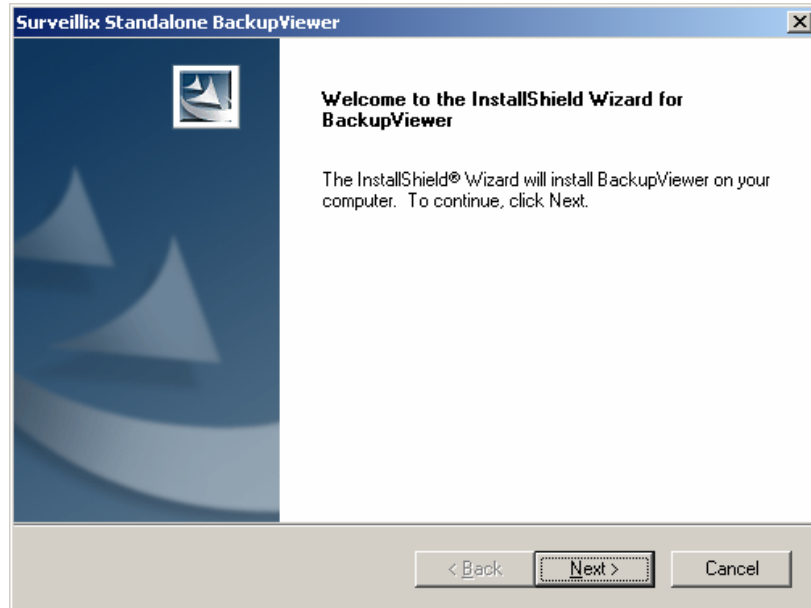

Figure 10
Backup Viewer

10.2 Installation

Installing the Backup Viewer

- 1) Insert the Software Installation Disc into the CDROM. (Do not install on the DVR unit)
- 2) Select the Backup Viewer option to begin installation. When the WELCOME screen appears, select NEXT.



- 3) When the CHOOSE DESTINATION LOCATION window appears select NEXT.

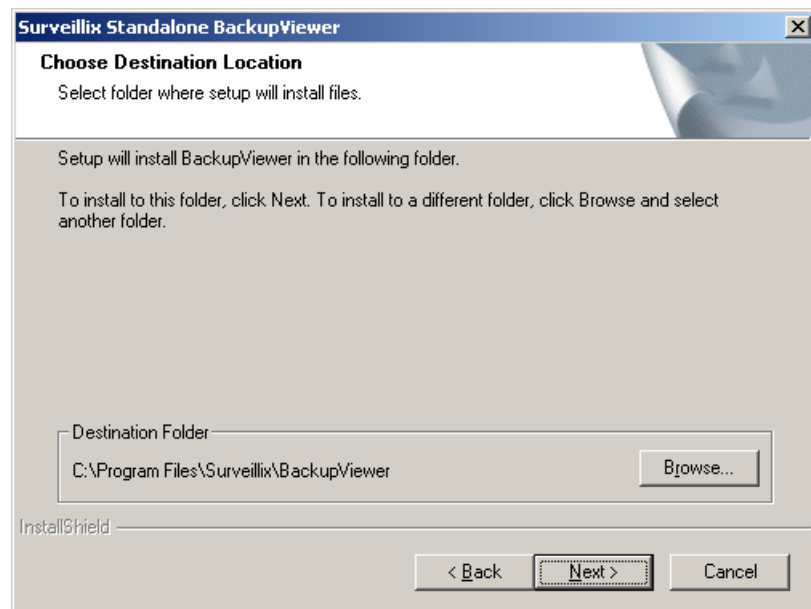

-
- 4) When the SELECT PROGRAM FOLDER window appears click NEXT.
-

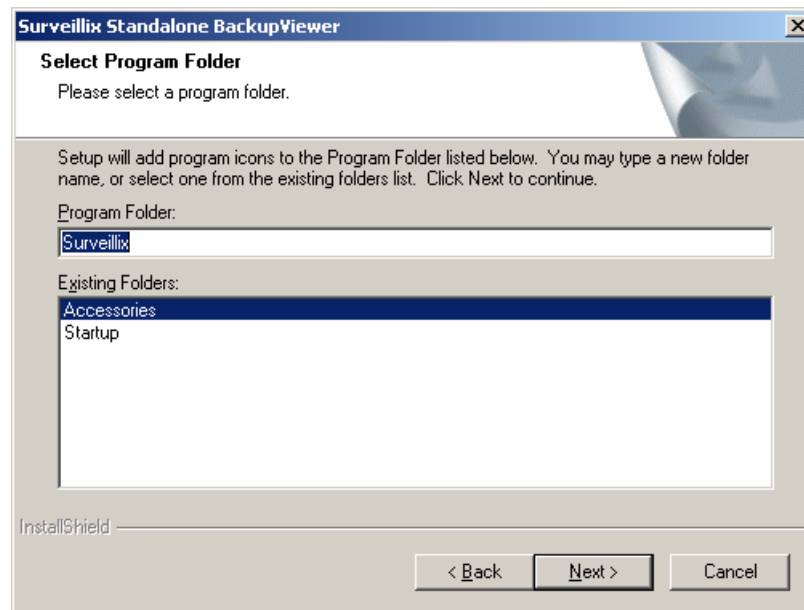

-
- 5) Select either 16 or 32 channel option depending on the Model you have. You can always reinstall and change this option at a later date. Click Next.
-

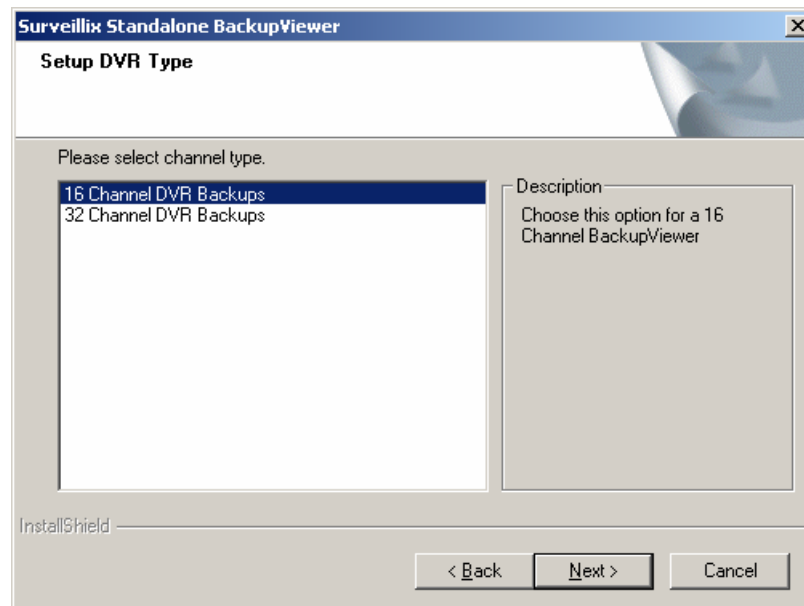

-
- 6) If you have purchased the TVS POS Remote then select the YES option. Otherwise select the NO option. Click Next.
-

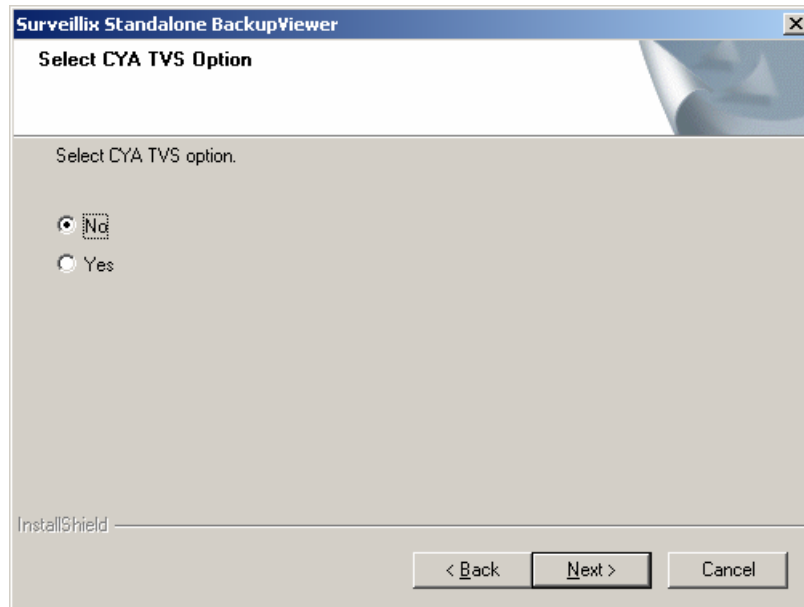

-
- 7) When this window appears click **Finish**. Setup is now complete.
-

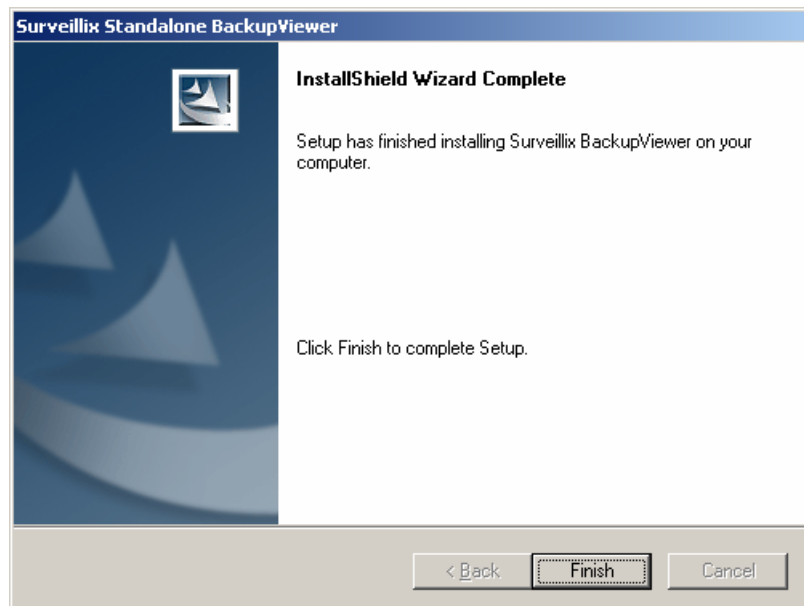

10.3 Loading Video from CDROM or Hard Drive

Loading video into the Backup Viewer involves only a few simple steps.

- 1) Open the Backup program by selecting START>PROGRAMS>DVR>BACKUP VIEWER>BACKUP VIEWER.
- 2) Select the OPEN button (See Section 5.7). The CHOOSE TIME TO SEARCH window should open.
- 3) For CDROM data select the appropriate CDROM drive letter from the BACKUP MEDIA box. For Hard Drive data either select an attached Hard Drive under the BACKUP MEDIA window or select the OPEN FOLDER icon. The Open Folder icon allows you to browse to the specified directory.
Once selected any available video data will be displayed in the CHOOSE START HOUR box.
- 4) Select a time to play by clicking on the desired time.
- 5) Press OK.

The Video should now be loaded into the Backup Viewer. To view the video simply follow the instructions for Searching as explained in Chapter 5.



Figure 10.3

CHAPTER **11**

Emergency Agent

This chapter includes the following information:

- Overview
- Using the Emergency Agent Software

11.1 Emergency Agent Overview

The Emergency Agent software is a utility that streams video across a Local Area Network to a Client PC when an alarm is detected on the DVR unit. The video that streams across can be stopped, played forwards and backwards, in slow motion or real speed.

The utility is loaded at startup and placed in the taskbar. It constantly monitors for a signal from the DVR unit. When an alarm signal is detected the Emergency Agent Image Viewer window opens and starts playing the video from the camera associated to the alarm.

11.2 Installing the Emergency Agent

- 1) Insert the Software Installation Disc into the CDROM. (Do not install on the DVR unit) Select the Emergency Agent option to begin installation and accept the license agreement.

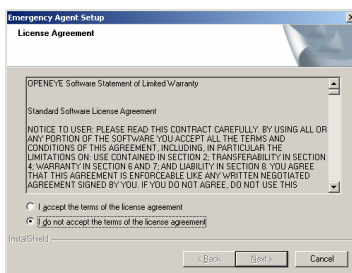

- 2) When the WELCOME screen appears, click NEXT.

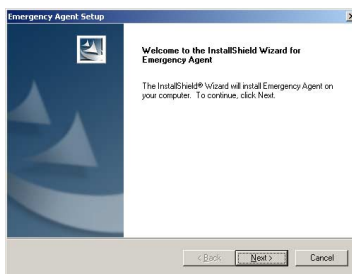

- 3) When the CHOOSE DESTINATION LOCATION window appears click NEXT.

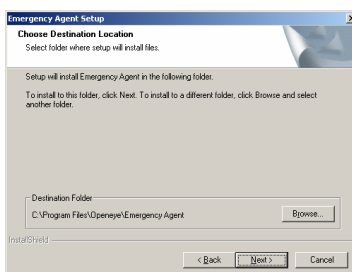

-
- 4) When the SETUP COMPLETE window appears click FINISH.
-

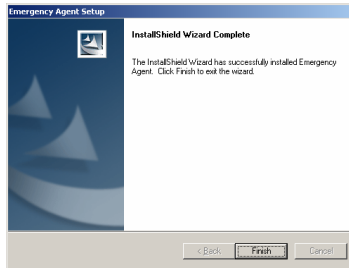

11.3 Configuring the DVR

To enable the Emergency Agent on the DVR follow these steps:

-
- 1) Enter SETUP and confirm you are in the CAMERA SETUP menu.
-
- 2) Select a camera and then associate sensor(s) to that camera using the SENSOR CONNECTION checkboxes.
-

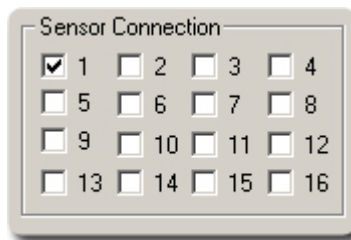

-
- 3) Click the Communication Setup button and make sure that DISABLE REMOTE CONNECTIONS is not checked in the Communication Setting menu.
-
- 4) The Emergency Agent uses one port to transfer the data through. The port can be adjusted inside the Communication Setting Menu if necessary. It is recommended that unless the port must be changed, that the default setting should be used.
-
- 5) Enter the IP Address of the computer running the Emergency agent software in the Emergency IP in the Network Setup section.
-
- 6) Click OK.
-
- 7) Select the Sensor & Control menu tab.
-
- 8) Enable the Sensor you wish to use.
-
- 9) Adjust the record, delay, output, and duration settings. (See the Sensor & Control section in the Setup Option Chapter for descriptions of these functions).
-
- 10) Click OK.
-

11.4 Configuring the Client PC

All configuration takes place in the Emergency Agent Window on the Client PC for descriptions and locations of the buttons and features of the Emergency Agent window Refer to the Emergency Agent Window section later in this chapter.

- 1) Open the Emergency Agent window on the Client PC.
Start >Programs > Toshiba > Emergency Agent > Emergency Agent
- 2) Click New in the DVR List and enter the site code, site name, and IP Address of the DVR you wish to connect to in the Site Edit window that opens. Click Save

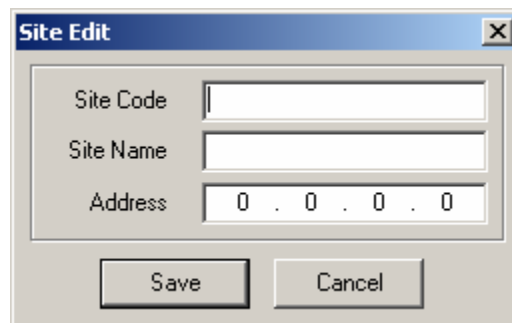

The image shows a 'Site Edit' dialog box with the following fields and buttons:

- Site Code:
- Site Name:
- Address:
- Buttons: Save, Cancel

- 3) Click the Tools menu and select Setup.
- 4) Confirm that the Listen Port in the **Configuration Window** is set to the same number as the Emergency Port in **Communication Settings** on the DVR. If the numbers are different adjust the Listen Port on the client PC to match the DVR.
- 5) Click Enter
- 6) Reboot the Client PC

11.5 Emergency Agent Window

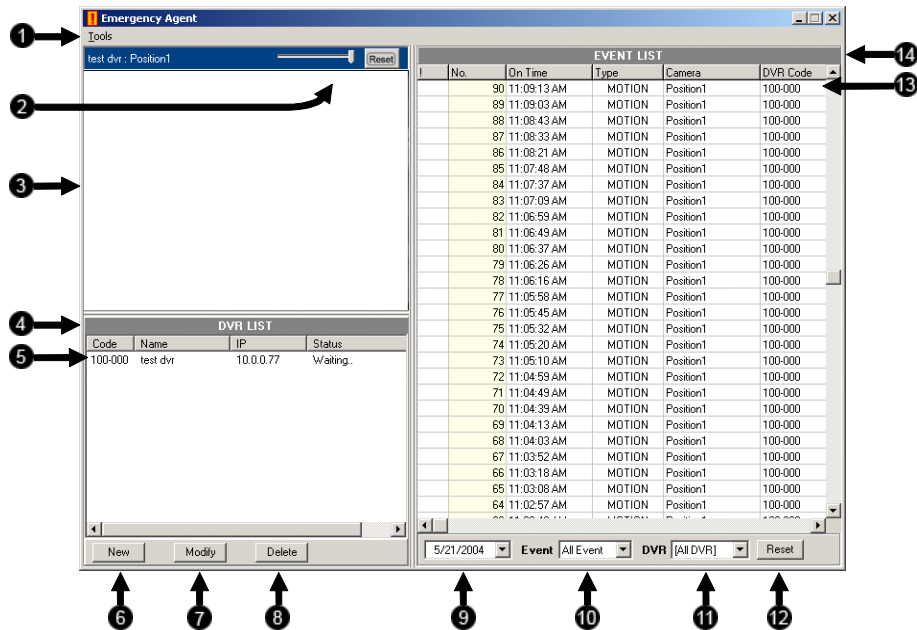

1. **Tools Menu** Opens the Setup (Configuration) window and Opens or Closes the Event List.
2. **Video Display** Displays the Video feed coming from the DVR.
3. **DVR List** Lists all DVR units you have connected to the Emergency Agent.
4. **DVR List Item** Individual DVR unit in DVR List with displayed settings.
5. **New** Opens Site Edit window to connect new DVR to Emergency Agent.
6. **Modify** Opens Site Edit to allow modification of selected DVR List Item.
7. **Delete** Deletes selected DVR List Item.
8. **Date** Selects date of events to display in the Event List.
9. **Event** Selects type of Event to Display in the Event List.
10. **DVR** Selects DVR to display in the Event List.
11. **Reset** Resets Date, Event, and DVR fields to defaults.
12. **Event List Item** Individual Event in Event List. Double-Clicking on an event opens the associated video in the Search Alarm window.
13. **Event List** Lists all recorded events matching the Date, Event, and DVR settings.

11.6 Search Alarm Window

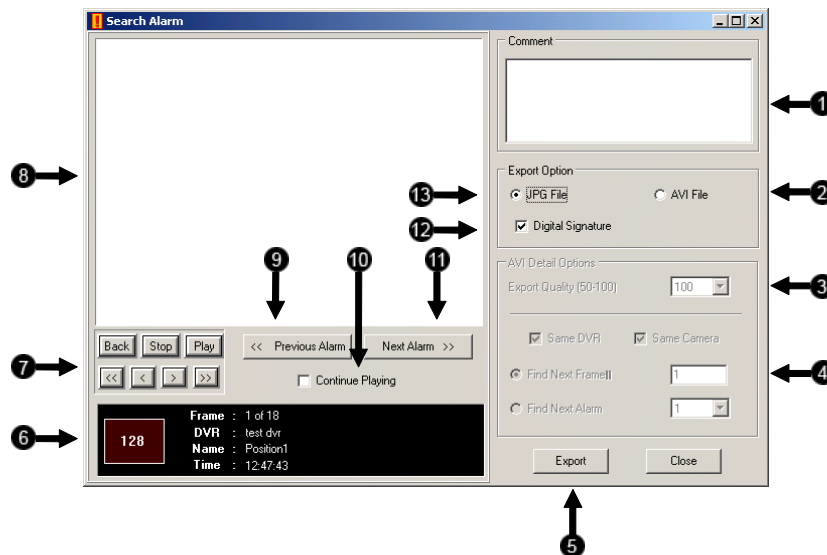

1. **Comment** Provides space for user to add comments to exported video.
2. **AVI File** When selected a video clip exported when Export is clicked.
3. **Export Quality** It may be necessary to reduce the overall size of an AVI file; for example, to email to someone. AVI file sizes can be reduced by reducing the image quality. However, reducing the image quality causes the AVI video to appear more pixelated. When size is not an issue, setting quality to 100 is highly recommended.
4. **Export Options** These options are only available when AVI export is selected and relate to the export options of the AVI video.
5. **Export** Exports AVI or JPG file to selected location.
6. **Alarm Event Information Display** Displays the event number and pertinent recorded information related to the alarm event.
7. **Playback Controls** The play controls allow you to play the video forward, backwards, and frame by frame.
8. **Display** Displays video playback.
9. **Previous Alarm** Moves to previous Alarm Event.
10. **Continuous Playing** Playing plays through all alarm events when video playback is initiated. When not selected video playback stops at end of recorded event.
11. **Next Alarm** Moves to next Alarm Event.
12. **Digital Signature** Adds a digital signature to the exported JPG image for use with the Digital Signature Verifier to verify integrity of exported images and prevent tampering.
13. **JPG File** When selected a JPG image is exported when Export is clicked.

11.7 Configuration Window

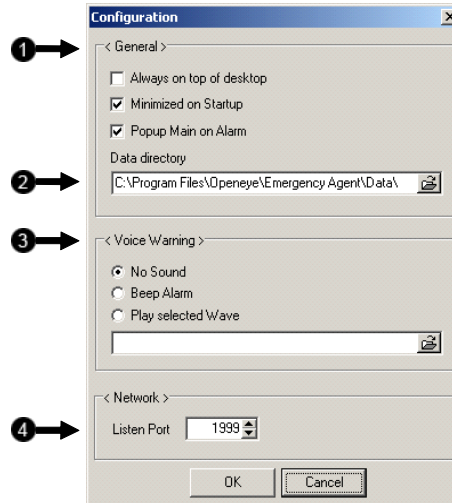

- 1. General** Offers configuration of basic display options for the Emergency Agent window.
- 2. Data Directory** Sets the location that recorded video footage is saved.
- 3. Voice Warning** Offers several configuration settings for activating an audible indicator when the Emergency Agent receives an event.
- 4. Listen Port** Indicates the port which the Emergency Agent uses to listen for incoming events. This number should be changed to the same number as is set in the Emergency Port in Communication Settings on the DVR.

CHAPTER **12**

Web Viewer

This chapter includes the following information:

- Overview
- Configuring the Web Viewer

12.1 Web Viewer Overview

The DVR unit allows you to access video using Microsoft® Internet Explorer® Browser 5.5 and later

Highlights:

View Live Video from most computers

Username and Password protected

Easy to use graphical interface

Basics:

75 users can access the Web DVR simultaneously. The Web DVR is an easy secure way to view live video from virtually any computer with an internet connection using Microsoft Internet Explorer.

In order to log in to the DVR server, a user account must be made for the user. This ensures that only authorized personnel are allowed to log in. In addition, each user can be assigned different privileges that allow them or deny them access to different functions. (See Section 5.9 – User Management.) For example, a user can be granted access to only view cameras 4, 8 and 16.

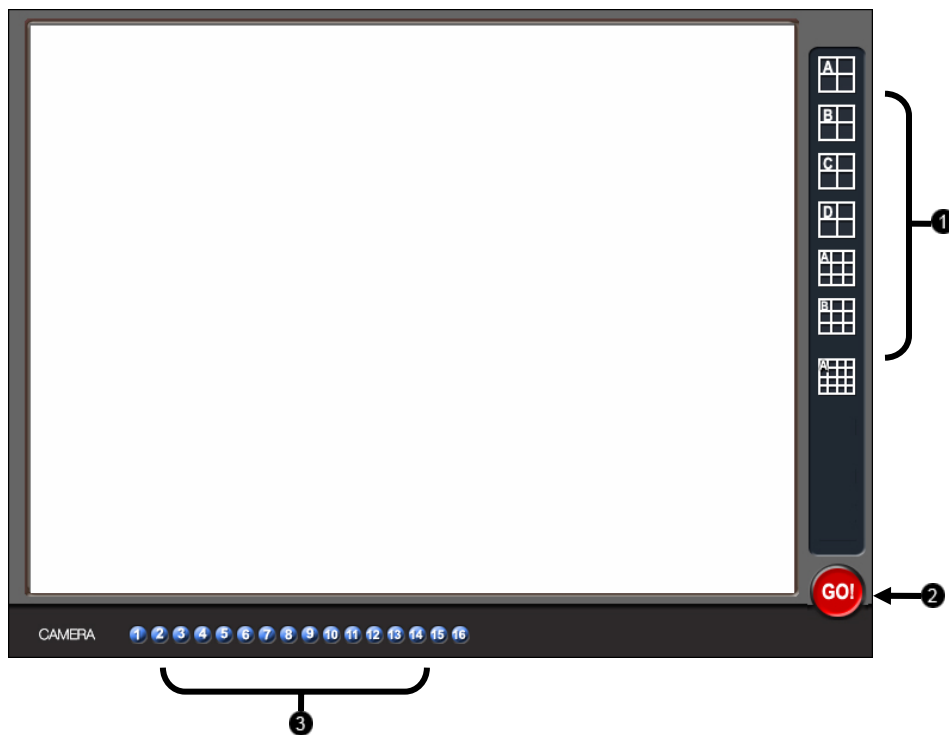

1. **Screen Division Buttons** Allow you to view one or more sets of cameras at a time. They are organized in several different groups such as 1x1, 4x4, and 8x8.
2. **GO!** Activates the commands
3. **Camera Buttons** Enable or disable selected cameras for use when searching.

12.2 Configuring the Server for Remote Connection

1. Enter Setup on the DVR unit.
2. Click the **Communication Setup button** to open the Network menu.
3. Uncheck the Disable Remote Control option.
You should now be allowed to adjust port settings if necessary.
4. NOTE: If you are using a Firewall, it may be necessary to adjust the port settings on both the DVR and the Firewall. Contact your Network Administrator for more information.
5. Press OK.
6. Make sure a User account is created.
Without a user account, the Administrator account must be used.

The DVR server is now ready to receive incoming connections.

12.3 Connecting to a DVR using Web Viewer

1. Open Microsoft® Internet Explorer® 5.5 or later.
2. Enter the IP address of the DVR into the Address Bar.
3. When attempting this for the first time on a Computer a window will open and you will be asked to accept an Active X installation. Select Yes to this.

NOTE: If you receive a message saying your Internet Explorer® security settings do not allow you to download Active X components then you will need to adjust your browser security settings. One way to do this is to add the IP address of the DVR to your trusted sites list inside Internet Explorer® settings. Contact your System administrator for additional help with adjusting Internet Explorer® settings.

4. When the Web Viewer finishes loading select one or more cameras (or select a screen division button).
5. Press GO!
6. A login window will appear. Enter a Username and Password that is authorized to access the DVR.
7. The cameras will now be displayed.

12.4 Closing the Web Viewer

The DVR unit allows you to access video using Microsoft® Internet Explorer® Browser 5.5 and later.

1. To exit the Web Viewer simply close Internet Explorer®.

CHAPTER **13**

Remote Software

This chapter includes the following information:

- Overview
- Configuring Remote Software

13.1

Remote Software Overview

The DVR unit was specifically designed to be fully operated and maintained remotely. It connects using the standard TCP/IP protocol through connection types such as DSL, Cable Modem, T1, ISDN, 56K Modem, LAN, and more. The Surveillix Remote software allows you to view live video, search through archived video, export images and video clips and have virtually full Setup control.

Highlights:

Search archived video

View live video

Export images and video clips

Control relay outputs

Setup administration

Basics:

The DVR can have up to 5 Simultaneous remote Connections. Each user can perform functions on the DVR unit and will not affect the other users. The only exception to this is accessing Setup. Only one user is allowed to access setup at any given time. The Frames per Second passed to the Remote Client varies greatly depending on the connection type and speed.

In order to log in to the DVR server, a user account must be made for the user.

This ensures that only authorized personnel are allowed to log in. In addition, each user can be assigned different privileges that allow them or deny them access to different functions. (See Section 5.9 – User Management.) For example, a user can be denied Searching and Setup privileges and only granted access to view cameras 4, 8 and 16.



It is highly recommended that users not be granted Setup privileges since this can pose a security risk. Only proper authorized Administrators should have access to Setup.

The Remote software operates virtually the same way as the DVR itself.

The appearance of it matches the DVR almost identically, however, there are a few minor differences. Some search features are not available (such as the Index and Object Searches) as well as some Setup options.

13.1.1 Remote Client Minimum Requirements

- Pentium 233 or equivalent
- 32MB System Memory
- DirectX 8 or higher
- Compatible video card (ATI Preferable)
- Internet or LAN Connection (56K, DSL, Cable Modem, T1, ISDN, etc.)
- TCP/IP installed
- Microsoft® Windows® 98, Me, 2000, or XP Operating System
- 1024 x 768 display resolution
- 16 Bit color depth or better

13.1.2 Remote Client Recommended Requirements

- Pentium IV 1.5+ or equivalent
- 256MB System Memory
- DirectX 8 or higher
- Compatible video card (ATI Preferable)
- Internet or LAN Connection (DSL, Cable Modem, T1, ISDN, etc.)
- TCP/IP installed
- Microsoft® Windows® 2000 or XP Operating System
- 1024 x 768 display resolution
- 32 Bit color depth or better

13.2 Remote Software Setup

13.2.1 Installing Remote Software

1. On the Client computer, insert the Surveillix Software CD into the CD-ROM. The CD should play automatically.
 2. When prompted, select the Install Remote Software option. Follow the installation instructions carefully.
 3. When the software finishes installing, close any open installation windows.
-

13.2.2 Create a New Remote Connection

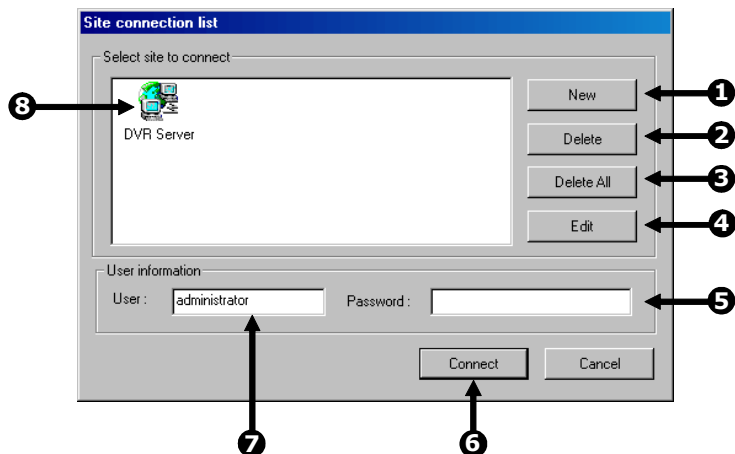

1. **New** Creates a new site to connect to.
2. **Delete** Deletes the selected site once it is selected from the list.
3. **Delete All** Deletes all listed sites.
4. **Edit** Used to edit a site once it is selected from the list.
5. **Password** Enter the logon password.
6. **Connect** Connects the Surveillix Remote Client to the Server.
7. **User** Enter the Login Username.
8. **Site** Displays a list of pre-configured sites.

Creating a New Remote Connection

1. Select Start → Programs → DVR → Center → DVR Center.
The Toshiba Surveillix Center Software opens and a Site Connection List window opens.
2. Press New to open the Site Detail Information window.
3. Enter the Site Code and Site Name. The Site Code will be the name displayed inside the connection box to help you identify the unit.
4. Enter the IP Address of the DVR server.
By default the DVR unit is set to connect using DHCP.
5. Enter the Center Port. This setting is specified on the server (See Section 13.2.)
6. Press OK.
7. Click on the newly created connection and enter the login username and password.
8. Press Connect.

13.3 Remote Server Setup

In order to access the DVR unit remotely, the DVR Server must be setup to allow remote connections.

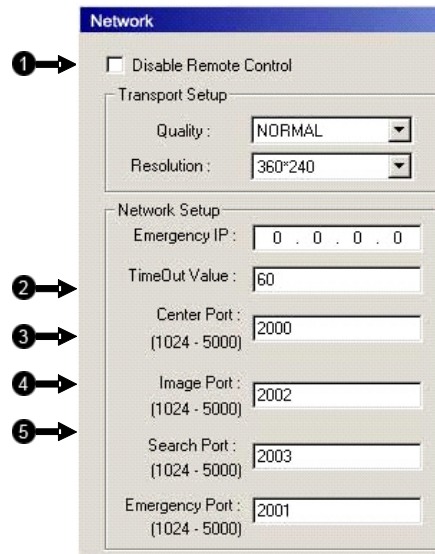

1. **Disable Remote** Enables/Disables acceptance of remote connections by the DVR server.
2. **Time Out Value** Specifies a value (in seconds) to wait for a signal from the Surveillix Remote Client. If a signal is not received by that time, the connection is dropped.
3. **enter Port** Used by the DVR to transfer the connection data.
4. **Image Port** Used by the DVR to transfer the image data.
5. **Search Port** Used by the DVR to transfer the search data

13.3.1 Configuring the Server for Remote Connection

The DVR can have up to 5 Simultaneous remote Connections. Each user can perform functions on the DVR unit and will not affect the other users. The only exception to this is accessing Setup. Only one user is allowed to access setup

1. Enter Setup on the DVR unit.
2. Click the **Communication Setup** button to open the Network menu.
3. Uncheck the Disable Remote Control option.
You should now be allowed to adjust port settings if necessary.

NOTE: If you are using a Firewall, it may be necessary to adjust the port settings on both the DVR and the Firewall. Contact your Network Administrator for more information.

4. Press OK.
5. Make sure a User account is created.
Without a user account, the Administrator account must be used.

The DVR server is now ready to receive incoming connections.

Appendix A

1.1 KV-KLR4 Specifications

		NTSC	PAL
CPU		Intel® Pentium® 4 Celeron 2.0GHz	
Storage (Hard Drive)		120 GB Standard	
Storage MAX		360GB / Extended Storage Available	
Operating System		Microsoft® Windows® 2000	
Viewing Rate		Max 30 FPS	Max 30 FPS
Recording Rate		Max 30 FPS	Max 30 FPS
Digital Control Output		4	
Sensor Input		4	
Resolution	NTSC	640x480 / 640x240 / 320x240	
	PAL	720x576 / 720x288 / 360x288	
Image Compression		MJPEG	
Average File Size		320x240 – 2~5k	
		640x240 – 4~8k	
		640x480 – 7~11k	
Video Inputs		4 CH (BNC)	
Composite Outputs		RCA	
Video Outputs		SVGA	
Motion Detection		Up to 5 Regions Per Channel / Adjustable Sensitivity	
Remote Operation		Full Remote Control Through PSTN, ISDN, ADSL, LAN, and TCP/IP	
Remote Software		Compatible with Microsoft Windows 95,98,Me,NT,2000,XP	
PAN / TILT / ZOOM		Built In RS-485/422/232 Interface	
Recording Mode		Continuous, Motion Detection, Sensor, Scheduled Recording	
Backup		3.5" Floppy, CD-RW (DAT, DVD, Zip® ... Optional)	
Digital Signature		Supports Digital Signature Verification	
Emergency Agent		Transmitted through TCP/IP – Pop-Up Window	

1.2

KV-KLR8 Specifications

		NTSC	PAL
CPU		Intel® Pentium® 4 Celeron 2.0GHz	
Storage (Hard Drive)		120 GB Standard	
Storage MAX		960GB / Extended Storage Available	
Operating System		Microsoft® Windows® 2000	
Viewing Rate		Max 60 FPS	Max 60 FPS
Recording Rate		Max 60 FPS	Max 60 FPS
Digital Control Output		4	
Sensor Input		8	
Resolution	NTSC	640x480 / 640x240 / 320x240	
	PAL	720x576 / 720x288 / 360x288	
Image Compression		MJPEG	
Average File Size		320x240 – 2~5k	
		640x240 – 4~8k	
		640x480 – 7~11k	
Video Inputs		8 CH (BNC)	
Composite Outputs		RCA	
Video Outputs		SVGA	
Motion Detection		Up to 5 Regions Per Channel / Adjustable Sensitivity	
Remote Operation		Full Remote Control Through PSTN, ISDN, ADSL, LAN, and TCP/IP	
Remote Software		Compatible with Microsoft Windows 95,98,Me,NT,2000,XP	
PAN / TILT / ZOOM		Built In RS-485/422/232 Interface	
Recording Mode		Continuous, Motion Detection, Sensor, Scheduled Recording	
Backup		3.5" Floppy, CD-RW (DAT, DVD, Zip® ... Optional)	
Digital Signature		Supports Digital Signature Verification	
Emergency Agent		Transmitted through TCP/IP – Pop-Up Window	

1.3 KV-KLR16 Specifications

		NTSC	PAL
CPU		Intel® Pentium® 4 Celeron 2.0GHz	
Storage (Hard Drive)		120 GB Standard	
Storage MAX		960GB / Extended Storage Available	
Operating System		Microsoft® Windows® 2000	
Viewing Rate		Max 60 FPS	Max 60 FPS
Recording Rate		Max 60 FPS	Max 60 FPS
Digital Control Output		4	
Sensor Input		16	
Resolution	NTSC	640x480 / 640x240 / 320x240	
	PAL	720x576 / 720x288 / 360x288	
Image Compression		MJPEG	
Average File Size		320x240 – 2~5k	
		640x240 – 4~8k	
		640x480 – 7~11k	
Video Inputs		16 CH (BNC)	
Composite Outputs		RCA	
Video Outputs		SVGA	
Motion Detection		Up to 5 Regions Per Channel / Adjustable Sensitivity	
Remote Operation		Full Remote Control Through PSTN, ISDN, ADSL, LAN, and TCP/IP	
Remote Software		Compatible with Microsoft Windows 95,98,Me,NT,2000,XP	
PAN / TILT / ZOOM		Built In RS-485/422/232 Interface	
Recording Mode		Continuous, Motion Detection, Sensor, Scheduled Recording	
Backup		3.5" Floppy, CD-RW (DAT, DVD, Zip® ... Optional)	
Digital Signature		Supports Digital Signature Verification	
Emergency Agent		Transmitted through TCP/IP – Pop-Up Window	

Free Manuals Download Website

<http://myh66.com>

<http://usermanuals.us>

<http://www.somanuals.com>

<http://www.4manuals.cc>

<http://www.manual-lib.com>

<http://www.404manual.com>

<http://www.luxmanual.com>

<http://aubethermostatmanual.com>

Golf course search by state

<http://golfingnear.com>

Email search by domain

<http://emailbydomain.com>

Auto manuals search

<http://auto.somanuals.com>

TV manuals search

<http://tv.somanuals.com>