

TOSHIBA FAX

TF 501

Instruction manual

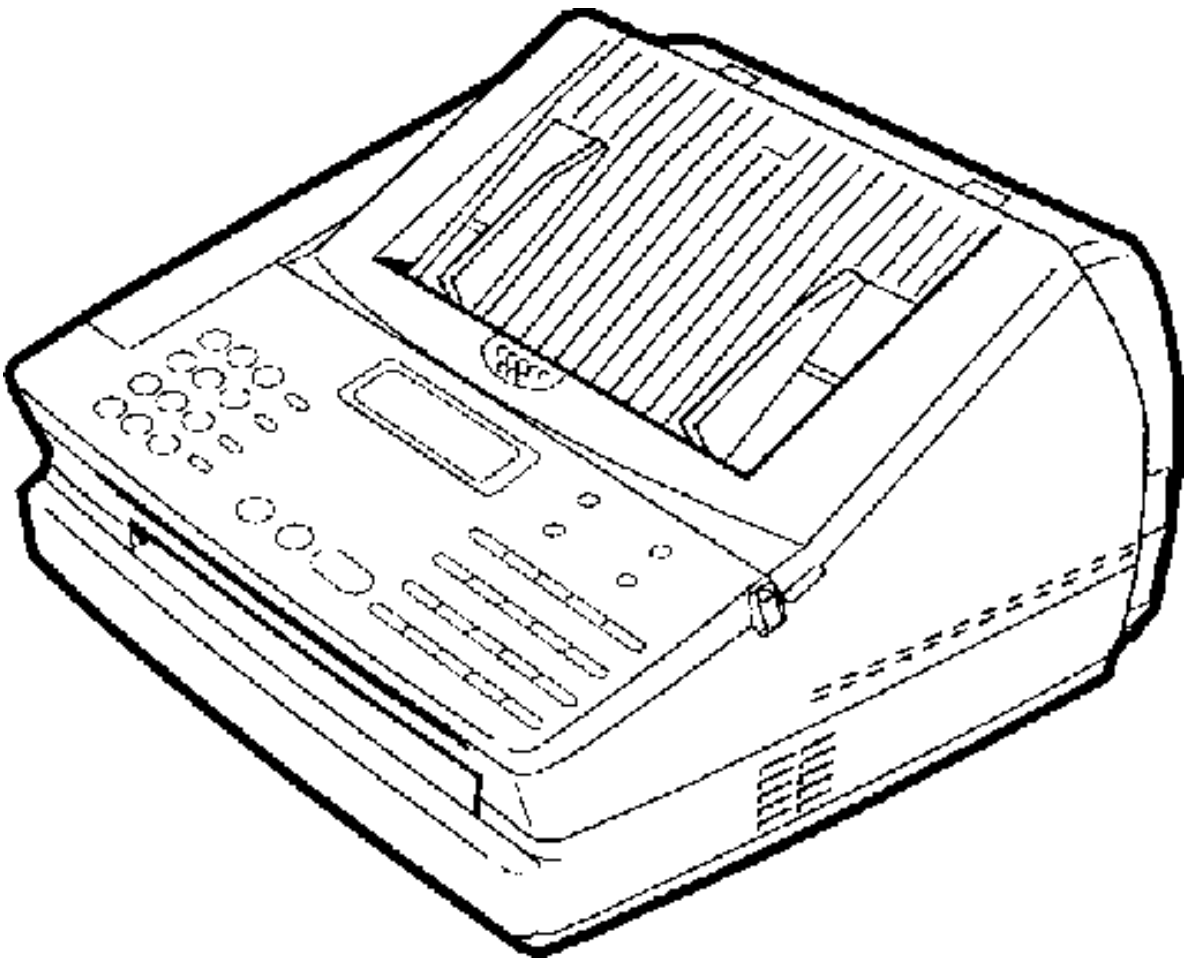

TOSHIBA

Contents

Part 1: Introducing your TOSHIBA FAX MACHINE	3
Unpacking, Installation	6
Installation the machine, loading the recording paper, installing the process unit	7
Installing the process unit and fixer cleaner	8
Transmitting messages, brief description	9
Function displays, menu controls	10
Standard setting: date, time	11
Receiving modes, cancelling reception, call request	12
Handling documents, document quality	13
Standard dialling procedures, automatic redial, cancelling transmission	14
Part 2: Functions for advanced users	15
Storing numbers and names, alphabet dialling, one-touch dialling	15
Storing, modifying and deleting group numbers	19
Multi-address transmission	22
Resolution, copying	23
Part 3: Even more possibilities	24
Terminal ID	24
Memory functions	25
Delayed transmission	26
Calling-up documents	27
Further options	29
Printer settings	31
Options for settings	32
Options	33
Part 4: Troubleshooting	34
Useful lists: transmission and reception reports	34
Useful lists: transmission reports	35
Replacing the toner cartridge	36
Troubleshooting: paper jam, cleaning the housing and scanner	37
Troubleshooting	38
Part 5: Glossary	41

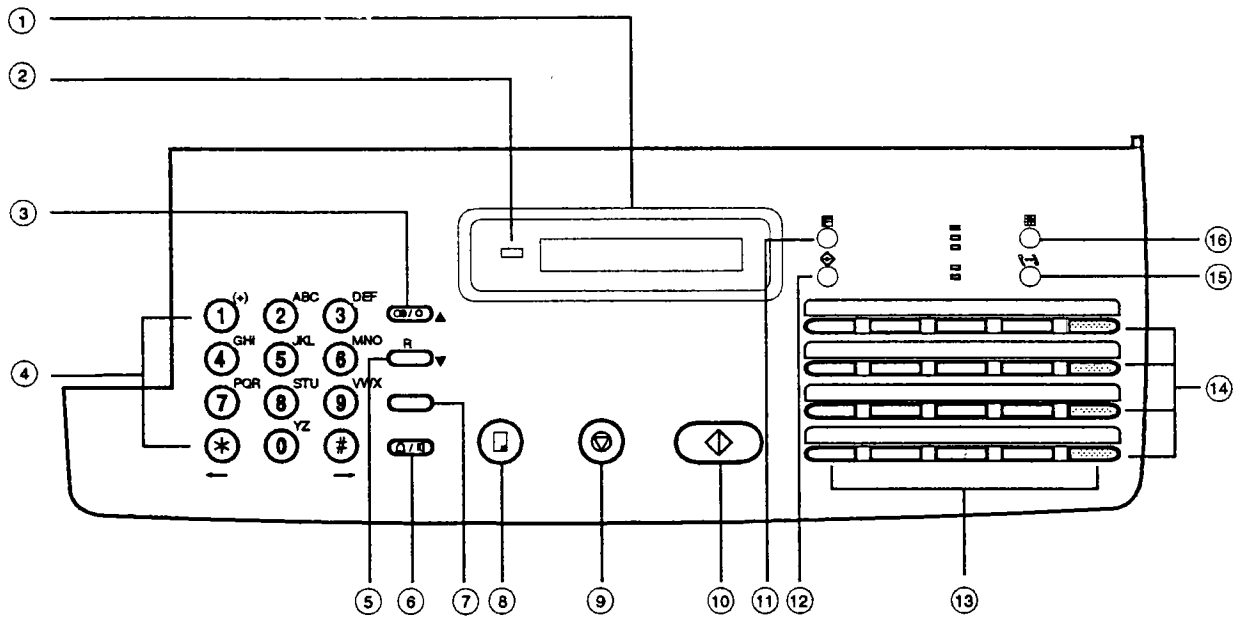
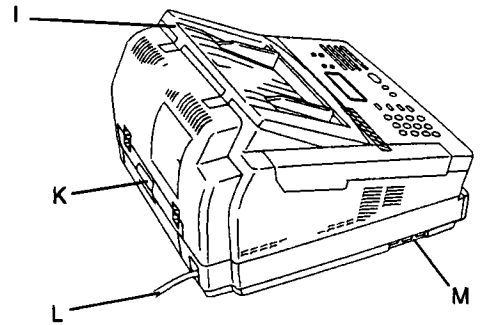
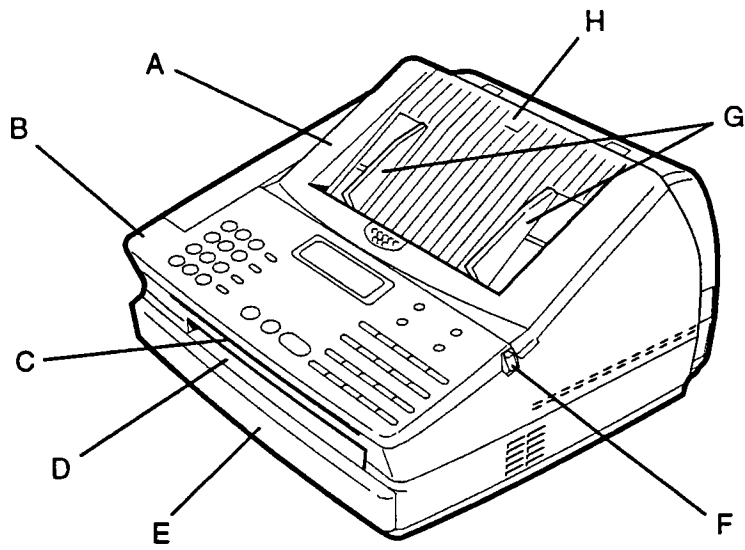

Control panel

- A** Cover
- B** Control panel
- C** Document exit
- D** Recording paper exit
- E** Recording paper cassette
- F** Release button
- G** Document guides
- H** Document tray
- I** Top cover
- K** Rear cover
- L** Power cable
- M** Telephone connection

- 1 LCD DISPLAY**
Displays indications about the operating modes of your fax machine. Your control monitor for all function settings.
- 2 Alarm**
Flashes when a machine error occurs.
- 3 REDIAL/PAUSE**
To initiate redialling of last telephone number and to select the name to which an alphabet dial key has been allocated. To insert a pause when dialling or entering telephone numbers.
- 4 DIAL KEYPAD**
Used to dial and store telephone numbers and to enter commands when modifying settings. You can also select characters to enter names with the * and # keys.
- 5 R key**
Used to connect the line at an extension and to search for a name which has been allocated an alphabet dial key.
- 6 CALL/HOOK**
Press this key if you wish to ask the other party to speak to you after fax transmission.
- 7 ALPHA. DIAL/TONE**
Press to call up one of the stored alphabet dial numbers. 2nd function: switches to DP 10 PPS dial method during telephone connection.
- 8 COPY**
You can check the quality of document reproduction in advance or simply take a normal photocopy.
- 9 RESET**
Used to stop an operation and return your machine to the stand-by mode, or clear an error display.
- 10 START / YES**
Initiates the sending and receiving functions. Confirms entries.
- 11 FUNCTION**
The most important key. Press this key to select menu settings.
- 12 SELECT/MEMORY/MULTI**
With this key you confirm functions and selections which you have called up with the FUNCTION key. Key for memory transmission and direct multi-address transmission.
- 13 ONE-TOUCH DIALLING keys**
Press the relevant key; your fax machine will send documents to the fax number you have stored here.
- 14 GROUP keys**
Used to directly select a receiver group for multi-address transmission and polling.
- 15 AUTO RCV and AUTO/MANUAL lamps**
To switch between automatic and manual reception.
- 16 RESOLUTION and FINE/SUPER FINE/HALF TONE lamps**
To send or copy, you can select fine or super fine resolution for optimum reproduction of very small print. The HALF TONE setting enables you to transmit photos and drawings.

Have fun with your new fax machine!

This instruction manual introduces you as briefly as possible to all the necessary functions of your new fax machine. For your convenience, let us first take a look at the contents.

Illustration

Part 1:

From page 6

Introducing your TOSHIBA FAX MACHINE

An introduction with practical exercises. Afterwards, you will have mastered all the basic functions, including how to send and receive.

Part 2:

From page 15

Functions for advanced users

Familiarize yourself with the great potential of your new fax machine. In return, the machine will offer you a high level of convenient operations.

Part 3:

From page 24

Even more possibilities

Many helpful functions, technical settings, lists and reports.

Part 4:

From page 34

Troubleshooting

Tips and checklists, how to eliminate faults, how to take care of your machine, and service over the telephone.

Part 5:

From page 41

Glossary

You'll find a description of all functions at a glance.

You're just 15 minutes away from your first fax message



Important...

When unpacking your machine, **please check** that all parts shown here are present and in perfect condition.

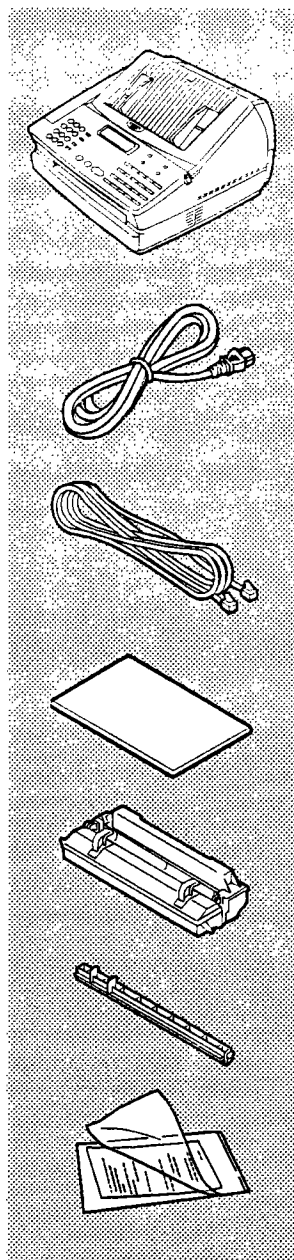

1 Fax machine

2 Power cable

3 Telephone cable
(not supplied in all countries)

4 Instruction manual
(this manual)

5 Process unit and toner cartridge

6 Fixer cleaner

7 Carrier sheet

If anything is missing, or damaged, please contact your dealer immediately.

Get ready...

The correct location for your fax machine is easily found:

- near a 240 V AC socket*,
- near a telephone connection, ideally with a single line reserved for your fax machine.

* If you wish to switch your machine off for a longer period, cut the power supply by removing the power cable from the machine or socket. No other equipment with high power consumption (such as a photocopier) or equipment which generates electrical noise (such as a radio, computer, radio transmitting and receiving equipment) should be connected to this mains supply.

Please protect your machine from

- direct sunlight
- dust
- vibration
- heat
- humidity



Get set...

Connecting to the mains

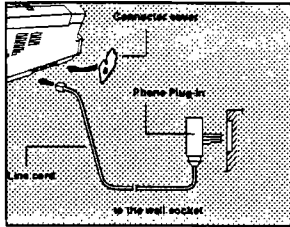

Telephone connection
Connect your fax machine (LINE) to the telephone socket.

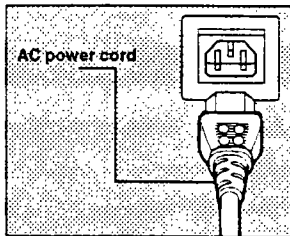

Connecting the AC power
You will find the mains connection on the back of the machine on the left.



▲ Connect the machine to the mains only after you have installed the process unit and fixer cleaner.

How to insert the recording paper

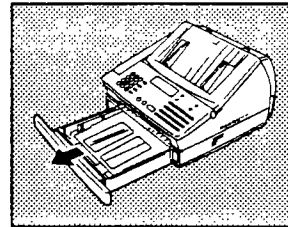

Remove the paper cassette

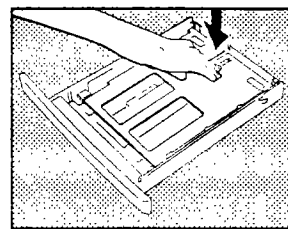

Press down the cassette plate until it locks into place.

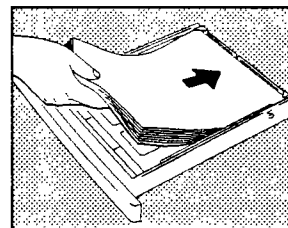

Insert a stack of A4 paper
Prepare the recording paper by flexing and fanning out the stack to separate the sheets. Place the paper so that it lies straight in the cassette with the side to be printed facedown and don't forget:

▲ The paper cassette holds a maximum 160 sheets (80g/m²).

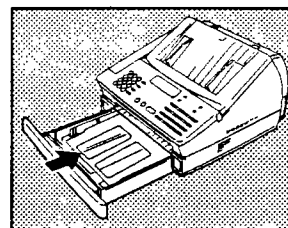

Then: Slide the cassette into the slot until you hear it lock into place.

▲ Do not use damp, wrinkled or torn paper.

...and...

When installing the machine for the first time and later when CHANGE PROC.UNIT is displayed, insert the new process unit as described below.

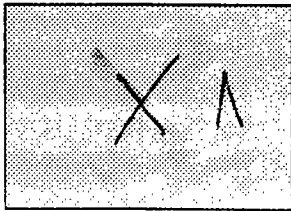

Open the top cover.

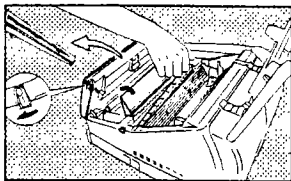

First: The fixer cleaner

This is inserted when installing your machine for the first time and each time the process unit is replaced:

Open the control panel cover to the front. Slide the cleaner underneath to the right, lift and remove. Insert the new cleaner first on the right, then press down firmly on the left.

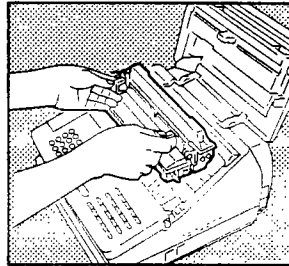

...Insert the process unit

First slide the green lock lever on the inside left of the machine to the back. The process unit is then inserted with its pins into the lateral guides and placed exactly in position by applying slight pressure downwards.

Now pull the lock lever forward again.

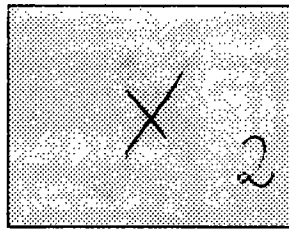

Then close the top cover and the control panel cover again.

Now (re)connect your fax machine to the socket.

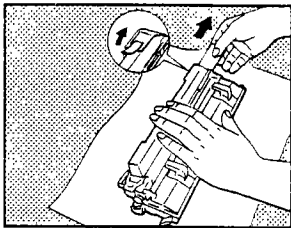

Now: The process unit

Place a sheet of paper on an even surface and lay the process unit on this. Remove the seal.

When holding the protective foil, be sure to avoid contact with any toner.

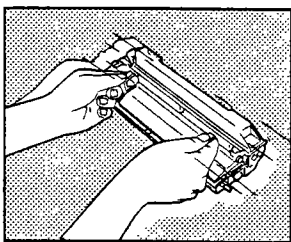

Shake the process unit

several times backwards and forwards, before you...



A damaged drum will affect the copy quality. Therefore: Never touch the drum surface or expose the drum to sunlight for more than three minutes.

...Go!

Good news: We're ready to send our first fax

It's easy from the word GO! For your first transmission, take an A4 sheet with typewritten text. Please turn to page 23 for information on the correct setting for more exacting documents e.g. pictures.

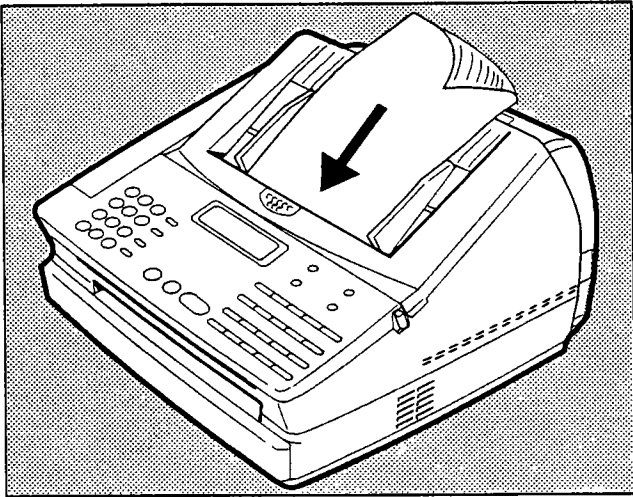

1. Load the document *

Place the sheet printed side **face-down** on the document tray.

Adjust the document guides to the edges of the sheet.

After 2 seconds, the machine will automatically draw the document in about 2 cm.

The message DOCUMENT SET appears on the LCD display in the centre of the control panel.



2. Pick up your handset and dial the receiver's fax number. **

When the receiving machine answers with a tone, you just have to ...

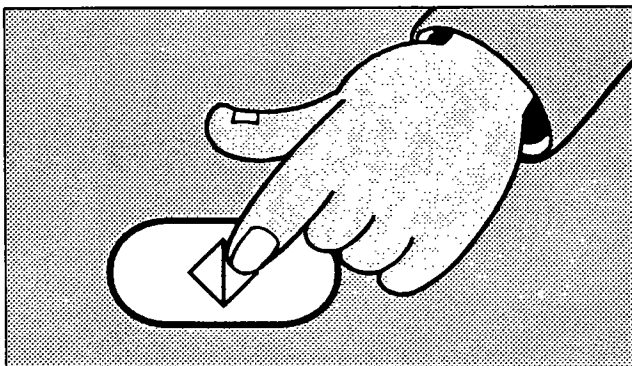

3. ...press **START**, then replace the handset. First, the machines exchange information with each other. After a few seconds, your document will be transmitted. Your fax machine tells you that transmission has ended by displaying **COMPLETED**.

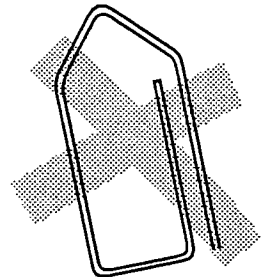

* Make sure you remove any paper-clips, staples or similar objects otherwise you may damage your fax machine.

** Turn to page 14 for a description of easier methods of dialling.

What have you done?

When preparing, dialling and transmitting your first fax message, you probably noticed that the LCD display changed with almost every step.

The LCD display in the centre of the control panel ...



... is your monitor for all operations performed by your fax machine.

When loading the document, it displays information on the loaded document. For example:



After you dialled a number and pressed START,

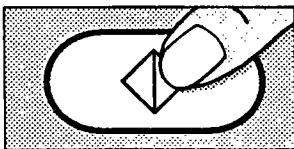

you saw on the display

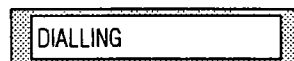

With other messages such as XMT READY and CONNECTING, your fax machine keeps you informed on each step it takes and the result e.g.:



By displaying the date and time, your fax machine tells you it is on **standby** to automatically receive incoming messages and carry out new jobs:

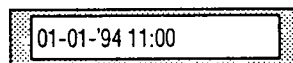

If you wish to reset your machine or make modifications to certain functions, your fax machine will make suggestions, ask questions and require selections via the LCD display.

Can your fax machine talk?

Not quite! However, your fax machine gives you suggestions in the form of menus but you can only see the current line from the list of suggestions. Like this:

REPORTS

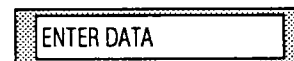

TX SPEED 4800

The rest of the list remains in the background. Shortly, you will learn exactly how this works in a practical example. Just one thing you should know now. Two keys take you through the menus:

With FUNCTION



you select the subject of the setting you wish to make.



takes you step-by-step from one selection to the next. Suggestions you wish to accept are mostly confirmed by pressing...

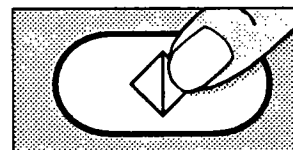

... START

Did you enter the wrong selection? **RESET** returns you to the standby mode.

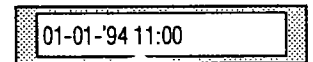
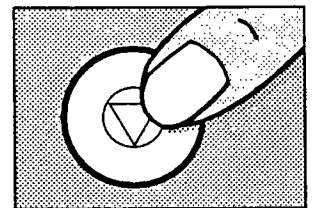

The LCD display indicates that the machine is on standby again. From here, you can start selecting again from the beginning of the menu.

This is a matter of principle: a menu for each function.

Successful handling of your fax machine's selection menus is best explained in practice. For example, in setting the system time. This ensures that all incoming and outgoing fax messages provide the important proof of date and time. This is how it works.

Setting date and time

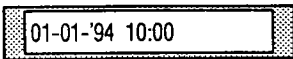

The standby mode is the starting point for each setting you enter in your fax machine.

FUNCTION

FUNCTION leads you through the suggestion list.

Key forward to the menu ENTER DATA.

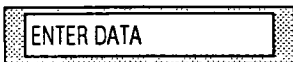

Each time you press FUNCTION, you call up a new subject. Press FUNCTION until the LCD display shows:

SELECT

SELECT now leads you each time you press the key through all suggestions to enter data:



Accept the suggestion DATE AND TIME. It's as simple as this:

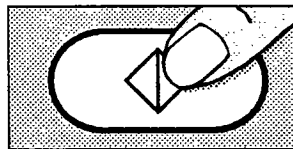

Press START
Your fax machine asks you to make an entry:

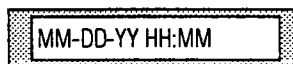

Using the number keys on the dial keypad, you can now enter the current system time, e.g.: Sunday, 1st June 1994, 11.00 a.m.

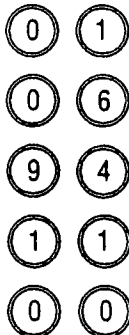

Press
01 for the day
06 for the month
94 for the year
11 for the time of day (24-hour format)
00 for the minutes

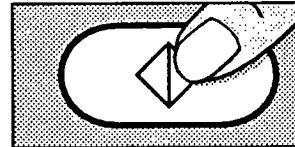

Confirm your entry by pressing START. The LCD display briefly indicates:

SET COMPLETED

The following display...



...offers you the possibility of making further entries.

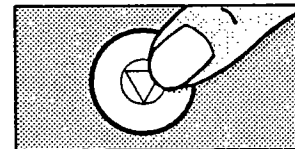

Reject this possibility by pressing RESET. Your fax machine then returns to the...

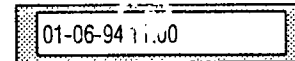

... **standby mode**, displaying the current date and time just entered.

Did you enter the wrong selection? RESET returns you to the standby mode.

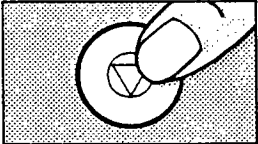
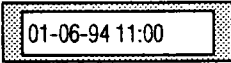

Did you notice anything?

Some keys on the control panel have two functions. This should not confuse you. For the machine settings, only the function we actually need is of interest.

Switch to receiving mode

Your fax machine basically offers you two methods for receiving calls. If you have additionally connected a telephone to your fax line, you may select a further setting. Your fax machine can "distinguish" between incoming calls and fax messages.

This is how you select the correct receiving mode

AUTO RCV

Press AUTO RCV
The LCD display switches between the AUTO and MANUAL receiving modes.

The AUTO display lights up

Automatic receiving mode
Your fax machine treats all incoming calls as fax messages. Callers wishing to speak to you hear only the fax tone.

The MANUAL display lights up

Manual receiving mode
The telephone rings. You can listen to the call on your fax machine via the built-in loud-speaker. (See page 33). If a caller wishes to speak to you, call him back on a normal telephone.

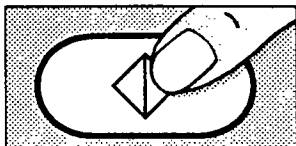

If you hear a fax tone, press START. The message will be received and printed out.

If a telephone is also connected to your fax line, you have to **pick up the handset** to take the call. If a caller is on the other end of the line, you can speak to him. **Only if you hear the tone from a fax machine, press START,** to switch over to FAX receiving mode.

TEL/FAX receiving mode
In the manual mode, you can activate a fax switch: If switched on, your fax machine will take the incoming call after a certain number of rings. If it then recognizes a fax message, it will be received and printed out. If there is no fax tone, the telephone will continue to ring. You can determine the number of rings and how long your telephone continues to ring before your fax machine accepts the call. Turn to page 30 for more details.

Do you wish to cancel reception?

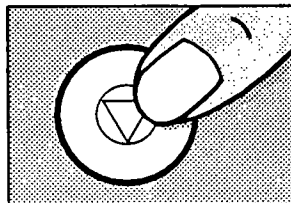

You can stop an ongoing reception at any time. To do so, press RESET.

To make enquiries: Call request



When transmitting or receiving a fax message, you can tell your partner that you wish to speak to him by pressing CALL.



The following appears on your LCD display:

- If you press CALL during TRANSMISSION, you can only speak to your partner after transmission is completed.
- If you press CALL during RECEPTION, you can already speak to your partner after transmission of the current page. To continue reception, press START after you have spoken.

If you do not accept a partner's call request, your fax machine will remind you that someone wishes to speak to you. It prints the following:

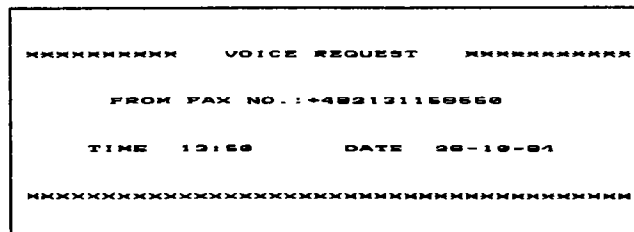

You wish to cancel the call request?
Just press CALL again.

Type and quality of documents

The following table gives you an idea of which documents your fax machine can handle.

		Single sheet	2 or more sheets
Document size	Max	216 mm (W) x 1000 mm (L)	216 mm (B) x 381 mm (L)
	Min	148 mm (W) x 105 mm (L)	
Effective scanning width		210 mm	
How many sheets can be loaded at one time?			stacks: up to 20 A4 sheets
Thickness of paper		0,05 to 0,15 mm	0,06 to 0,1 mm
Quality of paper		Uncoated on both sides	

- Documents longer than 381 mm can only be loaded manually.
- If you load several sheets at one time, they should all be of the same size and paper quality.

Problem documents...

- may not load. This applies to
- torn, wrinkled or damp pages
 - folded pages or pages with holes
 - transparent pages or pages with a smooth, shiny finish
 - textile or metallic documents

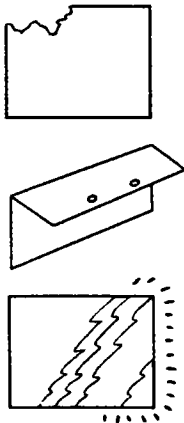

There are two ways of avoiding this problem:
...by photocopying or using a carrier sheet.
 Your TOSHIBA dealer can supply you with the necessary carrier sheets.

How to use carrier sheets:

Place your document face-up on the carrier sheet under the transparent cover. Carrier sheets can be used like normal documents except for one restriction: only one carrier sheet can be fed at one time.

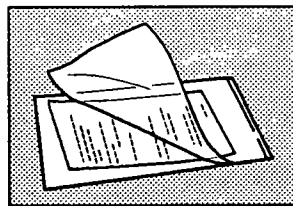

How to load documents correctly

Remove any paper-clips, staples and similar objects before transmitting the document. Now place your documents on the document tray - up to 20 at one time - as shown.

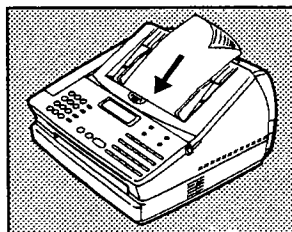

Automatic document feeder

Most important: Only the document sheets placed facedown on the document tray can be read. If you can still read your text, you'll be sending empty pages or the backs of pages!
 Adjust the document guides to the edges of the sheets. After 2 seconds, your document will be automatically pulled in by about 2 cm.

The first message: everything OK?

As soon as your fax machine has pulled the document in slightly, the following appears on the LCD display:



with the standard setting for resolution. If you wish to modify the setting, please refer to page 23.

 If you are receiving onto printed material (e.g. headed paper), your fax machine may be damaged by the colour print melting. Furthermore, certain colours may cause gases or the like to be formed during fixation.

Take a copy

As a check, you can take a copy of the document. All you have to do is press COPY.



Select the number of copies

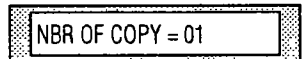

If you agree with the above setting - in this case 1 copy per document - press START. If not, enter the number of copies required and then press START.
 After copying, your fax machine will return to the standby mode again.
 Copies are not made in the standard mode but only with the resolutions FINE or HALF TONE.

Please dial

There are different ways of dialling on your fax machine. First the standard procedures. If your fax machine is connected to a telephone system with extensions, please refer to the instructions on access at extensions on page 32.

Direct transmission

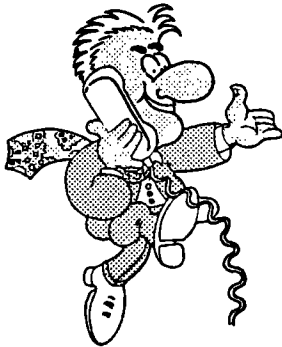

Dialling on the telephone

Dial on the telephone as described on page 9.

... or on the dial keypad.

There are 3 procedures:

1. You press HOOK on the control panel. The display shows TEL. You can now hear the dial tones and the other party accepting the call. Whether you press HOOK or not, continue as follows:

2. You first dial on the dial keypad and then load your document in the document feeder. Advantage: you can read off the fax number from the document. Or:

3. You load the document and then dial the receiver's fax number...

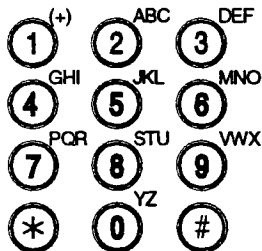
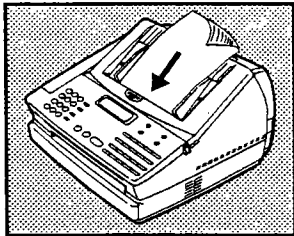

... on the dial keypad

For 2 and 3 above, you enter here the receiver's fax number.

For example: 012345

Is the number correct?
If you have "dialled" incorrectly, press RESET and redial.

Now just:
Press START.

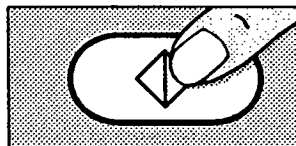

Your fax machine reports all steps up to ...



... successful transmission* on the LCD display. Successful transmission is confirmed by a short tone.



Your fax machine reports a transmission error with a long warning tone and this display:

Tips on how to eliminate transmission errors are given on page 38,39.

* Your fax machine will print out a transmission report automatically after each transmission. If you do not require this report, you may switch off the function as described on page 29.

Automatic redial

Is the number you dialled busy? Your fax machine automatically redials the number. To activate automatic redial immediately, press REDIAL.



Your fax machine confirms the redial by displaying



and then redials the number.

Do you wish to cancel the transmission?

You can cancel transmission at any time by pressing RESET.

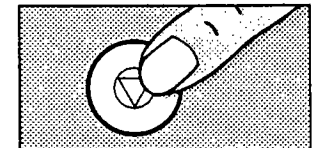

Dialling for advanced users

You can store numbers which are frequently called in your fax machine for use at any time.

Alphabet dialling: A great help!

You can store up to 50 alphabet numbers. Instead of dialling the whole number, press ALPHA.DIAL and enter the first letter of the receiver's name.

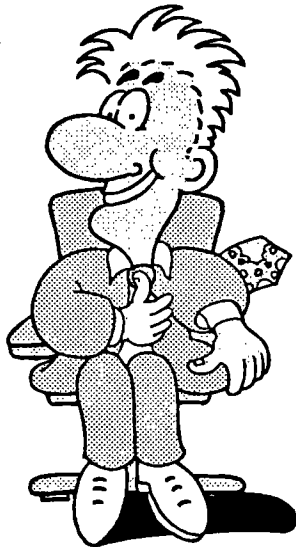

One-touch dialling: Even more convenient!

Your fax machine additionally reserves memory for your most important partners: on the one-touch keys 1-16. To dial, you just need to press the relevant key.

How to store numbers...

When the LCD display asks you to enter digits, use the dial keypad on the control panel.

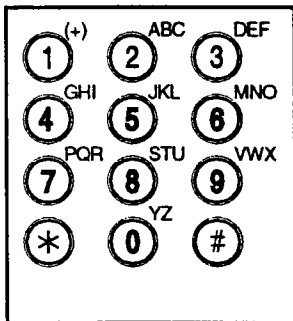

... and names

You can select letters on the dial keypad e.g. for receiver names on your terminal ID. This is how it works:

On the top right of each digit key, you will see a group of letters. A, B, and C are allocated to key 2. If you wish to enter A, press key 2 once. To enter B, press key 2 twice, and to enter C, press key 2 three times.

A space to overwrite letters is given in the list of special characters under key 1.

The character lists

Each time you press an alphanumeric key, you are taken one position further in this list:

Key	Character
1	• + ! ? - . 1 / : * % ! () ' i z
2	A B C 2 A A A E Ç a b c ä å æ ç
3	D E F 3 d e f
4	G H I 4 g h i
5	J K L 5 j k l
6	M N O 6 N O m n o ñ ö
7	P Q R 7 p q r
8	S T U 8 U s t u ü
9	V W X 9 v w x
0	Y Z 0 y z



The cursor keys

* and # move an underscore in the display each time they are pressed by one position in the direction of the arrow: * takes you to the left, # to the right.



The underscore

Wherever this is placed, you can enter a letter or digit or overwrite with another character.

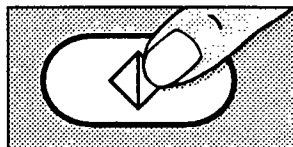

When your entry is complete, you can confirm by pressing **START**.

Telefax operation at extensions

When you are operating your fax machine at an extension, to gain access to a line, you will have to enter the R key before the telephone number, no matter whether you dial using the dial keypad or store the telephone numbers. If necessary, you can insert pauses using the PAUSE key. These appear on the display as a dash.

Part 2:

First: storing alphabet numbers ...

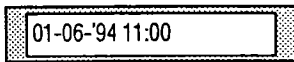

On the LCD display:
the standby mode

7x FUNCTION

Press **FUNCTION** seven times, you are asked to



2 x SELECT

You accept the suggestion ENTER DATA by pressing **SELECT**. After pressing SELECT twice, the following is displayed:



If you confirm with **START**, you are given an alternative:



As you wish to enter an alphabet number, confirm by pressing key 1 on the dial keypad for YES.

Your fax machine now asks you to select the required storage location (01-50) :

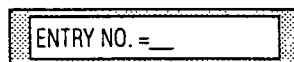

Enter a two-digit number e.g. 01: If the position is still free, the display is empty and you may enter the receiver's name.



A maximum of 15 characters can be entered on the dial keypad for the receiver's name e.g.: TOSHIBA. See also page 15.



When the name is complete, confirm by pressing **START**. You are then asked to enter the telephone number:



Enter the telephone number on the dial keypad... *

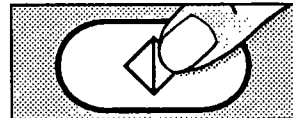

... and complete the operation by pressing **START**.

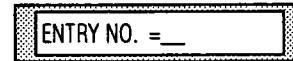

* If you wish to programme pauses (e.g. for overseas numbers) between the STD code and the subscriber number, press **PAUSE**. Pauses are shown on the LCD display as hyphens. You may also enter a space between digits in telephone numbers with the # key.

... deleting ...

One-touch numbers

If an old or wrong number is stored, it can be deleted or modified as shown below:

01-06-'94 11:00

In the same way you entered alphabet numbers...

7x  FUNCTION

... this combination of keys brings you to...

2x  SELECT

...the display:

ALPHABET SET

After confirming with START, select ...

ENTER:1 DELETE:2

... 2 in the next menu for DELETE.

ENTRY NO. = _

Now enter the number in the list of alphabet numbers which you wish to delete.

ALPHABET DELETE

After this display...

BANK

... you will see the receiver name which you can delete by pressing START. Your fax machine confirms this:

DELETED

If you do not wish to delete any further storage location, RESET will return the machine to the standby mode.

... and modifying

To modify a name or update a telephone number, you proceed in the same way as for entering alphabet numbers. Simply overwrite the old entries.

Storing one-touch numbers

01-06-'94 11:00

On the LCD display: the standby mode

7x  FUNCTION

Press FUNCTION seven times. You are asked to:

ENTER DATA

 SELECT

Press SELECT

ONE TOUCH SET

After pressing START ...

ENTER:1 DELETE:2

... select 1 on the dial keypad for YES

SELECT BUTTON

Then press the one-touch key you wish to assign to the telephone number of your new one-touch partner.

NAME SET

Now enter the name ...

TEL. NO.

... and telephone number of your partner - in the same way you store alphabet numbers. This also applies to deleting and modifying.



Storing was really worth it!

This is how you make use of alphabet dialling

You can store up to 50 telephone numbers in the alphabet dial memory. It is very simple to dial one of those numbers.

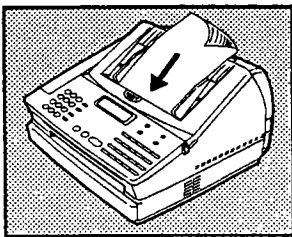

ALPHA. DIAL.

SELECT NAME

PAUSE

R

TOSHIBA

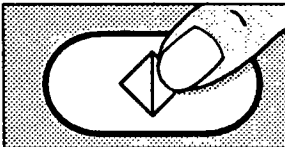

012345

Load the document

Don't forget: the printed side must be facedown.

Press ALPHA. DIAL.

Or do you first wish to modify the resolution? Instructions are given on page 23

Call up the receiver name*

You just need to enter the first letter of the name. Is the correct name displayed? If you have stored several names with the same first letter, you will have to select the required receiver name. PAUSE takes you forward, R backwards in the alphabet.

Now just press ...

... START

The number of your partner is displayed ...
... It's as simple as that!

One-touch: dialling with just one key

In addition to the alphabet numbers you can assign a further 16 telephone numbers to their own one-touch key on the control panel. Press this once and your fax machine takes all the work out of dialling.

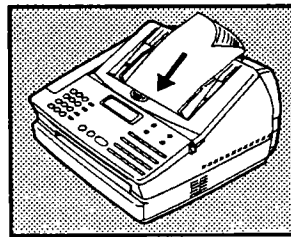

DOCUMENT SET

01

TOSHIBA EUROPE

Load the document

Don't forget: the printed side must be facedown.

The document is fed in automatically and the LCD display shows:

Do you wish to modify the resolution?

Instructions are given on page 23.

Now: Just press the one-touch key.*

The name of your partner* appears on the LCD display for 2 seconds and your fax message is transmitted.

* If you pressed an alphabet number or a one-touch key by mistake which has no stored telephone number, the following appears on the LCD display:

Now press the correct alphabet number or another one-touch key.

Your fax machine now automatically dials and transmits the document.



Working with groups - makes life much easier

Why should you really take the trouble to transmit or call up the same fax message to or from different receiving parties one by one until the last address has been called up? Your fax machine helps save your time, money and nerves by grouping operations and systematically working through them. The following functions are available:

Multi-address function

A document is automatically transmitted from the memory to a receiver group which you have previously set up.

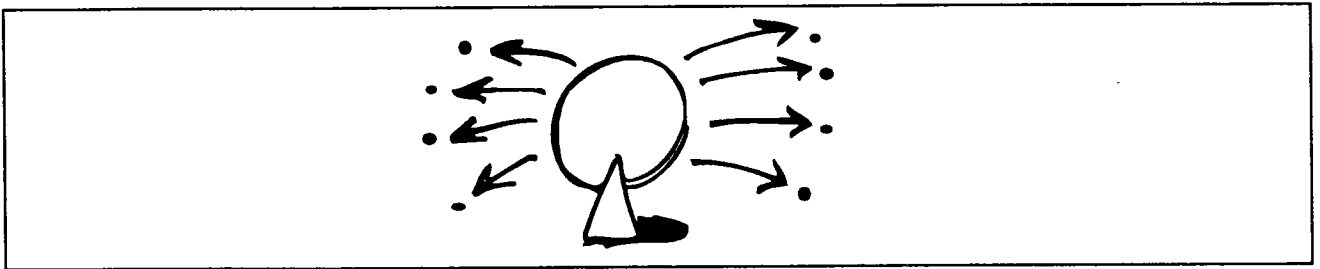

Multi-polling reception function

You can programme your fax machine to call up documents reserved for you from several stations or groups.

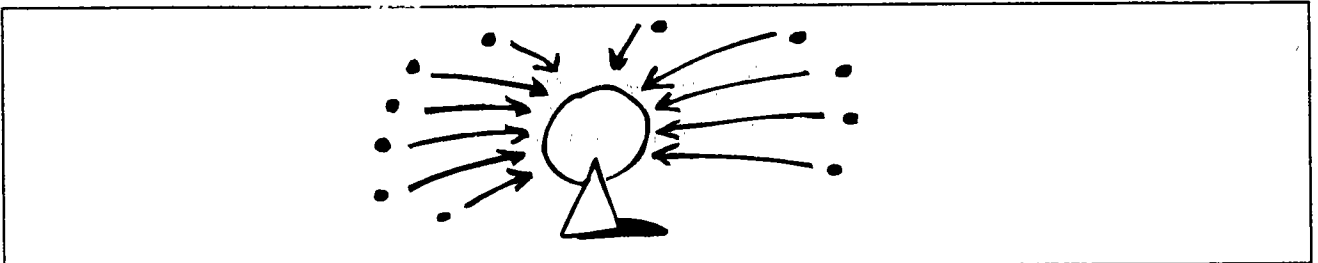

There is just one thing you have to do before you make use of these helpful functions: determine and store target groups.



If you have any questions in setting up these useful transmission and reception functions, your TOSHIBA service partner will be pleased to give you advice and assistance.

Storing, modifying and deleting groups and telephone numbers

You can store and modify at any time up to 4 groups with a maximum of 10 receiving parties each. You must first make up the receiver groups before you can use the multi-address transmission function. This is how it works:

7x  FUNCTION

Key forward to the menu:



3 x  SELECT

3 x SELECT brings you to:



Confirm by pressing START.

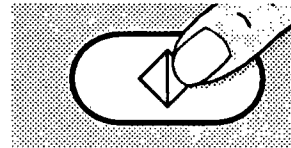

In the next menu, you are given a choice:





What do you wish to do?

Do you wish to store groups and telephone numbers?

Then enter 1 for YES on the dial keypad.

You are asked to:



Press the grey group key of the relevant group on the one-touch keypad
e.g. G1 key 

After you press the group key, you see either the display on the left or right:





Please continue reading on the next page.

Storing, modifying and deleting groups and telephone numbers

STORING:



Using the dial keypad, alphabet dialling or one-touch dialling, you can now enter one or more telephone numbers.



When the entry is complete, confirm by pressing START.

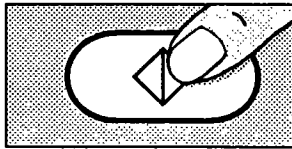

The following menu asks you to make a further entry:



If you have set up a new group, now give it a name (up to 15 characters) e.g:



If a group has already been assigned to this storage location, you may now modify the group name. Confirm the new, modified or old group name by pressing START.

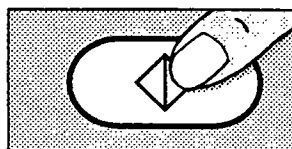

When the group entry is completed, your fax machine returns to its original display:

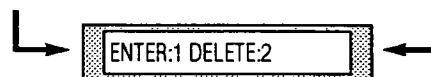

You can now work on other groups in the same way or: RESET returns you to the standby mode:

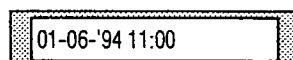

MODIFY/DELETE:



After this display, you can:

either:
delete the selected group and all the numbers stored there by pressing START.

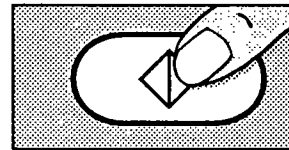

or:
delete one or more telephone numbers from the group. You do so with SELECT.



SELECT brings you step by step through the list of stored numbers.



If you wish to delete the telephone number displayed, press START.

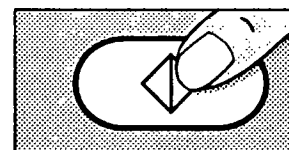

After informing you that the number has been deleted ...

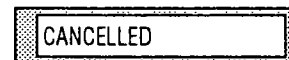

... your fax machine returns to its original display.

Automatic transmission to groups

Your document will be automatically transmitted in turn to all the members of pre-determined target groups - also with delayed transmission and redialling.

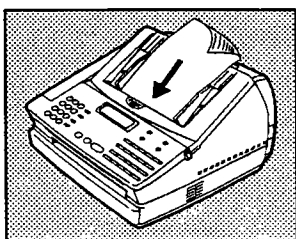

Load the document
If required, set resolution.

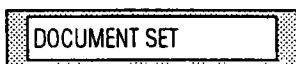

When the document is ready ...



... **press the group key.**
The selected group name is displayed e.g. FIELD SERVICE.



Multi-address transmission begins with...

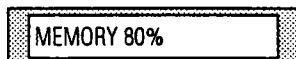

...the document being read into the memory. Memory capacity is displayed.* Then your fax machine displays:



Your fax machine dials all the telephone numbers of the group members in turn and transmits the document. If a connection is busy, it will be redialled at the end of the operation.

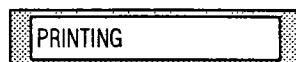

Einstellung kehrt das Gerät in den Standardzustand zurück. When the transmission is completed, your fax machine prints out a multi-address transmission report for your information..

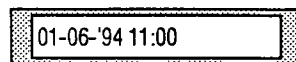

... and returns to the standby mode.

Delayed multi-address transmission?

This is very simple. Follow the description given on page 26. Instead of entering a telephone number, just press the one-touch key of the required receiver group.



*As in the case of other memory transmissions, the HALF TONE mode is not available for multi-address transmission. Multi-address transmission is not possible when the functions additional memory transmission, delayed transmission, direct multi-address transmission or polling are reserved with other jobs or available memory is less than 10%. If the available memory is exhausted before all the documents can be read in, your fax machine interrupts the memory procedure. If you wish to transmit documents already stored, press START. Or delete as described on page 25 under memory transmission.

The solution for detailed documents

Adjusting resolution

Even in the standard setting, your fax machine provides high-quality transmission or copying of your documents. However, you can also adjust the settings for your specific documents. The correct resolution - i.e. the number of pixels per millimetre - is selected according to the following general rules:

STANDARD:	for documents written by hand or typed
FINE:	for documents with very small print such as newspapers or diagrams
SUPER FINE:	for documents with very small detailed illustrations
HALF TONE:	for photos, half-tone or colour documents

How to reset resolution

For your next operation you may select your own resolution in each case.

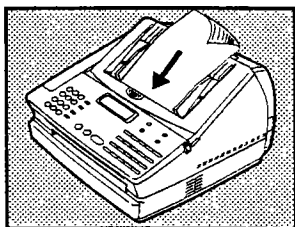

DOCUMENT SET

Load document.

In the standard setting, your document is sent with standard resolution.

This can be modified:

Press MODE until the LED of the required resolution lights up: FINE, SUPER FINE, HALF TONE. If the green LED does not light up, you have arrived again at the beginning of the selection. Your document will be sent with standard resolution.

 MODE

Note:

The resolution setting SUPER FINE is only available if the receiver's fax machine can handle this mode.

What about a copy?

Vary the resolution setting until you achieve optimum results for your documents. Test the setting by making a copy:

When you press

COPY



your fax machine asks you to enter

NBR OF COPY 01

Modify the number of copies or confirm with START*.

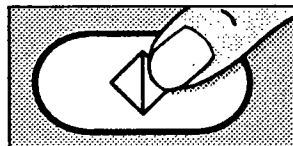

*It is not possible to select the standard setting when copying. Your fax machine copies instead in the FINE mode.



Your name at the top

Send your fax messages with your terminal ID. This can comprise your fax number (compulsory in Germany!) and your (company) name. There is room for 30 digits and/or 30 characters.

Here's how to enter your name...

7x  FUNCTION

Key forward...

7x  SELECT



... to the menu LOCAL NAME

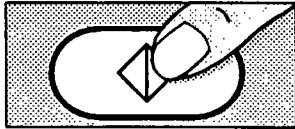

Start your entry by pressing START.



There is room for 30 characters for your name.

Enter the characters on the dial keypad. Tips are given on page 15.

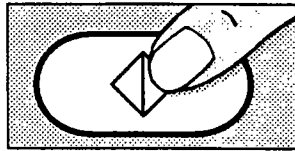

Is your name complete?
Confirm with START.



After this display, your fax machine offers you the possibility of ...



... making further entries with the next menu.
Instead of returning to the standby mode by pressing RESET, enter your ID.

... and now your fax number

6x  FUNCTION

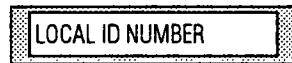

After confirming...

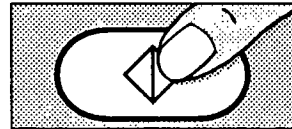

... with START...

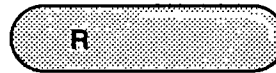

... enter your fax number. After you have pressed R, you can enter the international code e.g. 44 for England, your STD code without the 0 and your telephone number. For easier reading, you may insert a space with the # key.

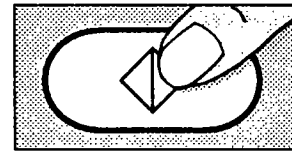
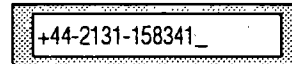

Is the number correct?
Confirm with START.

This gives your message the personal touch.

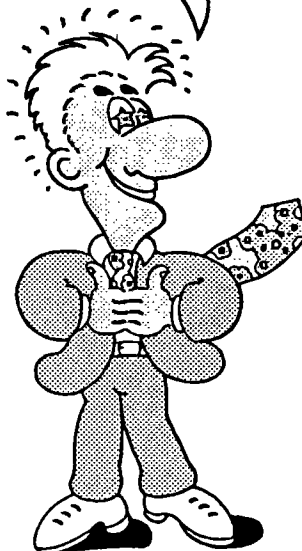

Your fax machine has a memory

With its built-in memory, your fax machine allows you to use a number of functions: delayed transmission, multi-polling reception, memory reception, memory reservation, memory transmission, multi-address transmission. Here is a summary of the memory functions.

Memory reception *

is always switched on. For example, when there is no recording paper, or a paper jam or the toner has run out, your fax machine stores any incoming fax message in its memory. This message will be printed out later:

1. The LCD display shows e.g. ADD PAPER and the available memory.



2. Do not switch off your fax machine.
3. Insert recording paper.
4. When your fax machine is back in the standby mode, the stored fax message will be automatically printed out.

Other useful memory functions such as

- **multi-polling reception and**
 - **memory reservation**
- are explained in the description of the respective basic functions.

* If the available memory is less than 10%, memory reception is not possible.

Transmission from memory

Your fax machine can store up to 16 pages of documents* and transmit them to a maximum of 20 receiving parties. Your document can be

- transmit once (memory transmission)
- transmit to several receiving parties in turn (multi-address transmission)

This is how it works:

• Memory transmission

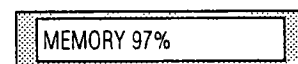
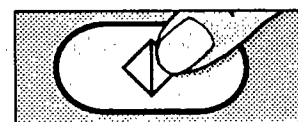

• Multi-address transmission

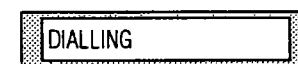
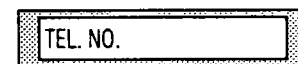

You have loaded a document and - if necessary - selected the required resolution.**

Press SELECT.

By alphabet or one-touch dialling, you can now enter:

a telephone number and...

... press **START**.

Your document is fed in and read into the memory.

The LCD display shows how much memory is still available e.g. 97%. * After the display ...

...press **START**. Your fax machine starts memory transmission.

You may however activate:

Enter a telephone number
After the number is confirmed with **START...**

... your fax machine is ready either: to accept further telephone numbers (a total of 20) for multi-address transmission

or:
after you press **START** again, your fax machine starts dialling.

After this display...

... your document will be transmitted in turn to the selected receiving parties.

* Memory requirement for each page depends on the close spacing of the lines. When the available memory is less than 10%, memory transmission cannot be activated.

** The HALF TONE mode is not available for memory transmission.

You cannot select the function memory transmission if you have already decided to use delayed transmission, multi-address transmission, direct multi-address transmission or polling. If the available memory is exhausted before all documents have been read into the memory, your fax machine interrupts the memory operation. If you wish to transmit the documents already stored, press **START**. Or:

Cancelling the memory functions

You can cancel stored jobs at any time:



Press **RESET** and your fax machine asks

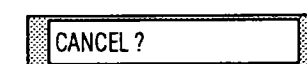

If you confirm with **START**, the memory function will be cancelled.

You can transmit at any time

There are messages which are better sent during the night. For overseas connections, for example, you can simply bridge a time gap of several hours: programme your fax machine to send your message at a specific time. This can also contribute to considerable savings in telephone charges.

Delayed transmission

This option is not available if the functions memory transmission, multi-address transmission, direct multi-address transmission or polling are activated.



3x FUNCTION

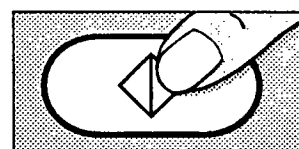
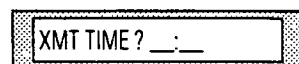
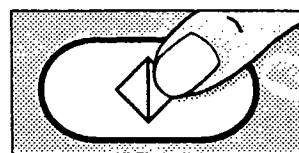
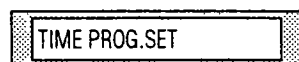

Load the document and, if necessary, select the required resolution.* After the document is fed in, the following display appears ...

Press FUNCTION three times and your fax machine displays:

Press START to programme the transmission time:

e.g. your message is to be sent at 11.45 p.m. On the dial keypad, enter: 2345

Confirm your entry with START and programme the receiver's telephone number.

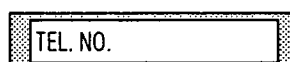

Enter the telephone number by alphabet dialling, one-touch dialling or on the dial keypad and press START. For multi-address transmission to groups, enter the required receiver group using the one-touch key.

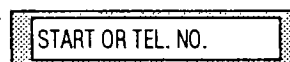

You now have the possibility of entering other receiving parties (up to 20). Confirm each entry with START.

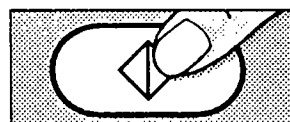

After making the last entry: Press START once more and your document will be read into the memory.

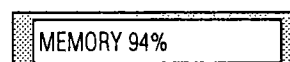

Your fax machine displays the available memory e.g. 94%...

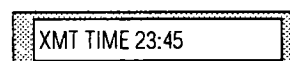

... and the transmission time programmed.

* Restrictions also apply to delayed transmission when the available memory is insufficient. See pages 22 + 25.



Polling

This function enables callers to call up a document which you have reserved for one or more receiving parties.

Reserve polling with or without data security

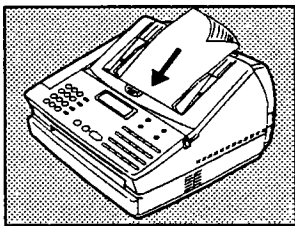

Load the document which you wish to have polled in the document feeder.

Your document is fed in and your fax machine displays:



2x **FUNCTION**

Press **FUNCTION** twice and this brings you to the SET POLLING menu.

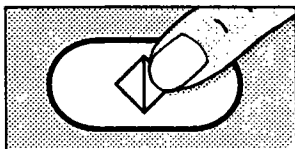
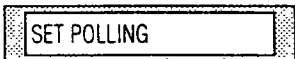

After you press **START**, your fax machine asks...



...whether you wish to use a password.

SELECT

SELECT now gives you the possibility of switching between the **PASSWORD** options.

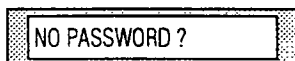

If you confirm the setting **NO PASSWORD** by pressing **START**, any caller has access to your document.

Choose **password ON**, proceed as described on the next page under "4-DIGIT-CODE".

The consequences of your next decision are even more far-reaching...

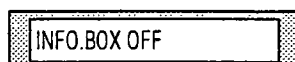

...**INFO.BOX OFF** or **ON**?

SELECT

If you press **SELECT** and select the setting **INFOBOX ON**, all callers have access to your document. However, it will not be deleted as in the case of polling without a password but will be available to all callers until you cancel the polling mode.

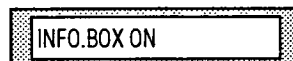

Confirm your selection with **START**. Press **START** again and your fax machine reads the document into the memory and shows this display.

* Restrictions also apply to document polling when the available memory is insufficient. See pages 22 + 25.

Cancelling the polling function

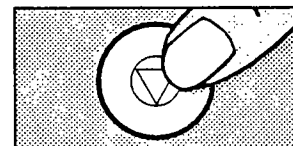

Simply press **RESET**. The display then asks:

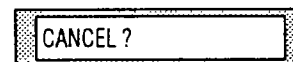

Press **START** within five seconds. Stored data are then deleted and your fax machine prints out a "blank" polling report.

Programmed security: the 4-digit code

A password is required if you wish to protect your documents from unauthorized callers or wish to call up documents which are reserved only for you. The exchange of documents can only function when both parties enter an agreed code. This is how it works:

7x  **FUNCTION**

Press FUNCTION seven times ...



With the next step, you can now ...

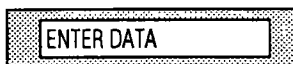

... and the display for data entry is shown.



... enter a 4-digit code.*

4x  **SELECT**

Press SELECT four times:

If you confirm your password by pressing START, your fax machine reports: ...

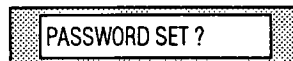

... and confirm the suggestion PASSWORD SET by pressing START.



... that the entry is complete and automatically switches to the mode for entering further data.

* The password may not consist of a combination of * or # and digits.
The password function may only be used when your partner's fax machine can handle this function.

If 4 asterisks (****) are entered as password, the password transmitted by your partner during polling will not be checked.
Polling is not possible if you enter "####" as password.

Deleting password

You can overwrite a password with another one or delete by entering **** instead of a 4-digit code.
If the number you have entered is incorrect, press RESET and reenter your password.

You too can call up messages

This is how you can call up reserved documents from other fax machines:

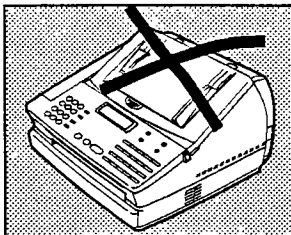

There must not be documents loaded in the document feeder of your fax machine.

2x  **FUNCTION**

FUNCTION brings you to the required option:

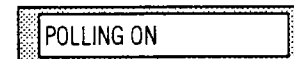

When the display shows...



Confirm SET POLLING by pressing START.

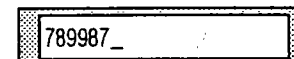

... enter the sender's telephone number: by alphabet dialling, one-touch dialling, using the group keys or the dial keypad:



Then press START - unless you used one-touch dialling.

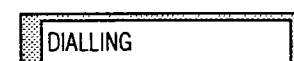

Your fax machine dials your partner's number, receives the polled message and prints it out together with a polling report...

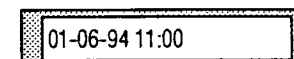
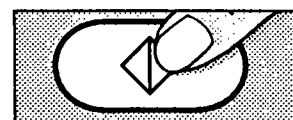

... and then returns to the standby mode.

- If your partner has protected polling with an agreed code, enter the password when your fax machine asks for this.
- You can also poll documents from different senders which are stored on a group key. Details are given from page 20.
- If a polling function has already been activated, it is not possible to poll any other documents.

Sometimes the setting makes all the difference

The functions described here have been set in the factory to proven standards. You can, however, adjust these functions to your own specific requirements by following these instructions: You always start by keying forward to the select options menu with which you can determine your settings.

7x  FUNCTION



From this menu...



SELECT OPTIONS is the starting point for all the settings on your fax machine described here. After pressing START...

8x  SELECT

... after pressing SELECT eight times, you arrive at this display:

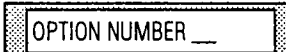

... your fax machine asks you to enter one of the following OPTION NUMBERS.

ECM: error correction mode

is always switched on. Transmission errors due to poor telephone line conditions are recognized and the relevant section of text retransmitted. Transmission time may be extended but if the correction mode is switched off, messages received from you may be garbled or contain errors. If the transmission is particularly bad, your fax machine will report COMM.ERROR. You can only switch on the error correction mode for your next transmission:



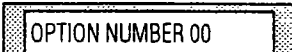

Enter 00 on the dial keypad and your fax machine reports:

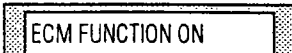

Select ON or OFF with SELECT.

 SELECT

Confirm your entry by pressing START ...



...You can now enter...

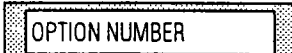

... other option numbers, or...

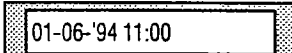

... conclude the entry procedure by pressing RESET and returning to the standby mode.

Ring-delay

When your fax machine recognizes a telephone call, it rings. As long as it is ringing, you can take the call by lifting the handset or pressing RESET. After the pre-set ring-delay, your fax machine switches to fax reception. This function setting allows you to determine this ring-delay.



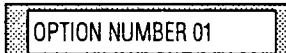

Enter 01 on the dial keypad and your fax machine reports:



The pre-set delay is 4 rings. Press SELECT and you can select the required number of rings and confirm with START.

 SELECT

Transmission reports

Transmission reports can be printed out after each message transmitted or only if there is an error. This is how to determine the setting:



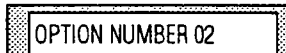

Enter 02 on the dial keypad and your fax machine reports:



Select ON or OFF with SELECT, confirm your entry with START and return to the standby mode by pressing RESET.

 SELECT



Instruction to enter this menu: see above.

Further settings

Auto delay

In the AUTOMATIC RECEPTION MODE, you can determine the number of rings before your fax machine switches into an incoming call.



OPTION NUMBER 03

Enter 03 on the dial keypad and your fax machine reports:

AUTO DELAY 01

Confirm the set number 01 or select a longer delay (up to 04) with SELECT.

Your selection is activated when you press START. RESET returns you to the standby mode.

SELECT

Paper size

Your recording paper can be either A4 or letter format.



OPTION NUMBER 04

Enter 04 on the dial keypad and your fax machine reports the standard setting:

PAPER SIZE A4

You can switch over to the alternative, PAPER SIZE LET by pressing SELECT.

Confirm your selection with START and return to the standby mode by pressing RESET.

SELECT

TEL/FAX switching in manual receiving mode

This setting allows you to determine whether your fax machine waits for several ringing signals (see function 01) or whether it switches over directly to fax reception.



OPTION NUMBER 05

Enter 05 on the dial keypad, the standard setting appears:

TEL DELAY ON

With SELECT, you can select either TEL DELAY ON or TEL DELAY OFF.

If you confirm TEL DELAY ON by pressing START, you can determine the number of rings before your fax machine takes the call.

SELECT

Number of rings before your fax machine switches over to FAX reception

As long as your extra telephone is ringing, you can take incoming calls. After this, your fax machine takes over.



OPTION NUMBER 06

If you enter OPTION NO 06, you can determine in the next display the number of rings before your fax machine switches over to automatic fax reception.

TEL DELAY 04

The standard setting on the display can be modified by pressing SELECT.

Confirm your entry with START.

SELECT

Pre-set resolution

When you load a document into the document feeder to be transmitted, polled or stored, the standard scanner setting is the factory setting: resolution in the standard mode. Depending on the type of document, you can also select the resolutions FINE, SUPER FINE or HALF TONE for the next transmission. (See page 23). However, you may also determine the standard setting FINE for all documents:



OPTION NUMBER 07

Enter OPTION NO 07.

DEFAULT RES.STD

SELECT

You can modify the standard setting by pressing SELECT.

Confirm your entry with START.



Instruction to enter this menu: see page 29.

Further settings

Your fax machine uses normal paper, mostly A4 format, as recording paper. If an incoming fax message is longer than a sheet of recording paper, the printer offers several possibilities of recording the message.

Reduced reproduction*

The reduction setting helps you save paper.



OPTION NUMBER 09

... enter 09 on the dial keypad and your fax machine reports:

COPY REDUCT. ON

Select ON or OFF with SELECT. Confirm your selection with START.

SELECT

* Documents received are "always" reduced in size.

Terminal ID

You can decide whether your name*, telephone number* and other information such as date and number of pages should be printed on the top of the documents your partner receives.



OPTION NUMBER 10

Enter 10 on the dial keypad and your fax reports:

HEADER PRINT ON

Select ON or OFF with SELECT. Confirm your entry with START and return to the standby mode by pressing RESET.

SELECT

* These details are compulsory in Germany.

Select the dialling method

Depending on the technical setting of your telephone network, you will have to select either DP 10 PPS or tone dialling. In case of doubt, please contact your competent telecommunications office or set DP 10 PPS.



OPTION NUMBER 11

Enter 11 on the dial keypad:

DP 10 PPS

With SELECT, you can decide whether your fax machine should use the DP 10 PPS dialling procedure...

SELECT

TONE DIALLING

... or TONE DIALLING. Confirm your decision with START and return to the standby mode by pressing RESET.



Instruction to enter this menu: page 29.

Redialling

When the connection you have dialled is busy, your fax machine automatically repeats the dialling a maximum of 10 times. You can set this yourself.



OPTION NUMBER 12

Enter 12 on the dial keypad and your fax machine reports:

REDIAL TIMES 08

You can modify the standard setting with SELECT. Confirm your entry with START and press RESET to return to the standby mode.

SELECT

Transmission speed

The higher the data transmission rate (measured in BPS) when transmitting and receiving, the quicker the transmission of your fax message. Your fax machine adjusts its transmission speed automatically to the remote machine. You may, however, also determine the maximum transmission speed yourself.



OPTION NUMBER 13

Enter 13 on the dial keypad and your fax machine reports:

XMT SPEED 9600

You can select the standard setting with SELECT. The settings 7200, 4800 and 2400 BPS are also available. Confirm your selection by pressing START and return to the standby mode with RESET.

SELECT

Reception speed

Instead of selecting a lower transmission rate each time due to poor telephone line conditions (see page 33), this setting allows you to determine a constant slower reception speed.



OPTION NUMBER 14

Enter 14 on the dial keypad and your fax machine displays:

RCV SPEED 9600

Instead of the standard setting, with SELECT you can select an alternative. Confirm your selection with START and return to the standby mode by pressing RESET.

SELECT

RCV SPEED 4800



Instruction to enter this menu: see page 29.

Power saver

When the printer heater of your fax machine is not switched on 24 hours a day, you can save electricity with the power saver option.



OPTION NUMBER 15

Enter 15 on the dial keypad. Your fax machine then displays:

POWER SAVE ON

In this power-saving setting, your fax machine first stores incoming fax messages. To print out the message or your copy, the printer heater switches on. The printout then begins after a warm-up period of approx. 60 secs.

SELECT

With SELECT, you can switch between the positions POWER SAVE OFF or ON.

POWER SAVE OFF

Your printer is always on standby in this setting - but you do not save electricity. Confirm your selection with START and return to the standby mode with RESET.

Maximum document length

The standard setting limits the maximum document length for transmitting or copying to 1 metre. This setting too may be adjusted to meet your special requirements.



OPTION NUMBER 16

Enter 16 on the dial keypad and your fax machine displays:

DOC. LENGTH 1m

Instead of the standard setting, with SELECT you can select an alternative.

SELECT

Confirm your selection with START and return to the standby mode by pressing RESET.

DOC. LENGTH 10m

* Settings for extensions

If special settings are necessary as you wish to operate your fax machine in a telephone system with extensions, please contact your dealer. The following information should be available:

- dialling method at the extension
- access type with
 - flash
 - earth key
 - by dialling a specific number

The dealer may charge any costs incurred.

Selecting options by pressing just one key

You may modify the following settings via menus which may be called up directly:

Speaker volume

Determine whether you wish to listen during dialling and when the receiver answers, and determine the speaker volume.

4x  FUNCTION

SPEAKER VOLUME

VOL.LEVEL <<<<

SET COMPLETED

Press START:

The speaker volume is illustrated by the number of arrows: <<<<. Press the # key for lower or OFF, the * key for higher volume. The test tone during setting allows you to decide upon the correct volume. Complete your entry by pressing START ... and return to the standby mode with RESET.

Ringer volume

In the same way, you can determine the volume at which your fax machine indicates incoming calls. Press

5x  FUNCTION

RINGER VOLUME

... and set the volume as described above.

Resetting transmission speed

If transmission errors frequently occur due to poor telephone line conditions, try a slower transmission rate of 4800 bit/s instead of the standard 9600.

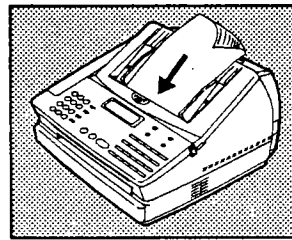

When the document is loaded...

 FUNCTION

... press FUNCTION once. Your fax machine offers:

TX SPEED 4800

Confirm this setting* with START and ...

DOC.READY 4800

... start transmission as usual by entering a telephone number.

* You can cancel this setting by pressing RESET, removing the document or making a copy.



Transmission reports and more

are printed in the standard setting automatically after each transmission. There are two types:

This is a normal transmission report:

*** ONE TOUCH DIAL LIST ***		
26-10-94 11:31		ID:48213115828 TOSHIBA
NO.	NAME	TELEPHONE NUMBER /SUB (SEP)
01	TIU	004493205277
02	TISE	003418808788
03	SCRIBONA DK	004543455522
04	MARGIECIOK	02114373110
05		
06	OZALID	004114328731
07		
08		
09		
10		
11		
12		

After multi-address transmission, you will receive a report like this:

*** GROUP LIST ***		
26-10-94 11:37		ID:48213115828 TOSHIBA
GROUP1 BURG		
NO.	TELEPHONE NUMBER	/SUB (SEP)
01	004493205277	
02	003418808788	
GROUP2 DISTRIBUTORS		
NO.	TELEPHONE NUMBER	/SUB (SEP)
01	004543455522	
02	02114373110	
03	004114328731	
GROUP3		
GROUP4		

Useful lists and reports

keep you informed on your fax machine's current settings and status of jobs stored. They can be printed out at any time:

6x FUNCTION

REPORTS

ACTIVITY REPORT

ONE TOUCH LIST

ALPHABET LIST

GROUP LIST

OPTIONS REPORT

TIME CONF.LIST

PRINTING

The LCD display offers you a selection of lists:

Press START. SELECT keys you through the menu:

You accept the list you require by pressing START. The printout follows:

The options report:

Provides your technician with information on the settings of your fax machine:

*** OPTIONS REPORT ***		
26-10-94 11:22		ID:48213115828 TOSHIBA
USER OPTIONS		
NO.	OPTION	STATUS
00	ECH FUNCTION	-- ON
01	CALLING TIMES IN TEL	-- 04 TIMES
02	CONFIRMATION	-- ON
03	AUTO MODE RING DELAY	-- 01 TIMES
04	PAPER SIZE	-- A4
05	TEL MODE ANS.DELAY	-- ON
06	TEL ANS.DELAY TIMES	-- 04 TIMES
07	DEFAULT RESOLUTION	-- STD
08	NOT USED	
09	COPY REDUCTION	-- OFF
10	HEADER	-- PRINT
11	DIAL METHOD	-- DP 18 PPS
12	NOT USED	
13	TX INITIAL SPEED	-- 9600 BPS
14	RCV INITIAL SPEED	-- 9600 BPS
15	POWER SAVE MODE	-- ON
16	DOCUMENT LENGTH	-- 1

To make a good impression: a new toner cartridge

After printing many pages, TONER NEAR EMPTY and later TONER EMPTY appear on the display. This means you must insert a new toner cartridge in your fax machine:

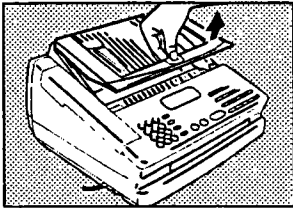

Open the top cover.
Don't forget: First remove the mains plug from the socket.

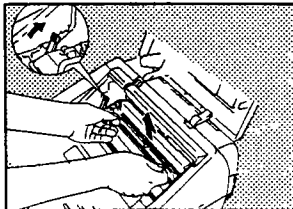

To replace toner:
Slide the green lock lever on the left side of the machine to the back and remove the process unit.

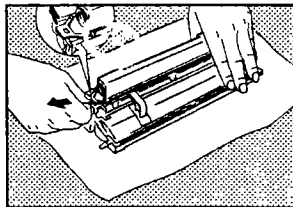

Place the process unit on a piece of paper on an even surface. Lightly tap on the toner cartridge to prevent any toner residue falling into the process unit. Pull the tape on the toner cartridge upwards before you slide it out of its holder.

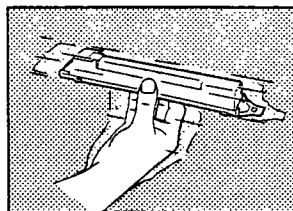

First shake the new cartridge...

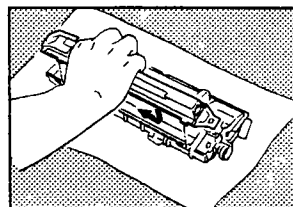

...then place on top of the process unit and slide it until it locks into place.

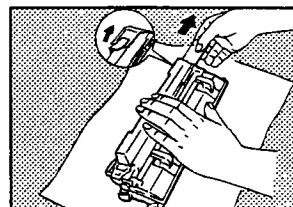

Now: remove the seal
When holding the protective foil, be sure to avoid contact with any toner residue.
Now shake the process unit several times horizontally before you...

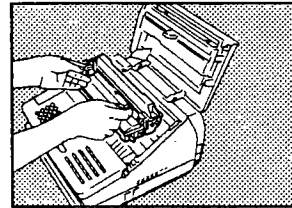

...install the process unit again.

Insert the pins into the lateral guides and then, by applying slight pressure, lower the unit into the correct position.

Now pull the lock lever forward again.



Never allow hair or dust to get into the process unit as this will block the proper supply of toner.

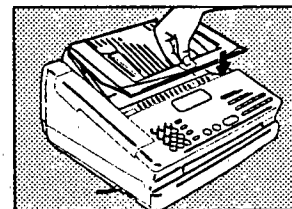

Then close the top cover and the control panel cover.

You can now connect your fax machine to the mains again.



When your fax machine is open, always keep the following in mind:

- Do not touch any parts inside the fax machine other than those described here. The fixer cover can be very hot – even after the machine has been switched off.
- You should install the process unit as quickly as possible as exposure to strong light can damage the drum and reduce the life of the process unit.
- Never throw old toner cartridges into an open fire and ensure proper disposal of packaging from exchanged parts as organic waste.

In case you come into contact with toner:

- Wash hands in cold water and clean thoroughly with soap.
- Wash eyes with plenty of water.
- If you have inhaled toner, breathe deeply in the open air.
- If toner gets in your mouth, wash it out with plenty of water.
- In an emergency, call a doctor.

How to clear a recording paper jam

When documents are fed in and recording paper fed out, this can lead to minor problems from time to time which, however, you can easily put right yourself. Just one point to remember: your fax machine should not be switched off as this would delete all the stored fax messages.*

How to clear a document jam

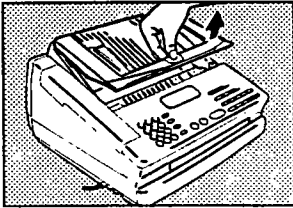

Press the release button to open the control panel cover.

 Keep the power ON.

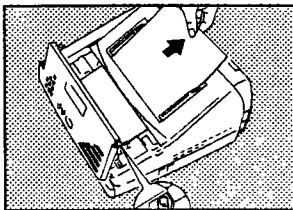

The jammed document can be carefully removed.

 Do not try to send the jammed document again. Use a carrier sheet or make a photocopy and transmit this instead.

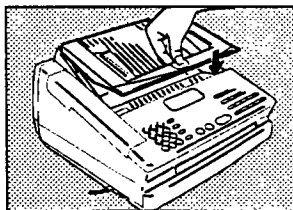

Close the control panel. Take care that the cover locks firmly into place.

Now by pressing START delete the error message.

* If you switched off your fax machine by mistake and thus deleted any fax message stored in the memory, ask for a reception report to be printed out. This gives the sender and you can ask him to send the message again.

How to clear a recording paper jam

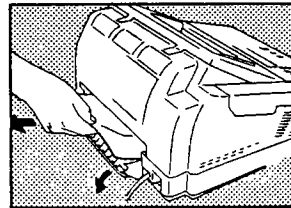

After opening the rear cover of the housing or the top cover, you will see whether paper has jammed here. Carefully remove any jammed paper without applying force. Don't forget to firmly close the back cover again!

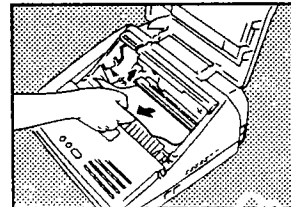

If paper has jammed under the process unit, lift the paper guide upwards and remove the process unit. You can then easily free any jammed paper without applying force.

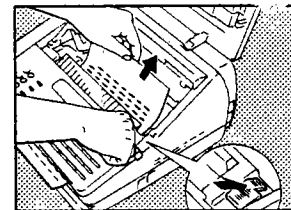

Has the recording paper jammed around the fixer unit? Then - if necessary - press the release lever of the fixer unit downwards and at the same time carefully pull out the jammed paper.

 Caution: HOT!

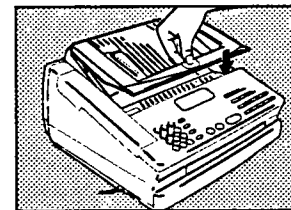

When closing the machine, ensure that all covers firmly lock into place.

From time to time: clean the housing

Never use abrasive materials to clean your fax machine - they could cause damage.

 Do not touch any parts inside the machine other than those described here. The heater cover may be very hot - even when the machine is switched off. Never open the recording paper cassette when paper is jammed.

To prevent your serviceman coming for nothing...

It can happen: your fax machine reports an operating error or fails to perform the required function. Before you make an unnecessary call on your service technician, take your time and see if you can help yourself. This checklist will help you recognize and eliminate errors.

Display	Cause	Corrective action
SYSTEM ERROR #	The fax machine has malfunctioned.	Pull the mains cable out of the socket and plug it in again. If this display is not cleared, contact your service centre.
CLOSE TOP COVER	The top cover is open.	Close the top cover.
NO PROCESS UNIT	The process unit is not installed.	Install the process unit.
DOCUMENT JAM	The document is jammed in the fax machine.	Open the control panel cover, remove the jammed document and load it again. (See also page 37)
	The document is longer than 1 metre.	Use a shorter document.
CHANGE PROC.UNIT	The process unit has reached the end of its life.	Replace the process unit. (See also page 8)
PAPER JAM ****%	The recording paper is jammed. The fax machine switches to memory reception and displays the available memory in % after the reception.	Remove the jammed paper. (See also page 37)
COMM.ERROR #003	If the memory is already full or becomes full during reception.	Press RESET and refer to page 39.
ADD PAPER ****%	The recording paper cassette is empty. The fax machine switches to memory reception and displays the available memory in % after the reception.	Load new recording paper in the cassette. (See also page 7)
TONER NEAR EMPTY	The toner is running out.	Order a new toner cartridge. About 100 sheets can be printed after this is displayed.
TONER EMPTY ****%	The toner cartridge is empty. The fax machine switches to memory reception and displays the available memory in % after the reception.	Replace the toner cartridge. (See also page 36)
COMM.ERROR	Communication error.	Refer to the information code table and take appropriate action. (See also page 39)

Error codes

If during or after transmission, COMM.ERROR is displayed. (It also appears in the transmission and reception reports under RESULT.)

Code number	Cause	Corrective action
001	Top cover or rear cover open.	Close the top cover or rear cover.
002	Document jam.	Remove the jammed document and load it again.
	The document is longer than 1 metre.	Use a shorter document.
003	Recording paper jam.	Remove jammed paper.
	Recording paper cassette is empty.	Load new paper.
	Toner cartridge is empty	Replace toner cartridge.
005-010	Line error.	Repeat transmission.
014	Read or print error.	Repeat transmission.
100-103	Line error.	Repeat transmission.
104	No document is loaded for polling.	Call the other party. Load the document before polling.
106	Wrong password for polling.	Call the other party and agree on password.
112-123	Line error.	Repeat transmission.
127	The other party's fax machine is not compatible.	Contact the other party and check compatibility.
128-156	Line error.	Repeat transmission.

Also check the following sources of error:

Error	Check
There is no display.	<ul style="list-style-type: none"> • Is the power cable properly plugged in? • Is the correct power supplied? Check the power by connecting another electrical appliance.
The document is not fed in	<ul style="list-style-type: none"> • Is the document torn or folded? • Are more than 20 sheets loaded? A maximum of 20 sheets can be loaded at one time.
No printout on the other party's recording paper.	<ul style="list-style-type: none"> • Is the document loaded facedown? • Has the other party's recording paper run out or is there a paper jam?
Communication error.	<ul style="list-style-type: none"> • If line conditions are poor, set a lower transmission speed.

If you cannot solve problems as described here, please contact your TOSHIBA dealer or service technician.

Glossary

You'll find a description of all functions at a glance.

* Pages marked with an * include useful basic information for setting the relevant machine functions.

Alphabeth Dialling	15*,18	Lists and Reports	34*,35
Automatic Redialling	14	Memory Funksions	25
Call Request	12	Menu Controls	10
Cancelling Reception	12	Multi-address Transmission	22
Cleaning the Fax Machine	37	One-Touch Dialling	15,21
Clearing a Document Jam	37	Printer Settings	29*,31
Concept of this Manual	5	Reduced Copies	31
Delayed Transmission	26	Power Saver	8
Dialling Method, Telephone	29*,31	Installing, replacing	8
Dialling Procedures, Fax Machine	Tone Dialling/DP 10 PPS	Incoming Calls, Fax Messages	12
	Standard	settings:	
	Alphabet Dialling	Automatic-	
	One-Touch Dialling	Manual Reception	
Documents	Automatic Document Feeder	TEL/FAX	12
	Calling-Up	Memory Reception	25
	Carrier Sheets	Inserting	7
	Copying	Setting	23
	Loading	Resolution	6
	Loading Correctly	Scope of Delivery	6
	Problem Documents	Sending Messages	
	Quality	Brief Description	9
	Reserve Polling	Alphabet Dialling,	
Error Codes	39	One-Touch Dialling	15-17*,18
Error Correction Function	29	Memory Transmission	25
Fax Machine	Unpacking	Individual Settings	29*-32
	Installing	During Dialling	33
	Connecting	Setting the Machine	
	Operating at Extensions	Speaker Volume	
	Summary	Standby Mode	10*,11
Function Displays	Multi-address Transmission,	Table of Contents	5
Groups	Polling	Telephone Numbers and Names	
	Storing, Modifying and	Storing	15*,16
	Deleting numbers	Deleting	15*,17
Initial Settings	Date and Time	Modifying	15*,17
	Automatic Receiving Mode	Setting	21
	Manual Receiving Mode	Replacing	36
	TEL/FAX Receiving Mode	Transmission and Reception Report	29,34
		Setting	29*,32
		Transmission Speed	
		Troubleshooting	
		Recognizing and	
		Eliminating Errors	38,39

Free Manuals Download Website

<http://myh66.com>

<http://usermanuals.us>

<http://www.somanuals.com>

<http://www.4manuals.cc>

<http://www.manual-lib.com>

<http://www.404manual.com>

<http://www.luxmanual.com>

<http://aubethermostatmanual.com>

Golf course search by state

<http://golfingnear.com>

Email search by domain

<http://emailbydomain.com>

Auto manuals search

<http://auto.somanuals.com>

TV manuals search

<http://tv.somanuals.com>