

# TOSHIBA

E: ENGLISH  
F: FRANÇAIS  
S: ESPAÑOL



# OWNER'S MANUAL

## LCD Color Television



COLORSTREAM®

Introduction

Connecting your TV

Using the Remote Control

Setting up your TV

Using the TV's Features

Appendix

Index

# 15DL75 20DL75

### Owner's Record

The model number and serial number are on the back of your TV. Record these numbers in the spaces below. Refer to these numbers whenever you communicate with your Toshiba dealer about this TV.

Model number:

Serial number:

# SAFETY INSTRUCTION MANUAL FOR YOUR TOSHIBA LCD Television

Always read and understand the **PRODUCT WARNINGS and USER DIRECTIONS** that are contained in this manual before attempting to use your LCD television, to help assure its safe use.

Always store this manual near your LCD television for convenient future reference.

Dear Customer,

Thank you very much for purchasing this Toshiba LCD television.

All of the safety Instructions that are contained in this manual must be read carefully and must be fully understood before you attempt to use this product in order to avoid potential hazards that could cause bodily injury or property damage, or could damage your LCD television.

We hope that you are completely satisfied with your Toshiba LCD television and it will give you long and enjoyable service. We look forward to providing you with additional Toshiba products to serve all of your entertainment needs in the future.

**Two categories of Safety instructions are included in this manual:**

1. **Product Warnings**, (i.e. what must never be done, to assure avoiding those hazards that could cause bodily injury or property damage).
2. **User Directions** (i.e. what must always be done, to assure the safe use of your Receiver/Tuner).

**The Safety Instructions contained in this manual have been categorized in accordance with the seriousness of the potential hazards, through the use of signal words.** Those Signal Words, and their intended meanings, are as follows:

- DANGER:** Indicates that the failure to observe the Safety Instructions could result in death or catastrophic bodily injury.
- WARNING:** Indicates that a failure to observe the Safety Instructions could result in serious bodily injury.
- CAUTION:** Indicates that a failure to observe the Safety Instructions could result in minor bodily injury or property damage.
- NOTE:** Designates Important Information that relates to the safe use of this product.

## Safety Precautions

**WARNING: TO REDUCE THE RISK OF FIRE OR ELECTRIC SHOCK, DO NOT EXPOSE THIS APPLIANCE TO RAIN OR MOISTURE.**



**WARNING: TO REDUCE THE RISK OF ELECTRIC SHOCK, DO NOT REMOVE COVER (OR BACK). NO USER-SERVICEABLE PARTS INSIDE. REFER SERVICING TO QUALIFIED SERVICE PERSONNEL.**

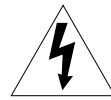

The lightning symbol in the triangle tells you that the voltage inside this product may be strong enough to cause an electric shock. **DO NOT TRY TO SERVICE THIS PRODUCT YOURSELF.**



The exclamation mark in the triangle tells you that important operating and maintenance instructions follow this symbol.

## WARNING

To prevent injury, this apparatus must be securely attached to the floor/wall in accordance with the installation instructions.

## NOTE TO CATV INSTALLERS

This is a reminder to call the CATV system installer's attention to Article 820-40 of the NEC, which provides guidelines for proper grounding and, in particular, specifies that the cable ground shall be connected to the grounding system of the building, as close to the point of cable entry as practical. For additional antenna grounding information, see items 26 and 27 on page 4.

# Child Safety

## It Makes A Difference Where Your TV Stands



**Congratulations on your purchase! As you enjoy your new TV, keep these safety tips in mind:**

### The Issue

- If you are like most consumers, you have a TV in your home. Many homes, in fact, have more than one TV.
- The home theater entertainment experience is a growing trend, and larger TVs are popular purchases; however, they are not always supported on the proper TV stands.
- Sometimes TVs are improperly secured or inappropriately situated on dressers, bookcases, shelves, desks, audio speakers, chests, or carts. As a result, TVs may fall over, causing unnecessary injury.

### Toshiba Cares!

- The consumer electronics industry is committed to making home entertainment enjoyable and safe.
- The Consumer Electronics Association formed the Home Entertainment Support Safety Committee, comprised of TV and consumer electronics furniture manufacturers, to advocate children's safety and educate consumers and their families about television safety.

### Tune Into Safety

- One size does NOT fit all! Use appropriate furniture large enough to support the weight of your TV (and other electronic components).
- Use appropriate angle braces, straps, and anchors to secure your furniture to the wall (but never screw anything directly into the TV).
- Carefully read and understand the other enclosed instructions for proper use of this product.
- Do not allow children to climb on or play with furniture and TVs.
- Avoid placing any item on top of your TV (such as a VCR, remote control, or toy) that a curious child may reach for.
- Remember that children can become excited while watching a program and can potentially push or pull a TV over.
- Share our safety message about this hidden hazard of the home with your family and friends. Thank you!



## Important Safety Instructions

- 1) **Read these instructions.**
- 2) **Keep these instructions.**
- 3) **Heed all warnings.**
- 4) **Follow all instructions.**



- 5) **Do not use this apparatus near water.**
- 6) **Clean only with dry cloth.**
- 7) **Do not block any ventilation openings.** Install in accordance with the manufacturer's instructions.

- 8) **Do not install near any heat sources** such as radiators, heat registers, stoves, or other apparatus (including amplifiers) that produce heat.

- 9) **Do not defeat the safety purpose of the polarized or grounding type plug.** A polarized plug has two blades with one wider than the other. A grounding type plug has two blades and a third grounding prong. The wide blade or the third prong are provided for your safety. If the provided plug does not fit into your outlet, consult an electrician for replacement of the obsolete outlet.

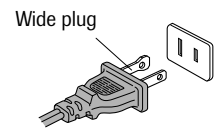

- 10) **Protect the power cord** from being walked on or pinched, particularly at plugs, convenience receptacles, and the point where they exit from the apparatus.

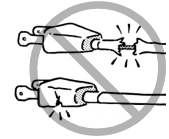

- 11) **Only use attachments/accessories specified by the manufacturer.**

- 12) **Use only with the cart, stand, tripod, bracket, or table specified by the manufacturer, or sold with the apparatus.** When a cart is used, use caution when moving the cart/apparatus combination to avoid injury from tip-over.



- 13) **Unplug this apparatus during lightning storms or when unused for long periods of time.**

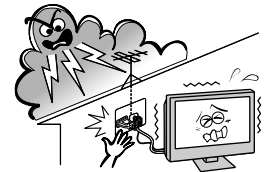

- 14) **Refer all servicing to qualified service personnel.** Servicing is required when the apparatus has been damaged in any way, such as power-supply cord or plug is damaged, liquid has been spilled or objects have fallen into the apparatus, the apparatus has been exposed to rain or moisture, does not operate normally, or has been dropped.

- 15) The apparatus shall not be exposed to dripping or splashing and that no objects filled with liquids, such as vases, shall be placed on the apparatus.

- 16) **CAUTION:** To reduce the risk of electric shock, do not use the polarized plug with an extension cord, receptacle, or other outlet unless the blades can be inserted completely to prevent blade exposure.



2500 Wilson Blvd.  
Arlington, VA 22201 U.S.A.  
Tel. 703-907-7600 Fax 703-907-7690  
www.CE.org



*CEA is the Sponsor, Producer and  
Manager of the International CES®*

# Installation, Care, and Service

## Installation

Follow these recommendations and precautions and heed all warnings when installing your TV:

- 17) Never modify this equipment. Changes or modifications may void: a) the warranty, and b) the user's authority to operate this equipment under the rules of the Federal Communications Commission.

- 18)  **DANGER: RISK OF SERIOUS PERSONAL INJURY, DEATH, OR EQUIPMENT DAMAGE!** Never place the TV on an unstable cart, stand, or table. The TV may fall, causing serious personal injury, death, or serious damage to the TV. 

- 19) Never place or store the TV in direct sunlight; hot, humid areas; or areas subject to excessive dust or vibration.

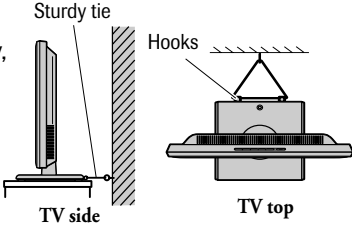
- 20) Always place the TV on the floor or a sturdy, level, stable surface that can support the weight of the unit. To secure the TV, use a sturdy tie from the hooks on the rear of the TV pedestal to a wall, pillar, or other immovable structure. Make sure the tie is tight, secure, and parallel to the floor. Leave a space of at least 4 inches around the TV.
- 

- 21) Never expose the apparatus to dripping or splashing liquid or place items such as vases, aquariums, any other item filled with liquid, or candles on top of the TV.

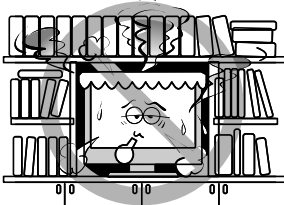
- 22) Never block or cover the slots or openings in the TV cabinet back, bottom, and sides. Never place the TV:
- on a bed, sofa, rug, or similar surface;
  - too close to drapes, curtains, or walls; or
  - in a confined space such as a bookcase, built-in cabinet, or any other place with poor ventilation.
- 

The slots and openings are provided to protect the TV from overheating and to help maintain reliable operation of the TV.

- 23) Never allow anything to rest on or roll over the power cord, and never place the TV where the power cord is subject to wear or abuse.

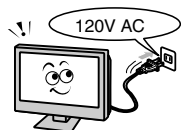

- 24) Never overload wall outlets and extension cords.

- 25) Always operate the TV with a 120V AC, 60Hz power source only.

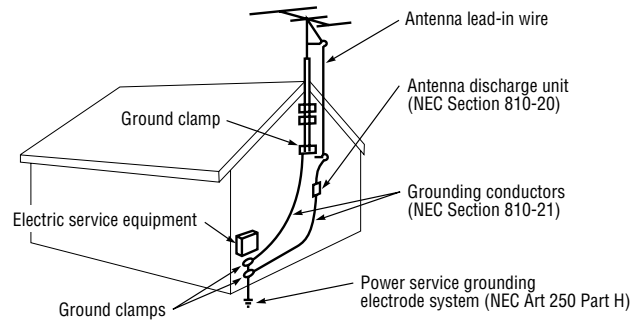

- 26) Always make sure the antenna system is properly grounded to provide adequate protection against voltage surges and built-up static charges (see Section 810 of the National Electric Code).





- 27)  **DANGER: RISK OF SERIOUS PERSONAL INJURY OR DEATH!**
- Use extreme care to make sure you are never in a position where your body (or any item you are in contact with, such as a ladder or screwdriver) can accidentally touch overhead power lines. Never locate the antenna near overhead power lines or other electrical circuits.
  - Never attempt to install any of the following during lightning activity: a) an antenna system; or b) cables, wires, or any home theater component connected to an antenna or phone system.
- 

## Care

For better performance and safer operation of your TOSHIBA TV, follow these recommendations and precautions:

- 28) If you use the TV in a room whose temperature is 32 °F (0 °C) or below, the picture brightness may vary until the LCD warms up. This is not a sign of malfunction.

- 29) Always unplug the TV before cleaning. Wipe the display panel surface gently using only a soft cloth (cotton, flannel, etc.). A hard cloth may damage the surface of the panel. Avoid contact with alcohol, thinner, benzene, acidic or alkaline solvent cleaners, abrasive cleaners, or chemical cloths, which may damage the surface. Do not splay volatile compounds such as insecticide on the cabinet. This may cause a discoloration or damage the cabinet.
- 

- 30)  **WARNING: RISK OF ELECTRIC SHOCK!** Never spill liquids or push objects of any kind into the TV cabinet slots.

---

31) While it is thundering, do not touch the connecting cables or apparatus.

---

32) For added protection of your TV from lightning and power surges, always unplug the power cord and disconnect the antenna from the TV if you leave the TV unattended or unused for long periods of time.

---

33) During normal use, the TV may make occasional snapping or popping sounds. This is normal, especially when the unit is being turned on or off. If these sounds become frequent or continuous, unplug the power cord and contact a Toshiba Authorized Service Center.

---

34)



**WARNING: RISK OF SERIOUS PERSONAL INJURY OR EQUIPMENT DAMAGE !**



Never strike the screen with a sharp or heavy object.

---

35) • If you have the LCD screen facing to the sun, the LCD screen will be damaged. Be aware of locating the TV in the place such as window side or outside of the room.

- Do not press the LCD screen strongly or scratch it, and do not putting anything on it. These actions will damage the LCD screen.
- 

## Service

36)



**WARNING: RISK OF ELECTRIC SHOCK !**

Never attempt to service the TV yourself. Opening and removing the covers may expose you to dangerous voltage or other hazards. Refer all servicing to a Toshiba Authorized Service Center.

---

37) If you have the TV serviced:

- Ask the service technician to use only replacement parts specified by the manufacturer.
  - Upon completion of service, ask the service technician to perform routine safety checks to determine that the TV is in safe operating condition.
- 

38) The cold cathode fluorescent lamp in the LCD panel contains a small amount of mercury. When the TV reaches the end of its useful life, dispose of the used TV by the approved method for your area, or ask a qualified service technician to properly dispose of the TV.



**Note:** The lamp unit contains mercury, the disposal of which may be regulated due to environmental considerations. For disposal or recycling information, contact your local authorities or the Electronics Industries Alliance ([www.eiae.org](http://www.eiae.org)).

---

## Important notes about your LCD TV

**The following symptoms are not signs of malfunction but technical limitation. Therefore TACP/TCL disclaims any responsibility for these symptoms.**

- 1) Under certain conditions, the display of this LCD TV may cause interference with the audio and/or video of certain types of electronic equipment that easily receive electromagnetic waves (e.g., AM radios and video equipment). In particular, the display of this LCD TV may affect certain types of electronic equipment that are located beyond the area where the LCD TV is being used.
- 2) If a still picture is displayed, an afterimage may remain on the screen, however it will disappear.
- 3) The LCD panel on this TV is manufactured using an extremely high level of precision technology; however, an occasional pixel (dot of light) may display constantly on the screen.  
This is a structural property of LCD technology and is not a sign of malfunction.  
Such pixels are not visible when the picture is viewed from a normal viewing distance.

**Note:** Interactive video games that involve shooting a “gun” type of joystick at an on-screen target may not work on this TV.

<b>Introduction.....</b>	<b>7</b>
Welcome to Toshiba .....	7
Supplied accessories .....	7
Connecting the power cord .....	7
Exploring your new TV .....	8
Rear terminal cover .....	9
Cable clamber .....	9
Adjusting the TV viewing angle .....	9
<b>Connecting your TV .....</b>	<b>10</b>
Connecting an antenna or cable TV .....	10
Connecting a VCR .....	11
Connecting a cable converter box .....	11
Connecting a cable converter box and a VCR .....	11
Connecting a DVD player with ColorStream® (component video) and a VCR .....	12
Connecting a DTV receiver/set-top box with ColorStream® (component video) and a VCR .....	13
Connecting an audio system .....	14
Connecting a camcorder .....	14
Connecting a personal computer (PC) .....	15
<b>Using the remote control .....</b>	<b>16</b>
Learning about the remote control .....	16
Installing the remote control batteries .....	16
Remote control effective range .....	16
<b>Setting up your TV .....</b>	<b>17</b>
Learning about the menu system .....	17
Changing the on-screen display language .....	18
Adding channels to the TV's memory .....	18
Programming channels automatically .....	18
Adding and erasing channels manually .....	19
Changing channels .....	19
Programming your favorite channels .....	19
<b>Using the TV's features.....</b>	<b>20</b>
Switching between two channels using Channel Return .....	20
Using the Blue screen feature .....	20
Selecting the video input source .....	20
Using the V-Chip menu .....	21
V-Chip rating and categories .....	21
V-Chip (Parental menu) setup .....	22
Adjusting the picture .....	23
Selecting the picture mode .....	23
Adjusting the picture quality .....	23
Using the closed caption feature .....	24
To turn on or off the Closed Caption feature .....	25
Using the Panel lock feature .....	25
Setting the sleep timer .....	25

Adjusting the sound .....	26
Muting the sound .....	26
Selecting stereo/SAP broadcasts .....	26
Using the WOW™ surround sound feature .....	27
Selecting the audio mode .....	27
Adjusting the sound quality .....	28
Using the StableSound® feature .....	28
Using the PC setting feature .....	29
Using the Auto off feature .....	30
Displaying on-screen information .....	30
Understanding the last mode memory feature .....	30
<b>Appendix.....</b>	<b>31</b>
Specifications .....	31
Troubleshooting .....	32
Limited United States Warranty .....	33
Limited Canada Warranty .....	34
<b>Index.....</b>	<b>35</b>

# Introduction

## Welcome to Toshiba

Thank you for purchasing this Toshiba LCD TV, one of the most innovative LCD color TVs. The goal of this manual is to guide you through setting up and operating your Toshiba TV as quickly as possible.

The model and serial numbers are on the back of your TV. Write these numbers in the space provided on the front cover of this manual for your records.

Instructions in this manual are based on using the remote control. You also can use the controls on the TV if they have the same name as those referred to on the remote control.

Please read all the safety and operating instructions carefully, and keep this manual for future reference.

## Supplied accessories

Check that you have the accessories and items shown.

Owner's Manual  
(This book)

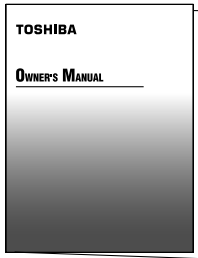

Remote control



Batteries for the remote control  
R03 (AAA) × 2

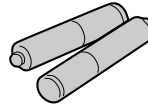

Power cord



## Connecting the power cord

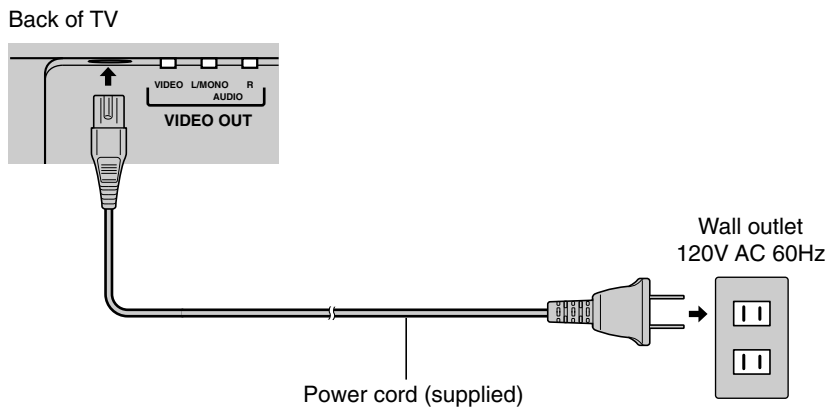

\* The power cord supplied with this product is to be used in United States and Canada only. If this product is used in another country, use a power cord which confirms to the law or regulations of that country.

## Exploring your new TV

You can operate your TV by using the buttons on the top panel or the remote control. The A/V terminals for connecting other equipment to your TV are on the back panel and side panel (see illustrations below). Also see "Connecting your TV" on pages 10-15. Model 20DL75 is used in this manual for illustration purpose.

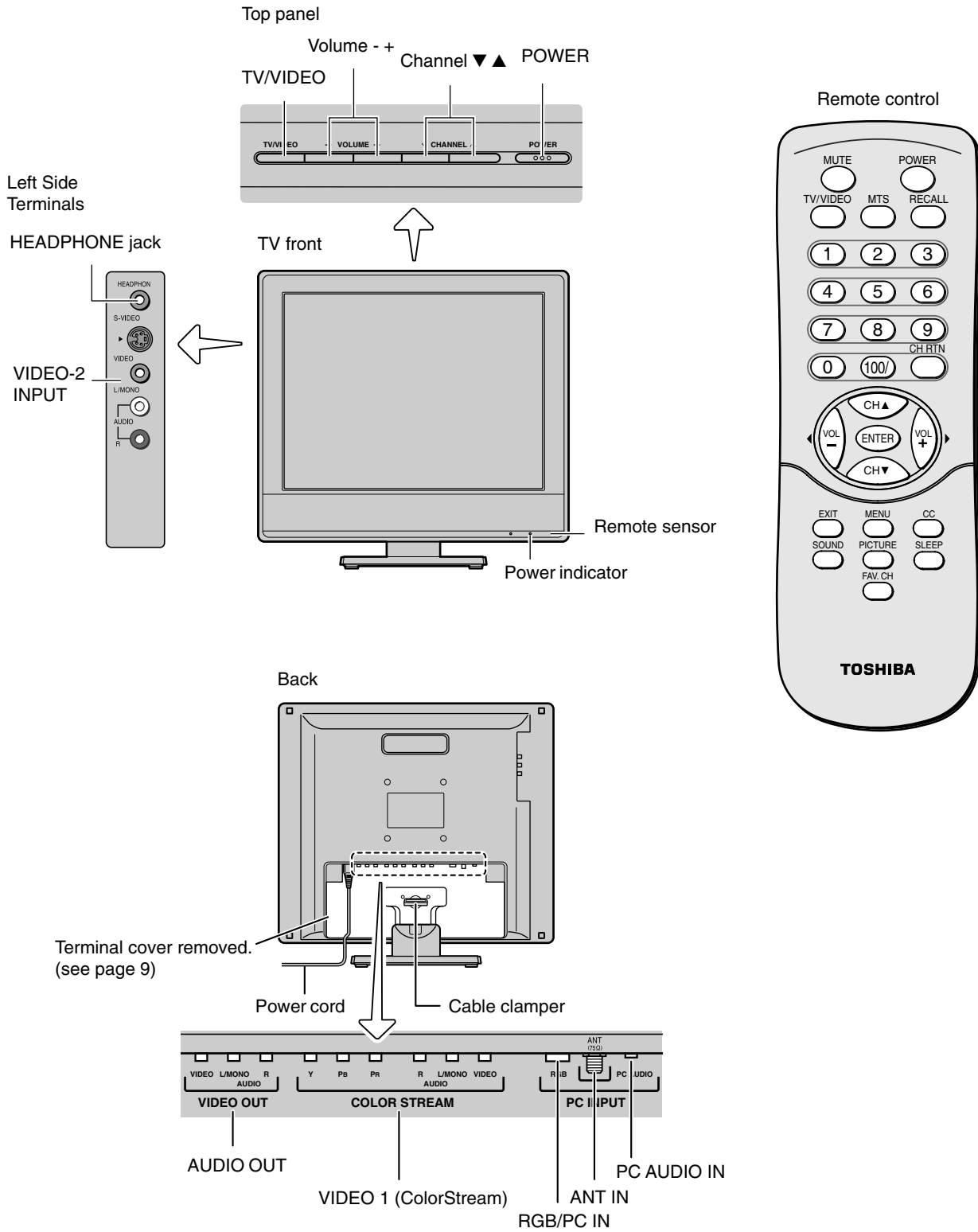



### Rear terminal cover

The connection panel is hidden behind the terminal cover.

1. Remove the cover. Release the three hooks on the bottom of the cover.
2. Install cables as necessary.
3. Reinstall the cover. Align the holes on the TV back with the two tabs on the rear terminal cover as shown.
4. Close the cover.

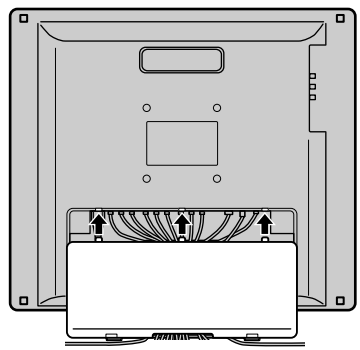
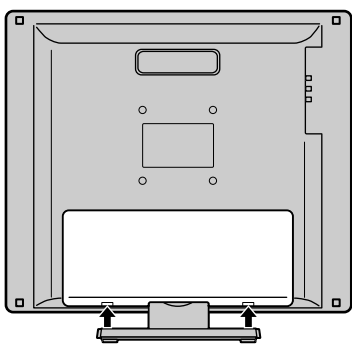

### Cable clammer

The cable clammer can be used to bundle the connection cables (see page 10).

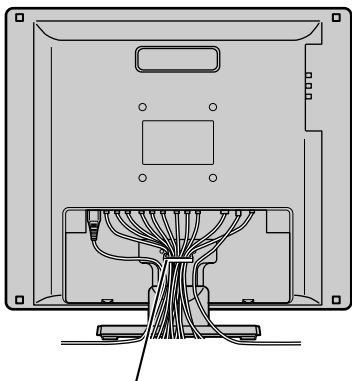

Cable clammer



**WARNING: RISK OF SERIOUS PERSONAL INJURY OR EQUIPMENT DAMAGE !**

*Never grasp the cable clammer when moving or lifting the TV. The cable clammer could break, causing the TV to fall.*

### Adjusting the TV viewing angle

You can adjust the angle of the TV screen.

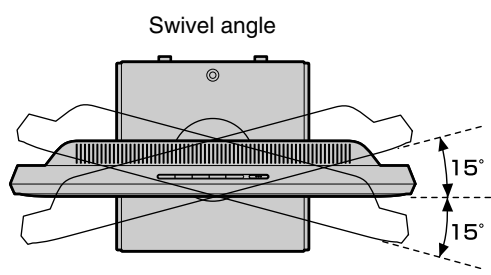

Swivel angle

Tilt angle

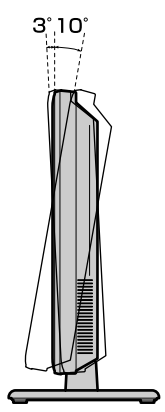

## Connecting your TV

**Note:** All required cables, if not provided with your other devices, can be purchased at many electronics accessory suppliers.

- **Coaxial (F-type) cable** is used for connecting your antenna, cable TV service, and/or cable converter box to the ANT 75 Ω RF inputs on your TV.
- **Standard A/V cables (composite video)** usually come in sets of three, and are for use with video devices with standard audio and standard (composite) video output. These cables (and the related inputs on your TV) are typically color-coded according to use: yellow for video, red for stereo right audio, and white for stereo left (or mono) audio.
- **S-video cable** is for use with video devices with S-video output. Separate audio cables are required for a complete connection.

**Note:** An S-video cable provides better picture performance than a composite video cable.

- **Component video cables** come in sets of three and are for use with video devices with component video output. These cables are typically color-coded red, green, and blue. (ColorStream® is Toshiba's brand of component video.) Separate audio cables are required for a complete connection.

**Note:** Component video cables provide better picture performance than a standard (composite) video or S-video cable.

- **Mini D-sub 15pin cable** is for use with a personal computer with an analog RGB (15pin) output. Separate audio cable is required for a complete connection.

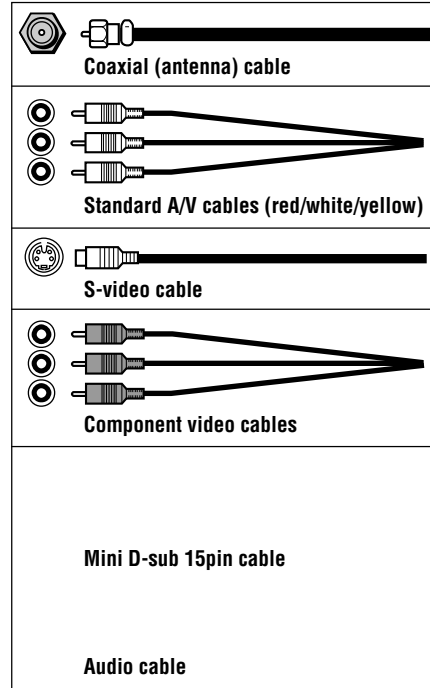

## Connecting an antenna or cable TV

This connection allows you to watch TV programs or basic cable channels.

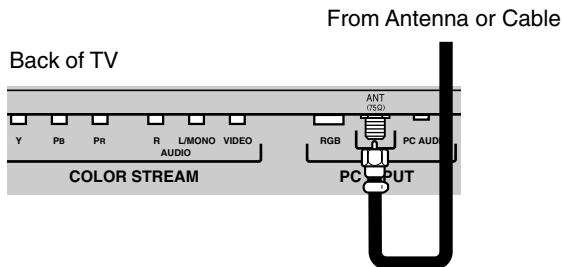

**NOTE: RISK OF EQUIPMENT DAMAGE!**

Never plug in any power cords until you have finished connecting all equipment.

## Connecting a VCR

This connection allows you to watch local channels and video programs, play or record on the VCR while watching TV, and record from one channel while watching another channel.

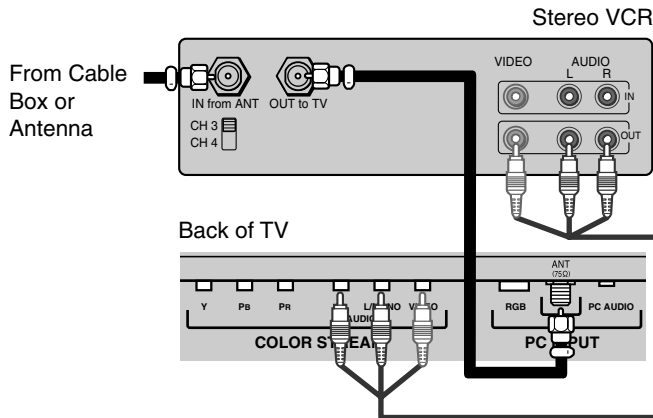

### Note:

If you have a mono VCR, connect L/Mono to VCR Audio OUT using only one audio cable.

If you have a VCR with S-video, use an S-video cable (in the S-video jacks) instead of a standard video cable.

The TV side panel can be used to connect a VCR with S-video.

## Connecting a cable converter box

This connection allows you to watch basic and premium cable channels. Tune the TV to channel 3 or 4 (whichever channel is vacant in your area), and use the converter box to change channels.

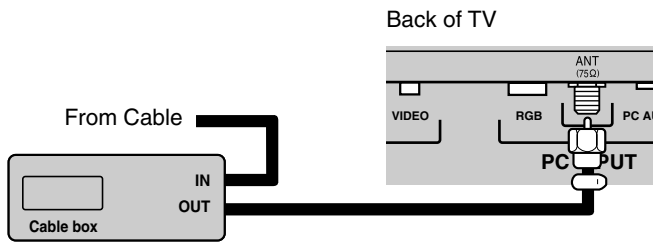

### Note:

When you use a converter box with your TV, the remote control will not operate some features, such as programming your favorite channels, and channel return function.

## Connecting a cable converter box and a VCR

This connection allows you to watch and record basic and premium cable channels, as well as watch videotapes. Set the TV signal source to Video1 (page 20). Tune the VCR to channel 3 or 4 (the same channel as the converter box output switch), and use the cable converter box to change channels.

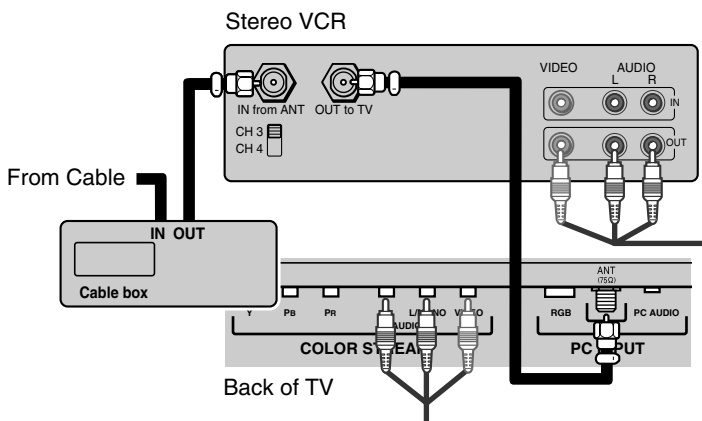

### Note:

When you use a converter box with your TV, the remote control will not operate some features, such as programming your favorite channels, and channel return function.

If you have a mono VCR, connect L/Mono to VCR Audio OUT using only one audio cable.

If you have a VCR with S-video, use an S-video cable (in the S-video jacks) instead of a standard video cable.

The TV side panel can be used to connect a VCR with S-video.

The unauthorized recording, use, distribution, or revision of television programs, videotapes, DVDs, and other materials is prohibited under the Copyright Laws of the United States and other countries, and may subject you to civil and criminal liability.

## Connecting a DVD player with ColorStream® (component video) and a VCR

This connection allows you to watch DVD, VCR, and TV programs, and record TV programs.

Your TV has ColorStream® (component video) inputs. Connecting your TV to a DVD player with component video can greatly enhance picture quality and realism.

- To record one TV program while watching another TV program, tune the VCR to the channel to record, and tune the TV to the channel to watch.
- To record a TV program while watching a DVD, tune the VCR to the channel to record, and select Video1 on the TV (see “Selecting the video input source” on page 20).

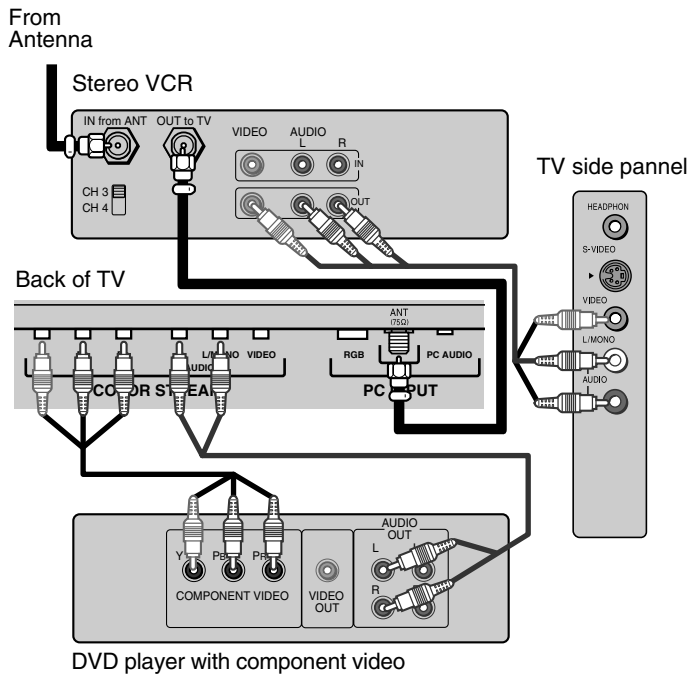

**Note:**

For the highest possible picture quality, use component video cables between the TV and DVD player.

The TV side panel can be used to connect a VCR with S-video.

The unauthorized recording, use, distribution, or revision of television programs, videotapes, DVDs, and other materials is prohibited under the Copyright Laws of the United States and other countries, and may subject you to civil and criminal liability.

## Connecting a DTV receiver/set-top box with ColorStream® (component video) and a VCR

This connection allows you to watch DTV (digital TV), VCR, and TV programs, and record DTV (composite video only) and TV programs.

Your TV has ColorStream® (component video) inputs. Connecting your TV to a DTV receiver with component video can greatly enhance picture quality and realism.

- To record and watch a DTV program, select LINE IN on the VCR, and select Video1 on the TV (see “Selecting the video input source” on page 20).
- To record a TV program while watching a DTV program, tune the VCR to the channel to record, and select Video1 on the TV.
- To record and watch the same TV program, tune the VCR to the channel to record, and select Video1 on the TV.
- To record one TV program while watching another TV program, tune the VCR to the channel to record, and tune the TV to the channel to watch.

### Note:

For the highest possible picture quality, use component video cables between the TV and DTV receiver/set-top box.

The TV side panel can be used to connect a VCR with S-video.

The unauthorized recording, use, distribution, or revision of television programs, videotapes, DVDs, and other materials is prohibited under the Copyright Laws of the United States and other countries, and may subject you to civil and criminal liability.

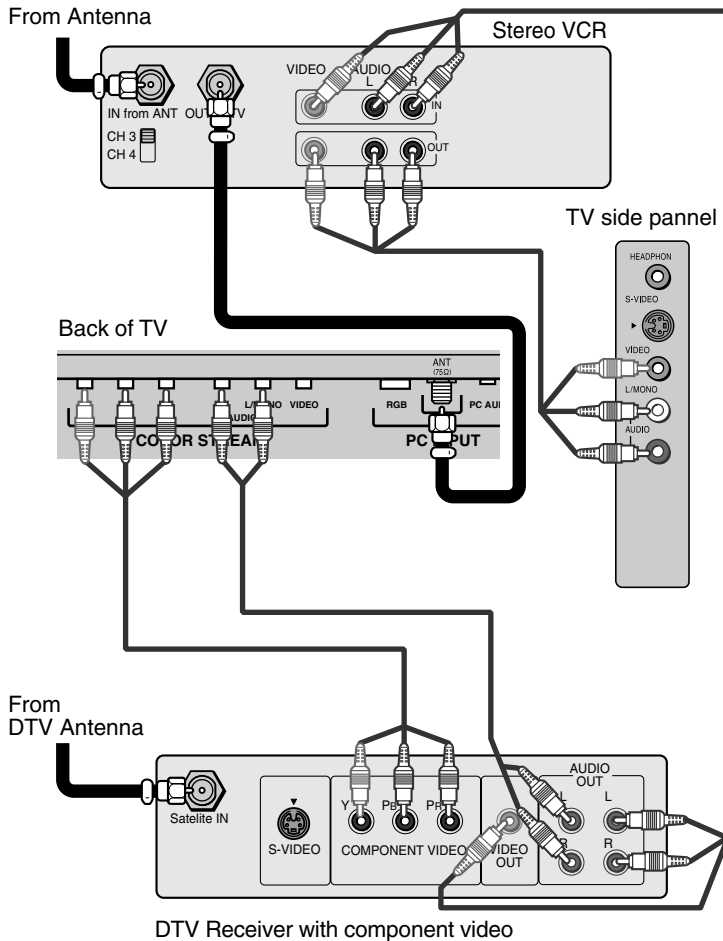

## Connecting an audio system

This connection allows you to hear the TV sound through external speakers connected to an audio amplifier. The audio signal level (fixed) is not affected by pressing the volume buttons on the TV or the TV's remote control. To control the audio through the amplifier, use the remote control for your audio system.

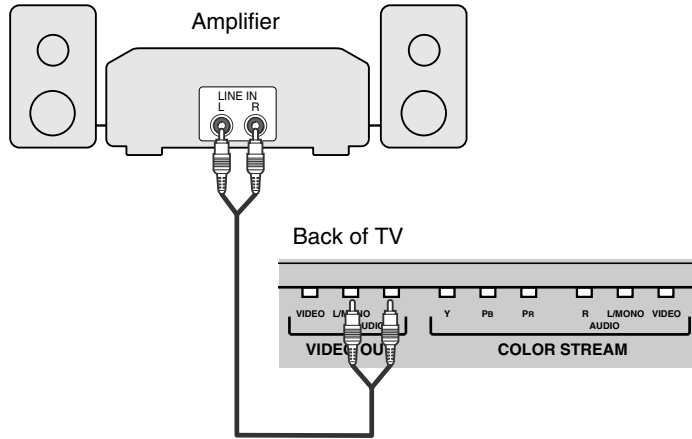

**Note:**

Set the TV's volume to the minimum level if necessary.

## Connecting a camcorder

This connection allows you to watch video materials recorded on a camcorder.

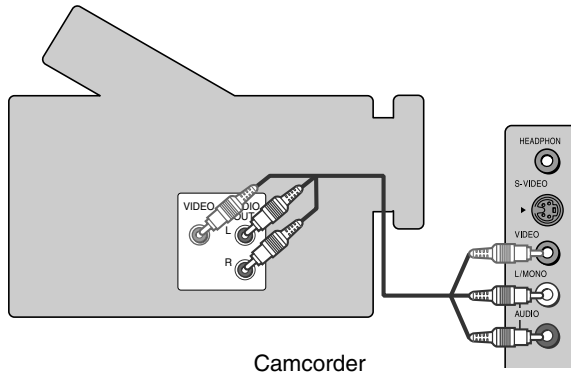

**Note:**

If you have a camcorder with S-video, use an S-video cable instead of a standard video cable for better picture performance.

Video 2 (side panel)

## Connecting a personal computer (PC)

This connection allows you to see the image of the personal computer on the TV screen. When connecting a personal computer to the TV, use an analog RGB (15pin) computer cable and an audio cable for PC.

- To use a personal computer, set the monitor output resolution on the personal computer before connecting to the TV. The following signals can be displayed.
  - VGA:VESA 640 × 480 @ 60Hz (20DL75)
  - XGA:VESA 1024 × 768 @ 60Hz (15DL75)
- Other formats may result in reduced picture quality.
- To display optimum picture, use the PC setting feature. (See “Using the PC setting feature” on page 29).

### Note:

- Some PC models cannot be connected to this TV.
- There is no need to use an adapter for computers with DOS/V compatible mini D-sub 15pin terminal.
- Depending on the specification of the PC you are playing the DVD-Video on, and the DVD's title, some scenes may be skipped, or you may not be able to pause during multi-angle scenes.

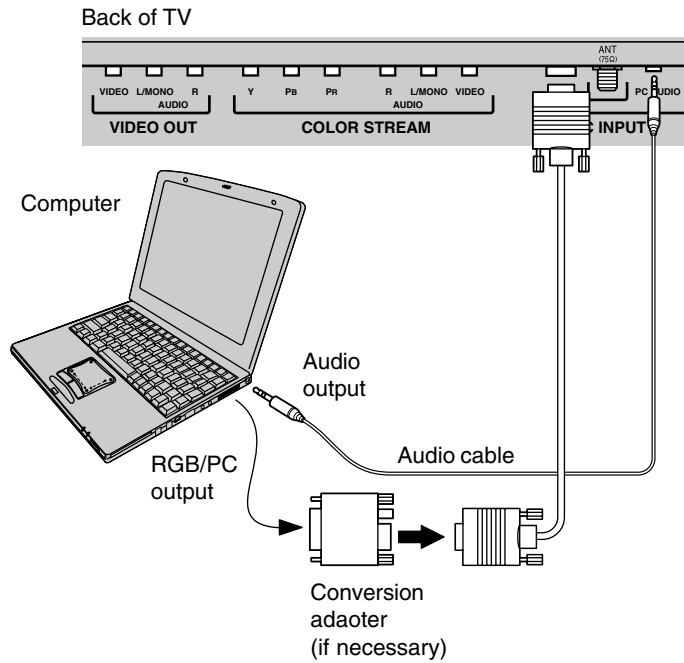

## Using the remote control

### Learning about the remote control

**POWER** turns the TV on and off (Standby)

The power indicator is illuminated in red.

**MUTE** mutes the sound (page 26)

**RECALL** displays on-screen information (page 30)

**MTS** switches Stereo or SAP sound (page 26)

**TV/VIDEO** selects the video input source (page 20)

**Channel Numbers (0-9, 100)** allow direct access to channels (page 20)

**CH RTN** returns to the last viewed channels (page 20)

**ENTER** sets programming menu information (page 17)

**▲▼ ◀▶** select or adjust programming menus (page 17)

**CH ▲▼** cycles through programmed channels (page 18)

**VOL - +** adjusts the volume level

**CC** selects the Caption or Text mode (page 24, 25)

**MENU** allows access to on-screen programming menus (page 17)

**EXIT** exits the programming menus (page 17)

**SLEEP** allows access to the automatic TV shut-off function (page 25)

**PICTURE** selects the picture mode (page 23)

**SOUND** selects the sound mode (page 28)

**FAV. CH** cycles through favorite channels (page 19)

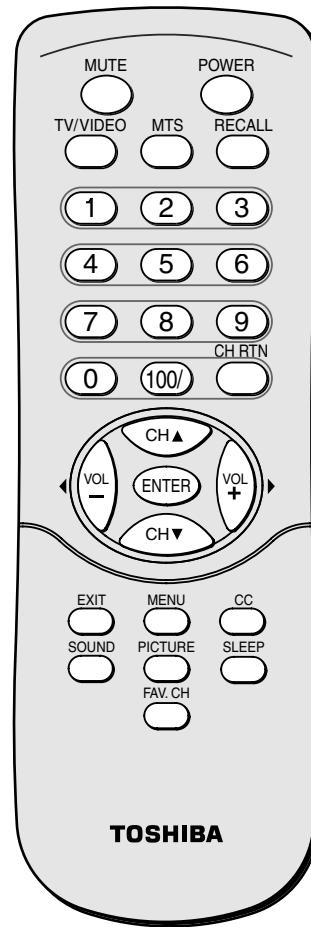

### Installing the remote control batteries

To install the batteries:

1. Open the battery cover of the back of the remote control.
2. Install two batteries (R03 size "AAA"). Match the + and – signs on the batteries to the signs on the battery compartment.

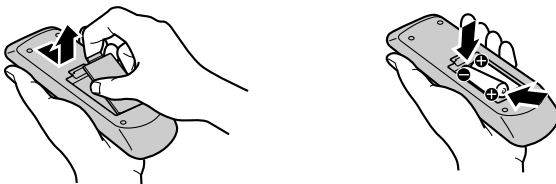

3. Close the battery cover on the remote control until the lock snaps.

### Remote control effective range

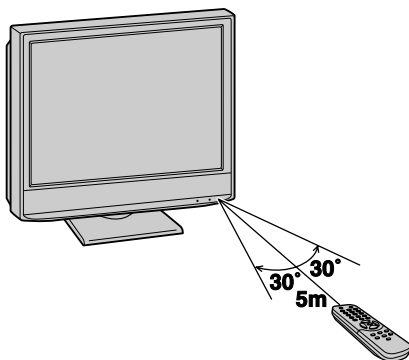

#### Caution:

Never throw batteries into a fire.

#### Note:

- Always dispose of batteries in a designated disposal location.
- Batteries should always be disposed of with the environment in mind. Always dispose of batteries in accordance with applicable laws and regulations.
- If the remote control does not operate correctly, or if the operating range becomes reduced, replace batteries with new ones.
- When necessary to replace batteries in the remote control always replace both batteries with new ones. Never mix battery types or use new and used batteries in combination.
- Always remove batteries from remote control if they are dead or if the remote control is not to be used for an extended period of time. This will prevent battery acid from leaking into the battery compartment.



# Setting up your TV

## Learning about the menu system

After you have installed the batteries, you will need to set some preferences on the TV by using the menu system. You can access the menu system using the buttons on your TV or the remote control.

1. Press MENU to display the menu system.
2. Press ◀ or ▶ to select a menu.
3. Press ▼, and then press ▲ or ▼ to select an item.
4. Press ▶, and then press ▲ or ▼ to select or adjust a setting.
5. Press ENTER to activate the channel program settings.

To return to the previous the menu, press EXIT.

To erase the menu display, press MENU.

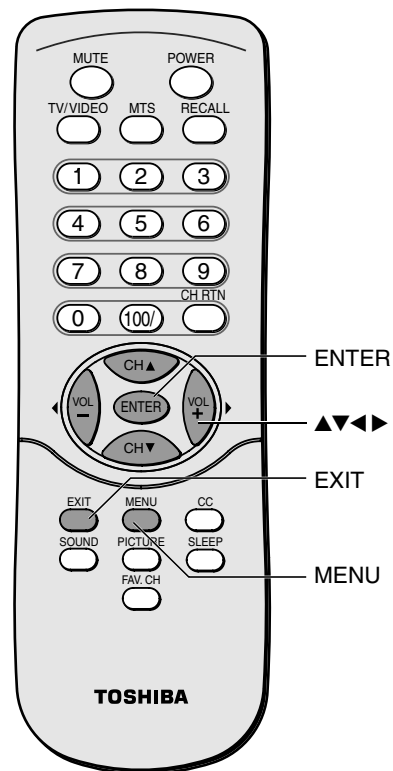
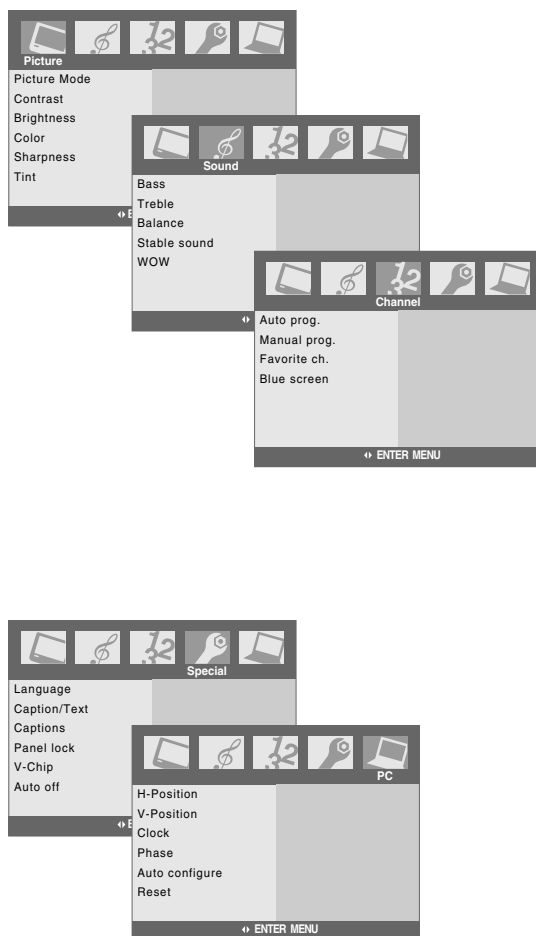

### Note:

The PC mode is selectable only when in the PC input mode (see "Selecting the video input source" on page 20).

## Changing the on-screen display language

You can choose from three different languages (English, French and Spanish) for the on-screen display of adjustment menus and messages.

To select a language:

1. Press MENU, and then press ◀ or ▶ until the Special menu appears.
2. Press ▼, and then press ▲ or ▼ to highlight Language.
3. Press ▶, and then press ▲ or ▼ to select your desired language.

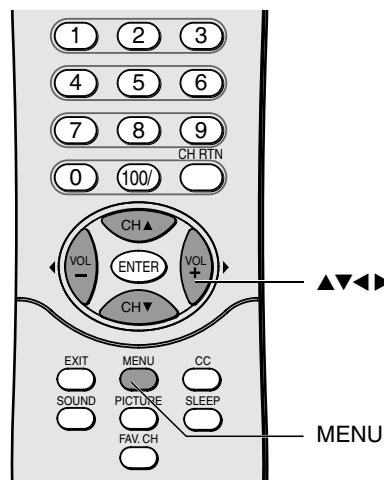

## Adding channels to the TV's memory

When you press CH ▲ or CH ▼, your TV will stop only on the channels you program into the TV's channel memory.

Follow the steps below and on the next page to program all active channels into the TV's memory.

### Programming channels automatically

Your TV can automatically detect all active channels in your area and store them into its memory. After the channels are programmed automatically, you can manually add or erase individual channels (see page 19).

To program channels automatically:

1. Press MENU, and then press ◀ or ▶ until the channel menu appears.
2. Press ▼, and then press ▲ or ▼ to highlight Auto prog.



3. Press ENTER to start auto programming. The TV will automatically cycle through all the TV and Cable channels, and store all active channels in the channel memory.



4. Press CH ▲ or CH ▼ to view the programmed channels.

### Note:

- To tune the TV to a channel not programmed in the channel memory, you must use the Channel Number buttons on the remote control.
- If you press the ENTER button in auto programming, the function will stop and only channels programmed up to that time will remain.

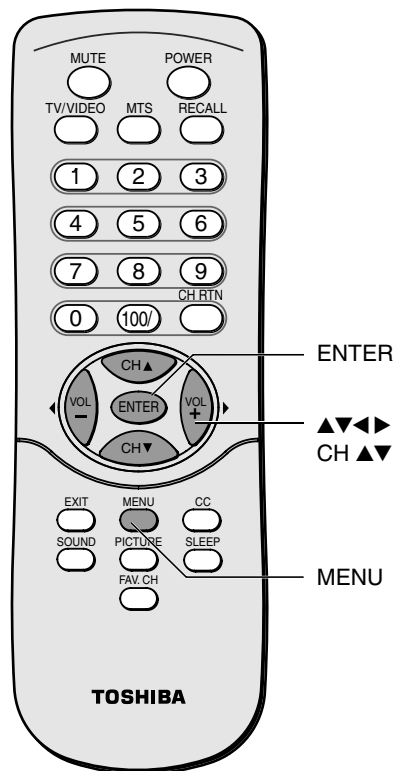

## Adding and erasing channels manually

After you have automatically programmed the active channels into the TV's channel memory, you can manually add or erase specific channels.

To add or erase channels:

1. Press MENU, and then press ◀ or ▶ until the channel menu appears.
2. Press ▼, and then press ▲ or ▼ to highlight Manual prog.
3. Press ▶, and then press ◀ or ▶ to select a channel you want to add or erase.



4. Press ▼, and then press ◀ or ▶ to select Memory (add) or Erase. The current channel is added to Memory or erased from the channel list.

## Changing channels

To change to a specific channel (programmed or unprogrammed):

Press the Channel Number buttons (0–9 and 100).

For channels 100 and higher, press the 100 button, and then the next two numbers. For example, to select channel 125, press 100, 2, 5.

To change to the next programmed channel:

Press CH ▲ or CH ▼ on the TV or remote control.

## Programming your favorite channels

You can preset up to 8 of your favorite channels using the Favorite Channel Programming feature. Because this feature scans through only your favorite channels, it allows you to skip other channels you do not normally watch.

To program your favorite channels:

1. Press MENU, and then press ◀ or ▶ until the Channel menu appears.
2. Press ▼, and then press ▲ or ▼ to highlight Favorite ch..
3. Press ENTER to display the Favorite ch. menu.



4. Press ▲ or ▼ to select the first favorite channel position.
5. Press ◀ or ▶ to set the desired channel number for first favorite channel.
6. Repeat steps 4 to 5 to program other channels.

To select your favorite channels:

Press FAV. CH repeatedly.

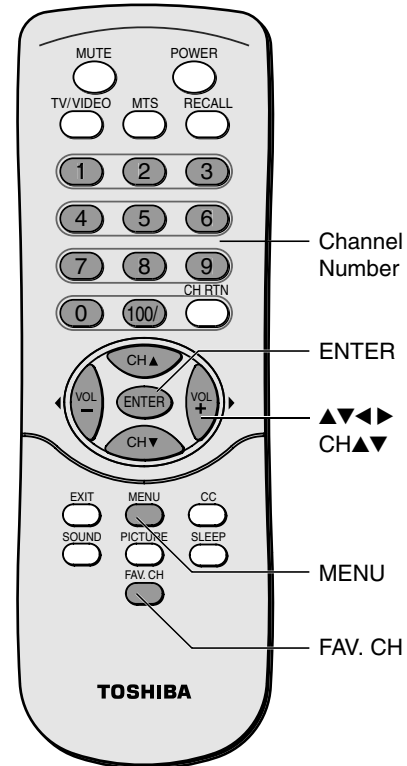
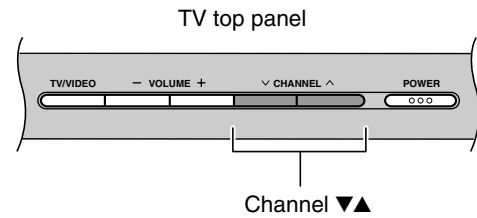

## Using the TV's features

### Switching between two channels using Channel Return

The Channel Return feature allows you to switch between two channels without entering an actual channel number each time.

To switch between two channels:

1. Select the first channel (or video mode) you want to view.
2. Select a second channel using the Channel Number buttons (0–9, 100).
3. Press CH RTN. The previous channel will be displayed.

Each time you press CH RTN, the TV will switch back and forth between the last two channels that were selected.

### Using the Blue screen feature

With the Blue screen function On, the screen will automatically turn blue and the sound will be muted when no signal is received.

To turn on the Blue screen:

1. Press MENU, and then press ◀ or ▶ until the Channel menu appears.
2. Press ▼, and then press ▲ or ▼ to highlight Blue screen.
3. Press ▶, and then press ▲ or ▼ to select On.

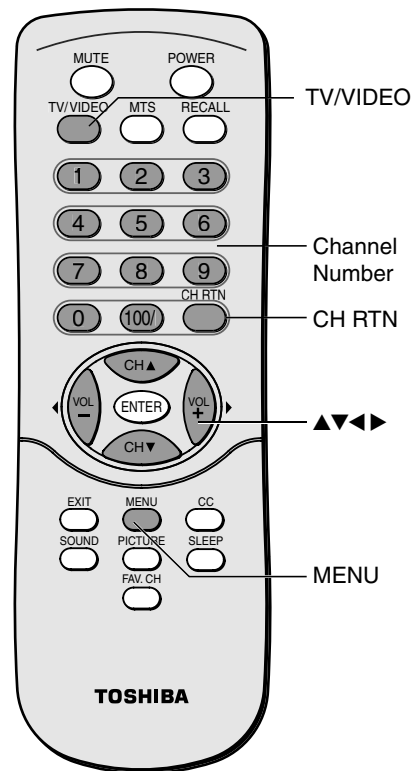
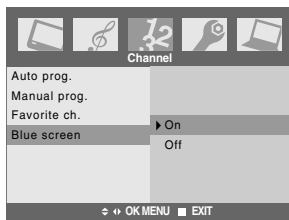

#### Note:

If the Blue screen comes on and off due to poor signal strength, select Off in step 3.

### Selecting the video input source

Press TV/VIDEO to view a signal from another device connected to your TV, such as a VCR or DVD player. You can select Video1 (including ColorStream), Video2, or PC depending on which input jacks are used for connecting the devices (see "Connecting your TV" on page 10).

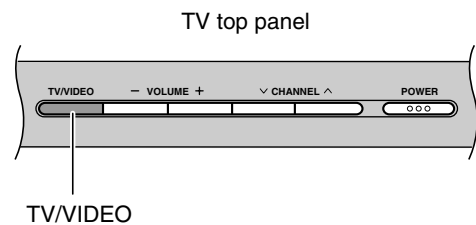
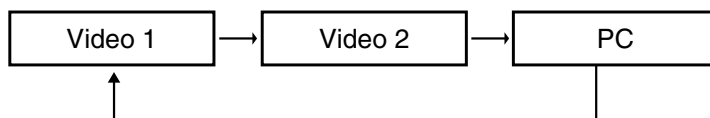

## Using the V-Chip menu

Some TV programs and movies include signals that classify the content of the program (violence, sex, dialog, language). The V-Chip control feature in this TV detects the signals and blocks the programs according to your selections. To use this feature, perform the following setup.

1. Ratings and categories to be blocked.
2. Set a password
3. Enable the lock

### V-Chip rating and categories

Rating guidelines are provided by broadcast stations. Most television programs and television movies can be blocked by TV Rating and/or Individual Categories. Movies that have been shown at the theaters or direct-to-video movies use the Movie Rating System (MPAA) only.

#### For Movies previously shown in theaters :

##### Movie Ratings :

- Unblocked
- G and Above (general audience)
- PG and Above (parental guidance suggested)
- PG-13 and Above (13 years and older)
- R and above (restricted)
- NC-17 and Above (18 years and older)
- X (adult)

If you set PG-13 and Above : G and PG movies will be available , PG-13, R, NC-17 and X will be blocked.

#### For Television programs including made-for-TV movies:

##### General TV Ratings:

- Unblocked
- TV-G and Above (general audience) (individual categories do not apply)
- TV-PG and Above (parental guidance suggested)
- TV-14 and Above (14 years and older)
- TV-MA (mature audience)

##### Children TV Ratings:

- Unblocked
- TV-Y and Above (youth)  
(individual content categories do not apply)
- TV-Y7 (youth, 7 years and up)

##### Content Categories:

- Dialog - sexual dialogue (applies to TV-PG and Above, TV-14)
- Language - adult language (applies to TV-PG and Above, TV-14 and Above, TV-MA)
- Sex scenes - sexual situations (applies to TV-PG and Above, TV-14 and Above, TV-MA)
- Violence (applies to TV-PG and Above, TV-14 and Above, TV-MA)
- F Violence - fantasy violence (applies only to TV-Y7)
- No Rating (blocks all viewing)

#### **Note:**

*The V-Chip function is available for the U.S. V-Chip system only. The Canadian V-Chip system is not supported.*

## V-Chip ( Parental menu) setup

1. Press MENU, and then press ◀ or ▶ until the Special menu appears.
2. Press ▼, and then press ▲ or ▼ to highlight V-Chip. Press Enter.

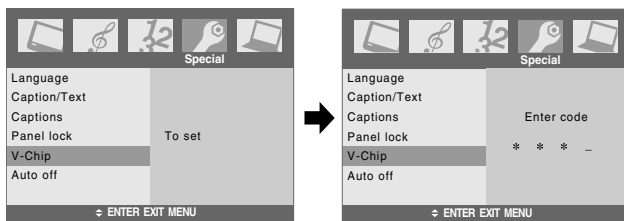

- If Lock is already set, enter the password requested.
- The TV is set with the initial password “0-0-0-0”.

3. Setting Lock on/off:

Press ▲ or ▼ to highlight Lock.  
Press ▶, and then press ▲ or ▼ to select On (Lock) or Off (Unlock).

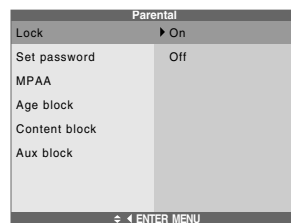

4. Set password:

Press ▲ or ▼ to highlight Set password.  
Press ▶, and then enter a four digit password.  
Enter it again when requested.

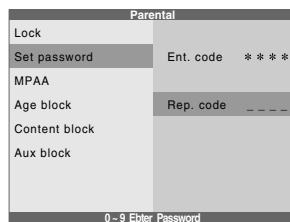

5. Press ▲ or ▼ to highlight type of blocking to be set.
6. Press ▶, and then press ▲ or ▼ to select type of ratings to block.
  - Age block and content block menus, also have sub menus. So, repeat steps 5 and 6 in the sub menu, to set the types of blocking and ratings.

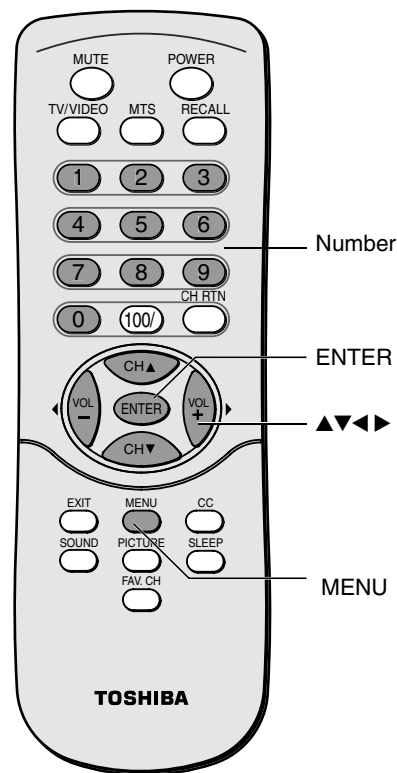
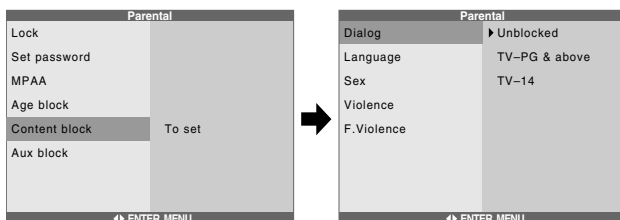
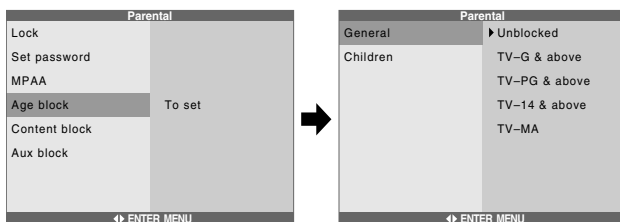

If you try to watch a TV program that exceed the rating limits you set, the TV enters program lock mode.

## Adjusting the picture

### Selecting the picture mode

You can select your desired picture type from four picture modes: Dynamic, Standard, Movie, or Memory.

Mode	Picture Quality
Dynamic	Bright and dynamic picture (factory setting)
Standard	Standard picture setting (factory setting)
Movie	Movie-like picture setting (factory setting)
Memory	Your personal preference

To select the picture mode:

Press PICTURE repeatedly to select the mode you prefer.

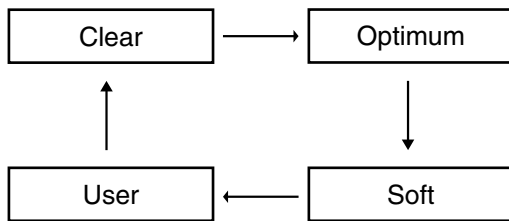

You can also select the picture mode by using the Picture menu:

1. Press MENU, and then press ◀ or ▶ until the Picture menu appears.
2. Press ▼, and then press ▼ or ▲ to highlight Picture Mode.
3. Press ▶, and then press ▼ or ▲ to select the mode you prefer.

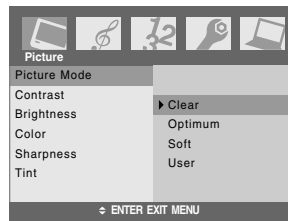

### Note:

If you select one of the factory-set picture modes (Dynamic, Standard, or Movie) and then change a picture quality setting (for example, increase the contrast), the picture mode automatically changes to Memory in the Picture menu.

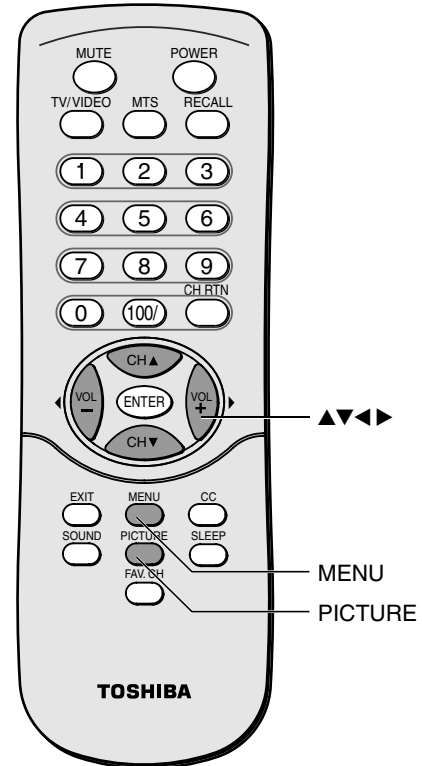

### Adjusting the picture quality

You can adjust the picture quality to your personal preferences, including the contrast, brightness, color, sharpness, and tint.

Selection	◀ Pressing	▶
contrast	lower	higher
brightness	darker	lighter
color	paler	deeper
sharpness	softer	sharper
tint	reddish	greenish

To adjust the picture quality:

1. Press MENU, and then press ◀ or ▶ until the Picture menu appears.
2. Press ▼, and then press ▲ or ▼ until the item you want to adjust is highlighted.
3. Press Enter.
4. Press ◀ or ▶ to adjust the level.

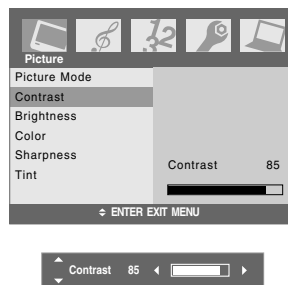

### Note:

If you continue to adjust the other item, press ▲ or ▼ in step 4.

The Picture qualities you adjusted can be saved in the TV's memory.

## Using the closed caption feature

The closed caption feature has two options:

- Captions—An on-screen display of the dialogue, narration, and sound effects of TV programs and videos that are closed captioned (usually marked as “CC” in TV listings).
- Text—An on-screen display of information not related to the current program, such as weather or stock data (when provided by individual stations).

To select captions or text:

1. Tune the TV to the desired program.
2. Press MENU, and then press ◀ or ▶ to display Special menu.
3. Press ▼, and then press ▲ or ▼ to highlight Caption/Text.

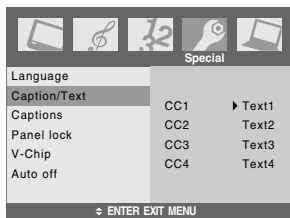

4. Press ▶, and then press ▲ or ▼ to select desired Caption or Text mode.

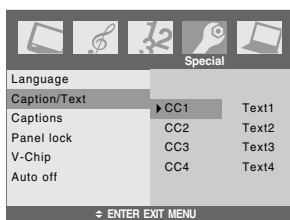

- To view captions, select CC1, CC2, CC3, or CC4 (CC1 displays translation of the primary language in your area).

**Note:** If the program or video you selected is not closed captioned, no captions will display on the screen.



- To view text, select Text1, Text2, Text3, or Text4.

**Note:** If text is not available in your area, a black rectangle may appear on your screen. If this happens, turn the Closed Caption feature Off.

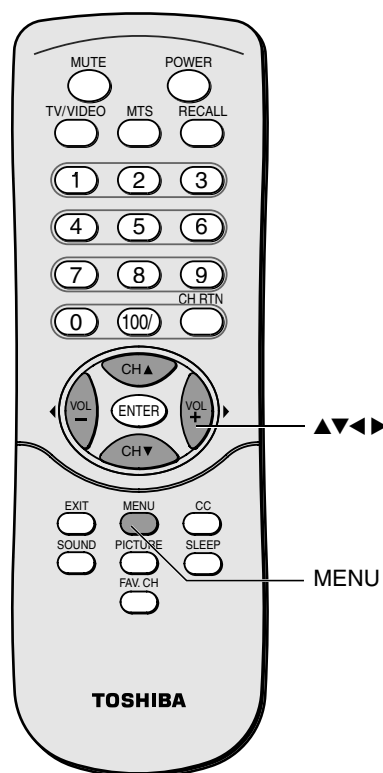
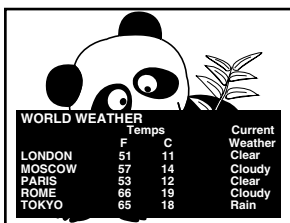

### Note:

A closed caption signal may not display in the following situations:

- When a videotape has been dubbed
- When the signal reception is weak
- When the signal reception is nonstandard



## To turn on or off the Closed Caption feature

1. Press MENU, and then press ◀ or ▶ to display the Special menu.
2. Press ▼, and then press ▲ or ▼ to highlight Captions.
3. Press ▶, and then press ▲ or ▼ to select On, EZ Mute or Off.
  - EZ Mute shows the selected Caption or Text when the TV sound is muted.

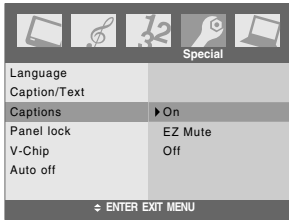

The CC button on the remote control can also be used to select On, EZ Mute or Off mode.

## Using the Panel lock feature

You can lock the control buttons on the TV to prevent your settings from being changed accidentally (by children, for example).

When the Panel lock is On, no control buttons on the TV top panel will operate.

To lock the top panel:

1. Press MENU, and then press ◀ or ▶ to display the Special menu.
2. Press ▼, and then press ▲ or ▼ to highlight Panel lock.
3. Press ▶, and then press ▲ or ▼ to select On.

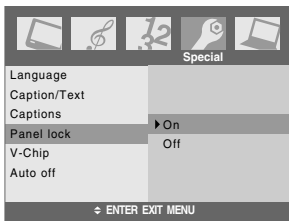

To unlock the top panel:  
Select Off in step 3 above.

## Setting the sleep timer

To set the sleep timer to turn off the TV automatically:

1. Press SLEEP to set the length of time until the TV turns off.

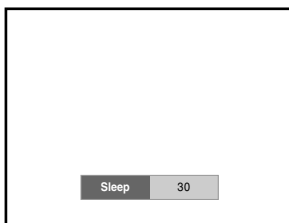

Every time you press the button, the time display will increase by 30 minutes, up to 120 minutes.

30 → 60 → 90 → 120 → ---

To cancel the sleep timer:

Press SLEEP until “Sleep ---” appears.

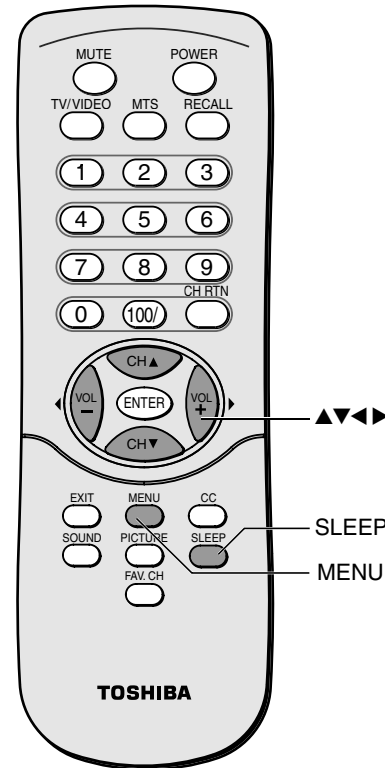
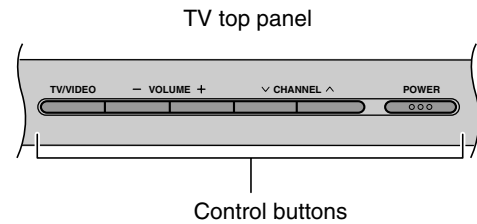
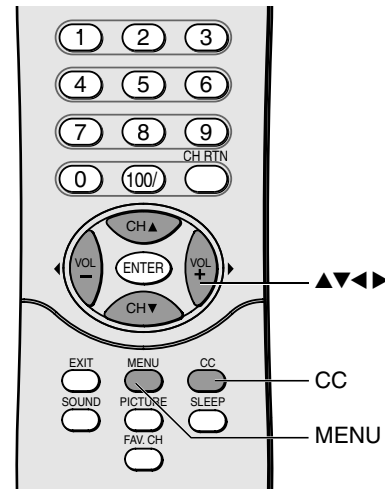

### Note :

- When an instant power failure occurs, the sleep timer settings may be cleared.
- To display the amount of time left until the TV turns off automatically, press SLEEP.

## Adjusting the sound

### Muting the sound

Press MUTE to temporarily turn off the sound. While the sound is off, the screen will display “Mute” in the lower left corner.

When you select “MUTE” mode, the closed caption feature is automatically activated. To deactivate this feature, deactivate MUTE. This feature works only when the closed caption mode is set to EZ Mute. See “Using the closed caption feature” on page 24 for more information.

### Selecting stereo/SAP broadcasts

The multi-channel TV sound (MTS) feature allows you to listen to high-fidelity stereo sound while watching TV. MTS can also transmit a second audio program (SAP) containing a second language, music, or other audio information (when provided by individual stations).

When the TV receives a stereo or SAP broadcast, the word “Stereo” or “SAP” appears on-screen every time the TV is turned on, the channel is changed, or the RECALL button is pressed.

The MTS feature is not available when the TV is in Video mode.

To listen to stereo sound:

Press MTS repeatedly to select Stereo.



You can leave your TV in Stereo mode because it will automatically output the type of sound being broadcast (stereo or monaural).

If the stereo sound is noisy, select Mono to reduce the noise.

To listen to SAP (if available):

Press MTS repeatedly to select SAP.



You will hear the station’s second audio program (if available) from the speakers, while viewing the original program’s picture.

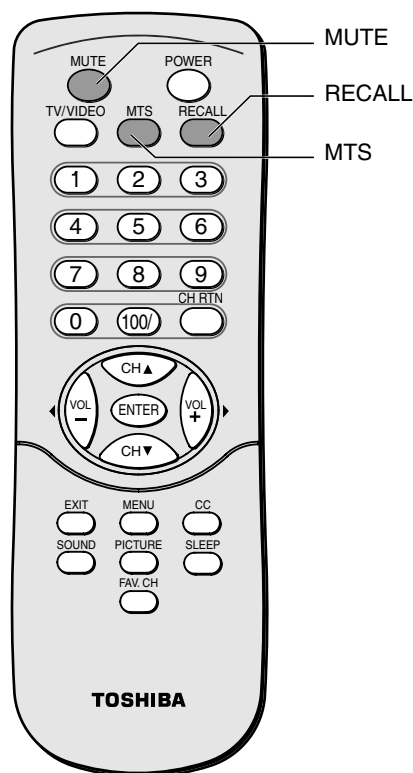

## Using the WOW™ surround sound feature

WOW surround widens and deepens audio listening field to deliver exceptional sound from the TV's speakers. The feature uses stereo signals from a TV broadcast or video input.

To activate the WOW feature:

1. Select Stereo mode (see "Selecting stereo/SAP broadcasts" on page 26).
2. Press MENU, and then press ◀ or ▶ until the Sound menu appears.
3. Press ▼, and then press ▲ or ▼ to highlight Audio Mode.
4. Press ▶, and then press ▲ or ▼ to select WOW.

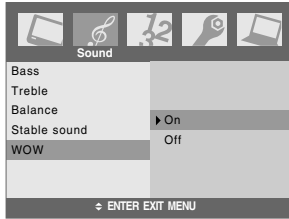

## Selecting the audio mode

This function lets you enjoy the best sound without special adjustment because the TV selects the appropriate sound option based on the program content.

Press SOUND repeatedly to select the appropriate sound mode as shown:



Mode	Sound Quality
WOW	see above
Flat	flat sound ( factory setting )
Hall	a concert hall filled with a rich warm sound ( factory setting )
Theater	a movie theater filled with a dynamic sound ( factory setting )
News	news/dialogue ( factory setting )
Memory	your personal preference

### Note:

If the broadcast is monaural, the WOW sound effect will not work.

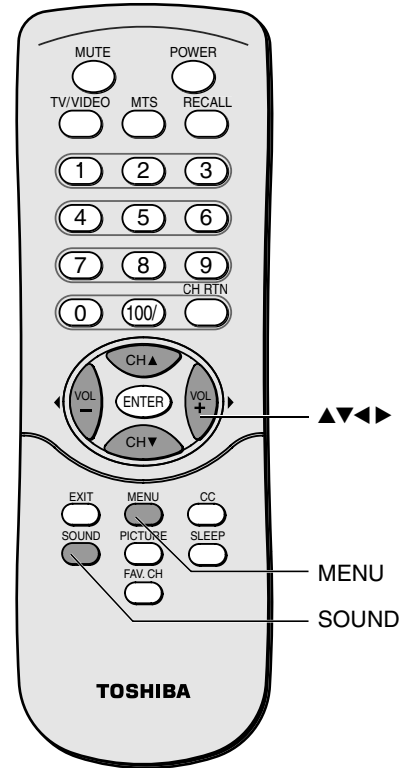

### Note:

If you select one of the factory-set audio modes ( WOW, Flat, Hall, Theater, or News ) ,and then change a sound quality setting ( for example, increase the bass ), the audio mode automatically change to Memory mode.

## Adjusting the sound quality

You can change the quality of your TV's sound by adjusting the bass, treble, and balance.

To adjust the sound quality:

1. Press MENU, and then press ◀ or ▶ until the Sound menu appears.
2. Press ▼, and then press ▲ or ▼ to highlight the item you want to adjust.

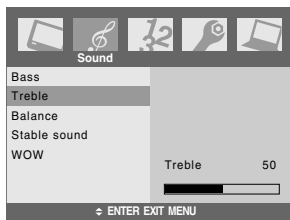

3. Press Enter.
4. Press ◀ or ▶ to adjust the level.



- ◀ makes the sound quality weaker or increases the balance in the left channel, depending on the item selected.
- ▶ makes the sound quality stronger or increases the balance in the right channel, depending on the item selected.

## Using the StableSound® feature

When the signal source is changed, the StableSound feature limits the highest volume level to prevent extreme changes in volume (for example, to prevent the sudden increase in volume that often happens when a TV program switches to a commercial).

To turn on the StableSound feature:

1. Press MENU, and then press ◀ or ▶ until the Sound menu appears.
2. Press ▼, and then press ▲ or ▼ to highlight Stable sound.
3. Press ▶, and then press ▲ or ▼ to Select On.

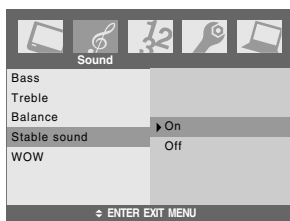

To turn off the StableSound feature:  
Select Off in step 3 above.

### Note:

If you continue to adjust the other item, press ▲ or ▼ in step 4.

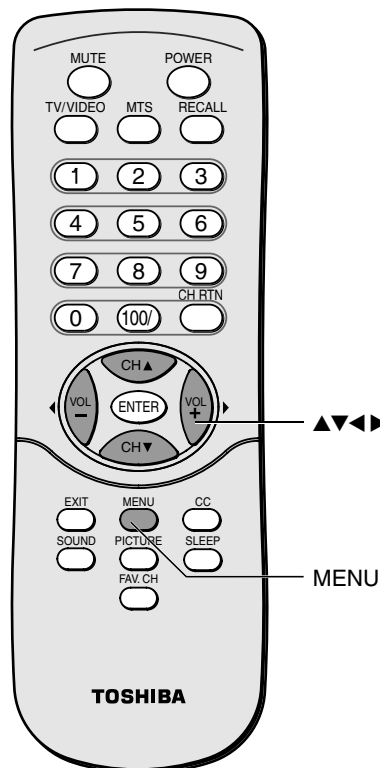

## Using the PC setting feature

You can adjust picture position, clock, phase, Auto configure, and reset as you prefer.

1. Press TV/VIDEO repeatedly to select PC input mode. (See “Selecting the video input source” in page 20.)
2. Press MENU, and then press ◀ or ▶ until the PC menu appears.
3. Press ▼, and then press ▲ or ▼ to select required item.

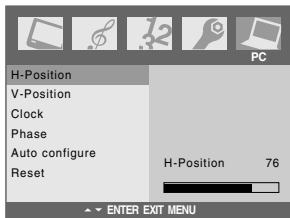

4. Press Enter.
5. Press ◀ or ▶ to make appropriate adjustments.
  - H-position/V-position  
Adjusts picture left/right and up/down. The adjustment ranges of H-Position is 0–100. (Based on the input mode, the adjustable range may change.)
  - Clock  
Minimizes any vertical bars or stripes appearing on the screen background. The adjustment ranges is 0–100. (Based on the input mode, the adjustable range may change.)
  - Phase  
Reduces (or Minimizes) any horizontal noise and clear up or sharpen the character images. The range adjustment is 0–100. (Based on the input mode, the adjustable range may change.)
  - Auto configure  
Automatically adjusts the screen position, clock, and clock phase. (The displayed image will disappear for a few seconds while Auto-configuration is in progress.)
  - Reset  
Returns to the default settings programmed at the factory; default settings cannot be changed.
6. Press ENTER to save.

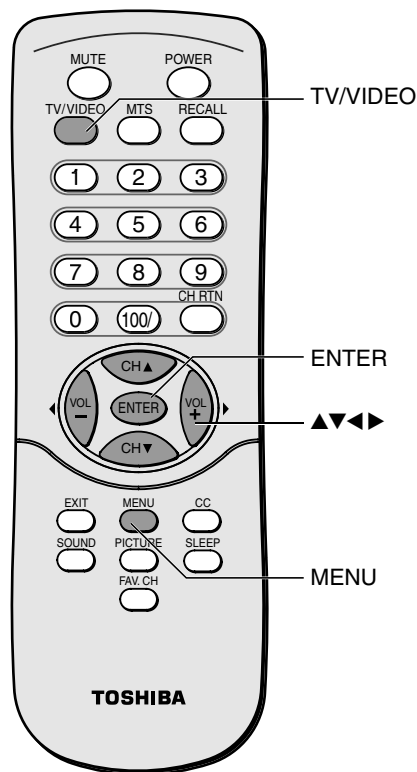
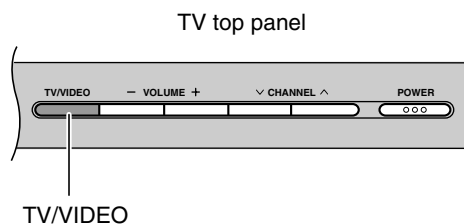

## Using the Auto off feature

With the Auto off feature On, the TV will automatically turn itself off after approximately 15 minutes if it is tuned to a vacant channel or a station that completes its broadcast for the day. This feature does not work in the blue screen off mode.

To activate the Auto off:

1. Press MENU, and then press ◀ or ▶ until the Special menu appears.
2. Press ▼, and then press ▲ or ▼ to highlight Auto off.
3. Press ▶, and then press ▲ or ▼ to Select On.

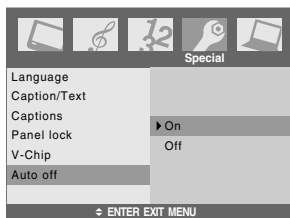

To deactivate the Auto off:  
Select Off in step 3 above.

## Displaying on-screen information

Press RECALL to display the following information on-screen:

- Channel number or Video mode selected
- Stereo or SAP audio status

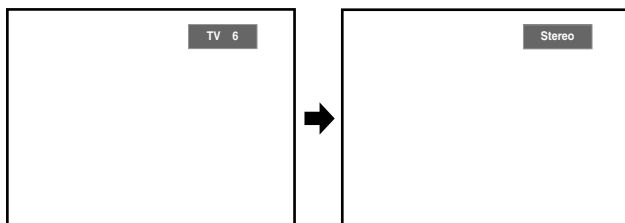

## Understanding the last mode memory feature

If the power is cut off while you are viewing the TV, the Last Mode Memory feature turns on the TV automatically when the power is resupplied.

If the power is going to be off for a long time and you are going to be away from your TV, unplug the power cord to prevent the TV from turning on in your absence.

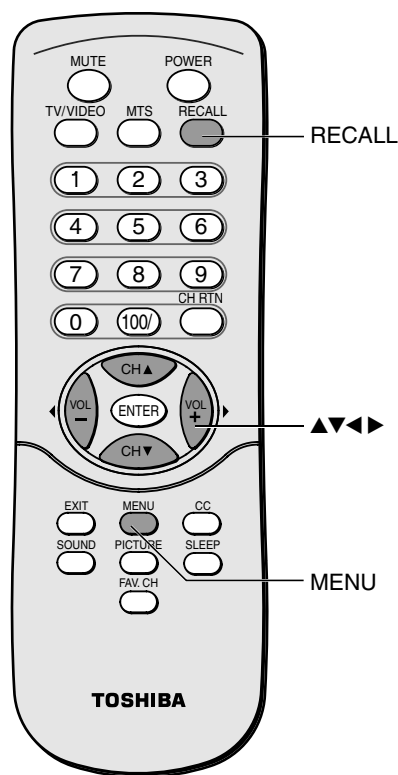

# Appendix

## Specifications

- This model complies with the specifications listed below.
- Designs and specifications are subject to change without notice.



**WARNING: RISK OF ELECTRIC SHOCK !**

**Never attempt to service the TV yourself. Opening and removing the covers may expose you to dangerous voltage or other hazards. Refer all servicing to a Toshiba Authorized Service Center.**

Television System	15DL75: Width : XX-X/X inches (XXX mm)
NTSC standard	Height : XX-XX/XX inches (XXX mm)
	Depth : XX-XX/XX inches (XXX mm)
Channel Coverage	20DL75: Width : XX-X/X inches (XXX mm)
VHF: 2 through 13	Height : XX-XX/XX inches (XXX mm)
UHF: 14 through 69	Depth : XX-XX/XX inches (XXX mm)
Cable TV: Mid band (A-8 through A-1, A through I)	
Super band (J through W)	Mass (weight)
Hyper band (AA through ZZ, AAA, BBB)	15DL75: XX.X lbs (XX.X kg)
Ultra band (65 through 94, 100 through 125)	20DL75: XX.X lbs (XX.X kg)
Power Source	Operating condition
120 V AC, 60 Hz	Temperature: 32°F – 95°F (0°C – 35°C)
	Humidity: 20 – 80% (no moisture condensation)
Power Consumption	
XXX W (average)	
1.0 W below in standby mode	
Audio Power	
5 W + 5 W	
Speaker Type	
Two X-X/X × X-X/X inches (XX × XXX mm)	
Video/Audio Terminals	
S-VIDEO INPUT	
Y : 1 V(p-p), 75 ohms, negative sync.	
C : 0.286 V(p-p) (burst signal), 75 ohms	
VIDEO/AUDIO INPUT	
VIDEO: 1 V(p-p), 75 ohms, negative sync.	
AUDIO: 150 mV(rms) (30% modulation equivalent, 22k ohms or greater)	
ColorStream® (Component video) INPUT	
Y : 1V(p-p), 75 ohms	
PR: 0.7 V(p-p), 75 ohms	
PB: 0.7 V(p-p), 75 ohms	
AUDIO: 150 mV(rms), 22k ohms or greater	
AUDIO OUTPUT	
150 mV(rms) (30% modulation equivalent, 2.2k ohms or less)	
HEADPHONE jack	
3.5 mm stereo	
PC INPUT	
15-pin D-sub Analog RGB	
PC AUDIO INPUT	
3.5 mm stereo mini jack	
Dimensions (Including TV stand)	

## Troubleshooting

Before calling a service technician, please check the following table for a possible cause of the symptom and some solutions.

<b>Symptom</b>	<b>Solution</b>
TV will not turn on	<ul style="list-style-type: none"><li>• Make sure the power cord is plugged in, then press POWER.</li><li>• Make sure the appropriate device mode on the remote control is selected.</li><li>• The remote control batteries may be dead. Replace the batteries.</li></ul>
No picture, no sound	<ul style="list-style-type: none"><li>• Check the antenna/cable connections.</li></ul>
No sound, picture OK	<ul style="list-style-type: none"><li>• The sound may be muted. Press VOLUME.</li><li>• The station may have broadcast difficulties. Try another channel.</li></ul>
Poor picture, sound OK	<ul style="list-style-type: none"><li>• Check the antenna connections.</li><li>• The station may have broadcast difficulties. Try another channel.</li><li>• Adjust the Picture menu.</li></ul>
Poor reception of broadcast channels	<ul style="list-style-type: none"><li>• The station may have broadcast difficulties. Try another channel.</li><li>• Check the antenna connections.</li></ul>
Black box appears on the screen	<ul style="list-style-type: none"><li>• The closed caption feature may be set to one of the Text modes (Text1, Text2, Text3, or Text4). Turn closed captioning Off.</li></ul>
Unable to select a certain channel	<ul style="list-style-type: none"><li>• The channel may be erased with the Manual programming feature.</li></ul>
Multiple images	<ul style="list-style-type: none"><li>• The station may have broadcast difficulties. Try another channel.</li><li>• Antenna reception may be poor. Use a highly directional outdoor antenna.</li></ul>
Poor color or no color	<ul style="list-style-type: none"><li>• The station may have broadcast difficulties. Try another channel.</li><li>• Adjust the Tint and/or Color in the Picture menu.</li></ul>
No stereo or SAP sound from a known MTS broadcast	<ul style="list-style-type: none"><li>• Make sure the MTS feature is set properly.</li></ul>
The top panel buttons do not operate	<ul style="list-style-type: none"><li>• Check the Panel lock feature.</li></ul>
The remote control does not operate	<ul style="list-style-type: none"><li>• Make sure the appropriate device mode is selected.</li><li>• Remove all obstructions between the remote control and the remote control sensor in the TV.</li><li>• The remote control batteries may be dead. Replace the batteries.</li></ul>



# Limited United States Warranty for LCD TV

## LCD Television Models Smaller than 26"

Toshiba America Consumer Products, L.L.C. ("TACP") makes the following limited warranties to original consumers in the United States. THESE LIMITED WARRANTIES EXTEND TO THE ORIGINAL CONSUMER PURCHASER OR ANY PERSON RECEIVING THIS LCD TV AS A GIFT FROM THE ORIGINAL CONSUMER PURCHASER AND TO NO OTHER PURCHASER OR TRANSFEREE.

PRODUCTS PURCHASED IN THE U.S.A. AND USED IN CANADA ARE NOT COVERED BY THESE WARRANTIES.

PRODUCTS PURCHASED IN CANADA AND USED IN THE U.S.A. ARE NOT COVERED BY THESE WARRANTIES.

### Limited One (1)Year Warranty on Parts and Labor\*

TACP warrants this LCD TV and its parts against defects in materials or workmanship for a period of one (1) year after the date of original retail purchase. DURING THIS PERIOD, TACP WILL, AT TACP'S OPTION, REPAIR OR REPLACE A DEFECTIVE PART WITH A NEW OR REFURBISHED PART WITHOUT CHARGE TO YOU FOR PARTS OR LABOR. YOU MUST DELIVER THE ENTIRE TELEVISION TO AN AUTHORIZED TACP SERVICE STATION. YOU MUST PAY FOR ALL TRANSPORTATION AND INSURANCE CHARGES FOR THE TELEVISION TO AND FROM THE SERVICE STATION.

### Rental Units

The warranty for rental units begins with the date of first rental or thirty (30) days from the date of shipment to the rental firm, whichever comes first.

### \*Commercial Units

LCD TVs sold and used for commercial purposes have a limited ninety (90) day warranty for all parts and labor.

### Owner's Manual and Product Registration Card

Read this owner's manual thoroughly before operating this LCD TV. If you purchased your LCD TV in the U.S.A. or Puerto Rico, complete and mail the enclosed product registration card, or register your product online at [www.tacp.toshiba.com/service](http://www.tacp.toshiba.com/service) as soon as possible. By registering your product you will enable TACP to bring you new products specifically designed to meet your needs and help us contact you in the unlikely event a safety notification is required under the Consumer Product Safety Act. **Failure to complete and return the product registration card or to register online does not diminish your warranty rights.**

### Your Responsibility

THE ABOVE WARRANTIES ARE SUBJECT TO THE FOLLOWING CONDITIONS:

- (1) You must provide your bill of sale or other proof of purchase.
- (2) All warranty servicing of this LCD TV must be made by an Authorized TACP Service Station.
- (3) The warranties from TACP are effective only if the LCD TV is purchased and operated in the U.S.A. or Puerto Rico.
- (4) Labor charges for installation, setup, adjustment of customer controls, and installation or repair of antenna systems are not covered by these warranties. Reception problems caused by inadequate antenna systems are your responsibility.
- (5) Warranties extend only to defects in materials or workmanship as limited above, and do not extend to any LCD TV or parts that have been lost or discarded by you or to damage to the LCD TV or parts caused by fires, misuse, accident, Acts of God (such as lightning or fluctuations in electric power), improper installation, improper maintenance, use in violation of instructions furnished by TACP, or misuse or to use or malfunction through simultaneous use of this product and connected equipment; units that have been modified or had the serial number removed, altered, defaced, or rendered illegible.

### How to Obtain Warranty Services

If, after following all of the operating instructions in this manual and checking the "Troubleshooting" section, you find that service is needed:

- (1) To find the nearest TACP Authorized Service Station, visit TACP's web site at [www.toshiba.com/tacp](http://www.toshiba.com/tacp) or call toll free 1-800-631-3811.
- (2) Present your bill of sale or other proof of purchase to the Authorized Service Station. You must deliver the entire television to an Authorized TACP Service Station. You must pay for all transportation and insurance charges for the television to and from the Service Station.

**For additional information, visit TACP's web site:  
[www.toshiba.com/tacp](http://www.toshiba.com/tacp)**

ALL WARRANTIES IMPLIED BY THE LAW OF ANY STATE OF THE U.S.A., INCLUDING THE IMPLIED WARRANTIES OF MERCHANTABILITY AND FITNESS FOR A PARTICULAR PURPOSE, ARE EXPRESSLY LIMITED TO THE DURATION OF THE LIMITED WARRANTIES SET FORTH ABOVE. WITH THE EXCEPTION OF ANY WARRANTIES IMPLIED BY THE LAW OF ANY STATE OF THE U.S.A. AS HEREBY LIMITED, THE FOREGOING WARRANTY IS EXCLUSIVE AND IN LIEU OF ALL OTHER WARRANTIES, GUARANTEES, AGREEMENTS, AND SIMILAR OBLIGATIONS OF TACP WITH RESPECT TO THE REPAIR OR REPLACEMENT OF ANY PARTS. IN NO EVENT SHALL TACP BE LIABLE FOR CONSEQUENTIAL OR INCIDENTAL DAMAGES (INCLUDING, BUT NOT LIMITED TO, LOST PROFITS, BUSINESS INTERRUPTION, OR MODIFICATION OR ERASURE OF RECORDED DATA) CAUSED BY USE, MISUSE OR INABILITY TO USE THIS PRODUCT.

No person, agent, distributor, dealer, or company is authorized to change, modify, or extend the terms of these warranties in any manner whatsoever. The time within which action must be commenced to enforce any obligation of TACP arising under this warranty or under any law of the United States or of any state thereof is hereby limited to 90 days from the date you discover, or should have discovered, the defect. This limitation does not apply to implied warranties arising under the law of any state of the U.S.A.

THIS WARRANTY GIVES YOU SPECIFIC LEGAL RIGHTS, AND YOU MAY ALSO HAVE OTHER RIGHTS, WHICH MAY VARY FROM STATE TO STATE IN THE U.S.A. SOME STATES OF THE U.S.A. DO NOT ALLOW LIMITATIONS ON THE DURATION OF AN IMPLIED WARRANTY, LIMITATIONS ON THE TIME WITHIN WHICH AN ACTION MAY BE BROUGHT, OR THE EXCLUSION OR LIMITATION OF INCIDENTAL OR CONSEQUENTIAL DAMAGES; THEREFORE, THE ABOVE LIMITATIONS OR EXCLUSIONS MAY NOT APPLY TO YOU UNDER SUCH CIRCUMSTANCES.

04/04

# Limited Canada Warranty for LCD TV

Toshiba of Canada Limited ("TCL") makes the following limited warranties to original consumers in Canada.

THESE LIMITED WARRANTIES EXTEND TO THE ORIGINAL CONSUMER PURCHASER OR ANY PERSON RECEIVING THIS LCD TV AS A GIFT FROM THE ORIGINAL CONSUMER PURCHASER AND TO NO OTHER PURCHASER OR TRANSFEREE.

PRODUCTS PURCHASED IN THE U.S.A. AND USED IN CANADA ARE NOT COVERED BY THESE WARRANTIES.

PRODUCTS PURCHASED IN CANADA AND USED IN THE U.S.A. ARE NOT COVERED BY THESE WARRANTIES.

## Limited One (1) Year Warranty on Labor\*

TCL warrants this LCD TV and its parts against defects in materials or workmanship for a period of one (1) year after the date of original retail purchase. DURING THIS PERIOD, TCL WILL, AT TCL'S OPTION, REPAIR OR REPLACE A DEFECTIVE PART WITH A NEW OR REFURBISHED PART WITHOUT CHARGE TO YOU FOR PARTS OR LABOR. YOU MUST DELIVER THE ENTIRE LCD TELEVISION TO AN AUTHORIZED TCL SERVICE DEPOT. YOU MUST PAY FOR ALL TRANSPORTATION AND INSURANCE CHARGES FOR THE LCD TELEVISION TO AND FROM THE SERVICE DEPOT.

## Limited One (1) Year Warranty on Parts\*

TCL further warrants the parts in this LCD TV against defects in materials or workmanship for a period of one (1) year after the date of original retail purchase. DURING THIS PERIOD, TCL WILL, AT TCL'S OPTION, REPAIR OR REPLACE A DEFECTIVE PART WITH A NEW OR REFURBISHED PART WITHOUT CHARGE TO YOU FOR THE PART, PROVIDED THAT IF A DEFECTIVE PART IS REPAIRED OR REPLACED AFTER NINETY (90) DAYS FROM THE DATE OF ORIGINAL RETAIL PURCHASE, YOU MUST PAY ALL LABOR CHARGES INVOLVED IN THE REPAIR OR REPLACEMENT. YOU MUST DELIVER THE ENTIRE LCD TELEVISION TO AN AUTHORIZED TCL SERVICE DEPOT. YOU MUST PAY FOR ALL TRANSPORTATION AND INSURANCE CHARGES FOR THE LCD TELEVISION TO AND FROM THE SERVICE DEPOT.

## Rental Units

The warranty for rental units begins with the date of first rental or thirty (30) days from the date of shipment to the rental firm, whichever comes first.

## \*Commercial Units

LCD TVs sold and used for commercial purposes have a limited ninety (90) day warranty for all parts, labor.

## Owner's Manual

Read this owner's manual thoroughly before operating this LCD TV.

## Your Responsibility

THE ABOVE WARRANTIES ARE SUBJECT TO THE FOLLOWING CONDITIONS:

- (1) You must provide your bill of sale or other proof of purchase.
- (2) All warranty servicing of this LCD TV must be made by an Authorized TCL Service Depot.
- (3) The warranties from TCL are effective only if the LCD TV is purchased in Canada from an authorized TCL dealer and operated in Canada.
- (4) Labor service charges for set installation, setup, adjustment of customer controls, and installation or repair of antenna systems are not covered by these warranties. Reception problems caused by inadequate antenna systems are your responsibility.

- (5) Warranties extend only to defects in materials or workmanship as limited above and do not extend to any LCD TV or parts that have been lost or discarded by you or to damage to the LCD TV or parts caused by misuse, accident, Acts of God (such as lightning or fluctuations in electric power), improper installation, improper maintenance, or use in violation of instructions furnished by TCL; or to units that have been modified or had the serial number removed, altered, defaced, or rendered illegible.

## How to Obtain Warranty Services

If, after following all of the operating instructions in this manual and checking the "Troubleshooting" section, you find that service is needed:

- (1) To find the nearest TCL Authorized Service Depot, visit TCL's web site at [www.toshiba.ca](http://www.toshiba.ca).
- (2) Present your bill of sale or other proof of purchase to the Authorized Service Depot. You must deliver the entire LCD television to an Authorized TCL Service Depot. You must pay for all transportation and insurance charge for the LCD television to and from the Service Depot.

**For additional information, visit TCL's web site:  
[www.toshiba.ca](http://www.toshiba.ca)**

ALL WARRANTIES IMPLIED BY THE LAW OF ANY PROVINCE OF CANADA, INCLUDING THE IMPLIED WARRANTIES OF MERCHANTABILITY AND FITNESS FOR A PARTICULAR PURPOSE, ARE EXPRESSLY LIMITED TO THE DURATION OF THE LIMITED WARRANTIES SET FORTH ABOVE. WITH THE EXCEPTION OF ANY WARRANTIES IMPLIED BY THE LAW OF ANY PROVINCE OF CANADA AS HEREBY LIMITED, THE FOREGOING WARRANTY IS EXCLUSIVE AND IN LIEU OF ALL OTHER WARRANTIES, GUARANTEES, AGREEMENTS, AND SIMILAR OBLIGATIONS OF TCL WITH RESPECT TO THE REPAIR OR REPLACEMENT OF ANY PARTS. IN NO EVENT SHALL TCL BE LIABLE FOR CONSEQUENTIAL OR INCIDENTAL DAMAGES.

No person, agent, distributor, dealer, or company is authorized to change, modify, or extend the terms of these warranties in any manner whatsoever. The time within which action must be commenced to enforce any obligation of TCL arising under this warranty or under any law of Canada or of any province thereof is hereby limited to 90 days from the date you discover, or should have discovered, the defect. This limitation does not apply to implied warranties arising under the law of any province of Canada.

THIS WARRANTY GIVES YOU SPECIFIC LEGAL RIGHTS, AND YOU MAY ALSO HAVE OTHER RIGHTS, WHICH MAY VARY FROM PROVINCE TO PROVINCE IN CANADA. SOME PROVINCES OF CANADA DO NOT ALLOW LIMITATIONS ON THE DURATION OF AN IMPLIED WARRANTY, LIMITATIONS ON THE TIME WITHIN WHICH AN ACTION MAY BE BROUGHT, OR THE EXCLUSION OR LIMITATION OF INCIDENTAL OR CONSEQUENTIAL DAMAGES; THEREFORE, THE ABOVE LIMITATIONS OR EXCLUSIONS MAY NOT APPLY TO YOU UNDER SUCH CIRCUMSTANCES.

Rev. MAR 02

# Index

## A B

Antenna cables .....	10
Audio mode selection .....	31
Audio system connection .....	14
Auto off .....	30
A/V cables .....	10
Back of the TV .....	8

## C

Cable converter box connection .....	14
Camcorder connection .....	14
CH ▲▼ buttons .....	18
CH RTN button .....	20
Channel Number buttons .....	20
Channel programming	
Automatic programming .....	18
Memory/ERASE .....	19
Closed caption .....	25
Component video cables .....	10

## D E

DTV receiver connection .....	13
DVD connection .....	12

## F G H I K

FAV. CH button .....	19
Favorite channels .....	19
Front of the TV .....	8

## L M

Language selection .....	18
Last mode memory .....	30
Menu system .....	17
MTS .....	26
MUTE button .....	26

## O P Q

Panel lock .....	25
PC connection .....	15
PC setting .....	29
Picture adjustments	
Picture mode .....	23
Picture quality .....	23

## R

RECALL button .....	30
Remote control	
Battery installation .....	16
Learning about the buttons .....	16

## S

S-video cables .....	10
SAP sound .....	26
Set-top box .....	13
Sleep timer .....	25
Sound quality adjustments .....	28
Specifications .....	31
Stable sound .....	28
Stereo sound .....	26

## T

Troubleshooting .....	32
TV/VIDEO button .....	20

## V

V-Chip	
Age block .....	22
Aux block .....	22
Content block .....	22
MPAA .....	22
Password .....	22
VCR connection .....	11-13

## W

Warranty .....	33, 34
WOW surround .....	27

## **TOSHIBA AMERICA CONSUMER PRODUCTS, L.L.C.**

HEAD OFFICE:82 TOTOWA ROAD, WAYNE, NEW JERSEY 07470, U.S.A.  
NATIONAL SERVICE DIVISION:1420B TOSHIBA DRIVE, LEBANON, TN. 37087, U.S.A.

## **TOSHIBA OF CANADA LTD.**

HEAD OFFICE/191 McNABB STREET MARKHAM, ONTARIO L3R 8H2, CANADA TEL: (905) 470-5400

SERVICE CENTERS:

TORONTO: 191 McNABB STREET MARKHAM, ONTARIO L3R 8H2, CANADA TEL: (905) 470-5400

MONTREAL: 18050 TRANS CANADA, KIRKLAND, QUEBEC, H9J-4A1, CANADA TEL:(514)390-7766

VANCOUVER: 22171 FRASERWOOD WAY, RICHMOND, B.C. V6W 1J5, CANADA TEL: (604) 303-2500

ColorStream and StableSound are registered trademarks of Toshiba America Consumer Products, L.L.C.

# **TOSHIBA**

## Free Manuals Download Website

<http://myh66.com>

<http://usermanuals.us>

<http://www.somanuals.com>

<http://www.4manuals.cc>

<http://www.manual-lib.com>

<http://www.404manual.com>

<http://www.luxmanual.com>

<http://aubethermostatmanual.com>

Golf course search by state

<http://golfingnear.com>

Email search by domain

<http://emailbydomain.com>

Auto manuals search

<http://auto.somanuals.com>

TV manuals search

<http://tv.somanuals.com>