



# TOSHIBA



Introduction

Connecting your TV

Setting up your TV

Using the TV's Features

Appendix

# OWNER'S MANUAL

## LCD Color Television

COLORSTREAM<sup>®</sup> HD

SRS<sup>®</sup> WOW

HDMI

THEATERWIDE HD

HDTV MONITOR

### Owner's Record

The model number and serial number are on the back of your TV. Record these numbers in the spaces below. Refer to these numbers whenever you communicate with your Toshiba dealer about this TV.

Model number:

Serial number:

# 20HL85

© 2005 TOSHIBA CORPORATION  
All Rights Reserved

Always read and understand the **PRODUCT WARNINGS and USER DIRECTIONS** that are contained in this manual before attempting to use your television, to help ensure its safe use.

Always store this manual near your television for convenient future reference.

### Dear Customer,

Thank you very much for purchasing this Toshiba television.

You must carefully read and understand all of the safety instructions contained in this manual before you attempt to use this product in order to avoid potential hazards that could cause bodily injury or property damage or could damage your Television.

We hope that you are completely satisfied with your Toshiba television and that it will give you long and enjoyable service. We look forward to providing you with additional Toshiba products to serve all of your entertainment needs in the future.

## Safety Precautions

**WARNING: TO REDUCE THE RISK OF FIRE OR ELECTRIC SHOCK, DO NOT EXPOSE THIS APPLIANCE TO RAIN OR MOISTURE.**



**CAUTION: TO REDUCE THE RISK OF ELECTRIC SHOCK, DO NOT REMOVE COVER (OR BACK). NO USER-SERVICEABLE PARTS INSIDE. REFER SERVICING TO QUALIFIED SERVICE PERSONNEL.**



The lightning flash with arrowhead symbol, within an equilateral triangle, is intended to alert the user to the presence of uninsulated "dangerous voltage" within the product's enclosure that may be of sufficient magnitude to constitute a risk of electric shock to persons.



The exclamation point within an equilateral triangle, is intended to alert the user to the presence of important operating and maintenance (servicing) instructions in the literature accompanying the appliance.

**CAUTION: To reduce the risk of electric shock, do not use the polarized plug with an extension cord, receptacle, or other outlet unless the blades can be inserted completely to prevent blade exposure.**

**WARNING:** Handling the cord on this product or cords associated with accessories sold with this product will expose you to lead, a chemical known to the State of California to cause birth defects or other reproductive harm. **Wash hands after handling.**



ENERGY STAR

ENERGY STAR® qualified TV. Products that earn the ENERGY STAR prevent green house gas emissions by meeting strict energy efficiency guidelines set by the U.S. Environmental Protection Agency and the U.S. Department of Energy. ENERGY STAR and the ENERGY STAR mark are registered U.S. marks.

**WARNING:** Always use the Toshiba wall bracket specified below or another wall bracket approved by Toshiba for wall mounting this television. The use of any wall bracket other than the Toshiba wall bracket specified below or another wall bracket approved by Toshiba for wall mounting this television could result in serious bodily injury and/or property damage.

**In the U.S.:** Use Toshiba wall bracket model number **FWB2027**. For more information, call TACP's Consumer Solutions Center at 1-800-631-3811 or visit TACP's website at [www.tacp.toshiba.com](http://www.tacp.toshiba.com).

**In Canada:** Call TCL's Customer Service Department at 1-800-268-3404.

## NOTE TO CATV INSTALLERS

This is a reminder to call the CATV system installer's attention to Article 820-40 of the U.S. NEC, which provides guidelines for proper grounding and, in particular, specifies that the cable ground shall be connected to grounding system of the building, as close to the point of cable entry as practical. For additional antenna grounding information, see item 17 on page 4.

## Child Safety

**It Makes A Difference Where Your TV Stands**

**Congratulations on your purchase!**

**As you enjoy your new TV, keep these safety tips in mind:**



### The Issue

- If you are like most consumers, you have a TV in your home. Many homes, in fact, have more than one TV.
- The home theater entertainment experience is a growing trend, and larger TVs are popular purchases; however, they are not always supported on the proper TV stands.
  - Sometimes TVs are improperly secured or inappropriately situated on dressers, bookcases, shelves, desks, audio speakers, chests, or carts. As a result, TVs may fall over, causing unnecessary injury.



### Toshiba Cares!

- The consumer electronics industry is committed to making home entertainment enjoyable and safe.
- The Consumer Electronics Association formed the Home Entertainment Support Safety Committee, comprised of TV and consumer electronics furniture manufacturers, to advocate children's safety and educate consumers and their families about television safety.

### Tune Into Safety

- One size does NOT fit all! Use appropriate furniture large enough to support the weight of your TV (and other electronic components).
- Use appropriate angle braces, straps, and anchors to secure your furniture to the wall (but never screw anything directly into the TV).
- Carefully read and understand the other enclosed instructions for proper use of this product.
- Do not allow children to climb on or play with furniture and TVs.
- Avoid placing any item on top of your TV (such as a VCR, remote control, or toy) that a curious child may reach for.
- Remember that children can become excited while watching a program and can potentially push or pull a TV over.
- Share our safety message about this hidden hazard of the home with your family and friends. Thank you!



2500 Wilson Blvd.  
Arlington, VA 22201 U.S.A.  
Tel. 703-907-7600 Fax 703-907-7690  
[www.CE.org](http://www.CE.org)

CEA is the Sponsor, Producer and Manager of the International CES®



## FCC compliance information

**CAUTION:** TO PREVENT ELECTRIC SHOCK DO NOT USE THIS POLARIZED PLUG WITH AN EXTENSION CORD, RECEPTACLE OR OTHER OUTLET UNLESS THE BLADES CAN BE FULLY INSERTED TO PREVENT BLADE EXPOSURE.

### Federal Communications Commission (FCC):

This equipment complies with Part 15 of the FCC rules.

### FCC Declaration of Conformity Compliance Statement (Part 15):

The Toshiba 20HL85, LCD TV Combination complies with Part 15 of the FCC rules. Operation is subject to the following two conditions: (1) this device may not cause harmful interference, and (2) this device must accept any interference received, including interference that may cause undesired operation.

The party responsible for compliance to these rules is:

Toshiba America Consumer Products, L.L.C.  
82 Totowa Rd. Wayne, NJ 07470.  
Ph: (800) 631-3811

**NOTE:** This equipment has been tested and found to comply with the limits for a Class B digital device, pursuant to Part 15 of the FCC rules. These limits are designed to provide reasonable protection against harmful interference in a residential installation. This equipment generates, uses, and can radiate radio frequency energy and, if not installed and used in accordance with the instructions, may cause harmful interference to radio communications. However, there is no guarantee that interference will not occur in a particular installation. If this equipment does cause harmful interference to radio or television reception, which can be determined by removing and applying power to the equipment, the user is encouraged to try to correct the interference by one or more of the following measures:

- Reorient or relocate the receiving antenna.
- Increase the separation between the equipment and the receiver.
- Connect the equipment into an outlet on a circuit different from that to which the receiver is connected.
- Consult the dealer or an experienced radio/TV technician for help.

**CAUTION:** Changes or modifications to this equipment not expressly approved by Toshiba could void the user's authority to operate this equipment.

## IMPORTANT SAFEGUARDS

### 1. READ INSTRUCTIONS

All the safety and operating instructions should be read before the unit is operated.

### 2. RETAIN INSTRUCTIONS

The safety and operating instructions should be retained for future reference.

### 3. HEED WARNINGS

All warnings on the unit and in the operating instructions should be adhered to.

### 4. FOLLOW INSTRUCTIONS

All operating and use instructions should be followed.

### 5. CLEANING

Unplug this unit from the wall outlet before cleaning. Do not use liquid cleaners or aerosol cleaners. Clean only with a dry cloth.

### 6. ATTACHMENTS

Do not use attachments not recommended by the product manufacturer as they may cause hazards.

### 7. WATER AND MOISTURE

Do not use this unit near water. For example, near a bathtub, washbowl, kitchen sink, laundry tub, in a wet basement, or near a swimming pool.

### 8. ACCESSORIES

Do not place this product on an unstable cart, stand, tripod, bracket, or table. The product may fall, causing serious injury to a child or adult, and serious damage to the product. Use only with a cart, stand, tripod, bracket, or table recommended by the manufacturer, or sold with the product. Any mounting of the product should follow the manufacturer's instructions, and should use a mounting accessory recommended by the manufacturer.

**8A.** An appliance and cart combination should be moved with care. Quick stops, excessive force, and uneven surfaces may cause the appliance and cart combination to overturn.

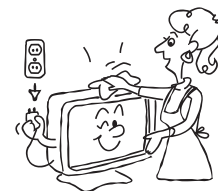

**DANGER:**  
RISK OF DEATH, SERIOUS  
PERSONAL INJURY, OR  
EQUIPMENT DAMAGE.



PORTABLE CART WARNING  
(symbol provided by RETAC)

S3126A

## 9. VENTILATION

Slots and openings in the cabinet back or bottom are provided for ventilation, and to ensure reliable operation of the unit, and to protect it from overheating. These openings must not be blocked or covered. The openings should never be blocked by placing the unit on a bed, sofa, rug, or other similar surface. This unit should never be placed near or over a radiator or heat source. This unit should not be placed in a built-in installation such as a bookcase or rack unless proper ventilation is provided or the manufacturer's instructions have been adhered to.

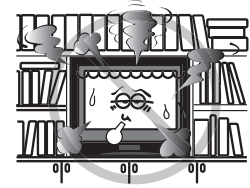

## 10. POWER SOURCE

This unit should be operated only from the type of power source indicated on the rating plate. If you are not sure of the type of power supply to your home, consult your appliance dealer or local power company.

## 11. GROUNDING OR POLARIZATION

This unit is equipped with a polarized alternating-current line plug (a plug having one blade wider than the other). This plug will fit into the power outlet only one way. This is a safety feature. If you are unable to insert the plug fully into the outlet, try reversing the plug. If the plug should still fail to fit, contact your electrician to replace your obsolete outlet.

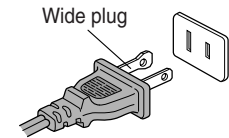

## 12. POWER-CORD PROTECTION

Power-supply cords should be routed so that they are not likely to be walked on or pinched by items placed upon or against them, paying particular attention to cords at plugs, convenience receptacles, and the point where they exit from the appliance.

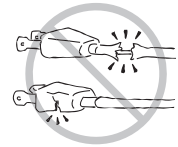

## 13. LIGHTNING

To protect your unit from a lightning storm, or when it is left unattended and unused for long periods of time, unplug it from the wall outlet and disconnect the antenna or cable system. This will prevent damage to the unit due to lightning and power line surges.

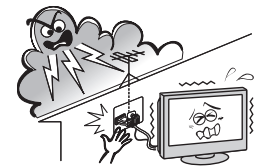

## 14. POWER LINES

An outside antenna system should not be located in the vicinity of overhead power lines or other electric light or power circuits, or where it can fall onto or against such power lines or circuits. When installing an outside antenna system, extreme care should be taken to keep from touching such power lines or circuits, as contact with them might be fatal.

## 15. OVERLOADING

Do not overload wall outlets and extension cords, as this can result in a risk of fire or electric shock.

## 16. OBJECT AND LIQUID ENTRY

Do not push objects through any openings in this unit, as they may touch dangerous voltage points or short out parts that could result in fire or electric shock. Never spill or spray any type of liquid into the unit.

## 17. OUTDOOR ANTENNA GROUNDING

If an outside antenna or cable system is connected to the unit, be sure the antenna or cable system is grounded to provide some protection against voltage surges and built-up static charges, Section 810 of the National Electrical Code (NEC), ANSI/NFPA 70, provides information with respect to proper grounding of the mast and supporting structure, grounding of the lead-in wire to an antenna discharge unit, size of grounding conductors, location of antenna discharge unit, connection to grounding electrodes, and requirements for the grounding electrode.

### EXAMPLE OF ANTENNA GROUNDING AS PER THE NATIONAL ELECTRICAL CODE

NEC-NATIONAL ELECTRICAL CODE

S2898A

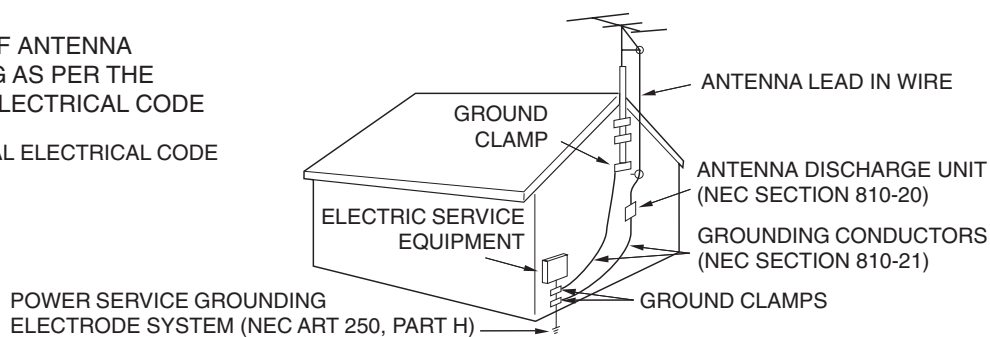



## 18. SERVICING

Do not attempt to service this unit yourself, as opening or removing covers may expose you to dangerous voltage or other hazards. Refer all servicing to qualified service personnel.

For example:

- a. When the power-supply cord or plug is damaged.
- b. If liquid has been spilled, or objects have fallen into the unit.
- c. If the unit has been exposed to rain or water.
- d. If the unit does not operate normally by following the operating instructions. Adjust only those controls that are covered by the operating instructions, as an improper adjustment of other controls may result in damage and will often require extensive work by a qualified technician to restore the unit to its normal operation.
- e. If the unit has been dropped or the cabinet has been damaged.
- f. When the unit exhibits a distinct change in performance, this indicates a need for service.



## 19. REPLACEMENT PARTS

When replacement parts are required, be sure the service technician uses replacement parts specified by the manufacturer or those that have the same characteristics as the original part.

Unauthorized substitutions may result in fire, electric shock or other hazards.

## 20. SAFETY CHECK

Upon completion of any service or repairs to this unit, ask the service technician to perform safety checks to determine that the unit is in proper operating condition.

## 21. HEAT

The product should be situated away from heat sources such as radiators, heat registers, stoves, or other products (including amplifiers) that produce heat.

## 22. CONNECTING

When you connect the product to other equipment, turn off the power and unplug all of the equipment from the wall outlet. Failure to do so may cause a product damage. Read the owner's manual of the other equipment carefully and follow the instructions when making any connections.

## 23. HEADPHONES

When you use headphones, keep the volume at a moderate level. Using headphones continuously at a high volume may cause hearing damage.

## 24. LCD

Do not press on or jolt the LCD panel. Doing so may cause the LCD panel glass to break and injury may occur. Should the LCD panel be broken and liquid leaks out, do not inhale or swallow it. Doing so may cause poisoning. If you have got it into your mouth, wash it out and consult your doctor. If your hands or clothes have touched it, wipe them with alcohol and a cleaning cloth and then wash them well.

Introduction

Connecting your TV

Setting up your TV

Using the TV's Features

Appendix

## ON DISPOSAL

**This product contains mercury. Disposal of mercury may be regulated due to environmental considerations. For disposal or recycling information, please contact your local authorities or the Electronic Industrial Alliance: [www.eiae.org](http://www.eiae.org).**

## Important notes about your LCD TV

The following symptoms are technical limitations of LCD Display technology and are not an indication of malfunction; therefore, Toshiba is not responsible for perceived defects resulting from these symptoms.

- 1) An afterimage (ghost) may appear on the screen if a fixed, non-moving image is displayed for a long period of time. The afterimage is not permanent and will disappear in a short period of time.

- 2) The LCD panel contained in this TV is manufactured using an extremely high level of precision technology; however, there may be an occasional pixel (dot of light) that does not operate properly (does not light, remains constantly lit, etc.). This is a structural property of LCD technology, is not a sign of malfunction, and is not covered under your warranty. Such pixels are not visible when the picture is viewed from a normal viewing distance.

**Note:** Interactive video games that involve shooting a "gun" type of joystick at an on-screen target may not work with this TV.

## Precautions

### Notes on handling

- Do not subject the LCD panel to physical shock, such as dropping it. It may cause unit damage and malfunction.
- Retain the original shipping carton and packing materials. For maximum protection when shipping, repack the unit as it was originally packed at the factory.
- Do not use volatile liquids, such as insecticide, near the unit. Do not leave rubber or plastic products in contact with the unit for prolonged periods of time. Doing so will leave marks on the finish.
- The top and rear panels of the unit may become warm after a long period of use. This is not a malfunction.
- When the unit is not in use, turn off the power.
- If you do not use the unit for a long period, the unit may not function properly in the future. Turn on and use the unit occasionally.

### Notes on locating the unit

- When you place this unit near a TV, radio, or VCR, the playback picture may become poor and the sound may be distorted. In this case, place the unit away from the TV, radio, or VCR.
- To avoid damage to this product, never place or store the TV in direct sunlight; hot, humid areas; or areas subject to excessive dust or vibration.
- Always place the TV on the floor or a sturdy, level stable surface that can support the weight of the unit. Use a sturdy tie between the TV's rear hooks and the rear wall, pillar, etc., or screw the TV to the stand using the TV's rear screw hole or a safety band (see illustration).

### Notes on cleaning

Clean only with a soft, dry, lint-free cloth.

### Notes on LCD

- The color LCD is manufactured using extremely high precision technology, but even so may include certain pixels that do not operate properly (that do not light, that remain lit constantly, etc.). We do our best to keep the number of these defective pixels to a minimum, but please understand that they cannot be completely eliminated even with the most advanced manufacturing technologies available today.
- The fluorescent tube which illuminates the panel from the inside will deteriorate with use. When the LCD becomes dim, flickers, or does not illuminate, contact your dealer for replacement.
- The brightness of the LCD monitor differs slightly depending on the viewing angles. Adjust the angle to obtain the best viewing. (The recommended angle is 90 degrees to the monitor.)

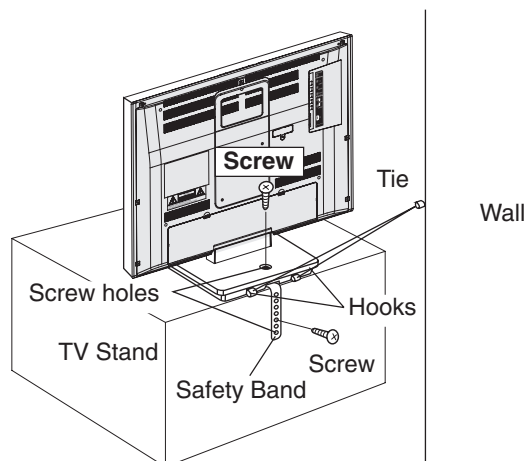



**Introduction ..... 2**

- FCC compliance information ..... 3
- IMPORTANT SAFEGUARDS ..... 3
- Precautions ..... 6
- Exploring your new TV ..... 8
- Selecting a location for the TV ..... 9

**Connecting your TV ..... 9**

- Connecting a VCR ..... 9
- Connecting a cable converter box or antenna ..... 10
- Connecting a DVD player/satellite receiver and a VCR ..... 11
- Connecting a DVD player with ColorStream® (component video) and a VCR ..... 12
- Connecting a DTV receiver/set-top box with ColorStream® (component video) and a VCR ..... 13
- Connecting a camcorder ..... 14
- Connecting an HDMI™ or a DVI device to the HDMI input ..... 15
- Connecting a PC (Personal Computer) ..... 16

**Power source ..... 16**

- Power connection ..... 16

**Setting up your TV ..... 17**

- Using the remote control ..... 17
  - Preparing the remote control for use ..... 17
  - Installing the remote control batteries ..... 17
  - Using the remote control to operate your other devices ..... 17
  - Programming the remote control to operate your other devices ..... 18
- Cable TV converter/satellite receiver, VCR and DVD player code tables ..... 19
- Learning about the remote control ..... 21
- Starting setup ..... 22
  - Changing the on-screen display language ..... 22
  - Adding channels to the TV's memory ..... 23
  - Programming channels automatically ..... 23
  - Adding and erasing channels manually ..... 23
  - Changing channels ..... 23

**Using the TV's features ..... 24**

- Adjusting the channel settings ..... 24
- Switching between two channels ..... 24
- Programming your favorite channels ..... 24
- Using the LOCKS menu ..... 25
  - Selecting a password ..... 25
  - Using the V-Chip (parental control) feature ..... 26
  - Locking channels ..... 27
  - Locking the video inputs ..... 27
  - Setting the GameTimer™ ..... 28
  - Using the panel lock feature ..... 28
- Labeling channels ..... 29
- Selecting the video input source ..... 30
- Labeling the video input sources ..... 30
- Setting the clock ..... 30
- Setting the ON timer ..... 31
- Viewing the wide-screen picture formats (480i and 480p signals only) ..... 32
- Selecting the cinema mode ..... 33
- Using the ASPECT feature ..... 33
- Setting the sleep timer ..... 34
- Using the closed caption feature ..... 34
- Adjusting the picture ..... 35
  - Selecting the picture mode ..... 35
  - Adjusting the picture quality ..... 35
  - Using the CableClear® feature ..... 36
  - Selecting the color temperature ..... 36
  - Resetting your picture adjustments ..... 36
- Adjusting the sound ..... 37
  - Muting the sound ..... 37
  - Selecting stereo/SAP broadcasts ..... 37
  - Adjusting the sound quality ..... 37
  - Resetting your audio adjustments ..... 38
  - Using the StableSound® feature ..... 38
  - Using the WOW™ surround sound feature ..... 38
  - Selecting the HDMI audio input source ..... 39
- Adjusting the back lighting feature ..... 39
- Displaying on-screen information ..... 39
- Auto power off ..... 39
- Understanding the Power Return feature ..... 39
- Picture/Audio adjustments in the PC mode ..... 40
- Resetting your picture/audio adjustment in the PC mode ..... 40

**Appendix ..... 41**

- Troubleshooting ..... 41
- Specifications ..... 42
- Limited United States Warranty ..... 43
- Limited Canada Warranty ..... 44

Introduction

Connecting your TV

Setting up your TV

Using the TV's Features

Appendix



## Exploring your new TV

You can operate your TV by using the buttons on the top panel or the remote control. The side and back panels provide the inputs to connect other equipment to your TV.

The STARTING SETUP feature appears the first time you turn on the TV. See page 22 for details.

Top panel

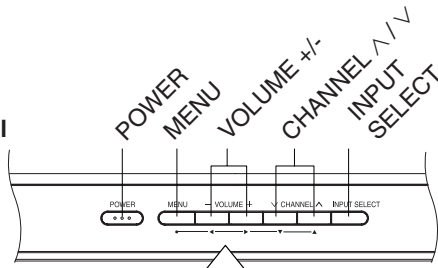

Top

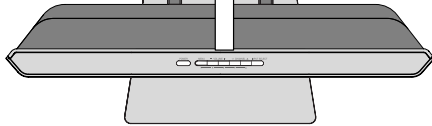

Front

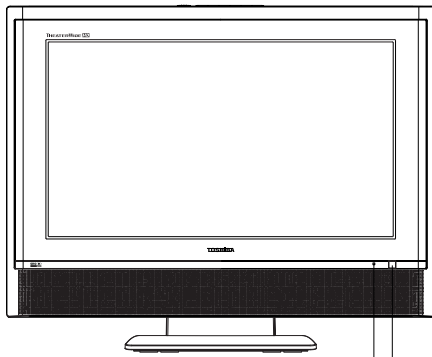

Power indicator  
Remote sensor

Right side

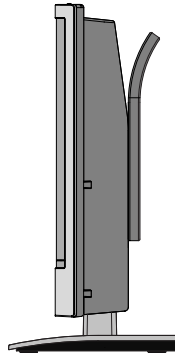

Approx 5° Approx 10°



You can adjust the angle of the TV screen 5° forward or 10° backward from vertical. Hold the base of the TV while adjusting the angle.

Remote control

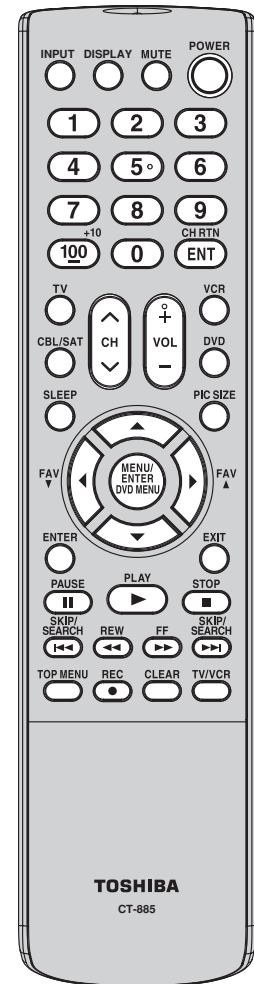

Back

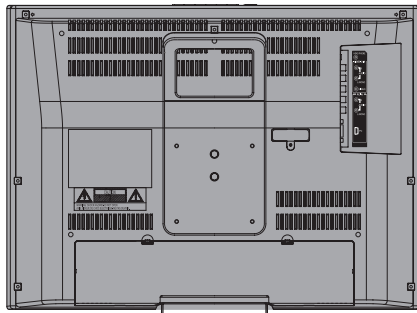

Left side

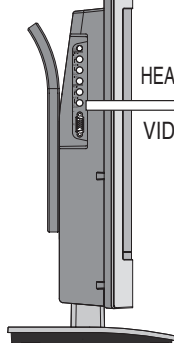

Side panel

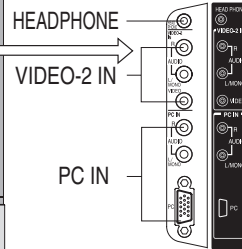

Back panel

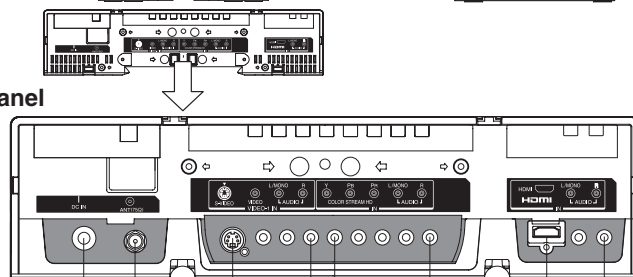

DC IN RF IN VIDEO-1 IN ColorStream HD IN HDMI IN





## Selecting a location for the TV

- Place the TV on the floor or on a sturdy platform in a location where light does not directly hit the screen.
- Place the TV far enough from the walls to allow proper ventilation. Inadequate ventilation may cause overheating, which may damage the TV.

## Connecting your TV

If you haven't connected electronic equipment before, or you have been frustrated in the past, you may wish to read this section. (Cables are not supplied.)

- A coaxial cable is the standard cable that comes in from your antenna or cable converter box. Coaxial cables use "F" connectors.
- Standard A/V (audio/video) cables are usually color coded according to use: yellow for video and red and white for audio. The red audio cable is for the stereo right channel, and the white audio cable is for the stereo left (or mono) channel. If you look at the rear panel of the TV, you will see that the terminals are color coded in the same manner as the cables.
- S-video cables provide better picture performance than standard video cables. S-video cables can only be used with S-video compatible components.
- Component video cables provide better picture performance than S-video cables. Component video cables can only be used with component video compatible components.
- HDMI (High Definition Multimedia Interface) cable is for use with video equipment that has HDMI output (see page 15).



### Note:

To prevent equipment damage, do not plug in any power cords until you have finished connecting all equipment.

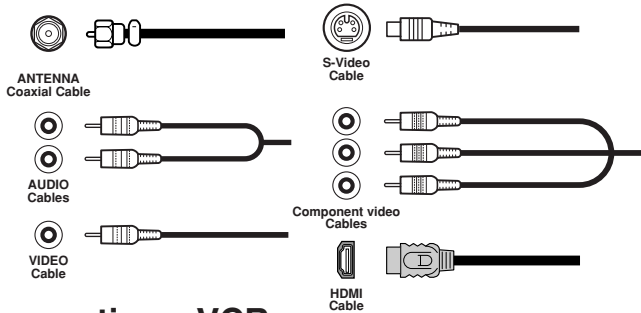

## Connecting a VCR

This connection allows you to watch local channels and video programs, play or record on the VCR while watching TV, and record from one channel while watching another channel.

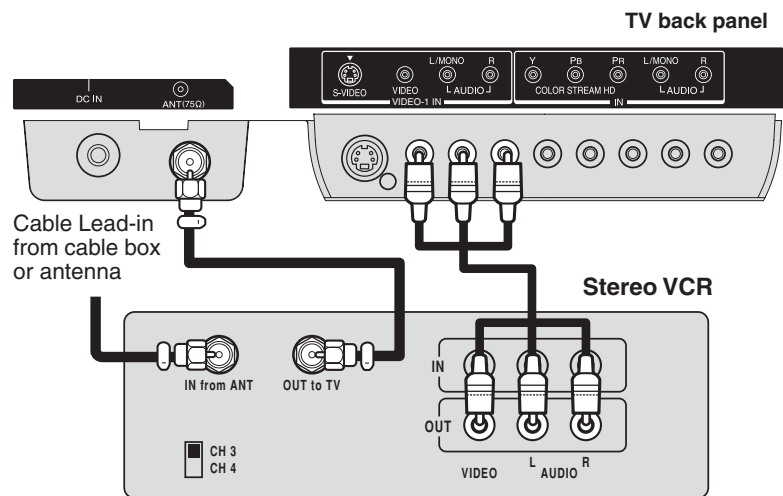

You will need:

- two coaxial cables
- one set of standard A/V cables

### Note:

If using a mono VCR, connect L/Mono to VCR Audio OUT using only one audio cable. For better picture quality, if your VCR has S-video, you can use an S-video cable instead of the standard video cable. Do not connect a standard video cable and an S-video cable to VIDEO-1 simultaneously.

The unauthorized recording, use, distribution or revision of television programs, videotapes, DVDs, and other materials is prohibited under the Copyright Laws of the United States and other countries, and may subject you to civil and criminal liability.





## Connecting a cable converter box or antenna

This television has an extended tuning range and can tune most cable channels without using a cable company supplied converter box. Some cable companies offer "premium pay channels" in which the signal is scrambled. Descrambling these signals for normal viewing requires the use of a descrambler device, which is generally provided by the cable company.

### Option 1: For Subscribers to Basic Cable TV Service

For basic cable service not requiring a Converter/Descrambler box, connect the incoming 75 ohm Coaxial Cable directly to the Antenna Jack on the back of the television.

### Option 2: For Subscribers to Scrambled Cable TV Service

If you subscribe to a cable service that requires the use of a Converter/Descrambler box, connect the incoming cable to the Converter/Descrambler box and connect the output of the box to the Antenna Jack on the back of the television. Follow the connections shown below. Set the television to the output of the Converter/Descrambler box (usually channel 3 or 4) and use the Converter/Descrambler box to select channels.

### Option 3: For Subscribers to Unscrambled Basic Cable with Scrambled Premium Channels

If you subscribe to a cable service in which basic cable channels are unscrambled and premium channels require the use of a Converter/Descrambler box, you may wish to use a two-set signal splitter (sometimes called a "two-set coupler") and an A/B Switch box from the cable installer or an electronics supply store. Follow the connections shown below. With the switch in the "B" position, you can directly tune any nonscrambled channels on your TV. With the switch in the "A" position, tune your TV to the output of the Converter/Descrambler box (usually channel 3 or 4) and use the box to tune scrambled channels.

**Note:**  
When you use a converter box with your TV, there may be features that you cannot program using the remote control, such as labeling channels, blocking channels, and programming your favorite channels.

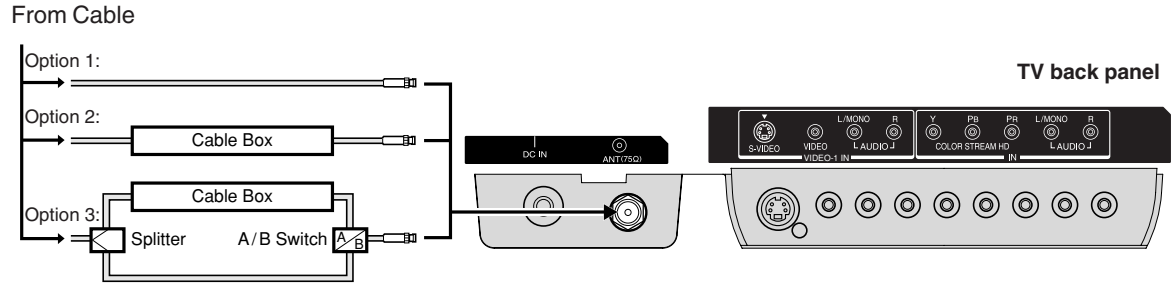



## Connecting a DVD player/satellite receiver and a VCR

This connection allows you to watch DVD/satellite, VCR, or TV programs. You can record from the satellite receiver and TV, as well as record one TV channel while watching another channel.

From satellite

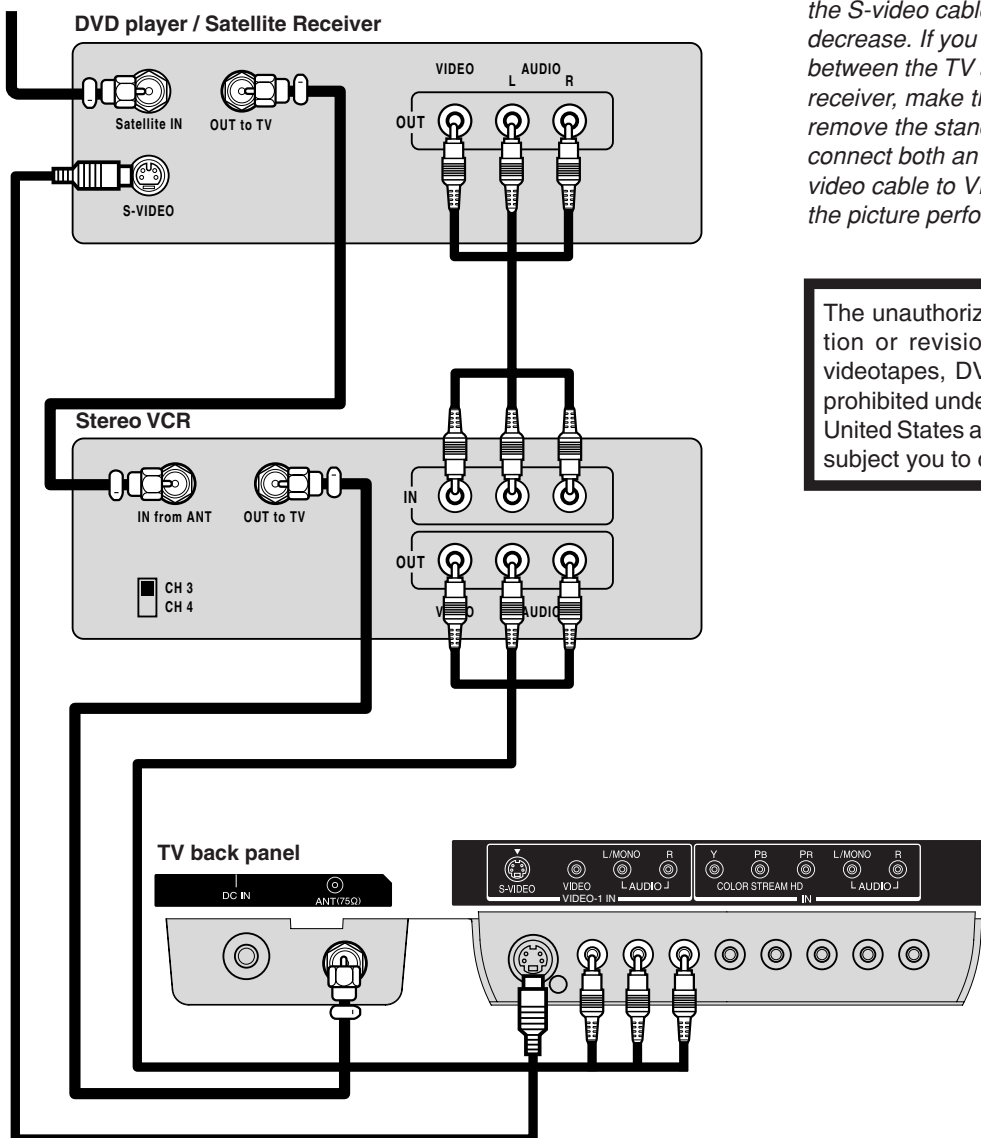

You will need:

- three coaxial cables
- two sets of standard A/V cables
- one S-video cable

### Note:

You can use a standard video cable instead of the S-video cable, but the picture quality will decrease. If you use an S-video cable between the TV and DVD player/satellite receiver, make the audio connections but remove the standard video cable. Do not connect both an S-video and a standard video cable to VIDEO1 at the same time or the picture performance will be unacceptable.

The unauthorized recording, use, distribution or revision of television programs, videotapes, DVDs, and other materials is prohibited under the Copyright Laws of the United States and other countries, and may subject you to civil and criminal liability.

Introduction

Connecting your TV

Setting up your TV

Using the TV's Features

Appendix



## Connecting a DVD player with ColorStream® (component video) and a VCR

This connection allows you to watch DVD, VCR, or TV programs and record TV programs. You can record from one source while watching a program from another source. Your TV is capable of using ColorStream (component video). Connecting your TV to a component video compatible DVD player, such as a Toshiba DVD player with ColorStream®, can greatly enhance picture quality and performance.

Connecting your TV

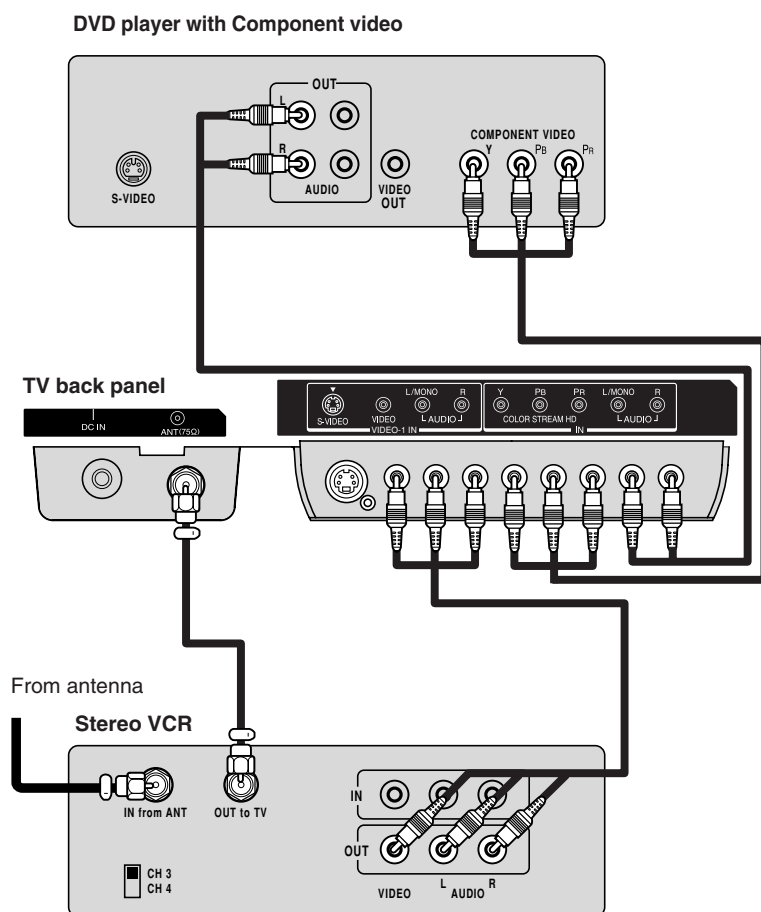

You will need:

- two coaxial cables
- one set of standard A/V cables
- one set of component video cables
- one pair of standard audio cables

### Note:

The ColorStream HD jacks can be used with Progressive (480p, 720p) and Interlaced (480i, 1080i) scan systems. A 1080i signal will provide the best picture performance.

The unauthorized recording, use, distribution or revision of television programs, videotapes, DVDs, and other materials is prohibited under the Copyright Laws of the United States and other countries, and may subject you to civil and criminal liability.



## Connecting a DTV receiver/set-top box with ColorStream® (component video) and a VCR

This connection allows you to watch DTV (digital TV), VCR, and TV programs, and record DTV and TV programs. Your TV has ColorStream® (component video) inputs. Connecting your TV to a DTV receiver with component video can greatly enhance picture quality and realism.

You will need:

- three coaxial cables
- two sets of standard A/V cables
- one set of standard audio cables
- one set of component video cables

### Note:

For HDMI connection, see page 15. The ColorStream HD jacks and HDMI jacks can be used with Progressive (480p, 720p) and Interlaced (480i, 1080i) scan systems. If your DTV receiver does not have component video, use the S-video and standard audio connections instead. Do not connect both an S-video and a standard video cable to VIDEO1 at the same time or the picture performance will be unacceptable.

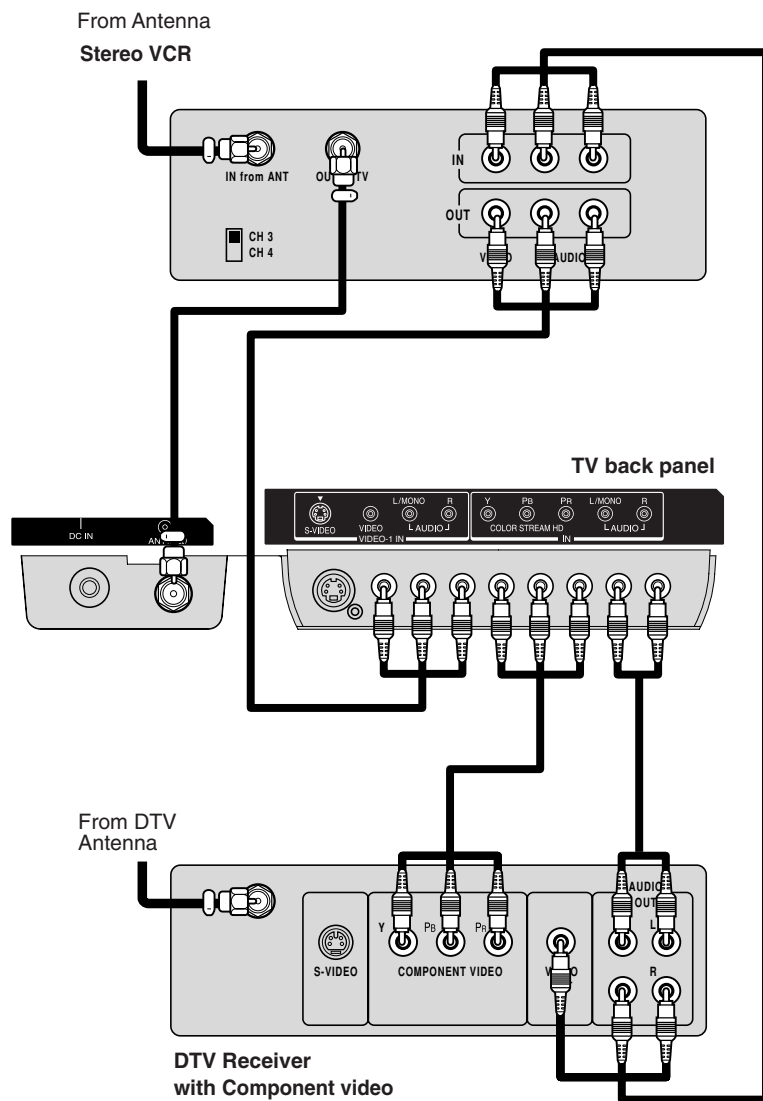

The unauthorized recording, use, distribution, or revision of television programs, videotapes, DVDs, and other materials is prohibited under the Copyright Laws of the United States and other countries, and may subject you to civil and criminal liability.



Connecting your TV

## Connecting a camcorder

This connection allows you to watch videos recorded on a camcorder.

You will need:

- one set of standard AV cables

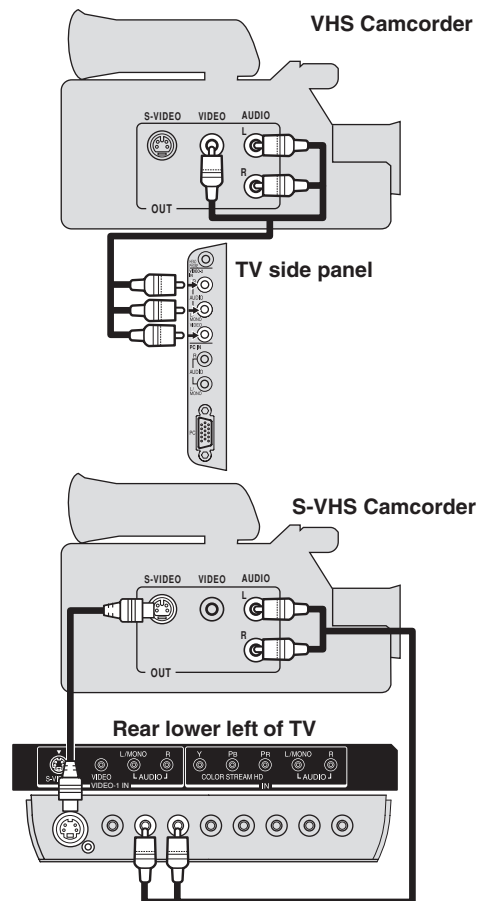

You will need:

- one S-video cable
- one pair of standard audio cables

### Note:

For better picture quality, if your camcorder has S-video, you can use an S-video cable (plus the standard audio cables) instead of a standard video cable.

Do not connect both a standard video cable and an S-video cable at the same time, or the picture performance will be unacceptable.



## Connecting an HDMI™ or a DVI device to the HDMI input

The HDMI<sup>[1]</sup> input on your TV receives digital audio and uncompressed digital video from an HDMI device or uncompressed digital video from a DVI<sup>[2]</sup> device.

This input is designed to accept HDCP<sup>[3]</sup> program material in digital form from EIA/CEA-861/861B-compliant<sup>[4]</sup> consumer electronic devices (such as a set-top box or DVD player with HDMI or DVI output).

The HDMI input is designed for best performance with high definition video signals. It will accept and display 480i, 480p, 720p and 1080i signals.

**Note: The HDMI jack is not intended for connection to and should not be used with a personal computer. For PC connection, see page 16.**

### To connect an HDMI device, you will need:

- one HDMI cable (type A connector)

*For proper operation, it is recommended that you use as short an HDMI cable as possible. You should not encounter difficulty if you use an HDMI cable that is shorter than 16.4 ft (5m).*

*HDMI cable transfers both video and audio. Separate analog audio cables are not required (see illustration below).*

**You must set the HDMI audio input setting to “HDMI” in the AUDIO menu (see page 39).**

*Some CDVs (Video CDs) may not output digital audio signals. In that case, you may hear sound by connecting analog audio cables. If you do use analog audio cables for this reason, you will need to set the HDMI audio input setting to “DVI” to hear the analog audio (see page 39).*

**Note:** *If you connect an HDMI device and analog audio cables and play media with digital audio output, to hear digital audio you must set the HDMI audio input setting to “HDMI” (page 39).*

### HDMI device

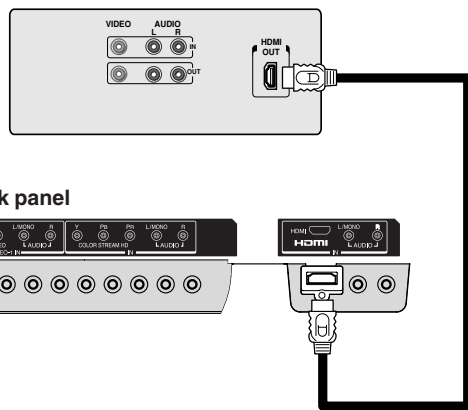

### TV back panel

- [1] HDMI = High-Definition Multimedia Interface.
  - [2] DVI = Digital Video Interface.
  - [3] HDCP = High-bandwidth Digital Content Protection.
  - [4] EIA/CEA-861/861B compliance covers the transmission of uncompressed digital video with high-bandwidth digital content protection, which is being standardized for reception of high-definition video signals.
- Because this is an evolving technology, it is possible that some devices may not operate properly with the TV.*

*To ensure that the HDMI or DVI device is reset properly, it is recommended that you follow these procedures:*

- *When turning on your electronic components, turn on the TV first, and then the HDMI or DVI device.*
- *When turning off your electronic components, turn off the HDMI or DVI device first, and then the TV.*

### To connect a DVI device, you will need:

- one HDMI-to-DVI adapter cable (HDMI type A connector)
- one pair of standard analog audio cables

*For proper operation, the length of an HDMI-to-DVI adapter cable should not exceed 9.8 ft (3m). The recommended length is 6.6 ft (2m).*

*An HDMI-to-DVI adapter cable transfers only video. Separate analog audio cables are required (see illustration below).*

**You must set the HDMI audio input setting to “DVI” in the AUDIO menu (see page 39).**

### DVI device

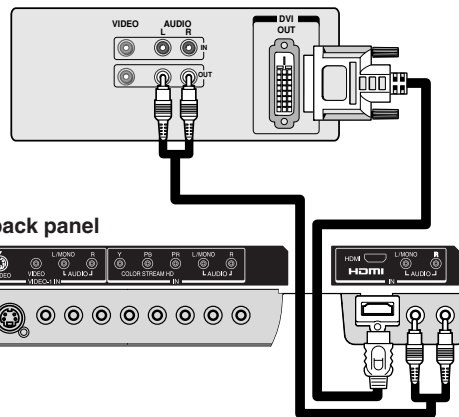

### TV back panel

HDMI, the HDMI logo, and High-Definition Multimedia Interface are trademarks or registered trademarks of HDMI Licensing, LLC.



Connecting your TV

### Connecting a PC (Personal Computer)

Before you connect this TV to your PC, change the adjustment of your PC's Resolution and Refresh rate. See "Monitor Display modes" at right.

Connect one end of a (male to male) VGA cable to the video card of the computer and the other end to the VGA connector PC at the side of the TV. Fix the connectors firmly with the screws on the plug. In case of a Multimedia computer, connect the audio cables to the audio outputs of your Multimedia computer and to the AUDIO L and R connectors of the PC IN jacks of the TV.

Set the video input source to PC mode (see "Selecting the video input source" on page 30 and "Picture/Audio adjustments in the PC mode" on page 40). The TV can be used as a computer monitor.

You will need:

- one VGA cable

#### Monitor Display modes

MODE	Resolution	Refresh rate
VGA	640x480	60Hz
SVGA	800x600	56.3Hz
SVGA	800x600	60.3Hz
XGA	1024x768	60Hz
WXGA	1280x720	60Hz
WXGA	1280x768	60Hz

#### Notes:

- The current signal source does not display when you return to TV mode.
- The on-screen displays will have a different appearance in PC mode than in TV mode.
- When you select WXGA mode, set the WXGA INPUT to ON in the PC PICTURE menu (see page 40.)

#### TV side panel

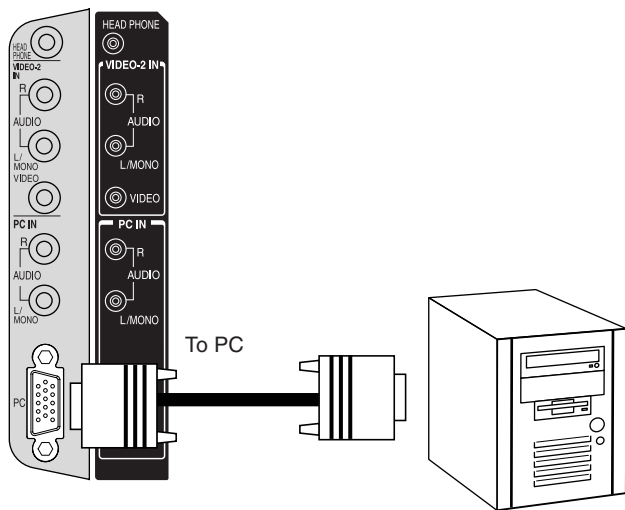

### Power source

#### Power connection

##### To use AC power

1. Connect the AC cord to the AC adapter.
2. Connect the AC adapter plug into the TV's DC input jack.
3. Connect the AC cord into a wall outlet.

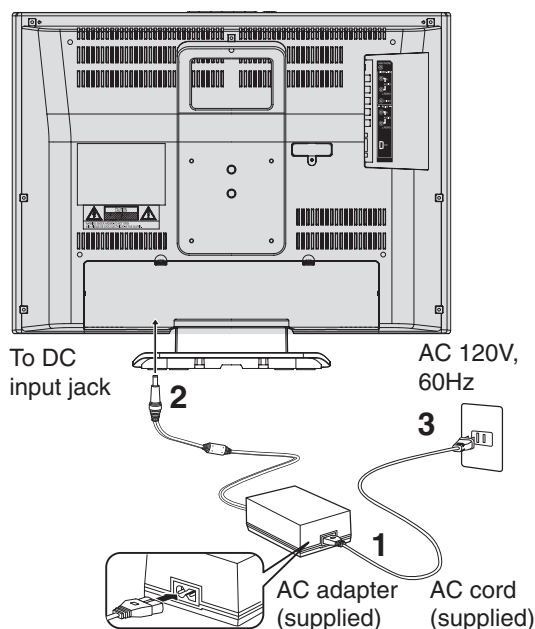

#### Notes:

- Make sure to insert the plug of each cord securely.
- During use the AC adapter becomes warm. This is not a malfunction.

#### WARNING:

- Do not connect this unit to the power using any device other than the supplied AC adapter or power cord. This could cause fire, electric shock, or damage.
- Do not use with a voltage other than the power voltage displayed. This could cause fire, electric shock, or damage.
- Never lift the AC adapter by holding the AC cord. The AC adapter may fall, causing personal injury or equipment damage.

#### CAUTION:

- Do not use the AC adapter if it is covered by a cloth etc., or pressed into a narrow area. This results in poor dissipation of heat and may cause fire, electric shock, or damage.
- When this unit is not used for a long time, (e.g., away on a trip) in the interest of safety, be sure to unplug it from the wall outlet.
- Do not plug/unplug the plug when your hands are wet. This may cause electric shock.
- If you need to replace the supplied AC adapter or AC cord, the specified AC adapter and AC cord must be used. Contact the dealer that you purchased the unit from.







# Setting up your TV

## Using the remote control

### Preparing the remote control for use

With the remote control, you can operate your TV, most cable TV converters/satellite receivers, VCRs, and DVD players together, even if they are different brands. If you will be using your TV with a Toshiba satellite receiver, VCR, or DVD player, your remote control is already programmed and ready to use. If you own different brands of cable TV converters/satellite receivers, VCRs, and/or DVD players, you must first program your remote control. (See "Programming the remote control to operate your other devices," on page 18.)

### Installing the remote control batteries

#### To install the batteries:

1. Open the battery cover on the back of the remote control.

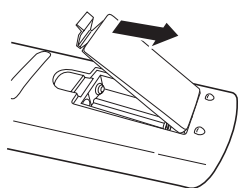

2. Install two "AAA" size batteries. Match the + and - signs on the batteries to the signs on the battery compartment.

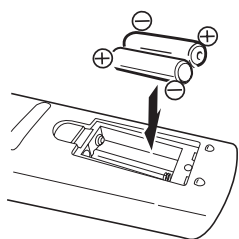

3. Close the battery cover on the remote control until the lock snaps.

### Using the remote control to operate your other devices

#### To control a cable TV converter/satellite receiver:

Program the remote control to recognize the brand of your cable TV converter/satellite receiver (see "Programming the remote control to operate your other devices" on page 18.) The buttons shown at right will control the cable TV converter/satellite receiver. Press "CBL/SAT" first.

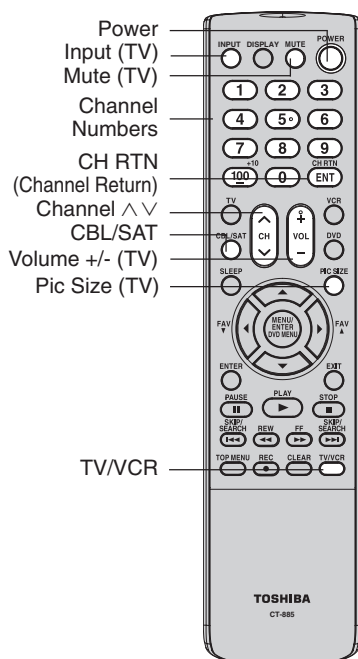

#### To control a VCR:

Program the remote control to recognize the brand of your VCR (see "Programming the remote control to operate your other devices" on page 18.) The buttons shown at right will then control the VCR. Press "VCR" first.

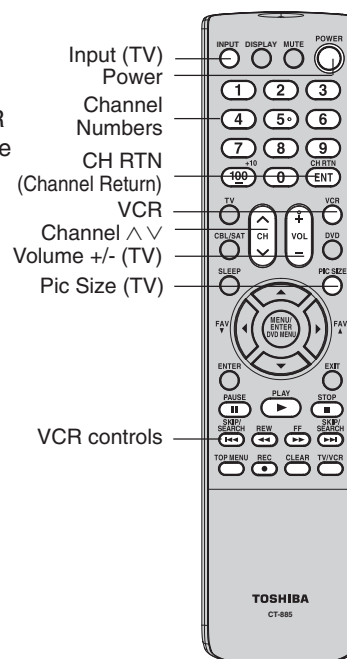

#### Note:

The TV remote control may not operate your VCR, DVD player, or cable TV converter. Refer to the owner's manual supplied with your other devices to see which features may be available. Additionally, the remote control for this TV may not support certain features available on the original remote controls for your other devices, in which case it is suggested that you use the original remote control for the applicable device.

#### Caution:

- Never throw batteries into a fire.

#### Notes:

- Be sure to use AAA size batteries.
- Dispose of batteries in a designated disposal area.
- Batteries should always be disposed of with the environment in mind. Always dispose of batteries in accordance with applicable laws and regulations.
- If the remote control does not operate correctly, or if the operating range becomes reduced, replace batteries with new ones.
- When necessary to replace batteries in the remote control, always replace both batteries with new ones. Never mix battery types or use new and used batteries in combination.
- Always remove batteries from remote control if they are dead or if the remote control is not to be used for an extended period of time. This will prevent battery acid from leaking into the battery compartment.



### To control a DVD player:

Program the remote control to recognize the brand of your DVD player (see “Programming the remote control to operate your other devices” below.) The buttons shown at right will then control the DVD player. Press “DVD” first.

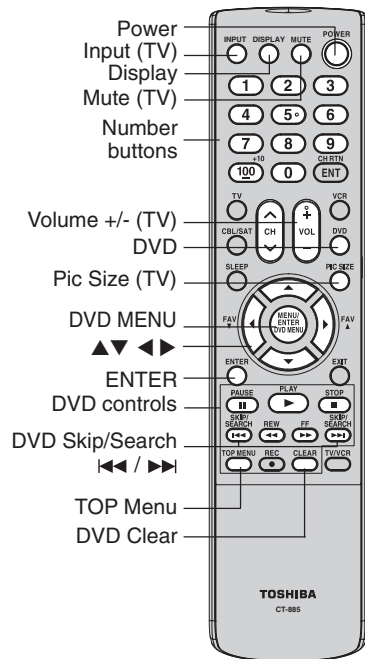

## Programming the remote control to operate your other devices

This remote control is pre-programmed to operate most Toshiba satellite receivers, VCRs, and DVD players. To control a non-Toshiba device (or a Toshiba device that the remote control is not pre-programmed to operate), you must follow the steps below to program your remote control.

1. Refer to the code tables (on pages 19 and 20) to find the corresponding code for your device.  
If more than one code is listed, try each one separately until you find the one that works.
2. If you are programming the remote control to operate your:
  - Cable TV converter/satellite receiver: Press “CBL/SAT.”
  - VCR: Press “VCR.”
  - DVD player: Press “DVD.”
3. While holding down DISPLAY, press the Channel Number buttons to enter the three-digit code for your device within 10 seconds.  
**Note:** If you do not enter the code within 10 seconds from step 3, or if you enter the wrong code, this operation is canceled.
4. Point the remote control at the cable TV converter/satellite receiver, VCR or DVD player, and press POWER to test the code.
  - If the device responds, you entered the correct code.
  - If the device does not respond, repeat steps 1–4 using another code.
5. Press “TV” to control the TV.

For future reference, write down the codes you used:

Cable TV converter/satellite receiver code \_\_\_\_\_

VCR code \_\_\_\_\_

DVD player code \_\_\_\_\_

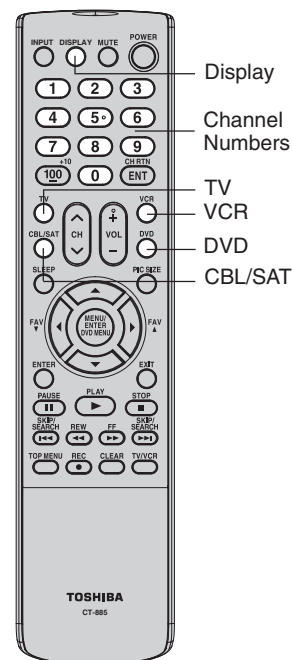

### Notes:

- When shipped from the factory, the remote control is set to operate your TV.
- Each time you replace the batteries, you must reprogram the remote control.
- Some newer VCRs are capable of working on either of two remote codes. These VCRs have a switch labeled “VCR1/VCR2.” If your VCR has this kind of switch and does not respond to any of the codes for your VCR, set the switch to the other position (VCR1 or VCR2) and reprogram the remote control.



## Cable TV converter/satellite receiver, VCR and DVD player code tables

[For CBL/SAT Mode]

### CABLE Box

Brand	Code	Brand	Code	Brand	Code
ABC	061, 062, 063, 082, 084, 087, 091, 092, 096, 098	Jerrold	062, 069, 071, 082, 086, 089, 091, 096	Scientific Atlanta	063, 078, 079, 080, 088, 098, 101, 105
Archer	065, 092, 097, 099	Magnavox	072, 096	Sears	095
Cableview	064, 094	Memorex	091, 092, 104	Signature	062
Century	092	Multi Canal	090	Signature 2000	096
Citizen	090, 092, 097	Novavision	101	Sprucer	081, 085
Contec	083, 085, 086, 088, 093, 098	Panasonic	081, 083, 085	Starcom	069, 082, 087, 096, 103, 104
Diamond	093	Philco	087	Stargate	069, 090
Eagle	091	Philips	066, 067, 068, 070, 072, 073, 074, 075, 091, 092	Sylvania	095, 100
GE	061, 062	Pioneer	076, 077	TeleView	090
Gemini	069, 070, 094	Proscan	061, 062	Texscan	100
General Instruments	062, 089, 096	Radio Shack	092, 097, 099	Tocom	071, 084, 085
Hamlin	093	RCA	064, 081	U. S. Electronics	087, 096, 098
Hitachi	062, 095, 096	Realistic	065	United Cable	082
Jasco	097	Recoton	102	Universal	065, 092, 097, 099, 102, 103
		Samsung	077, 090	Wards	096

### Satellite

Brand	Code	Brand	Code	Brand	Code
Alphastar	038, 059	Hughes Network Systems	019	Realistic	030
Chaparral	034	Intersat	048	Samsung	059
DISH Network	057	Janeil	027	Sony	014, 055
Drake	020, 040, 044, 046, 050, 053	JVC	017, 057	Star Choice	057
Echostar	018, 041, 051	Kenwood	029	Star Trak	025, 026, 037, 054
Express Vu	057	Magnavox	060	STS	024
Fujitsu	027	Optimus	058	Toshiba	000, 001, 002, 003, 004, 005, 006, 007, 020, 031, 056
GE	008, 009, 013	Pansat	036, 052	Uniden	021, 028, 030, 032, 035, 039, 043, 045, 047, 058
General Instruments	010, 011, 012, 022, 023, 031, 049	Primestar	015, 042	Zenith	027
Hitachi	033	Proscan	008, 009, 013		
Hughes	033	Radio Shack	022, 023, 030		
		RCA	008, 009, 013, 016		

[For VCR Mode]

### VCR

Brand	Code	Brand	Code	Brand	Code
Admiral	049	Fuji	004, 041	Marantz	005, 006, 007, 012, 014, 026, 053, 067
Aiko	019	Funai	018, 073	Memorex	007, 009, 010, 016, 018, 034, 049, 063, 065, 066, 068, 075, 079
Aiwa	018	Garrard	018	MGA	020, 028, 039
Akai	003, 004, 037, 038, 039, 058, 069	GE	001, 002, 009, 040, 042, 048, 056	MGN	056
Audiovox	010	Go Video	056, 059, 061, 081	Minolta	024, 025, 035, 063
Bell & Howell	007, 068	Goldstar	005, 010, 014, 054, 056, 065, 067	Mitsubishi	020, 024, 025, 028, 039, 043, 065
Broksonic	008, 017	Gradiente	018, 065	Montgomery Ward	049
Calix	010	Harman Kardon	005	Motorola	049
Carver	026	Hitachi	024, 025, 035, 037, 042, 063, 070, 080	MTC	009, 046, 061
CCE	019	JBL	076	Multitech	009, 012, 018
Citizen	009, 010, 011, 012, 013, 014, 015, 019, 057, 073	JC Penney	005, 006, 007, 008, 009, 010, 023, 024, 025, 026, 035, 056, 061, 063, 065	NEC	005, 006, 007, 012, 014, 037, 043, 053, 054, 067, 070
Colortyme	005	Jensen	024, 025, 037	Nikko	010
Craig	009, 010, 016, 061, 065, 079	JVC	005, 006, 007, 014, 037, 043, 062, 063, 068, 082	Noblex	009
Curtis Mathes	001, 005, 009, 012, 014, 040, 048, 053, 056, 057	Kenwood	005, 006, 007, 012, 014, 037, 043, 053, 068, 071	Optimus	010, 049, 065
Daewoo	011, 013, 015, 017, 018, 019, 057, 078	Kodak	010	Optonica	031
Daytron	078	LG	010	Orion	054, 057, 062, 065, 068, 072
Denon	063	Lloyds	053, 073, 079	Panasonic	036, 045, 046, 057, 061, 072, 079
Dimensia	001, 048	Logik	061	Pentax	012, 024, 025, 035, 042, 053, 063
Electrohome	010, 020, 065	LXI	010	Pentex Research	014
Emerson	003, 008, 010, 011, 017, 018, 020, 028, 039, 054, 057, 062, 065, 068, 072	Magnasonic	061, 065, 078	Philco	026, 027, 063
Fisher	007, 016, 021, 022, 023, 057, 064, 068, 070, 071, 079	Magnavox	026, 027, 034, 044, 057, 061, 072	Philips	026, 031, 044, 057
				Pioneer	006, 024, 043, 055



### VCR (Continued)

Brand	Code	Brand	Code	Brand	Code
Portland	012, 013, 015	Sanyo	007, 009, 016, 054, 064, 068, 071, 075, 079, 085	Tashiko	010
Proscan	001, 002, 048			Tatung	037
Proton	061			Teac	018, 029, 037
Quasar	045	Scott	008, 011, 017, 028, 030, 057, 065, 072	Technics	036
Radio Shack	010, 031, 065			Teknika	010, 018, 065
Radio Shack/Realistic	007, 009, 010, 016, 018, 020, 021, 022, 031, 049	Sears	007, 010, 016, 021, 022, 023, 024, 025, 035, 053, 057, 063, 064, 065, 068, 071, 075, 079	Toshiba	000, 011, 021, 023, 024, 028, 030, 039, 057, 074, 078, 079
Radix	010			Totevision	009, 010, 065
RCA	001, 002, 003, 009, 024, 025, 029, 035, 040, 042, 045, 048, 055, 056, 063, 071, 083	Sharp	013, 020, 031, 049, 051, 060, 066	Unitec	073
		Shintom	004, 025, 032, 061	Unitech	009
Realistic	007, 009, 010, 011, 016, 018, 020, 021, 022, 031, 049, 051, 056, 060, 065, 075, 079	Signature	049	Vector Research	005, 006, 011, 012, 053
		Signature 2000	075	Video Concepts	005, 006, 011, 012, 039, 053
		Singer	047, 061	Wards	009, 010, 011, 016, 018, 020, 024, 025, 031, 035, 049, 051, 056, 057, 060, 065, 066, 079
Ricoh	047	Sony	004, 032, 033, 041, 052, 058, 070, 074, 076, 077, 080	White Westinghouse	073
Runco	034	STS	035	XR-1000	018
Samsung	009, 011, 038, 056, 073, 084	Sylvania	018, 026, 027, 028, 044, 072	Yamaha	005, 006, 007, 014, 037, 053
Sansui	006, 037, 043, 061	Symphonic	018, 051, 053, 073, 079	Zenith	004, 032, 034, 041, 047, 069, 086
		Tandy	007		

### TV/VCR Combo

Brand	Code	Brand	Code	Brand	Code
Action	078	Precision	078	Toshiba	057
GE	059, 062	Quasar	065	Zenith	065
Goldstar	065	Realistic	079	Totevision	009, 010, 065
Panasonic	065	Sony	074		

### [For DVD Mode] DVD

Brand	Code	Brand	Code	Brand	Code
Aiwa	006, 015	Kenwood	037	Sampo	060
Apex	016, 017	Konka	008, 009	Samsung	061, 062, 086, 090
BOSE	097	Magnavox	004, 038	Sansui	073
Broksonic	018	Memorex	039	Sanyo	063, 091
Clarion	019	Mintek	040	Sharp	064, 067
Classic	020	NAD	026	Sherwood	074
Daewoo	021	Nakamichi	041	Sony	011, 012, 065, 066, 068, 069, 070
Denon	022, 023, 024, 025	Norcent	043		
Emerson	026, 027	Onkyo	044	Sylvania	027
Fisher	028	Oritron	058	Teac	071
Funai	027	Panasonic	010, 045, 046, 047, 048, 049, 050	Technics	072
GE	001, 029, 030			Techwood	075
Go Video	087	Philips	004, 051	Toshiba	000, 013, 076, 077, 078
GPX	031	Pioneer	052, 053, 054, 055	Yamaha	079, 080, 081
Hitachi	005, 032, 033, 034, 035	Proscan	001, 056	Zenith	014, 082, 092
JVC	003, 007, 036, 042, 088	Qwestar	057, 058		
		RCA	001, 002, 059, 089		

### Portable DVD

Brand	Code	Brand	Code	Brand	Code
Aiwa	093	Panasonic	024, 096, 099	RCA	098
Audiovox	094, 095				

### HTIB

Brand	Code	Brand	Code	Brand	Code
Lasonic	083	Panasonic	084	Venturer	085

### [For VCR and DVD Mode] DVD/VCR Combo

Brand	VCR Code	DVD Code	Brand	VCR Code	DVD Code
Go Video	081	087	Samsung	084	090
JVC	082	088	Sanyo	085	091
RCA	083	089	Zenith	086	092

Setting up your TV



## Learning about the remote control

**POWER** turns the TV on and off

**SLEEP** programs the TV to turn off at a set time (page 34)

**INPUT** selects the video input source (page 30)

**CH  $\wedge$  /  $\vee$**  cycles through programmed channels (page 23)

**TV** selects TV mode

**CBL/SAT** selects CBL/SAT mode (page 17)

**VCR** selects VCR mode (page 17)

**DVD** selects DVD mode (page 18)

**CHANNEL NUMBERS** allow direct access to channels (page 24)

**VOL +/-** adjusts the volume level

**CH RTN (Channel Return)** returns to the last viewed channel (page 24)

**MENU/ENTER** accesses the menu system; also sets menu selections (page 22)

**FAV  $\blacktriangle$  /  $\blacktriangledown$  (Favorite Channels)** cycles through the channels you programmed as favorite channels (page 24)

**MUTE** turns off the sound (page 37)

**DISPLAY** displays status information on-screen (page 39)

**EXIT** closes on-screen menus (page 22)

**PIC SIZE** cycles through the three picture sizes: Natural, TheaterWide and full (page 32)

**STOP** stops a videotape/DVD

**REC** starts recording a videotape

**PLAY** plays a videotape/DVD

**FF** fast forwards a videotape/DVD

**REW** rewinds a videotape/DVD

**PAUSE** pauses a videotape/DVD

**TV/VCR** toggles between TV and VCR modes when viewing while recording

**DVD SKIP/SEARCH  $\ll$   $\gg$**  skips DVD chapter

**DVD CLEAR** clears input data in DVD mode

**TOP MENU** access the DVD TOP menu

**DVD MENU** access the DVD menu

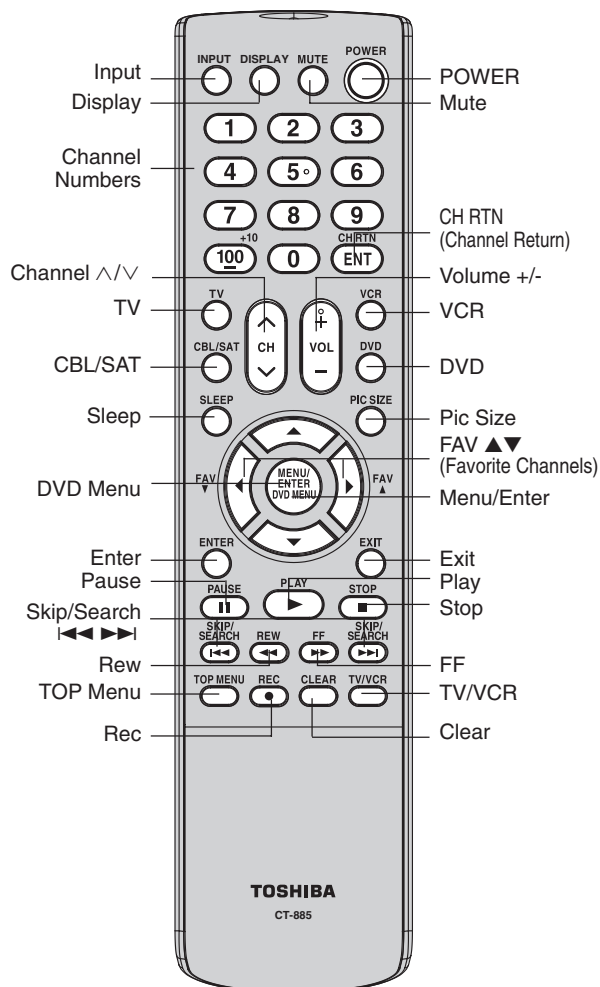

- Aim the remote control at the remote sensor and press control buttons to operate.
- Operate the remote control within a 30 degree angle on either side of the remote sensor, up to a distance of approx. 16 ft. (5m).

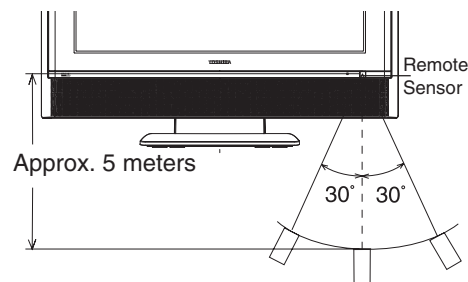

Introduction

Connecting your TV

Setting up your TV

Using the TV's Features

Appendix



## Starting setup

The STARTING SETUP feature appears the first time you turn on the TV, and helps you select the menu language, specify the TV/CABLE setting, and program channels automatically.

**IMPORTANT: Make sure that the antenna or cable TV system connection is made!**

1. Press TV to select the TV mode.
2. Press POWER to turn on the TV. The starting setup function begins and the language setup menu appears on the screen. Press ▲ or ▼ to select your desired language, then press ENTER.
3. Press ▲ or ▼ to select "TV" or "CABLE", then press ENTER.
4. Press ▲ or ▼ to select "START", then press ENTER. If you select "CANCEL" and press ENTER, the STARTING SETUP stops and changes to the TV screen.
5. Now the "AUTO SETUP" starts. After the starting setup is completed, the TV channel appears on the screen.
  - If you press the EXIT button in the process of "AUTO SETUP" the STARTING SETUP stops and changes to the TV screen.

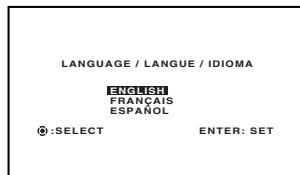

After you have installed the batteries and programmed the remote control, you need to set some preferences on the TV using the menu system. You can access the menu system with the buttons on the remote control.

- When you make a menu selection, your changes occur immediately. You do not have to press MENU or EXIT to see your changes.
- After one minute, the menu screen will automatically close if you do not make a selection. Your changes will still be saved.
- When you are finished programming the menus, press EXIT.

## Changing the on-screen display language

You can choose from three different languages (English, French and Spanish) for the on screen displays. Adjustment menus and messages will appear in the language of your choice.

### To select a language:

1. Press TV to select the TV mode.
2. Press MENU, then press ◀ or ▶ until the SETUP menu appears.

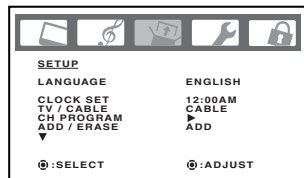

3. Press ▲ or ▼ to highlight LANGUAGE.

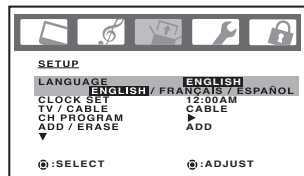

4. Press ◀ or ▶ to highlight your desired language.

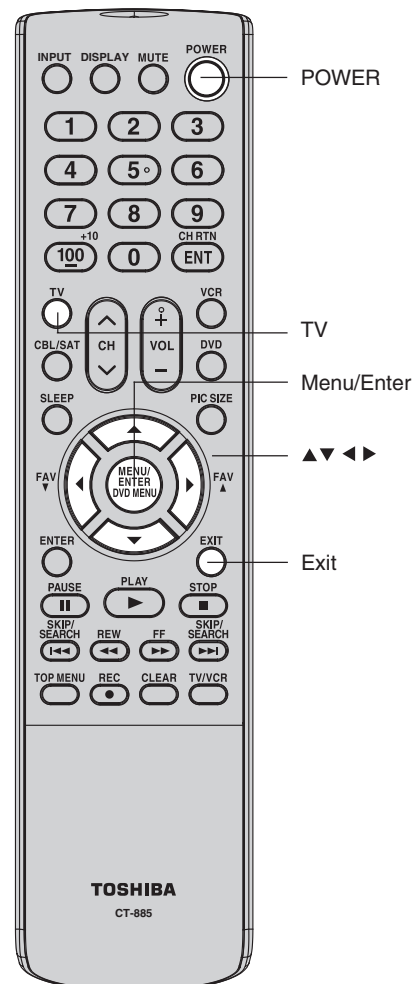

### Note:

The position and size of the on-screen menus change for some program formats (such as 1080i or 720p).

### Note:

If the remote control does not operate your TV, press the "TV" button on the remote control and try again.



## Adding channels to the TV's memory

When you press CH  $\wedge$  or  $\vee$ , your TV will stop only on the channels you have stored in the TV's channel memory. Follow the steps below to program channels into the channel memory.

### Programming channels automatically

Your TV can automatically detect all active channels and store them in its memory. After the TV has stored the channels in its memory automatically, you can add or erase channels manually.

#### To add channels automatically:

1. Press TV to select the TV mode.
2. Press MENU, then press  $\blacktriangleleft$  or  $\blacktriangleright$  to display the SETUP menu.
3. Press  $\blacktriangle$  or  $\blacktriangledown$  until the TV/CABLE selection is highlighted.
4. Press  $\blacktriangleleft$  or  $\blacktriangleright$  to highlight either TV or CABLE, depending on which you use.  
If you use an antenna, choose TV.  
If you use cable, choose CABLE.
5. Press  $\blacktriangledown$  until the CH PROGRAM selection is highlighted.
6. Press  $\blacktriangleright$  to start channel programming. The TV will automatically cycle through all the TV or Cable channels (depending on which you selected), and store all active channels in the channel memory. While the TV is cycling through the channels, the message "PROGRAMMING NOW-PLEASE WAIT" appears.
7. When channel programming is complete, the message "COMPLETED" appears.
8. Press CH  $\wedge$  or  $\vee$  to view the programmed channels.

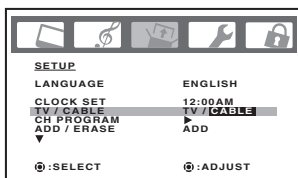

### Adding and erasing channels manually

After you have programmed the channels automatically, you can add or erase specific channels manually.

#### To add or erase channels manually:

1. Press TV to select the TV mode.
2. Select the channel you want to add or erase. If adding channels, you must select the channel to add using the Channel Number buttons.
3. Press MENU, then press  $\blacktriangleleft$  or  $\blacktriangleright$  to display the SETUP menu.
4. Press  $\blacktriangle$  or  $\blacktriangledown$  to highlight ADD/ERASE.
5. Press  $\blacktriangleleft$  or  $\blacktriangleright$  to select ADD or ERASE, whichever function you want to perform.
6. Repeat steps 1-5 for other channels you want to add or erase.

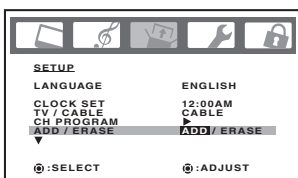

### Changing channels

#### To change to the next programmed channel:

Press Channel  $\wedge$  /  $\vee$  on the TV or CH  $\wedge$  /  $\vee$  on the remote control.

#### To change to a specific channel (programmed or unprogrammed):

Press the Channel Number buttons (0-9 and 100) on the remote control. For example, to select channel 125, press 100, 2, 5.

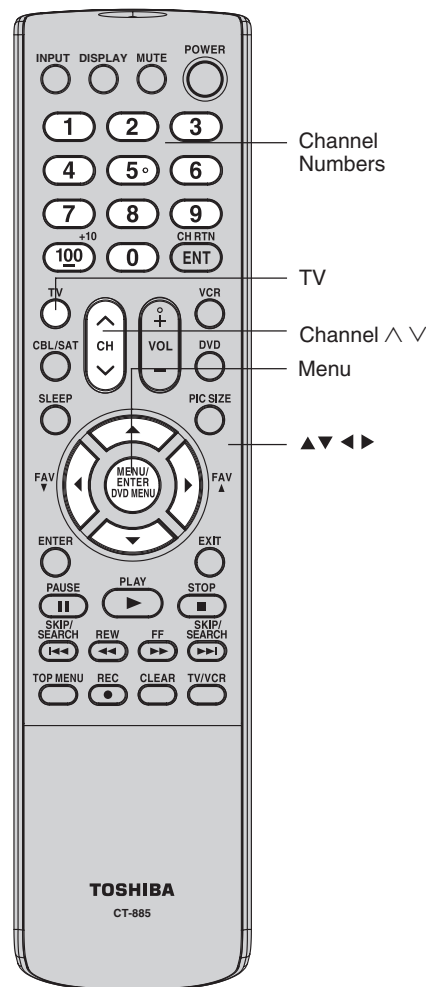

In addition to cycling through your programmed channels, the Channel  $\wedge$  /  $\vee$  buttons will also cycle through the video input sources (page 30) in the order illustrated below.

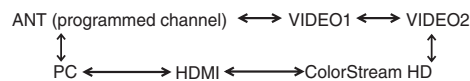

#### Note:

If the remote control does not operate your TV, press the "TV" button on the remote control and try again.

Introduction

Connecting your TV

Setting up your TV

Using the TV's Features

Appendix



## Using the TV's features

### Adjusting the channel settings

#### Switching between two channels

You can switch between two channels without entering an actual channel number each time.

##### To switch between two channels:

1. Press TV to select the TV mode.
2. Select the first channel you want to view.
3. Select a second channel using the Channel Number buttons (0-9, 100).
4. Press CH RTN. The previous channel will be displayed.

Each time you press CH RTN, the TV will switch back and forth between the two channels.

#### Programming your favorite channels

You can preset up to 12 of your favorite channels using the Favorite Channel Programming feature. Because this feature scans through only your favorite channels, it allows you to skip other channels you do not normally watch.

You can still use Channel  $\wedge$  /  $\vee$  to scan through all the channels you programmed in the TV's memory.

##### To program your favorite channels:

1. Press TV to select the TV mode.
2. Select a channel you want to program.
3. Press MENU, then press  $\blacktriangleleft$  or  $\blacktriangleright$  to display the OPTION menu.
4. Press  $\blacktriangle$  or  $\blacktriangledown$  to highlight FAVORITE CH.

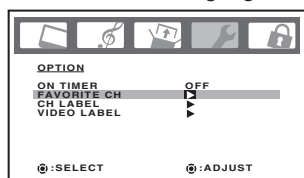

5. Press  $\blacktriangleright$  to display the FAVORITE CH menu. SET/CLEAR will be highlighted.

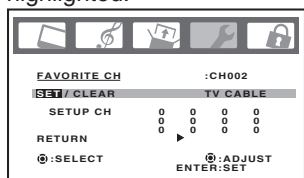

6. Press  $\blacktriangleleft$  or  $\blacktriangleright$  to highlight SET and press ENTER.
7. Press EXIT to return to normal viewing.
8. Repeat steps 1-7 for up to 12 channel.

##### To select your favorite channels:

Press the FAV  $\blacktriangle$  /  $\blacktriangledown$  buttons on the remote control to select your favorite channels.

The FAV  $\blacktriangle$  /  $\blacktriangledown$  buttons will not work until you have programmed your favorite channels.

##### To clear your favorite channels:

1. Press TV to select the TV mode.
2. Select a channel you want to clear.
3. Press MENU, then press  $\blacktriangleleft$  or  $\blacktriangleright$  to display the OPTION menu.
4. Press  $\blacktriangle$  or  $\blacktriangledown$  to highlight FAVORITE CH.
5. Press  $\blacktriangleright$  to display the FAVORITE CH menu. SET/CLEAR will be highlighted.
6. Press  $\blacktriangleleft$  or  $\blacktriangleright$  to highlight CLEAR.

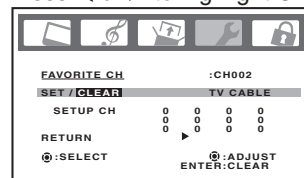

7. Press ENTER until "0" replaces the channel number you want to erase.
8. Press EXIT to return to normal viewing.
9. Repeat steps 1-8 for the other channels.

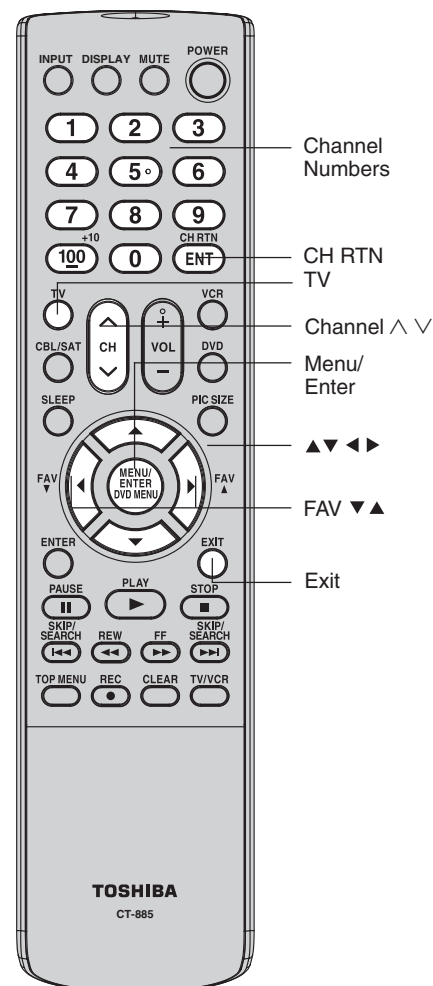

#### Note:

If the remote control does not operate your TV, press the "TV" button on the remote control and try again.







## Using the V-Chip (parental control) feature

The Motion Picture Association of America (MPAA) uses a rating system to qualify motion picture content. Television broadcasters employ a rating system to qualify the content of television programs, as well. The TV and MOVIE ratings work with the V-Chip feature and allow you to block programs according to the rating limits you set.

### To use the V-Chip to block programs by rating:

1. Press TV to select the TV mode.
2. Press MENU, then press ◀ or ▶ to display the LOCKS menu.
3. Press ▲ or ▼ to display the password entering mode.
4. Use the Channel Number buttons (0-9) to enter your password. Press ENTER. The LOCKS menu appears.
5. Press ▲ or ▼ to highlight V-CHIP.
  - Press ◀ or ▶ to highlight ON to enable V-Chip program blocking by rating.
  - Press ◀ or ▶ to highlight OFF to disable V-Chip program blocking by rating.
6. Press ▲ or ▼ to highlight TV RATING. Then, press ◀ or ▶ to display the desired rating.

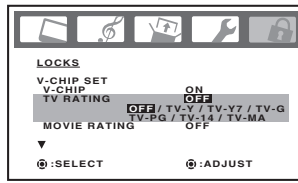
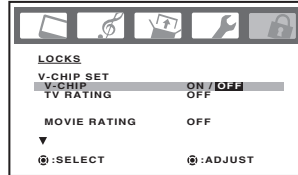

- OFF** : TV RATING is not set
- TV-Y** : All children
- TV-Y7** : 7 years old and above
- TV-G** : General audience
- TV-PG** : Parental guidance
- TV-14** : 14 years old and above
- TV-MA** : 17 years old and above
- When you select TV-Y7, TV-PG, TV-14 or TV-MA, press DISPLAY to explain the rating. Press ▲ or ▼ to select the desired rating you want. Press ◀ or ▶ to select the setting "ON" or "OFF", then press ENTER.

7. Press ▲ or ▼ to highlight MOVIE RATING. Then, press ◀ or ▶ to display the desired rating.

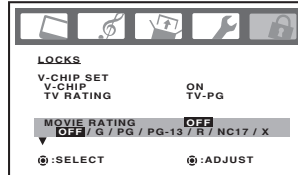

- OFF** : MOVIE RATING is not set (no movies will be blocked)
- G** : All ages
- PG** : Parental guidance
- PG-13** : Parental guidance less than 13 years old
- R** : Under 17 years old Parental guidance suggested
- NC17** : 17 years old and above
- X** : Adult only

8. When you are done selecting the ratings, press EXIT to return to normal viewing.

When you try to view a program with a ratings block, a message will appear listing the program's ratings. The program can still be viewed if you press MUTE and then enter your password to temporarily bypass the block.

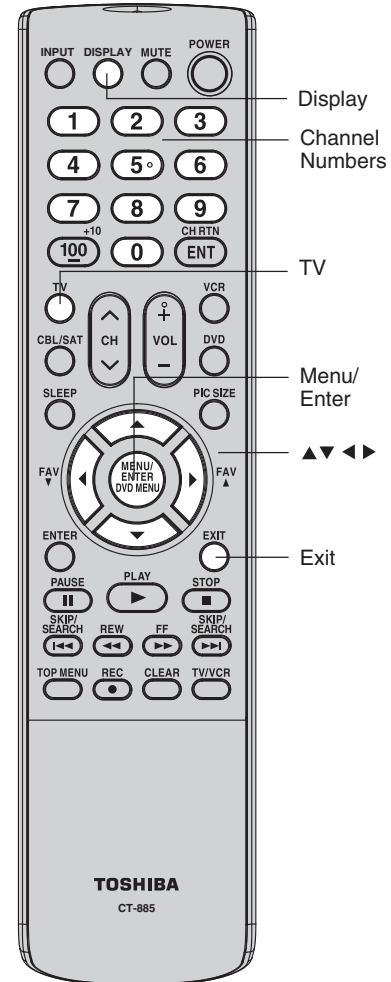

### Note:

If the remote control does not operate your TV, press the "TV" button on the remote control and try again.



## Locking channels

With the CH LOCK feature, you can lock specific channels. You will not be able to tune locked channels unless you clear the setting. You can choose to lock up to nine TV channels and nine cable channels.

1. Press TV to select the TV mode.
2. Use the Channel Number buttons (0-9 and 100) to display the television channel you wish to lock.
3. Press MENU, then press ◀ or ▶ to display the LOCKS menu.
4. Press ▲ or ▼ to display the password entering mode.

5. Use the Channel Number buttons (0-9) to enter your password, then press ENTER. The LOCKS menu appears.

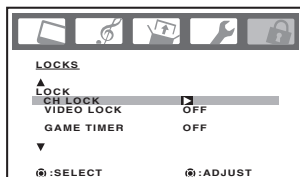

6. Press ▲ or ▼ to highlight CH LOCK and press ▶ to display the CH LOCK menu.

7. Press ◀ or ▶ to select the following:

- SET- to set the channel as one to be locked. Then press ENTER.
- CLEAR- to clear all channels from the list of locked channels. Then press ENTER.

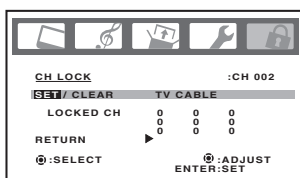

8. Repeat steps 1 through 7 to lock other channels. When you are finished locking channels, press EXIT to return to normal viewing.

If you try to tune a locked channel, the TV will not display it, but will display the nearest unlocked channel.

### To unlock channels:

1. Press TV to select the TV mode.
2. Press MENU, then press ◀ or ▶ to display the LOCKS menu.
3. Press ▲ or ▼ to display the password entering mode.
4. Use the Channel Number buttons (0-9) to enter your password, then press ENTER. The LOCKS menu appears.
5. Press ▲ or ▼ to highlight CH LOCK and press ▶ to display the CH LOCK menu.
6. Press ◀ or ▶ to highlight CLEAR and clear all channels from the list of locked channels. Press ENTER.
7. Press EXIT to return to normal viewing.

## Locking the video inputs

With the VIDEO LOCK feature, you can lock out the input sources (VIDEO1, VIDEO2, COLORSTREAM HD, HDMI, PC) and channels 3 and 4. You will not be able to select the input sources with the INPUT button or Channel buttons unless you clear the setting.

### To set up the video lock:

1. Press TV to select the TV mode.
2. Press MENU, then press ◀ or ▶ to display the LOCKS menu.
3. Press ▲ or ▼ to display the password entering mode.
4. Use the Channel Number buttons (0-9) to enter your password, then press ENTER. The LOCKS menu appears.
5. Press ▲ or ▼ to highlight VIDEO LOCK.

6. Press ◀ or ▶ to select:

- OFF: Unlocks all video input sources.
- VIDEO: Locks VIDEO1, VIDEO2, COLORSTREAM HD, HDMI, PC.
- VIDEO +: Locks VIDEO1, VIDEO2, COLORSTREAM HD, HDMI, PC, channel 3 and channel 4. This option should be used if you use the antenna terminal to play a video tape.

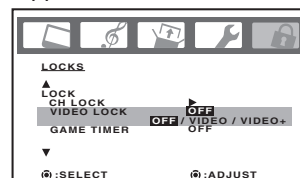

7. Press EXIT to return to normal viewing.

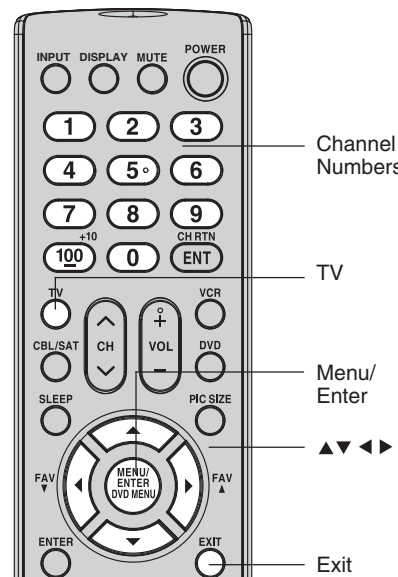

### Note:

After programming CH LOCK, change channels before turning off the television.

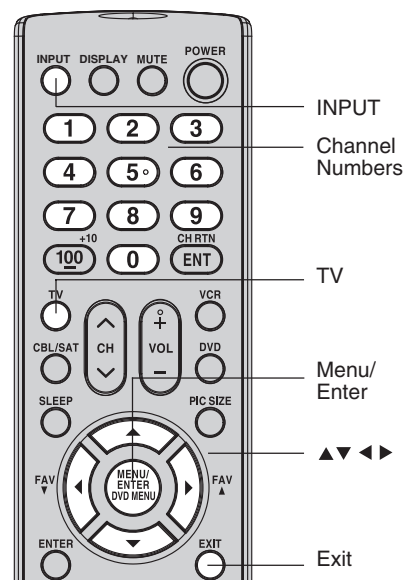

### Note:

After programming VIDEO LOCK, change channels or press the INPUT key before turning off the television.

### Note:

If the remote control does not operate your TV, press the "TV" button on the remote control and try again.

Introduction

Connecting your TV

Setting up your TV

Using the TV's Features

Appendix



### To unlock the video inputs:

1. Press TV to select the TV mode.
2. Press MENU, then press ◀ or ▶ to display the LOCKS menu.
3. Press ▲ or ▼ to display the password entering mode.
4. Use the Channel Number buttons (0-9) to enter your password, then press ENTER. The LOCKS menu appears.
5. Press ▲ or ▼ to highlight VIDEO LOCK and press ◀ or ▶ to highlight OFF.
6. Press EXIT to return to normal viewing.

### Setting the GameTimer™

With the GameTimer™ feature, you can automatically activate the VIDEO LOCK feature (VIDEO setting) to set a time limit for playing a video game (30, 60, 90 or 120 minutes).

#### To set up the GameTimer:

1. Press TV to select the TV mode.
2. Press MENU, then press ◀ or ▶ to display the LOCKS menu.
3. Press ▲ or ▼ to display the password entering mode.
4. Use the Channel Number buttons (0-9) to enter your password, then press ENTER. The LOCKS menu appears.
5. Press ▲ or ▼ to highlight GAME TIMER.
6. Press ◀ or ▶ to select a time limit (30 minutes, 60 minutes, 90 minutes, 120 minutes or OFF).
7. Press EXIT to return to normal viewing. After the GameTimer is programmed, the display will appear briefly every ten minutes to remind you that the GameTimer is operating.

When the programmed time is reached, the TV will change channels automatically and enter VIDEO LOCK mode.

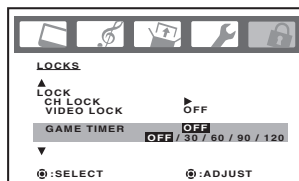

### Notes:

- Interactive video games that involve shooting a gun type of joy-stick at an on-screen target may not work on this TV.
- To deactivate the GameTimer, set the VIDEO LOCK to OFF (see "Locking the video inputs" page 27).

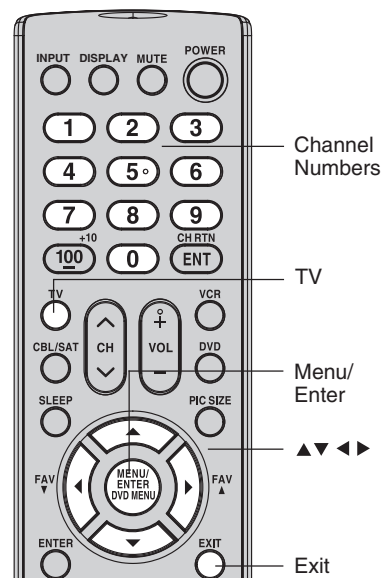

### Using the panel lock feature

You can lock the top panel buttons to prevent your settings from being changed accidentally (by children, for example). When the panel lock is in ON, all control buttons on the TV top panel (except POWER) do not operate.

#### To lock the panel:

1. Press TV to select the TV mode.
2. Press MENU, then press ◀ or ▶ to display the LOCKS menu.
3. Press ▲ or ▼ to display the password entering mode.
4. Use the Channel Number buttons (0-9) to enter your password, then press ENTER. The LOCKS menu appears.
5. Press ▲ or ▼ to highlight PANEL LOCK and press ◀ or ▶ to highlight ON.

If a button on the top panel is pressed, the message "NOT AVAILABLE" appears.

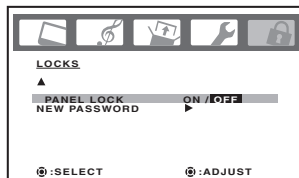

#### To unlock the panel:

Press and hold the VOLUME – button on the TV top panel for about 10 seconds until the message "PANEL LOCK:OFF" appears on-screen.

#### You also can unlock the panel using the menus:

1. Press TV to select the TV mode.
2. Press MENU, then press ◀ or ▶ to display the LOCKS menu.
3. Press ▲ or ▼ to display the password entering mode.
4. Use the Channel Number buttons (0-9) to enter your password, then press ENTER. The LOCKS menu appears.
5. Press ▲ or ▼ to highlight PANEL LOCK, and then press ◀ or ▶ to highlight OFF.

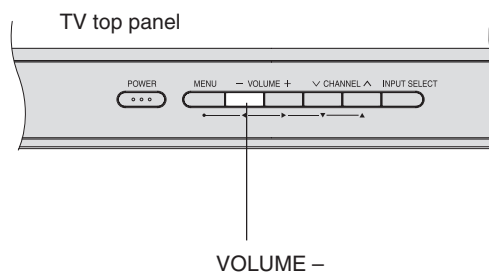

### Note:

If the remote control does not operate your TV, press the "TV" button on the remote control and try again.



## Labeling channels

Channel labels appear above the channel number display each time you turn on the TV, select a channel, or press the DISPLAY button. You can choose any four characters to identify a channel.

### To create channel labels:

1. Press TV to select the TV mode.
2. Select a channel you want to label.
3. Press MENU, then press ◀ or ▶ until the OPTION menu appears.
4. Press ▲ or ▼ to highlight CH LABEL.
5. Press ▶ to display the CH LABEL menu. SET/CLEAR will be highlighted.
6. Press ◀ or ▶ to highlight SET, then press ENTER.
7. Press ENTER to highlight LABEL.
8. Press ◀ or ▶ to enter a character in the first space. Press the button repeatedly until the character you want appears on the screen. Press ENTER.
9. Repeat step 8 to enter the rest of the characters.

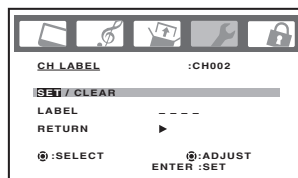
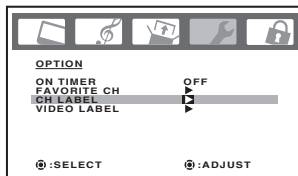

- If you would like a blank space in the label name, you must choose an empty space from the list of characters; otherwise, a dash will appear in that space.
10. Repeat steps 1-9 for other channels. You can assign a label to each channel.
  11. Press EXIT to return to normal viewing.

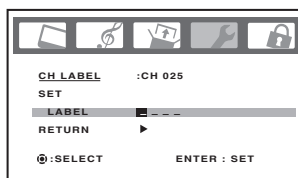

### Note:

The character will change as below.

- ↔ 0...9 ↔ A...Z  
↔ SPACE ↔ + ↔ -

### To erase channel labels:

1. Press TV to select the TV mode.
2. Select a channel with a label.
3. Press MENU, then press ◀ or ▶ until the OPTION menu appears.
4. Press ▲ or ▼ to highlight CH LABEL.
5. Press ▶ to display the CH LABEL menu. SET/CLEAR will be highlighted.
6. Press ◀ or ▶ to highlight CLEAR.
7. Press ENTER.
8. Repeat steps 1-7 to erase other channel labels.

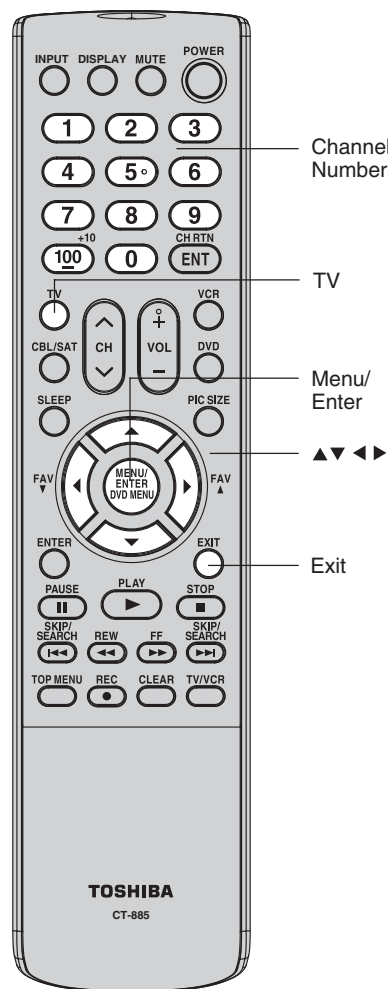

Introduction

Connecting your TV

Setting up your TV

Using the TV's Features

Appendix

### Note:

If the remote control does not operate your TV, press the "TV" button on the remote control and try again.

## Selecting the video input source

Press INPUT to view a signal from another device connected to your TV, such as a VCR or DVD player. You can select ANT, VIDEO 1, VIDEO 2, ColorStream HD, HDMI or PC depending on which input jacks you used to connect your devices (see "Connecting your TV" on page 9).

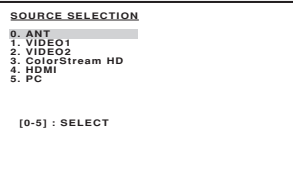

Pressing INPUT on the remote control displays the current signal source (press INPUT again or 0-5 to change)

You also can use the Channel  $\wedge$  /  $\vee$  buttons to select the video input source. In addition to cycling through your programmed channels (page 23), the Channel  $\wedge$  /  $\vee$  buttons will also cycle through the video input sources, in the order illustrated below.

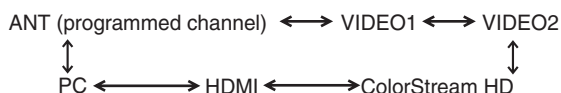

## Labeling the video input sources

The video label feature allows you to label each input source for your TV from the following preset list of labels:

- : Uses the default label name
- VCR : Video cassette recorder
- DVD : DVD video
- DTV : Digital TV set-top box
- SAT : Satellite box
- CBL : Cable box

### To label the video input sources:

1. Press TV to select the TV mode.
2. Press MENU, then press  $\leftarrow$  or  $\rightarrow$  to display the OPTION menu.
3. Press  $\blacktriangle$  or  $\blacktriangledown$  to highlight VIDEO LABEL.
4. Press  $\rightarrow$  to display the VIDEO LABEL menu.
5. Press  $\blacktriangle$  or  $\blacktriangledown$  to highlight the video source you want to label.
6. Press  $\leftarrow$  or  $\rightarrow$  to select the desired label for that input source.
7. Press EXIT to return to normal viewing.

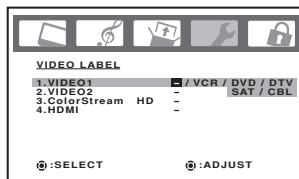
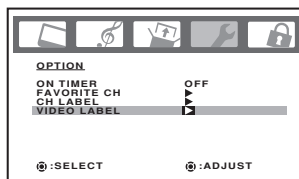

## Setting the clock

You must set the clock before you can program the ON timer.

### To set the clock: (Example: 8:30 AM)

1. Press TV to select the TV mode.
2. Press MENU, then press  $\leftarrow$  or  $\rightarrow$  to display the SETUP menu.
3. Press  $\blacktriangle$  or  $\blacktriangledown$  to highlight CLOCK SET.
4. Press  $\rightarrow$  to highlight the hour position.
5. Press  $\blacktriangle$  or  $\blacktriangledown$  to set the hour, then press  $\rightarrow$  to highlight the minute position.
6. Press  $\blacktriangle$  or  $\blacktriangledown$  to set the minutes, then press EXIT to return to normal viewing.

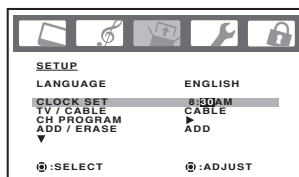
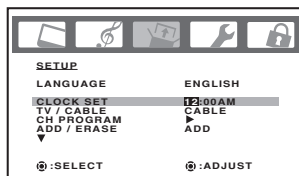

**Please note the following regarding the HDMI source selection:**

**The HDMI IN jack is not intended for connection to and should not be used with a PC (personal computer). See "Connecting an HDMI or a DVI device to the HDMI input" on page 15 and "Connecting a PC" on page 16 for details.**

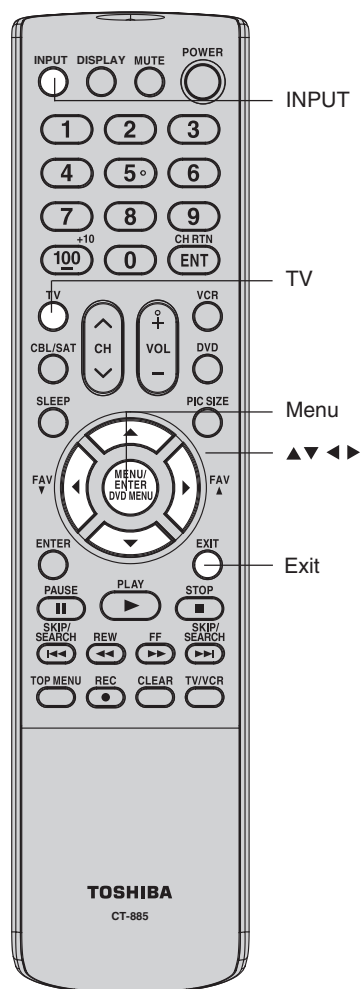

### Note:

If the power source for the TV is interrupted (for example, the power cord is unplugged or a power failure occurs), you will need to reset the clock.

### Note:

If the remote control does not operate your TV, press the "TV" button on the remote control and try again.



## Setting the ON timer

This feature allows you to program the TV to turn on automatically at a set time. If you program the ON TIMER to "DAILY," the TV will turn on every day at the same time to the same channel until you clear the ON TIMER.

**To set the on timer: (Example: Turning on the TV to channel 012 at 6:30 AM, DAILY)**

1. Press TV to select the TV mode.
2. Set the clock, if you have not already done so (see above).
3. Press MENU, then press ◀ or ▶ to display the OPTION menu.
4. Press ▲ or ▼ to highlight ON TIMER.
5. Press ◀ or ▶ to highlight SET, then press ENTER. The ON TIMER menu appears. Press ▶ to set the time.
6. Press ▲ or ▼ to set the desired hour, then press ▶.

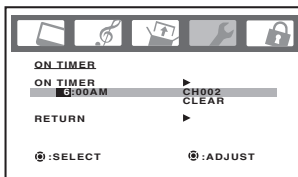

7. Set the desired minutes and channel, as in step 6.

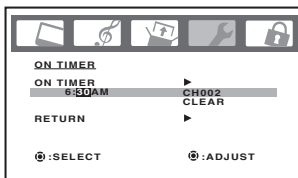

8. Press ▶ to select ONCE or DAILY.
9. Press EXIT to return to normal viewing.

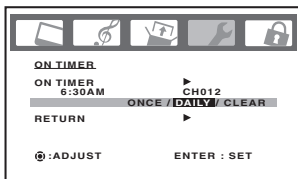

### To cancel the on timer:

Select CLEAR in step 8 above.  
Press EXIT to return to normal viewing.

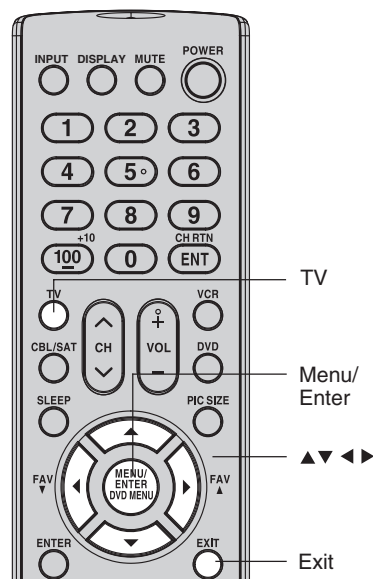

### Note:

After a power failure or disconnection of the power, the timer settings will be lost.

### Note:

If the remote control does not operate your TV, press the "TV" button on the remote control and try again.

Introduction

Connecting your TV

Setting up your TV

Using the TV's Features

Appendix



## Viewing the wide-screen picture formats (480i and 480p signals only)

You can view 480i and 480p format programs in a variety of picture sizes—Natural, TheaterWide, and Full.

The way the image displays in any of the picture sizes will vary depending on the format of the program you are viewing. Select the picture size that displays the current program the way that looks best to you.

### Selecting the picture size

1. Press TV to select the TV mode.
2. Press PIC SIZE on the remote control.
3. Press the corresponding number button (0-2) to select the desired picture size, as described below and on the next page.

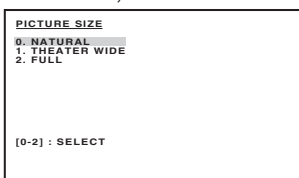

### Natural picture size

- The image is displayed close to its originally formatted proportion. Some program formats will display with side bars and/or bars at the top and bottom.

Natural picture size example: The way the image displays will vary depending on the format of the program you are currently watching.

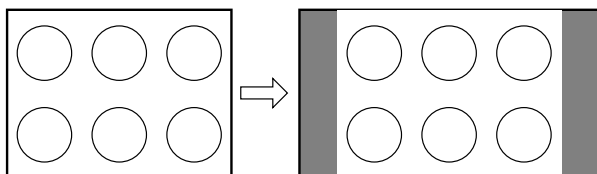

Conventional (4:3) picture on a conventional TV screen

Conventional (4:3) picture in Natural size on your wide-screen TV

### TheaterWide picture size (for 4:3 format programs)

- The center of the picture remains close to its original proportion, but the left and right edges are stretched wider to fill the screen.
- The top and bottom edges of the picture may be hidden.

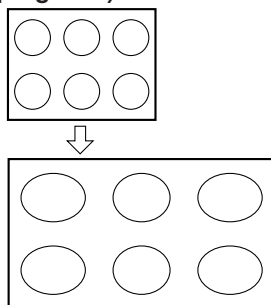

TheaterWide picture size example

### Full picture size (for 16:9 source programs)

- If receiving a 4:3 format program, the picture is stretched wider to fill the width of the screen, but not stretched taller.
- None of the picture is hidden.

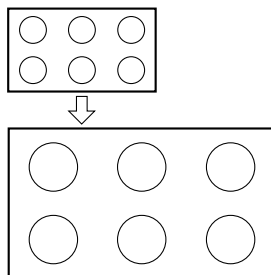

Full picture size example

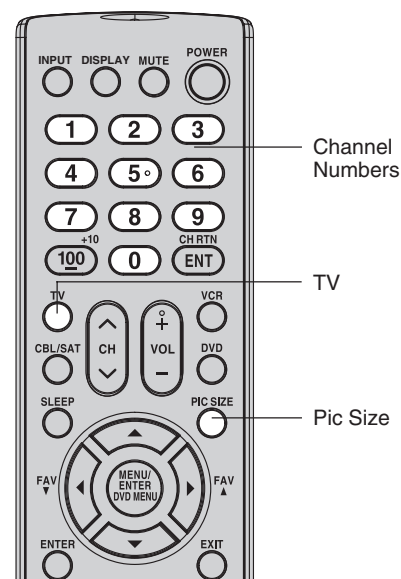

### Note:

You also can change the picture size by selecting PICTURE SIZE in the SETUP menu.

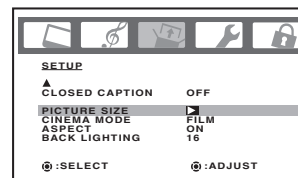

### Notes:

- The PICTURE SIZE feature is not available for some program formats (such as 1080i or 720p). Such formats will display in Full picture size.
- Using these functions to change the picture size (i.e., changing the height/ width ratio) for any purpose other than your private viewing may be prohibited under the Copyright Laws of the United States and other countries, and may subject you to civil and criminal liability.

### Note:

If the remote control does not operate your TV, press the "TV" button on the remote control and try again.





## Selecting the cinema mode

When you view a DVD movie (3:2 pull-down processed) from a DVD player connected to the ColorStream (component video) inputs on the TV, smoother and more natural motion can be obtained by setting the CINEMA MODE to FILM.

### To set the CINEMA MODE to FILM:

1. Press TV to select the TV mode.
2. Press MENU, then press ◀ or ▶ until the SETUP menu appears.
3. Press ▲ or ▼ to highlight CINEMA MODE, then press ◀ or ▶ to select FILM.

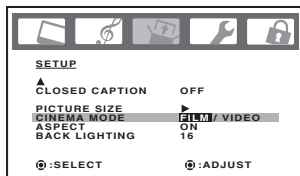

### To set the CINEMA MODE to VIDEO (off):

Press ◀ or ▶ to select VIDEO in step 3 above.

## Using the ASPECT feature

When the ASPECT feature is set to ON and the TV receives a 480i signal, the picture size is automatically selected (as described in the following table).

Aspect ratio of signal source	Automatic aspect size (automatically selected when ASPECT is ON)
4:3 Normal	Natural
16:9 Full	Full
4:3 Letter box	TheaterWide
Not defined	User-set mode

If the signal does not include aspect information, the picture size you selected on pages 32 is displayed.

### To turn on the ASPECT feature:

1. Press TV to select the TV mode.
2. Press MENU, then press ◀ or ▶ until the SETUP menu appears.
3. Press ▲ or ▼ to highlight ASPECT, then press ◀ or ▶ to select ON.

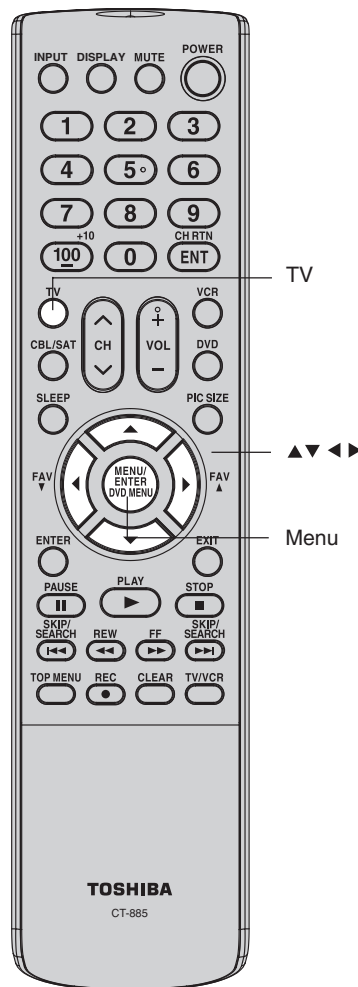
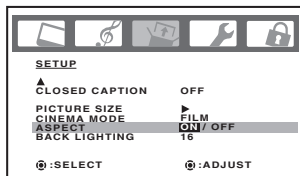

Introduction

Connecting your TV

Setting up your TV

Using the TV's Features

Appendix

### Note:

If the remote control does not operate your TV, press the "TV" button on the remote control and try again.



## Setting the sleep timer

You can set the TV so it turns off automatically.

### To set the sleep timer:

Repeatedly press SLEEP on the remote control to set the length of time until the TV turns off. The clock will increase 10 minutes for each press of the SLEEP button (0h00m, 0h10m, ... 1h50m, 2h00m). After the sleep timer is programmed, the display will appear briefly every ten minutes to remind you that the sleep timer is operating.

### To confirm the sleep timer setting:

Press SLEEP one time. The remaining time will be momentarily displayed.

### To cancel the sleep timer:

Repeatedly press SLEEP until the display turns to 0h00m.

## Using the closed caption feature

The Closed Caption feature has two options:

- Captions—An on-screen display of the dialogue, narration, and sound effects of programs and videos that are closed-captioned (usually identified in your local TV listing as “CC”).
- Text—An on-screen display of information not related to the program, such as weather or stock data (if available in your viewing area).

### To view captions or text:

1. Press TV to select the TV mode.
2. Tune the TV to the desired program.
3. Press MENU, then press ◀ or ▶ to display the SETUP menu.
4. Press ▲ or ▼ to highlight CLOSED CAPTION.

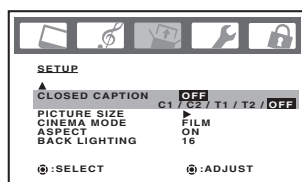

5. Press ◀ or ▶ to select the desired Closed Caption mode, as follows:
  - To view captions, select C1 or C2 (C1 displays translation of the primary language in your area).  
Note: If the program or video you selected is not closed-captioned, no captions will display on-screen.
  - To view text, select T1 or T2. Note: If text is not available in your viewing area, a black rectangle may appear on-screen. If this happens, set the Closed Caption feature to OFF.
  - To turn the Closed Caption feature off, highlight OFF in the Closed Caption menu.

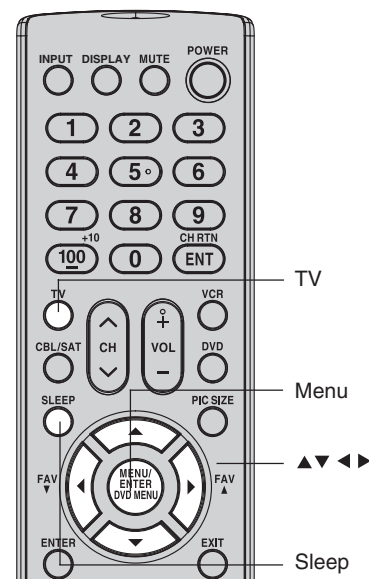

### Note:

A closed caption signal may not be decoded in the following situations:

- when a video tape has been dubbed
- when the signal reception is weak
- when the signal reception is non-standard

### Note:

If the remote control does not operate your TV, press the “TV” button on the remote control and try again.



## Adjusting the picture

### Selecting the picture mode

You can select four picture modes—Sports, Standard, Movie, and Memory—as described in the following table:

Mode	Picture Quality
SPORTS	Bright and dynamic picture (factory-set)
STANDARD	Standard picture quality (factory-set)
MOVIE	Movie-like picture setting (factory-set)
MEMORY	Your personal preferences (set by you; see “Adjusting the picture quality”)

#### To select the picture mode:

1. Press TV to select the TV mode.
2. Press MENU, then press ◀ or ▶ to display the PICTURE menu.
3. Press ▲ or ▼ to highlight MODE.

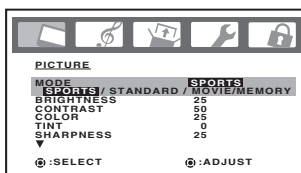

4. Press ◀ or ▶ to highlight the mode you prefer.
5. Press EXIT to return to normal viewing.

### Adjusting the picture quality

You can adjust the picture quality to your personal preferences, including the brightness, contrast, color, tint, and sharpness. The qualities you choose will be stored automatically in your TV's memory so you can recall them at any time.

#### To adjust the picture quality:

1. Press TV to select the TV mode.
2. Press MENU, then press ◀ or ▶ to display the PICTURE menu.
3. Press ▲ or ▼ until the item you want to adjust is highlighted.

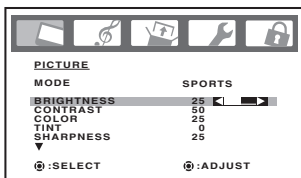

4. Press ◀ or ▶ to adjust the level.

Selection	◀ Pressing	▶
BRIGHTNESS	darker	lighter
CONTRAST	lower	higher
COLOR	paler	deeper
TINT	reddish	greenish
SHARPNESS	softer	sharper

5. Press EXIT to return to normal viewing.

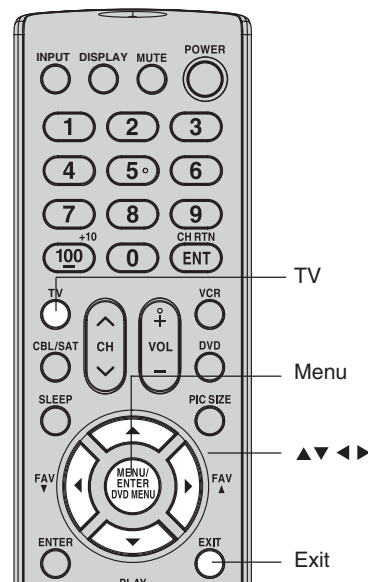
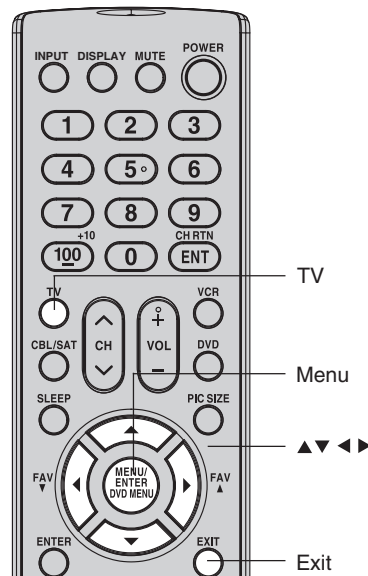

Introduction

Connecting your TV

Setting up your TV

Using the TV's Features

Appendix

#### Note:

If the remote control does not operate your TV, press the “TV” button on the remote control and try again.



## Using the CableClear® feature

CableClear® reduces visible interference in your TV picture. This is useful when receiving a broadcast with a weak signal (especially a Cable channel) or playing a video cassette or disc damaged by repeated use.

### To turn on the CableClear® feature:

1. Press TV to select the TV mode.
2. Press MENU, then press ◀ or ▶ to display the PICTURE menu.
3. Press ▲ or ▼ to highlight CableClear.

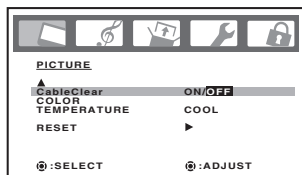

4. Press ◀ or ▶ to select ON.

### To turn off the CableClear® feature:

Select OFF in step 4.

## Selecting the color temperature

Change the picture quality by selecting from three preset color temperatures—cool, medium, and warm—as described in the following table:

Mode	Picture Quality
COOL	Blueish
MEDIUM	Neutral
WARM	Reddish

### To select the color temperature:

1. Press TV to select the TV mode.
2. Press MENU, then press ◀ or ▶ to display the PICTURE menu.
3. Press ▲ or ▼ to highlight COLOR TEMPERATURE.

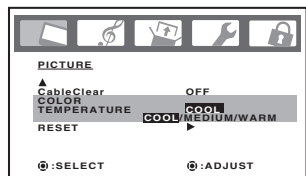

4. Press ◀ or ▶ to highlight the mode you prefer.
5. Press EXIT to return to normal viewing.

## Resetting your picture adjustments

The RESET function returns your picture quality adjustments to the following factory settings:

Mode .....	sports	Tint .....	center (0)
Brightness .....	center (25)	Sharpness .....	center (25)
Contrast .....	max (50)	Color temperature ..	cool
Color .....	center (25)		

### To reset your picture adjustments:

1. Press TV to select the TV mode.
2. Press MENU, then press ◀ or ▶ to display the PICTURE menu.
3. Press ▲ or ▼ to highlight RESET, and then press ▶.

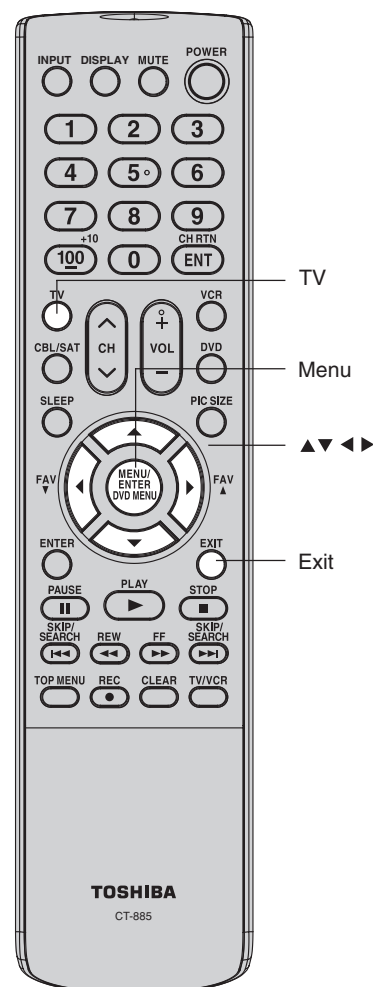
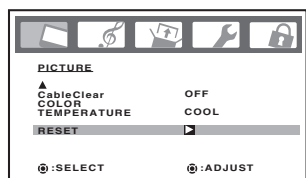

### Note:

If the remote control does not operate your TV, press the "TV" button on the remote control and try again.



## Adjusting the sound

### Muting the sound

Press MUTE to temporarily turn off the sound. While the sound is off, the screen will display the word MUTE in the lower right-hand corner. To restore the sound, press MUTE again.

### Selecting stereo/SAP broadcasts

The multi-channel TV sound (MTS) feature provides high-fidelity stereo sound. MTS also can transmit a second audio program (SAP) containing a second language or other audio information.

**Note:** The MTS feature is not available in VIDEO mode.

When the TV receives a stereo or SAP broadcast, the word "STEREO" or "SAP" displays on-screen every time you turn the TV on, change the channel, or press DISPLAY.

#### To listen to stereo sound:

1. Press TV to select the TV mode.
2. Press MENU, then press ◀ or ▶ to display the AUDIO menu.
3. Press ▲ or ▼ to highlight MTS.
4. Press ◀ or ▶ to highlight STR (stereo).

Notes:

- In general, you can leave your TV in stereo mode because the TV automatically outputs the type of sound being broadcast (stereo or mono).
- If the stereo sound is noisy, select MONO to reduce the noise.

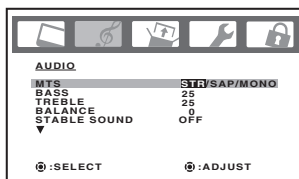

5. Press EXIT to return to normal viewing.

#### To listen to a second audio program (SAP):

1. Press TV to select the TV mode.
2. Press MENU, then press ◀ or ▶ to display the AUDIO menu.
3. Press ▲ or ▼ to highlight MTS.
4. Press ◀ or ▶ to highlight SAP. The TV speakers will output the second audio program instead of normal audio.
5. Press EXIT to return to normal viewing.

### Adjusting the sound quality

You can change the sound quality of your TV by adjusting the bass, treble, and balance.

#### To adjust the sound quality:

1. Press TV to select the TV mode.
2. Press MENU, then press ◀ or ▶ until the AUDIO menu appears.
3. Press ▲ or ▼ to highlight the item you want to adjust.

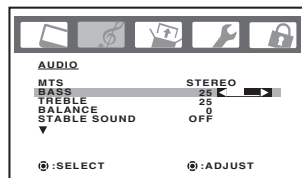

4. Press ◀ or ▶ to adjust the level.
  - ◀ makes the sound quality weaker or decreases the balance in the right channel, depending on the item selected.
  - ▶ makes the sound quality stronger or decreases the balance in the left channel, depending on the item selected.

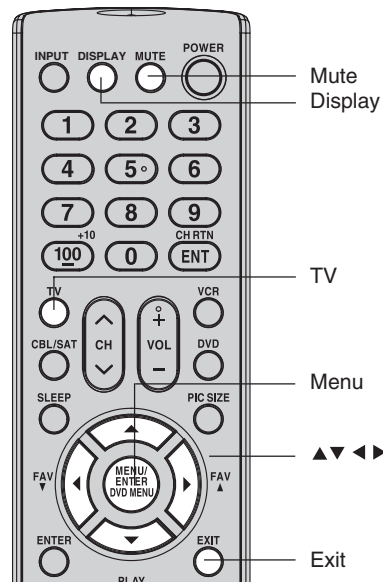

#### Note:

A second audio program (SAP) can be heard only on those TV stations that offer it.

For example, a station might broadcast music as a second audio program. If you have SAP on, you will see the current program on the screen but hear music instead of the program's normal audio.

However, if you have SAP on, and the station you are watching is not currently broadcasting a second audio program, the station's normal audio will be output; however, occasionally there is no sound at all in SAP mode. If this happens, set the MTS feature to STEREO mode.

#### Note:

Adjusting the sound quality (bass, treble and balance) does not affect the sound that is output from the headphone jack.

#### Note:

If the remote control does not operate your TV, press the "TV" button on the remote control and try again.

Introduction

Connecting your TV

Setting up your TV

Using the TV's Features

Appendix



### Resetting your audio adjustments

The RESET function returns the audio adjustments to the following factory settings:

- Bass .....center (25)
- Treble ..... center (25)
- Balance ..... center (0)

#### To reset your audio adjustments:

1. Press TV to select the TV mode.
2. Press MENU, then press ◀ or ▶ to display the AUDIO menu.
3. Press ▲ or ▼ to highlight RESET, and then press ▶.

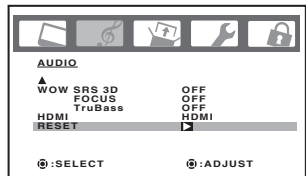

### Using the StableSound® feature

The StableSound feature limits the highest volume level to prevent extreme changes in volume when the signal source is changed.

#### To turn on the StableSound® feature:

1. Press TV to select the TV mode.
2. Press MENU, then press ◀ or ▶ to display the AUDIO menu.
3. Press ▲ or ▼ to highlight STABLE SOUND.
4. Press ◀ or ▶ to highlight ON.

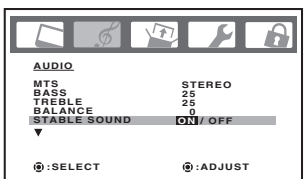

#### To turn off the StableSound® feature:

Highlight OFF in step 4 above.

### Using the WOW™ surround sound feature

WOW is a special combination of SRS Labs audio technologies that creates a thrilling surround sound experience with deep, rich bass from stereo sound sources. Your TV's audio will sound fuller, richer, and wider. WOW consists of three features; SRS 3D, FOCUS, and TruBass.

#### To adjust the WOW feature:

1. Press TV to select the TV mode.
2. Select STEREO mode (see "selecting stereo/SAP broadcasts" on page 37).
3. Press MENU, then press ◀ or ▶ to display the AUDIO menu.
4. Press ▼ or ▲ to highlight the desired WOW feature you want to adjust.
  - SRS 3D — To turn on or off the surround sound effect.
  - FOCUS — To turn on or off the vocal emphasis effect.
  - TruBass — To select your desired bass expansion level (HIGH, LOW or OFF).

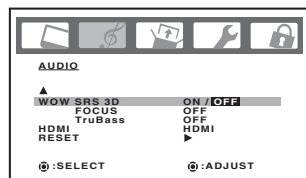

5. Press ◀ or ▶ to adjust the item.

WOW, SRS and (●) symbol are trademarks of SRS Labs, Inc. WOW technology is incorporated under license from SRS Labs, Inc.

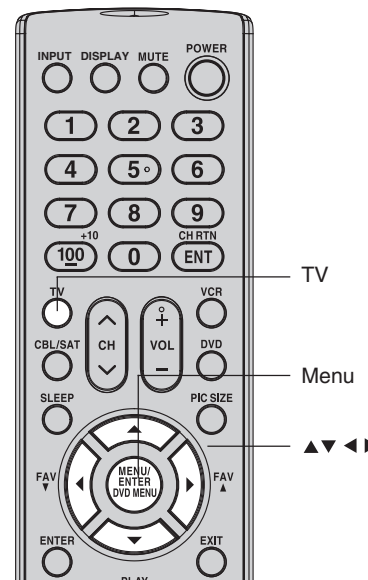

#### Notes:

- If the broadcast is monaural, the SRS 3D effect will not work.
- The headphone jack do not output any of the WOW audio features.

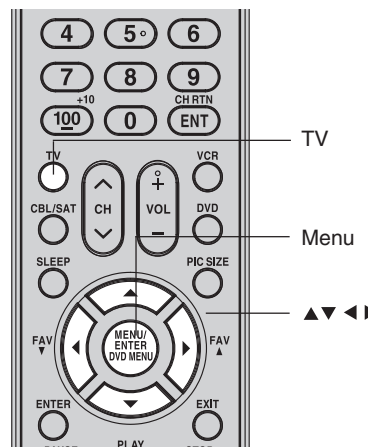

#### Note:

If the remote control does not operate your TV, press the "TV" button on the remote control and try again.

Using the TV's Features



### Selecting the HDMI audio input source

See page 15 for details on connecting an HDMI or a DVI device to the TV's HDMI input. If you connect a DVI device, to hear audio you must also connect the analog audio cables to the HDMI audio IN jacks (see page 15). Set the HDMI audio input setting to "DVI" with this connection.

If you connect an HDMI device and play media with digital audio output, to hear digital audio set the HDMI audio input setting to "HDMI" with this connection.

If you connect an HDMI device but play media with analog audio output (for example, certain CDVs do not output digital audio), to hear audio you must also connect the analog audio cables to the HDMI audio IN jacks (see page 15). Set the HDMI audio input setting to "DVI" with this connection.

#### To select the HDMI audio input source:

1. Press TV to select the TV mode.
2. Press MENU, then press ◀ or ▶ to display the AUDIO menu.
3. Press ▼ or ▲ to highlight HDMI.
4. Press ◀ or ▶ to select HDMI or DVI.

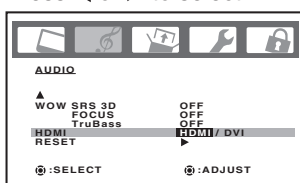

### Adjusting the back lighting feature

If your TV is in a bright room, the screen image may be difficult to see. You can use the BACK LIGHTING feature to adjust the screen brightness for improved picture clarity.

#### To adjust the back lighting:

1. Press TV to select the TV mode.
2. Press MENU, then press ◀ or ▶ until the SETUP menu appears.
3. Press ▲ or ▼ to highlight BACK LIGHTING.

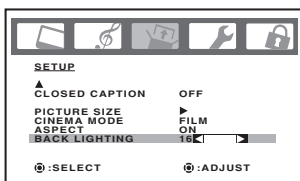

4. Press a ◀ or ▶ to adjust the screen brightness.

### Displaying on-screen information

Press DISPLAY to display the following on-screen information:

- Clock
- Channel number or Video input mode selected
- Channel label (if preset)
- Stereo or SAP (second audio program) audio status
- Content rating
- On timer, Sleep timer (if preset)
- Picture size

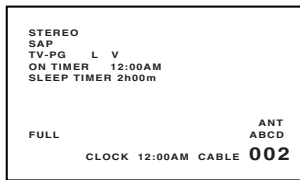

### Auto power off

The TV will automatically turn off after approximately 15 minutes if it is tuned to a vacant channel or a station that completes its broadcast for the day and stops broadcasting on that channel. This feature does not work in Video input/PC mode.

### Understanding the Power Return feature

If the power is cut off while you are viewing the TV and the power is resupplied, the Power Return feature will turn the TV on automatically.

If the power is going to be off for a long time or you are going to be away from home for a long time, unplug the power cord from the wall outlet to prevent the TV from turning on in your absence.

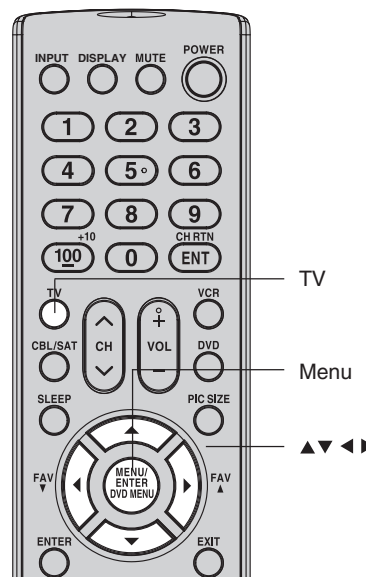

#### Note:

The cold cathode fluorescent lamp used for the back light on this TV has a limited life. When areas on the screen darken, flicker, or no longer light up, the lamp may be at the end of its life. Contact your nearest Toshiba Authorized Service Station.

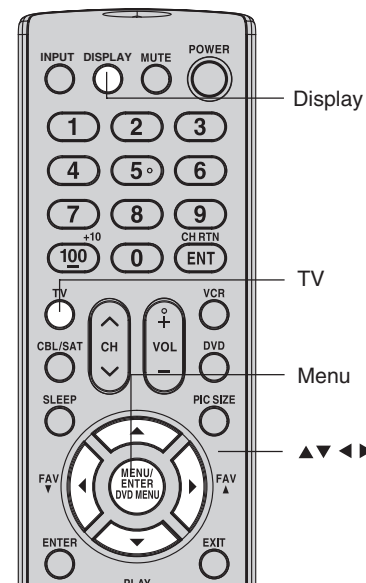

#### Note:

If the remote control does not operate your TV, press the "TV" button on the remote control and try again.

Introduction

Connecting your TV

Setting up your TV

Using the TV's Features

Appendix



## Picture/Audio adjustments in the PC mode

There are a number of picture settings you can adjust to optimize the performance of the unit in PC mode.

### PICTURE Menu

PICTURE	
BRIGHTNESS	25
CONTRAST	50
HOR POSITION	25
VER POSITION	25
PHASE	0
CLOCK	0
▼	
Ⓞ:SELECT	Ⓞ:ADJUST

### AUDIO Menu

AUDIO	
BASS	25
TREBLE	0
BALANCE	0
STABLE SOUND	OFF
WOW SRS 3D	OFF
WOW FOCUS	OFF
WOW TruBass	OFF
RESET	▶
▼	
Ⓞ:SELECT	Ⓞ:ADJUST

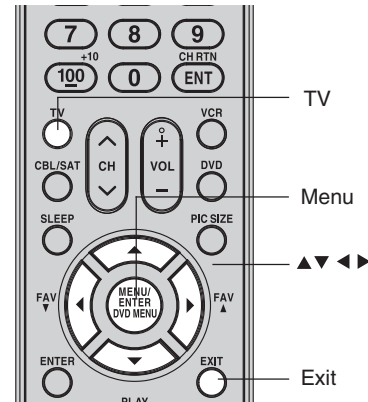

### Example: Adjust the contrast.

1. Press TV to select the TV mode.
2. During PC mode, press MENU, then press ◀ or ▶ to display the PICTURE menu.
3. Press ▲ or ▼ to select CONTRAST.
4. Press ◀ or ▶ to adjust CONTRAST.
5. Press EXIT to return to normal viewing.

### Notes:

- If you wish to change the on-screen language, follow the steps 1-4 on page 22.
- If no buttons are pressed for more than approx. 60 seconds, the PC Monitor Menu screen will return to normal Monitor screen automatically.
- The PC Monitor Menu settings are not effective for normal TV mode, DVD mode or external input mode.

## DESCRIPTION ABOUT EACH SETTING OPTION

### PICTURE menu

<b>BRIGHTNESS:</b>	To adjust the brightness of PC Monitor screen.
<b>CONTRAST:</b>	To adjust the contrast of PC Monitor screen.
<b>HOR POSITION:</b>	To adjust the horizontal position of the image on the PC Monitor screen. Each video standard will require a different value for this setting.
<b>VER POSITION:</b>	To adjust the vertical position of the image on the PC Monitor screen. Each video standard will require a different value for this setting.
<b>PHASE:</b>	This must be adjusted after the frequency has been set to optimize picture quality.
<b>CLOCK:</b>	To minimize any vertical bars or stripes visible on the screen background.
<b>RED/GREEN/BLUE:</b>	To adjust the color temperature of the PC Monitor screen.
<b>WXGA INPUT:</b>	Set to ON, when you select the WXGA mode on the PC.

### AUDIO menu

<b>BASS/STREBLE/BALANCE:</b>	To adjust the sound quality of PC mode.
<b>STABLE SOUND:</b>	To turn on or off the StableSound® feature in PC mode.
<b>WOW SRS 3D:</b>	To turn on or off the surround effect in PC mode.
<b>WOW FOCUS:</b>	To turn on or off the vocal emphasis effect in PC mode.
<b>WOW TruBass:</b>	To select your desired bass expansion level (HIGH, LOW or OFF) in PC mode.

## Resetting your picture/audio adjustments in the PC mode

The RESET function returns your picture quality adjustments to the following factory settings:

PICTURE menu	AUDIO menu
Brightness ..... center (25)	Bass ..... center (25)
Contrast ..... max (50)	Treble ..... center (25)
Red ..... center (25)	Balance ..... center (0)
Green ..... center (25)	
Blue ..... center (25)	

### To reset your picture adjustments:

1. Press TV to select the TV mode.
2. Press MENU during PC mode.
3. Press ◀ or ▶ to select the desired menu.
4. Press ▲ or ▼ to highlight RESET, and then press ▶.

### Note:

If the remote control does not operate your TV, press the "TV" button on the remote control and try again.





## Appendix

### Troubleshooting

Before calling a service technician, please check the following table for a possible cause of the symptom and some solutions.

Symptom	Solution
TV will not turn on	<ul style="list-style-type: none"> <li>Make sure the connection of the AC adapter and AC cord, then press POWER.</li> <li>The remote control batteries may be dead. Replace the batteries.</li> </ul>
No picture, no sound	<ul style="list-style-type: none"> <li>Check the antenna/cable connections.</li> </ul>
No sound, picture OK	<ul style="list-style-type: none"> <li>The sound may be muted. Press VOLUME.</li> <li>The station may have broadcast difficulties. Try another channel.</li> <li>The MTS feature may be in SAP mode. Select STR or MONO in the MTS menu.</li> </ul>
Poor sound, picture OK	<ul style="list-style-type: none"> <li>The station may have broadcast difficulties. Try another channel.</li> <li>The MTS feature may be in SAP mode. Select STR or MONO in the MTS menu.</li> </ul>
Poor picture, sound OK	<ul style="list-style-type: none"> <li>Check the antenna connections.</li> <li>The station may have broadcast difficulties. Try another channel.</li> <li>Adjust the PICTURE menu.</li> </ul>
Poor reception of broadcast channels	<ul style="list-style-type: none"> <li>The station may have broadcast difficulties. Try another channel.</li> <li>Check the antenna connections.</li> </ul>
Cannot receive above channel 13	<ul style="list-style-type: none"> <li>Make sure TV/CABLE is set to CABLE mode.</li> </ul>
Unable to select a certain channel	<ul style="list-style-type: none"> <li>The channel may be blocked by the V-Chip feature or CH LOCK feature, or erased with the add/erase feature.</li> </ul>
Cannot access signal input sources (Video1, Video2, ColorStream HD, HDMI and PC) and/or Channels 3 and 4	<ul style="list-style-type: none"> <li>Check the VIDEO LOCK feature.</li> </ul>
Multiple images	<ul style="list-style-type: none"> <li>The station may have broadcast difficulties. Try another channel.</li> <li>Use a highly directional outdoor antenna.</li> </ul>
Poor color or no color	<ul style="list-style-type: none"> <li>The station may have broadcast difficulties. Try another channel.</li> <li>Adjust the TINT and/or COLOR in the PICTURE menu.</li> </ul>
Black box on screen	<ul style="list-style-type: none"> <li>Select OFF in the Closed Caption menu to turn off the Closed Caption Text mode.</li> </ul>
No stereo or SAP sound from a known MTS broadcast	<ul style="list-style-type: none"> <li>Make sure the MTS feature is set properly (AUDIO menu).</li> </ul>
The V-Chip password does not work (U.S. V-Chip system only)	<ul style="list-style-type: none"> <li>Change or reset your password.</li> </ul>
The remote control does not operate	<ul style="list-style-type: none"> <li>Make sure the TV • CBL/SAT • VCR • DVD mode is set properly.</li> <li>Remove all obstructions between the remote control and the TV.</li> <li>The remote control batteries may be dead. Replace the batteries.</li> </ul>
The top panel buttons do not operate	<ul style="list-style-type: none"> <li>Check the PANEL LOCK feature.</li> </ul>

As with all products that contain a digital display, in rare instances, when viewing certain content (e.g., television broadcasts, video games, DVD), you may notice that the sound and picture are slightly out of sync. This phenomenon can be caused by various factors including, without limitation, video processing within the TV, video processing in an attached gaming system, and video processing/different compression rates used by broadcasters in their programming. You may want to try one or more of the following suggestions, which may help to reduce the effect of this phenomenon: Control-If the TV is connected to an A/V receiver that has a programmable audio delay feature, use this feature to help synchronize the sound to the picture.-If connected to a video game system and your TV has the Game Mode feature (see owner's manual for more information), enable this feature.-If you notice this phenomenon only on certain TV channels, please contact your local broadcast, cable, or satellite provider to inform them of this issue.



## Specifications

### Notes:

- This model complies with the specifications listed below.
- Designs and specifications are subject to change without notice.
- This model may not be compatible with features and/or specifications that may be added in the future.

LCD panel	20.04 inches (508.9 mm diagonal)(Screen size is approximate.)
Display method	Color TFT LCD
Number of pixels	1366 (Horizontal) x 768 (Vertical)
Television system	NTSC standard
Tuner type	F-Synth
Channel coverage	VHF: 2 – 13 UHF: 14 – 69 Cable TV: 4A, A-5 – A-1, A-I, J – W, W+1 – W+84
Antenna input	VHF/UHF 75 ohm
Power source	120V AC, 60 Hz with supplied AC adapter
Power consumption	100 W with supplied AC adapter
Audio power	2.5W + 2.5 W
Speaker type	1.8 x 3.9 inches (45.7 x 99.1 mm), 16 ohm x 2
Video/Audio terminals	S-VIDEO INPUT Y-INPUT: 1V (p-p), 75 ohm, negative sync., Mini DIN 4pin x 1 C-INPUT: 0.286V (p-p) (burst signal), 75 ohm VIDEO/AUDIO INPUT VIDEO: 1V (p-p), 75 ohm, negative sync., pin jack x 2 AUDIO: 150 mV (rms) (30% modulation equivalent, 47k ohm), pin jack (L/R) x 5 ColorStream® (component video) INPUT Y: 1V (p-p), 75 ohm P <sub>R</sub> : 0.7V (p-p), 75 ohm P <sub>B</sub> : 0.7V (p-p), 75 ohm HEADPHONE Ø3.5mm stereo mini jack x 1 HDMI INPUT: HDMI compliant (type A connector) HDCP compliant E-EDID* compliant Suggested scan rates: 1080i, 480p, 480i, 720p HDMI Audio: 2-channel PCM 32/44.1/48 kHz sampling frequency 16/20/24 bits per sample PC Monitor Input Mini-Dsub 15pin x 1
Dimensions	Width: 21-13/16 inches (554 mm) Height: 17-5/8 inches (448 mm) Depth: 8-11/16 inches (220 mm)
Weight	19.8 lbs. (9.0 kg)
Supplied accessories	Remote control (CT-885) with two size “AAA” batteries AC adapter AC cord (for AC adapter) Owner’s Manual (This booklet)

\* E-EDID = Enhanced-Extended Display Identification.

**WARNING:** Always use the Toshiba wall bracket specified below or another wall bracket approved by Toshiba for wall mounting this television. The use of any wall bracket other than the Toshiba wall bracket specified below or another wall bracket approved by Toshiba for wall mounting this television could result in serious bodily injury and/or property damage.

**In the U.S.:** Use Toshiba wall bracket model number **FWB2027**. For more information, call TACP’s Consumer Solutions Center at 1-800-631-3811 or visit TACP’s website at [www.tacp.toshiba.com](http://www.tacp.toshiba.com).

**In Canada:** Call TCL’s Customer Service Department at 1-800-268-3404.



## Limited United States Warranty for LCD Televisions, 20" and smaller

Toshiba America Consumer Products, L.L.C. ("TACP") makes the following limited warranties to original consumers in the United States. **THESE LIMITED WARRANTIES EXTEND TO THE ORIGINAL CONSUMER PURCHASER OR ANY PERSON RECEIVING THIS LCD TELEVISION AS A GIFT FROM THE ORIGINAL CONSUMER PURCHASER AND TO NO OTHER PURCHASER OR TRANSFEREE.**

LCD TELEVISIONS PURCHASED IN THE U.S.A. AND USED ANYWHERE OUTSIDE OF THE U.S.A., INCLUDING, WITHOUT LIMITATION, CANADA AND MEXICO, ARE NOT COVERED BY THESE WARRANTIES.

LCD TELEVISIONS PURCHASED ANYWHERE OUTSIDE OF THE U.S.A., INCLUDING, WITHOUT LIMITATION, CANADA AND MEXICO, AND USED IN THE U.S.A., ARE NOT COVERED BY THESE WARRANTIES.

### Limited One (1) Year Warranty on Parts and Labor

TACP warrants this LCD Television and its parts against defects in materials or workmanship for a period of one (1) year after the date of original retail purchase. DURING THIS PERIOD, TACP WILL, AT TACP'S OPTION, REPAIR OR REPLACE A DEFECTIVE PART WITH A NEW OR REFURBISHED PART WITHOUT CHARGE TO YOU.

### Rental Units

The warranty for LCD Television rental units begins on the date of the first rental or thirty (30) days after the date of shipment to the rental firm, whichever comes first.

### Limited Warranty for Commercial Units

TACP warrants LCD Televisions that are sold and used for commercial purposes as follows: all parts are warranted against defects in materials or workmanship for a period of ninety (90) days after the date of original retail purchase. DURING THIS PERIOD, TACP WILL, AT TACP'S OPTION, REPAIR OR REPLACE A DEFECTIVE PART WITH A NEW OR REFURBISHED PART WITHOUT CHARGE TO YOU.

### Owner's Manual and Product Registration Card

Read this owner's manual thoroughly before operating this LCD Television. Complete and mail the enclosed product registration card or register your LCD Television online at [m/service](http://m/service) [www.tacp.toshiba.com/service](http://www.tacp.toshiba.com/service) as soon as possible. By registering your LCD Television you will enable TACP to bring you new products specifically designed to meet your needs and help us to contact you in the unlikely event a safety notification is required under the U.S. Consumer Product Safety Act. Failure to complete and return the product registration card does not diminish your warranty rights.

### Your Responsibility

THE ABOVE WARRANTIES ARE SUBJECT TO THE FOLLOWING CONDITIONS:

- (1) You must retain your original bill of sale or provide other proof of purchase.
- (2) All warranty servicing of this LCD Television must be made by the Depot Warranty Repair Center specified by the TACP Consumer Solutions Center.
- (3) The warranties from TACP are effective only if this LCD Television is purchased and operated in the Continental U.S.A. or Puerto Rico.
- (4) Labor service charges for set installation, setup, adjustment of customer controls, and installation or repair of antenna systems are not covered by this warranty. Reception problems caused by inadequate antenna systems, misaligned satellite dishes, cable television distribution, VCRs, DVD players/recorders, personal computer level IEEE-1394 devices, and any other connected signal source device are your responsibility.

- (5) Warranties extend only to defects in materials or workmanship as limited above, and do not extend to any LCD Television or parts that have been lost or discarded by you or to damage to the LCD Television or parts caused by fires, misuse, accident, Acts of God (such as lightning or fluctuations in electric power), improper installation, improper maintenance, or use in violation of instructions furnished by TACP; use or malfunction through simultaneous use of this LCD Television and connected equipment; or to units that have been modified or had the serial number removed, altered, defaced, or rendered illegible.

### How to Obtain Warranty Service

If, after following all of the operating instructions in this manual and reviewing the section entitled "Troubleshooting," you find that service is needed:

- (1) For instructions on how to obtain warranty service for your LCD Television, contact TACP's Consumer Solution Center toll free at 1-800-575-5469.
- (2) You must include a copy or original bill of sale or other proof of purchase along with the entire LCD Television to the Depot Warranty Repair Center specified by the TACP Consumer Solutions Center. You are responsible for all inbound transportation and insurance charges for the LCD Television to the Depot Warranty Repair Center specified by the TACP Consumer Solutions Center.

For additional information, visit TACP's website:  
[www.tacp.toshiba.com](http://www.tacp.toshiba.com)

ALL WARRANTIES IMPLIED BY THE LAW OF ANY STATE OF THE U.S.A., INCLUDING THE IMPLIED WARRANTIES OF MERCHANTABILITY AND FITNESS FOR A PARTICULAR PURPOSE, ARE EXPRESSLY LIMITED TO THE DURATION OF THE LIMITED WARRANTIES SET FORTH ABOVE. WITH THE EXCEPTION OF ANY WARRANTIES IMPLIED BY THE LAW OF ANY STATE OF THE U.S.A. AS HEREBY LIMITED, THE FOREGOING WARRANTY IS EXCLUSIVE AND IN LIEU OF ALL OTHER WARRANTIES, GUARANTEES, AGREEMENTS, AND SIMILAR OBLIGATIONS OF TACP WITH RESPECT TO THE REPAIR OR REPLACEMENT OF ANY PARTS. IN NO EVENT SHALL TACP BE LIABLE FOR CONSEQUENTIAL OR INCIDENTAL DAMAGES (INCLUDING, BUT NOT LIMITED TO, LOST PROFITS, BUSINESS INTERRUPTION, OR MODIFICATION OR ERASURE OF RECORDED DATA CAUSED BY USE, MISUSE OR INABILITY TO USE THIS LCD TELEVISION).

No person, agent, distributor, dealer, or company is authorized to change, modify, or extend the terms of these warranties in any manner whatsoever. The time within which an action must be commenced to enforce any obligation of TACP arising under the warranty or under any statute or law of the United States or any state thereof is hereby limited to ninety (90) days from the date you discover, or should have discovered, the defect. This limitation does not apply to implied warranties arising under the law of any state of the U.S.A.

THIS WARRANTY GIVES YOU SPECIFIC LEGAL RIGHTS AND YOU MAY ALSO HAVE OTHER RIGHTS WHICH MAY VARY FROM STATE TO STATE IN THE U.S.A. SOME STATES OF THE U.S.A. DO NOT ALLOW LIMITATIONS ON THE DURATION OF AN IMPLIED WARRANTY, WHEN AN ACTION MAY BE BROUGHT, OR THE EXCLUSION OR LIMITATION OF INCIDENTAL OR CONSEQUENTIAL DAMAGES. THEREFORE, THE ABOVE PROVISIONS MAY NOT APPLY TO YOU UNDER SUCH CIRCUMSTANCES.



## Limited Canada Warranty for LCD Televisions, 20" and smaller

Toshiba Canada Limited, ("TCL") makes the following limited warranties to original consumers in Canada. THESE LIMITED WARRANTIES EXTEND TO THE ORIGINAL CONSUMER PURCHASER OR ANY PERSON RECEIVING THIS LCD TELEVISION AS A GIFT FROM THE ORIGINAL CONSUMER PURCHASER AND TO NO OTHER PURCHASER OR TRANSFEREE.

LCD TELEVISIONS PURCHASED IN CANADA AND USED ANYWHERE OUTSIDE OF CANADA, INCLUDING, WITHOUT LIMITATION, THE U.S.A. AND MEXICO, ARE NOT COVERED BY THESE WARRANTIES.

LCD TELEVISIONS PURCHASED ANYWHERE OUTSIDE OF CANADA, INCLUDING, WITHOUT LIMITATION, THE U.S.A. AND MEXICO, AND USED IN CANADA ARE NOT COVERED BY THESE WARRANTIES.

### Limited One (1) Year Warranty on Parts and Labour

TCL warrants this LCD Television and its parts against defects in materials or workmanship for a period of one (1) year after the date of original retail purchase. DURING THIS PERIOD, TCL WILL, AT TCL'S OPTION, REPAIR OR REPLACE A DEFECTIVE PART WITH A NEW OR REFURBISHED PART WITHOUT CHARGE TO YOU. YOU MUST DELIVER THE ENTIRE TELEVISION TO AN AUTHORIZED TCL SERVICE DEPOT. YOU MUST PAY FOR ALL TRANSPORTATION AND INSURANCE CHARGES FOR THE TELEVISION TO AND FROM THE SERVICE DEPOT.

### Rental Units

The warranty for LCD Television rental units begins on the date of the first rental or thirty (30) days after the date of shipment to the rental firm, whichever comes first.

### Limited Warranty for Commercial Units

TCL warrants LCD Televisions that are sold and used for commercial purposes as follows: all parts are warranted against defects in materials or workmanship for a period of ninety (90) days after the date of original retail purchase. DURING THIS PERIOD, TCL WILL, AT TCL'S OPTION, REPAIR OR REPLACE A DEFECTIVE PART WITH A NEW OR REFURBISHED PART WITHOUT CHARGE TO YOU. YOU MUST DELIVER THE ENTIRE TELEVISION TO AN AUTHORIZED TCL SERVICE DEPOT. YOU MUST PAY FOR ALL TRANSPORTATION AND INSURANCE CHARGES FOR THE TELEVISION TO AND FROM THE SERVICE DEPOT.

### Owner's Manual and Product Registration

Read this owner's manual thoroughly before operating this LCD Television.

Register your LCD Television online at [www.toshiba.ca](http://www.toshiba.ca) as soon as possible. By registering your LCD Television you will enable TCL to bring you new products specifically designed to meet your needs and help us to contact you in the unlikely event a safety notification is required. Failure to register your LCD Television does not diminish your warranty rights.

### Your Responsibility

#### THE ABOVE WARRANTIES ARE SUBJECT TO THE FOLLOWING CONDITIONS:

- (1) You must retain your original bill of sale or provide other proof of purchase.
- (2) All warranty servicing of this LCD TV must be made by an Authorized TCL Service Depot.
- (3) The warranties from TCL are effective only if this LCD Television is purchased in Canada from an authorized TCL dealer and operated in Canada.
- (4) Labour service charges for set installation, setup, adjustment of customer controls, and installation or repair of antenna systems are not covered by this warranty. Reception problems caused by inadequate antenna systems, misaligned satellite dishes, cable television distribution, VCRs, DVD players/recorders, personal computer level IEEE-1394 devices, and any other connected signal source device are your responsibility.

- (5) Warranties extend only to defects in materials or workmanship as limited above, and do not extend to any LCD Television or parts that have been lost or discarded by you or to damage to the LCD Television or parts caused by fires, misuse, accident, Acts of God (such as lightning or fluctuations in electric power), improper installation, improper maintenance, or use in violation of instructions furnished by TCL; use or malfunction through simultaneous use of this LCD Television and connected equipment; or to units that have been modified or had the serial number removed, altered, defaced, or rendered illegible.

### How to Obtain Warranty Service

If, after following all of the operating instructions in this manual and reviewing the section entitled "Troubleshooting," you find that service is needed:

- (1) To find the nearest TCL Authorized Service Depot, visit TCL's web site at [www.toshiba.ca](http://www.toshiba.ca).
- (2) You must include the original bill of sale (or a copy thereof) or other proof of purchase along with the entire LCD Television to the Authorized Service Depot. You are responsible for all inbound transportation and insurance charges for the LCD Television to the Authorized Service Depot.

**For additional information, visit TCL's website:  
[www.toshiba.ca](http://www.toshiba.ca)**

ALL WARRANTIES IMPLIED BY THE LAW OF ANY PROVINCE OF CANADA, INCLUDING THE IMPLIED WARRANTIES OF MERCHANTABILITY AND FITNESS FOR A PARTICULAR PURPOSE, ARE EXPRESSLY LIMITED TO THE DURATION OF THE LIMITED WARRANTIES SET FORTH ABOVE. WITH THE EXCEPTION OF ANY WARRANTIES IMPLIED BY THE LAW OF ANY PROVINCE OF CANADA AS HEREBY LIMITED, THE FOREGOING WARRANTY IS EXCLUSIVE AND IN LIEU OF ALL OTHER WARRANTIES, GUARANTEES, AGREEMENTS, AND SIMILAR OBLIGATIONS OF TCL WITH RESPECT TO THE REPAIR OR REPLACEMENT OF ANY PARTS. IN NO EVENT SHALL TCL BE LIABLE FOR CONSEQUENTIAL OR INCIDENTAL DAMAGES (INCLUDING, BUT NOT LIMITED TO, LOST PROFITS, BUSINESS INTERRUPTION, OR MODIFICATION OR ERASURE OF RECORDED DATA CAUSED BY USE, MISUSE, OR INABILITY TO USE THIS LCD TELEVISION).

No person, agent, distributor, dealer, or company is authorized to change, modify, or extend the terms of these warranties in any manner whatsoever. The time within which an action must be commenced to enforce any obligation of TCL arising under the warranty or under any law of Canada or any province thereof is hereby limited to ninety (90) days from the date you discover, or should have discovered, the defect. This limitation does not apply to implied warranties arising under the law of any province of Canada.

THIS WARRANTY GIVES YOU SPECIFIC LEGAL RIGHTS AND YOU MAY ALSO HAVE OTHER RIGHTS WHICH MAY VARY FROM PROVINCE TO PROVINCE IN CANADA. SOME PROVINCES OF CANADA DO NOT ALLOW LIMITATIONS ON THE DURATION OF AN IMPLIED WARRANTY, WHEN AN ACTION MAY BE BROUGHT, OR THE EXCLUSION OR LIMITATION OF INCIDENTAL OR CONSEQUENTIAL DAMAGES. THEREFORE, THE ABOVE PROVISIONS MAY NOT APPLY TO YOU UNDER SUCH CIRCUMSTANCES. [0305]



# MEMO

---

Introduction

Connecting your TV

Setting up your TV

Using the TV's Features

Appendix



# MEMO

---

Appendix



# MEMO

---

Introduction

Connecting your TV

Setting up your TV

Using the TV's Features

Appendix



**TOSHIBA AMERICA CONSUMER PRODUCTS, L.L.C.**

**Head Office**

82 Totowa Road, Wayne, NJ 07470

**National Service Division**

1420B Toshiba Drive, Lebanon, TN 37087

CableClear, ColorStream, TheaterWide and StableSound are registered trademarks of Toshiba America Consumer Products, L.L.C.  
GameTimer is a trademark of Toshiba America Consumer Products, L.L.C.

**TOSHIBA**



J3U70101C 05/07 SH

Printed in Thailand



## Free Manuals Download Website

<http://myh66.com>

<http://usermanuals.us>

<http://www.somanuals.com>

<http://www.4manuals.cc>

<http://www.manual-lib.com>

<http://www.404manual.com>

<http://www.luxmanual.com>

<http://aubethermostatmanual.com>

Golf course search by state

<http://golfingnear.com>

Email search by domain

<http://emailbydomain.com>

Auto manuals search

<http://auto.somanuals.com>

TV manuals search

<http://tv.somanuals.com>