

TOSHIBA

Leading Innovation >>>

Owner's Manual

Integrated High Definition LCD Television

COLORSTREAM® HD

DOLBY
DIGITAL PLUS

DOLBY
VOLUME

HDMI®
HIGH-DEFINITION MULTIMEDIA INTERFACE

HDTV
HIGH-DEFINITION TELEVISION

AUDYSSEY
EQ

40UX600U
46UX600U
55UX600U

For an overview of steps for setting up your new TV, see page 10.

Note: To display a High Definition picture, the TV must be receiving a High Definition signal (such as an over-the-air High Definition TV broadcast, a High Definition digital cable program, or a High Definition digital satellite program). For details, please contact your TV antenna installer, cable provider, or satellite provider.

Owner's Record

The model number and serial number are on the back and side of your TV. Record these numbers in the spaces below. Refer to these numbers whenever you communicate with your Toshiba dealer about this TV.

Model number:

Serial number:



Dear Customer,

Thank you for purchasing this Toshiba LCD TV. This manual will help you use the many exciting features of your new LCD TV. **Before operating your LCD TV, please read this manual completely**, and keep it nearby for future reference.

Safety Precautions

WARNING: TO REDUCE THE RISK OF FIRE OR ELECTRIC SHOCK, DO NOT EXPOSE THIS APPLIANCE TO RAIN OR MOISTURE.



WARNING: TO REDUCE THE RISK OF ELECTRIC SHOCK, DO NOT REMOVE COVER (OR BACK). NO USER-SERVICEABLE PARTS INSIDE. REFER SERVICING TO QUALIFIED SERVICE PERSONNEL.



The lightning flash with arrowhead symbol, within an equilateral triangle, is intended to alert the user to the presence of uninsulated "dangerous voltage" within the product's enclosure that may be of sufficient magnitude to constitute a risk of electric shock to persons.



The exclamation point within an equilateral triangle is intended to alert the user to the presence of important operating and maintenance (servicing) instructions in the literature accompanying the appliance.

WARNING

To prevent injury, this apparatus must be securely attached to the floor/wall in accordance with the installation instructions. See item 25 on page 4 and instructions on page 5.

WARNING: If you decide to wall mount this television, always use a UL Listed wall bracket appropriate for the size and weight of this television. The use of any wall bracket other than a UL Listed wall bracket appropriate for the size and weight of this television for wall mounting this television could result in serious bodily injury and/or property damage. See "Removing the Pedestal Stand" (page 5).

NOTE TO CATV INSTALLERS

This is a reminder to call the CATV system installer's attention to Article 820-40 of the U.S. NEC, which provides guidelines for proper grounding and, in particular, specifies that the cable ground shall be connected to the grounding system of the building, as close to the point of cable entry as practical. For additional antenna grounding information, see items 32 and 33 on page 4.

CHILD SAFETY:

It Makes A Difference How and Where You Use Your Flat Panel Display

Congratulations on your purchase! As you enjoy your new product, please keep these safety tips in mind:

The Issue

- The home theater entertainment experience is a growing trend and larger flat panel displays are popular purchases. However, flat panel displays are not always supported on the proper stands or installed according to the manufacturer's recommendations.

- Flat panel displays that are inappropriately situated on dressers, bookcases, shelves, desks, speakers, chests or carts may fall over and cause injury.



TOSHIBA Cares!

- The consumer electronics industry is committed to making home entertainment enjoyable and safe.

Tune Into Safety

- One size does NOT fit all. Follow the manufacturer's recommendations for the safe installation and use of your flat panel display.
- Carefully read and understand all enclosed instructions for proper use of this product.
- Don't allow children to climb on or play with furniture and television sets.
- Don't place flat panel displays on furniture that can easily be used as steps, such as a chest of drawers.
- Remember that children can become excited while watching a program, especially on a "larger than life" flat panel display. Care should be taken to place or install the display where it cannot be pushed, pulled over, or knocked down.
- Care should be taken to route all cords and cables connected to the flat panel display so that they cannot be pulled or grabbed by curious children.

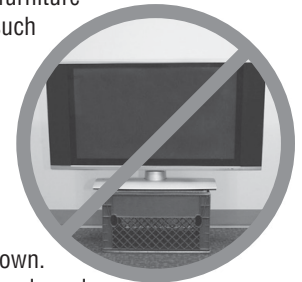

Wall Mounting: If you decide to wall mount your flat panel display, always:

- Use a mount that has been recommended by the display manufacturer and/or listed by an independent laboratory (such as UL, CSA, ETL).
- Follow all instructions supplied by the display and wall mount manufacturers.
- If you have any doubts about your ability to safely install your flat panel display, contact your retailer about professional installation.
- Make sure that the wall where you are mounting the display is appropriate. Some wall mounts are not designed to be mounted to walls with steel studs or old cinder block construction. If you are unsure, contact a professional installer.
- A minimum of two people are required for installation. Flat panel displays can be heavy.



www.CE.org/safety

Important Safety Instructions

- 1) **Read these instructions.**
- 2) **Keep these instructions.**
- 3) **Heed all warnings.**
- 4) **Follow all instructions.**



- 5) **Do not use this apparatus near water.**
- 6) **Clean only with dry cloth.**
- 7) **Do not block any ventilation openings.** Install in accordance with the manufacturer's instructions.
- 8) **Do not install near any heat sources** such as radiators, heat registers, stoves, or other apparatus (including amplifiers) that produce heat.

- 9) **Do not defeat the safety purpose of the polarized or grounding type plug.** A polarized plug has two blades with one wider than the other. A grounding type plug has two blades and a third grounding prong. The wide blade or the third prong are provided for your safety. If the provided plug does not fit into your outlet, consult an electrician for replacement of the obsolete outlet.

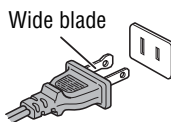

- 10) **Protect the power cord** from being walked on or pinched, particularly at plugs, convenience receptacles, and the point where they exit from the apparatus.
- 11) **Only use attachments/accessories specified by the manufacturer.**

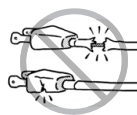

- 12) **Use only with the cart, stand, tripod, bracket, or table specified by the manufacturer, or sold with the apparatus.** When a cart is used, use caution when moving the cart/apparatus combination to avoid injury from tip-over.
- 13) **Unplug this apparatus during lightning storms or when unused for long periods of time.**



- 14) **Refer all servicing to qualified service personnel.** Servicing is required when the apparatus has been damaged in any way, such as power-supply cord or plug is damaged, liquid has been spilled or objects have fallen into the apparatus, the apparatus has been exposed to rain or moisture, does not operate normally, or has been dropped.

Additional Safety Precautions

- 14a) **CAUTION:** If the TV is dropped and the cabinet or enclosure surface has been damaged or the TV does not operate normally, take the following precautions:
 - **ALWAYS** turn off the TV and unplug the power cord to avoid possible electric shock or fire.
 - **NEVER** allow your body to come in contact with any broken glass or liquid from the damaged television. The LCD panel inside the TV contains glass and a toxic liquid. If the liquid comes in contact with your mouth or eyes, or your skin is cut by broken glass, rinse the affected area thoroughly with water and consult your doctor.

- **ALWAYS** contact a service technician to inspect the TV any time it has been damaged or dropped.

- 15) **CAUTION:**
 - To reduce the risk of electric shock, do not use the polarized plug with an extension cord, receptacle, or other outlet unless the blades can be inserted completely to prevent blade exposure.
 - To prevent electric shock, match wide blade of plug to wide slot; fully insert.
- 16) **CAUTION:**



Do not let children swallow the product or play with the plastic bag. Keep the product and the plastic bag out of the reach of children.
- 17) **CAUTION:**

Do not let water or other liquids come into contact with the product, as it may result in damage.
- 18) **WARNING:**
 - To prevent the spread of fire, keep candles or other open flames away from this product at all times.
 - Keep the product away from direct sunlight, fire or a heat source such as a heater. This may reduce the product lifetime or result in fire.

Installation, Care, and Service

Installation

Follow these recommendations and precautions and heed all warnings when installing your TV:

- 19)  **WARNING: NEVER expose batteries to excessive heat such as sunshine, fire or the like.**
- 20) **ALWAYS** plug the product into an outlet that is located in such a manner that it can be easily unplugged in case the product requires service.
- 21) **NEVER** route the product's power cord inside a wall or similar enclosed area.
- 22) Never modify this equipment. Changes or modifications may void: a) the warranty, and b) the user's authority to operate this equipment under the rules of the Federal Communications Commission.
- 23)  **DANGER: RISK OF SERIOUS PERSONAL INJURY, DEATH, OR EQUIPMENT DAMAGE!**
Never place the TV on an unstable cart, stand, or table. The TV may fall, causing serious personal injury, death, or serious damage to the TV. 
- 24) To avoid damage to this product, never place or store the TV in direct sunlight; hot, humid areas; or areas subject to excessive dust or vibration.

- 25) Always place the TV on the floor or a sturdy, level, stable surface that can support the weight of the unit. In order to maintain stability and prevent the TV falling over, secure the TV with a sturdy strap from the hooks on the rear of the TV pedestal to a wall stud, pillar, or other immovable structure. Make sure the strap is tight, secure, and parallel to the floor.

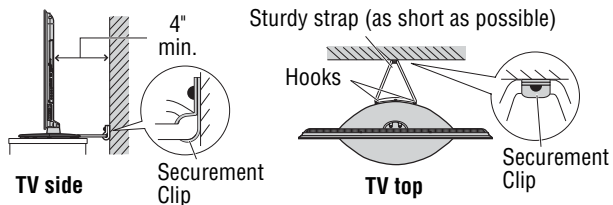

- 26) The apparatus shall not be exposed to dripping or splashing, and that no objects filled with liquids, such as vases, shall be placed on the apparatus.

- 27) Never block or cover the slots or openings in the TV cabinet back, bottom, and sides. Never place the TV:

- on a bed, sofa, rug, or similar surface;
- too close to drapes, curtains, or walls; or
- in a confined space such as a bookcase, built-in cabinet, or any other place with poor ventilation.



The slots and openings are provided to protect the TV from overheating and to help maintain reliable operation of the TV. Leave a space of at least 4 (four) inches around the TV.

- 28) Always place the back of the television at least 4 (four) inches away from any vertical surface (such as a wall) to allow proper ventilation.

- 29) Never allow anything to rest on or roll over the power cord, and never place the TV where the power cord is subject to wear or abuse.

- 30) Never overload wall outlets and extension cords.

- 31) Always operate this equipment from a 120 VAC, 60 Hz power source only.

- 32) Always make sure the antenna system is properly grounded to provide adequate protection against voltage surges and built-up static charges (see Section 810 of the National Electric Code).

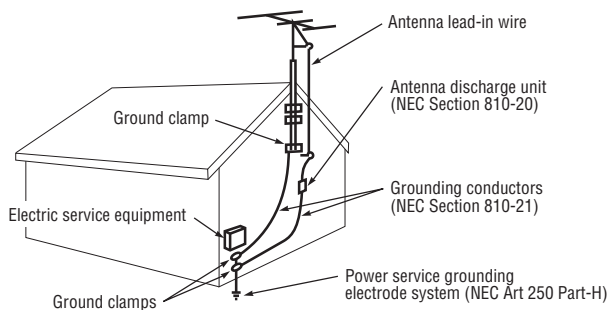

- 33)  **DANGER: RISK OF SERIOUS PERSONAL INJURY OR DEATH!**

- Use extreme care to make sure you are never in a position where your body (or any item you are in contact with, such as a ladder or screwdriver) can accidentally touch overhead power lines. Never locate the antenna near overhead power lines or other electrical circuits.
- Never attempt to install any of the following during lightning activity: a) an antenna system; or b) cables, wires, or any home theater component connected to an antenna or phone system.

Care

For better performance and safer operation of your TOSHIBA TV, follow these recommendations and precautions:

- 34) If you use the TV in a room whose temperature is 32 °F (0 °C) or below, the picture brightness may vary until the LCD warms up. This is not a sign of malfunction.

- 35) Always unplug the TV before cleaning. When cleaning your TV, please first remove any dirt or dust from the surface. Gently wipe the cabinet and the display panel surface (the TV screen) with a dry, soft cloth only (cotton, flannel, etc.). The enclosed cleaning cloth is for cabinet cleaning. Harsh rubbing or use of a dirty or stiff cloth will scratch the TV surface. Avoid contact with alcohol, thinner, benzene, acidic or alkaline solvent cleaners, abrasive cleaners, or chemical cloths, which may damage the TV surface. Never spray volatile compounds such as insecticide on the TV surface. Such products may damage or discolor the TV.



- 36)  **WARNING: RISK OF ELECTRIC SHOCK!** 

Never spill liquids or push objects of any kind into the TV cabinet slots.

- 37) While it is thundering, do not touch the connecting cables or apparatus.

- 38) For added protection of your TV from lightning and power surges, always unplug the power cord and disconnect the antenna from the TV if you leave the TV unattended or unused for long periods of time.

- 39) ALWAYS unplug the TV to completely disconnect from mains power. When the TV is turned off using the on/off switch, it is not completely disconnected from power and a minute amount of current is still consumed.

- 40) During normal use, the TV may make occasional snapping or popping sounds. This is normal, especially when the unit is being turned on or off. If these sounds become frequent or continuous, unplug the power cord and contact a Toshiba Authorized Service Center.

- 41)  **WARNING: RISK OF SERIOUS PERSONAL INJURY OR EQUIPMENT DAMAGE!**

Never strike the screen with a sharp or heavy object.



- 42) • The LCD screen of this product can be damaged by ultraviolet radiation from the sun. When selecting a location for the television, avoid locations where the screen may be exposed to direct sunlight, such as in front of a window.
- Never touch, press, or place anything on the LCD screen. These actions will damage the LCD screen. If you need to clean the LCD screen, follow the instructions in item 35 on page 4.

Service

- 43)  **WARNING: RISK OF ELECTRIC SHOCK!** 

Never attempt to service the TV yourself. Opening and removing the covers may expose you to dangerous voltage or other hazards. Failure to follow this WARNING may result in death or serious injury. Refer all servicing not specified in this manual to a Toshiba Authorized Service Center.

- 44) If you have the TV serviced:
- Ask the service technician to use only replacement parts specified by the manufacturer.
 - Upon completion of service, ask the service technician to perform routine safety checks to determine that the TV is in safe operating condition.

Choosing a location for your LCD TV

To Display your LCD TV on the included Pedestal Stand:

Observe the following safety precautions:

- 1) Read and Follow the pedestal assembly instructions included with the pedestal.
CAUTION: Before beginning pedestal assembly, carefully lay the front of the LCD Panel face down on a flat, cushioned surface such as a quilt or blanket. Leave the bottom of the unit protruding over the edge of the surface and assemble the pedestal as indicated below.
Note: Extreme care should always be used when attaching the pedestal stand to avoid damage to the LCD panel.
- 2) Place the TV on a sturdy, level surface that can support the weight of the TV.
- 3) Be sure to secure the TV to a wall stud, pillar, surface, or other immovable structure. To secure the TV in this manner: (1) attach the provided securement clip to an immovable structure, then (2) pass a sturdy strap through the securement clip and attach each end to the hooks located on the back of the TV. Be sure to leave at least 4 inches between the TV and the wall or similar structure for ventilation. See item 25, page 4 for additional details.

To Display your LCD TV using a Wall Bracket:

If you decide to wall mount your LCD TV, always use a UL Listed wall bracket appropriate for the size and weight of the LCD TV (see page 2) :

- 1) **CAUTION:** Two people are required for installation.
- 2) Unplug and remove any cables and/or other component connectors from the rear of the TV.
- 3) Follow the instructions provided with your wall bracket. Before proceeding, make sure the appropriate bracket(s) are attached to the wall and the back of the TV as described in the instructions provided with the wall bracket.
- 4) Always use the screws supplied or recommended by the wall mount manufacturer.
- 5) After attaching the appropriate bracket(s) to the wall and the back of the TV, remove the pedestal stand from the TV as described below.

Removing the Pedestal Stand

- 1) Carefully lay the front of the unit face down on a flat, cushioned surface such as a quilt or blanket. Leave the stand protruding over the edge of the surface.
Note: Extreme care should always be used when removing the pedestal stand to avoid damage to the LCD panel.
- 2) Remove the four screws shown in the diagram below. This will allow removal of the pedestal stand.
- 3) Once you have removed all four screws holding the pedestal stand in place, remove the pedestal stand from the TV by sliding the pedestal stand away from the TV.

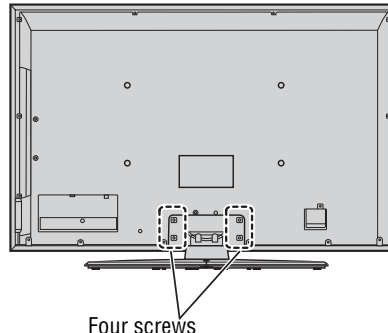

USA - Federal Communications Commission Statement

FCC Compliance Statement

This device complies with Part 15 of the FCC Rules. Operation is subject to the following two conditions:
(1) This device may not cause harmful interference, and
(2) This device must accept any interference received, including interference that may cause undesired operation.

The party responsible for compliance to these rules is:
Toshiba America Consumer Products, L.L.C.
82 Totowa Rd. Wayne, NJ 07470.
Ph: 1-800-631-3811

Interference: *This equipment has been tested and found to comply with the limits for a Class B digital device, pursuant to Part 15 of the FCC Rules. These limits are designed to provide reasonable protection against harmful interference in a residential installation.*

This equipment generates, uses and can radiate radio frequency energy and, if not installed and used in accordance with the instructions, may cause harmful interference to radio communications. However, there is no guarantee that interference will not occur in a particular installation. If this equipment does cause harmful interference to radio or television reception, which can be determined by turning the equipment off and on, the user is encouraged to try to correct the interference by one of the following measures:

- Reorient or relocate the receiving antenna.
- Increase the separation between the equipment and receiver.
- Connect the equipment into an outlet on a circuit different from that to which the receiver is connected.
- Consult the dealer or an experienced radio/TV technician for help.

Wireless Radio

For product available in the USA/Canada market, only channel 1–11 can be operated. Selection of other channels is not possible.

The device could automatically discontinue transmission in case of absence of information to transmit, or operational failure. Note that this is not intended to prohibit transmission of control or signaling information or the use of repetitive codes where required by the technology.

If this device is going to be operated in 5.15–5.25GHz frequency range, then it is restricted in indoor environment only.

Important: *Any changes or modifications not expressly approved by the party responsible for compliance could void the user's authority to operate this equipment.*

This device and its antenna(s) must not be co-located or operating in conjunction with any other antenna or transmitter.

FCC Radiation Exposure Statement: *This equipment complies with FCC radiation exposure limits set forth for an uncontrolled environment. This equipment should be installed and operated with minimum distance 20cm between the radiator & your body.*

Canada - Industry Canada Statement

This device complies with ICES-003 Class B & RSS-210.

Operation is subject to the following two conditions:

- (1) This device may not cause harmful interference, and
- (2) This device must accept any interference received, including interference that may cause undesired operation of the device.

This device and its antenna(s) must not be co-located or operating in conjunction with any other antenna or transmitter.

Wireless Radio

For product available in the USA/Canada market, only channel 1–11 can be operated. Selection of other channels is not possible.

The device could automatically discontinue transmission in case of absence of information to transmit, or operational failure. Note that this is not intended to prohibit transmission of control or signaling information or the use of repetitive codes where required by the technology.

Important: *Any changes or modifications not expressly approved by the party responsible for compliance could void the user's authority to operate this equipment.*

IMPORTANT NOTE:

IC Radiation Exposure Statement: *This equipment complies with IC RSS-102 radiation exposure limits set forth for an uncontrolled environment. This equipment should be installed and operated with minimum distance 20cm between the radiator & your body.*

ENERGY STAR® User Information

ENERGY STAR User Information Statement: the factory default settings of this television meet ENERGY STAR® requirements. Enabling or changing certain features and functionality (e.g. Picture Settings, Auto Brightness Sensor, Power-On Mode) may increase energy consumption, possibly beyond the limits required for ENERGY STAR qualification.

To ensure your television is operating at optimal energy efficiency, select [Home] mode during initial activation. To return to [Home] mode settings, select [AutoView] picture mode, set the Auto Brightness Sensor to [On] mode, and set the Power-On mode to [Power-Saving]. [AutoView] mode is recommended for normal home use.

For more information, see page 52 and 57.



ENERGY STAR® qualified TV. Products that earn the ENERGY STAR prevent green house gas emissions by meeting strict guidelines set by the U.S. Environmental Protection Agency. ENERGY STAR and the ENERGY STAR mark are registered U.S. marks.

Important notes about your LCD TV

The following symptoms are technical limitations of LCD Display technology and are not an indication of malfunction; therefore, Toshiba is not responsible for perceived issues resulting from these symptoms.

- 1) An afterimage (ghost) may appear on the screen if a fixed, non-moving image is displayed for a long period of time. The afterimage is not permanent and will disappear in a short period of time.
- 2) The LCD panel contained in this TV is manufactured using an extremely high level of precision technology; however, there may be an occasional pixel (dot of light) that does not operate properly (does not light, remains constantly lit, etc.). This is a structural property of LCD technology, is not a sign of malfunction, and is not covered under your warranty. Such pixels are not visible when the picture is viewed from a normal viewing distance.

Note: Interactive video games that involve shooting a "gun" type of joystick at an on-screen target may not work with this TV.

Trademark Information

- Manufactured under license from Dolby Laboratories. Dolby and the double-D symbol are trademarks of Dolby Laboratories.
- **AUDYSSEY** EQ Audyssey EQ is based on the award-winning Audyssey MultEQ technology. It is the first-ever room equalization solution that can achieve optimum sound for a large listening area and it is featured in many high end home theater products. Audyssey EQ is used in the TV tuning process to calculate an equalization solution that corrects time and frequency response problems in TV systems. This results in clear, rich sound with more intelligible dialog.
- Manufactured under license from Audyssey Laboratories. U. S. and foreign patents pending. Audyssey EQ is a registered trademark of Audyssey Laboratories.
- HDMI, the HDMI Logo, and High-Definition Multimedia Interface are trademarks or registered trademarks of HDMI Licensing LLC in the United States and other countries.
- INSTAPORT™ and INSTAPORT logo are trademarks of Silicon Image, Inc. in the United States and other countries.
- MPEG Layer-3 audio coding technology licensed from Fraunhofer IIS and Thomson.
- **SD** SDHC Logo is a trademark.
- DLNA®, DLNA® Certification Logo and DLNA CERTIFIED™ are registered trademarks, trademarks, service marks, or certification marks of the Digital Living Network Alliance.
- VUDU is a trademark of VUDU, Inc .
- YouTube and the YouTube Logo are trademarks of Google Inc. in the United States and Canada.
- This product contains NetFront Browser of ACCESS CO., LTD.
- **ACCESS**™ ACCESS, the ACCESS logo and NetFront are trademarks or registered trademarks of ACCESS CO., LTD. in the United States, Japan and other countries.
© 2010 ACCESS CO., LTD. All rights reserved.
This software is based in part on the work of the Independent JPEG Group.
- This product contains Adobe® Flash® Player software under license from Adobe Systems Incorporated. Copyright © 1995-2009 Adobe Systems Incorporated. All rights reserved. Adobe and Flash are trademarks of Adobe Systems Incorporated.

Contents

Important Safety Instructions	3
Installation, Care, and Service	3
Choosing a location for your LCD TV	5
Chapter 1: Introduction	10
Features of your new TV	10
Overview of steps for installing, setting up, and using your new TV	10
TV front and side panel	11
TV back panel	12
Chapter 2: Connecting your TV	13
Overview of cable types	13
About the connection illustrations	13
Connecting a VCR and antenna, Cable TV or Camcorder	14
Connecting a DVD player with ColorStream® (component video), a VCR (to record and playback), or a satellite receiver	15
Connecting a device to the IR OUT infrared terminal using the IR blaster cable for IR pass-through device control	16
Connecting an HDMI® or DVI device to the HDMI input	17
REGZA-LINK® connection	18
Connecting a HDMI audio system	19
Connecting a digital audio system	19
Connecting a personal computer (PC)	20
Connecting a home network	21
Chapter 3: Using the remote control	23
Preparing the remote control for use	23
Installing the remote control batteries	23
Learning about the remote control	24
Using the remote control to control your other devices	25
Remote control functional key chart	26
Programming the remote control to operate your other devices	28
Remote control codes	29
Chapter 4: Menu layout and navigation	32
Main menu layout	32
Quick menu	32
Navigating the menu system	33
Chapter 5: Setting up your TV	34
Initial Setup	34
Quick Setup from the SETUP menu	34
Selecting the menu language	34
Configuring the antenna input source for the ANT/CABLE terminal	35
Programming channels into the TV's channel memory	35
Auto Tuning	35
Manual Tuning	35
Setting AV Input mode	36
Setting channel skip	36
Setting video input skip	36
Labeling video input sources	36
Setting the time zone	37
Selecting the location	37
Chapter 6: Basic features	38
Tuning channels	38
Setting the Channel Tuning Mode	38
Tuning to the next programmed channel	38
Tuning to a specific channel (programmed or unprogrammed)	38
Tuning channels using the Channel Browser™	39
Switching between two channels using Channel Return	41
Switching between two channels using SurfLock™	41
Selecting the video input to view	41
Using the closed caption mode	42
Analog CC Mode	42
Digital CC Settings	42
Setting the PIN code	43
Registering a new PIN code	43
Changing or deleting your PIN code	43
If you cannot remember your PIN code	43
Using lock menu	43
Blocking TV programs and movies by rating (V-Chip)	43
Downloading an additional rating system for blocking TV programs and movies	44
Unlocking programs	45
Locking channels	45
Input lock feature	45
Network Lock	46
GameTimer®	46
Panel lock	46
Using REGZA-LINK®	47
REGZA-LINK® playback device control	47
REGZA-LINK® input source selection	47
Amplifier VOLUME and MUTE controls	48
Other REGZA-LINK® functions	48
REGZA-LINK® PC Link	48
Using the HDMI® settings feature	49
Setting the HDMI® audio mode	49
Viewing the HDMI® signal information	49
Using the PC settings feature	50
Setting the PC Audio	50
Setting the On Timer	51
Setting the Sleep Timer	51
Automatic Power Down	52
No Signal Power Down	52
Power-On Mode	52
Blue Screen	52
TOSHIBA Illumination	52
Displaying TV status information	53
Viewing support information	53
Reset Factory Defaults	53
Understanding the auto power off feature	53
Understanding the last mode memory feature	53
Chapter 7: Picture and sound controls	54
Selecting the picture size	54
Scrolling the picture	56
Using the Auto Aspect feature	56
Using the 4:3 Stretch	56
Using the FREEZE feature	56
Adjusting the picture	57
Selecting the picture mode	57
Adjusting the picture quality	57
Using the advanced picture settings features	58
Resolution+™	58
DynaLight™	58
Dynamic Contrast	58
Static Gamma	58
Film Stabilization	58
Expert Mode	59

ClearFrame™ feature.....	59
MPEG NR.....	59
DNR.....	59
Auto Brightness Sensor.....	60
Backlight Adjustment Pro.....	60
ColorMaster™.....	60
Base Color Adjustment.....	60
Color temperature.....	61
Viewing the Control Visualization window.....	61
Using the TheaterLock™ feature.....	61
Adjusting the audio.....	62
Muting the sound.....	62
Selecting stereo/SAP broadcasts.....	62
Adjusting the audio balance.....	62
Selecting the optical audio output format.....	62
Using the Dolby® Digital	
Dynamic Range Control feature.....	63
Using Dolby® Volume.....	63
Using the advanced sound settings features.....	63
Using the surround sound feature.....	63
Chapter 8: Advanced features.....	64
Using your home network.....	64
Setting up the Network.....	65
Wireless Setup.....	65
Advanced Network Setup.....	67
Network Connection Test.....	68
Using the software keyboard.....	69
Performing a Software Upgrade.....	69
Setting up the Media Renderer feature.....	70
Using the Widgets feature.....	71
VUDU™.....	71
Playing YouTube™.....	72
Using Function.....	72
Using the Media Player.....	75
Media Player Specifications.....	75
Basic operation.....	76
Viewing Movie files	
(on DLNA CERTIFIED™ Server).....	77
Playing Music file	
(on DLNA CERTIFIED™ Server).....	79
Viewing Photo files.....	80
Using the Photo Frame feature.....	81
Chapter 9: Troubleshooting.....	83
General troubleshooting.....	83
LED indications.....	85
Chapter 10: Appendix.....	86
Specifications.....	86
Acceptable signal formats for PC IN and HDMI	
terminals.....	88
PC IN signal formats.....	88
HDMI signal formats.....	89
Limited United States Warranty	
for LCD Televisions.....	90
Limited Canadian Warranty	
for Toshiba Brand Flat Panel Televisions.....	91
Index.....	99

Chapter 1: Introduction

Features of your new TV

The following are just a few of the many exciting features of your new Toshiba widescreen, integrated HD, LCD TV:

- **Integrated digital tuning (8VSB ATSC and QAM)** eliminates the need for a separate digital converter set-top box (in most cases).
- **1080p output resolution.**
- **Four HDMI®** digital, High-Definition Multimedia Interfaces with 1080p input support (📖 page 17).
- **HDMI capabilities**
 - ARC (Audio Return Channel)** enables the audio signal of the TV to be sent to the AV amplifier via the HDMI cable.
 - Content Type** adjusts the picture quality automatically for HDMI input content.
 - HDMI INSTAPORT™** technology reduces lag time when switching HDMI sources.
 - RGB Range** feature adjusts RGB full range signal automatically.
- **REGZA-LINK®** allows control of external devices from the TV remote via HDMI connection (📖 page 47).
- **ColorStream® HD** high-resolution component video input (📖 page 15). This is used by setting the AV input mode to ColorStream HD (📖 page 36).
- **Digital Audio Out** optical audio connection with Dolby® Digital optical output format (📖 page 62).
- **PC IN (Analog RGB)** computer terminal (📖 page 20).
- **IR OUT** for controlling infrared remote-controlled devices through the TV (📖 page 16).
- **Widgets** allows you to access select featured websites from your television.
- **ColorMaster™** allows you to adjust the TV's standard colors (📖 page 60).
- **Expert Mode** allows detailed calibration with red, green and blue color selections (📖 page 59).
- **ClearFrame™** 120 Hz anti-blur feature (📖 page 59).
- **Resolution+™** upconverts and enhances for a more detailed picture (📖 page 58).
- **AutoView™** allows you to automatically adjust picture settings based on ambient light conditions and input signal content (📖 page 57).
- **Dolby® Volume** eliminates inconsistent TV volume when changing channels or viewing commercials (📖 page 63).
- **Media Player** allows you to view photo files and to play music or movie files (📖 page 75).



ENERGY STAR® qualified

Overview of steps for installing, setting up, and using your new TV

Follow these steps to set up your TV and begin using its many exciting features.

- 1 Observe the following when choosing a location for the TV:
 - Read “Important notes about your LCD TV” (📖 page 7).
 - Place the TV in a proper location (📖 pages 2–5).
 - 2 Do not plug in any power cords until AFTER you have connected all cables and devices to your TV.
 - 3 BEFORE connecting cables or devices to the TV, learn the functions of the TV's connections and controls (📖 pages 11–12).
 - 4 Connect your other electronic device(s) to the TV (📖 pages 13–22).
 - 5 See “Chapter 3: Using the remote control” (📖 page 23) for an overview of the buttons on the remote control, install the batteries and prepare to operate your other device(s).
 - 6 AFTER connecting all cables and devices, plug in the power cords for your TV and other devices.
- Note: After you turn on the TV, the Initial Setup menu appears automatically by default.**
- 7 See “Chapter 4: Menu layout and navigation” for a quick overview of navigating the TV's menu system (📖 page 32).
 - 8 Program channels into the TV's channel memory (📖 page 35).
 - 9 For details on using the TV's features, see Chapters 6, 7 and 8.
 - 10 For help, refer to the Troubleshooting Guide, see Chapter 9.
 - 11 For technical specifications and warranty information, see Chapter 10.

TV front and side panel

Model 40UX600U is used in this manual for illustration purposes.

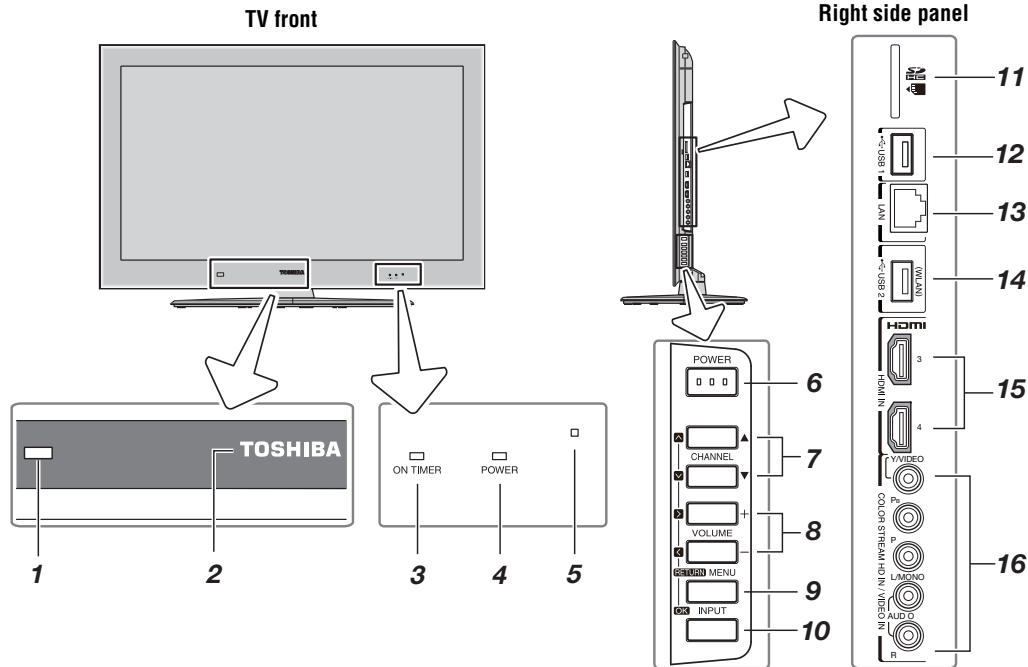

1 Remote sensor — Point the remote control toward this remote sensor.

Effective range:

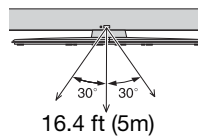

2 TOSHIBA Illumination

See “TOSHIBA Illumination” on page 52 for additional information.

3 On Timer LED

See “Setting the On Timer” on page 51.

4 Power On/Standby LED

See “LED indications” on page 85 for additional information.

5 Auto Brightness Sensor — This sensor will detect the ambient light conditions to optimize the backlighting levels (ⓘ page 60).

6 POWER — Press to turn the TV on and off. If the TV stops responding to the controls on the remote control or TV control panel and you cannot turn off the TV, press and hold the **POWER** button on the TV control panel for 5 or more seconds to reset the TV.

7 CHANNEL ▲▼ — When no menu is on-screen, these buttons change the channel (programmed channels only; ⓘ page 35).

ARROWS ^ v — When a menu is on-screen, these buttons function as up/down menu navigation buttons.

8 VOLUME+ - — These buttons adjust the volume level.

ARROWS < > — When a menu is on-screen, these buttons function as left/right menu navigation buttons.

9 MENU/RETURN — Press to access the menu system (ⓘ page 33). When a menu is on-screen, the **MENU** button on the TV’s control panel functions as the **RETURN** button.

10 INPUT/OK — Repeatedly press to change the source you are viewing. When a menu is on-screen, the **INPUT** button on the TV’s control panel functions as the **OK** button.

11 SD card slot — For use when inserting an SD Memory Card.

12 USB 1 — For use when inserting a USB device.

13 LAN port — For use when connecting to DLNA Certified products, Widgets, VUDU and YouTube.

14 USB 2 — For use when using WLAN with Dual Band WLAN Adapter.*

15 HDMI IN — HDMI input receives digital audio and uncompressed digital video from an HDMI device or uncompressed digital video from a DVI device.

16 COLOR STREAM HD IN/VIDEO IN — These include standard A/V connections. These are switched by AV input mode. (ⓘ page 36).

* About the device restrictions of the wireless LAN (ⓘ pages 6 and 64).

TV back panel

For an explanation of cable types and connections, see pages 13–20.

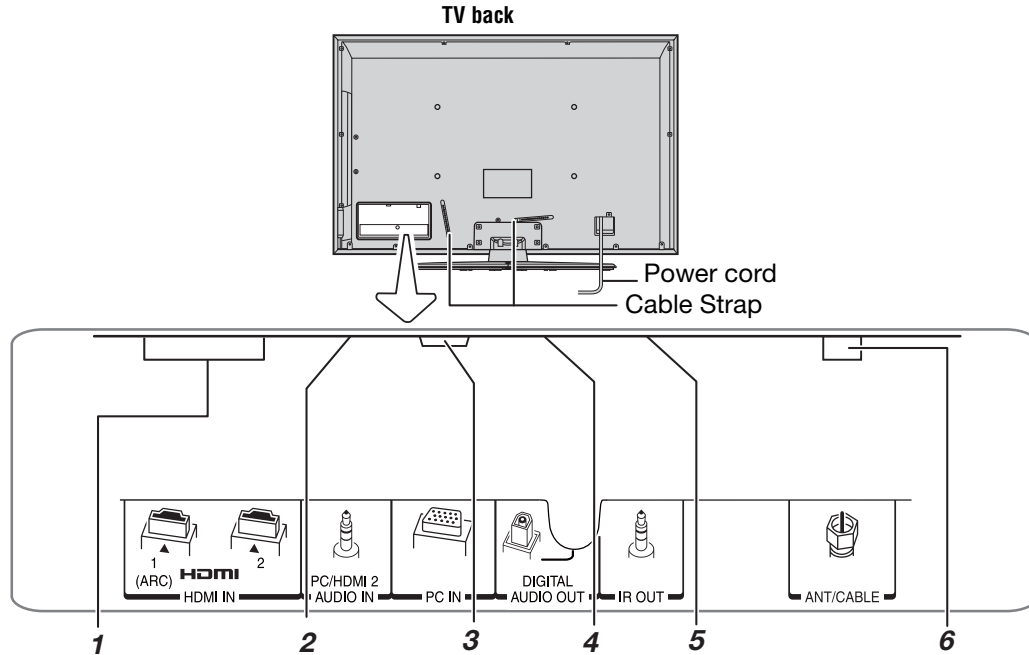

- 1 HDMI IN** — HDMI input receives digital audio and uncompressed digital video from an HDMI device or uncompressed digital video from a DVI device.
- 2 PC/HDMI 2 AUDIO IN** — PC audio input terminal is shared with HDMI 2 analog audio input terminal, and its use can be configured in the **AV Connection** menu (see page 50).
- 3 PC IN** — For use when connecting a personal computer.
- 4 DIGITAL AUDIO OUT** — Optical audio output in Dolby Digital or PCM (pulse-code modulation) format for connecting an external Dolby Digital decoder, amplifier, or home theater system with optical audio input.
- 5 IR OUT** — For controlling infrared remote-controlled devices through the TV. You can connect up to two devices with the Dual-wand blaster cable (see page 13), and then control the devices using the TV's IR pass-through features (see page 16).
- 6 ANT/CABLE** — Input that supports analog (NTSC) and digital (ATSC) off-air antenna signals and analog and digital Cable TV (QAM) signals.

HDMI, the HDMI Logo, and High-Definition Multimedia Interface are trademarks or registered trademarks of HDMI Licensing LLC in the United States and other countries.

Manufactured under license from Dolby Laboratories. Dolby and the double-D symbol are trademarks of Dolby Laboratories.

Chapter 2: Connecting your TV

Overview of cable types

Cables can be purchased from most stores that sell audio/video devices. Before purchasing any cables, be sure of connector types required by your devices and the length of each cable.

Coaxial cable (F-type)



Coaxial (F-type) cable is used for connecting your antenna, cable TV service, and/or cable converter box to the **ANT/CABLE** input on your TV.

Standard A/V cables (red/white/yellow)

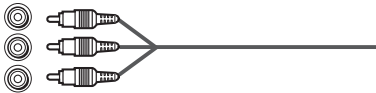

Standard A/V cables (composite video) usually come in sets of three and are for use with video devices with analog audio and composite video output. These cables (and the related inputs on your TV) are typically color-coded according to use: yellow for video, red for stereo right audio, and white for stereo left (or mono) audio.

Component video cables (red/green/blue)

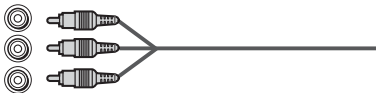

Component video cables come in sets of three and are for use with video devices with component video output. (ColorStream® is Toshiba's brand of component video.) These cables are typically color-coded red, green, and blue. Separate audio cables are required for a complete connection.

Note: Component video cables provide better picture performance than a standard (composite) video or S-video cable.

HDMI® cable (with HDMI Logo “HDMI”)



HDMI (High-Definition Multimedia Interface) cable is for use with devices with an HDMI output. An HDMI cable delivers digital audio and video in its native format. This cable carries both video and audio information; therefore, separate audio cables are not required for a complete HDMI device connection (pages 17–20).

Note: An HDMI cable provides the best audio and picture performance.

Dual-wand IR blaster cable



Dual-wand IR blaster cable is for use with video devices with IR (infrared) remote control. This cable can be used with the TV's IR pass-through feature (page 16).

To obtain IR blaster cable:
Visit <http://ceaccessories.toshiba.com/>

Optical audio cable



Optical audio cable is for connecting receivers with Dolby Digital or PCM (pulse-code modulation) optical audio input to the TV's **DIGITAL AUDIO OUT** terminal (page 19).

Analog RGB (15-pin) computer cable

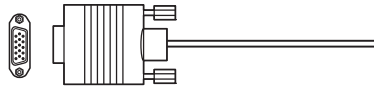

Analog RGB (15-pin) computer cable is for connecting a PC to the TV's **PC IN** terminal (page 20).

Note: Separate audio cables are required for a complete connection.

Standard/Crossover LAN cable

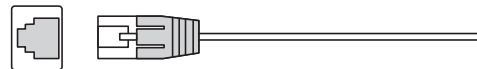

Standard LAN cable is used to connect the TV to your home network (pages 21–22).

Crossover LAN cable is used to connect the TV to directly to a PC (page 21).

About the connection illustrations

You can connect different types and brands of devices to your TV in several different configurations. The connection illustrations in this manual are representative of typical device connections only. The input/output terminals on your devices may differ from those illustrated herein. For details on connecting and using your specific devices, refer to each device's owner's manual.

Connecting a VCR and antenna, Cable TV or Camcorder

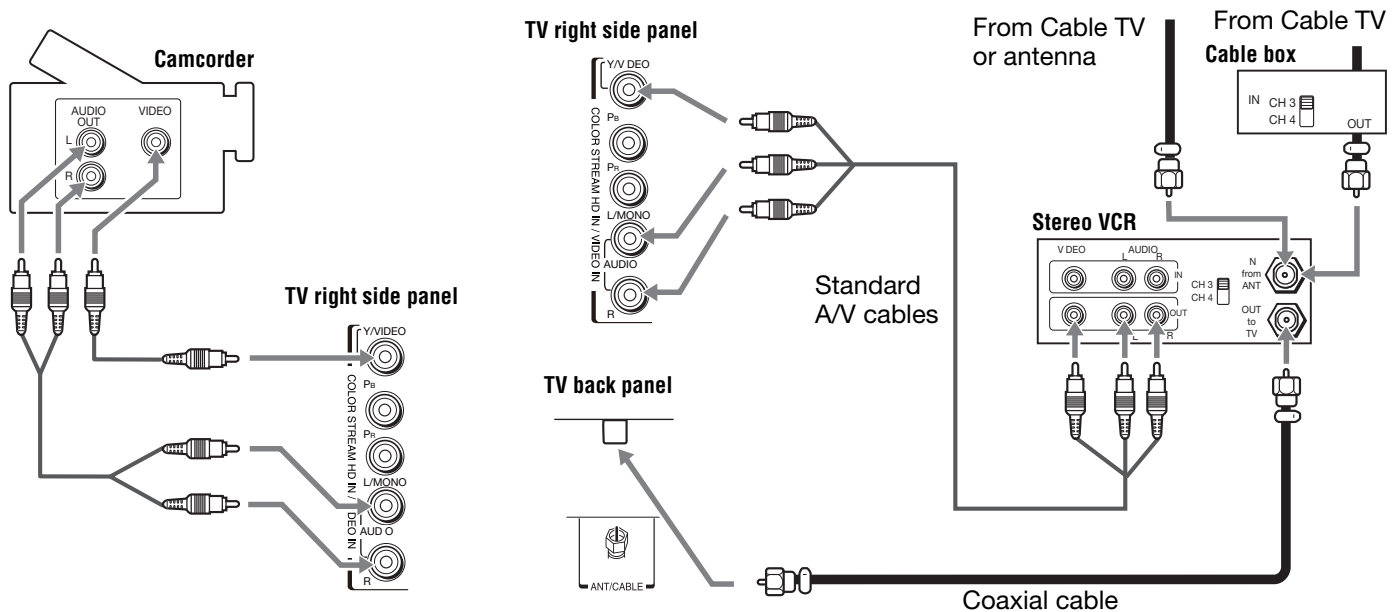

You will need:

- Coaxial cables
- Standard A/V cables
 - If you have a mono VCR, connect **L/MONO** on the TV to your VCR's audio out terminal using the white audio cable only.

Note: When you use a Cable box, you may not be able to use the remote control to program or access certain features on the TV.

To view the antenna or Cable signal:

Press **(INPUT)** and **▲** or **▼** to select the **ANT/CABLE**.

To view basic and premium Cable channels:

Turn OFF the VCR. Press **(INPUT)** and **▲** or **▼** to select the **ANT/CABLE**. Tune the TV to channel 3 or 4 (whichever channel the Cable box output is set to). Use the Cable box controls to change channels.

To view the VCR:

Turn ON the VCR. Press **(INPUT)** and **▲** or **▼** to select the **VIDEO**.

To view the camcorder video:

Press **(INPUT)** and **▲** or **▼** to select the **VIDEO**.

Note: To program the TV remote control to operate other devices, see Chapter 3.

The unauthorized recording, use, distribution, or revision of television programs, videotapes, DVDs, and other materials is prohibited under the Copyright Laws of the United States and other countries, and may subject you to civil and criminal liability.

Connecting a DVD player with ColorStream® (component video), a VCR (to record and playback), or a satellite receiver

Your TV has ColorStream® (component video) input.

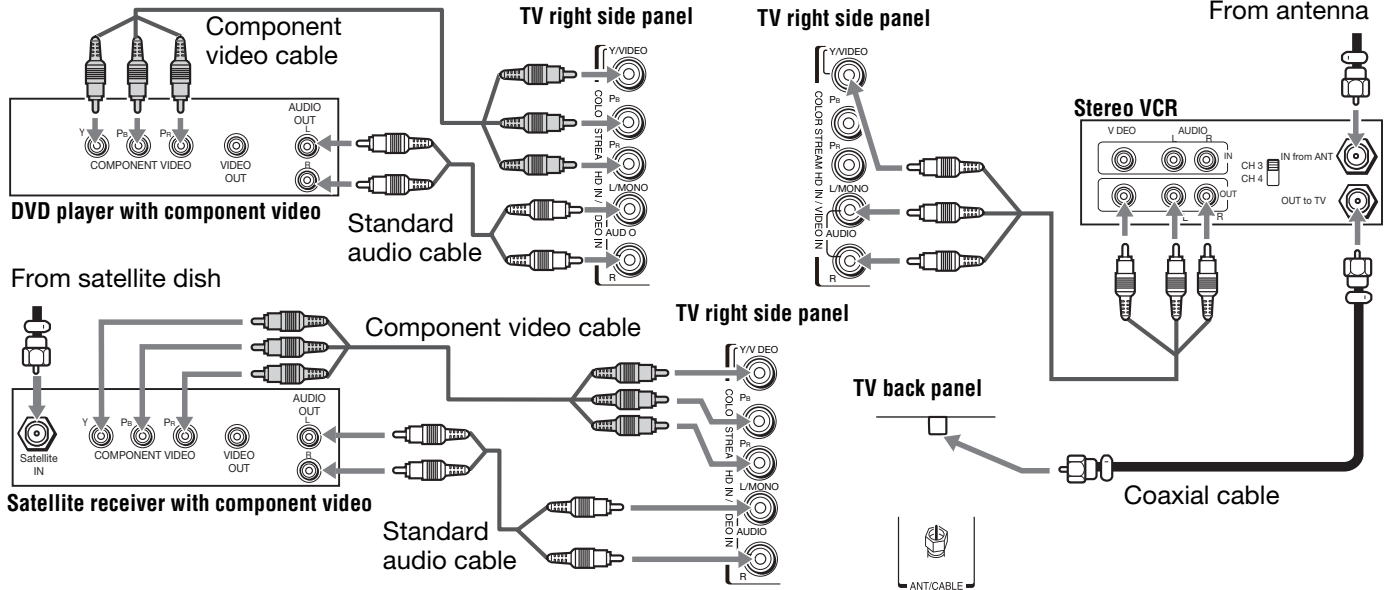

You will need:

- Coaxial cables
- Standard A/V cables
 - If you have a mono VCR, connect **L/MONO** on the TV to your VCR's audio out terminal using the white audio cable only.
- Standard audio cables
- Component video cables
 - You can connect the component video cables (plus audio cables) from the DVD player or satellite receiver to the **ColorStream** terminal on the TV. The **ColorStream HD** terminal can be used to display Progressive (480p, 720p, 1080p) and Interlaced (480i, 1080i). Please check the Owner's Manual of the DVD player or satellite in order to determine the best output signal available (1080p 24 Hz/30 Hz/50 Hz/25 Hz are not supported).
 - If your DVD player or satellite receiver does not have component video, connect a standard A/V cable to **VIDEO** on the side panel. If your DVD player has HDMI video, see page 17.

Note: When you use ColorStream HD or Video, switch AV input mode appropriately (⏏ "Setting AV Input mode" on page 36).

To view antenna or Cable channels:

Press **(INPUT)** and **▲** or **▼** to select the **ANT/CABLE**.

To view the DVD player:

Turn ON the DVD player. Press **(INPUT)** and **▲** or **▼** to select the **ColorStream HD**.

To view satellite programs using the component video connections:

Turn on the satellite receiver. Press **(INPUT)** and **▲** or **▼** to select the **ColorStream HD**.

To view the VCR or view and record antenna channels:

Turn ON the VCR. Tune the VCR to the channel you want to watch. Press **(INPUT)** and **▲** or **▼** to select the **VIDEO**.

To record a TV program while watching a DVD:

Turn ON the VCR. Tune the VCR to the channel to record.

Note: To program the TV remote control to operate other devices, see Chapter 3.

The unauthorized recording, use, distribution, or revision of television programs, videotapes, DVDs, and other materials is prohibited under the Copyright Laws of the United States and other countries, and may subject you to civil and criminal liability.

Connecting a device to the IR OUT infrared terminal using the IR blaster cable for IR pass-through device control

You can use the TV's **IR OUT** terminal to remotely operate many infrared remote-controlled devices enclosed within an entertainment center or similar cabinet.

You will need:

- Dual-wand IR blaster cable (see page 13)
- Other cables as required to connect the device(s) to the TV (see pages 14, 15 and 17)

To connect the IR blaster cable:

- 1 Locate the infrared sensor on the front of your device. This sensor is marked on some devices.*
- 2 Align one of the IR blaster cable's wands about 1 inch away from the infrared sensor on the front of the device and attach it using double-sided mounting tape. If you have a second device, attach the second wand in a similar manner.

Note: If you do not have a second device, coil the second wand with a rubber band and leave it behind the TV.

- 3 Plug the IR blaster cable's plug into the TV's **IR OUT** terminal.

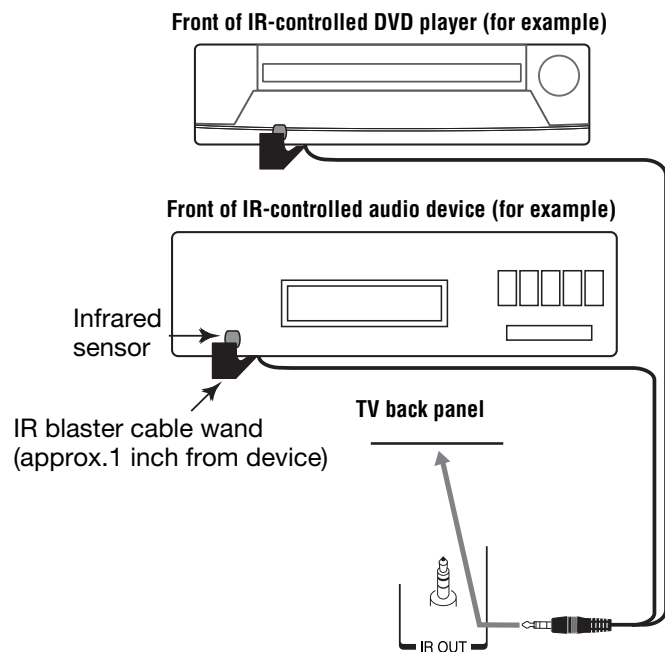

To control the device(s):

Point either the device's remote control or the TV remote control (that you previously programmed to operate the device; see Chapter 3) toward the front of the TV and press the button for the desired function. The signal passes from the remote control through the TV to the device via the IR blaster cable.

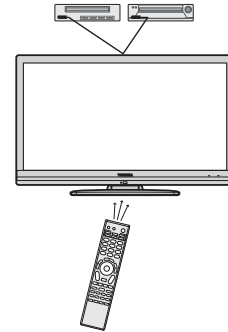

Note:

- To program the remote control to operate the device(s), see "Programming the remote control to operate your other devices" (see page 28).
- The IR pass-through feature does not support all IR-controlled devices; satisfactory performance may not be attainable with certain devices.

*If you cannot locate the device's infrared sensor:

- 1 Turn OFF the device.
- 2 Starting at the lower left corner of the device, place the end of the device's remote control (with the infrared emitter) so it touches the front of the device and press **POWER**. (Do not use the TV's remote control for this step.)
- 3 If the device turns on, the point at which the remote control touched the device is the location of the sensor.
- 4 If the device does not turn on, move the remote control slightly to the right and press **POWER** again.
- 5 Repeat step 4 until you locate the device's infrared sensor.

Connecting an HDMI® or DVI device to the HDMI input

The HDMI input on your TV receives digital audio and uncompressed digital video from an HDMI source device, or uncompressed digital video from a DVI (Digital Visual Interface) source device. This input is designed to accept HDCP (High-Bandwidth Digital-Content Protection) program material in digital form from EIA/CEA-861-D compliant[1] consumer electronic devices (such as a set-top box or DVD player with HDMI or DVI output). Supported signal formats: VGA, SVGA, XGA, WXGA, SXGA, 480i (60Hz), 480p (60Hz), 720p (60Hz), 1080i (60Hz), 1080p (24Hz/60Hz). For detailed signal specifications, see page 89. Supported Audio format: Linear PCM, Dolby Digital (AC-3), sampling rate 32/44.1/48 kHz.

Note:

- To connect a PC to the HDMI input, see page 20.
- Some legacy HDMI sources may not work properly with your HDMI TV, due to the adoption of new standards. Please try setting the following options (Content Type and INSTAPORT™) to Off. See “Using the HDMI settings feature” (page 49).

To connect an HDMI device, you will need:

- one HDMI cable per HDMI device
 - For proper operation, it is recommended that you use an HDMI cable with the HDMI Logo (HDMI).
 - To display an 1080p/60 Hz signal format, you will need a High Speed HDMI cable. Conventional HDMI/DVI cable may not work properly.
 - HDMI cable transfers both video and audio. Separate analog audio cables are not required.
 - See “Setting the HDMI audio mode” (page 49).

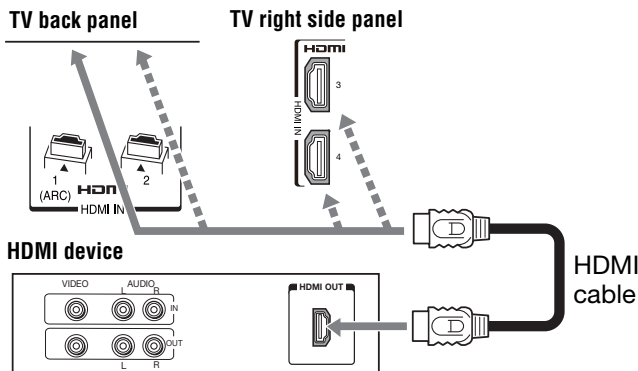

To view the HDMI device video:

Press **INPUT** and **▲** or **▼** to select the **HDMI 1**, **HDMI 2**, **HDMI 3** or **HDMI 4**.

Note: To program the TV remote control to operate other devices, see Chapter 3.

To connect a DVI device, you will need:

- One HDMI-to-DVI adapter cable
 - For proper operation, the length of an HDMI-to-DVI adapter cable should not exceed 9.8 ft (3m). The recommended length is 6.6 ft (2m).
- One 3.5mm Stereo to RCA Y-Cable
 - An HDMI-to-DVI adapter cable transfers video only. Separate analog audio cables are required.
 - See “Setting the HDMI audio mode” (page 49).

TV back panel

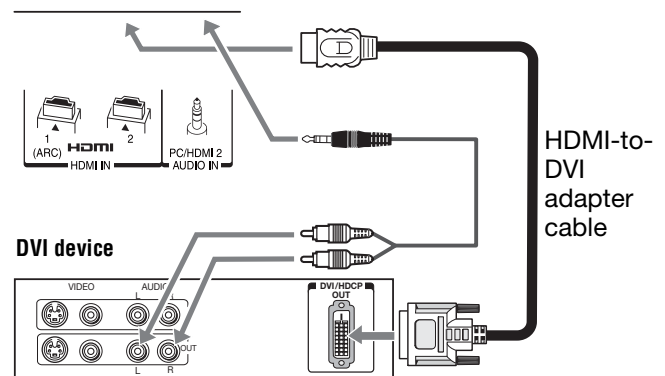

Note: To ensure that the HDMI or DVI device is reset properly, it is recommended that you follow these procedures:

- When turning on your electronic components, **turn on the TV first** and then the HDMI or DVI device.
- When turning off your electronic components, **turn off the HDMI or DVI device first** and then the TV.

[1] EIA/CEA-861-D compliance covers the transmission of uncompressed digital video with high-bandwidth digital content protection, which is being standardized for reception of high-definition video signals. Because this is an evolving technology, it is possible that some devices may not operate properly with the TV.

HDMI, the HDMI Logo, and High-Definition Multimedia Interface are trademarks or registered trademarks of HDMI Licensing LLC in the United States and other countries.

REGZA-LINK® connection

You can control the basic functions of connected audio/video devices using the TV's remote control if you connect a REGZA-LINK® compatible audio receiver or playback device. The REGZA-LINK® feature uses the CEC technology as regulated by the HDMI standard.

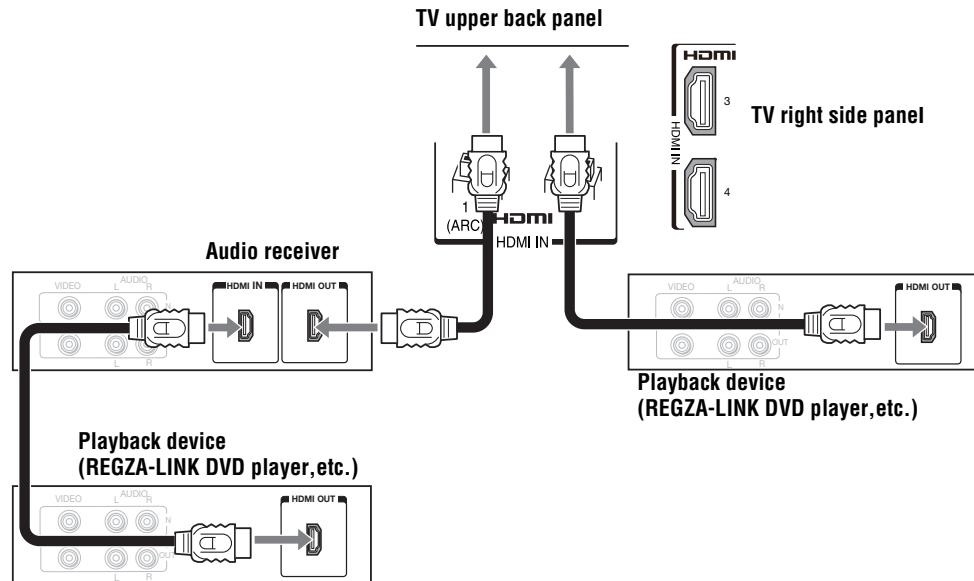

To connect an audio receiver and playback devices, you will need:

- HDMI cables (see page 13)

Note:

- If several devices are connected, REGZA-LINK® feature may not operate properly.
- For proper operation, it is recommended that you use HDMI cables with the HDMI Logo (HDMI).

Before controlling the device(s):

- For an explanation of setup and operations, see pages 47–48.
- The connected devices must also be set. For details, see the operation manual for each device.

Note: This feature is limited to models incorporating Toshiba's REGZA-LINK. However, Toshiba is not liable for those operations. Refer to the individual instruction manuals for compatibility information.

Connecting a HDMI audio system

HDMI audio system is available if your AV amplifier corresponds to ARC.

You will need:

- HDMI cable

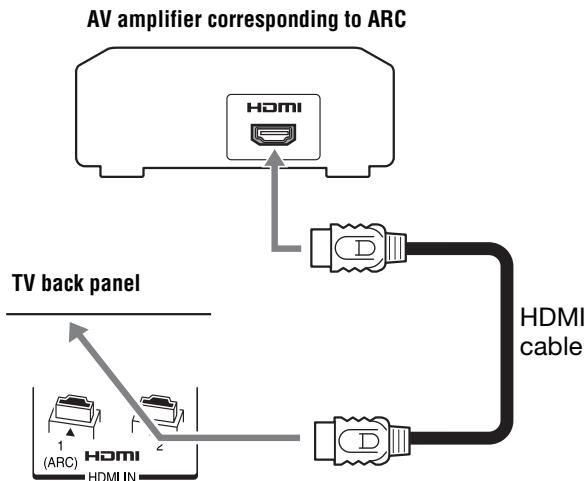

HDMI's ARC (Audio Return Channel) feature

This feature enables the audio signal of the TV to be sent to the AV amplifier via the HDMI cable. It will not be necessary to connect a cable from the audio output of the TV to the audio input of the AV amplifier to reproduce the audio received from the tuner of the TV through the AV amplifier.

Connecting a digital audio system

The TV's **DIGITAL AUDIO OUT** terminal outputs a Dolby® Digital or 2-channel down-mixed PCM (pulse-code modulation) signal for use with an external Dolby Digital decoder or other external audio system with optical audio input.

You will need:

- Optical audio cable (Use an optical audio cable that has the larger "TosLink" connector and not the smaller "mini-optical" connector.)

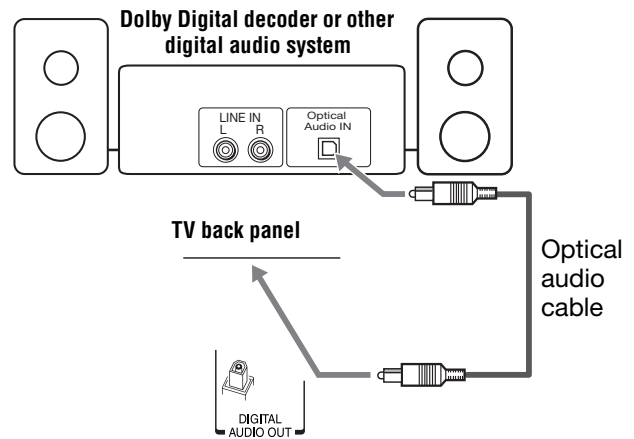

Before controlling the audio:

- See "Selecting the optical audio output format" (page 62).

Note:

- Some audio systems may not be compatible with Dolby Digital bitstream signals. Older audio systems that are not compatible with standard optical out signals may not work properly, creating a high noise level that may damage speakers or headphones. **THIS DAMAGE IS NOT COVERED BY YOUR WARRANTY.**
- The DIGITAL AUDIO OUT terminal may not output some digital audio sources because of copy restrictions.
- The Dolby Digital format is available in the following situations:
 - When tuned to a digital RF channel or HDMI input.
 - When DLNA Certified products or VUDU is used.

Manufactured under license from Dolby Laboratories. Dolby, and the double-D symbol are trademarks of Dolby Laboratories.

Connecting a personal computer (PC)

With either the **PC IN** or **HDMI** connection, you can watch your computer's display on the TV and hear the sound from the TV's speakers.

To connect a PC to the PC IN terminal on the TV, you will need:

- Analog RGB (15-pin) computer cable
- PC audio cable

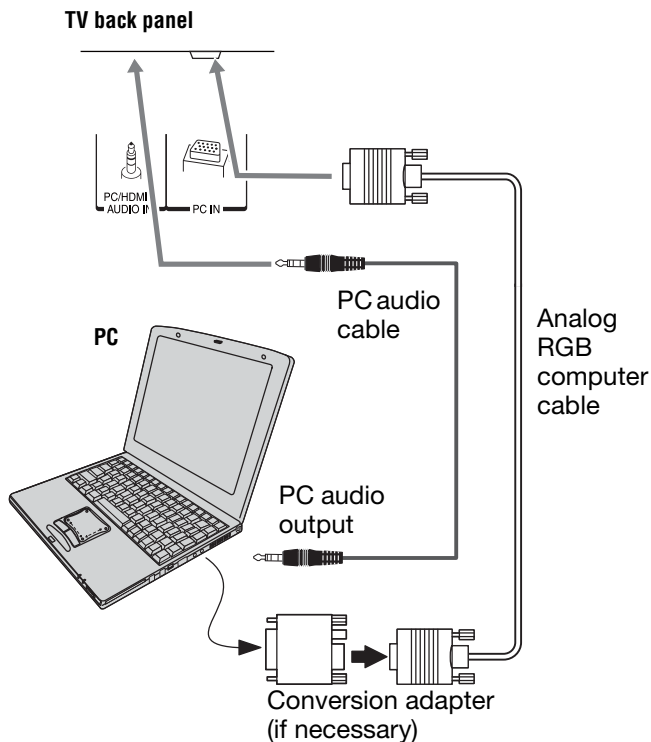

Before using the PC:

See "Using the PC settings feature" (page 50).

To use a PC:

- Set the monitor output resolution on the PC before connecting it to the TV.
- Supported signal formats: VGA, SVGA, XGA, WXGA, SXGA. For detailed signal specifications, see page 88.

Note:

- The PC audio input terminals on the TV are shared with the HDMI 2 analog audio input terminals.
- Some PC models cannot be connected to this TV.
- An adapter is not needed for computers with a compatible mini D-sub 15-pin terminal.
- Depending on the DVD's title and the specifications of the PC on which you are playing the DVD-Video, some scenes may be skipped or you may not be able to pause during multi-angle scenes.

Signal names for mini D-sub 15-pin connector

Pin No.	Signal name	Pin No.	Signal name	Pin No.	Signal name
1	R	6	Ground	11	NC
2	G	7	Ground	12	NC
3	B	8	Ground	13	H-sync
4	NC *	9	NC	14	V-sync
5	NC	10	Ground	15	NC

* NC=Not connected

To connect a PC to the HDMI terminal on the TV, you will need:

If your PC has no HDMI terminal:

- Adapter cable
- Analog audio cable

If your PC has HDMI or DVI terminal:

- HDMI cable or HDMI-to-DVI adapter cable

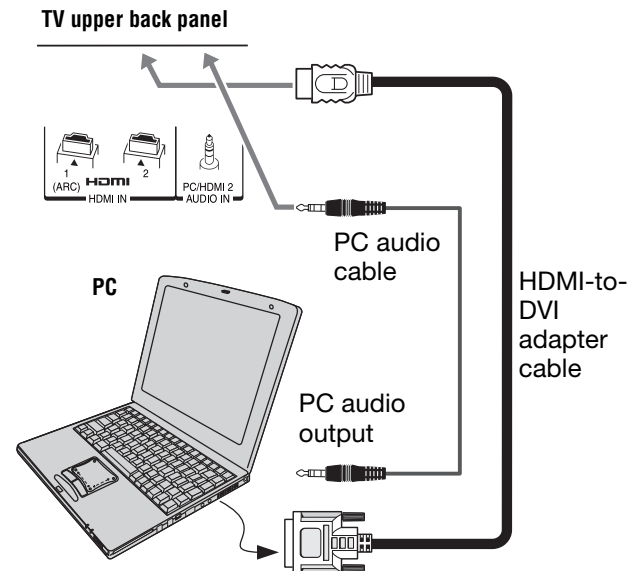

Supported signal formats: VGA, SVGA, XGA, WXGA, SXGA, 480i (60Hz), 480p (60Hz), 720p (60Hz), 1080i (60Hz), 1080p (24Hz/60Hz). For detailed signal specifications, see page 89.

Note: The edges of the images may be hidden.

Connecting a home network

The LAN port allows your Toshiba TV to connect to your home network. You can use this home network to access photo, movie and music files that are stored on a DLNA CERTIFIED™ Server and play them on your TV.

Connecting the TV directly to a PC without an Internet connection

- You will need:
- Crossover LAN cable

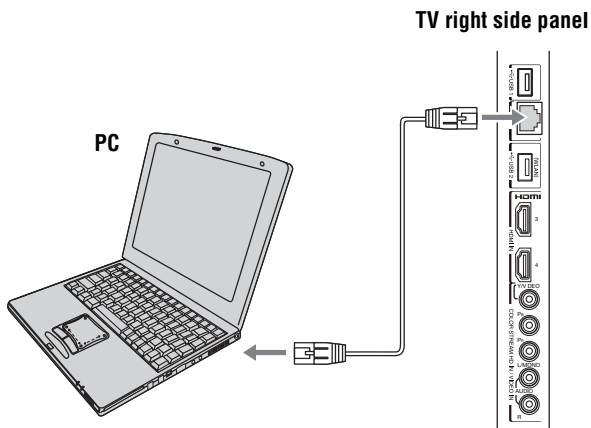

Connecting the TV to a home network without an Internet connection

- You will need:
- Standard LAN cables
 - Router with Hub

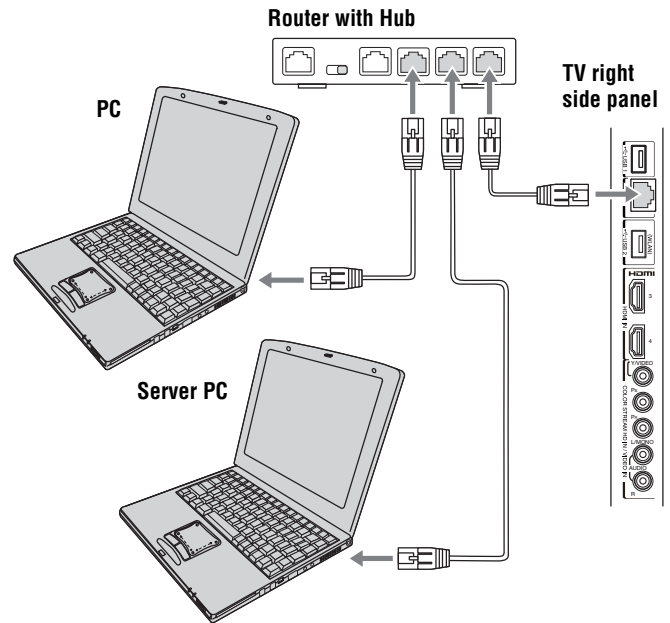

Connecting the TV to a home network with an Internet connection - Cable

You will need:

- Coaxial or telephone cable (depending on your modem type)
- Standard LAN cables
- Router with Hub
- Modem (DSL or cable)

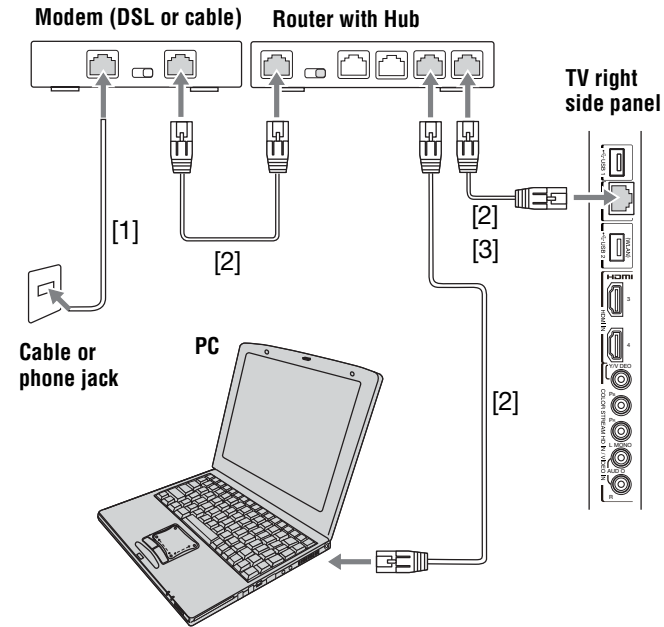

- [1] Coaxial or telephone cable (depending on your modem type)
- [2] Standard LAN cable
- [3] Do NOT connect a phone jack directly to the TV's LAN port.

Connecting the TV to a home network with an Internet connection - Wireless

You will need:

- Coaxial or telephone cable (depending on your modem type)
- Standard LAN cables
- Dual Band WLAN Adapter (WLM-10U1)
(👉 Specifications are on page 87.)
- Wireless LAN access point
- Modem (DSL or cable)

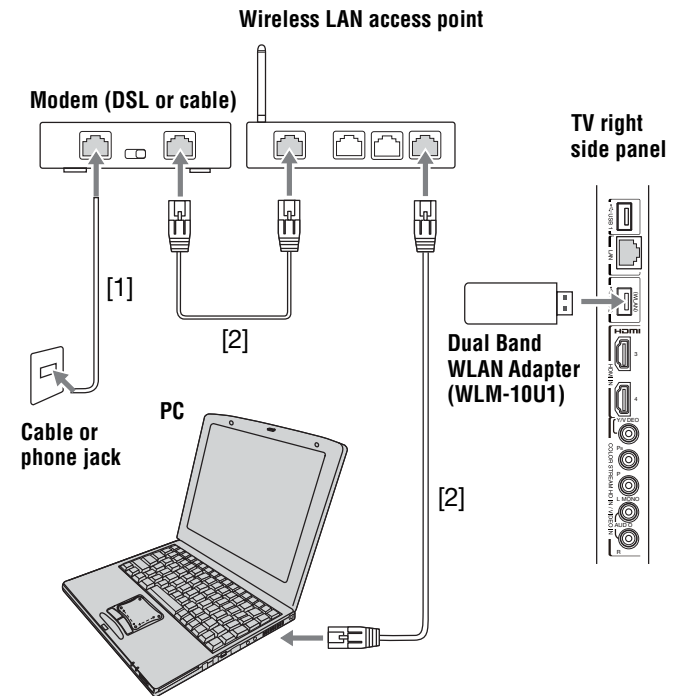

The transmission speed over the wireless LAN and the distance over which wireless LAN can reach may vary depending on surrounding electromagnetic environment, obstacles, access point design and configuration, and client design and software/hardware configurations. The actual transmission speed will be lower than the theoretical maximum speed.

The Dual Band WLAN Adapter is based on the IEEE 802.11n specification and may not be fully compatible with, or support some features (e.g., security) of certain Wi-Fi equipment that are based on the draft version of IEEE 802.11n.

- [1] Coaxial or telephone cable (depending on your modem type)
- [2] Standard LAN cable

Chapter 3: Using the remote control

Preparing the remote control for use

Your TV remote control can operate your TV and many other devices such as cable converter boxes, satellite receivers, VCRs, DVD players, and HTIBs (home theater in a box), even if they are different brands.

If you have a Toshiba device:

Your TV remote control is preprogrammed to operate most Toshiba devices (see page 26).

If you have a non-Toshiba device or a Toshiba device that the remote control is not preprogrammed to operate:

You can program the TV remote control so it will operate the other device (see page 28).

Installing the remote control batteries

- 1 Slide the battery cover off the back of the remote control.

Squeeze tab and lift cover.

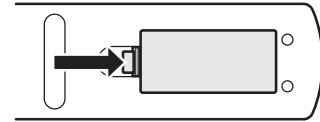

- 2 Install two “AAA” size carbon zinc batteries. Match the + and – symbols on the batteries to the symbols on the battery compartment.

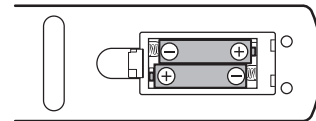

- 3 Slide the battery cover on to the remote control until the lock snaps.

Caution: Batteries must not be exposed to excessive heat such as sunshine, fire or the like.

Note:

- Be sure to use AAA size carbon zinc batteries.
- Dispose of batteries in a designated disposal area.
- Batteries should always be disposed of with the environment in mind. Always dispose of batteries in accordance with applicable laws and regulations.
- If the remote control does not operate correctly, or if the operating range becomes reduced, replace batteries with new ones.
- When necessary to replace batteries in the remote control, always replace both batteries with new ones. Never mix battery types or use new and used batteries in combination.
- Always remove batteries from the remote control if they are dead or if the remote control is not to be used for an extended period of time. This will prevent battery acid from leaking into the battery compartment.

Learning about the remote control

The buttons used for operating the TV only are described here.

For the REGZA-LINK remote control functions, see “REGZA-LINK® playback device control” (page 47). For a complete list of the remote control’s functions, see “Remote control functional key chart” (pages 26–27).

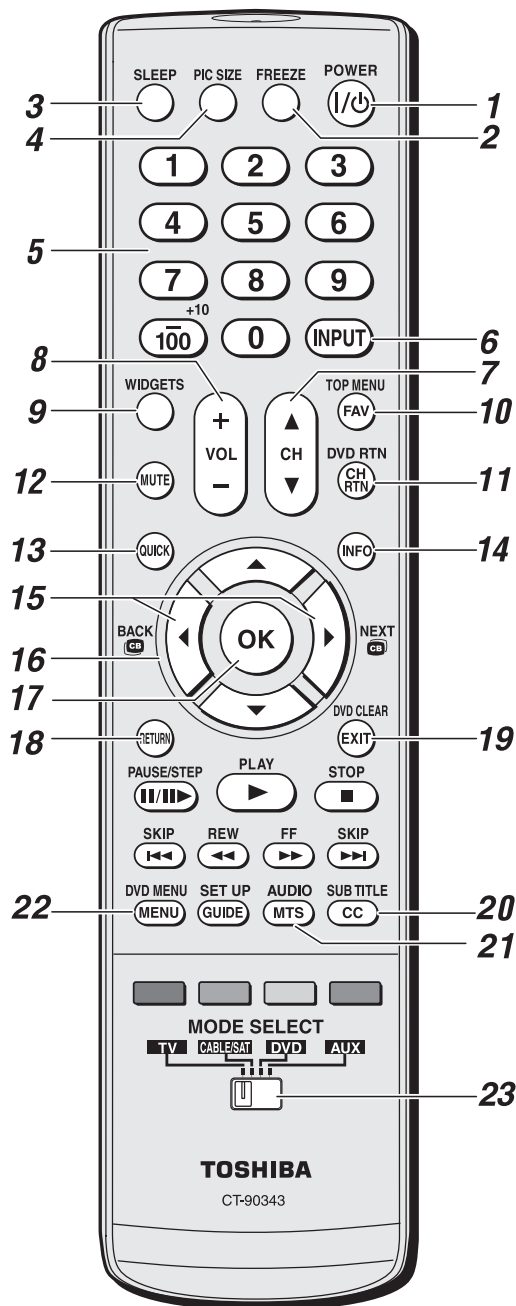

- 1 **POWER** turns the TV on and off.
- 2 **FREEZE** freezes the picture. Press again to restore the moving picture (page 56).
- 3 **SLEEP** accesses the sleep timer (page 51).
- 4 **PIC SIZE** cycles through the picture sizes (page 54).
- 5 **Channel Numbers (0–9, –/100)** directly tune channels. The **100** button is used to enter two part channel numbers (page 38) or to edit the Favorites List (page 40).
- 6 **INPUT** selects the video input source (page 41).
- 7 **CH▲▼** cycles through programmed channels when no menu is on-screen.
- 8 **VOL + –** adjusts the volume level.
- 9 **WIDGETS** accesses Widgets menu.
- 10 **FAV** accesses the Favorites List in the Channel Browser™ (page 40).
- 11 **CH RTN** returns to the last viewed channel or source (page 41).
- 12 **MUTE** reduces or turns off the sound (page 62).
- 13 **QUICK** accesses Quick menu.
- 14 **INFO** displays TV status information as well as program details, when available (page 53).
- 15 **BACK / NEXT** While watching TV, these buttons open the Channel Browser™ and tune to the previous/next channel in the channel history.
- 16 **Arrow buttons (▲▼◀▶)** When a menu is on-screen, these buttons select or adjust programming menus.
- 17 **OK** activates highlighted items in the main menu system.
- 18 **RETURN** returns to previous menu.
- 19 **EXIT** closes on-screen menus.
- 20 **CC** opens the closed caption selector (page 42).
- 21 **MTS** selects the audio mode.
- 22 **MENU** accesses the main TV menu system (pages 32 and 33).
- 23 **MODE SELECT** switch selects between TV, CABLE/SAT, DVD, and AUX modes. Set to “TV” to control the TV.

Note: The error message “NOT AVAILABLE” may appear if you press a key for a function that is not available.

Using the remote control to control your other devices

If you have a non-Toshiba device or a Toshiba device that the remote control is not preprogrammed to operate, you must first program the remote control to recognize the device (if you have not already done so) (page 28).

To use your TV remote control to operate:

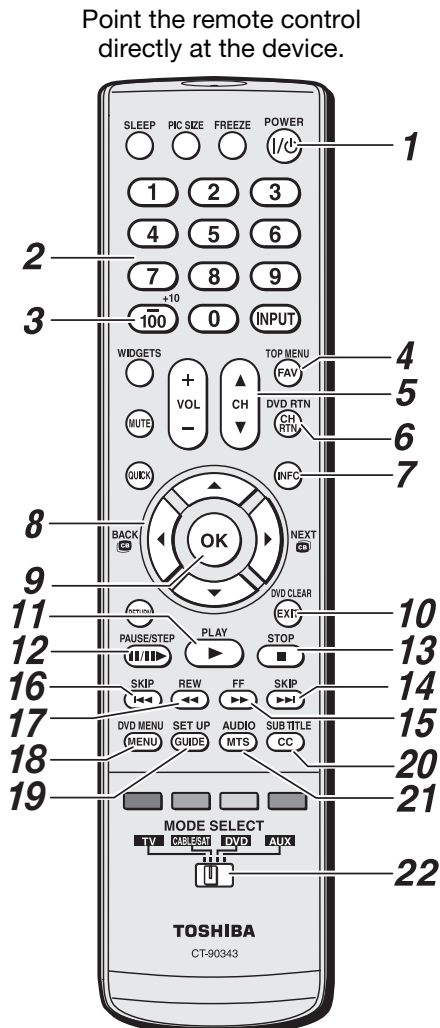

- Cable converter box or satellite receiver, set the **MODE SELECT** switch to **CABLE/SAT**.
- DVD player or HTIB, set the **MODE SELECT** switch to **DVD**.
- VCR, set the **MODE SELECT** switch to **AUX**.

Note: Even after the TV remote control is programmed, it may not operate certain features on any other devices. If this happens and you wish to use those features, you will need to use the device's original remote control.



- 1 POWER** Turns the selected device on and off.
- 2 Channel Numbers (0-9)** Press to directly access channels (as opposed to \uparrow \downarrow).
- 3 +10** Press to directly access DVD chapters higher than 10.
- 4 TOP MENU** Accesses a DVD's top menu.
- 5 CH ▲▼** For channels programmed into the channel memory (page 35):
▲ selects the next higher channel.
▼ selects the next lower channel.
- 6 DVD RTN** Returns to previous DVD's menu.
- 7 INFO** Displays TV status information on-screen.
- 8 ▲▼◀▶** Press to navigate DVD menus (may not work on some DVD players).
- 9 OK** Required by some satellite receivers and DVD players to activate certain functions.
- 10 EXIT** Closes on-screen menus.
DVD CLEAR Press to reset the title and chapter number.
- 11 PLAY** Begins playback of a tape or DVD.
- 12 PAUSE** Press during play or record mode to pause the picture; press again to restart.
- 13 STOP** Stops the tape or DVD.
- 14 SKIP ▶▶** Skips forward to locate later DVD chapters.
- 15 FF** Fast-forwards the tape or DVD. (Press during play mode to view the picture moving rapidly forward.)
- 16 SKIP ◀◀** Skips back to beginning of current DVD chapter, or locates previous chapters.
- 17 REW** Rewinds/reverses the tape or DVD. (Press during play mode to view the picture moving rapidly backward.)
- 18 MENU** Accesses the menu in CABLE/SAT mode.
DVD MENU Accesses the DVD menu in DVD mode.
- 19 GUIDE** Displays the channel guide in CABLE/SAT mode.
SET UP Accesses a DVD's setup menu in AUX mode.
- 20 SUBTITLE** Accesses subtitles if available.
- 21 AUDIO** Accesses the Audio menu.
- 22 MODE SELECT** Switches set to "TV" to control the TV; "CABLE/SAT" to control a cable converter box or satellite receiver; "DVD" to control a DVD player, HTIB or BD; "AUX" to control a VCR.

Remote control functional key chart

REMOTE CONTROL KEY	Toshiba TV	CABLE	SAT (satellite)	DVD	AUX (VCR)
SLEEP	Sleep	← TV	← TV	← TV	← TV
PIC SIZE	Picture Size	← TV	← TV	← TV	← TV
FREEZE	FREEZE	← TV	← TV	← TV	← TV
POWER	Power	Power	Power	Power	Power
1	Digit 1	Digit 1	Digit 1	Digit 1	Digit 1
2	Digit 2	Digit 2	Digit 2	Digit 2	Digit 2
3	Digit 3	Digit 3	Digit 3	Digit 3	Digit 3
4	Digit 4	Digit 4	Digit 4	Digit 4	Digit 4
5	Digit 5	Digit 5	Digit 5	Digit 5	Digit 5
6	Digit 6	Digit 6	Digit 6	Digit 6	Digit 6
7	Digit 7	Digit 7	Digit 7	Digit 7	Digit 7
8	Digit 8	Digit 8	Digit 8	Digit 8	Digit 8
9	Digit 9	Digit 9	Digit 9	Digit 9	Digit 9
0	Digit 0	Digit 0	Digit 0	Digit 0	Digit 0
- /100/ +10	- (sub channel)	---	- (sub CH)	+10	100
INPUT	Input	← TV	← TV	← TV	← TV
WIDGETS	Widgets	---	---	---	---
MUTE	Mute	← TV	← TV	← TV	← TV
QUICK	Quick Menu	---	---	---	---
VOL + -	Volume Up/Down	← TV	← TV	← TV	← TV
CH▲▼	Channel Up/Down	Channel Up/ Down	Channel Up/ Down	---	Channel Up/ Down
FAV/TOP MENU	FAV Browser	---	---	Top Menu	---
CH RTN/DVD RTN	Last Channel	---	---	DVD Return	---
INFO	Info	---	Info	Display	---
OK	OK	---	Select, Enter	Enter	---
▲	Menu Up / FAV Up	---	Menu Up	Menu Up	---
▼	Menu Down / FAV Down	---	Menu Down	Menu Down	---
◀ 	Menu Left/ BACK C/B Back	---	Menu Left	Menu Left	---
▶ 	Menu Right/ NEXT C/B Next	---	Menu Right	Menu Right	---
RETURN	Return	---	---	---	---
EXIT/DVD CLEAR	Exit	---	Exit	DVD Clear	---
PAUSE/STEP	Pause*	---	---	Pause	Pause
PLAY	Play*	---	---	Play	Play
STOP	Stop*	---	---	Stop	Stop
SKIP ◀◀	Skip REV* / DAY-	---	---	Skip REV	---
SKIP ▶▶	Skip FWD* / DAY+	---	---	Skip FWD	---
REW	REW*	---	---	Rewind	Rewind
FF	FF*	---	---	Fast FWD	Fast FWD
MENU/DVD MENU	Menu	---	Menu	DVD Menu	---

Chapter 3: Using the remote control



REMOTE CONTROL KEY	Toshiba TV	CABLE	SAT (satellite)	DVD	AUX (VCR)
GUIDE/SET UP	---	---	SAT Guide	Setup	---
MTS/AUDIO	MTS	---	---	Audio	---
CC/SUBTITLE	CC	---	---	Subtitle	---
RED	Red*	---	---	---	---
GREEN	Green*	---	---	---	---
YELLOW	Yellow*	---	---	---	---
BLUE	Blue*	---	---	---	---

Note:

- “---” = key does not send a signal in that remote control mode.
- “← TV” = key will affect the TV, even though the remote control is in another mode.
- “*” = This function is available for REGZA-LINK® (see page 47).

Programming the remote control to operate your other devices

Your Toshiba TV remote control is preprogrammed to operate most Toshiba devices. To program your TV remote control to operate a non-Toshiba device (or a Toshiba device that it is not preprogrammed to operate), follow the steps below. For details on using the remote control to operate the device, see page 25.

- 1 In the remote control code table (pages 29–31), find the code for your device. If more than one code is listed, try each one separately until you find one that works.
- 2 Set the **MODE SELECT** switch to the type of device you are programming the remote control to operate — CABLE/SAT (for a cable converter box or satellite receiver), DVD (for a DVD player, HTIB [home theater in a box] or BD), or AUX (for a VCR or TV/VCR combo).
- 3 While holding down , press the Channel Number buttons to enter the 3-digit code for your device.
- 4 To test the code, turn on the device, point the remote control at it, and press . See notes below.
 - If the correct code was entered, the device will turn off.
 - If the device does not respond, repeat steps 1 – 4 using another code.
 - If the device does not respond to another code, you will need to use the remote control that came with the device.
- 5 Remember to set the **MODE SELECT** switch back to “TV” to control the TV.
- 6 For future reference, write down the code(s) you used:

DEVICE	CODE	DEVICE	CODE

Note:

- In addition to POWER, confirm that all necessary keys on the TV remote control operate your device. If some keys are not operational, repeat the device code setup using another code (if other codes are listed for your device). If, after trying all listed codes, the necessary keys do not operate your device, use the device’s original remote control.
- Every time you change the batteries, you will need to reprogram the remote control.
- Some newer VCRs respond to either of two codes. These VCRs have a switch labeled “VCR1/VCR2.” If your VCR

has this kind of switch and does not respond to the codes for your VCR brand, set the switch to the other position (“VCR1” or “VCR2”) and reprogram the remote control.

Remote control codes

In some cases, you may not be able to operate your device with the TV remote control. Your device may use a code that is not recognized by the TV remote control. If this happens, use the device's remote control.

Cable converter box

Brand	Code
ABC	061, 062, 063, 082, 084, 087, 092, 096, 098
Archer	065, 092, 097, 099
Cableview	064, 094
Century	092
Citizen	090, 092, 097
Contec	083, 085, 086, 088, 093, 098
Diamond	093
GE	061, 062
Gemini	069, 070, 094
Hamlin	093
Hitachi	062, 095, 096
Jasco	097
Motorola/GI/Jerrold	062, 069, 071, 082, 086, 089, 096, 107
Magnavox	072, 096
Memorex	092, 104
Multi Canal	090
Novavision	101
Panasonic	081, 083, 085
Philco	087
Philips	066, 067, 068, 070, 072, 073, 074, 075, 092
Pioneer	076, 077
Proscan	061, 062
Radio Shack	092, 097, 099
RCA	064, 081
Realistic	065
Recoton	102
Samsung	077, 090
Scientific Atlanta	063, 078, 079, 080, 088, 098, 101, 105
Sears	095
Signature	062
Signature 2000	096
Sprucer	081, 085
Starcom	069, 082, 087, 096, 103, 104

Stargate	069, 090
Sylvania	095, 100
TeleView	090
Texscan	100
Tocom	071, 084, 085
U. S. Electronics	087, 096, 098
United Cable	082
Universal	065, 092, 097, 099, 102, 103
Wards	096

Satellite receiver

Brand	Code
Alphastar	038, 059
Chaparral	034
DISH Network	057
Drake	020, 040, 044, 046, 050, 053
Echostar	018, 041, 051
Express Vu	057
Fujitsu	027
GE	008, 009, 013
General	010, 011, 012, 022, 023, 031, 049
Instruments	049
Hitachi	033
Hughes	033
Hughes Network Systems	019
Intersat	048
Janeil	027
JVC	017, 057
Kenwood	029
Magnavox	060
Optimus	058
Pansat	036, 052
Primestar	015, 042
Proscan	008, 009, 013
Radio Shack	022, 023, 030
RCA	008, 009, 013, 016
Realistic	030
Samsung	059
Sony	014, 055
Star Choice	057, 106
Star Trak	025, 026, 037, 054
STS	024
Toshiba	000, 001, 002, 003, 004, 005, 006, 007, 020, 031, 056
Uniden	021, 028, 030, 032, 035, 039, 043, 045, 047, 058
Zenith	027

TV/VCR Combo

Brand	Code
Action	078
GE	059, 062
Goldstar	065
Panasonic	065
Precision	078
Quasar	065
Realistic	079
Sony	074
Toshiba	057
Zenith	065
Totevision	009, 010, 065

DVD/VCR Combo

Brand	Code
Go Video	DVD=087, VCR=081
JVC	DVD=088, VCR=082
RCA	DVD=089, VCR=083
Samsung	DVD=090, VCR=084
Sanyo	DVD=091, VCR=085
Zenith	DVD=092, VCR=086

DVD player

Brand	Code
Aiwa	006, 015
Apex	016, 017
BOSE	097
Broksonic	018
Clarion	019
Classic	020
Daewoo	021
Denon	022, 023, 024, 025
Emerson	026, 027
Fisher	028
Funai	027
GE	001, 029, 030
Go Video	087
GPX	031
Hitachi	005, 032, 033, 034, 035
JVC	003, 007, 036, 042, 088
Kenwood	037
Konka	008, 009
Magnavox	004, 038
Memorex	039
Mintek	040
NAD	026
Nakamichi	041

Chapter 3: Using the remote control

Norcent	043
Onkyo	044
Oritron	058
Panasonic	010, 045, 046, 047, 048, 049, 050
Philips	004, 051
Pioneer	052, 053, 054, 055
Proscan	001, 056
Qwestar	057, 058
RCA	001, 002, 059, 089
Sampo	060
Samsung	061, 062, 086, 090
Sansui	073
Sanyo	063, 091
Sharp	064, 067
Sherwood	074
Sony	011, 012, 065, 066, 068, 069, 070
Sylvania	027
Teac	071
Technics	072
Techwood	075
Toshiba	000, 013, 076, 077, 078, 100, 101
Yamaha	079, 080, 081
Zenith	014, 082, 092

Portable DVD player

Brand	Code
Aiwa	093
Audiovox	094, 095
Panasonic	024, 096, 099
RCA	098

VCR

Brand	Code
Admiral	049
Aiko	019
Aiwa	018
Akai	003, 004, 037, 038, 039, 058, 069
Audiovox	010
Bell & Howell	007, 068
Broksonic	008, 017
Calix	010
Carver	026
CCE	019
Citizen	009, 010, 011, 012, 013, 014, 015, 019, 057, 073

Colortyme	005
Craig	009, 010, 016, 061, 065, 079
Curtis Mathes	001, 005, 009, 012, 014, 040, 048, 053, 056, 057
Daewoo	011, 013, 015, 017, 018, 019, 057, 078
Daytron	078
Denon	063
Dimensia	001, 048
Electrohome	010, 020, 065
Emerson	003, 008, 010, 011, 017, 018, 020, 028, 039, 054, 057, 062, 065, 068, 072
Fisher	007, 016, 021, 022, 023, 057, 064, 068, 070, 071, 079
Fuji	004, 041
Funai	018, 073
Garrard	018
GE	001, 002, 009, 040, 042, 048, 056
Go Video	056, 059, 061, 081
Goldstar	005, 010, 014, 054, 056, 065, 067
Gradiente	018, 065
Harman Kardon	005
Hitachi	024, 025, 035, 037, 042, 063, 070, 080
JBL	076
JC Penney	005, 006, 007, 008, 009, 010, 023, 024, 025, 026, 035, 056, 061, 063, 065
Jensen	024, 025, 037, 050
JVC	005, 006, 007, 014, 037, 043, 055, 062, 063, 068, 082
Kenwood	005, 006, 007, 012, 014, 037, 043, 050, 053, 068, 071
Kodak	010
LG	010
Lloyds	053, 073, 079
Logik	061
LXI	010
Magnasonic	061, 065, 078

Magnavox	026, 027, 034, 044, 057, 061, 072
Marantz	005, 006, 007, 012, 014, 026, 053, 067
Memorex	007, 009, 010, 016, 018, 034, 049, 063, 065, 066, 068, 075, 079
MGA	020, 028, 039
MGN	056
Minolta	024, 025, 035, 063
Mitsubishi	020, 024, 025, 028, 039, 043, 065
Montgomery Ward	049
Motorola	049
MTC	009, 046, 061
Multitech	009, 012, 018
NEC	005, 006, 007, 012, 014, 037, 043, 053, 054, 067, 070
Nikko	010
Noblex	009
Optimus	010, 049, 065
Optonica	031
Orion	054, 057, 062, 065, 068, 072
Panasonic	036, 045, 046, 057, 061, 072, 079
Pentax	012, 024, 025, 035, 042, 053, 063
Pentax Research	014
Philco	026, 027, 063
Philips	026, 031, 044, 057
Pioneer	006, 024, 043, 055
Portland	012, 013, 015
Proscan	001, 002, 048
Proton	061
Quasar	045
Radio Shack	010, 031, 065
Radio Shack/ Realistic	007, 009, 010, 016, 018, 020, 021, 022, 031, 049
Radix	010
RCA	001, 002, 003, 009, 024, 025, 029, 035, 040, 042, 045, 048, 055, 056, 063, 071, 083

Realistic	007, 009, 010, 011, 016, 018, 020, 021, 022, 031, 049, 051, 056, 060, 065, 075, 079
Ricoh	047
Runco	034
Samsung	009, 011, 038, 056, 073, 084
Sansui	006, 037, 043, 061
Sanyo	007, 009, 016, 054, 064, 068, 071, 075, 079, 085
Scott	008, 011, 017, 028, 030, 057, 065, 072
Sears	007, 010, 016, 021, 022, 023, 024, 025, 035, 053, 057, 063, 064, 065, 068, 071, 075, 079
Sharp	013, 020, 031, 049, 051, 060, 066
Shintom	004, 025, 032, 061
Signature	049
Signature 2000	075
Singer	047, 061
Sony	004, 032, 033, 041, 052, 058, 070, 074, 076, 077, 080
STS	035
Sylvania	018, 026, 027, 028, 044, 072
Symphonic	018, 050, 051, 053, 073, 079
Tandy	007
Tashiko	010
Tatung	037
Teac	018, 029, 037
Technics	036
Teknika	010, 018, 065
Toshiba	000, 011, 021, 023, 024, 028, 030, 039, 057, 074, 078, 079
Totevision	009, 010, 065
Unitec	073
Unitech	009
Vector Research	005, 006, 011, 012, 053
Video Concepts	005, 006, 011, 012, 039, 053

Wards	009, 010, 011, 016, 018, 020, 024, 025, 031, 035, 049, 051, 056, 057, 060, 065, 066, 079
White	073
Westinghouse	
XR-1000	018
Yamaha	005, 006, 007, 014, 037, 053
Zenith	004, 032, 034, 041, 047, 069, 086

HTIB

Brand	Code
Lasonic	083
Panasonic	084
Venturer	085





BD

Brand	Code
Denon	135, 136, 137
Hitachi	132, 133, 134
Integra	114
JVC	115, 116, 118, 119, 120, 121
LG	111, 112
Marantz(US)	127, 128
Mitsubishi	125, 126
Onkyo	114
Panasonic	102, 103, 104
Philips	105
Pioneer	106
Samsung	107
Sharp	129, 130, 131
Sony	108, 109, 110, 117
Toshiba	113
Yamaha	122, 123, 124

Chapter 4: Menu layout and navigation



Main menu layout

To open the main menus (illustrated below), press  on the remote control or TV control panel.

Icon	Item	Page
PICTURE 	Picture Mode	57
	Reset	57
	Backlight	57
	Contrast	57
	Brightness	57
	Color	57
	Tint	57
	Sharpness	57
	Advanced Picture Settings	58
	Control Visualization	61
	TheaterLock	61
	MTS	62
	SOUND 	Balance
Advanced Sound Settings		63
Dolby Volume		63
Dynamic Range Control		63
Widgets		71
APPLICATIONS 	VUDU	71
	YouTube	72
	Media Player	75
	Channel Browser	39
	Favorites Browser	40
	On Timer	51
	Sleep Timer	51
	REGZA-LINK Setup	48
	Network Setup	65
	VUDU Deactivation	71
	Media Renderer Setup	70
	Photo Frame Setup	81
PREFERENCES 	Channel Browser Setup	39
	PIN Setting	43
	Parental Control and Locks	43
	Display Settings	50, 56
	AV Connection	36, 49, 50, 62
	Energy Saving Settings	52
	Blue Screen	52
	HDMI Information Display	49
	TOSHIBA Illumination	52

Icon	Item	Page
SETUP 	Menu Language	34
	ANT/CABLE In	35
	Auto Tuning	35
	Manual Tuning	35
	TV Settings	36
	Quick Setup	34
	Location	37
	Software Upgrade	69
	System Information	53
	Reset TV	53

Quick menu

Quick menu helps you access some options quickly. Press  to display the Quick menu and press  or  to select the option.

Note: Quick menu items are different depending on the current mode.

Quick menu Item	Page
PICTURE	54–61
Picture Mode	57
Picture Size	54
Photo Frame	81
Sort	78, 79, 80
Repeat	78, 79, 80
SOUND	62–63
Speakers	48
YouTube	72
Media Player	75
REGZA-LINK Player Control	47
Sleep Timer	51
Interval Time	80
Device Information	78, 79, 80
Wireless Information	67

Navigating the menu system

You can use the buttons on the remote control or TV control panel to access and navigate your TV's on-screen menu system.

- Press **(MENU)** to open the menu.

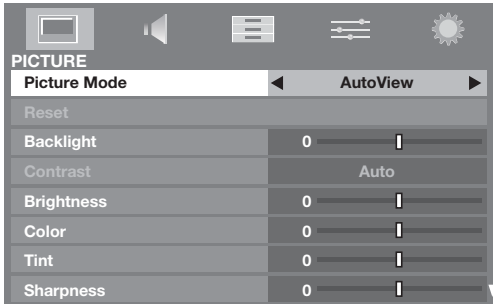

- Press **◀** or **▶** on the remote control or TV control panel to select the top menu, and its respective items will appear below.
- To use the items, press **▲** or **▼** on the remote control or TV control panel to move up and down through them.
- To move to the forward page, press **(OK)**. To return to the previous page, press **(RETURN)**.
- Press **◀** or **▶** to adjust settings.
- All menus will close automatically if you do not make a selection within 60 seconds.
- To close a menu instantly, press **(MENU)** or **(EXIT)**.

Chapter 5: Setting up your TV

Initial Setup

When you first turn on or reset the TV, the Initial Setup window will appear.

- 1 In the **Menu Language** field, press ◀ or ▶ to select your preferred language and press (OK).
- 2 Next, the **Local Time Setting** window will appear. Press ▲ or ▼ to select **Time Zone**, set your desired time zone with ◀ or ▶.
- 3 Then, press ▲ or ▼ to select **Daylight Saving Time**. Press ◀ or ▶ to select **On** or **Off**, and press (OK).
- 4 Next, the **Location** setting window will appear. For normal home use, press ◀ or ▶ to select **Home** and press (OK).
- 5 Next, the **ANT/CABLE In** setup window will appear. Press ▲ or ▼ to highlight **Cable** or **Antenna**, and press (OK) to select the input.
*Note: If you do not want to scan channels, you do not need to make a selection for **ANT/CABLE**. Highlight **Next** and press (OK) to skip this step.*
- 6 If you select **Cable**, and then highlight **Next** and press (OK), channel scan will start. If you select **Antenna**, and then highlight **Next** and press (OK), the **Channel Tuning Mode** setup window will appear. To tune only digital channels, select **Digital**. To tune digital channels preferentially over analog when entering channel number directly, select **Auto**. For normal tuning, select **Standard**. Press (OK).
- 7 Press (OK) to start **Start Scan**.
Note: If you want to stop scanning, press (EXIT) while scanning.

You can stop the Initial Setup with (EXIT). However if you do not finish the entire Initial Setup process, the Initial Setup window will appear every time you turn on the TV.

Note: (EXIT) does not work until the settings of **Menu Language/Time Zone/Location** finish.

Quick Setup from the SETUP menu

You can conveniently change various basic TV settings from the Quick Setup item located under the SETUP menu.

- 1 Press (MENU) to open the **SETUP** menu.
- 2 Press ▲ or ▼ to select **Quick Setup** and press (OK).
- 3 A confirmation message will appear on the screen, press ◀ or ▶ to select **Yes** and press (OK).
- 4 Other procedures are the same as **Initial Setup** (see left-hand column).

Selecting the menu language

You can choose from three different languages (**English**, **Français** and **Español**) for the on-screen display of menus and messages.

- 1 From the **SETUP** menu, highlight **Menu Language**.
- 2 Press ◀ or ▶ to select your preferred language and press (EXIT).

Configuring the antenna input source for the ANT/CABLE terminal

- 1 From the **SETUP** menu, highlight **ANT/CABLE In**.
- 2 Press ◀ or ▶ to select the input source (**Antenna** or **Cable**) for the **ANT/CABLE** input and press (OK).

Programming channels into the TV's channel memory

When you press (CH) or (CH) on the remote control or TV control panel, your TV will stop only on the channels you programmed into the TV's channel memory. Follow the steps below to program channels into the TV's channel memory.

Auto Tuning

Your TV can automatically detect all active channels in your area and store them in its memory. After the channels are programmed automatically, you can manually add or erase individual channels in the channel memory.

Note:

- You must configure the ANT/CABLE input source before programming channels.
- If the ANT/CABLE input is configured for **Cable**, the automatic channel programming process erases channels that were previously programmed into the TV's memory.
- If the ANT/CABLE input is configured for **Antenna**, the automatic channel programming process adds newly found channels to the existing set of programmed channels (and does NOT erase channels that were previously programmed into the TV's memory). To remove an Antenna source channel from the memory, you must set it to Skip (SKIP) "Setting channel skip" on page 36).
- To tune the TV to a channel not programmed in the channel memory, you must use the number buttons on the remote control.
- Programming channels when the ANT/CABLE input is configured for **Cable** will take substantially longer than when the antenna input is configured for **Antenna**. This is normal; however, once channel programming is finished, you should not have to repeat the programming process again unless your Cable TV service lineup changes significantly.

- 1 Configure the **ANT/CABLE** input, if you have not already done so (SEE left-hand column).
- 2 From the **SETUP** menu, highlight **Auto Tuning** and press (OK).
- 3 A screen will appear warning that previous programs and settings will be deleted.
- 4 Press (OK) to start Auto Tuning. The TV will automatically cycle through all the channels, and store all active channels in the channel memory. When Auto Tuning is finished, press (CH) or (CH) to view the programmed channels.

Manual Tuning

After automatically programming channels into the channel memory, you can manually enter channels if the physical channel is known.

- 1 From the **SETUP** menu, highlight **Manual Tuning** and press (OK).
- 2 Use the Channel Numbers on the remote control to enter the channel number (up to three-digit number) and press (OK).
- 3 Press (OK) to start Manual Tuning.

If channels are found, they will be listed at the bottom of the screen. Analog channels will be noted by an "ATV" symbol and digital channels by a "DTV" symbol.

Setting AV Input mode

This setting determines the configuration of the shared AV input on the side of your TV. You can set this input for either **ColorStream HD** or **Video**.

- 1 From the **PREFERENCES** menu, highlight **AV Connection** and press **OK**.
- 2 Press **▲** or **▼** to select **AV Input**.
- 3 Press **◀** or **▶** to select your desired setting and press **EXIT**.

Note: If you select the wrong setting, picture will have no color or be fuzzy.

Setting channel skip

To prevent certain channels from being viewed, channel positions can be skipped.

- 1 From the **SETUP** menu, highlight **TV Settings** and press **OK**.
- 2 Press **▲** or **▼** to select **Channel Options** and press **OK**. The list of channels will appear.

Channel Options			
Ch.	Type	<input type="checkbox"/>	<input type="checkbox"/>
5-1	DTV	<input checked="" type="checkbox"/>	<input type="checkbox"/>
6	ATV	<input type="checkbox"/>	<input type="checkbox"/>
6-1	DTV	<input type="checkbox"/>	<input type="checkbox"/>
8	ATV	<input type="checkbox"/>	<input type="checkbox"/>
9	ATV	<input type="checkbox"/>	<input type="checkbox"/>
10	ATV	<input type="checkbox"/>	<input type="checkbox"/>
11	ATV	<input type="checkbox"/>	<input type="checkbox"/>
12	ATV	<input type="checkbox"/>	<input type="checkbox"/>

- 3 Press **▲** or **▼** to select a channel position to be skipped and press **OK**. A check will appear in the box. To remove the check, press **OK** again.

Note: Skipped channels cannot be selected with **CH** or **CH**; however, they can still be accessed with the Channel Number buttons.

Setting video input skip

You can set certain video inputs to be skipped over when selecting inputs in the Input selection window.

To turn on the skip:

- 1 From the **PREFERENCES** menu, highlight **AV Connection** and press **OK**.
- 2 Press **▲** or **▼** to highlight **Input Labeling**, and press **OK**.
- 3 Press **▲** or **▼** to highlight the item you want to be skipped, and then press the **RED** button to turn on **Skip**.

To turn off the skip:

- 1 From the **PREFERENCES** menu, highlight **AV Connection** and press **OK**.
- 2 Press **▲** or **▼** to highlight **Input Labeling**, and press **OK**.
- 3 Press **▲** or **▼** to highlight the skipped item, and then press the **RED** button to turn off the skip.

Labeling video input sources

These input labels are shown in the input selector, and in the Channel Browser and banner displays. You can label video inputs according to the devices you have connected to the TV.

- 1 From the **PREFERENCES** menu, highlight **AV Connection** and press **OK**.
- 2 Press **▲** or **▼** to highlight **Input Labeling**, and press **OK**.
- 3 Press **▲** or **▼** to highlight the item you want to label, and then press **◀** or **▶** to select --, **Amplifier**, **Cable**, **DVD**, **Game**, **PC**, **Recorder**, **Satellite** or **VCR**, or press the **GREEN** button to select **User Input**.

Note: When **User Input** is selected by pressing the **GREEN** button, the **Software Keyboard** window will appear. Input the desired characters (10 characters or less) by using the **Software Keyboard** (page 69) or using the number buttons for a number input. To save your settings, press the **BLUE** button.

- 4 Repeat step 3 for other video inputs.

Note: Skipped channels cannot be selected with **CH** or **CH**; however, they can still be accessed with the Channel Number buttons.

Setting the time zone

The Time Zone setup will allow you to specify the correct time zone for your region. This feature will allow the TV status information to show the correct time zone information for your viewing area.

- 1** From the **SETUP** menu, highlight **TV Settings** and press **OK**.
- 2** Press **▲** or **▼** to select **Local Time Setting** and press **OK**.
- 3** Highlight **Time Zone** and press **◀** or **▶** to set your desired time zone.
- 4** If you want to activate the daylight saving time, highlight **Daylight Saving Time**.
- 5** Press **◀** or **▶** to select **On** and press **EXIT**.

Selecting the location

You can select Home or Store for the TV location. For normal home use, select Home.

- 1** From the **SETUP** menu, highlight **Location**.
- 2** Press **◀** or **▶** to select **Home** and press **EXIT**.

Chapter 6: Basic features

Tuning channels

Setting the Channel Tuning Mode

This feature allows you to choose how tuning will be handled for analog and digital channels when the TV is in Antenna mode.

Note: To use this feature, **ANT/CABLE In** must be set to **Antenna** (see page 35).

The channel tuning mode has three options.

Mode	Description
Standard	Both analog and digital channels can be tuned normally
Auto (default)	Digital channels will have priority when manually entering a channel number using the Channel Numbers (0-9) on the remote control, analog channels can still be tuned by / if available
Digital	Only digital channels can be tuned

To set the Channel Tuning Mode:

- 1 From the **SETUP** menu, highlight **TV Settings** and press .
- 2 Press or to highlight **Channel Tuning Mode**.
- 3 Press or to select your desired mode and then press .

Note: The Channel Options window as well as the Channel Browser ANT/CABLE List will be updated automatically when you change the mode. Also, the History List will be cleared, but the Favorites List will be saved.

Tuning to the next programmed channel

To tune to the next programmed channel:

Press or on the remote control or TV control panel.

Note: This feature will not work unless you program channels into the TV's channel memory (see page 35).

Tuning to a specific channel (programmed or unprogrammed)

Tuning analog channels:

Press the Channel Number (0-9) on the remote control. For example, to select channel 125, press 1, 2, 5, then .

Tuning digital channels:

Enter the major Channel Number (0-9) on the remote control, followed by the dash () button and then the sub-channel number. For example, to select digital channel 125-1, press 1, 2, 5, -, 1, then .

Tuning channels using the Channel Browser™

The Channel Browser™ provides an easy navigation interface for all your channels and inputs. This feature allows you to:

- Navigate the contents of all of your inputs.
- Keep a list of your favorite channels.
- Keep a history of the last 32 channels or inputs viewed.
- Quickly surf and tune your recently viewed channels/inputs from the Channel Browser™ History List.
- Surf via Browse mode (to immediately tune channels as you highlight them in the Channel Browser™) or Select mode (to surf over channels in the Channel Browser™ before you select one to tune).
- Quickly change inputs from the Inputs List.
- Quickly select REGZA-LINK® devices from the REGZA-LINK List.

To set up the Channel Browser™:

- 1 From the **PREFERENCES** menu, highlight **Channel Browser Setup** and press **OK**.
- 2 Press **▼** or **▲** to highlight **Navigation**, and then press **◀** or **▶** to select either **Select Mode** or **Browser Mode**.
- 3 Press **▼** or **▲** to highlight **History List**, and then press **◀** or **▶** to select the setting you prefer: **On** or **Off**.

Note: History List will be cleared every time the TV is powered off.

- 4 Press **▼** or **▲** to highlight **ANT/CABLE List**, and then press **◀** or **▶** to select **On** or **Off**.
- 5 Press **▼** or **▲** to highlight **Inputs List**, and then press **◀** or **▶** to select **On** or **Off**.
- 6 Press **▼** or **▲** to highlight **Favorites List**, and then press **◀** or **▶** to select **On** or **Off**.
- 7 Press **▼** or **▲** to highlight **REGZA-LINK List**, and then press **◀** or **▶** to select **On** or **Off**.

*Note: REGZA-LINK List will be automatically grayed out and set to off when **Enable REGZA-LINK** is set to **Off** (Page 48).*

- 8 To return to factory defaults, highlight **Reset** and press **OK**.

To open the Channel Browser™:

- Press **BACK** **◀** or **NEXT** **▶**.
- Press **BACK** **◀** or **NEXT** **▶** to surf backward or forward through the tuned 32 channels in the History list, the channels in the ANT/CABLE channel list, the inputs in the Inputs list, the REGZA-LINK® devices in the REGZA-LINK list, or the favorite channels/inputs in the Favorites list.
- From the **APPLICATIONS** menu, highlight **Channel Browser** and press **OK**.

Elements of the Channel Browser™

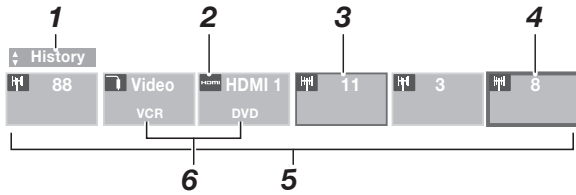

- 1 Current list (**History**, **ANT/CABLE**, **Inputs**, **Favorites**, or **REGZA-LINK**)
- 2 Input type
- 3 Channel or input currently being viewed
- 4 Channel or input that is currently highlighted in the browser
- 5 Channels stored in the History List
- 6 Input labels

To toggle among the available lists:

After opening the Channel Browser™, press ▲ or ▼ to toggle among **History**, **ANT/CABLE**, **Inputs**, **Favorites**, and **REGZA-LINK**.

Note:

- The Channel Browser™ opens in **History List** by default. Once another list has been selected, the Channel Browser™ will open in the last selected list.
- If all lists are turned off, pressing **BACK** ◀, **NEXT** ▶, or **FAV** will not display the Channel Browser™. If **Favorites List** is turned off, pressing **FAV** will not display the Favorites Browser.
- Pressing **FAV** will bring up the Channel Browser™ Favorites list regardless of the last selected list in the Channel Browser™.

To tune to a channel or input in Browse mode:

- 1 In **Browse** mode, when you stop on an item in the Channel Browser™, it will be highlighted and the TV will automatically tune to the channel or input.
- 2 Press **EXT** to close the Channel Browser™.

To tune to a channel or input in Select mode:

- 1 In **Select** mode, when you stop on an item in the Channel Browser™, it will be highlighted but you must press **OK** to tune the TV to the highlighted item.
- 2 Press **OK** to tune the TV to the highlighted item.
- 3 Press **EXT** to close the Channel Browser™.

Favorites Browser

The Favorites Browser allows you to quickly set up a favorite channels/inputs list that is integrated into the Channel Browser™.

To add a favorite channel/input:

- 1 Tune to the channel or input.
- 2 Press and hold **FAV** for 3 seconds.

Note: Additions are added to the beginning of the Favorites list on the left side of the Channel Browser™.

To delete a favorite channel/input:

- 1 Press **FAV** to open the Favorites List.
- 2 Highlight the channel or input to delete with **BACK** ◀ or **NEXT** ▶.
- 3 Press and hold **100** for 3 seconds. The channel/input will be removed from the Favorites list.

Adding and clearing channels and inputs in the History List

Adding channels and inputs to the History List:

As a channel or input is tuned, the Channel Browser™ adds it to the History List and displays it on the “right side” of the Channel Browser™. Previously tuned channels/inputs are “shifted” to the left, eventually moving off the left side. Press **BACK** ◀ to surf backward through the previously tuned channels/inputs. Any channel or input that is tuned repeatedly will not be repeated in the History List but instead will be moved to the end of the list on the right side of the Channel Browser™.

The Channel Browser™ will store the following channels:

- All channels that are tuned using the numeric buttons on the remote control.
- All channels that are tuned for at least 5 seconds using **CH** or **CH**.

Note: Whenever an item is selected that cannot be tuned (for various reasons), the TV will automatically tune to the previously viewed channel or input.

Clearing channels from the History List:

- Reconfiguring the **ANT/CABLE** input will clear the History List.
- Once 32 channels or inputs are stored in the History List, the oldest item will be removed from the list when a new channel or input is tuned.
- Turning off the TV will clear the History List.

Switching between two channels using Channel Return

The Channel Return feature allows you to switch between two channels without entering an actual channel number each time. This feature also works for external inputs.

- 1 Select the first channel you want to view.
- 2 Select a second channel using the Channel Number buttons (and the dash (100) button if needed).
- 3 Press CH RTN on the remote control. The previous channel will display. Each time you press CH RTN , the TV will switch back and forth between the last two channels that were tuned.

Switching between two channels using SurfLock™

The SurfLock™ feature temporarily “memorizes” one channel to the CH RTN button, so you can return to that channel quickly from any other channel with CH RTN . This feature also works for external inputs.

To memorize a channel to the CH RTN button:

- 1 Tune the channel you want to program into the CH RTN button.
- 2 Press and hold CH RTN for about 2 seconds until the message “Memorized” appears. The channel has been programmed to the CH RTN button.
- 3 You can then change channels repeatedly, and when you press CH RTN , the memorized channel will be tuned.

The TV will return to the memorized channel one time only. Once you press CH RTN and then change channels again, the memory will be cleared and the button will function as Channel Return.

Selecting the video input to view

To select the video input to view:

- 1 Press INPUT on the remote control or TV control panel.
- 2 And then either:
 - Press 0–6; or
 - Repeatedly press \blacktriangle or \blacktriangledown , then press OK to change the input; or
 - Repeatedly press INPUT to change the input.

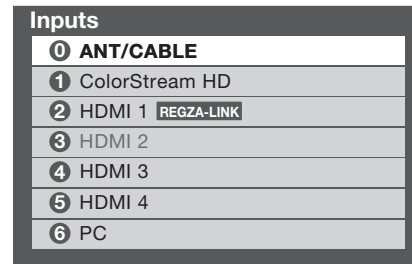

Note:

- You can label the video input sources according to the specific devices you have connected to the TV (see “Labeling video input sources” on page 36).
- Sources can also be skipped (see “Setting video input skip” on page 36).
- Inputs that are set to skip will be grayed out and will be skipped over when selecting inputs by repeatedly pressing INPUT or \blacktriangle or \blacktriangledown . They are only available by using direct number entry.
- If one or more REGZA-LINK® devices are connected to an HDMI input, the REGZA-LINK® icon will appear in the input selector. In this case, the label (see page 36) will not appear in the input selector.

To select a REGZA-LINK® device:

- 1 Press \blacktriangle or \blacktriangledown to highlight an appropriate HDMI input.
- 2 Press \blacktriangleright to display the list of REGZA-LINK® devices for that input.
- 3 If there are multiple REGZA-LINK® devices on the input, use \blacktriangle or \blacktriangledown to highlight a particular device.
- 4 Press OK to select the device and change inputs.

Using the closed caption mode

To turn on the closed caption mode:

- 1 From the **SETUP** menu, highlight **TV Settings** and press **OK**.
- 2 Press **▼** or **▲** to select **Closed Captions Settings** and press **OK**.
- 3 Press **▼** or **▲** to select **Closed Captions** and press **◀** or **▶** to select **On**.

Note: If **Closed Captions** is set to **Off**, **Analog CC Mode** and **Digital CC Settings** will be grayed out.

Analog CC Mode

The closed caption mode has two options:

Mode	Description
Captions	An on-screen display of the dialogue, narration, and sound effects of TV programs and videos that are closed captioned (usually marked "CC" in program guides).
Text	An on-screen display of information not related to the current program, such as weather or stock data (when provided by individual stations).

To view captions or text:

From the **Closed Captions Settings** menu, highlight **Analog CC Mode**.

• To view captions:

Press **◀** or **▶** to highlight **CC1**, **CC2**, **CC3**, or **CC4**.



Note: If the program or video you selected is not closed captioned, no captions will display on-screen.

• To view text:

Press **◀** or **▶** to highlight **T1**, **T2**, **T3**, or **T4**.

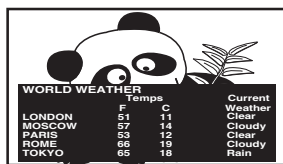

Note: If text is not available in your area, a black rectangle may appear on screen. In this case, set the **Closed Captions Settings** to **Off**.

Note: A closed caption signal may not display in the following situations:

- When a videotape has been dubbed.

- When the signal reception is weak.
- When the signal reception is non-standard.

Digital CC Settings

You can customize the closed caption display characteristics.

Note:

- This settings is available for digital channels only.
- You cannot set the **Caption Text** and **Background** as the same color.

Mode	Description
Caption Size	Auto, Small, Standard, Large
Caption Text Type	Auto, Default, Mono w. Serif, Prop. w. Serif, Mono w/o Serif, Prop. w/o Serif, Casual, Cursive, Small Capitals
Caption Text Edge	Auto, None, Raised, Depressed, Uniform, Left Drop Shadow, Right Drop shadow
Caption Text Color	Auto, Black, White, Red, Green, Blue, Yellow, Magenta, Cyan
Text Foreground Opacity	Auto, Transparent, Translucent, Flashing, Solid
Background Color	Auto, Black, White, Red, Green, Blue, Yellow, Magenta, Cyan
Text Background Opacity	Auto, Transparent, Translucent, Flashing, Solid
Caption Text Edge Color	Auto, Black, White, Red, Green, Blue, Yellow, Magenta, Cyan

To customize the closed captions:

- 1 From the **Closed Captions Settings** menu, highlight **Digital CC Settings** and press **OK**.
- 2 Press **▲** or **▼** to highlight the characteristic you want to change, and then press **◀** or **▶** to select the format for that characteristic.

Using the Closed Caption button

If you press **CC** when an analog channel is tuned or from an external AV input (only available for 480i):

- The CC bar will appear and will display CC1-4 and T1-4 as the options.

If you press **CC** when a digital channel is tuned:

- The CC bar will appear and will display the available caption options (available languages) for that channel or service.

Setting the PIN code

A PIN code is necessary for some menus.

Note: *Parental Control and Locks* menu is grayed out if no PIN has been set.

Registering a new PIN code

- 1 From the **PREFERENCES** menu, highlight **PIN Setting** and press **OK**. A new screen will display.
- 2 Press the number buttons to enter a four-digit number. Re-enter the PIN code to confirm it.

Note: PIN code cannot be set to "0000".

Changing or deleting your PIN code

- 1 From the **PREFERENCES** menu, highlight **PIN Setting** and press **OK**. The PIN code screen will display.
- 2 Press the number buttons to enter your four-digit PIN code.
 - Change PIN
Highlight **Change PIN** and press **OK**.
 - Delete PIN
Highlight **Delete PIN** and press **OK**.
If you delete the PIN code, the settings of **Parental Control and Locks** are reset.

Note: PIN code cannot be set to "0000".

If you cannot remember your PIN code

While the PIN code screen is displayed, press **INFO** four times within five seconds. The PIN code will be cleared and you can enter a new PIN code.

Using lock menu

Blocking TV programs and movies by rating (V-Chip)

Some TV programs and movies include signals that classify the content of the program (violence, sex, dialogue, language). The V-Chip feature in this TV detects the signals and blocks the programs according to the ratings you select.

Note: Rating blocking is a function of the V-Chip feature in this TV, which supports the U.S. V-Chip system only.

To block and unblock TV programs and movies:

- 1 From the **PREFERENCES** menu, highlight **Parental Control and Locks** and press **OK**.
- 2 Enter your four-digit PIN code.
- 3 Press **▲** or **▼** to highlight **Enable Rating Blocking**.
- 4 Press **◀** or **▶** to select **On**.
- 5 Press **▼** to highlight **Edit Rating Limits** and press **OK**.
The **Edit Rating Limits** screen appears.
- 6 Press **▲**, **▼**, **◀** or **▶** and then press **OK** to select the level of blocking you prefer. A box with an "X" is a rating that will be blocked. As you highlight a rating, a definition for the rating appears at the bottom of the screen.

Note: This feature will be grayed out if PIN code is not set.

Downloading an additional rating system for blocking TV programs and movies

An additional rating system may be available for use in selectively blocking programs.

Note: The currently tuned station must be receiving a digital signal before an additional rating system can be downloaded.

To download the additional rating system (if available):

- 1 From the **PREFERENCES** menu, highlight **Parental Control and Locks** and press **OK**.
- 2 Enter your four-digit PIN code. Parental Control and Locks window is displayed.
- 3 Press **▲** or **▼** to highlight **Enable Rating Blocking**.
- 4 Press **◀** or **▶** to select **On**.
- 5 Press **▼** to highlight **Edit Rating Limits** and press **OK**. The **Edit Rating Limits** screen appears.
- 6 Highlight **Alt RS** and press **OK**. The **Edit Alternate Ratings** screen will appear.

Note:

 - The **Alt RS** button will only be available if an additional rating system is currently available.
 - It may take several minutes for the TV to download the additional rating system.
 - The information displayed in the **Alternate Ratings** screen will depend on the configuration of the additional rating system available at the time of download.
- 7 Press **▲**, **▼**, **◀** or **▶** and then press **OK** to select the level of blocking you prefer. A box with an "X" is a rating that will be blocked.

Note:

- The additional rating system can only be downloaded one time. You will not be able to download any updates to the rating system should such updates become available.
- The additional rating system is not designed, transmitted, or controlled by the TV or Toshiba, nor is the availability of an additional rating system determined or controlled by Toshiba. Similarly, the rating of programs in an additional rating system is not determined, transmitted, or controlled by the TV or Toshiba.
- The additional rating system is an evolving technology; therefore, availability, content, and format may vary.

Independent rating system for broadcasters	
Ratings	Description and Content themes
TV-MA	Mature Audience Only (This program is specifically designed to be viewed by adults and therefore may be unsuitable for children under 17.) L) Crude or indecent language S) Explicit sexual activity V) Graphic violence
TV-14	Parents Strongly Cautioned (This program contains some material that many parents would find unsuitable for children under 14 years of age.) D) Intensely suggestive dialogue L) Strong, coarse language S) Intense sexual situations V) Intense violence
TV-PG	Parental Guidance Suggested (This program contains material parents may find unsuitable for younger children.) D) Some suggestive dialogue L) Infrequent coarse language S) Some sexual situations V) Moderate violence
TV-G	General Audience (Most parents would find this program suitable for all ages.)
TV-Y7, TV-Y7FV	Directed to Older Children (This program is designed for children age 7 and above. Note: Programs in which fantasy violence may be more intense or more combative than other programs in this category are designated TV-Y7FV.)
TV-Y	All Children (This program is designed to be appropriate for all children.)

Independent rating system for movies	
Ratings	Description and Content themes
X	X-rated (For adults only)
NC-17	Not intended for anyone 17 and under
R	Restricted (Under 17 requires accompanying parent or adult)
PG-13	Parents Strongly Cautioned (Some material may be inappropriate for children under 13)
PG	Parental Guidance Suggested (Some material may not be suitable for children)
G	General Audience (Appropriate for all ages)

Note:

- If you place an “X” in the box next to “**Rated “None”**”, programs rated “**None**” or “**Not Rated**” will be blocked; however, programs that do not provide any rating information will not be blocked.
- To display the rating of the program you are watching, press **INFO** on the remote control. If it is rated “None,” the word “**NONE**” appears in the **INFO** screen (as shown below right). If rating information is not provided, no rating will appear in the **INFO** screen.



Unlocking programs

If you try to tune the TV to a program that exceeds the rating limits you set, the TV will enter program lock mode and a warning message will appear on-screen. Follow the instructions to temporarily unlock the program.

Locking channels

With the Lock feature, you can lock specific channels. The locked channels can only be accessed by entering the PIN (see “Setting the PIN code” on page 43).

- 1 From the **SETUP** menu, highlight **TV Settings** and press **OK**.
- 2 Press **▲** or **▼** to select **Channel Options** and press **OK**. The list of channels will appear.

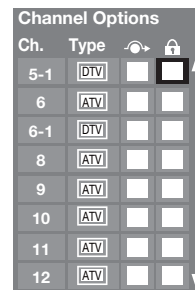

- 3 Press **▶** and then **▲** or **▼** to select a channel in the lock column, then press **OK**.
- 4 PIN code entry will be required to set a locked channel.

Note: If the PIN code has not been set yet, a warning message will appear.
- 5 A check will appear in the box. To remove the check, press **OK** again.

Input lock feature

You can use the Input Lock feature to lock the video inputs and channels 3 and 4. You will not be able to view the input sources or channels until you unlock the inputs.

- 1 From the **PREFERENCES** menu, highlight **Parental Control and Locks** and press **OK**.
- 2 Enter your four-digit PIN code.
- 3 Press **▲** or **▼** to highlight **Input Lock**.
- 4 Press **◀** or **▶** to select **Video**, **Video+** or **Off** and press **EXIT**.

Mode	Description
Video	Locks Video, ColorStream HD, HDMI 1, HDMI 2, HDMI 3, HDMI 4, and PC.
Video+	Locks Video, ColorStream HD, HDMI 1, HDMI 2, HDMI 3, HDMI 4, PC and channels 3 and 4. <ul style="list-style-type: none"> • Select Video+ if you play video tapes via the ANT/CABLE input.
Off	Unlocks all video inputs and channels 3 and 4.

Network Lock

You can use the Network Lock feature to prevent the Web browser from launching. When this feature is set to **On**, PIN input will be necessary to use Widgets, VUDU or YouTube.

- 1 From the **PREFERENCES** menu, highlight **Parental Control and Locks** and press **OK**.
- 2 Enter your four-digit PIN code.
- 3 Press **▲** or **▼** to highlight **Network Lock** and press **◀** or **▶** to select **On**, and then press **EXIT**.

To unlock the Network:
Select **Off** in step 3 above.

GameTimer®

You can use the GameTimer® to set a time limit for playing a video game (30–120 minutes). When the GameTimer expires, the TV enters Input Lock mode and locks out the input source for the video game device.

- 1 From the **PREFERENCES** menu, highlight **Parental Control and Locks** and press **OK**.
- 2 Enter your four-digit PIN code.
- 3 Press **▲** or **▼** to select **GameTimer**, and then press **◀** or **▶** to select **30**, **60**, **90**, or **120** minutes.

To cancel the GameTimer®:
Select **Off** in step 3 above.

To deactivate the Input Lock once the GameTimer® has activated it:
Set the **Input Lock** to **Off** (ⓘ “Input lock feature” on page 45.)

Note:

- A message will appear when 10 minutes, 3 minutes, and 1 minute remain on the GameTimer®.
- If the TV loses power with time remaining on the GameTimer®, when power is restored the TV will enter Input Lock mode (as if the GameTimer had been activated), and you will have to deactivate the Input Lock (ⓘ page 45).

Panel lock

You can lock the control panel to prevent your settings from being changed accidentally (by children, for example). When **Panel Lock** is **On**, none of the controls on the TV control panel will operate except **POWER**.

- 1 From the **PREFERENCES** menu, highlight **Parental Control and Locks** and press **OK**.
- 2 Enter your four-digit PIN code.
- 3 Press **▲** or **▼** to select **Panel Lock**, and then press **◀** or **▶** to select **On**.

Note: When **Panel Lock** is set to **On**, “Not Available” window will be displayed when the buttons on the TV control panel are pressed. If the **POWER** button is pressed, the TV will switch off and can only be brought out of standby by using the remote control.

To unlock the control panel:
Select **Off** in step 3 above.

Using REGZA-LINK®











This feature uses CEC technology and allows you to control Toshiba REGZA-LINK® compatible devices with the TV remote control via HDMI connection. When **Enable REGZA-LINK** in the **REGZA-LINK Setup** menu is set to **On**, the following REGZA-LINK® functions will be enabled.

REGZA-LINK® playback device control

With your TV's remote control, you can control the connected REGZA-LINK playback device you are watching.





Available remote control key functions:

Before using the following key functions, first set the MODE SELECT switch on the remote control to **TV**.

Button	Description
	Begins playback.
	Stops playback.
	Pauses the picture during play or record mode.
	Skips forward.
	Skips backward.
	Fast-forwards.
	Rewinds/reverses.
	Navigates contents menu, etc.
	Enters contents menu, etc.
	Returns to the previous menu.
	Closes the menu.
RED, GREEN, YELLOW, BLUE	Controls various operations

Note: These functions depend on the connected devices.

REGZA-LINK® Player Control menu functions:



- 1 Press  to open the Quick menu.
- 2 Highlight **REGZA-LINK Player Control** and press .
- 3 Press  or  to select the item you want to control and press .

Item	Description
Power	Turns the selected device on and off.
Root Menu	Accesses the top menu of the selected device.
Contents Menu	Accesses the contents list when you press  . At this time, the REGZA-LINK Player Control menu will disappear.
Setup Menu	Accesses the setup menu of a DVD player.
Top Menu	Accesses the top menu of a DVD during playback.
DVD Menu	Accesses the menu of a DVD during playback.

Note:

- These functions depend on the connected devices.
- The REGZA-LINK Player Control item will be grayed out in the following conditions:
 - A non-HDMI input is currently selected.
 - The **Enable REGZA-LINK** item is set to **Off**.
 - The connected REGZA-LINK device is not a playback or recording device.

REGZA-LINK® input source selection

If a REGZA-LINK® device with HDMI switching capability (e.g. Amplifier) is connected to the HDMI input, you can select another REGZA-LINK® device that is connected to the master HDMI device using  on the remote control or the TV control panel ( page 41).

Amplifier VOLUME and MUTE controls

With your TV's remote control, you can adjust or mute the sound volume of your amplifier. First, set the MODE SELECT switch to **TV**.

- adjust the volume level.
- turns off the sound.

To use this function:

- 1 From the **PREFERENCES** menu, highlight **REGZA-LINK Setup** and press .
- 2 Press or to highlight **Speaker Preference**.
- 3 Press or to select **Amplifier**.

Note: Confirm that a connected REGZA-LINK® device (such as DVD player, etc.) is selected for the Amplifier input source.

Note:

- You can also use this function when the amplifier is connected to the TV's **DIGITAL AUDIO OUT** terminal (not HDMI connection). In this case, select a digital audio input mode on the amplifier.
- These functions depend on the device connected.

Other REGZA-LINK® functions

When **Enable REGZA-LINK** and each item in the **REGZA-LINK Setup** menu are set to **On**, the following functions will be enabled.

Item	Description
TV Auto Power	If a REGZA-LINK® device is turned on, the TV turns on automatically.
Auto Standby	If the TV is turned off, the TV will send a message to turn off all of the REGZA-LINK devices connected to the TV.
Amplifier Control	If Amplifier Control is set to On , you can adjust the sound volume or turn off the sound using the remote control.
Speaker Preference	From this item, you can set your audio output preference to the TV speakers or the amplifier. When this item is set to Amplifier , the remote control can be used to adjust or mute the volume of the audio. This item will be grayed out and set to TV Speakers automatically unless a REGZA-LINK® compatible audio receiver is connected.

Note: When you turn on the amplifier, change its input source, or adjust the sound volume, the sound will be output from the amplifier's speakers even if **TV Speakers** has been selected. Turn the TV off and on again to output the sound from the TV speakers.

To set the REGZA-LINK® Setup:

- 1 From the **PREFERENCES** menu, highlight **REGZA-LINK Setup** and press .
- 2 Press or to highlight **Enable REGZA-LINK**.
- 3 Press or to select **On**.
Note: If you set **Enable REGZA-LINK** to **Off**, the other items under REGZA-LINK Setup will be grayed out.
- 4 Press or to highlight the **REGZA-LINK** setup item you want to use, and press or to select **On** or the desired mode.
 - TV Auto Power: On/Off
 - Auto Standby: On/Off
 - Amplifier Control: On/Off
 - Speaker Preference: TV Speakers/Amplifier

REGZA-LINK® PC Link

This feature automatically sets suitable widescreen formats and picture preferences when the TV is connected to a REGZA-LINK® PC.

Note: This feature depends on the type of equipment connected.

Using the HDMI® settings feature

This menu consists of the following items (new HDMI capabilities) and will be grayed out on non-HDMI inputs.

Some HDMI legacy sources may not work properly with your HDMI TV, please try setting the following options (Content Type and INSTAPORT™) to **Off**. Adjusting these settings should allow your HDMI legacy source to operate properly with your TV.

Mode (default setting)	Description
Enable Content Type: On	This feature adjusts the picture quality automatically by the content of “Contents type” included in the HDMI input. Note: When Picture Mode is set to AutoView , this feature is available.
INSTAPORT™: On	This feature reduces the lag time when switching HDMI sources.
RGB Range: Auto	This feature adjusts RGB full range signal automatically. When Limited is selected, RGB output signal is output in the range from 16 to 235. When Full is selected, RGB output signal is output in the range from 0 to 255.

The HDMI settings (Content Type and RGB Range) need proper HDMI source devices. If your HDMI source device does not support these features, the TV may not work properly when these features are enabled.

Note: If your HDMI connection is capable of 1080p and/or your TV is capable of refresh rates greater than 60 Hz, you will need a High Speed HDMI® cable. Conventional HDMI/DVI cables may not work properly with this mode.

- 1 Select the appropriate HDMI input mode (HDMI 1, HDMI 2, HDMI 3, or HDMI 4).
- 2 From the **PREFERENCES** menu, highlight **AV Connection** and press **(OK)**.
- 3 Press **▲** or **▼** to select **HDMI Settings**.
- 4 Press **▲** or **▼** to highlight the item you want to set.
- 5 Press **◀** or **▶** to select your desired setting.

Setting the HDMI® audio mode

To set the HDMI audio mode:

- 1 From the **PREFERENCES** menu, highlight **AV Connection** and press **(OK)**.
- 2 Press **▲** or **▼** to select **HDMI 2 Audio**.
- 3 Press **◀** or **▶** to select **Auto**, **Digital** or **Analog**, and press **(EXIT)**.

Mode	Description
Auto	When viewing the HDMI 2 input, if digital audio from the HDMI input is available, it will be output. If not, the TV will automatically detect and output analog audio from the PC/HDMI 2 Audio input.
Digital	When viewing the HDMI 2 input, digital audio from the HDMI input will be output.
Analog	When viewing the HDMI 2 input, analog audio from the PC/HDMI 2 Audio input will be output.

Note: If PC/HDMI 2 Audio is set to **PC**, this feature will be grayed out.

Viewing the HDMI® signal information

- 1 From the **PREFERENCES** menu, highlight **HDMI Information Display**.
- 2 Press **◀** or **▶** to select **On**, and then press **(INFO)**. Normal banner and signal information banner will appear.

Note:

- Signal information banner will appear when this feature is set to **On** and you watch HDMI input.
- If you press **(INFO)** when this feature is set to **Off**, only normal banner will appear.
- When Content type is No Data, this is not displayed.

Using the PC settings feature

You can view an image from a PC on the TV screen. When a PC is connected to the TV's PC IN terminal, you can use the PC Settings feature to make adjustments to the image.

If the edges of the picture are cut off, readjust the **Horizontal Position** and **Vertical Position**. If the picture is affected by interference, readjust the **Clock Phase** and **Sampling Clock**.

- 1 Select PC input mode (see "Selecting the video input to view" on page 41).
- 2 From the **PREFERENCES** menu, highlight **Display Settings** and press **OK**.
- 3 Press **▲** or **▼** to select **PC Settings** and press **OK**.
Note: If a PC is not connected or there is no PC input signal, this menu will be grayed out.
- 4 Press **▲** or **▼** to highlight the item you want to adjust.
- 5 Press **◀** or **▶** to make any appropriate adjustments.
Note: The screen is disrupted momentarily when adjusting the PC settings. This is not a sign of malfunction.

Mode	Description
Horizontal Position	Moves the picture left/right. The adjustment range is within ± 10 from center.*
Vertical Position	Moves the picture up/down. The adjustment range is within ± 10 from center.*
Clock Phase	Helps to reduce noise and sharpen the picture. The adjustment range is within ± 32 from center.
Sampling Clock	Helps to reduce noise and minimize periodic vertical stripes on the screen. The adjustment range is within ± 5 from center.

* The default settings and /or adjustment ranges vary depending on the input signal format.

Setting the PC Audio

This function allows you to output sound from your PC when connecting using the PC/HDMI 2 Audio IN terminal and an analog RGB cable.

- 1 From the **PREFERENCES** menu, highlight **AV Connection** and press **OK**.
- 2 Press **▲** or **▼** to select **PC/HDMI 2 Audio**.
- 3 Press **◀** or **▶** to select **PC**.

Note: Setting PC/HDMI 2 to PC will force HDMI 2 Audio to Digital mode.

Setting the On Timer

You can set the on timer to automatically turn on the TV to a preset channel or input at a preset time.

To activate the On Timer:

- 1 From the **APPLICATIONS** menu, highlight **On Timer** and press **OK**.
- 2 Press **▲** or **▼** to select **Enable On Timer**, and then press **◀** or **▶** to select **On**.

Note: If the *Enable On Timer* is set to **Off**, other menus under *On Timer* cannot be changed.

To set the On Timer:

- 1 From the **APPLICATIONS** menu, highlight **On Timer** and press **OK**.
- 2 Press **▲** or **▼** to highlight the item you want to change, and then press **◀**, **▶** or the number buttons to make your desired adjustment.
- 3 Highlight **Done**, and then press **OK**.

Item	Description
Input	To select video input source (ANT/CABLE, Video, ColorStream HD, HDMI 1, HDMI 2, HDMI 3, HDMI 4, or PC).
Channel	To select the channel when the TV turns on.
Volume	To set the volume when the TV turns on.
Time until Power On	To set the time when the TV turns on from now with ◀ or ▶ or the number buttons. <ul style="list-style-type: none"> • The setting at time is a unit of ten minutes. (minimum: 00:10, maximum: 12:00)

Note:

- When the **On Timer** is set to **On**, the *On Timer LED* is turned on (☞ “LED indications” on page 85).
- If you do not operate the TV for 1 hour after it is powered on by the *On Timer* feature, the TV will automatically turn itself off.

To cancel the On Timer:

- 1 From the **APPLICATIONS** menu, highlight **On Timer** and press **OK**.
- 2 Press **▲** or **▼** to select **Enable On Timer**.
- 3 Press **◀** or **▶** to select **Off**.

Setting the Sleep Timer

You can set the sleep timer to turn off the TV after a set length of time (maximum of 12 hours).

To set the sleep timer using the remote control:

Press **SLEEP** to set the length of time until the TV turns off. Repeatedly press **SLEEP** to increase the time in 10-minute increments, or press **▲** or **▼** to increase or decrease the time in 10-minute increments, to a maximum of 12 hours.

To set the sleep timer using the on-screen menus:

- 1 From the **APPLICATIONS** menu, highlight **Sleep Timer**.
- 2 Press the number buttons to enter the length of time or press **◀**, **▶** or the number buttons to increase or decrease in 10-minute increments (maximum of 12 hours).

Note: When a power failure occurs, the sleep timer setting may be cleared.

To display the remaining sleep time:

Press **SLEEP**.

To cancel the sleep timer:

Press **SLEEP** repeatedly or press **▲** or **▼** until it is set to 0 minutes.

Automatic Power Down

The TV will automatically turn itself off (standby) after 4 hours, if you do not operate the TV either from the remote control or the TV control panel.

- 1 From the **PREFERENCES** menu, highlight **Energy Saving Settings** and press **OK**.
- 2 Press **▲** or **▼** to select **Automatic Power Down**.
- 3 Press **◀** or **▶** to select **On** or **Off**, and press **EXIT**.

Note:

- This feature is set to **On** when Location is set to **Home**.
- 1 minute before switching to standby, a warning message will appear.
- When the following features are set, the feature that is set for the nearest time will function.
 - Automatic Power Down
 - Sleep Timer
 - Photo Frame/Auto Power Off
 - Auto shutdown after 1 hour of inactivity (after power-on by On Timer)
 - No signal auto power off (after 15 minute of no signal)

No Signal Power Down

The TV will automatically turn itself off after 15 minutes when no signal is detected.

You can change the setting to Off for the following purposes:

- low signal strength of analog channel (no signal detection)
- Only Audio L/R is connected to external input to listen to music through the TV speakers.

- 1 From the **PREFERENCES** menu, highlight **Energy Saving Settings** and press **OK**.
- 2 Press **▲** or **▼** to select **No Signal Power Down**, and press **OK**.
- 3 Press **▲** or **▼** to highlight the item you want to change, and press **◀** or **▶** to select **On** or **Off**.

Note:

- Default setting is all **On**.
- A warning message will appear 1 minute before turning off.

Power-On Mode

You can select either **Power-Saving** or **Fast** mode.

- **Power-Saving** mode keeps power consumption in standby mode to below 1W. As a result, it takes a bit longer for the TV to turn on.
- **Fast** mode increases power consumption in standby mode. As a result, the TV will turn on more quickly.

- 1 From the **PREFERENCES** menu, highlight **Energy Saving Settings** and press **OK**.
- 2 Press **▲** or **▼** to select **Power-On Mode**.
- 3 Press **◀** or **▶** to select either **Power-Saving** or **Fast**, and then press **EXIT**.
Select **Power-Saving** for optimal energy efficiency.

Blue Screen

When Blue Screen is set to On, the screen will turn blue and the sound will be muted on analog channels and external input modes when no signal is received.

- 1 From the **PREFERENCES** menu, highlight **Blue Screen**.
- 2 Press **◀** or **▶** to select **On**, and press **EXIT**.

TOSHIBA Illumination

You can set the illumination mode of the TOSHIBA logo located on the front panel to On or Off.

- 1 From the **PREFERENCES** menu, highlight **TOSHIBA Illumination**.
- 2 Press **◀** or **▶** to select either **On** or **Off**, and then press **EXIT**.

Displaying TV status information

To display TV status information:

Press **INFO**.

The following information will display (if applicable):

- Current input (**ANT/CABLE, Video**, etc.)
- If ANT/CABLE is the current input, either “CABLE” (for cable TV) or “ANT” (for over-the-air broadcasts).
- Channel number (if in **ANT/CABLE** mode)
- Input label (if set)
- Digital signal strength indicator (bar graph in lower right corner of box; for ATSC signal only)
- Stereo, Mono or SAP audio status (when HDMI input mode, Dolby Digital or PCM)
- Video resolution
- Aspect ratio of incoming video signal (4:3 or 16:9)
- V-Chip rating status
- GameTimer (if set)

To close the screen:

Press **INFO** again.

The following additional information (only available for **ANT/CABLE** input) will display for off air digital channels (if applicable):

- Title
- Duration
- Detailed description

To display next program information for digital channels, press **INFO** again. Pressing **INFO** a third time will remove the entire banner.

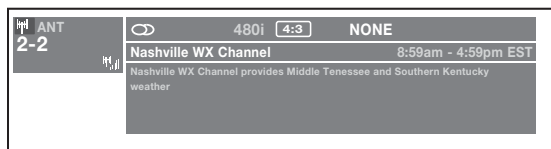

Note: The location of the banner can be moved to the top or bottom of the screen by pressing **▲** or **▼** while the **INFO** display is on-screen. The last position will be stored to memory.

Viewing support information

- 1 From the **SETUP** menu, highlight **System Information**.
- 2 Press **OK** to display support information containing Web/Customer service numbers for US, Canada and Mexico.

Reset Factory Defaults

You can reset all settings and channels to their factory default values.

- 1 From the **SETUP** menu, highlight **Reset TV** and press **OK**.
- 2 Enter your PIN code (if PIN code has been set).
- 3 Press **◀** or **▶** to select **Yes** and press **OK**. The TV will turn off automatically.

To cancel the reset:

Press **◀** or **▶** to select **No** and press **OK**.

Understanding the auto power off feature

The TV will automatically turn itself off after approximately 15 minutes if it is tuned to a vacant channel or a station that completes its broadcast for the day.

Note:

- If you want to set this feature to off, see “No Signal Power Down” on page 52.
- If it is possible that you will be away from the TV for an extended period of time, you should unplug the power cord.

Understanding the last mode memory feature

If the power is cut off while you are viewing the TV, the Last Mode Memory feature automatically turns on the TV when the power is resupplied.

Chapter 7: Picture and sound controls

Selecting the picture size

You can view many program formats in a variety of picture sizes—**Native**, **4:3**, **Full**, **TheaterWide 1**, **TheaterWide 2**, **TheaterWide 3**, **Normal** and **Dot by Dot**.

Note: The “picture size” illustrations are examples only. The format of the image (in any of the picture sizes) will vary depending on the format of the signal you are currently watching. Select the picture size that displays the current program the way that looks best to you.

You can save separate picture size preferences for each input on your TV.

To select the picture size:

- 1 Press **PIC SIZE**.
- 2 While the **Picture Size** screen is open, you can do one of the following to select the desired picture size:
 - Repeatedly press **PIC SIZE**.
 - Press the corresponding number button.
 - Press **▲** or **▼** and **OK**.

Note: Some of the picture sizes may not be available depending on the signal format being received.

Using these functions to change the picture size (i.e., changing the height/ width ratio) for any purpose other than your private viewing may be prohibited under the Copyright Laws of the United States and other countries, and may subject you to civil and criminal liability.

Note: If you select one of the TheaterWide® picture sizes, the top and bottom edges of the picture (including subtitles or captions) may be hidden. To view the hidden edges, either adjust the **Picture Position** (👁️ “Scrolling the picture” on page 56) or try viewing the program in **4:3** or **Full**.

Picture Size

Native
(for 480i (HDMI), 480p (HDMI), 720p, 1080i, and 1080p signal programs)

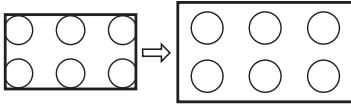

- If receiving a 1080i, 1080p, 720p, 480i (HDMI), or 480p (HDMI) signal program, Native mode scales the video to display the entire picture within the borders of the screen (i.e. no overscanning).
- This is especially useful for external HD sources such as DVHS movies, Video Games or PC graphics.
- None of the picture is hidden.

Note:

- This mode is supported only for HDMI (1080i, 1080p, 720p, 480i, and 480p), ColorStream® (1080i and 720p), and ANT/CABLE (digital) inputs (1080i, 1080p, and 720p).
- Depending on the input signal, the border of the picture may be hidden, displayed in black, or noisy.

4:3

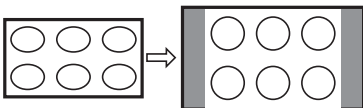
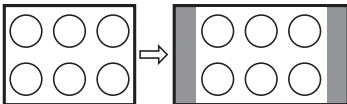

Some program formats will display with sidebars and/or bars at the top and bottom.

Full
(for 16:9 [480i, 480p] source programs only)

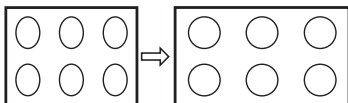

If receiving a squeezed 4:3 format program, the picture is stretched wider to fill the width of the screen but not stretched taller.

(for 1080i, 1080p, and 720p program sources)

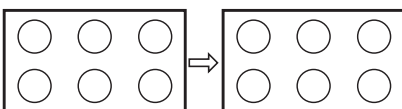

The edges surrounding the picture may be hidden.

Picture Size

TheaterWide 1
(for 4:3 format programs)

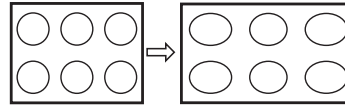

The center of the picture remains close to its original proportion, but the left and right edges are stretched wider to fill the screen.

TheaterWide 2
(for letter box programs)

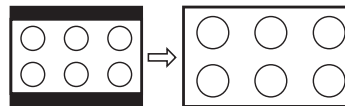

The top and bottom edges of the picture may be hidden*.

TheaterWide 3
(for letter box programs with subtitles)

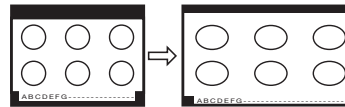

The top and bottom edges are hidden*.

Normal
(for VGA, SVGA, XGA, WXGA, and SXGA sources and Photo files)

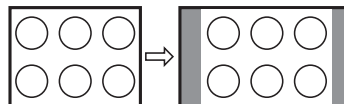

“Normal” is a non-stretched display. Some input signal formats will display with sidebars and/or bars at the top and bottom.

Dot by Dot
(for VGA, SVGA, XGA, WXGA, and SXGA sources and Photo files)

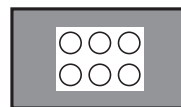

“Dot by Dot” is a non-scaling display. Depending on the input signal format, the picture is displayed with sidebars and/or bars at the top and bottom. (Example: VGA input source)

* To view the hidden areas (such as subtitles or captions), see “Scrolling the picture” (page 56).

Scrolling the picture

If the edges of the picture are cut off, you can adjust the image position.

Note: You can adjust the picture position when the picture size is set to **TheaterWide 2** or **TheaterWide 3**.

- 1 From the **PREFERENCES** menu, highlight **Display Settings** and press **OK**.
- 2 Press **▲** or **▼** to select **Picture Position** and press **OK**.
- 3 Press **▲** or **▼** to select **Vertical Position**.
- 4 Press **◀** or **▶** to make the appropriate adjustments. The adjustment range is from **-5** to **+10**.

Using the Auto Aspect feature

When this feature is set to **On**, the TV will automatically select the picture size when one of the following input sources is received:

- A 480i, 480p, 720p, 1080i digital signal from the **ANT/CABLE** input
- A 480i signal from the **ColorStream HD** or **Video** input
- A 480i, 480p, 720p, 1080i, 1080p, or VGA (60/72/75 Hz) signal from the **HDMI 1/2/3/4** input

Note: The auto aspect ratio feature is not applicable to the **PC** input.

- 1 From the **PREFERENCES** menu, highlight **Display Settings** and press **OK**.
- 2 Press **▲** or **▼** to select **Auto Aspect**.
- 3 Press **◀** or **▶** to select **On**, and then press **EXIT**.

Using the 4:3 Stretch

When 4:3 Stretch is activated, the size switching system converts 4:3 programs to full screen picture.

Note: This feature is available when **Auto Aspect** is set to **On**.

- 1 From the **PREFERENCES** menu, highlight **Display Settings** and press **OK**.
- 2 Press **▲** or **▼** to select **4:3 Stretch**.
- 3 Press **◀** or **▶** to select **On**, and then press **EXIT**.

Using the FREEZE feature

- 1 When viewing the TV, press **FREEZE** to make the picture a still picture.
- 2 To return to moving picture, press **FREEZE** again.

Note: If the TV is left in **FREEZE** mode for more than 15 minutes, the TV will return to moving picture automatically.

Using the **FREEZE** function for any purpose other than your private viewing may be prohibited under the Copyright Laws of the United States and other countries, and may subject you to civil and criminal liability.

Adjusting the picture

Selecting the picture mode

You can select your desired picture settings from the following modes, as described below.

Mode	Description
AutoView™	Automatically adjusts picture settings based on ambient light conditions and input signal content.
Sports	Bright and dynamic picture.
Standard	Standard picture settings.
Movie	Lower contrast for darkened room.
Game	Designed for playing a video game requiring split-second timing between the on-screen display and input from the controller.
PC	Designed for viewing of PC tables and documents.

Note:

- **PC** mode is available for HDMI and PC inputs only (not displayed for other input sources).
- **Game** mode cannot be turned on when the **ANT/CABLE** input is selected.

- 1 From the **PICTURE** menu, highlight **Picture Mode**.
- 2 Press ◀ or ▶ to select your preferred picture mode and press **EXIT**.

Note: The picture mode you select affects the current input only. You can select a different picture mode for each input.

Adjusting the picture quality

The picture quality you adjusted under a certain picture mode is saved to the picture mode of same name.

Selection	Pressing ◀	Pressing ▶
Backlight*	darker	lighter
Contrast	lower	higher
Brightness	darker	lighter
Color	paler	deeper
Tint	reddish	greenish
Sharpness	softer	sharper

* Backlight adjusts the brightness of the entire screen. When in video mode and no signal is input, this will automatically be set to 0. (Settings are stored in memory.)

Note: Some menus cannot be adjusted in any of the following case.

- **AutoView** is selected.
- **TheaterLock** is set to **On**.

To adjust the picture quality:

- 1 From the **PICTURE** menu, highlight the setting you would like to adjust (**Backlight, Contrast, Brightness, Color, Tint, or Sharpness**).
- 2 Press ◀ or ▶ to adjust the setting, and then press **EXIT**.

Note: The picture setting that you adjusted affects the current input only. You can adjust the picture quality separately for each input.

To revert to the factory defaults:

- 1 Select the picture mode you want to reset.
- 2 From the **PICTURE** menu, highlight **Reset** and press **OK**.
- 3 A confirmation message will appear. Press ◀ or ▶ to select **Yes**, and then press **OK**.

Using the advanced picture settings features

Note: Some of the Advanced Picture Settings features will not be available for adjustment when the Picture Mode is set to **AutoView**.

Resolution+™

The Resolution+™ feature allows you to adjust the levels for your desired picture settings and achieve a sharper picture.

To set Resolution+:

- 1 From the **PICTURE** menu, highlight **Advanced Picture Settings** and press **OK**.
- 2 Press **▲** or **▼** to highlight **Resolution+**, and press **OK**.
- 3 Press **◀** or **▶** to select **On**.
- 4 Press **▲** or **▼** to highlight **Level**, and then press **◀** or **▶** to select either **1**, **2**, **3**, **4**, or **5** and press **OK**.

Note:

- When the Picture Mode is set to **AutoView**, the level range is from -2 to +2.
- If the Picture Mode is set to **Game** or **PC**, Resolution+ will be grayed out.
- This feature may not work properly depending on the content.
- Noise may appear on the image depending on the device connected to the TV (e.g. a device with a specific enhancer function).

DynaLight™

The DynaLight™ feature automatically strengthens the black coloring of dark areas in the video according to the level of darkness.

- 1 From the **PICTURE** menu, highlight **Advanced Picture Settings** and press **OK**.
- 2 Press **▲** or **▼** to select **DynaLight**.
- 3 Press **◀** or **▶** to select **On** or **Off** and press **EXIT**.

Dynamic Contrast

Dynamic Contrast detects changes in picture quality that affect the appearance of your contrast settings and then automatically adjusts the video.

- 1 From the **PICTURE** menu, highlight **Advanced Picture Settings** and press **OK**.
- 2 Press **▲** or **▼** to select **Dynamic Contrast**.
- 3 Press **◀** or **▶** to adjust the level, and then press **OK**. The adjustment range is from **0** to **10**.

Note: When the Picture Mode is set to **AutoView**, the level range is from -5 to +5.

Static Gamma

The static gamma feature allows you to adjust the levels of black in the picture.

To adjust the static gamma settings:

- 1 From the **PICTURE** menu, highlight **Advanced Picture Settings** and press **OK**.
- 2 Press **▲** or **▼** to select **Static Gamma**.
- 3 Press **◀** or **▶** to adjust the level and press **OK**. The adjustment range is within ± 15 from center.
 - If the setting is moved in the minus direction, the detail of black colors will be decreased.
 - If the setting is moved in the plus direction, the detail of black colors will be increased.

Film Stabilization

This feature helps to eliminate video shaking.

- 1 From the **PICTURE** menu, highlight **Advanced Picture Settings** and press **OK**.
- 2 Press **▲** or **▼** to select **Film Stabilization**.
- 3 Press **◀** or **▶** to select **Smooth**, **Standard** or **Off** and press **EXIT**.

Note:

- If the Picture Mode is set to **Game** or **PC**, this feature will be set to **Off** automatically and grayed out.
- If the Picture Mode is set to **AutoView**, select **Auto**, **Smooth**, **Standard** or **Off**.

Expert Mode

This feature individually enables/disables the Red, Green, and Blue components of the picture to allow for more accurate adjustment of each color.

- 1 From the **PICTURE** menu, highlight **Advanced Picture Settings** and press **OK**.
- 2 Press **▲** or **▼** to select **Expert Mode**, and then press **OK**.
- 3 Press **▲** or **▼** to select either **Red**, **Green** or **Blue**.
- 4 Press **◀** or **▶** to select **On**.
- 5 Press **▼** to select **Color** or **Tint**, press **◀** or **▶** to adjust, and then press **EXIT**.

Note:

- When the Picture Mode is set to **AutoView**, this feature will be grayed out.
- When the Expert Mode menu is exited, the **On/Off** modes of **Red**, **Green** and **Blue** are no longer valid.
- It is not possible to turn off all three colors at the same time.

ClearFrame™ feature

The ClearFrame 120 Hz anti-blur technology doubles the frame rate from 60 frames per second to 120 frames per second, virtually eliminating motion blur without adding flicker or reducing image brightness.

- 1 From the **PICTURE** menu, highlight **Advanced Picture Settings** and press **OK**.
- 2 Press **▲** or **▼** to select **ClearFrame**.
- 3 Press **◀** or **▶** to select **On**, and then press **EXIT**.

Note: If the Picture Mode is set to **Game**, this feature will be grayed out.

MPEG NR

The MPEG noise reduction feature allows you to reduce visible interference caused by MPEG compression.

- 1 From the **PICTURE** menu, highlight **Advanced Picture Settings** and press **OK**.
- 2 Press **▲** or **▼** to select **Noise Reduction** and press **OK**.
- 3 Press **▲** or **▼** to highlight **MPEG NR**.
- 4 Press **◀** or **▶** to select either **Low**, **Middle**, **High** or **Off** and press **OK**.

Note: If the Picture Mode is set to **Game** or **PC**, this feature will be grayed out.

DNR

DNR enables you to “soften” the screen representation of a weak signal to reduce the noise effect.

- 1 From the **PICTURE** menu, highlight **Advanced Picture Settings** and press **OK**.
- 2 Press **▲** or **▼** to select **Noise Reduction** and press **OK**.
- 3 Press **▲** or **▼** to select **DNR**.
- 4 Press **◀** or **▶** to select **Low**, **Middle**, **High**, **Auto** or **Off** and press **OK**.

Note:

- If the Picture Mode is set to **Game** or **PC**, this feature will be grayed out.
- The differences may not always be noticeable (for the best result use lower settings as picture quality can be lost if the setting is too high).

Auto Brightness Sensor

When the Auto Brightness Sensor feature is set to **On**, the TV will automatically optimize the backlighting levels to suit ambient light conditions.

- 1 From the **PICTURE** menu, highlight **Advanced Picture Settings** and press **OK**.
- 2 Press **▲** or **▼** to select **Auto Brightness Sensor Settings** and press **OK**.
- 3 Press **▲** or **▼** to highlight **Auto Brightness Sensor**.
- 4 Press **◀** or **▶** to select **On** or **Off** and press **OK**.

Note: When the Picture Mode is set to **AutoView**, this feature will be automatically set to **On** and grayed out.

Backlight Adjustment Pro

This feature adjusts the backlight so that it can change to match the ambient light conditions.

- 1 From the **PICTURE** menu, highlight **Advanced Picture Settings** and press **OK**.
- 2 Press **▲** or **▼** to select **Auto Brightness Sensor Settings** and press **OK**.
- 3 Press **▲** or **▼** to highlight **Backlight Adjustment Pro** and press **OK**. The Backlight Control Level window will appear.
- 4 Press **OK** to display the adjustment window. Press **◀** or **▶** to select the point and press **▲** or **▼** to adjust the level. The adjustment range is from 0 to 100.

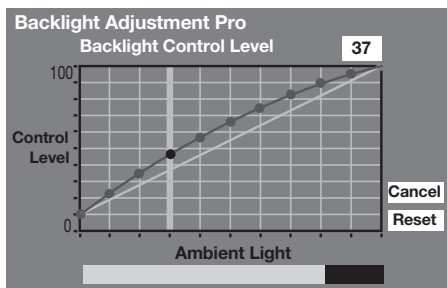

- 5 Press **OK** to fix the adjustment. To cancel the adjustment when selecting a point, select **Cancel** on the screen. To revert the adjustments of all points to the factory defaults, select **Reset** on the screen and press **OK**.

Note: If the **Auto Brightness Sensor** is set to **Off**, this feature will be grayed out.

ColorMaster™

The ColorMaster™ feature allows you to adjust standard colors.

- 1 From the **PICTURE** menu, highlight **Advanced Picture Settings** and press **OK**.
- 2 Press **▲** or **▼** to select **ColorMaster**, press **◀** or **▶** to select **On**, and then press **EXIT**.

Base Color Adjustment

When ColorMaster™ is set to **On**, the list of base colors will be displayed. You can select a base color to adjust.

- 1 From the **PICTURE** menu, highlight **Advanced Picture Settings** and press **OK**.
- 2 Press **▲** or **▼** to select **Base Color Adjustment** and press **OK**. The **Base Color Adjustment** window will appear.
- 3 Press **▲** or **▼** to highlight the color you want to adjust, and then press **▶**.
- 4 Press **◀** or **▶** to select either **Hue**, **Saturation**, or **Brightness**.
- 5 Press **▲** or **▼** to adjust the setting.
- 6 Repeat steps 3 through 5 to adjust any other color. To revert the adjustments to the factory defaults, select **Reset** on the screen and press **OK**.

Color temperature

To adjust the color temperature:

- 1 From the **PICTURE** menu, highlight **Advanced Picture Settings** and press **OK**.
- 2 Press **▲** or **▼** to select **Color Temperature** and press **OK**.
- 3 Press **▲** or **▼** to highlight **Color Temperature**.
- 4 Press **◀** or **▶** to adjust the level. The adjustment range is 0 (warm) to 10 (cool). Then, press **EXIT**.

Note: When the Picture Mode is set to **AutoView**, the adjustment range is -5 to +5.

To adjust RGB Offset and RGB Gain:

- 1 From the **PICTURE** menu, highlight **Advanced Picture Settings** and press **OK**.
- 2 Press **▲** or **▼** to select **Color Temperature** and press **OK**.
- 3 Press **▲** or **▼** to highlight the menu you want to adjust, and then press **◀** or **▶** to adjust the setting.

Note: When Picture Mode is set to **AutoView**, only the **Color Temperature** setting will be available.

To revert the adjustments to the factory defaults:
Select **Reset** in step 1 above and press **OK**.

Viewing the Control Visualization window

This feature displays a histogram and control curve illustrating the brightness of the TV.

- 1 From the **PICTURE** menu, highlight **Control Visualization** and press **OK**. The histogram window will appear.

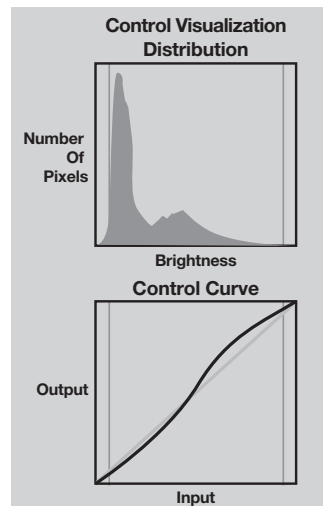

- 2 Press **RETURN** to close the window and go back to menu. If no key is pressed within 10 minutes, it closes automatically.

Using the TheaterLock™ feature

The TheaterLock™ feature allows you to “lock” items in the **PICTURE** menu that affect the picture display. These items will be grayed out and unavailable when the **TheaterLock** is set to **On**.

- 1 From the **PICTURE** menu, highlight **TheaterLock**.
- 2 Press **◀** or **▶** to select **On**, and then press **EXIT**.

Adjusting the audio

Muting the sound

Press **MUTE** to partially reduce (1/2 Mute) or turn off (Mute) the sound. Each time you press **MUTE**, the mute mode will change in the following order:



If the closed caption mode is set to **Off** when you select “Mute” mode, the closed caption feature is automatically activated if the TV program is Closed Captioned. To mute the audio without automatically activating the closed caption feature, use **VOL** to set the volume to 0.

Note: If you modify items in the **SOUND** menu while Mute is active, the Mute will automatically be cancelled.

Selecting stereo/SAP broadcasts

The multi-channel TV sound (MTS) feature allows you to output high-fidelity stereo sound. MTS also can transmit a second audio program (SAP) containing a second language, music, or other audio information (when provided by individual stations).

When the TV receives a stereo or SAP broadcast, the word “STEREO” or “SAP” appears on-screen when **INFO** is pressed. The MTS feature is only available for analog signals on the **ANT/CABLE** input.

To listen a stereo sound:

- 1 From the **SOUND** menu, highlight **MTS**.
- 2 Press **◀** or **▶** to select **Stereo** and press **EXIT**.

Note:

- You can typically leave the TV in **Stereo** mode because it will automatically output the type of sound being broadcast (stereo or monaural).
- If the stereo sound is noisy, select **Mono** to reduce the noise.

To listen to a second audio program on an analog station (if available):

Select **SAP** in step 2 above.

Note:

- A Second Audio Program (SAP) can be heard only on those TV stations that offer it. For example, a station might broadcast another language as a second audio program. If you have SAP on, you will see the current program on the screen but hear the other language instead of the program’s normal audio.
- If you have SAP on and the station you are watching is not broadcasting a second audio program, the station’s normal audio will be output. However, occasionally there

is no sound at all in **SAP** mode. If this happens, set the MTS feature to **Stereo** mode.

Using the MTS button

If you press **MTS** when an analog channel is tuned:

- The Analog Audio bar will appear and will display Stereo, SAP, Mono as the options.

If you press **MTS** when a digital channel is tuned:

- The Digital Audio bar will appear and will offer different audio choices for the digital channel.

If you press **MTS** when an external input is selected:

- No Audio bar is displayed.

Adjusting the audio balance

You can adjust the audio balance.

- 1 From the **SOUND** menu, highlight **Balance**.
- 2 Press **◀** or **▶** to adjust the level of the desired item, and then press **EXIT**.
 - **◀** increases the balance in the left channel (depending on the item selected).
 - **▶** increases the balance in the right channel (depending on the item selected).

Selecting the optical audio output format

You can use this feature to select the optical audio output format when you connect a Dolby Digital decoder or other digital audio system to the **DIGITAL AUDIO OUT** terminal on the TV.

- 1 Tune to a digital source on the **ANT/CABLE** input.
- 2 From the **PREFERENCES** menu, highlight **AV Connection** and press **OK**.
- 3 Press **▲** or **▼** to select **Digital Audio Output**.
- 4 Press **◀** or **▶** to select **Auto** or **PCM**, and then press **EXIT**.

Auto: This mode outputs Dolby Digital or PCM to the digital audio output socket according to what is being broadcasted.

PCM: This mode outputs PCM format to the digital audio output socket.

Using the Dolby® Digital Dynamic Range Control feature

This dynamic range control feature causes Dolby Digital and Dolby Digital Plus dynamic range to be further compressed, allowing you to switch from digital to analog broadcasts at the same dynamic range.

- 1 From the **SOUND** menu, highlight **Dynamic Range Control**.
- 2 Press ◀ or ▶ to select **On**.

Note:

- This feature is available when the Dolby Digital or the Dolby Digital Plus is input to TV in the following situations:
 - When tuned to a digital RF channel or HDMI input.
 - When DLNA Certified products or VUDU is used.
- This feature is not available when **Dolby Volume** is set to **Low** or **High**.
- This feature will also affect the **Digital Audio Output** when the optical audio output format is set to **PCM**.

Using Dolby® Volume

This feature provides a consistent sound volume regardless of programs, channels or input sources.

- 1 From the **SOUND** menu, highlight **Dolby Volume**.
- 2 Press ◀ or ▶ to select **Low**, **High** or **Off**.

Note:

- If **Dynamic Range Control** is set to **On**, this feature will be grayed out.
- This feature does not affect the audio signal output from the **DIGITAL AUDIO OUT**.

Using the advanced sound settings features

Using the surround sound feature

Bass, Treble, Surround, Voice Enhancement, and Dynamic Bass Boost help to create a thrilling surround sound experience with deep, rich bass from stereo sound sources. Your TV's audio will sound fuller, richer, and wider.

Note: Surround features are only available for **Stereo** mode (📺 "Selecting stereo/SAP broadcasts" on page 62).

- 1 From the **SOUND** menu, highlight **Advanced Sound Settings** and press (OK).
- 2 Press ▼ or ▲ to highlight the feature you want to adjust, and then press ◀ or ▶ to adjust the item.

Mode	Description
Bass, Treble	Pressing ◀ makes the bass or treble weaker. Pressing ▶ makes the bass or treble stronger.
Surround	Select the desired mode (Spatial , Cinema , or Off). Spatial: reproduces an expansive and deep sound Cinema: delivers realistic sound similar to what you would experience in a movie theater.
Voice Enhancement	Turn the vocal emphasis effect On or Off .
Dynamic Bass Boost	Select the desired bass expansion level (Off , Low , or High).

Chapter 8: Advanced features

Using your home network

- This TV is a DLNA CERTIFIED™ Player and Renderer. This TV can play digital content stored on a DLNA CERTIFIED™ product with server function. If you want to use this TV as a DLNA CERTIFIED™ Player or Renderer, you will have to configure the network settings on your TV (🔗 page 21).
- If you want to use your home network with an Internet connection, you will have to configure the network settings on your TV (🔗 page 22). Change the network settings if necessary (🔗 “Setting up the Network” on page 65).

If you use Internet services, see the following note before using it.

Note:

- Internet services are available only in the United States. (Except YouTube)
- Use of internet services requires a working broadband internet connection (1 to 2 Mbps for SD video, 2.25 to 4.5 Mbps for HD video and 4.5 to 9 Mbps for HDX video).
- VUDU and other internet-based services are not provided by TOSHIBA, may change or be discontinued at any time and may be subject to restrictions imposed by your internet service provider. The quality, functionality, or availability of such services may be affected by the capacity of your Internet connection. Use of VUDU video-on-demand and other internet services may require the creation of a separate account through a computer with internet access.
- Not all VUDU services may be available on or be compatible with this product.
- VUDU video-on-demand and other internet services may require payment of one-time and/or recurring charges.
- You are solely responsible for any charges incurred as a result of using internet-based content, including, without limitation, communications charges for the provision of internet or network services and any charges incurred for third-party internet content services, such as video on demand or subscription services. All third-party services are provided in accordance with whatever terms and conditions are established between such third-party providers and you.
- TOSHIBA MAKES NO REPRESENTATIONS OR WARRANTIES ABOUT THE CONTENT, AVAILABILITY OR FUNCTIONALITY OF THE VUDU SERVICE OR OTHER INTERNET DELIVERED THIRD-PARTY SERVICES AND DOES NOT WARRANT THAT ANY OF THEM WILL BE UNINTERRUPTED, ERROR FREE OR SATISFACTORY. ANY IMPLIED WARRANTY, INCLUDING BUT NOT LIMITED TO ANY IMPLIED WARRANTY OF MERCHANTABILITY OR FITNESS FOR A PARTICULAR PURPOSE OF ANY THIRD PARTY CONTENT OR SERVICE, IS EXPRESSLY EXCLUDED AND DISCLAIMED. UNDER NO CIRCUMSTANCES

WILL TOSHIBA BE LIABLE IN CONTRACT, TORT OR UNDER ANY OTHER THEORY FOR ANY DAMAGES ARISING OUT OF OR IN CONNECTION WITH YOUR USE OF ANY CONTENT OR SERVICE PROVIDED BY ANY THIRD PARTY, EVEN IF ADVISED OF THE POSSIBILITY OF SUCH DAMAGES.

When you enjoy Internet services by wireless:

Wireless Interoperability:

- The Dual Band WLAN Adapter that is included is designed to be interoperable with any wireless LAN product that is based on Direct Sequence Spread Spectrum (DSSS) /Orthogonal Frequency Division Multiplexing (OFDM) radio technology, and is compliant to:
 - The IEEE 802.11a/b/g and IEEE 802.11n Standard, as defined and approved by the Institute of Electrical and Electronics Engineers and; may not be fully compatible with, or support some features (e.g., security) of certain Wi-Fi equipment.
 - The Wireless Fidelity (Wi-Fi®) certification as defined by the Wi-Fi Alliance®. The “Wi-Fi CERTIFIED™” logo is a certification mark of the Wi-Fi Alliance®.
- The included Dual Band WLAN Adapter is intended for use with 40UX600U, 46UX600U and 55UX600U only and should not be used with other devices. Use with other devices may result in damage to the wireless USB dongle and/or the other device. Such use will void any warranty that may otherwise apply and Toshiba will have no liability for any damage that may result from such use.

Wireless LAN and your Health:

Wireless LAN products, like other radio devices, emit radio frequency electromagnetic energy. The level of energy emitted by Wireless LAN devices however is far much less than the electromagnetic energy emitted by wireless devices like for example mobile phones.

Because Wireless LAN products operate within the guidelines found in radio frequency safety standards and recommendations, TOSHIBA believes Wireless LAN is safe for use by consumers. These standards and recommendations reflect the consensus of the scientific community and result from deliberations of panels and committees of scientists who continually review and interpret the extensive research literature.

In some situations or environments, the use of Wireless LAN may be restricted by the proprietor of the building or responsible representatives of the organization. Such restriction may apply in environment where the risk of interference to other devices or services is perceived or identified as harmful.

If you are uncertain of the policy that applies on the use of wireless devices in a specific organization or environment, you are encouraged to ask for authorization to use the Wireless LAN device prior to turning on the equipment.

Using under wireless LAN environment:

Note:

- It is recommended to use IEEE 802.11a or IEEE 802.11n on 5 GHz for audio and SD video streaming.
- It is recommended to use IEEE 802.11n on 5 GHz for HD video streaming.
- It is recommended that the encoding rate of content of Video streaming is 20 Mps or less.
- It is not recommended to use 2.4 GHz for audio and video streaming.
- Content playback may be interrupted by surrounding various interference.

Setting up the Network

You can select the Network Type.

- 1 From the **PREFERENCES** menu, highlight **Network Setup** and press **OK**.
- 2 Press **▲** or **▼** to highlight **Network Type**, and then press **◀** or **▶** to select **Wired** or **Wireless**.
Note: If the Dual Band WLAN Adapter is not connected, **Wireless** cannot be selected.
- 3 If you select **Wired**, see “Advanced Network Setup” on page 67.
If you select **Wireless**, see the next column.

Wireless Setup

Note:

- This feature is grayed out when the Dual Band WLAN Adapter is not connected or Network Type is set to Wired.
- Continued connection of AP (Access Point) is not guaranteed. The connection may be disconnected while watching TV.
- Do not remove the Dual Band WLAN Adapter while changing the settings of the wireless connection or communicating.

There are 3 methods for wireless setup:

• Easy Setup (WPS)

If AP corresponds to WPS, this can be used.

- WPS (Wi-Fi Protected Setup™) is standard designed to execute connection of wireless LAN equipment and setup of security easily. WPS will automatically configure all wireless settings.

• Assisted Setup (setup by using AP's notification information)

Network Name, Authentication, and Encryption are decided based on information from AP. You manually set Security Key.

• Manual Setup (to input all settings)

Easy Setup using PBC (Push Button Configuration)

- 1 From the **PREFERENCES** menu, highlight **Network Setup** and press **OK**.
- 2 Press **▲** or **▼** to highlight **Wireless Setup**, and press **OK**.
- 3 Press **▲** or **▼** to highlight **Easy Setup**, and press **OK**.
- 4 Press **◀** or **▶** to select **PBC**.
- 5 Press **▼** to highlight **Start Scan**, and press **OK**.
- 6 Following the on-screen instruction, push the appropriate button on your AP.
- 7 When a window reporting that the setup succeeded appears, press **OK**.

To cancel searching for the AP:

Press **RETURN** while searching for the AP. A message will appear. Then press **◀** or **▶** to select **Yes** and press **OK**.

Easy Setup using PIN (Personal Identification Number)

- 1 From the **PREFERENCES** menu, highlight **Network Setup** and press **OK**.
- 2 Press **▲** or **▼** to highlight **Wireless Setup**, and press **OK**.
- 3 Press **▲** or **▼** to highlight **Easy Setup**, and press **OK**.
- 4 Press **◀** or **▶** to select **PIN**.
- 5 Press **▼** to highlight **Start Scan**, and press **OK**.
- 6 Press **▲** or **▼** to select the desired AP and press **OK**.
Note: Check the MAC address on label of the AP or the manual of it and select an AP.
- 7 When the PIN code window appears, enter the displayed PIN into your AP, and then press **OK** to start the PIN Setup. When a message displays to report that the setup was successful, press **OK**.

To cancel searching for the AP:

Press **RETURN** while searching for the AP. A message will appear. Then press **◀** or **▶** to select **Yes** and press **OK**.

Assisted Setup

- 1 From the **PREFERENCES** menu, highlight **Network Setup** and press **OK**.
- 2 Press **▲** or **▼** to highlight **Wireless Setup**, and press **OK**.
- 3 Press **▲** or **▼** to highlight **Assisted Setup**, and press **OK**.
- 4 Press **▲** or **▼** to select the desired AP and press **OK**.
Note: Check the MAC address on label of the AP or the manual of it and select an AP.
- 5 Highlight **Security Key** and press **OK**. The Software Keyboard window will appear.
- 6 Input the Security Key by using the Software Keyboard (page 69). To save your setting, press the **BLUE** button.
Note:
 - The Security Key must adhere to these conditions:
 - TKIP/AES: 8-63 ASCII or 64 Hex characters
 - WEP: 5 or 13 ASCII or 10 or 26 Hex characters
 - Key ID of WEP encryption to set is only one.
- 7 Highlight **Done**, and then press **OK**.
*Note: If **Network Name** is not displayed, see step 4 and 5 in **Manual Setup** (the next column) to set **Network Name** before pressing **Done**.*

Note: Settings are not saved if **RETURN** is pressed before **Done** is selected.

Manual Setup

- 1 From the **PREFERENCES** menu, highlight **Network Setup** and press **OK**.
- 2 Press **▲** or **▼** to highlight **Wireless Setup**, and press **OK**.
- 3 Press **▲** or **▼** to highlight **Manual Setup**, and press **OK**.
- 4 Press **▲** or **▼** to highlight **Network Name**, and press **OK**. The Software Keyboard window will appear.
- 5 Input the Network Name by using the Software Keyboard (page 69). To save your setting, press the **BLUE** button.
- 6 Press **▲** or **▼** to highlight **Authentication**, and then press **◀** or **▶** to select **Open System, Shared Key, WPA-PSK** or **WPA2-PSK**.
- 7 Press **▲** or **▼** to highlight **Encryption**, and then press **◀** or **▶** to select **None, WEP, TKIP** or **AES**.

Note:

- Certain encryption types are only compatible with specific authentication types.
 - When Authentication is Open System, only WEP or None is compatible.
 - When Authentication is Shared Key, only WEP is compatible.
 - When Authentication is WPA-PSK or WPA2-PSK, only TKIP or AES is compatible.
- When incompatible Authentication/Encryption pairings are attempted, a warning message will be displayed, and no connection attempt will be made until the incompatibility is resolved.
- Key ID of WEP encryption to set is only one.

- 8 Press **▲** or **▼** to highlight **Security Key**, and press **OK**. The Software Keyboard window will appear.
- 9 Input the Security Key by using the Software Keyboard (page 69). To save your setting, press the **BLUE** button.
Note: This item is grayed out when **Encryption** is **None**.
- 10 Highlight **Done**, and then press **OK**.
Note: When **Encryption** is **None**, a message will appear. Press **◀** or **▶** to select **Yes** and press **OK**.

Note: Settings are not saved if **RETURN** is pressed before **Done** is selected.

Wireless Information

The settings configured in **Wireless Setup** can be confirmed.

- 1 Press **OK** to open the Quick menu.
- 2 Press **▲** or **▼** to select **Wireless Information** and press **OK**.
- 3 When the AP connection succeeds, a Wireless Information window will appear.

Note: Press the **RED** button if you confirm the situation of surrounding APs.

Item	Description
Status	Connected is displayed when the TV is connecting with the AP. Disconnected is displayed when the TV is disconnecting with the AP.
Signal	Connection signal strength with AP (STRONG/MEDIUM/WEAK)
Speed	The link speed with AP
Mode	Working mode (11a, 11b, 11g, 11n)
Channel	A channel in use (1-165)
Network Name	SSID set
Authentication	Authentication set
Encryption	Encryption set
Security Key	Security Key set
AP MAC Address	The AP's MAC address is displayed when the TV is connecting with AP.
USB MAC Address	The MAC address of USB (Dual Band WLAN Adapter) is displayed.
DHCP	Enabled is displayed when you use DHCP. Disabled is displayed when you do not use DHCP.
IP Address	The TV's IP address
Subnet Mask	Value of the Subnet Mask
Default Gateway	Address of the Default GATEWAY
DNS	Address of the DNS

Note: Even if AP for IEEE 802.11n is used when **Encryption** is set to **WEP** or **TKIP**, the Speed value might be low. **Encryption** is recommended to be changed to **AES** (left-hand column).

Advanced Network Setup

Note:

- When the DHCP function of the router connected with this TV is On, you can set **Auto Setup** to On or Off. (Usually set it to **On**.)
- When the DHCP function of the router is Off, set **Auto Setup** to **Off**, and manually set IP Address or DNS Address.

IP Address Setup

Auto Setup:

- 1 From the **PREFERENCES** menu, highlight **Network Setup** and press **OK**.
- 2 Press **▲** or **▼** to highlight **Advanced Network Setup**, and press **OK**.
- 3 Press **▲** or **▼** to highlight **IP Address Setup**, and press **OK**.
- 4 Highlight **Auto Setup**, and then press **◀** or **▶** to select **On**.

Note: Other items will be grayed out when **Auto Setup** is set to **On**.

Manual Setup:

- 1 From the **PREFERENCES** menu, highlight **Network Setup** and press **OK**.
- 2 Press **▲** or **▼** to highlight **Advanced Network Setup**, and press **OK**.
- 3 Press **▲** or **▼** to highlight **IP Address Setup**, and press **OK**.
- 4 Highlight **Auto Setup**, and then press **◀** or **▶** to select **Off**.
- 5 Press **▲** or **▼** to highlight **IP Address**.
- 6 Press **◀** or **▶** to highlight the field you want to change, and then use the number buttons to input the IP address. To save the setting, press **OK**.

Note:

- IP address field numbers must be between 0 and 255. If you input an incompatible number and press **OK**, the field number will reset to the previous value.
- 7 Press **▲** or **▼** to highlight **Subnet Mask**, and edit in the same way as IP Address.
 - 8 Press **▲** or **▼** to highlight **Default Gateway**, and edit in a way same as IP Address.

Note: If you manually set the IP address, you must not use the same IP address for any other device. The IP address you use should be a private address. If you do not know the correct values to use, please contact your network administrator or internet service provider.

DNS Setup

Note: When the DHCP function of the router connected to this TV is Off, set **Auto Setup** to **Off**, and manually set the DNS address(es). Your internet service provider should have provided these to you.

Auto setup:

- 1 From the **PREFERENCES** menu, highlight **Network Setup** and press **OK**.
- 2 Press **▲** or **▼** to highlight **Advanced Network Setup**, and press **OK**.
- 3 Press **▲** or **▼** to highlight **DNS Setup**, and press **OK**.
- 4 Highlight **Auto Setup**, and then press **◀** or **▶** to select **On**.

Note: Other items will be grayed out when **Auto Setup** is set to **On**.

Manual setup:

- 1 From the **PREFERENCES** menu, highlight **Network Setup** and press **OK**.
 - 2 Press **▲** or **▼** to highlight **Advanced Network Setup**, and press **OK**.
 - 3 Press **▲** or **▼** to highlight **DNS Setup**, and press **OK**.
 - 4 Highlight **Auto Setup**, and then press **◀** or **▶** to select **Off**.
 - 5 Press **▲** or **▼** to highlight **Primary DNS Address**.
 - 6 Press **◀** or **▶** to highlight the field you want to change, and then use the number buttons to input the Primary DNS Address. To save the setting, press **OK**.
- Note:**
- DNS address field numbers must be between 0 and 255. If you input an incompatible number and press **OK**, the field number will reset to the previous value.
- 7 Press **▲** or **▼** to highlight **Secondary DNS Address**, and edit in the same way as Primary DNS Address.

MAC Address

You can view the fixed MAC address for the TV and for the Dual Band WLAN Adapter, if one is installed.

- 1 From the **PREFERENCES** menu, highlight **Network Setup** and press **OK**.
- 2 Press **▲** or **▼** to highlight **Advanced Network Setup**, and press **OK**.
- 3 Press **▲** or **▼** to highlight **MAC Address**, and press **OK**.

Network Connection Test

This function checks the Internet connectivity.

- 1 From the **PREFERENCES** menu, highlight **Network Setup** and press **OK**.
- 2 Press **▲** or **▼** to highlight **Network Connection Test**, and press **OK**.

Note: A message will appear to indicate if the connection was successful or if it could not be completed.

Note: The result of Network Connection Test does not always guarantee the connection. Depending on the situation, VUDU or YouTube may not be able to be used.

To cancel the Network Connection Test:

Press **EXIT** while searching for the Internet connection.

Using the software keyboard

You can enter text by using the Software Keyboard. The Software Keyboard window will appear when you press **OK** on a field that accepts character input.

To enter text using the software keyboard:

- 1 Highlight the desired character on the on-screen software keyboard.
- 2 Press **OK**.
- 3 Repeat steps 1 and 2 until you have entered all desired text.
- 4 Press the **BLUE** button to close the software keyboard and return to the previous screen.

Note: If **RETURN** is pressed, changes are not saved and the software keyboard window is closed. The text will remain as it was before starting the keyboard.



Input operation on the remote control:

Button	Description
OK	Inputs the selected character.
0-9	Inputs the number directly.
▲ ▼ ◀ ▶	Moves the character highlight.
◀▶▶▶	Moves the cursor.
◀◀	Moves the cursor to the head of a character string.
▶▶	Moves the cursor to the end of a character string.
RED	Deletes 1 character to the left of the cursor.
GREEN	Cycles through upper case, lower case, numbers, and symbols, if available.
YELLOW	Chooses an accented version of the current letter, if applicable.
BLUE	Saves changes and closes the Software Keyboard window.
RETURN	Closes the Software Keyboard window without saving changes.

Performing a Software Upgrade

TOSHIBA may offer upgrades for the TV's software in the future. The TV's software is upgraded via the Network.

Before downloading software;

Configure your TV to connect to the Internet.

Note: While the upgrade is being performed, you will not be able to watch the TV.

- 1 From the **SETUP** menu, highlight **Software Upgrade** and press **OK**.
- 2 **Network Upgrade** is displayed. Press **OK**.
Note: If the network is not available, a warning message will appear.
- 3 The TV software upgrade will start when download succeeds.

Setting up the Media Renderer feature

Term meaning:

- DMS: DLNA CERTIFIED™ Server
- DMR: DLNA CERTIFIED™ Renderer
- DMC: DLNA CERTIFIED™ Controller

The TV can be configured as a DMR. When operating as a DMR, the TV is displaying content provided by a DMS. The selection of the media is done by the DMC – the TV does not select the input. The TV can play photo, movie, or audio files when operating as a DMR.

Installation

You can configure the DMR settings individually, or use Installation mode to be prompted for each setting in order.

- 1 From the **PREFERENCES** menu, highlight **Media Renderer Setup** and press **OK**.
- 2 Press **▲** or **▼** to highlight **Installation**, and press **OK**.
- 3 Press **◀** or **▶** to select **On**, and press **OK**.
- 4 If you want to change the device name as a Renderer, highlight the Device Name field and press **OK**. The Software Keyboard window will appear.
- 5 Input the Device Name by using the Software Keyboard (☞ page 69). To save your setting, press the **BLUE** button.
Note: The Device Name can be up to 127 characters long.
- 6 Highlight **Done**, and then press **OK**.
- 7 If you want to change the password, press **◀** or **▶** to select **Yes**, and then press **OK**.
- 8 Change the password by using the Software Keyboard (☞ page 69), and then press the **BLUE** button.
Note: The Web Password can be up to 15 characters long.
- 9 Highlight **Done**, and then press **OK**.
- 10 If you want to limit access from unexpected DMCs, press **◀** or **▶** to select **On**, and then press **OK**.
- 11 If you want to proceed with registration of DMCs, press **◀** or **▶** to select **Yes**, and then press **OK**.
- 12 Press **▲** or **▼** to highlight the item you want to accept, and press **OK**. A check will appear in the box. To remove the check, press **OK** again.
- 13 Press **▶** to highlight **Done**, and then press **OK**.

- 14 The **Maximum Volume Setup** window appear. Press **◀** or **▶** to adjust to the desired volume. Then, press **OK**.

Media Renderer

- 1 From the **PREFERENCES** menu, highlight **Media Renderer Setup** and press **OK**.
- 2 Press **▲** or **▼** to highlight **Media Renderer**, and then press **◀** or **▶** to select **On** or **Off**.

Device Name Setup

The device name as a DMR can be changed. The set device name can be confirmed from the DMC.

- 1 From the **PREFERENCES** menu, highlight **Media Renderer Setup** and press **OK**.
- 2 Press **▲** or **▼** to highlight **Device Name Setup**, and press **OK**.
- 3 Highlight the Device Name field and press **OK**. The Software Keyboard window will appear.
- 4 Input the Device Name by using the Software Keyboard (☞ page 69). To save your setting, press the **BLUE** button.
Note: The Device Name can be up to 127 characters long.
- 5 Highlight **Done**, and then press **OK**.

Web Password Setup

This setup sets a necessary password for the DMC's accessing a built-in Web page of a DMR.

- 1 From the **PREFERENCES** menu, highlight **Media Renderer Setup** and press **OK**.
- 2 Press **▲** or **▼** to highlight **Web Password Setup**, and press **OK**.
- 3 Highlight the Password field and press **OK**. The Software Keyboard window will appear.
- 4 Change the password by using the Software Keyboard (☞ page 69), and then press the **BLUE** button.
Note:
 - The Web Password can be up to 15 characters long.
 - Only the password can be changed. User ID cannot be changed.
- 5 Highlight **Done**, and then press **OK**.

Note:

- Some DMC can view or modify the device name of the DMR.
- Depending on the TV's state, the device name may not be able to set from Web page.
- Confirm the DMCs instruction manual for the way of accessing Web pages.

Media Controller Setup

You can limit which DMC can control this TV. If Access Control is enabled, only those DMCs with a check will be allowed to control the TV.

- 1 From the **PREFERENCES** menu, highlight **Media Renderer Setup** and press **OK**.
- 2 Press **▲** or **▼** to highlight **Media Controller Setup**, and press **OK**.
- 3 Press **▲** or **▼** to highlight **Access Control**, and then press **◀** or **▶** to select **On**.
- 4 Press **▲** or **▼** to highlight **Select Media Controller**, and press **OK**.
- 5 Press **▲** or **▼** to highlight the item you want to accept, and press **OK**. A check will appear in the box. To remove the check, press **OK** again.
- 6 Press **▶** to highlight **Done**, and then press **OK**.

Note:

- You can select up to 8 DMC devices.
- If you would not like to limit the DMCs for this TV, set **Access Control** to **Off**.
- Devices other than DMC may be displayed in the list. Confirm the MAC address of DMC and set it.

Maximum Volume Setup

This feature allows you to set the maximum volume of the TV when it receives volume operation commands from a DMC.

- 1 From the **PREFERENCES** menu, highlight **Media Renderer Setup** and press **OK**.
- 2 Press **▲** or **▼** to highlight **Maximum Volume Setup**, and press **◀** or **▶** to adjust to the desired volume.

Note:

- The TV's remote control can set volume regardless of the value of Maximum Volume Setup.
- When DMR playback is ended, the TV volume will return to the value in effect when DMR playback is started.

Using the Widgets feature

The Widgets feature allows you to easily access certain websites.

Note:

- You need to configure a home network before using this feature (see page 22).
- If **Network Lock** is set to **On**, it will be necessary to enter your four-digit PIN code in order to access network features.

- 1 From the **APPLICATIONS** menu, highlight **Widgets** and press **OK** or press **WIDGETS** on the remote control. The Widgets display will appear.
- 2 Press **▲**, **▼**, **◀** or **▶** to select the widget you want to access, and press **OK**.

To close the Widgets display:

Press **EXIT**.

VUDU™

VUDU™ is an on-demand service that offers high-definition movies on the Web.

You can access the VUDU service by either of the following methods:

From the menu:

- 1 Press **MENU**.
- 2 From the **APPLICATIONS** menu, highlight **VUDU** and press **OK**.

From Widgets:

- 1 Press **WIDGETS**.
- 2 Press **▲**, **▼**, **◀** or **▶** to select **VUDU**, and press **OK**.

To deactivate your device:

This feature allows you to deactivate VUDU service.

- 1 From the **PREFERENCES** menu, highlight **VUDU Deactivation** and press **OK**.
- 2 Press **◀** or **▶** to select **Yes**, and press **OK**.

Playing YouTube™

YouTube is a video-sharing service managed by YouTube, LLC.

This TV allows you to view YouTube contents.

Note:

- You need to configure a home network before using this feature (☞ page 22).
- If **Network Lock** is set to **On**, it will be necessary to enter your four-digit PIN code in order to access network features.

- 1 From the **APPLICATIONS** menu, highlight **YouTube** and press **OK**.
- 2 Press **▲**, **▼**, **◀** or **▶** to select the file you want to view, and press **OK**.

To close the YouTube:

Press **EXIT**.

Note:

- YouTube contents have been independently managed by YouTube, LLC.
- Not all YouTube contents that can be accessed by computer may be viewed with this TV.
- This TV may not be able to do some operations that computer can do.
- Depending on network environment and the use situation, content may be difficult to view.
- Though the same volume value, an actual volume might be greatly different depending on contents.
- This TV might take time to the start-up and the playback of contents.
- Content that the user may feel is improper or offensive may be included in the contents of YouTube.
- We do not assume at all the responsibility for contents that YouTube offers.
- If you have any questions about YouTube contents, please contact YouTube, LLC.
- The content of service and the screen that can be used may be changed without a previous notice.
- You cannot post videos to YouTube from this TV. Please use a PC to post videos.
- Not all contents can be viewed normally when you access to websites other than YouTube XL through this TV.

Using Function

Function are entrances to the functions that are often used.

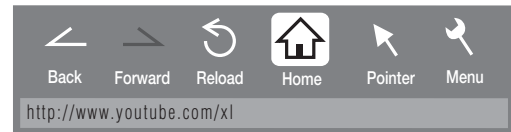

- 1 Press the **BLUE** button while displaying YouTube. The Function menu window will appear.
- 2 Press **◀** or **▶** to select the desired icon, and press **OK**.





Item	Description
Back	Returns to the previous page.
Forward	Moves to the forward page.
Reload/ Abort	Updates the displayed page./ Aborts update (X is displayed while reading, and ↻ is displayed in other case.)
Home	Returns to the top page of YouTube.
Pointer	Switches the pointer On/Off or drag mode.
Menu	Switches the frame or sets various settings (☞ pages 73–75).

Switching the pointer

The tool that operates the screen can be changed to the pointer or the drag mode.



- 1 From the Function menu, press ◀ or ▶ to select **Pointer**, and then press **OK**.
- 2 If you select , see "To use the Pointer: ON" on this page. If you select , see "To use the Drag Mode" on this page.

To use the Pointer: ON:

- 1 Press ▲ or ▼ to select **Pointer: ON**, and press **OK**.
 -  will appear.
- 2 Press ▲, ▼, ◀ or ▶ to the place where  changes to , and then press **OK**.

Note: When **Pointer: OFF** is selected and ▲, ▼, ◀ or ▶ is pressed, the highlight moves to linked areas.

To use the Drag Mode:

- 1 Press ▲ or ▼ to select **Pointer: ON**, and press **OK**.
- 2 Press the **BLUE** button.
- 3 From the Function menu, press ◀ or ▶ to select **Pointer**, and then press **OK**.
- 4 Press ▲ or ▼ to select **Drag Mode**, and press **OK**.
 -  will appear.
- 5 Press **OK**, and then  changes to .
- 6 Press ▲, ▼, ◀ or ▶ to move the selected item in the desired place.

Switching the frame

- 1 From the Function menu, press ◀ or ▶ to select **Menu**, and then press **OK**.
- 2 Press ◀ or ▶ to select **Page Tasks**.
- 3 Highlight **Switch Frames**, and press **OK**.

Setting the view feature

- 1 From the Function menu, press ◀ or ▶ to select **Menu**, and then press **OK**.
- 2 Press ◀ or ▶ to select **View**.
- 3 Press ▲ or ▼ to select the desired item, and press **OK**.
- 4 Press ▲ or ▼ to select the desired setting, and press **OK**.

Item	Settings
Display Mode	<p>Normal: Displays YouTube page with the size as it is.</p> <p>Just-Fit Rendering: Displays YouTube page by a size that the width was adjusted to be suitable for this TV.</p>
Text Size	<p>Changes the font size of the screen. Select from Largest, Large, Medium, Small or Smallest.</p> <p>Note: This font size is effective only for the page.</p>
Advanced Settings	See the next column.
Page Information	Displays the information of the page you are viewing.
Server Certificates	Displays the server certification.

To setup the Advanced Settings:

- 1 Press ▲, ▼, ◀ or ▶ to select the setting items, and press **OK**. A check will appear in the box. To remove the check, press **OK** again.
- 2 Press ▲, ▼, ◀ or ▶ to select OK field, and press **OK**.

Item	Description
Image	Sets display/non-display of images.
Table	Sets effect/non-effect of tables.
CSS	Sets effect/non-effect of CSS.
Japanese hyphenation	Sets effect/non-effect of the Japanese hyphenation.
Pop-up window	Sets effect/non-effect of pop-up windows.
Animation	Sets display/non-display of animations.
JavaScript	Sets effect/non-effect of JavaScript.
Word wrap	Sets effect/non-effect of Word Wrap. If Word Wrap enables, a word not finished at the end of line is shifted to the next line.
Rapid-Render	Sets effect/non-effect of Rapid-Render. If Rapid-Render enables, texts and links are displayed first, and the images and the tables, etc. are displayed afterward. The highlight can be moved with the text and the link displayed.

Setting other features

- 1 From the Function menu, press ◀ or ▶ to select **Menu**, and then press **OK**.
- 2 Press ◀ or ▶ to select **Settings**.
- 3 Press ▲ or ▼ to select the desired item, and press **OK**.
- 4 Press ▲ or ▼ to select the desired setting, and press **OK**.

Item	Settings
Security	When jumping from a protected page to an unprotected page, the message is displayed when the check is applied to Notify of secure/non-secure page changes . Apply the check to select SSL version from SSL Version to use (SSL2.0, SSL3.0, TSL1.0) . A content confirmation of the certification and a setting effect/non-effect can be done in Root Certificates and CA Certificates (☞ right-hand column).
Cookies	Accept all: Cookie is received, and it records in this TV. Reject all: Cookie is not received. Prompt before accepting: When Cookie is received, a message window will be displayed.
Delete Cookies	Deletes all recorded Cookies.
Cache	Use cache: When the check is applied to this, cache is used. Delete All Cache Data: Deletes all the cache preserved in the television.
Browser Information	Displays the information on a browser.

Note:

- *Cookie is the technical information that a website leaves in this TV so that the website will recognize you when you use it again.*
- *Cache is a system used to shorten the display time by checking the past data preserved in this television when a page that you viewed before is seen again.*

To confirm Root Certificates or CA Certificates:

- 1 Press ▲ or ▼ to select **Security** in **Setting the other feature** step 3.
- 2 Press ▲, ▼, ◀ or ▶ to select **Root Certificates** or **CA Certificates**, and press **OK**.
- 3 Press ▲ or ▼ to select the desired certificate:
 - When **OK** is pressed, a detailed information window will appear.
 - When the **BLUE** button is pressed, **Disable** or **Enable** bar will appear. It changes whenever **BLUE** button is pressed.
- 4 Press **RETURN**.

Using the Media Player

This TV allows you to enjoy photo files stored on a USB device or SD Memory Card.

Moreover, you can also play photos, movies or music files from your PC by connecting the TV to your home network. There are two ways to play contents.

Term meaning:

DMP: DLNA CERTIFIED™ Player
DMS: DLNA CERTIFIED™ Server
DMR: DLNA CERTIFIED™ Renderer
DMC: DLNA CERTIFIED™ Controller

- DMP: The TV can control and play a content on a DMS.
 - DMS is a device which has a server function to DMP or DMR.
- DMR: The TV can play a content on a DMS. The playback is controlled by a DMC.
 - DMC is a device which can command the TV to display contents.

Note:

- USB device or SD Memory Card is available for viewing JPEG files.
- Do not insert/remove USB device or SD Memory Card while in use.
- **MENU** is not available during playback.
- When you want to use your TV as DMR, set **Media Renderer** to **On** (☞ “Media Renderer” on page 70).

Media Player Specifications

Device

USB device:

USB Mass Storage Class devices (MSC)

Note:

- Connectivity is not guaranteed for all devices.
- Incorrect behavior may occur with a USB HUB connection.

SD Memory Card:

SD Memory Card: up to 2GB

SD High Capacity Memory Card (SDHC): 4 - 32GB

Note: Do not use any SD Memory Cards other than those specified.

DLNA CERTIFIED™ Server:

Your PC (for example)

Supported file system

FAT12, FAT16 and FAT32

You must obtain any required permission from copyright owners to download or use copyrighted content. Toshiba cannot and does not grant such permission.

Basic operation

Using Media Player with USB and SD Memory Card

When Auto Start is enabled, you will be asked if you want to start the Media Player whenever a USB or SD device is inserted. If Auto Start is disabled (or if you want to connect to a DMS on the network), you must manually start the Media Player from the menu.

To change the Auto Start setting:

- 1 From the **APPLICATIONS** menu, highlight **Media Player** and press **OK**.
- 2 Press **▲** or **▼** to highlight **Setup**, and press **OK**.
- 3 Press **▲** or **▼** to highlight **USB/SD Auto Start**, and then press **◀** or **▶** to select **On** or **Off**.

Auto Start:

- 1 Insert USB device into the **USB** terminal or SD Memory Card into the **SD card slot** on the right side of the TV. A prompt will appear.
- 2 Press **◀** or **▶** to select **Yes**, and then press **OK**.
- 3 Press **▲** or **▼** to select **Photo** and press **OK**. The thumbnail view will appear.
- 4 Press **▲** or **▼** to select USB device or SD Memory Card if the selection window is displayed.

Note: If **Auto Start** is set to **Off**, you can start the Media Player manually.

Manual Start:

- 1 Insert USB device into the **USB** terminal or SD Memory Card into the **SD card slot** on the right side of the TV.
- 2 From the **APPLICATIONS** menu, highlight **Media Player**, and then press **OK**.
- 3 Press **▲** or **▼** to select **Photo** and press **OK**. The thumbnail will appear.
- 4 Press **▲** or **▼** to select USB device or SD Memory Card if the selection window is displayed.

To select a file in the list of contents:

- 1 Press **▲**, **▼**, **◀** or **▶** to select a file or folder.
- 2 Press **OK** to move to the next layer, or press **RETURN** to return to the previous layer.

To close the Media Player:

Press **EXIT**. The TV will return to the last-viewed channel or video input.

Using Media Player with DLNA CERTIFIED™ Server

You need to configure a home network before using this feature (see page 21).

- 1 From the **APPLICATIONS** menu, highlight **Media Player**, and then press **OK**.
- 2 Press **◀** or **▶** to select **Photo**, **Movie**, or **Music** and press **OK**. The thumbnail (for Photo) or list of files (for Movie and Music) will appear.
Note: If there is more than one media server on the network, a list of all media servers will be displayed. Highlight the server you want to use, and press **OK**.
- 3 Press **▲** or **▼** to select DMS if the selection window is displayed.

To select a file in the list of contents:

- 1 Press **▲**, **▼**, **◀** or **▶** to select a file or folder.
- 2 Press **OK** to move to the next layer, or press **RETURN** to return to the previous layer.

To close the Media Player:

Press **EXIT**. The TV will return to the last-viewed channel or video input.

To set the Media Server Setup:

You only need to complete the Media Server Setup if you want to memorize DMS to be woken up later by the TV.

- 1 From the **APPLICATIONS** menu, highlight **Media Player**, and then press **OK**.
- 2 Press **▲** or **▼** to highlight **Setup**, and press **OK**.
- 3 Press **▲** or **▼** to highlight **Media Server Setup**, and press **OK**. The list that contains the currently active DMSs and the registered DMSs will appear.
- 4 Press **▲** or **▼** to select the desired device, and press **OK**. A check will appear in the box. To remove the check, press **OK** again.
- 5 Press **▶** to highlight **Done**, and then press **OK**.

Note:

- The setting is not saved when **RETURN** is pressed before **Done** is pressed.
- Up to 8 DMSs can be selected.
- Even if the device checked is power-off, it is displayed but grayed out in the Select Device window. When **OK** is pressed on a highlighted grayed out item, a confirmation of Wake-on-LAN is displayed. The TV tries to wake up the DMS if **Yes** is pressed. The Server will start if it supports Wake-on-LAN feature.
- Depending on Media Server, it may not start even if Wake-on-LAN is sent.
- When some DMSs are connected, it may take time until the list is displayed. The list may be smoothly displayed by the following operation.
 - The device selection window is closed once and it is displayed again.
 - The **RED** button is pressed.

Viewing Movie files (on DLNA CERTIFIED™ Server)

Basic Playback:

- 1 After selecting a file (see “To select a file in the list of contents” on page 76), press **OK** or **PLAY** to begin playback.

Note:

- When you highlight the file without pressing **OK**, the content is played on a preview screen. When **OK** is pressed, it is played in the full screen mode.
- Depending on the file size, it may take some time to start playback.

- 2 Press **STOP** to stop playback.
- 3 If playback finishes before **STOP** is pressed, the screen will return to the list.

Note: When the repeat mode is set to **All**, the next file will start playing automatically.

To pause playback:

Press **PAUSE/STEP** during playback.

To resume normal playback, press **PLAY**.

Note:

- You can move to the desired replay position by pressing **◀** or **▶** during PAUSE.
- PAUSE or operations during PAUSE may not be able to operate depending on contents, DMC or DMS.

To play in fast reverse or fast forward directions:

Press **REW** or **FF** during playback. Each time you press the **REW** or **FF**, the playback speed will change.

- **REW**: Fast reverse playback
- **FF**: Fast forward playback

To locate a specific file:

Press **SKIP** or **SKIP** repeatedly to access the desired file.

- **SKIP**: Playback starts from the beginning of the current file. When you press twice quickly, playback starts from the beginning of the previous file.
- **SKIP**: To locate subsequent files.

Note:

- If the previous or next file is not compatible, it will be skipped automatically.
- When the TV is used as a DMR, this feature is not available.
- These features may not be able to be operated depending on the contents, DMC or DMS.

To select a language:

If subtitle or audio information is available in the video file, you can select it.

- 1 Press **CC** during playback.
- 2 Press **▲** or **▼** to select **Subtitle** or **Audio**.
- 3 Press **◀** or **▶** to select your preferred language.

To set the repeat mode:

- 1 Press **QUICK**.
- 2 The current repeat setting will appear. Press **◀** or **▶** to select **Off**, **All** or **1**.
- 3 Press **RETURN**. The setting is effective until the TV is turned off.

Mode	Description
Off	The content is played back only once.
All	Contents in the same folder are repeatedly played back.
1	The same content is repeatedly played back.

Note: When the TV is used as a DMR, this feature is not available.

To sort the folders and files:

- 1 Press **QUICK** to open the Quick menu in list mode.
- 2 Press **▲** or **▼** to select **Sort**.
- 3 Press **◀** or **▶** to select **Title**, **New** or **Old** to set the sorting rule.

Item	Description
Title	Title--File sorting rules: 1. Unicode priority 2. (0, 1, ..., 9), capital alphabet (A, B, ..., Z), small alphabet (a, b, ..., z), Chinese 3. Increasing order
New	From new to old according to the date and time when the contents were updated.
Old	From old to new according to the date and time when the contents were updated.

Note: Sorting may not be supported by the DMS you are connected to.

To display the device information:

- 1 Press **QUICK** to open the Quick menu in list mode.
- 2 Press **▲** or **▼** to select **Device Information**.

To display the file status information:

- 1 Press **NFO** during playback. The information will be displayed on the bottom of the screen.
- 2 Press **NFO** again to remove the information.

Note: The information may not be correctly displayed depending on contents, DMC or DMS.

File Compatibility:

File format:

Video: MPEG2(PS) PAL, MPEG2(PS) NTSC, MPEG2(TS)

Audio: LPCM / MPEG1-Layer1 / MPEG1-Layer2 / MPEG2-Layer2 / Dolby Digital (AC-3)

Maximum number of files: 1000 / folder

Playing Music file (on DLNA CERTIFIED™ Server)

Basic Playback:

1 After selecting a file (see page 76), press **OK** or **PLAY** to begin playback.

Note: Depending on the file size, it takes some time to start playback.

2 Press **STOP** to stop playback.
If playback finishes before **STOP** is pressed, the next file will start playing automatically.

To pause playback:

Press **PAUSE/STEP** during playback.
To resume normal playback, press **PLAY**.

Note:

- You can move to the desired replay position by pressing **◀** or **▶** during PAUSE.
- PAUSE or operations during PAUSE may not be able to operate depending on contents, DMC or DMS.

To play in fast reverse or fast forward directions:

Press **REW** or **FF** during playback. Each time you press the **REW** or **FF**, the playback speed will change.

- **REW**: Fast reverse playback
- **FF**: Fast forward playback

Note: This feature is not controlled by DMC.

To locate a specific file:

Press **SKIP** or **SKIP** repeatedly to access the desired file.

- **SKIP**: Playback starts from the beginning of the current file.
- When you press twice quickly, playback starts from the beginning of the previous file.
- **SKIP**: To locate subsequent files.

Note:

- If the previous or next file is not compatible, it will be skipped automatically.
- When the TV is used as a DMR, this feature is not available.

To set the repeat mode:

- 1** Press **QUICK**. The current repeat setting will appear.
- 2** Press **◀** or **▶** to select **Off**, **All** or **1**.
- 3** Press **RETURN**. The setting is effective until the TV is turned off.

Mode	Description
Off	Contents in the same folder are played back once.
All	Contents in the same folder are repeatedly played back.
1	The same content is repeatedly played back.

Note: When the TV is used as a DMR, this feature is not available.

To sort the folders and files:

- 1** Press **QUICK** to open the Quick menu in the list mode.
- 2** Press **▲** or **▼** to select **Sort**.
- 3** Press **◀** or **▶** to select **Title**, **New** or **Old** to set the sorting rule.

Item	Description
Title	Title--File sorting rules: 1. Unicode priority 2. (0, 1, ..., 9), capital alphabet (A, B, ..., Z), small alphabet (a, b, ..., z), Chinese 3. Increasing order
New	From new to old according to the date and time when the contents were updated.
Old	From old to new according to the date and time when the contents were updated.

Note: Sorting may not be supported by the DMS you are connected to.

To display the device information:

- 1** Press **QUICK** to open the Quick menu in list mode.
- 2** Press **▲** or **▼** to select **Device Information**.

To display the file status information:

- 1** Press **NFO** during playback. The information will be displayed on the bottom of the screen.
- 2** Press **NFO** again to remove the information.

Note: The information may not be correctly displayed depending on contents, DMC or DMS.

File Compatibility:

File format: MP3, LPCM
Sampling frequency: 32 kHz, 44.1 kHz, 48 kHz
Bit rate: from 32 to 320 kbps
Maximum number of files: 1000 / folder

Viewing Photo files

Multi View mode:

This view mode allows you to search for photos in a grid format. These pictures are displayed using thumbnail data in each image file.

- 1 Press ▲, ▼, ◀ or ▶ to move the highlight in one window.
 - If all of the photos will not fit in one screen, when pressing ◀ at the top left thumbnail, the screen will move to the previous page. Conversely, when pressing ▶ at the bottom right thumbnail, the screen will move to the next page.
- 2 When you select a folder, press Ⓞ to move to the next layer. Press Ⓜ to move back to the previous layer.
- 3 Press Ⓞ to view the selected photo in Single View mode.

Note: When the TV is used as a DMR, this feature is not available.

Single View mode:

In this view mode, only files located in the selected directory shall be displayed. When moving from Multi View mode to the Single View mode, the currently selected photo shall be displayed.

- 1 On Multi view mode, press ▲, ▼, ◀ or ▶ to select a file and press Ⓞ.
- 2 Press ▶ to view the next file, or press ◀ to view the previous file.

Note:

- If the previous or next file is not compatible, it will be skipped automatically.
- Single view mode is changed to Multi View mode when Ⓜ is pressed.

Slideshow mode:

This view allows you to watch a slideshow of the photos. In this mode, only files located in the selected directory will be played.

- 1 To switch to Slideshow mode, press Ⓞ while in Single View mode. To return to Single View mode, press Ⓞ again.
- 2 Press ▶ to view the next file, or press ◀ to view the previous file.

Note: If the previous or next file is not compatible, it will be skipped automatically.

Note: When the TV is used as a DMR, this feature is not available.

To sort the folders and files:

- 1 Press Ⓞ to open the Quick menu from Multi View mode.
- 2 Press ▲ or ▼ to select **Sort**.
- 3 Press ◀ or ▶ to select **Title**, **New** or **Old** to set the sorting rule.

Item	Description
Title	Title--File sorting rules: 1. Unicode priority 2. (0, 1, ..., 9), capital alphabet (A, B, ..., Z), small alphabet (a, b, ..., z), Chinese 3. Increasing order
New	From new to old according to the date and time when the picture was updated.
Old	From old to new according to the date and time when the picture was updated.

Note: Sorting may not be supported by the DMS you are connected to.

To display the device information:

- 1 Press Ⓞ to open the Quick menu from Multi View mode.
- 2 Press ▲ or ▼ to select **Device Information**.

To set the mode settings:

- 1 Press Ⓞ to open the Quick menu while in Single View mode or Slideshow mode.
- 2 Press ▲ or ▼ to highlight the item (**PICTURE**, **Picture Size**, **Interval Time** or **Repeat**).
- 3 Press ◀ or ▶ to adjust the setting.
- 4 Press Ⓜ to return to Single View mode or Slideshow mode.

Item	Description
Interval Time	To set a time interval to view photos at your preferred interval (3sec, 5sec, 10sec, 15sec, 30sec, 60sec, or 90sec).
Repeat	To display photos in the same directory repeatedly. On/Off

To rotate the image:

While viewing the image in Single View mode or Slideshow mode, press ▲ to rotate the image 90 degrees clockwise, press ▼ to rotate the image 90 degrees counterclockwise.

Note: When the TV is used as a DMR, this feature is not available.

To return to the thumbnail:

Press Ⓜ while in Single View mode or Slide Show mode.

To display file status information:

- 1 Press **INFO**. The information will be displayed on the bottom of the screen.
- 2 Press **INFO** again to remove the information from the screen.

Note: The file status information will disappear automatically.

Note: The information may not be correctly displayed depending on contents, DMC or DMS.

File Compatibility:

USB or SD card use

Data compatibility: JPEG Exif ver 2.2

File format: JPEG

Maximum viewable resolution:

4096 × 4096 (HW decode) pixels

16384 × 16384 (SW decode) pixels

Maximum photo size: 9 MB

Maximum number of files: 2000 / folder

Content on DLNA CERTIFIED™ Server

Data compatibility: JPEG EXIF Ver.1.x or later,
JFIF 1.02a

File format: JPEG

Maximum viewable resolution:

4096 × 4096 pixels (DMP)

1024 × 768 pixels (DMR)

Maximum photo size: 6 MB

Maximum number of files: 2000 / folder

Using the Photo Frame feature

This feature allows you to display a photo file stored on the TV.

- Only one photo file can be stored on the TV.
- The photo file can be overwritten with a file from an external device (USB, SD Memory Card).
- This Photo file cannot be imported from a DLNA CERTIFIED™ Server.

- 1 From the **PREFERENCES** menu, highlight **Photo Frame Setup** and press **OK**. The preview screen will appear.
- 2 Press **▶** to select **Start**, and then press **OK** to start Photo Frame.

To open from the Quick menu

- 1 Press **QUICK** to open the Quick menu.
- 2 Press **▲** or **▼** to select **Photo Frame**, and then press **OK** to start **Photo Frame**.

To close the Photo Frame:

Press **EXIT**.

Photo Select

- 1 From the **PREFERENCES** menu, highlight **Photo Frame Setup** and press **OK**. The preview screen will appear.
- 2 Press **▲** or **▼** to highlight **Photo Select**, and press **OK**. The device selection screen appears.
Note: This screen will not appear when there is only one device connected.
- 3 Press **▲** or **▼** to select the appropriate device, and then press **OK**.
- 4 Press **▲**, **▼**, **◀** or **▶** to select the photo you want to copy from the USB storage device or SD card to the TV, and then press **OK**.

Photo Edit

- 1 From the **PREFERENCES** menu, highlight **Photo Frame Setup** and press **OK**. The preview screen will appear.
- 2 Press **▲** or **▼** to highlight **Photo Edit**, and press **OK**.
- 3 Press **▲** or **▼** to select **Rotate** or **Delete**.
- 4 Set the following items as required.
 - **Rotate** - Press **OK** to rotate the image 90° clockwise.
 - **Delete** - Press **◀** or **▶** to select **YES**, and then press **OK**.
- 5 Press **EXIT**.

Auto Power Off

- 1** From the **PREFERENCES** menu, highlight **Photo Frame Setup** and press **OK**. The preview screen will appear.
- 2** Press **▲** or **▼** to highlight **Auto Power Off**.
- 3** Press **◀** or **▶** to select Off, 00:30, 01:00, 02:00, 04:00, 06:00 or 12:00.
 - *If the Photo Frame window is left open, the TV will automatically turn off after the set length of time (maximum 12 hours).*
- 4** Press **EXIT**.

Chapter 9: Troubleshooting

General troubleshooting

Before calling a service technician, please check this chapter for a possible cause of the problem and some solutions you can try.

Black box on-screen

- The closed caption feature is set to one of the Text modes (**T1**, **T2**, **T3**, or **T4**). Set the closed caption feature to **Off** (🔗 page 42).

TV stops responding to controls

- If the TV stops responding to the controls on the remote control or TV control panel and you cannot turn off the TV, press and hold the **POWER** button on the TV control panel for 5 or more seconds to reset the TV.

Other problems

- If your TV's problem is not addressed in this Troubleshooting section or the recommended solution has not worked, use the Reset Factory Defaults procedure (🔗 page 53).

TV will not turn on

- Make sure the power cord is plugged in, and then press **POWER**.
- The remote control batteries may be dead. Replace the batteries or try the control panel buttons.

Picture problems

General picture problems

- Check the antenna/cable connections (🔗 Chapter 2).
- Press **INPUT** on the remote control or the TV and select a valid video input source (🔗 page 41). If no device is connected to a particular input on the TV, no picture will display when you select that particular input source. For device connection details, see Chapter 2.
- Antenna reception may be poor. Use a highly directional outdoor antenna (if applicable).
- The station may have broadcast difficulties. Try another channel.
- Adjust the picture qualities (🔗 page 57).

Video Input Selection problems

- If the **Input Selection** window does not appear when you press **INPUT** on the remote control or the TV control panel, press **INPUT** a second time, which will change to the next video input source and display the **Input Selection** window.

Cannot view external signals or channel 3 or 4

- If you cannot view signals from external devices connected to **VIDEO**, **ColorStream HD**, **HDMI 1**, **HDMI 2**, **HDMI 3**, **HDMI 4**, **PC** or from channels 3 or 4, make sure the **Input Lock** is set to **Off** (🔗 page 45).

Poor color or no color

- The station may have broadcast difficulties. Try another channel.
- Check the AV Input mode when you use Video or ColorStream HD (🔗 page 36).
- Adjust the **Tint** and/or **Color** (🔗 page 57).

Poor composite picture

- If the TV is connected to an external A/V device (e.g. DVD player, video game system, set-top box, etc.) try using a **ColorStream** or **HDMI** video connection instead.

Picture and sound are out of sync

- As with all products that contain a digital display, in rare instances, when viewing certain content (e.g. television broadcasts, video games, DVDs), you may notice that the sound and picture are slightly out of sync. This phenomenon can be caused by various factors including, without limitation, video processing within the TV, video processing in an attached gaming system, and video processing or different compression rates used by broadcasters in their programming. You may want to try one or more of the following suggestions, which may help to reduce the effect of this phenomenon:
 - If the TV is connected to an A/V receiver that has a programmable audio delay feature, use this feature to help synchronize the sound to the picture.
 - If you notice this phenomenon only on certain TV channels, please contact your local broadcast, cable, or satellite provider to inform them of this issue.

Sound problems

- Check the antenna/cable connections (🔗 Chapter 2).
- The station may have broadcast difficulties. Try another channel.
- The sound may be muted. Press **VOLUME**.
- If you hear no sound, try setting the **MTS** feature to **Stereo** mode (🔗 page 62).
- If you are not receiving a second audio program from a known SAP source, make sure the **MTS** feature is set to **SAP** mode (🔗 page 62).
- If you hear audio that seems “incorrect” for the program you are watching (such as music or a foreign language), the SAP mode may be on. Set the **MTS** feature to **Stereo** mode (🔗 page 62).
- If you connect a PC using either the **PC IN** terminal or an **HDMI** terminal, make sure that the **PC Audio** setting is properly set (🔗 page 50).

Remote control problems

- Make sure the remote control is set to the correct device mode (🔗 page 28).
- Remove all obstructions between the remote control and the TV.
- The remote control batteries may be dead. Replace the batteries (🔗 page 23).
- Your TV remote control may not operate certain features on your external device. Refer to the owner's manual for your other device to determine its available features. If your TV remote control does not operate a specific feature on another device, use the remote control that came with the device (🔗 pages 29–31).
- If the TV still does not act as expected, use the Reset Factory Defaults procedure (🔗 page 53).

(continued)

Channel tuning problems

- Make sure the remote control is set to the correct device mode (🔗 page 28).
- The channel may have been erased from the channel memory by the **Auto Tuning** feature. Add the channel to the channel memory (🔗 page 35).
- The channel may be blocked by the **Lock** feature. Unblock the channel (🔗 page 45).
- If you are unable to tune digital channels, check the antenna configuration (🔗 page 35). If you are still unable to tune digital channels, clear all channels from the channel list and reprogram channels into the channel memory (🔗 page 35). If you are still unable to tune digital channels, use the Reset Factory Defaults procedure (🔗 page 53). Also see “TV stops responding to controls” and “Other problems” (🔗 page 83).

Closed caption problems

- If the program or video you selected is not closed-captioned, no captions will display.
- If text is not available, a black rectangle may appear. If this happens, turn off the closed caption feature (🔗 page 42).
- A closed-caption signal may not display correctly in the following situations: a) when a videotape has been dubbed; b) when the signal reception is weak; or c) when the signal reception is nonstandard (🔗 page 42).

Rating blocking (V-Chip) problems

- If you forget your PIN code: While the PIN code entering screen is displayed, press  four times within 5 seconds. The PIN code you previously stored will be cleared (🔗 page 43).
- The V-Chip feature is available for the U.S. V-Chip system only (🔗 page 43).

No REGZA-LINK operation

- The REGZA-LINK feature is available for Toshiba REGZA-LINK compatible devices.
- Make sure HDMI cables with the HDMI Logo (**HDMI**) are used.
- When the connected REGZA-LINK device does not work correctly after you have changed settings of the device, turn off your TV and unplug the power cord, then plug and turn on again.
- If several devices are connected, the REGZA-LINK feature may not operate properly.
- Read the instruction manual furnished with the connected REGZA-LINK device.

HDMI problems

For HDMI cables

- Make sure HDMI cables with the HDMI Logo (**HDMI**) are used (🔗 page 13).

For Legacy HDMI sources

- Some legacy HDMI sources may not work properly with the latest HDMI TV products due to new standard adoption. Please try turning Off these HDMI settings (Content Type and INSTAPORT™) (🔗 page 49).

Network problems

Cannot connect to network

- Check the modem and splitter connections (🔗 pages 21–22).
- Check the Dual Band WLAN Adapter connections (🔗 page 22).
- Make sure the splitter is connected to the modem or LAN port correctly (🔗 page 22).
- Confirm your modem's operation.
- Make sure your network address is set up correctly.

No network connection

- The LAN cables are not connected properly or at all. Connect all cables (🔗 pages 21–22).
- Make sure the modem's power cord is plugged in.
- Make sure your network address is set up correctly (🔗 “Setting up the Network” on page 65).

Network Setup fails (Auto)

- The LAN cables are not connected properly or at all. Connect all cables.
- The DHCP service is not enabled on the router, or no router is present. Refer to your router's documentation for instructions on enabling DHCP. If you do not have a router, you must manually set up the network address.
- Internet service is not available. Check your cable/DSL modem or contact your ISP for Internet service issues.

Network Setup fails (Manual)

- The TV IP address is the same as the networked PC's. The TV IP address must be different from the PC's IP address.
- The TV IP address is not on the same subnet as the networked PC's. For example, if the PC has IP 192.168.0.100 with netmask 255.255.255.0, and the TV has IP 192.168.0.200 with netmask 255.255.255.0, then they are both on same subnet. Conversely, if the PC has IP 192.168.1.100 with netmask 255.255.255.0, and the TV has IP 192.168.0.200 with netmask 255.255.255.0, then they are on DIFFERENT sub-nets.

Unstable network connection

- Unplug the Ethernet cables, and then connect them again.

The "Server" name is not displayed

- The LAN cables are not connected properly or at all. Connect all cables (🔗 pages 21–22).
- The network setup on the Server is incorrect. Make sure both the Server and TV are using the same network type (DHCP/manual) and have compatible network settings.
- Too many sharing devices are connected. You cannot connect more than 32 sharing devices at one time.

Wireless network problems

- Make sure the Dual Band WLAN Adapter connection (☞ page 22).
- Check that the power of AP is On.
- After starting wireless network setup, confirm that the window that the wireless constitution was completed successfully appears.
- Check the AP's connection status (☞ page 67).
- If the AP does not correspond to the PBC of WPS, Easy Setup (PBC) cannot set even if its push-button is pressed.
- If AP list is not displayed in Easy Setup (PIN) or Assisted Setup, the power of AP may be Off. Check that it is On, and then try starting the AP scan.
- Read the AP's instruction manual.

Media Player problems

- Make sure that devices are connected correctly.
- Incorrect behavior may occur with a USB HUB connection.
- If the played photo is low-resolution, make sure that the DMS may change the scale of a image. This TV may select and play the changed image.
- If this TV cannot play some photo files, make sure that they were not edited by PC application. Some PC applications may change the photo format to incompatible.
- If the played content is low-resolution, make sure that the DMS supports the multiple formats for this content. This TV may select one of the formats for the content automatically.
- If this TV cannot play the content of DMS, make sure that the content is not copy-protected.
- If a playback is unstable, check the traffic or congestion on the network.
- Contents that PC originally recorded may not be able to be played correctly.
- A DMS may restrict access from this TV to the DMS. See the DMS's manual to allow this TV to access the DMS. This TV's MAC address can be confirmed at **MAC Address** (☞ page 68). Make sure that the contents of the DMS are compatible with the formats which this TV supports.
- If this TV cannot play the content of DMS, make sure the format is one of the formats which this TV supports (☞ pages 78, 79 or 81).

For DLNA CERTIFIED™ Player

- Depending on the DMS, it may take time to display the list.

For DLNA CERTIFIED™ Renderer

- Depending the state of this TV, DMC may not be able to control a DMR playback.
- If DMR playback start regardless a user intention, check the access control of DMS or set **Media Renderer** to **Off**.

LED indications

The Power and On Timer LED lights on the front of the TV indicate the TV's status, as described below.

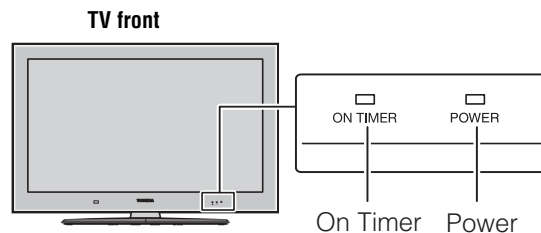

LED Indication

Power On/Standby LED

- **Green is ON (solid)**
The TV is operating properly.
- **Orange is ON (solid)**
Standby with Power-On Mode set to Fast. See "Power-On Mode" (☞ page 52).
- **Green blinks three times**
TV is powering up. Wait several seconds until the green LED stops blinking.
- **Green blinks**
Abnormal operation of BUS line. Turn OFF the TV and unplug the power cord. Plug the power cord in again and turn ON the TV.
- **Red blinks**
Power-On Failure. Turn OFF the TV and unplug the power cord. Plug the power cord in again and turn ON the TV.
- **Orange blinks**
Abnormal operation of back light. Turn OFF the TV and unplug the power cord. Plug the power cord in again and turn ON the TV.

On Timer LED

- **Green is ON (solid)**
On Timer is set.
- **Green blinks (if applicable)**
Fan Stopped. Turn OFF the TV and unplug the power cord. Plug the power cord in again and turn ON the TV.

If, after trying the solutions, the problem still exists:

- In the U.S., call TACP Consumer Solutions at 1-800-631-3811.

In Canada, locate the nearest Toshiba authorized service depot by directing your web browser to www.toshiba.ca; click "Home Entertainment," and then click "Support."

Chapter 10: Appendix

Specifications

Note:

- *This model complies with the specifications listed below.*
- *Designs and specifications are subject to change without notice.*
- *This model may not be compatible with features and/or specifications that may be added in the future.*

Television System

NTSC standard
ATSC standard (8VSB)
Digital Cable (64 QAM, 256 QAM; in-the-clear, unencrypted)

Channel Coverage

VHF: 2 through 13
UHF: 14 through 69
Cable TV: Mid band (A-8 through A-1, A through I)
Super band (J through W)
Hyper band (AA through ZZ, AAA, BBB)
Ultra band (65 through 94, 100 through 135)

Power Source

120 V AC, 60 Hz

Power Consumption

40UX600U:
1.3 A (rms) (maximum current)
0.08 W in standby mode
46UX600U:
1.4 A (rms) (maximum current)
0.09 W in standby mode
55UX600U:
1.6 A (rms) (maximum current)
0.09 W in standby mode

Audio Power

10 W + 10 W

Speaker Type

Main: Two 1-3/8 × 2-3/4 inches (35 × 70 mm)

Video/Audio Terminals

VIDEO/AUDIO INPUT:

VIDEO: 1 V(p-p), 75 ohm, negative sync.
AUDIO: 200 mV(rms) (-20dBFS)

ColorStream® (component video) HD INPUT:

VIDEO: Y: 1V(p-p), 75 ohm
PR: 0.7 V(p-p), 75 ohm
PB: 0.7 V(p-p), 75 ohm
Suggested formats: 1080p, 1080i, 720p, 480p, 480i
AUDIO: 200 mV(rms), 22 k ohm or greater

HDMI® INPUT:

HDMI compliant
HDCP compliant
Suggested formats: See table on page 89.
HDMI Audio: 2-channel Linear-PCM/Dolby Digital (AC-3); 32/44.1/48 kHz sampling frequency; 16/20/24 bits per sample

DIGITAL AUDIO OUTPUT:

Optical type

IR OUT:

3 V(p-p), 3.5 mm mono socket

PC INPUT:

15-Pin D-sub Analog RGB

Dimensions (include foot stand)

40UX600U: Width: 39-21/32 inches (1,007 mm)
Height: 27-1/16 inches (687 mm)
Depth: 12-31/32 inches (329 mm)
46UX600U: Width: 44-29/32 inches (1,140 mm)
Height: 29-31/32 inches (761 mm)
Depth: 12-31/32 inches (329 mm)
55UX600U: Width: 52-7/8 inches (1,343 mm)
Height: 34-31/32 inches (888 mm)
Depth: 15-19/32 inches (396 mm)

Mass (weight)

40UX600U: 38.6 lbs (17.5 kg)
46UX600U: 46.3 lbs (21.0 kg)
55UX600U: 62.8 lbs (28.5 kg)

Operating conditions

Temperature: 32°F - 95°F (0°C - 35°C)
Humidity: 20 - 80% (no moisture condensation)

Supplied Accessories

- Owner’s manual (this book)
- Pedestal assembly installation manual
- Stop/Quick set up guide
- Cleaning cloth’s manual
- Remote control
- Size “AAA” carbon zinc batteries (two)
- Dual Band WLAN Adapter (WLM-10U1)

Standard	IEEE 802.11a/b/g/n
Host Interface	USB2.0 compatible
Frequency Range	5.15–5.35 GHz, 5.47–5.725 GHz, 5.725–5.850 GHz, 2.412–2.462 GHz
Security	WEP64/128, TKIP, AES, WPA/ WPA2-PSK, WPS, None

- Securement Clip
Use this clip to attach the TV to a wall stud, pillar, or other immovable structure. See item 25 on page 4 and instructions on page 5.
- Cleaning cloth (to clean the cabinet and control panel)
- Registration card TACP
- Tool set

Acceptable signal formats for PC IN and HDMI terminals

PC IN signal formats

Note:

- The PC IN on this TV only accepts signal formats which are compliant with VESA-DMT as shown in the table below. Since some PCs input signals which are different from the resolution and frequency described in the table below, the following phenomenon may occur: incorrect display, false format detection, picture position failure, blur, or judder. In this case, set the monitor output format on your PC to conform to any signals in the table below.
- The signals whose vertical frequency are 56 Hz, 70 Hz, 72 Hz, or 75 Hz are converted to 60 Hz signal.
- When you connect a PC to this TV, it is recommended to set the refresh rate of your PC to 60 Hz.
- The PC IN on this TV does not accept the Sync on Green, Composite Sync and Interlace signals.

Format	Resolution	V. Frequency	H. Frequency	Pixel Clock Frequency	VESA Standard (DMT)
VGA	640 × 480	59.940/60 Hz	31.469/31.500 kHz	25.175/25.200 MHz	●
		72.809 Hz	37.861 kHz	31.500 MHz	●
		75.000 Hz	37.500 kHz	31.500 MHz	●
SVGA	800 × 600	56.250 Hz	35.156 kHz	36.000 MHz	●
		60.317 Hz	37.879 kHz	40.000 MHz	●
		72.188 Hz	48.077 kHz	50.000 MHz	●
		75.000 Hz	46.875 kHz	49.500 MHz	●
XGA	1024 × 768	60.004 Hz	48.363 kHz	65.000 MHz	●
		70.069 Hz	56.476 kHz	75.000 MHz	●
		75.029 Hz	60.023 kHz	78.750 MHz	●
WXGA	1280 × 768	59.995 Hz	47.396 kHz	68.250 MHz	●
		59.870 Hz	47.776 kHz	79.500 MHz	●
		74.893 Hz	60.289 kHz	102.250 MHz	●
	1360 × 768	60.015 Hz	47.712 kHz	85.500 MHz	●
SXGA	1280 × 1024	60.020 Hz	63.981 kHz	108.000 MHz	●
		75.025 Hz	79.976 kHz	135.000 MHz	●

HDMI signal formats

Note:

- The HDMI inputs on this TV only accept VGA, SVGA, XGA, WXGA, and SXGA signal formats which are compliant with VESA as shown in the table below. Since some PCs and HDMI or DVI devices input signals which are different from the resolution and frequency described in the table below, the following phenomenon may occur: incorrect display, false format detection, picture position failure, blur, or judder. In this case, set the monitor output format on your PC, HDMI or DVI device to conform to any signals in the table below.
- The signals whose vertical frequency are 24 Hz, 56 Hz, 70 Hz, 72 Hz, or 75 Hz are converted to 60 Hz signal.
- When you connect a PC to this TV, it is recommended to set the refresh rate of your PC to 60 Hz.

Format	Resolution	V. Frequency	H. Frequency	Pixel Clock Frequency	VESA Standard
VGA	640 × 480	59.940 Hz	31.469 kHz	25.175 MHz	●
		72.809 Hz	37.861 kHz	31.500 MHz	●
		75.000 Hz	37.500 kHz	31.500 MHz	●
SVGA	800 × 600	56.250 Hz	35.156 kHz	36.000 MHz	●
		60.317 Hz	37.879 kHz	40.000 MHz	●
		72.188 Hz	48.077 kHz	50.000 MHz	●
		75.000 Hz	46.875 kHz	49.500 MHz	●
XGA	1024 × 768	60.004 Hz	48.363 kHz	65.000 MHz	●
		70.069 Hz	56.476 kHz	75.000 MHz	●
		75.029 Hz	60.023 kHz	78.750 MHz	●
WXGA	1280 × 768	59.995 Hz	47.396 kHz	68.250 MHz	●
		59.870 Hz	47.776 kHz	79.500 MHz	●
		74.893 Hz	60.289 kHz	102.250 MHz	●
	1360 × 768	60.015 Hz	47.712 kHz	85.500 MHz	●
SXGA	1280 × 1024	60.020 Hz	63.981 kHz	108.000 MHz	●
		75.000 Hz	79.976 kHz	135.000 MHz	●
480i	720 × 480i	59.940/60 Hz	15.734/15.750 kHz	27.000/27.027 MHz	
480p	720 × 480p	59.940/60 Hz	31.469/31.500 kHz	27.000/27.027 MHz	
720p	1280 × 720p	59.940/60 Hz	44.955/45.000 kHz	74.176/74.250 MHz	
1080i	1920 × 1080i	59.940/60 Hz	33.716/33.750 kHz	74.176/74.250 MHz	
1080p	1920 × 1080p	23.976/24 Hz	26.973/27.000 kHz	74.176/74.250 MHz	
		59.940/60 Hz	67.433/67.500 kHz	148.352/148.500 MHz	

Limited United States Warranty for LCD Televisions

Toshiba America Consumer Products, L.L.C. ("TACP") makes the following limited warranties to original consumers in the United States.

THESE LIMITED WARRANTIES EXTEND TO THE ORIGINAL CONSUMER PURCHASER OR ANY PERSON RECEIVING THIS LCD TELEVISION AS A GIFT FROM THE ORIGINAL CONSUMER PURCHASER AND TO NO OTHER PURCHASER OR TRANSFEREE. LCD TELEVISIONS PURCHASED IN THE U.S.A. AND USED ANYWHERE OUTSIDE OF THE U.S.A., INCLUDING, WITHOUT LIMITATION, CANADA AND MEXICO, ARE NOT COVERED BY THESE WARRANTIES. LCD TELEVISIONS PURCHASED ANYWHERE OUTSIDE OF THE U.S.A., INCLUDING, WITHOUT LIMITATION, CANADA AND MEXICO, AND USED IN THE U.S.A., ARE NOT COVERED BY THESE WARRANTIES.

Limited One (1) Year Warranty on Parts and Labor

TACP WARRANTS THIS LCD TELEVISION AND ITS PARTS AGAINST DEFECTS IN MATERIALS OR WORKMANSHIP FOR A PERIOD OF ONE (1) YEAR FROM THE DATE OF ORIGINAL RETAIL PURCHASE. DURING THIS PERIOD, TACP WILL, AT TACP'S SOLE DISCRETION, REPAIR OR REPLACE A DEFECTIVE PART/PRODUCT WITH A NEW OR REFURBISHED PART/PRODUCT WITHOUT CHARGE TO YOU FOR PARTS OR LABOR. ANY PART OR PRODUCT REPLACED UNDER THIS LIMITED WARRANTY BECOMES THE PROPERTY OF TACP. IN SOME CASES, YOU MAY BE RESPONSIBLE FOR DELIVERING THE PRODUCT TO A SERVICE CENTER.

Rental Units

Warranty period begins on the date of the first rental or thirty (30) days after the date of shipment to the rental firm, whichever comes first.

Limited Warranty for Commercial Units

TACP warrants parts and labor for LCD Televisions that are sold and used for commercial purposes for a period of ninety (90) days after the date of original retail purchase. This warranty is void if the product is exposed to excessive temperature (heat/cold), moisture as outlined in the product's specification listed in the Owner's manual as well as exposure to excessive smoke, dust, or other airborne contaminants. All exclusions outlined in paragraph (4) and (5) under the "Your Responsibilities" section apply to commercial use.

Your Responsibility

Read the owner's manual thoroughly before operating this LCD Television. Complete and mail the enclosed product registration card or register your LCD Television online at www.tacp.toshiba.com/service. Registration of your LCD Television will enable TACP to contact you in the unlikely event a safety notification is required under the U.S.

Consumer Product Safety Act. Failure to complete and return the product registration card does not diminish your warranty rights.

THE ABOVE WARRANTIES ARE SUBJECT TO THE FOLLOWING CONDITIONS:

This Limited Warranty is extended only to the original purchaser and only covers product purchased as new.

- (1) A purchase receipt or other proof of the original purchase date is required for Warranty service.
- (2) All warranty servicing of this LCD Television must be performed by an Authorized TACP Service Station.
- (3) The warranties from TACP are effective only if this LCD Television is purchased and operated in the U.S.A. or Puerto Rico.
- (4) Removal and reinstallation of product that is mounted in such a manner as to impede normal service is not covered under these warranties. This includes wall mounts, custom cabinets and other installation methods that do not provide for direct and immediate access to the product for service purposes. Labor service charges for set installation, setup, adjustment of customer controls, and installation or repair of antenna, satellite or cable systems are not covered by this warranty. Reception problems caused by inadequate antenna systems, misaligned satellite dishes or improperly installed cable drops are your responsibility.
- (5) Warranties extend only to defects in materials or workmanship as limited above, and do not extend to any LCD Television or parts that have been lost or discarded by you or to damage to the LCD Television or parts caused by fires, misuse, abuse, accident, Acts of God (such as lightning or fluctuations in electric power), improper installation, improper maintenance, or use in violation of instructions furnished by TACP; use or malfunction through simultaneous use of this LCD Television and connected equipment; or to units that have been modified or had the serial number removed, altered, defaced, or rendered illegible.
- (6) Products purchased "AS-IS" or "With known faults, defects or problems" are not covered by this limited warranty. Product previously owned or registered by a consumer and resold is not covered by this limited warranty.
- (7) Product that is refurbished and resold is not covered under this warranty.

How to Obtain Warranty Service

If, after following all of the operating instructions in this manual, review the section entitled "Concierge" located on our Customer Support Web site "www.tacp.toshiba.com/customer-support". If you find that service is needed, follow the instructions provided on the web site or please contact TACP's Consumer Solution Center toll free at 1-800-631-3811. You must present upon request your original bill of sale or other proof of purchase including the serial number for in warranty service.

ALL WARRANTIES IMPLIED BY THE LAW OF ANY STATE OF THE U.S.A., INCLUDING THE IMPLIED WARRANTIES OF MERCHANTABILITY AND FITNESS FOR A PARTICULAR PURPOSE, ARE EXPRESSLY LIMITED TO THE DURATION OF THE LIMITED WARRANTIES SET FORTH ABOVE. WITH THE EXCEPTION OF ANY WARRANTIES IMPLIED BY THE LAW OF ANY STATE OF THE U.S.A. AS HEREBY LIMITED, THE FOREGOING WARRANTY IS EXCLUSIVE AND IN LIEU OF ALL OTHER WARRANTIES, GUARANTEES, AGREEMENTS, AND SIMILAR OBLIGATIONS OF TACP WITH RESPECT TO THE REPAIR OR REPLACEMENT OF ANY PARTS. IN NO EVENT SHALL TACP BE LIABLE FOR CONSEQUENTIAL OR INCIDENTAL DAMAGES (INCLUDING, BUT NOT LIMITED TO, LOST PROFITS, BUSINESS INTERRUPTION, OR MODIFICATION OR ERASURE OF RECORDED DATA CAUSED BY USE, MISUSE OR INABILITY TO USE THIS LCD TELEVISION).

No person, agent, distributor, dealer or company is authorized to change, modify or extend the terms of these warranties in any manner whatsoever. The time within which an action must be commenced to enforce any obligation of TACP arising under the warranty or under any statute, or law of the United States or any state thereof, is hereby limited to ninety (90) days from the date you discover or should have discovered, the defect. This limitation does not apply to implied warranties arising under the law of any state of the U.S.A.

THIS WARRANTY GIVES YOU SPECIFIC LEGAL RIGHTS AND YOU MAY ALSO HAVE OTHER RIGHTS WHICH MAY VARY FROM STATE TO STATE IN THE U.S.A. SOME STATES OF THE U.S.A. DO NOT ALLOW LIMITATIONS ON THE DURATION OF AN IMPLIED WARRANTY, WHEN AN ACTION MAY BE BROUGHT, OR THE EXCLUSION OR LIMITATION OF INCIDENTAL OR CONSEQUENTIAL DAMAGES. THEREFORE, THE ABOVE PROVISIONS MAY NOT APPLY TO YOU UNDER SUCH CIRCUMSTANCES.

Limited Canadian Warranty for Toshiba Brand Flat Panel Televisions

Toshiba of Canada Limited ("TCL") makes the following limited warranties to original consumers in Canada. THESE LIMITED WARRANTIES EXTEND TO THE ORIGINAL CONSUMER PURCHASER OR ANY PERSON RECEIVING THIS TOSHIBA BRAND FLAT PANEL TELEVISION (the "TELEVISION(S)" or "Television(s)") AS A GIFT FROM THE ORIGINAL CONSUMER PURCHASER AND TO NO OTHER PURCHASER OR TRANSFEREE.

TELEVISIONS PURCHASED IN CANADA, AND USED ANYWHERE OUTSIDE OF CANADA INCLUDING, WITHOUT LIMITATION, THE UNITED STATES AND MEXICO, ARE NOT COVERED BY THESE WARRANTIES.

TELEVISIONS PURCHASED ANYWHERE OUTSIDE OF CANADA, INCLUDING, WITHOUT LIMITATION, THE UNITED STATES AND MEXICO, AND USED IN CANADA, ARE NOT COVERED BY THESE WARRANTIES.

Limited One (1) Year Warranty on Parts and Labour

TCL warrants the Television and its parts against material defects in materials or workmanship that result in the Television failing for a period of one (1) year after the date of original retail purchase. DURING THIS PERIOD, TCL WILL, AT TCL'S OPTION, REPAIR OR REPLACE A DEFECTIVE PART WITH A NEW OR RECERTIFIED PART WITHOUT CHARGE TO YOU FOR PARTS OR LABOUR.

Rental Units

The warranty for Television rental units begins with the date of first rental or thirty (30) days from the date of shipment to the rental firm, whichever comes first.

Your Responsibility

Read the owner's manual thoroughly before operating this LCD Television. Complete and mail the enclosed product registration card or register your LCD Television online at <http://support.toshiba.ca/warranty/>. Registration of your LCD Television will enable TCL to contact you in the unlikely event of a product safety notice. Failure to complete the product registration does not diminish your warranty rights.

THE ABOVE WARRANTIES ARE SUBJECT TO THE FOLLOWING CONDITIONS:

- (1) You must provide your bill of sale or other proof of purchase.
- (2) All warranty servicing of this Television must be performed by a Toshiba Authorized Service Provider (ASP).
- (3) The warranties from TCL are effective only if the Television is (i) purchased as new and unopened from TCL or from TCL's authorized distributors, dealers or resellers ("ADR's") and (ii) located/operated in Canada.
- (4) Removal and reinstallation of product that is mounted in such a manner as to impede normal service is not covered under these warranties. This includes wall

mounts, custom cabinets and other installation methods that do not provide for direct and immediate access to the product for service purposes. Labour charges for set installation, setup, adjustment of customer controls, and installation or repair of antenna systems are not covered by these warranties. Reception problems caused by inadequate antenna systems are your responsibility.

- (5) Warranties extend only to material defects in materials or workmanship as limited above, and do not extend to:
- Service, repairs or replacement made necessary by accident, misuse, abuse, moisture, liquids, dust, dirt, neglect, accident, damage, 24/7 applications, improper installation, improper operation, improper cleaning, improper maintenance, normal wear and tear, screen burn or image retention caused by prolonged display of static images and/or phosphor aging, or any other external cause or event, act or omission outside the control of TCL, including fire, theft, acts of God, alteration, power failures, power surges or power shortages, lightning, other electrical faults, or repairs, modifications or replacements by persons other than those authorized by TCL to service the Television;
 - Replacement of missing, discarded or lost parts, the provision of retrofits, or preventive maintenance;
 - Repair of damage that is cosmetic only or does not affect the Television functionality, such as wear and tear, scratches and dents;
 - Service on Toshiba-branded accessory items (such accessory items may be covered by their own warranty);
 - Service on third party products or service made necessary by use of incompatible third party products;
 - Service made necessary by the simultaneous use of this Television and connected equipment;
 - Modifications to the Television not approved in writing by TCL, and service made necessary by the use or installation of non-Toshiba modifications to the Television;
 - Service of a Television on which the TOSHIBA label or logo, rating label or serial number have been defaced or removed;
 - Damage to the Television caused by failure to follow the specifications, User manuals or guides as to usage and/or storage.
 - Firmware updates that are posted to the Toshiba Support website and can be performed by the end user via a USB stick or SD card type media.

Disclaimer and Limitation of Remedy

TO THE EXTENT NOT PRECLUDED BY LAW, ALL OTHER EXPRESS AND IMPLIED WARRANTIES, CONDITIONS AND REPRESENTATIONS FOR THIS TELEVISION, INCLUDING THE IMPLIED WARRANTIES, CONDITIONS AND REPRESENTATIONS OF MERCHANTABILITY AND FITNESS FOR A PARTICULAR PURPOSE, ARE HEREBY DISCLAIMED AND EXCLUDED. IF THE APPLICABLE LAW, STATUTORY OR OTHERWISE, PRECLUDES THE EXCLUSION OF ANY

IMPLIED WARRANTIES, CONDITIONS AND REPRESENTATIONS THEN SUCH IMPLIED WARRANTIES, CONDITIONS AND REPRESENTATIONS ARE OTHERWISE LIMITED IN DURATION TO THE TERM OF THIS EXPRESS WRITTEN LIMITED WARRANTY. TO THE EXTENT NOT PRECLUDED BY LAW, STATUTORY OR OTHERWISE, THIS WRITTEN WARRANTY SUPERCEDES AND SPECIFICALLY DISCLAIMS ANY OTHER WARRANTY, CONDITION OR REPRESENTATION NOT STATED IN THIS WARRANTY, WHETHER MADE BY TCL, TOSHIBA CORPORATION, THEIR AFFILIATES, ADRs AND ASPs AND WHETHER MADE ORALLY OR IN WRITING (INCLUDING ANY STATEMENT IN ANY BROCHURE, PRESS RELEASE, ANNOUNCEMENT, ADVERTISEMENT, POINT OF SALE DISPLAY, ETC.).

YOU MUST READ AND FOLLOW ALL SET-UP AND USAGE INSTRUCTIONS IN THE APPLICABLE USER GUIDES AND/OR MANUALS. IF YOU FAIL TO DO SO, THIS TELEVISION MAY NOT FUNCTION PROPERLY AND YOU MAY SUFFER DAMAGE. THIS WARRANTY WILL NOT COVER ANY SERVICE THAT IS REQUIRED, IN PART OR IN WHOLE, AS A RESULT OF ANY FAILURE TO FOLLOW THE SET-UP AND USAGE INSTRUCTIONS. THIS WARRANTY DOES NOT APPLY AND SHALL BE VOID AND UNENFORCEABLE IF THE TELEVISION IS OPENED, SERVICED, OR REPAIRED BY PERSONS OTHER THAN THOSE AUTHORIZED BY TCL TO SERVICE OR REPAIR THE TELEVISION.

IF THE TELEVISION FAILS TO WORK AS WARRANTED ABOVE, YOUR SOLE AND EXCLUSIVE REMEDY SHALL BE REPAIR OR REPLACEMENT OF THE DEFECTIVE PART. IN NO EVENT WILL TCL, TOSHIBA CORPORATION, THEIR AFFILIATES, ADRs OR ASPs (THE "RELATED PARTIES") BE LIABLE TO YOU OR ANY THIRD PARTY FOR ANY DAMAGES, MONEY, REIMBURSEMENT, COSTS OR EXPENSES. THIS LIMITATION APPLIES TO DAMAGES, MONEY, REIMBURSEMENT, COSTS OR EXPENSES OF ANY KIND WHATSOEVER INCLUDING ANY DIRECT OR INDIRECT DAMAGES, DAMAGE TO PROPERTY OR PERSON, LOST PROFITS, LOST SAVINGS, INCONVENIENCE OR OTHER SPECIAL, INCIDENTAL, EXEMPLARY OR CONSEQUENTIAL DAMAGES, WHETHER FOR BREACH OF WARRANTY, BREACH OF CONTRACT, TORT (INCLUDING NEGLIGENCE), UNDER A STATUTE OR UNDER ANY OTHER LAW OR FORM OF ACTION, OR WHETHER ARISING OUT OF THE USE OF OR INABILITY TO USE THE TELEVISION, EVEN IF ANY OF THE RELATED PARTIES HAS BEEN ADVISED OF THE POSSIBILITY OF SUCH DAMAGES OR OF ANY CLAIM BY ANY OTHER PARTY.

No person, agent, distributor, dealer or company is authorized to change, modify or extend the terms of these warranties in any manner whatsoever.

Arbitration and Dispute Resolution

To the extent not precluded by law, any claim, dispute, controversy or disagreement (whether for breach of warranty, breach of contract, tort (including negligence), under a statute or under any other law or form of action) against any

of the Related Parties arising out of, or otherwise relating to: (i) this warranty; (ii) the Television; (iii) any oral or written representations, statements, brochures, press releases, advertising, announcement, point of sale display, or promotional material relating to the Television; (iv) the relationships that result from this warranty, (the foregoing claims, disputes controversies and disagreements are collectively referred to as the "Dispute"), shall be referred to and resolved by final and binding arbitration (to the exclusion of the courts). To the extent not precluded by law, you agree to waive any right that you may have to commence or participate in any representative or class proceeding against the Related Parties relating to any Dispute. If and where applicable and to the extent not precluded by law, you further agree to opt out of any such representative or class proceedings. Arbitration of any Dispute will be conducted in the forum and in the manner as agreed to between you and TCL. Failing such agreement, the arbitration will be conducted by one arbitrator pursuant to the laws and rules relating to arbitration generally in force in the jurisdiction in which you reside at the time that the Dispute arises. To the extent not precluded by law, no claim, dispute, controversy or disagreement of any other person may be joined or combined with any Dispute by you, without the prior written consent of TCL.

Critical Applications

The Television you have purchased is not designed for any "critical applications." "Critical applications" means life support systems, medical applications, connections to implanted medical devices, commercial transportation, nuclear facilities or systems or any other applications where Television failure could lead to injury to persons or loss of life or catastrophic property damage.

IF THE CUSTOMER USES THE TELEVISION IN ANY CRITICAL APPLICATION, THE CUSTOMER AND NOT TCL, ITS AFFILIATES, ADRs OR ASPs – ASSUME SOLE AND FULL RESPONSIBILITY FOR SUCH USE. TCL RESERVES THE RIGHT TO REFUSE TO SERVICE ANY TELEVISION USED IN A CRITICAL APPLICATION. TCL, ITS AFFILIATES, ADRs AND ASPs HEREBY DISCLAIM ANY AND ALL LIABILITY, DAMAGES AND CONSEQUENCES ARISING OUT OF THE SERVICE OR REFUSAL TO SERVICE SUCH TELEVISION AND FURTHER DISCLAIM ANY AND ALL LIABILITY, CONSEQUENCES AND DAMAGES THAT MAY ARISE OR RESULT FROM THE USE OF THE TELEVISION IN ANY CRITICAL APPLICATIONS.

General Provisions

If and to the extent that any provision of this limited warranty should generally be found to be unenforceable, the unenforceable provision shall be severed from the warranty and deemed not to form part of the warranty. The remaining provisions of this warranty shall be and remain valid and enforceable. If and to the extent that any provision of this limited warranty as it relates to any of the Related Parties is found to be invalid or unenforceable in respect of that party (the "Excluded Party"), the Excluded Party shall be deemed

to be severed or excluded from the provision, and the provision shall remain valid, enforceable and applicable in respect of the other or remaining Related Parties.

To the extent permitted by law, this limited warranty shall be governed and construed in accordance with the laws of Ontario.

If there is any inconsistency between this limited warranty, on the one hand, and any statement in the packaging of the Television or in any other document enclosed with, or used in the context of the promotion or sale of, the Television, on the other hand, the provisions of this limited warranty shall prevail.

How to Obtain Warranty Services

If, after following all of the operating instructions in this manual, checked the "Troubleshooting" section, and have visited www.toshiba.ca/support for additional information, you find that service is needed, please contact TCL Customer Support toll free at 1 800 268-3404.

For at least three (3) years from the date of distribution of the this product, Toshiba will give to anyone who contacts Toshiba Consumer Solutions at (800) 631-3811, for a charge of no more than our cost of physically performing source code distribution, a complete machine-readable copy of the complete corresponding GPL and LGPL source code for the version of the GPL and LGPL code that we distributed to you in this product.

GPL: Linux Kernel 2.6.20.19, busybox 1.4.2, pump-autoip 0.8.11.1

LGPL: glibc 2.5.1, gcc 4.1.2, avformat 52.31.0, avcodec 52.20.0, avutil 49.15.0

Portions of this software are copyright (C) <2007> The Free Type Project(www.freetype.org). All rights reserved.

This software is based in part on the work of the Independent JPEG group.

Copyright (C) 1996 - 2009, Daniel Stenberg, <daniel@haxx.se>. All rights reserved.

Permission to use, copy, modify, and distribute this software for any purpose with or without fee is hereby granted, provided that the above copyright notice and this permission notice appear in all copies.

THE SOFTWARE IS PROVIDED "AS IS", WITHOUT WARRANTY OF ANY KIND, EXPRESS OR IMPLIED, INCLUDING BUT NOT LIMITED TO THE WARRANTIES OF MERCHANTABILITY, FITNESS FOR A PARTICULAR PURPOSE AND NONINFRINGEMENT OF THIRD PARTY RIGHTS. IN NO EVENT SHALL THE AUTHORS OR COPYRIGHT HOLDERS BE LIABLE FOR ANY CLAIM, DAMAGES OR OTHER LIABILITY, WHETHER IN AN

ACTION OF CONTRACT, TORT OR OTHERWISE, ARISING FROM, OUT OF OR IN CONNECTION WITH THE SOFTWARE OR THE USE OR OTHER DEALINGS IN THE SOFTWARE.

Except as contained in this notice, the name of a copyright holder shall not be used in advertising or otherwise to promote the sale, use or other dealings in this Software without prior written authorization of the copyright holder.

Except where otherwise noted in the source code (e.g. the files hash.c, list.c and the trio files, which are covered by a similar license but with different Copyright notices) all the files are:

Copyright (C) 1998-2003 Daniel Veillard. All Rights Reserved.

Permission is hereby granted, free of charge, to any person obtaining a copy of this software and associated documentation files (the "Software"), to deal in the Software without restriction, including without limitation the rights to use, copy, modify, merge, publish, distribute, sublicense, and/or sell copies of the Software, and to permit persons to whom the Software is furnished to do so, subject to the following conditions:

The above copyright notice and this permission notice shall be included in all copies or substantial portions of the Software.

THE SOFTWARE IS PROVIDED "AS IS", WITHOUT WARRANTY OF ANY KIND, EXPRESS OR IMPLIED, INCLUDING BUT NOT LIMITED TO THE WARRANTIES OF MERCHANTABILITY, FITNESS FOR A PARTICULAR PURPOSE AND NONINFRINGEMENT. IN NO EVENT SHALL THE DANIEL VEILLARD BE LIABLE FOR ANY CLAIM, DAMAGES OR OTHER LIABILITY, WHETHER IN AN ACTION OF CONTRACT, TORT OR OTHERWISE, ARISING FROM, OUT OF OR IN CONNECTION WITH THE SOFTWARE OR THE USE OR OTHER DEALINGS IN THE SOFTWARE.

Except as contained in this notice, the name of Daniel Veillard shall not be used in advertising or otherwise to promote the sale, use or other dealings in this Software without prior written authorization from him.

* Copyright (C) 2000 Bjorn Reese and Daniel Veillard.

* Permission to use, copy, modify, and distribute this software for any purpose with or without fee is hereby granted, provided that the above copyright notice and this permission notice appear in all copies.

* THIS SOFTWARE IS PROVIDED ``AS IS" AND WITHOUT ANY EXPRESS OR IMPLIED WARRANTIES, INCLUDING, WITHOUT LIMITATION, THE IMPLIED WARRANTIES OF MERCHANTABILITY AND FITNESS FOR A PARTICULAR PURPOSE. THE AUTHORS AND CONTRIBUTORS ACCEPT NO RESPONSIBILITY IN

* ANY CONCEIVABLE MANNER.

* Copyright (C) 2000 Gary Pennington and Daniel Veillard.

* Permission to use, copy, modify, and distribute this software for any purpose with or without fee is hereby granted, provided that the above copyright notice and this permission notice appear in all copies.

* THIS SOFTWARE IS PROVIDED ``AS IS" AND WITHOUT ANY EXPRESS OR IMPLIED WARRANTIES, INCLUDING, WITHOUT LIMITATION, THE IMPLIED WARRANTIES OF MERCHANTABILITY AND FITNESS FOR A PARTICULAR PURPOSE. THE AUTHORS AND CONTRIBUTORS ACCEPT NO RESPONSIBILITY IN ANY CONCEIVABLE MANNER.

* Copyright (C) 2001 Bjorn Reese <breese@users.sourceforge.net>

* Permission to use, copy, modify, and distribute this software for any purpose with or without fee is hereby granted, provided that the above copyright notice and this permission notice appear in all copies.

* THIS SOFTWARE IS PROVIDED ``AS IS" AND WITHOUT ANY EXPRESS OR IMPLIED WARRANTIES, INCLUDING, WITHOUT LIMITATION, THE IMPLIED WARRANTIES OF MERCHANTABILITY AND FITNESS FOR A PARTICULAR PURPOSE. THE AUTHORS AND CONTRIBUTORS ACCEPT NO RESPONSIBILITY IN ANY CONCEIVABLE MANNER.

* Copyright (C) 2001 Bjorn Reese and Daniel Stenberg.

* Permission to use, copy, modify, and distribute this software for any purpose with or without fee is hereby granted, provided that the above copyright notice and this permission notice appear in all copies.

* THIS SOFTWARE IS PROVIDED ``AS IS" AND WITHOUT ANY EXPRESS OR IMPLIED WARRANTIES, INCLUDING, WITHOUT LIMITATION, THE IMPLIED WARRANTIES OF MERCHANTABILITY AND FITNESS FOR A PARTICULAR PURPOSE. THE AUTHORS AND CONTRIBUTORS ACCEPT NO RESPONSIBILITY IN ANY CONCEIVABLE MANNER.

* Copyright (C) 2003 Daniel Veillard.

* Permission to use, copy, modify, and distribute this software for any purpose with or without fee is hereby granted, provided that the above copyright notice and

* this permission notice appear in all copies.

*

* THIS SOFTWARE IS PROVIDED ``AS IS" AND WITHOUT
* ANY EXPRESS OR IMPLIED WARRANTIES,
* INCLUDING, WITHOUT LIMITATION, THE IMPLIED
* WARRANTIES OF MERCHANTABILITY AND FITNESS
* FOR A PARTICULAR PURPOSE. THE AUTHORS AND
* CONTRIBUTORS ACCEPT NO RESPONSIBILITY IN
* ANY CONCEIVABLE MANNER.

This product includes software developed by the
OpenSSL Project for use in the OpenSSL Toolkit (<http://www.openssl.org>).

This product includes cryptographic software written by
Eric Young (eay@cryptsoft.com).

OpenSSL 0.9.8 Copyright (C) 1998-2008 the OpenSSL
Project. All Rights reserved. Redistribution and use in
source and binary forms, with or without modification, are
permitted provided that the following conditions are met:

- (1) Redistributions of source code must retain the above
copyright notice, this list of conditions and the
following disclaimer.
- (2) Redistributions in binary form must reproduce the
above copyright notice, this list of conditions and the
following disclaimer in the documentation and/or
other materials provided with the distribution.
- (3) All advertising materials mentioning features or use of
this software must display the following
acknowledgement: This product includes software
developed by the OpenSSL Project for use in the
OpenSSL Toolkit (<http://openssl.org>).
- (4) The names "OpenSSL Toolkit" and "Open SSL
Project" must not be used to endorse or promote
products derived from this software without prior
written permission. For written permission, please
contact openssl-core@openssl.org.
- (5) Products derived from this software may not be called
"OpenSSL" nor may "Open SSL" appear in their
names without prior written permission of the
OpenSSL Project.
- (6) Redistributions of any form whatsoever must retain
the following acknowledgement: "This product
includes software developed by the OpenSSL Project
for use in the OpenSSL Toolkit (<http://www.openssl.org>)." "

THIS SOFTWARE IS PROVIDED BY THE OpenSSL
PROJECT "AS IS" AND ANY EXPRESSED OR IMPLIED
WARRANTIES, INCLUDING, BUT NOT LIMITED TO, THE
IMPLIED WARRANTIES OF MERCHANTABILITY AND
FITNESS FOR A PARTICULAR PURPOSE ARE
DISCLAIMED. IN NO EVENT SHALL THE OpenSSL
PROJECT OR CONTRIBUTORS BE LIABLE FOR ANY
DIRECT, INDIRECT, INCIDENTAL, SPECIAL,
EXEMPLARY, OR CONSEQUENTIAL DAMAGES
(INCLUDING, BUT NOT LIMITED TO, PROCUREMENT

OF SUBSTITUTE GOODS OR SERVICES; LOSS OF USE,
DATA, OR PROFITS; OR BUSINESS INTERRUPTION)
HOWEVER CAUSED AND ON ANY THEORY OF
LIABILITY, WHETHER IN CONTRACT, STRICT LIABILITY,
OR TORT (INCLUDING NEGLIGENCE OR OTHERWISE)
ARISING IN ANY WAY OUT OF THE USE OF THIS
SOFTWARE, EVEN IF ADVISED OF THE POSSIBILITY OF
SUCH DAMAGE.

This product includes cryptographic software written by
Eric Young (eay@cryptsoft.com). This product includes
software written by Tim Hudson (tjh@cryptsoft.com).

Copyright (C) 1995-1998 Eric Young
(eay@cryptsoft.com). All Rights reserved. This package is
an SSL implementation written by Eric Young
(eay@cryptsoft.com). The implementation was written so
as to conform with Netscapes SSL. This library is free for
commercial and noncommercial use so long as the
following conditions are adhered to. The following
conditions apply to all code found in this distribution, be it
the RC4, RSA, lhash, DES, etc., code; not just the SSL
code. The SSL documentation included with this
distribution is covered by the same copyright terms
except that the holder is Tim Hudson (tjh@cryptsoft.com).
Copyright remains Eric Young's, and as such any
Copyright notices in the code are not to be removed. If this
package is used in a product, Eric Young should be given
attribution as the author of the parts of the library used.
This can be in the form of a textual message at program
startup or in documentation (online or textual) provided
with the package. Redistribution and use in source and
binary forms, with or without modification, are permitted
provided that the following conditions are met:

- (1) Redistributions of source code must retain the
copyright notice, this list of conditions and the
following disclaimer.
- (2) Redistributions in binary form must reproduce the
above copyright notice, this list of conditions and the
following disclaimer in the documentation and/or
other materials provided with the distribution.
- (3) All advertising materials mentioning features or use of
this software must display the following
acknowledgement: "This product includes
cryptographic software written by Eric Young
(eay@cryptsoft.com)." The word 'cryptographic' can
be left out if the routines from the library being used
are not cryptographic related.
- (4) If you include any Windows specific code (or
derivative thereof) from the apps directory
(application code) you must include an
acknowledgement: "This product includes software
written by Tim Hudson (tjh@cryptsoft.com)."

THIS SOFTWARE IS PROVIDED BY ERIC YOUNG "AS IS"
AND ANY EXPRESS OR IMPLIED WARRANTIES,
INCLUDING, BUT NOT LIMITED TO, THE IMPLIED
WARRANTIES OF MERCHANTABILITY AND FITNESS
FOR A PARTICULAR PURPOSE ARE DISCLAIMED. IN

NO EVENT SHALL THE AUTHOR OR CONTRIBUTORS BE LIABLE FOR ANY DIRECT, INDIRECT, INCIDENTAL, SPECIAL, EXEMPLARY, OR CONSEQUENTIAL DAMAGES (INCLUDING, BUT NOT LIMITED TO, PROCUREMENT OF SUBSTITUTE GOODS OR SERVICES; LOSS OF USE, DATA, OR PROFITS; OR BUSINESS INTERRUPTION) HOWEVER CAUSED AND ON ANY THEORY OF LIABILITY, WHETHER IN CONTRACT, STRICT LIABILITY, OR TORT (INCLUDING NEGLIGENCE OR OTHERWISE) ARISING IN ANY WAY OUT OF THE USE OF THIS SOFTWARE, EVEN IF ADVISED OF THE POSSIBILITY OF SUCH DAMAGE.

The license and distribution terms for any publicly available version or derivative of this code cannot be changed, i.e. this code cannot simply be copied and put under another distribution license (including the GNU Public License).

License

This is a copy of the current LICENSE file inside the CVS repository.

LICENSE ISSUES

=====

The OpenSSL toolkit stays under a dual license, i.e. both the conditions of the OpenSSL License and the original SSLeay license apply to the toolkit. See below for the actual license texts. Actually both licenses are BSD-style Open Source licenses. In case of any license issues related to OpenSSL please contact openssl-core@openssl.org.

OpenSSL License

=====

Copyright (C) 1998-2008 The OpenSSL Project. All rights reserved.

Redistribution and use in source and binary forms, with or without modification, are permitted provided that the following conditions are met:

1. Redistributions of source code must retain the above copyright notice, this list of conditions and the following disclaimer.

2. Redistributions in binary form must reproduce the above copyright notice, this list of conditions and the following disclaimer in the documentation and/or other materials provided with the distribution.

3. All advertising materials mentioning features or use of this software must display the following acknowledgment: "This product includes software developed by the OpenSSL Project for use in the OpenSSL Toolkit. (<http://www.openssl.org/>)"

4. The names "OpenSSL Toolkit" and "OpenSSL Project" must not be used to endorse or promote products derived from this software without prior written permission. For written permission, please contact openssl-core@openssl.org.

5. Products derived from this software may not be called "OpenSSL" nor may "OpenSSL" appear in their names without prior written permission of the OpenSSL Project.

6. Redistributions of any form whatsoever must retain the following acknowledgment: "This product includes software developed by the OpenSSL Project for use in the OpenSSL Toolkit (<http://www.openssl.org/>)"

THIS SOFTWARE IS PROVIDED BY THE OpenSSL PROJECT "AS IS" AND ANY EXPRESSED OR IMPLIED WARRANTIES, INCLUDING, BUT NOT LIMITED TO, THE IMPLIED WARRANTIES OF MERCHANTABILITY AND FITNESS FOR A PARTICULAR PURPOSE ARE DISCLAIMED. IN NO EVENT SHALL THE OpenSSL PROJECT OR ITS CONTRIBUTORS BE LIABLE FOR ANY DIRECT, INDIRECT, INCIDENTAL, SPECIAL, EXEMPLARY, OR CONSEQUENTIAL DAMAGES (INCLUDING, BUT NOT LIMITED TO, PROCUREMENT OF SUBSTITUTE GOODS OR SERVICES; LOSS OF USE, DATA, OR PROFITS; OR BUSINESS INTERRUPTION) HOWEVER CAUSED AND ON ANY THEORY OF LIABILITY, WHETHER IN CONTRACT, STRICT LIABILITY, OR TORT (INCLUDING NEGLIGENCE OR OTHERWISE) ARISING IN ANY WAY OUT OF THE USE OF THIS SOFTWARE, EVEN IF ADVISED OF THE POSSIBILITY OF SUCH DAMAGE.

=====

This product includes cryptographic software written by Eric Young (eay@cryptsoft.com). This product includes software written by Tim Hudson (tjh@cryptsoft.com).

Original SSLeay License

Copyright (C) 1995-1998 Eric Young (eay@cryptsoft.com) All rights reserved.

This package is an SSL implementation written by Eric Young (eay@cryptsoft.com).

The implementation was written so as to conform with Netscapes SSL.

This library is free for commercial and non-commercial use as long as the following conditions are adhered to. The following conditions apply to all code found in this distribution, be it the RC4, RSA, lhash, DES, etc., code; not just the SSL code. The SSL documentation included with this distribution is covered by the same copyright terms except that the holder is Tim Hudson (tjh@cryptsoft.com).

Copyright remains Eric Young's, and as such any Copyright notices in the code are not to be removed. If this package is used in a product, Eric Young should be given attribution as the author of the parts of the library used. This can be in the form of a textual message at program startup or in documentation (online or textual) provided with the package.

Redistribution and use in source and binary forms, with or without modification, are permitted provided that the following conditions are met:

1. Redistributions of source code must retain the copyright notice, this list of conditions and the following disclaimer.

2. Redistributions in binary form must reproduce the above copyright notice, this list of conditions and the following disclaimer in the documentation and/or other materials provided with the distribution.

3. All advertising materials mentioning features or use of this software must display the following acknowledgement: "This product includes cryptographic software written by Eric Young (eay@cryptsoft.com)"

The word 'cryptographic' can be left out if the routines from the library being used are not cryptographic related :-).

4. If you include any Windows specific code (or a derivative thereof) from the apps directory (application code) you must include an acknowledgement: "This product includes software written by Tim Hudson (tjh@cryptsoft.com)"

THIS SOFTWARE IS PROVIDED BY ERIC YOUNG ``AS IS'' AND ANY EXPRESS OR IMPLIED WARRANTIES, INCLUDING, BUT NOT LIMITED TO, THE IMPLIED WARRANTIES OF MERCHANTABILITY AND FITNESS FOR A PARTICULAR PURPOSE ARE DISCLAIMED. IN NO EVENT SHALL THE AUTHOR OR CONTRIBUTORS BE LIABLE FOR ANY DIRECT, INDIRECT, INCIDENTAL, SPECIAL, EXEMPLARY, OR CONSEQUENTIAL DAMAGES (INCLUDING, BUT NOT LIMITED TO, PROCUREMENT OF SUBSTITUTE GOODS OR SERVICES; LOSS OF USE, DATA, OR PROFITS; OR BUSINESS INTERRUPTION) HOWEVER CAUSED AND ON ANY THEORY OF LIABILITY, WHETHER IN CONTRACT, STRICT LIABILITY, OR TORT (INCLUDING NEGLIGENCE OR OTHERWISE) ARISING IN ANY WAY OUT OF THE USE OF THIS SOFTWARE, EVEN IF ADVISED OF THE POSSIBILITY OF SUCH DAMAGE.

The license and distribution terms for any publically available version or derivative of this code cannot be changed. i.e. this code cannot simply be copied and put under another distribution license [including the GNU Public License.]

This software uses libraries from the FFmpeg project under the LGPLv2.1

Copyright (C) 2005, 2007 Olivier Gay
<olivier.gay@a3.epfl.ch> All rights reserved.

Redistribution and use in source and binary forms, with or without modification, are permitted provided that the following conditions are met:

1. Redistributions of source code must retain the above copyright notice, this list of conditions and the following disclaimer.

2. Redistributions in binary form must reproduce the above copyright notice, this list of conditions and the

following disclaimer in the documentation and/or other materials provided with the distribution.

3. Neither the name of the project nor the names of its contributors may be used to endorse or promote products derived from this software without specific prior written permission.

THIS SOFTWARE IS PROVIDED BY THE PROJECT AND CONTRIBUTORS ``AS IS'' AND ANY EXPRESS OR IMPLIED WARRANTIES, INCLUDING, BUT NOT LIMITED TO, THE IMPLIED WARRANTIES OF MERCHANTABILITY AND FITNESS FOR A PARTICULAR PURPOSE ARE DISCLAIMED.

IN NO EVENT SHALL THE PROJECT OR CONTRIBUTORS BE LIABLE FOR ANY DIRECT, INDIRECT, INCIDENTAL, SPECIAL, EXEMPLARY, OR CONSEQUENTIAL DAMAGES (INCLUDING, BUT NOT LIMITED TO, PROCUREMENT OF SUBSTITUTE GOODS OR SERVICES; LOSS OF USE, DATA, OR PROFITS; OR BUSINESS INTERRUPTION) HOWEVER CAUSED AND ON ANY THEORY OF LIABILITY, WHETHER IN CONTRACT, STRICT LIABILITY, OR TORT (INCLUDING NEGLIGENCE OR OTHERWISE) ARISING IN ANY WAY OUT OF THE USE OF THIS SOFTWARE, EVEN IF ADVISED OF THE POSSIBILITY OF SUCH DAMAGE.

License for Lua 5.0 and later versions

Copyright (C) 1994-2008 Lua.org, PUC-Rio.

Permission is hereby granted, free of charge, to any person obtaining a copy of this software and associated documentation files (the "Software"), to deal in the Software without restriction, including without limitation the rights to use, copy, modify, merge, publish, distribute, sublicense, and/or sell copies of the Software, and to permit persons to whom the Software is furnished to do so, subject to the following conditions:

The above copyright notice and this permission notice shall be included in all copies or substantial portions of the Software.

THE SOFTWARE IS PROVIDED "AS IS", WITHOUT WARRANTY OF ANY KIND, EXPRESS OR IMPLIED, INCLUDING BUT NOT LIMITED TO THE WARRANTIES OF MERCHANTABILITY, FITNESS FOR A PARTICULAR PURPOSE AND NONINFRINGEMENT. IN NO EVENT SHALL THE AUTHORS OR COPYRIGHT HOLDERS BE LIABLE FOR ANY CLAIM, DAMAGES OR OTHER LIABILITY, WHETHER IN AN ACTION OF CONTRACT, TORT OR OTHERWISE, ARISING FROM, OUT OF OR IN CONNECTION WITH THE SOFTWARE OR THE USE OR OTHER DEALINGS IN THE SOFTWARE.

This is a version (aka dmalloc) of malloc/free/realloc written by Doug Lea and released to the public domain. Use, modify, and redistribute this code without permission or acknowledgement in any way you wish. Send

questions, comments, complaints, performance data, etc to dl@cs.oswego.edu

* VERSION 2.7.2 Sat Aug 17 09:07:30 2002 Doug Lea (dl at gee)

Note: There may be an updated version of this malloc obtainable at

<ftp://gee.cs.oswego.edu/pub/misc/malloc.c>

Check before installing!

ICU License – ICU 1.8.1 and later

COPYRIGHT AND PERMISSION NOTICE

Copyright (C) 1995-2009 International Business Machines Corporation and others All rights reserved.

Permission is hereby granted, free of charge, to any person obtaining a copy of this software and associated documentation files (the "Software"), to deal in the Software without restriction, including without limitation the rights to use, copy, modify, merge, publish, distribute, and/or sell copies of the Software, and to permit persons to whom the Software is furnished to do so, provided that the above copyright notice(s) and this permission notice appear in all copies of the Software and that both the above copyright notice(s) and this permission notice appear in supporting documentation.

THE SOFTWARE IS PROVIDED "AS IS", WITHOUT WARRANTY OF ANY KIND, EXPRESS OR IMPLIED, INCLUDING BUT NOT LIMITED TO THE WARRANTIES OF MERCHANTABILITY, FITNESS FOR A PARTICULAR PURPOSE AND NONINFRINGEMENT OF THIRD PARTY RIGHTS. IN NO EVENT SHALL THE COPYRIGHT HOLDER OR HOLDERS INCLUDED IN THIS NOTICE BE LIABLE FOR ANY CLAIM, OR ANY SPECIAL INDIRECT OR CONSEQUENTIAL DAMAGES, OR ANY DAMAGES WHATSOEVER RESULTING FROM LOSS OF USE, DATA OR PROFITS, WHETHER IN AN ACTION OF CONTRACT, NEGLIGENCE OR OTHER TORTIOUS ACTION, ARISING OUT OF OR IN CONNECTION WITH THE USE OR PERFORMANCE OF THIS SOFTWARE.

Except as contained in this notice, the name of a copyright holder shall not be used in advertising or otherwise to promote the sale, use or other dealings in this Software without prior written authorization of the copyright holder.

Index

A			
Antenna input configuration	35	Location	37
Audio quality adjustments	62	M	
Auto Aspect	56	Manual Tuning	35
Auto Brightness Sensor.....	60	Media Player	75
Auto Tuning	35	Media Renderer Setup	70
AutoView.....	57	MPEG NR.....	59
B		MTS.....	62
Backlight.....	57	MUTE	62
Backlight Adjustment Pro.....	60	N	
Base Color Adjustment.....	60	Network Setup	65
Blue Screen	52	O	
C		On Timer	51
Channel Browser™	39	Optical audio output format.....	62
Channel lock.....	45	P	
Channel Return.....	41	Panel Lock	46
ClearFrame™	59	PC Audio	50
Closed Caption.....	42	PC connection	20
D		PC settings.....	50
DIGITAL AUDIO OUT.....	19	Picture mode.....	57
Digital CC Settings	42	Picture quality	57
DNR	59	Picture scroll	56
Dolby® Volume	63	Picture size selection	54
DVD player connection	15	PIN code	43
DVI connection	17	Power-On Mode.....	52
DynaLight™	58	R	
Dynamic Bass Boost	63	REGZA-LINK®	47
Dynamic Contrast	58	REGZA-LINK® connection	18
Dynamic Range Control	63	Remote control	24
E		Battery installation.....	23
Expert Mode	59	Device code table.....	29
F		Functional key chart	26
Film Stabilization	58	Programming	28
FREEZE	56	Reset Factory Defaults.....	53
G		Resolution+™	58
GameTimer®	46	RGB Range	49
H		S	
HDMI® audio mode	49	SAP	62
HDMI® connection.....	17	Satellite receiver connection	15
HDMI® settings feature.....	49	Sleep Timer	51
I		Static Gamma	58
Input Lock.....	45	Stereo sound.....	62
INSTAPORT™	49	Support information	53
IR OUT connection	16	SurfLock™	41
L		Surround	63
Labeling	36	T	
Language selection	34	TheaterLock™	61
Last mode memory.....	53	TheaterWide® picture size	54
LED indication	85	Time Zone	37
		TOSHIBA Illumination	52
		TV status information	53

TOSHIBA AMERICA CONSUMER PRODUCTS, L.L.C.

Corporate Headquarters: 82 TOTOWA ROAD, WAYNE, NJ 07470, U.S.A.
NATIONAL SERVICE DIVISION: 1420-B TOSHIBA DRIVE, LEBANON, TN 37087, U.S.A.

TOSHIBA OF CANADA LTD.

HEAD OFFICE: 191 McNABB STREET, MARKHAM, ONTARIO, L3R 8H2, CANADA – TEL: (905) 470-5400
SERVICE CENTERS:
TORONTO: 191 McNABB STREET, MARKHAM, ONTARIO L3R 8H2, CANADA – TEL: (905) 470- 5400

MANUFACTURED BY

TOSHIBA ELECTROMEX, S.A. DE C.V.

ColorStream, GameTimer and TheaterWide are registered trademarks of Toshiba America Consumer Products, L.L.C.
AutoView, Channel Browser, ClearFrame, DynaLight, ColorMaster, SurfLock and TheaterLock are trademarks of Toshiba America Consumer Products, L.L.C.
REGZA and REGZA-LINK are registered trademarks of Toshiba Corporation.
Resolution+ is a trademark of Toshiba Corporation.

Appearance of the pedestal stand depends on the respective models.
L'aspect du support de table dépend des modèles respectifs.
El aspecto de la base varía en cada modelo respectivo.



Two people are required for installation.
Il faut deux personnes pour effectuer l'installation.
Para la instalación se requieren 2 personas.

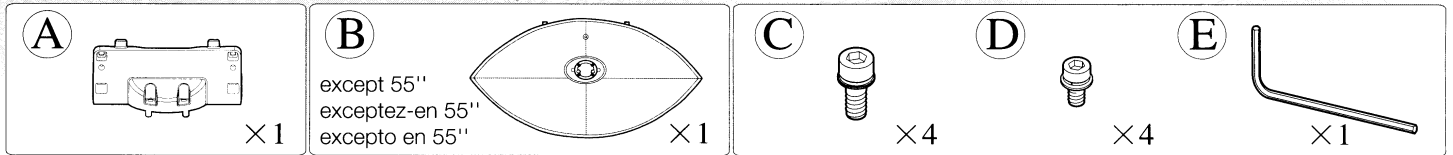

WARNING: To prevent possible electric shock, protect the power cord from being pinched when attaching the pedestal stand.

AVERTISSEMENT : Pour éviter tout risque de choc électrique, éviter que le cordon électrique soit coincé en fixant le socle.

ADVERTENCIA: Para evitar posibles descargas eléctricas, evite machucar el cable de alimentación cuando coloque el soporte del pedestal.

CAUTION: Before beginning pedestal assembly, carefully lay the front of the LCD Panel face down on a flat, cushioned surface such as a quilt or blanket. Leave the bottom of the unit protruding over the edge of the surface and assemble pedestal as indicated below.

ATTENTION : Avant de commencer l'assemblage du support de table, placer avec soin l'avant du panneau ACL, face vers le bas, sur une surface plane, matelassée, comme sur une courtepoinette ou une couverture. Laisser dépasser le bas de l'unité du rebord de la surface et monter le support de table tel qu'indiqué ci-dessous.

PRECAUCIÓN: Antes de comenzar a montar el pedestal, coloque con cuidado la parte delantera del panel LCD boca abajo en una superficie plana y acolchonada, como una sábana o una colcha. Deje la parte inferior de la unidad de manera que sobresalga de la superficie y monte el pedestal como se indica abajo.

Note: Extreme care should always be used when attaching the pedestal stand to avoid damage to the LCD panel.

Remarque : Toujours faire très attention quand vous attachez le support de table pour éviter d'endommager le panneau ACL.

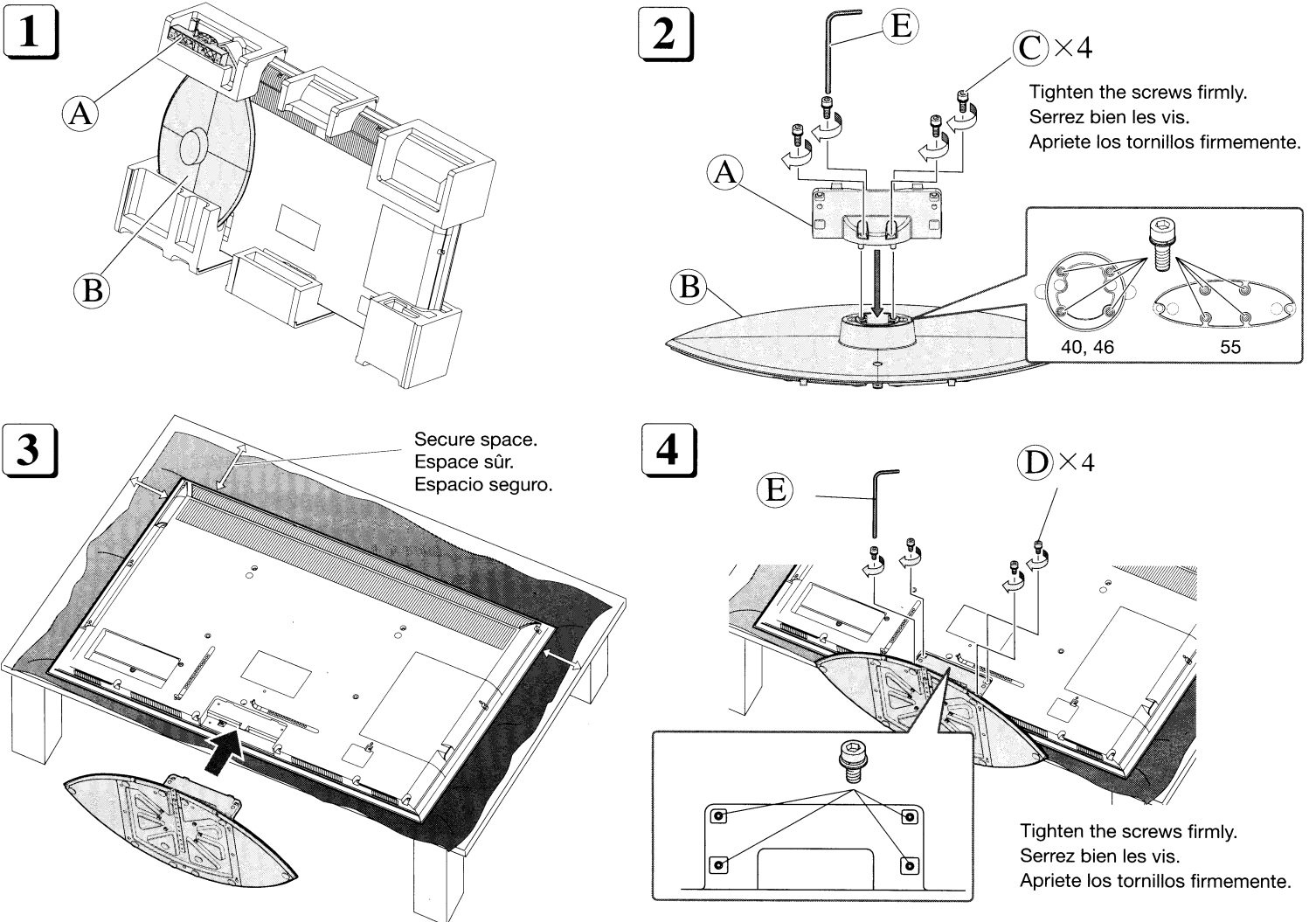

HDTV Quick Set-Up Guide (For US customers)

⚠ WARNING: The Owner's Manual contains important safety precautions not included in this Guide, please review completely prior to using this product.

Congratulations on the purchase of your new Toshiba High-Definition Television. You must have an HD Signal to watch an HD Picture!

Getting HDTV is easy as 1, 2, 3.

There are 3 basic ways to receive an HDTV Signal on your new High-Definition TV:

1 Over-The-Air (Antenna)



Connect a high quality outside antenna (not supplied) directly to the antenna input on the TV. (reception cannot be guaranteed and is based on proximity to the local signal)

Additional HDTV Antenna Reference Information can be obtained from www.antennaweb.org

2 Cable or Phone Company HDTV Service



Cable or Phone Company HDTV Service Customers will need to subscribe to High-Definition Service from your local provider. (Additional monthly subscription cost may apply)

Digital Cable or Digital Satellite is not HDTV. The picture quality is superior to standard analog cable, but it is not HDTV! See the difference HD Programming makes!

3 SATELLITE



Satellite Customers will need a High-Definition satellite receiver and appropriate dish hardware. (Additional monthly subscription cost may apply)

Once you have a High-Definition Signal you need to connect it to a High-Definition Input on your TV.

If you are connecting directly from an antenna or basic cable.



1 Antenna Input

To connect directly from an antenna or basic cable. Connect the cable directly to the antenna input on the back of the TV.

INPUT
TV



If you are using an HD Cable Box or HD Satellite Box, there are 3 standard connections that can be used to receive an HD signal.

2 HDMI® to HDMI®

HDMI® is the best connection for HDTV. This is a digital connection that carries both digital video and digital audio.

OUTPUT
Cable box / Satellite box

HDMI



INPUT
TV
HDMI



3 DVI to HDMI®

Your HD Cable Box or HD Satellite Receiver may have a DVI connection. This will be connected to the HDMI® jack on the TV using an HDMI® cable and an HDMI® to DVI converter. DVI carries digital video only. Therefore, this will require a separate analog audio connection as well. (use the red and white audio connections)

OUTPUT
Cable box / Satellite box

DVI



R AUDIO L

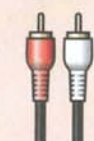

INPUT
TV
HDMI



AUDIO



4 Component Video Input

ColorStream® HD Component may also be used to receive HDTV. Use if no HDMI® or DVI Jack is available. There are 3 jacks color-coded with Red-Green-Blue on the back of the TV and HD Cable Box or HD Satellite Receiver. This connection will require a separate analog audio connection. (use the red and white audio connections)

OUTPUT
Cable box / Satellite box

AUDIO R L Y Pb Pr

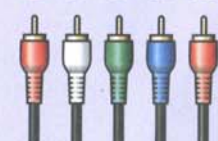

INPUT
TV

Y/VIDEO Pb Pr AUDIO L R

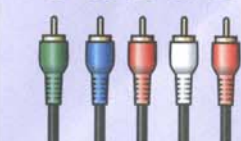

Now that you have HD Programming and are connected to an HD Input, Tune to an HD Channel (Remember not all channels are currently broadcast in HD) Sit back, relax and enjoy the superior quality of High-Definition.
Note: Standard analog TV channels and HD channels, even on the same network, broadcast on different channels. Example: ABC analog may be on channel 4, while ABC-HD may be on channel 104.

If you are experiencing problems please call Toshiba Customer Service at 1-800-631-3811

All cables and Adapters are sold separately.

For additional Toshiba Product Information visit www.tacp.com. Please remember to complete your product registration. Failure to register your product does not diminish your warranty rights.

TOSHIBA
Leading Innovation >>>

VX1A00155700



**Please Do The Following Before Returning
This Product To The Store.**

**Faites ce qui suit avant de retourner ce produit
au magasin.**

If you are experiencing a technical problem or have questions regarding operation, authorized service centers, warranty or parts, please contact our Customer Service Department at:

1-(800) 631-3811 (For US Customers)

1-(800) 268-3404 (For Canadian Customers)

Many questions regarding parts, service, and warranties can be answered by visiting the Customer Support Section of our website:

www.tacp.com (For US Customers)

www.toshiba.ca (For Canadian Customers)

THANK YOU

Si vous éprouvez des difficultés techniques ou si vous avez des questions concernant le fonctionnement du produit, les centres de service autorisés, la garantie ou les pièces, veuillez appeler notre département du service à la clientèle au:

1-(800) 631-3811 (États-Unis seulement)

1-(800) 268-3404 (Canada seulement)

Vous trouverez également des réponses à de nombreuses questions sur les pièces, le service et les garanties en visitant la section Soutien à la clientèle de notre site Web:

www.tacp.com (États-Unis seulement)

www.toshiba.ca (Canada seulement)

MERCI

****PLEASE SEE OPPOSITE SIDE OF THIS PAPER FOR QUICK SETUP DIRECTIONS**** ➔

How To Clean Your Cabinet

When cleaning your cabinet, please first remove any dirt or dust from the surface and then gently wipe with the enclosed cleaning cloth or other soft cloth. Harsh rubbing or use of a dirty cleaning cloth or stiff cloth will scratch the surface of the cabinet.

Comment nettoyer votre cabinet

Quand vous nettoyez votre cabinet, s'il vous plait, au début, enlevez toutes saletés ou poussières qui pourrait être sur la surface et puis doucement nettoyez avec le chiffon prévu a cet effet ou un autre chiffon lisse. Un rude coup de chiffon ou l'usage d'un chiffon sale ou rigide rayera la surface du cabinet.

Please send products and other correspondence to:

Toshiba America Consumer Products, L.L.C.
82 Totowa Road
Wayne, NJ 07470

First Class
Postage
Required
Post Office will
not deliver without
proper postage.

Toshiba America Consumer Products, L.L.C.
P.O. Box 3980
Peoria, IL 61612-3980

IMPORTANT!

TOSHIBA

Image is Everything™

PRODUCT REGISTRATION CARD

Complete and return this Product Registration Card within 10 days to receive valuable Toshiba information. Failure to complete and return this card does not diminish your warranty rights.

See details inside...

If you have comments or suggestions about our product, please write to:

Toshiba America Consumer Products, L.L.C. >> 82 Totowa Road >> Wayne, NJ 07470

Copyright © 2004 All Rights Reserved

Please seal with tape. Do not staple.

TOSHIBA'S CONSUMER INFORMATION PROGRAM

Congratulations for choosing Toshiba, a leader in developing tomorrow's technology today. Toshiba is committed to producing high-quality, reliable and innovative products. To uphold our commitment to excellence, we need to understand our customers' needs.

Please complete the following Product Registration Card. The information we are asking from you below will help us bring you new products specifically designed to meet your needs. By registering your product you will automatically be enrolled in our Consumer Information Program, which provides you with the following benefits:

1. **PRODUCT SAFETY NOTIFICATION:** Registering our product will allow us to contact you in the unlikely event a product safety notification is required.
2. **CONFIRMATION OF OWNERSHIP:** We will keep the model number, serial number, and other information on this card in our files for up to ten years. In the event of fire, flood or theft, your registration will serve as your proof of purchase for insurance purposes.
3. **WARRANTY SERVICE:** Filling out this card will help us contact you in case there is a problem with this product.

IMPORTANT: Please register your product within 10 days by mail or register online @ www.tacp.toshiba.com/register

1. Mr. Mrs. Ms. Miss Email address

First Name Initial Last Name

Street Apt. No.

City State Zip Code

Home telephone number Work telephone number 2. Date of Purchase

Area Code Area Code Month Day Year

IMPORTANT! To ensure your enrollment in Toshiba's Consumer Information Program, write the complete model number of the product you purchased in the space below.

3. Model Number 4. Serial Number

5. Price paid (excluding tax) \$.00

6. Have you purchased a service contract or extended warranty for this product?

1. Yes, from my retail dealer
2. No, but contract was offered by my retail dealer
3. No, contract was not offered

a. If you answered "yes" to 6, how long does your service contract or extended warranty last?

1. 1 Year
2. 2 Years
3. 3 Years
4. More than 3 Years

b. Would you like to obtain more information from Toshiba on extended warranties:

1. Yes
2. No

7. Where was this product purchased?

- | | |
|--|---|
| 01. <input type="checkbox"/> Received as a Gift | 07. <input type="checkbox"/> Catalog Showroom |
| 02. <input type="checkbox"/> Department Store | 08. <input type="checkbox"/> Rental Dealer |
| 03. <input type="checkbox"/> Discount Store | 09. <input type="checkbox"/> Mail Order |
| 04. <input type="checkbox"/> TV/Appliance Store | 10. <input type="checkbox"/> Premium Offer |
| 05. <input type="checkbox"/> Specialty/Electronics Store | 11. <input type="checkbox"/> Other |
| 06. <input type="checkbox"/> Warehouse/Membership Club | |

fold here

With #1 being the most important, prioritize the following:

1. Where do you get new product information?
 - newspaper
 - tech magazines
 - news broadcasts
 - on-line
 - product literature
 - retail salesperson
 - other
2. What resources do you use to make your purchase decision?
 - friends/family
 - on-line research
 - retail salesperson
 - product reviews
 - other
3. What do you look for when purchasing CE products:
 - style, cosmetics
 - picture quality
 - brand
 - quality
 - price
 - technology
 - reliability
4. Why did you choose this product?
 - brand image
 - quality
 - price
 - purchased other Toshiba products
 - technology
 - reliability
 - recommended by a friend/family
 - product reviews

Check all that apply

5. Which of the following products do you own?

Product	Manufacturer
<input type="checkbox"/> TV - projection TV	<input type="text"/>
<input type="checkbox"/> TV - tabletop	<input type="text"/>
<input type="checkbox"/> TV Combination	<input type="text"/>
<input type="checkbox"/> TV - flat panel/plasma	<input type="text"/>
<input type="checkbox"/> DVD player	<input type="text"/>
<input type="checkbox"/> Home Theater in a Box	<input type="text"/>
<input type="checkbox"/> TiVo®	<input type="text"/>
<input type="checkbox"/> Home Networking Server	<input type="text"/>
<input type="checkbox"/> Computer	<input type="text"/>
<input type="checkbox"/> Audio Player	<input type="text"/>
<input type="checkbox"/> Digital Camera	<input type="text"/>
<input type="checkbox"/> Digital Camcorder	<input type="text"/>
<input type="checkbox"/> Receiver	<input type="text"/>
<input type="checkbox"/> Speakers - stand alone	<input type="text"/>
<input type="checkbox"/> Other	<input type="text"/>

6. May we contact you?

- Yes No Email:

Thanks for taking the time to fill out this questionnaire. Your answers will be used for market research studies and reports.

- Please check here if, for some reason, you would prefer not to participate in the opportunity.

Free Manuals Download Website

<http://myh66.com>

<http://usermanuals.us>

<http://www.somanuals.com>

<http://www.4manuals.cc>

<http://www.manual-lib.com>

<http://www.404manual.com>

<http://www.luxmanual.com>

<http://aubethermostatmanual.com>

Golf course search by state

<http://golfingnear.com>

Email search by domain

<http://emailbydomain.com>

Auto manuals search

<http://auto.somanuals.com>

TV manuals search

<http://tv.somanuals.com>