

TOSHIBA

REGZA

Owner's Manual

Integrated High Definition LCD Television

COLORSTREAM® HD 

HDMI 

32RV530U

37RV530U

42RV530U

46RV530U

52RV530U

For an overview of steps for setting up your new TV, see page 9.

Note: To display a High Definition picture, the TV must be receiving a High Definition signal (such as an over-the-air High Definition TV broadcast, a High Definition digital cable program, or a High Definition digital satellite program). For details, please contact your TV antenna installer, cable provider, or satellite provider.

Owner's Record

The model number and serial number are on the back of your TV. Record these numbers in the spaces below. Refer to these numbers whenever you communicate with your Toshiba dealer about this TV.

Model number:

Serial number:

Dear Customer,

Thank you for purchasing this Toshiba LCD TV. This manual will help you use the many exciting features of your new LCD TV. **Before operating your LCD TV, please read this manual completely**, and keep it nearby for future reference.

Safety Precautions

WARNING: TO REDUCE THE RISK OF FIRE OR ELECTRIC SHOCK, DO NOT EXPOSE THIS APPLIANCE TO RAIN OR MOISTURE.



WARNING: TO REDUCE THE RISK OF ELECTRIC SHOCK, DO NOT REMOVE COVER (OR BACK). NO USER-SERVICEABLE PARTS INSIDE. REFER SERVICING TO QUALIFIED SERVICE PERSONNEL.



The lightning flash with arrowhead symbol, within an equilateral triangle, is intended to alert the user to the presence of uninsulated "dangerous voltage" within the product's enclosure that may be of sufficient magnitude to constitute a risk of electric shock to persons.



The exclamation point within an equilateral triangle is intended to alert the user to the presence of important operating and maintenance (servicing) instructions in the literature accompanying the appliance.

WARNING

To prevent injury, this apparatus must be securely attached to the floor/wall in accordance with the installation instructions. See item 20 on page 3 and instructions on page 5.

WARNING: If you decide to wall mount this television, always use a UL Listed wall bracket appropriate for the size and weight of this television. The use of any wall bracket other than a UL Listed wall bracket appropriate for the size and weight of this television for wall mounting this television could result in serious bodily injury and/or property damage. See "Removing the Pedestal Stand" (page 5).

NOTE TO CATV INSTALLERS

This is a reminder to call the CATV system installer's attention to Article 820-40 of the U.S. NEC, which provides guidelines for proper grounding and, in particular, specifies that the cable ground shall be connected to the grounding system of the building, as close to the point of cable entry as practical. For additional antenna grounding information, see items 27 and 28 on page 4.

CHILD SAFETY:

It Makes A Difference How and Where You Use Your Flat Panel Display

Congratulations on your purchase! As you enjoy your new product, please keep these safety tips in mind:

The Issue

- The home theater entertainment experience is a growing trend and larger flat panel displays are popular purchases. However, flat panel displays are not always supported on the proper stands or installed according to the manufacturer's recommendations.



- Flat panel displays that are inappropriately situated on dressers, bookcases, shelves, desks, speakers, chests or carts may fall over and cause injury.

TOSHIBA Cares!

- The consumer electronics industry is committed to making home entertainment enjoyable and safe.

Tune Into Safety

- One size does NOT fit all. Follow the manufacturer's recommendations for the safe installation and use of your flat panel display.
- Carefully read and understand all enclosed instructions for proper use of this product.
- Don't allow children to climb on or play with furniture and television sets.
- Don't place flat panel displays on furniture that can easily be used as steps, such as a chest of drawers.
- Remember that children can become excited while watching a program, especially on a "larger than life" flat panel display. Care should be taken to place or install the display where it cannot be pushed, pulled over, or knocked down.
- Care should be taken to route all cords and cables connected to the flat panel display so that they cannot be pulled or grabbed by curious children.

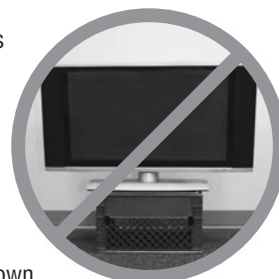

Wall Mounting: If you decide to wall mount your flat panel display, always:

- Use a mount that has been recommended by the display manufacturer and/or listed by an independent laboratory (such as UL, CSA, ETL).
- Follow all instructions supplied by the display and wall mount manufacturers.
- If you have any doubts about your ability to safely install your flat panel display, contact your retailer about professional installation.
- Make sure that the wall where you are mounting the display is appropriate. Some wall mounts are not designed to be mounted to walls with steel studs or old cinder block construction. If you are unsure, contact a professional installer.
- A minimum of two people are required for installation. Flat panel displays can be heavy.



www.CE.org/safety

Important Safety Instructions

- 1) **Read these instructions.**
- 2) **Keep these instructions.**
- 3) **Heed all warnings.**
- 4) **Follow all instructions.**



- 5) **Do not use this apparatus near water.**
- 6) **Clean only with dry cloth.**
- 7) **Do not block any ventilation openings.** Install in accordance with the manufacturer's instructions.
- 8) **Do not install near any heat sources** such as radiators, heat registers, stoves, or other apparatus (including amplifiers) that produce heat.

- 9) **Do not defeat the safety purpose of the polarized or grounding type plug.** A polarized plug has two blades with one wider than the other.

A grounding type plug has two blades and a third grounding prong. The wide blade or the third prong are provided for your safety. If the provided plug does not fit into your outlet, consult an electrician for replacement of the obsolete outlet.

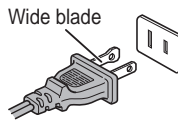

- 10) **Protect the power cord** from being walked on or pinched, particularly at plugs, convenience receptacles, and the point where they exit from the apparatus.

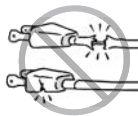

- 11) **Only use attachments/accessories specified by the manufacturer.**

- 12) **Use only with the cart, stand, tripod, bracket, or table specified by the manufacturer, or sold with the apparatus.** When a cart is used, use caution when moving the cart/apparatus combination to avoid injury from tip-over.



- 13) **Unplug this apparatus during lightning storms or when unused for long periods of time.**

- 14) **Refer all servicing to qualified service personnel.** Servicing is required when the apparatus has been damaged in any way, such as power-supply cord or plug is damaged, liquid has been spilled or objects have fallen into the apparatus, the apparatus has been exposed to rain or moisture, does not operate normally, or has been dropped.

Additional Safety Precautions

- 14a) **CAUTION:** If the TV is dropped and the cabinet or enclosure surface has been damaged or the TV does not operate normally, take the following precautions:
 - ALWAYS turn off the TV and unplug the power cord to avoid possible electric shock or fire.
 - NEVER allow your body to come in contact with any broken glass or liquid from the damaged television. The LCD panel inside the TV contains glass and a toxic liquid. If the liquid comes in contact with your mouth or eyes, or your skin is cut by broken glass, rinse the affected area thoroughly with water and consult your doctor.
 - ALWAYS contact a service technician to inspect the TV any time it has been damaged or dropped.

- 15) **CAUTION:**

- To reduce the risk of electric shock, do not use the polarized plug with an extension cord, receptacle, or other outlet unless the blades can be inserted completely to prevent blade exposure.
- To prevent electric shock, match wide blade of plug to wide slot; fully insert.

- 16) **WARNING:**

To prevent the spread of fire, keep candles or other open flames away from this product at all times.

Installation, Care, and Service

Installation

Follow these recommendations and precautions and heed all warnings when installing your TV:

- 17) Never modify this equipment. Changes or modifications may void: a) the warranty, and b) the user's authority to operate this equipment under the rules of the Federal Communications Commission.

- 18) **DANGER: RISK OF SERIOUS PERSONAL INJURY, DEATH, OR EQUIPMENT DAMAGE!**

Never place the TV on an unstable cart, stand, or table. The TV may fall, causing serious personal injury, death, or serious damage to the TV.



- 19) To avoid damage to this product, never place or store the TV in direct sunlight; hot, humid areas; or areas subject to excessive dust or vibration.

- 20) Always place the TV on the floor or a sturdy, level, stable surface that can support the weight of the unit. To secure the TV, use a sturdy strap from the hooks on the rear of the TV pedestal to a wall stud, pillar, or other immovable structure. Make sure the strap is tight, secure, and parallel to the floor.

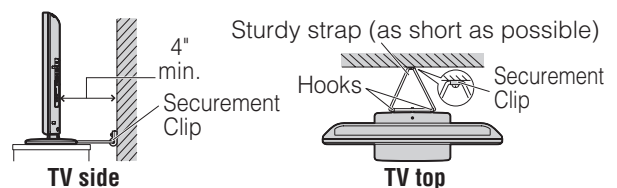

- 21) The apparatus shall not be exposed to dripping or splashing and that no objects filled with liquids, such as vases, shall be placed on the apparatus.

- 22) Never block or cover the slots or openings in the TV cabinet back, bottom, and sides. Never place the TV:

- on a bed, sofa, rug, or similar surface;
- too close to drapes, curtains, or walls; or
- in a confined space such as a bookcase, built-in cabinet, or any other place with poor ventilation.

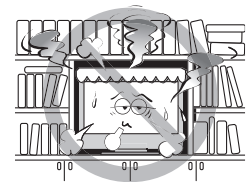

The slots and openings are provided to protect the TV from overheating and to help maintain reliable operation of the TV. Leave a space of at least 4 (four) inches around the TV.

(continued)

- 23) Always place the back of the television at least four (4) inches away from any vertical surface (such as a wall) to allow proper ventilation.
- 24) Never allow anything to rest on or roll over the power cord, and never place the TV where the power cord is subject to wear or abuse.
- 25) Never overload wall outlets and extension cords.
- 26) Always operate this equipment from a 120 VAC, 60 Hz power source only.
- 27) Always make sure the antenna system is properly grounded to provide adequate protection against voltage surges and built-up static charges (see Section 810 of the National Electric Code).

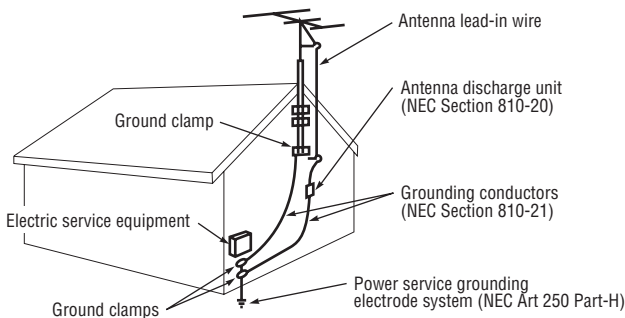

28)  **DANGER: RISK OF SERIOUS PERSONAL INJURY OR DEATH!**



- Use extreme care to make sure you are never in a position where your body (or any item you are in contact with, such as a ladder or screwdriver) can accidentally touch overhead power lines. Never locate the antenna near overhead power lines or other electrical circuits.
- Never attempt to install any of the following during lightning activity: a) an antenna system; or b) cables, wires, or any home theater component connected to an antenna or phone system.

Care

For better performance and safer operation of your TOSHIBA TV, follow these recommendations and precautions:

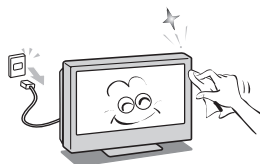
- 29) If you use the TV in a room whose temperature is 32 °F (0 °C) or below, the picture brightness may vary until the LCD warms up. This is not a sign of malfunction.
- 30) Always unplug the TV before cleaning. Gently wipe the display panel surface (the TV screen) using a dry, soft cloth only (cotton, flannel, etc.). A hard cloth may damage the surface of the panel. Avoid contact with alcohol, thinner, benzene, acidic or alkaline solvent cleaners, abrasive cleaners, or chemical cloths, which may damage the surface. Never spray volatile compounds such as insecticide on the cabinet. Such products may damage or discolor the cabinet.



- 31)  **WARNING: RISK OF ELECTRIC SHOCK!** 
Never spill liquids or push objects of any kind into the TV cabinet slots.



- 32) While it is thundering, do not touch the connecting cables or apparatus.
- 33) For added protection of your TV from lightning and power surges, always unplug the power cord and disconnect the antenna from the TV if you leave the TV unattended or unused for long periods of time.
- 34) During normal use, the TV may make occasional snapping or popping sounds. This is normal, especially when the unit is being turned on or off. If these sounds become frequent or continuous, unplug the power cord and contact a Toshiba Authorized Service Center.

- 35)  **WARNING: RISK OF SERIOUS PERSONAL INJURY OR EQUIPMENT DAMAGE!**
Never strike the screen with a sharp or heavy object.



- 36) • The LCD screen of this product can be damaged by ultraviolet radiation from the sun. When selecting a location for the television, avoid locations where the screen may be exposed to direct sunlight, such as in front of a window.
- Never touch, press, or place anything on the LCD screen. These actions will damage the LCD screen. If you need to clean the LCD screen, follow the instructions in item 30 on this page.

Service

- 37)  **WARNING: RISK OF ELECTRIC SHOCK!** 
Never attempt to service the TV yourself. Opening and removing the covers may expose you to dangerous voltage or other hazards. Failure to follow this WARNING may result in death or serious injury. Refer all servicing not specified in this manual to a Toshiba Authorized Service Center.

- 38) If you have the TV serviced:
- Ask the service technician to use only replacement parts specified by the manufacturer.
 - Upon completion of service, ask the service technician to perform routine safety checks to determine that the TV is in safe operating condition.
- 39) The cold cathode fluorescent lamp in the LCD panel contains a small amount of mercury.
- When the TV reaches the end of its useful life, dispose of the used TV by the approved method for your area, or ask a qualified service technician to properly dispose of the TV.

 **Note:** The lamp(s) inside this product contain mercury. Disposal may be regulated due to environmental considerations. For disposal or recycling information, contact your local authorities or the Electronics Industries Alliance (www.eiae.org).

Choosing a location for your LCD TV

To Display your LCD TV on the included Pedestal Stand:

Observe the following safety precautions:

- 1) Read and Follow the pedestal assembly instructions included with the pedestal.

CAUTION: Before beginning pedestal assembly, carefully lay the front of the LCD Panel face down on a flat, cushioned surface such as a quilt or blanket. Leave the bottom of the unit protruding over the edge of the surface and assemble the pedestal as indicated below.

Note: Extreme care should always be used when attaching the pedestal stand to avoid damage to the LCD panel.

- 2) Place the TV on a sturdy, level surface that can support the weight of the TV.
- 3) Be sure to secure the TV to a wall stud, pillar, surface, or other immovable structure. To secure the TV in this manner: (1) attach the provided securement clip to an immovable structure, then (2) pass a sturdy strap through the securement clip and attach each end to the hooks located on the back of the TV. Be sure to leave at least 4 inches between the TV and the wall or similar structure for ventilation. See item 20, page 3 for additional details.

To Display your LCD TV using a Wall Bracket:

If you decide to wall mount your LCD TV, always use a UL-listed wall bracket appropriate for the size and weight of the LCD TV (see page 2) :

- 1) **CAUTION:** Two people are required for installation.
- 2) Unplug and remove any cables and/or other component connectors from the rear of the TV.
- 3) Follow the instructions provided with your wall bracket. Before proceeding, make sure the appropriate bracket(s) are attached to the wall and the back of the TV as described in the instructions provided with the wall bracket.
- 4) After attaching the appropriate bracket(s) to the wall and the back of the TV, remove the pedestal stand from the TV as described below.

Removing the Pedestal Stand

- 1) Carefully lay the front of the unit face down on a flat, cushioned surface such as a quilt or blanket. Leave the stand protruding over the edge of the surface.

Note: Extreme care should always be used when removing the pedestal stand to avoid damage to the LCD panel.

- 2) Remove the jack pack cover on the back of the TV to expose the pedestal stand screws. The jack pack cover can be removed without tools.
- 3) Remove the four screws shown in the diagram below. This will allow removal of the pedestal stand.
- 4) Once you have removed all four screws holding the pedestal stand in place, remove the pedestal stand from the TV by sliding the pedestal stand away from the TV.

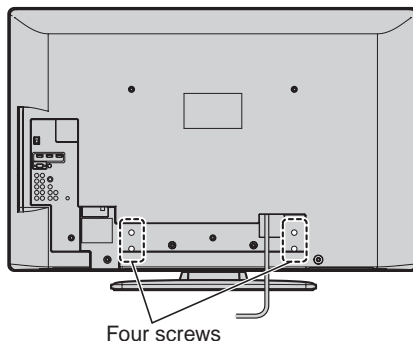

FCC Declaration of Conformity Compliance Statement (Part 15):

The **Toshiba 32RV530U, 37RV530U, 42RV530U, 46RV530U, and 52RV530U Televisions** comply with Part 15 of the FCC rules.

Operation is subject to the following two conditions: (1) this device may not cause harmful interference, and (2) this device must accept any interference received, including interference that may cause undesired operation.

The party responsible for compliance to these rules is:

Toshiba America Consumer Products, L.L.C.

82 Totowa Rd. Wayne, NJ 07470.

Ph: 1-800-631-3811

Note: *This equipment has been tested and found to comply with the limits for a Class B digital device, pursuant to Part 15 of the FCC rules. These limits are designed to provide reasonable protection against harmful interference in a residential installation. This equipment generates, uses, and can radiate radio frequency energy and, if not installed and used in accordance with the instructions, may cause harmful interference to radio communications. However, there is no guarantee that interference will not occur in a particular installation. If this equipment does cause harmful interference to radio or television reception, which can be determined by removing and applying power to the equipment, the user is encouraged to try to correct the interference by one or more of the following measures:*

- Reorient or relocate the receiving antenna.
- Increase the separation between the equipment and the receiver.
- Connect the equipment into an outlet on a circuit different from that to which the receiver is connected.
- Consult the dealer or an experienced radio/TV technician for help.

Caution: *Changes or modifications to this equipment not expressly approved by Toshiba could void the user's authority to operate this equipment.*

Important notes about your LCD TV

The following symptoms are technical limitations of LCD Display technology and are not an indication of malfunction; therefore, Toshiba is not responsible for perceived issues resulting from these symptoms.

- 1) An afterimage (ghost) may appear on the screen if a fixed, non-moving image is displayed for a long period of time. The afterimage is not permanent and will disappear in a short period of time.
- 2) The LCD panel contained in this TV is manufactured using an extremely high level of precision technology; however, there may be an occasional pixel (dot of light) that does not operate properly (does not light, remains constantly lit, etc.). This is a structural property of LCD technology, is not a sign of malfunction, and is not covered under your warranty. Such pixels are not visible when the picture is viewed from a normal viewing distance.

Note: *Interactive video games that involve shooting a "gun" type of joystick at an on-screen target may not work with this TV.*

Trademark Information

- Manufactured under license from Dolby Laboratories. Dolby and the double-D symbol are registered trademarks of Dolby Laboratories.
- HDMI, the HDMI logo and High-Definition Multimedia Interface are trademarks or registered trademarks of HDMI Licensing LLC.
- Deep Color is trademark of HDMI Licensing LLC. (Only available for 46" and 52" models)

Contents

Important Safety Instructions	3
Installation, Care, and Service	3
Chapter 1: Introduction	9
Features of your new TV	9
Overview of steps for installing, setting up, and using your new TV	9
TV front and side panel controls and connections	10
TV back panel connections	11
Chapter 2: Connecting your TV	12
Overview of cable types	12
About the connection illustrations	12
Connecting a VCR (or a VCR with S-video) and antenna, Cable TV or Camcorder	13
Connecting a DVD player with ColorStream® (component video), a VCR, and a satellite receiver	14
Connecting a device to the IR OUT infrared terminal using the IR blaster cable for IR pass-through device control	15
Connecting an HDMI™ or DVI device to the HDMI input	16
REGZA-LINK connection	17
Connecting a digital audio system	18
Connecting an audio system	18
Connecting a personal computer (PC)	19
Chapter 3: Using the remote control	20
Preparing the remote control for use	20
Installing the remote control batteries	20
Learning about the remote control	21
Using the remote control to control your other devices	22
Remote Control functional key chart	23
Programming the remote control to control your other devices	24
Remote control codes	25
Chapter 4: Menu layout and navigation	27
Main menu layout	27
Setup/Installation menu layout	27
Navigating the menu system	28
Chapter 5: Setting up your TV	29
Selecting the menu language	29
Configuring the antenna input source for the ANT/CABLE terminal	29
Programming channels into the TV's channel memory	30
Programming channels automatically	30
Manually adding and deleting channels in the channel memory	30
Labeling channels	31
Setting the HDMI™ audio mode	32
Viewing the digital signal meter	33
Setting the time zone	33
Viewing the system status	34
Selecting the Power-On Mode	34
Chapter 6: Using the TV's features	35
Selecting the video input source to view	35
Labeling the video input sources	35
Tuning channels	36
Tuning channels using the Channel Browser™	36
Setting the Channel Tuning Mode	38
Tuning to the next programmed channel	38
Tuning to a specific channel (programmed or unprogrammed)	38
Switching between two channels using Channel Return	39
Switching between two channels using SurfLock™	39
Selecting the picture size	39
Scrolling the TheaterWide® picture (TheaterWide 2 and 3 only)	41
Using the auto aspect ratio feature	41
Selecting the cinema mode (480i and 1080i signals)	42
Using the FREEZE feature	42
Adjusting the picture	42
Selecting the picture mode	42
Adjusting the picture quality	42
Using the TheaterLock™ feature	43
Using the closed caption mode	43
Base closed captions	43
Digital CC Settings	43
CC Selector	44
Adjusting the audio	44
Muting the sound	44
Using the digital audio selector	44
Selecting stereo/SAP broadcasts	45
Adjusting the audio quality	45
Using the StableSound® feature	45
Selecting the optical audio output format	46
Using the Dolby® Digital Dynamic Range Control feature	46
Using the Locks menu	46
Entering the PIN code	46
If you cannot remember your PIN code	46
Changing your PIN code	47
Blocking TV programs and movies by rating (V-Chip)	47
Downloading an additional rating system for blocking TV programs and movies	47
Blocking channels	48
Unlocking programs temporarily	48
Using the input lock feature	49
Using the GameTimer®	49
Using the control panel lock feature	49
Using the PC settings feature	50
Setting the PC Audio	50
Setting the sleep timer	51
Using REGZA-LINK	51
REGZA-LINK playback device (HD DVD player, etc.) control	51
REGZA-LINK input source selection	52
VOLUME and MUTE controls of Audio Receiver	52
Other REGZA-LINK functions	52
Using the HDMI settings feature	53
Displaying TV status information	54
Understanding the auto power off feature	54
Understanding the last mode memory feature	54

(continued)

Chapter 7: Using the TV's advanced features	55
Using the advanced picture settings features	55
Using dynamic contrast	55
Using the static gamma feature	55
Selecting the color temperature	56
Using CableClear® digital noise reduction	56
Using MPEG noise reduction.	56
Using the ColorMaster™ feature	57
Using the Game Mode feature	57
Using the advanced audio settings features	58
Using the surround sound features	58
Chapter 8: Troubleshooting	59
General troubleshooting	59
LED indications	61
Chapter 9: Appendix	62
Specifications	62
Acceptable signal formats	
for PC IN and HDMI terminals	63
Limited United States Warranty	
for LCD Televisions 26" and Larger	64
Limited Canadian Warranty	
for Toshiba Brand Flat Panel Televisions	65
Index	68

Features of your new TV

The following are just a few of the many exciting features of your new Toshiba widescreen, integrated HD, LCD TV:

- **Integrated digital tuning (8VSB ATSC and QAM)** eliminates the need for a separate digital converter set-top box (in most cases).
- **1080p output resolution.**
- **Four HDMI™** digital, high-definition multimedia interfaces with 1080p input support (🔗 page 16).
- **HDMI capabilities**
 - Lip-Sync Latency** feature activates an auto audio/video display timing adjustment function that allows HDMI source devices to accurately perform synchronization automatically.
 - Deep Color** feature allows the HDMI source to increase the available colors bits within the boundaries defined by the RGB or YCbCr color space. (Only supported on 46" and 52" models)
- **REGZA-LINK** allows control of external devices from the TV remote via HDMI connection (🔗 page 51).
- **Two sets of ColorStream® HD** high-resolution component video inputs (🔗 page 14).
- **Digital Audio Out** optical audio connection with Dolby® Digital optical output format (🔗 page 46).
- **CableClear®** digital picture noise reduction (🔗 page 56).
- **PC IN (Analog RGB)** computer terminal (🔗 page 19).
- **Channel Labeling** allows you to put the Call Letters (e.g. ABC, HBO, etc.) on the screen along with the station numbers, so you always know what you're watching (🔗 page 31).
- **IR OUT** infrared terminal using the IR blaster cable for IR pass-through device control (🔗 pages 12 and 15).
- **ColorMaster™** allows you to adjust the TV's standard colors. The menu for this feature has a unique "black" design to enhance contrast while you're adjusting the color (🔗 page 57).

Overview of steps for installing, setting up, and using your new TV

Follow these steps to set up your TV and begin using its many exciting features.

- 1** Observe the following when choosing a location for the TV:
 - Read "Important notes about your LCD TV" (🔗 page 6).
 - Place the TV in a proper location (🔗 pages 2–5)
- 2** Do not plug in any power cords until AFTER you have connected all cables and devices to your TV.
- 3** BEFORE connecting cables or devices to the TV, learn the functions of the TV's connections and controls (🔗 pages 10–11).
- 4** Connect your other electronic device(s) to the TV (🔗 pages 12–19).
- 5** See "Chapter 3: Using the remote control" (🔗 page 20) for an overview of the buttons on the remote control, install the batteries and prepare to operate your other device(s).
- 6** AFTER connecting all cables and devices, plug in the power cords for your TV and other devices.
- 7** See "Menu layout and navigation" for a quick overview of navigating the TV's menu system (🔗 page 27).
- 8** Program channels into the TV's channel memory (🔗 page 30).
- 9** For details on using the TV's features, see Chapters 6 and 7.
- 10** For help, refer to the Troubleshooting Guide, see Chapter 8.
- 11** For technical specifications and warranty information, see Chapter 9.

TV front and side panel controls and connections

Model 42RV530U is used in this manual for illustration purposes.

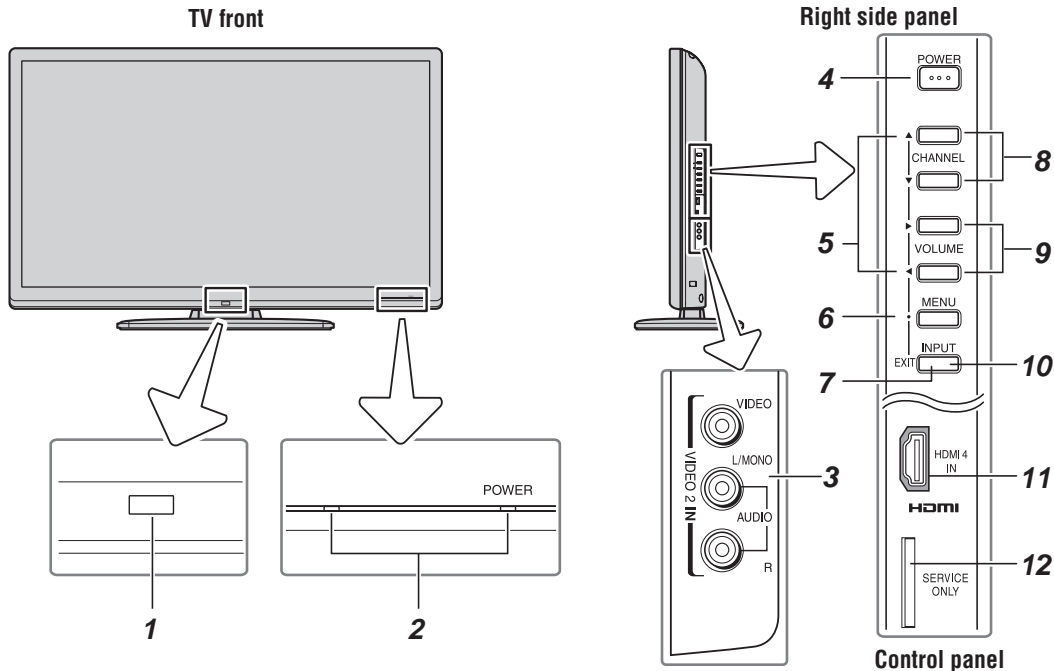

- 1 Remote sensor** — Point the remote control toward this remote sensor.

Effective range:

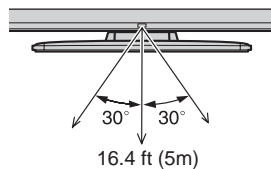

- 2 Green and Yellow LEDs**

Green = Power indicator

Yellow = Power-On Mode indicator (see “Selecting the Power-On Mode” on page 34)

See “LED indications” on page 61 for additional information.

- 3 VIDEO 2 IN** — The side panel A/V connections are referred to as “VIDEO 2” and include standard A/V connections.

- 4 POWER** — Press to turn the TV on and off.

If the TV stops responding to the controls on the remote control or TV control panel and you cannot turn off the TV, press and hold the **POWER** button on the TV control panel for 5 or more seconds to reset the TV.

- 5 ARROWS ▲▼◀▶** — When a menu is on-screen, these buttons function as up/down/left/right menu navigation buttons.

- 6 MENU (ENTER)** — Press to access the menu system (see page 27). When a menu is on-screen, the **MENU** button on the TV’s control panel functions as the **ENTER** button.

- 7 EXIT** — Press to instantly close an on-screen menu.

- 8 CHANNEL ▲▼** — When no menu is on-screen, these buttons change the channel (programmed channels only; see page 30).

- 9 VOLUME ◀▶** — These buttons adjust the volume level.

- 10 INPUT** — Repeatedly press to change the source you are viewing (**ANT/CABLE, VIDEO 1, VIDEO 2, ColorStream HD1, ColorStream HD2, HDMI 1, HDMI 2, HDMI 3, HDMI 4, PC**).

- 11 HDMI™ IN** — High-Definition Multimedia Interface (HDMI 4) input receives digital audio and uncompressed digital video from an HDMI device or uncompressed digital video from a DVI device. HDMI connection is necessary to receive 1080p signals.

- 12 Service port** — For service use only. Used for updating the television’s firmware.

TV back panel connections

For an explanation of cable types and connections, see pages 12–19.

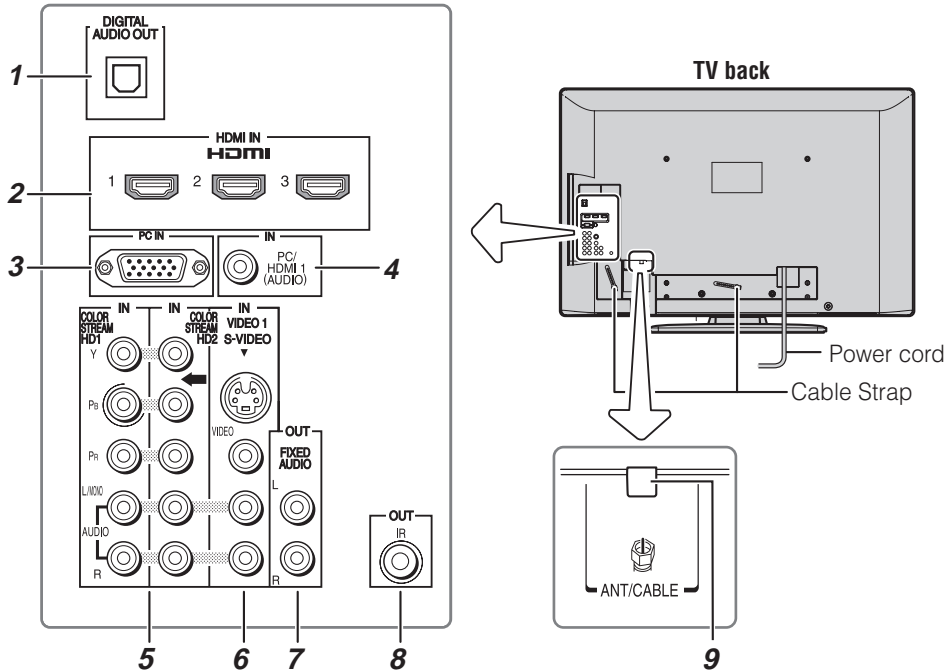

- 1 DIGITAL AUDIO OUT** — Optical audio output in Dolby Digital or PCM (pulse-code modulation) format for connecting an external Dolby Digital decoder, amplifier, A/V receiver, or home theater system with optical audio input.
- 2 HDMI™ IN** — High-Definition Multimedia Interface input receives digital audio and uncompressed digital video from an HDMI device or uncompressed digital video from a DVI device. Also see item 4. HDMI connection is necessary to receive 1080p signals.
- 3 PC IN** — For use when connecting a personal computer.
- 4 PC/HDMI 1 (AUDIO) IN** — PC audio input terminal is shared with HDMI 1 analog audio input terminal, and its use can be configured in the **Audio Setup** menu (page 50).
- 5 ColorStream® HD1 and ColorStream® HD2** — Two sets of ColorStream® high-definition component video inputs (with standard stereo audio inputs) for connecting devices with component video output, such as a Toshiba DVD player with ColorStream®.

Note: Component video cables carry only video information; separate audio cables are required for a complete connection.

- 6 VIDEO 1 IN** — Standard (composite) video and standard audio inputs plus optional S-video inputs for connecting devices with composite video or S-video output.
Note: Standard (composite) video and S-video cables carry only video information; separate audio cables are required for a complete connection.
- 7 Fixed Audio OUT** — Analog audio outputs for connecting an audio amplifier.
- 8 IR OUT** — For controlling infrared remote-controlled devices through the TV. You can connect up to two devices with an optical IR blaster cable (page 12), and then control the devices using the TV's IR pass-through features.
- 9 ANT/CABLE** — Antenna input that supports analog (NTSC) and digital (ATSC) off-air antenna signals and analog and digital Cable TV (QAM) signals.

HDMI, the HDMI logo and High-Definition Multimedia Interface are trademarks or registered trademarks of HDMI Licensing LLC. Manufactured under license from Dolby Laboratories. Dolby and the double-D symbol are registered trademarks of Dolby Laboratories.

Chapter 2: Connecting your TV

Overview of cable types

Cables can be purchased from most stores that sell audio/video devices. Before purchasing any cables, be sure of connector types required by your devices and the length of each cable.

Coaxial (F-type) cable



Coaxial (F-type) cable is used for connecting your antenna, cable TV service, and/or cable converter box to the **ANT/CABLE** input on your TV.

Standard A/V cables (red/white/yellow)

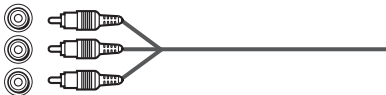

Standard A/V cables (composite video) usually come in sets of three, and are for use with video devices with analog audio and composite video output. These cables (and the related inputs on your TV) are typically color-coded according to use: yellow for video, red for stereo right audio, and white for stereo left (or mono) audio.

S-video cable



S-video cable is for use with video devices with S-video output. Separate audio cables are required for a complete connection.

Note: An S-video cable provides better picture performance than a composite video cable. If you connect an S-video cable, be sure to disconnect the standard (composite) video cable or the picture performance will be unacceptable.

Component video cables (red/green/blue)

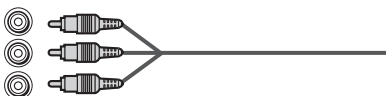

Component video cables come in sets of three and are for use with video devices with component video output. (ColorStream® is Toshiba's brand of component video.) These cables are typically color-coded red, green, and blue. Separate audio cables are required for a complete connection.

Note: Component video cables provide better picture performance than a standard (composite) video or S-video cable.

HDMI™ cable (with HDMI Logo “HDMI”)



HDMI (High-Definition Multimedia Interface) cable is for use with devices with an HDMI output. An HDMI cable delivers digital audio and video in its native format. This cable carries both video and audio information; therefore, separate audio cables are not required for a complete HDMI device connection (see page 16, 17 and 19).

Note: HDMI cable provides better picture performance than a standard (composite) video or S-video cable.

Dual-wand IR blaster cable



Dual-wand IR blaster cable is for use with video devices with IR (infrared) remote control. This cable can be used with the TV's IR pass-through feature (see page 15).

To obtain IR blaster cable:

Visit <http://ceaccessories.toshiba.com/>

Optical audio cable



Optical audio cable is for connecting receivers with Dolby Digital or PCM (pulse-code modulation) optical audio input to the TV's **DIGITAL AUDIO OUT** terminal (see page 18).

Analog RGB (15-pin) computer cable

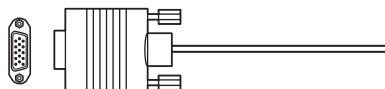

Analog RGB (15-pin) computer cable is for connecting a PC to the TV's **PC IN** terminal (see page 19).

Note: Separate audio cables are required for a complete connection.

About the connection illustrations

You can connect different types and brands of devices to your TV in several different configurations. The connection illustrations in this manual are representative of typical device connections only. The input/output terminals on your devices may differ from those illustrated herein. For details on connecting and using your specific devices, refer to each device's owner's manual.

Connecting a VCR (or a VCR with S-video) and antenna, Cable TV or Camcorder

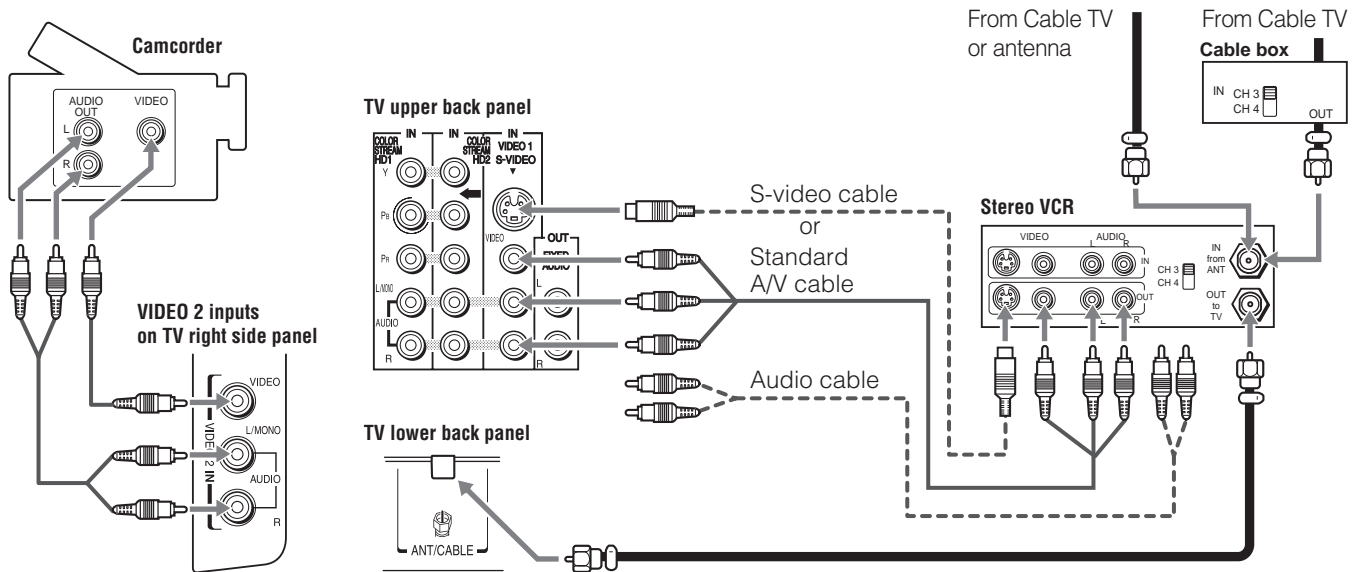

You will need:

- coaxial cables
- standard A/V cables
 - For better picture performance, if your VCR has S-video, use an S-video cable (plus the audio cables) instead of the standard video cable.
 - For better picture performance, if your camcorder has S-video, connect an S-video cable (plus the audio cables) to **VIDEO 1** on the TV back instead of the **VIDEO 2** on the TV right side panel.
 - If you have a mono VCR, connect **L/MONO** on the TV to your VCR's audio out terminal using the white audio cable only.
- S-video cable (if your VCR or camcorder has S-video)
 - Do not connect both types of video cable to **VIDEO 1** at the same time or the picture performance will be unacceptable.
- standard audio cables (if your VCR or camcorder has S-video)

Note: When you use a Cable box, you may not be able to use the remote control to program or access certain features on the TV.

To view the antenna or Cable signal:

Select the **ANT/CABLE** video input source on the TV.*

To view basic and premium Cable channels:

Turn OFF the VCR. Select the **ANT/CABLE** video input source on the TV.* Tune the TV to channel 3 or 4 (whichever channel the Cable box output is set to). Use the Cable box controls to change channels.

To view the VCR:

Turn ON the VCR. Select the **VIDEO 1** video input source on the TV.*

To view the camcorder video:

Select the **VIDEO 2** video input source on the TV.*

* To select the video input source, press **INPUT** on the remote control (page 21). To program the TV remote control to operate other devices, see Chapter 3.

The unauthorized recording, use, distribution, or revision of television programs, videotapes, DVDs, and other materials is prohibited under the Copyright Laws of the United States and other countries, and may subject you to civil and criminal liability.

Connecting a DVD player with ColorStream® (component video), a VCR, and a satellite receiver

Your TV has two sets of ColorStream® (component video) inputs.

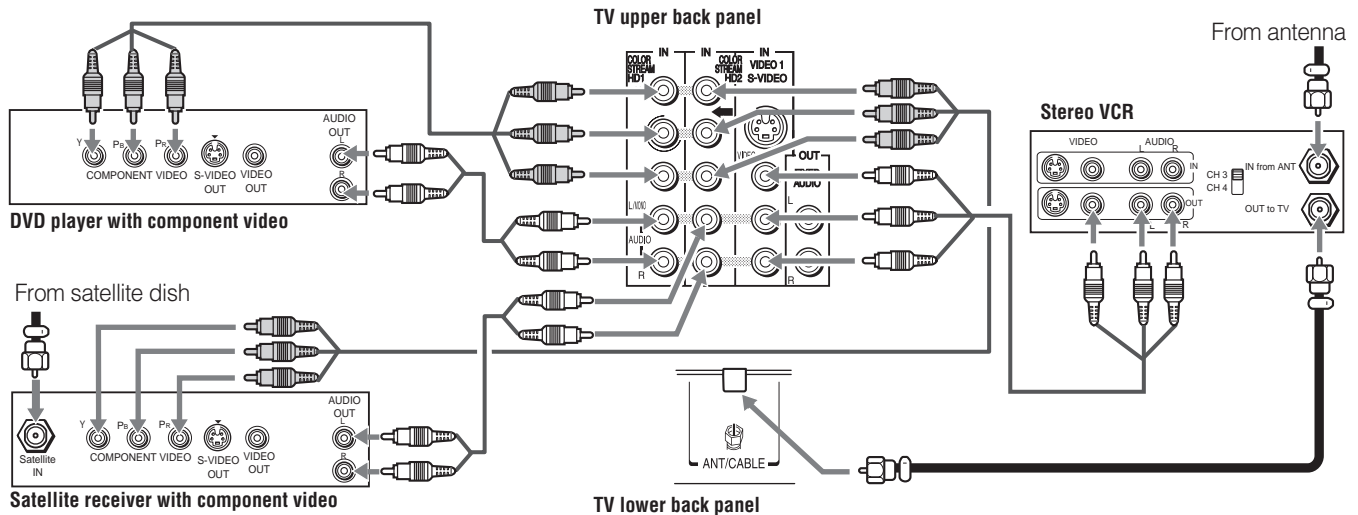

You will need:

- coaxial cables
- standard A/V cables
 - For better picture performance, if your VCR has S-video, use an S-video cable (plus the audio cables) instead of the standard video cable. Do not connect both types of video cable to **VIDEO 1** at the same time or the picture performance will be unacceptable.
 - If you have a mono VCR, connect **L/MONO** on the TV to your VCR's audio out terminal using the white audio cable only.
- standard audio cables
- component video cables
 - You can connect the component video cables (plus audio cables) from the DVD player or satellite receiver to either set of **ColorStream** terminals on the TV (**HD1** or **HD2**). The **ColorStream HD1** and **HD2** terminals can be used to display Progressive (480p, 720p) and Interlaced (480i, 1080i). Please check the Owner's Manual of the DVD player or satellite in order to determine the best output signal available (1080p is not supported).
 - If your DVD player or satellite receiver does not have component video, connect a standard A/V cable to **VIDEO 2** on the side panel. If your DVD player has HDMI video, see page 16.

To view antenna or Cable channels:

Select the **ANT/CABLE** video input source on the TV.*

To view the DVD player:

Turn ON the DVD player. Select the **ColorStream HD1** video input source on the TV.*

To view satellite programs using the component video connections:

Turn on the satellite receiver. Select the **ColorStream HD2** video input source on the TV.*

To view the VCR or view and record antenna channels:

Turn ON the VCR. Tune the VCR to the channel you want to watch. Select the **VIDEO 1** video input source on the TV.*

To record a TV program while watching a DVD:

Turn ON the VCR. Tune the VCR to the channel to record. Select the **ColorStream HD1** video input source on the TV* to view the DVD.

* To select the video input source, press **INPUT** on the remote control (page 21). To program the TV remote control to operate other devices, see Chapter 3.

The unauthorized recording, use, distribution, or revision of television programs, videotapes, DVDs, and other materials is prohibited under the Copyright Laws of the United States and other countries, and may subject you to civil and criminal liability.

Connecting a device to the IR OUT infrared terminal using the IR blaster cable for IR pass-through device control

You can use the TV's **IR OUT** terminal (infrared pass-through) to remotely operate (through the TV) many infrared remote-controlled devices (such as Toshiba infrared remote-controlled VCRs or DVD players) enclosed within an entertainment center or similar cabinet. Without the **IR OUT** connection, the device typically would need to be visible to operate it remotely.

You will need:

- dual-wand IR blaster cable (see page 12)
- other audio/video cables as required to connect the device(s) to the TV (see pages 13–16)

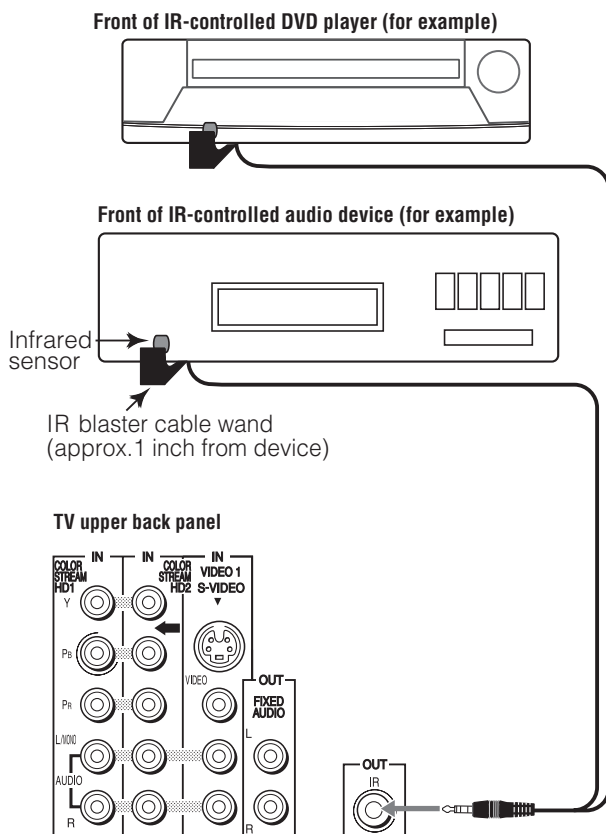

To connect the IR blaster cable:

- 1 Locate the infrared sensor on the front of your device. This sensor is marked on some devices.*
- 2 Align one of the IR blaster cable's wands about 1 inch away from the infrared sensor on the front of the device and attach it using double-sided mounting tape. If you have a second device, attach the second wand in a similar manner. (See illustration.)

Note: If you do not have a second device, coil the second wand with a rubber band and leave it behind the TV.

- 3 Plug the IR blaster cable's plug into the TV's **IR OUT** terminal.

To control the device(s):

Point either the device's remote control or the TV remote control (that you previously programmed to operate the device; see Chapter 3) toward the front of the TV and press the button for the desired function. The signal passes from the remote control through the TV to the device via the IR blaster cable.

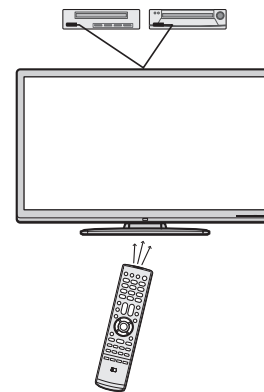

Note:

- If you use the device's remote control to operate the device, you also will need to use the TV's remote control to operate the TV.
- The IR pass-through feature does not support all IR-controlled devices; satisfactory performance may not be attainable with certain devices.

*If you cannot locate the device's infrared sensor:

- 1 Turn OFF the device.
- 2 Starting at the lower left corner of the device, place the end of the device's remote control (with the infrared emitter) so it touches the front of the device and press **POWER**. (Do not use the TV's remote control for this step.)
- 3 If the device turns on, the point at which the remote control touched the device is the location of the sensor.
- 4 If the device does not turn on, move the remote control slightly to the right and press **POWER** again.
- 5 Repeat step 4 until you locate the device's infrared sensor.

Connecting an HDMI™ or DVI device to the HDMI input

The HDMI input on your TV receives digital audio and uncompressed digital video from an HDMI source device, or uncompressed digital video from a DVI (Digital Visual Interface) source device.

This input is designed to accept HDCP (High-Bandwidth Digital-Content Protection) program material in digital form from EIA/CEA-861-D-compliant^[1] consumer electronic devices (such as a set-top box or DVD player with HDMI or DVI output).

The HDMI input can accept and display VGA, SVGA, XGA, WXGA, SXGA, 480i (60Hz), 480p (60Hz), 720p (60Hz), 1080i (60Hz), and 1080p (24Hz/60Hz) signal formats. For detailed signal specifications, see page 63.

Supported Audio format: Linear PCM, sampling rate 32/44.1/48 kHz

Note: To connect a PC to the HDMI input, see page 19.

To connect an HDMI device, you will need:

- one HDMI cable (type A connector) per HDMI device
 - For proper operation, it is recommended that you use an HDMI cable with the HDMI Logo (**HDMI**).
 - To display an 1080p/60Hz signal format, you will need a Category 2 cable. Conventional HDMI/DVI cable may not work properly.
 - HDMI cable transfers both video and audio. Separate analog audio cables are not required (see illustration).
 - See “Setting the HDMI™ audio mode” (page 32).

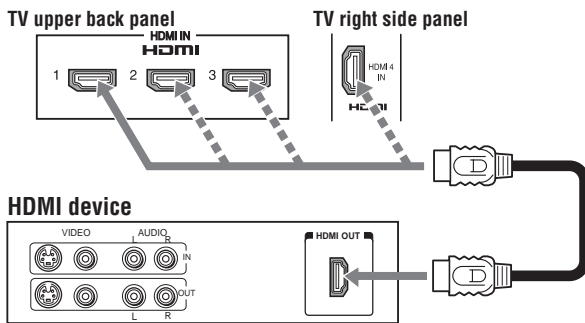

To view the HDMI device video:

Select the HDMI 1, HDMI 2, HDMI 3, or HDMI 4 video input source on the TV.*

* To select the video input source, press **INPUT** on the remote control (page 21). To program the TV remote control to operate other devices, see Chapter 3.

To connect a DVI device, you will need:

- one HDMI-to-DVI adapter cable (HDMI type A connector) per DVI device
 - For proper operation, the length of an HDMI-to-DVI adapter cable should not exceed 9.8 ft (3m). The recommended length is 6.6 ft (2m).
- one pair of standard analog audio cables per DVI device
 - An HDMI-to-DVI adapter cable transfers video only. Separate analog audio cables are required (see illustration).
 - See “Setting the HDMI™ audio mode” (page 32).

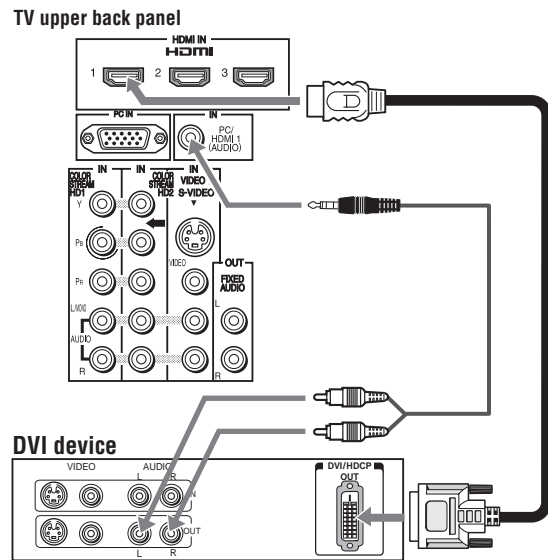

Note: To ensure that the HDMI or DVI device is reset properly, it is recommended that you follow these procedures:

- When turning on your electronic components, **turn on the TV first**, and then the HDMI or DVI device.
- When turning off your electronic components, **turn off the HDMI or DVI device first**, and then the TV.

[1] EIA/CEA-861-D compliance covers the transmission of uncompressed digital video with high-bandwidth digital content protection, which is being standardized for reception of high-definition video signals. Because this is an evolving technology, it is possible that some devices may not operate properly with the TV.

HDMI, the HDMI logo and High-Definition Multimedia Interface are trademarks or registered trademarks of HDMI Licensing LLC.

REGZA-LINK connection

You can control the basic functions of connected audio/video devices using the TV's remote control if you connect a REGZA-LINK compatible audio receiver or playback device. For an explanation of setup and operations, see pages 51 and 52.

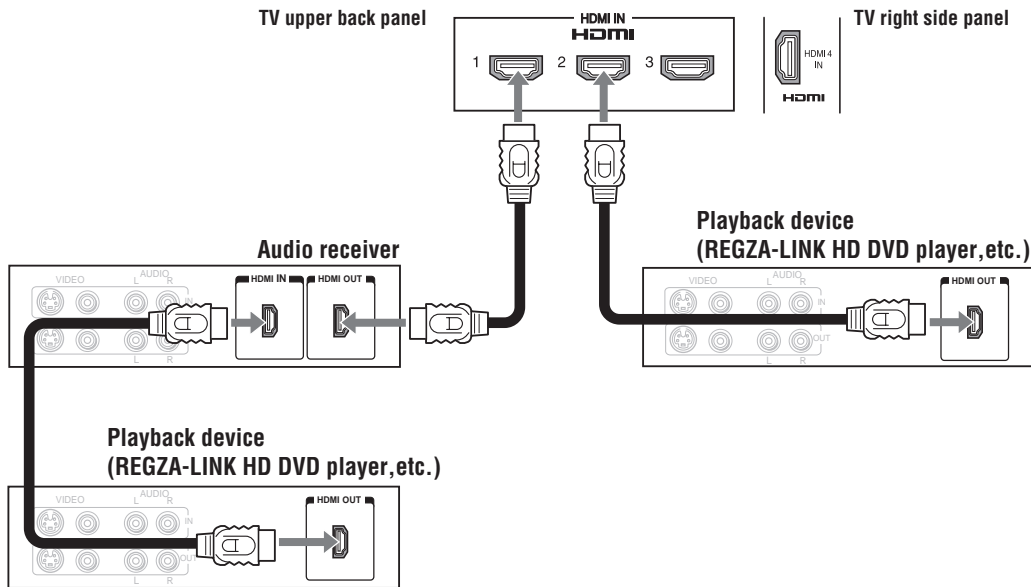

To connect an Audio Receiver and Playback Devices, you will need:

- HDMI cables (☞ page 16)

Note:

- If several devices are connected, REGZA-LINK feature may not operate properly.
- For proper operation, it is recommended that you use HDMI cables with the HDMI Logo (**HDMI**).

Before controlling the device(s):

- After completing the above connections, set the **REGZA-LINK Setup** menu as you desire (☞ page 52).
- The connected devices must also be set. For details, see the operation manual for each device.
- The REGZA-LINK feature uses the CEC technology as regulated by the HDMI standard.
- This feature is limited to models incorporating Toshiba's REGZA-LINK. However, Toshiba is not liable for those operations. Refer to the individual instruction manuals for compatibility information.

Connecting a digital audio system

The TV's **DIGITAL AUDIO OUT** terminal outputs a Dolby®* Digital  or 2-channel down-mixed PCM (pulse-code modulation) signal for use with an external Dolby® Digital decoder or other external audio system with optical audio input.

You will need:

- optical audio cable (Use an optical audio cable that has the larger "TosLink" connector and not the smaller "mini-optical" connector.)

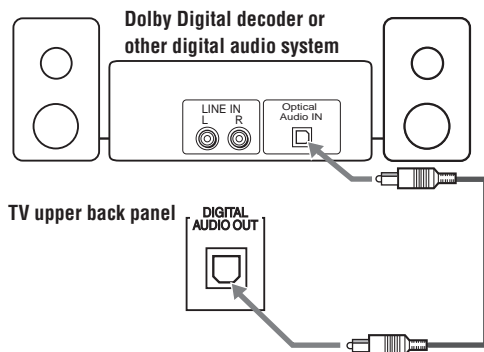

To control the audio:

- Turn on the TV and the digital audio device.
- Press **MENU** on the TV's remote control and open the **Audio** menu.
- Highlight **Audio Setup** and press **ENTER**.

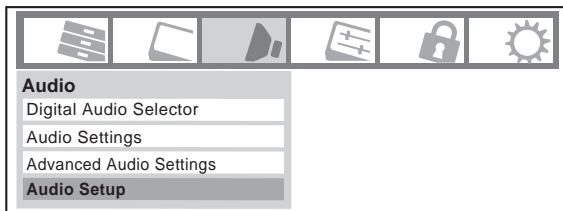

- In the **Optical Output Format** field, select either **Dolby Digital** or **PCM**, depending on your device (⏪ "Selecting the optical audio output format" on page 46).

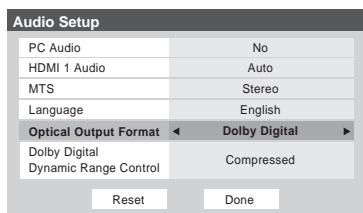

Note:

- Some audio systems may not be compatible with Dolby Digital bitstream signals. Older audio systems that are not compatible with standard optical out signals may not work properly, creating a high noise level that may damage speakers or headphones. **THIS DAMAGE IS NOT COVERED BY YOUR WARRANTY.**
- The **DIGITAL AUDIO OUT** terminal may not output some digital audio sources because of copy restrictions.

* Manufactured under license from Dolby Laboratories. Dolby, and the double-D symbol are registered trademarks of Dolby Laboratories.

Connecting an audio system

This connection allows you to use external speakers with an external analog audio amplifier to adjust the sound level.

You will need:

- standard audio cables

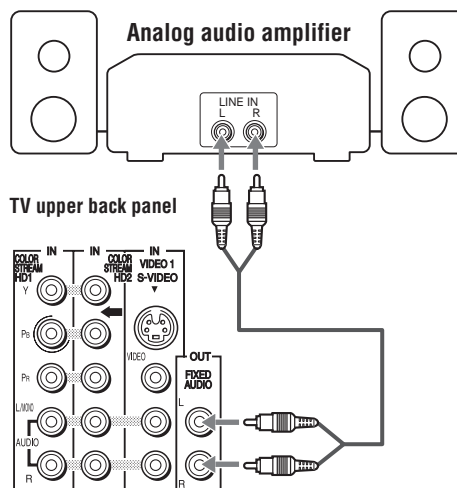

To control the audio:

- Turn on the TV and the stereo amplifier.
- Minimize the sound volume from the TV's built-in speakers and control the volume level using the amplifier's remote control.

Connecting a personal computer (PC)

With either the PC IN or HDMI connection, you can watch your computer's display on the TV and hear the sound from the TV's speakers.

To connect a PC to the PC IN terminal on the TV:

When connecting a PC to the PC IN terminal on the TV, use an analog RGB (15-pin) computer cable and a PC audio cable.

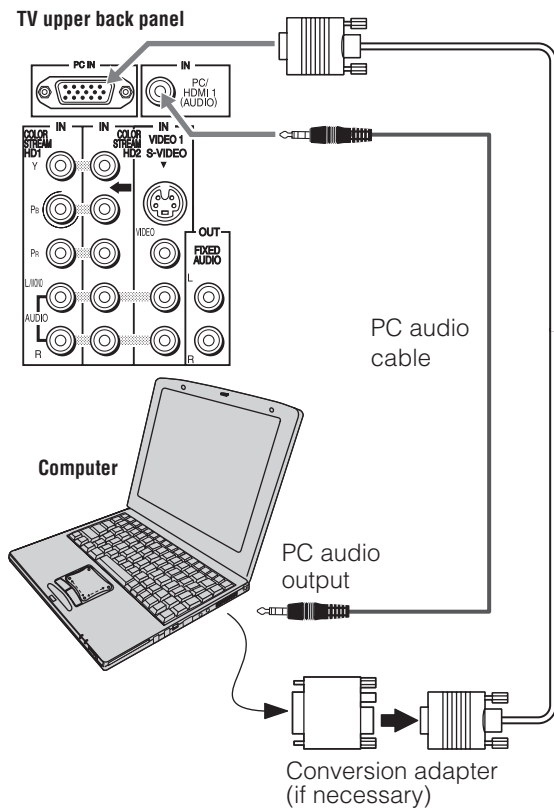

- To use a PC, set the monitor output resolution on the PC before connecting it to the TV. The PC IN terminal can accept and display VGA, SVGA, XGA, WXGA, and SXGA signal formats. For detailed signal specifications, see page 63.
- To display the optimum picture, use the PC setting feature (see "Using the PC settings feature" on page 50).

Note:

- The PC audio input terminals on the TV are shared with the HDMI 1 analog audio input terminals (see page 50).
- Some PC models cannot be connected to this TV.
- An adapter is not needed for computers with a compatible mini D-sub 15-pin terminal.
- Depending on the DVD's title and the specifications of the PC on which you are playing the DVD-Video, some scenes may be skipped or you may not be able to pause during multi-angle scenes.

- Signal names for mini D-sub 15-pin connector

Pin No.	Signal name	Pin No.	Signal name	Pin No.	Signal name
1	R	6	Ground	11	NC
2	G	7	Ground	12	NC
3	B	8	Ground	13	H-sync
4	NC *	9	NC	14	V-sync
5	NC	10	Ground	15	NC

*NC=Not connected

To connect a PC to the HDMI terminal on the TV:

When connecting a PC to the HDMI terminal on the TV, use an adapter cable and analog audio cables.

If connecting a PC with an HDMI terminal, use an HDMI cable (type A connector). Separate analog cables are not necessary (see page 16).

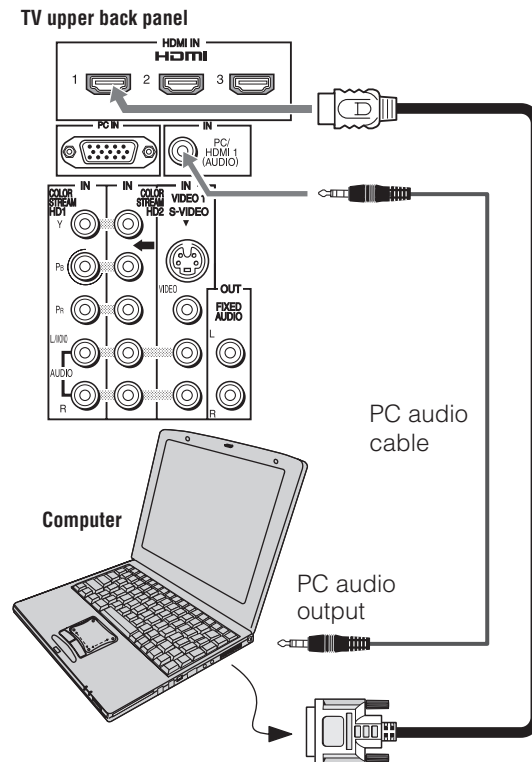

The HDMI input can accept and display VGA, SVGA, XGA, WXGA, SXGA, 480i (60Hz), 480p (60Hz), 720p (60Hz), 1080i (60Hz), and 1080p (24Hz/60Hz) signal formats. For detailed signal specifications, see page 63.

Note:

- The edges of the images may be hidden.
- If receiving a 480i (HDMI), 480p (HDMI), 720p, 1080i, or 1080p signal program, Native mode scales the video to display the entire picture within the borders of the screen (i.e. no overscanning).

Chapter 3: Using the remote control

Preparing the remote control for use

Your TV remote control can operate your TV and many other devices such as cable converter boxes, satellite receivers, VCRs, DVD players, and HTIBs (home theater in a box), even if they are different brands.

If you have a Toshiba device:

Your TV remote control is preprogrammed to operate most Toshiba devices (📖 page 24).

If you have a non-Toshiba device or a Toshiba device that the remote control is not preprogrammed to operate:

You can program the TV remote control so it will operate the other device (📖 pages 22–26).

Installing the remote control batteries

- 1 Remove the battery cover from the back of the remote control.

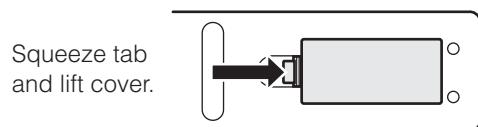

- 2 Install two “AAA” size batteries, making sure to match the + and – signs on the batteries to the signs on the battery compartment.

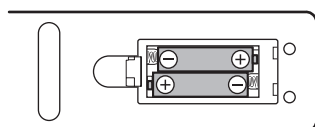

- 3 Reinsert the battery cover in the remote control until the tab snaps.

Caution: Batteries must not be exposed to excessive heat such as sunshine, fire or the like.

Note:

- Be sure to use AAA size batteries.
- Dispose of batteries in a designated disposal area.
- Batteries should always be disposed of with the environment in mind. Always dispose of batteries in accordance with applicable laws and regulations.
- If the remote control does not operate correctly, or if the operating range becomes reduced, replace batteries with new ones.
- When necessary to replace batteries in the remote control, always replace both batteries with new ones. Never mix battery types or use new and used batteries in combination.
- Always remove batteries from the remote control if they are dead or if the remote control is not to be used for an extended period of time. This will prevent battery acid from leaking into the battery compartment.

Learning about the remote control

The buttons used for operating the TV only are described here. For a complete list of the remote control's functions, see the remote control functional key chart (page 23).

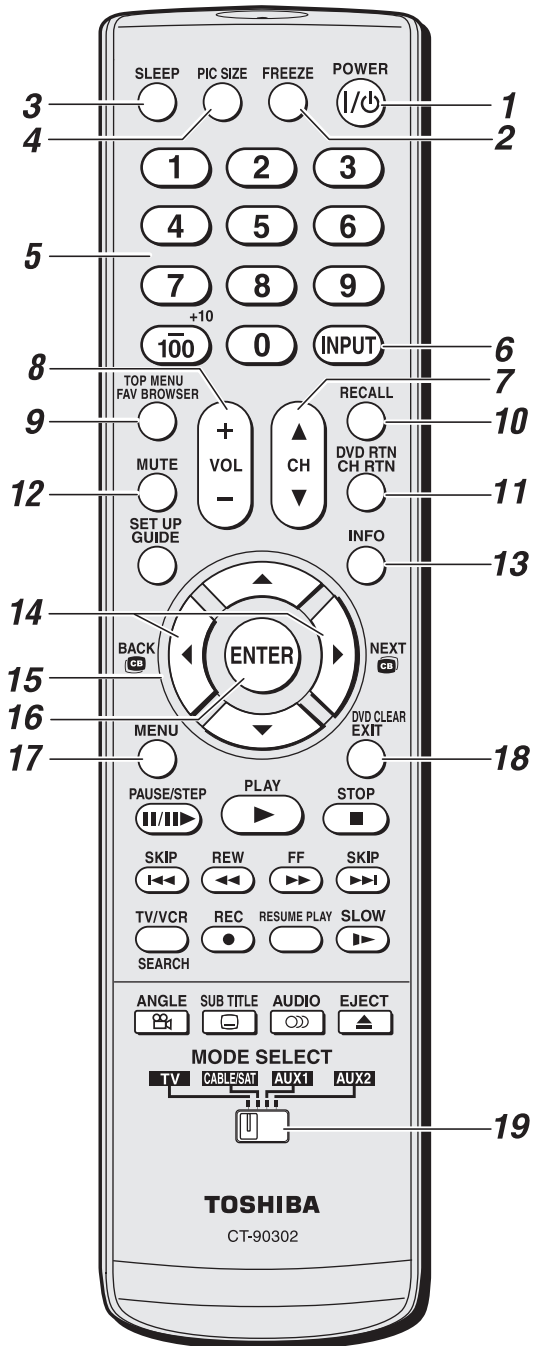

- 1 **POWER** turns the TV on and off. When the TV is on, the green LED indicator on the TV front will be illuminated.
- 2 **FREEZE** freezes the picture. Press again to restore the moving picture (page 42).
- 3 **SLEEP** accesses the sleep timer (page 51).
- 4 **PIC SIZE** cycles through the picture sizes: **Natural**, **TheaterWide 1/2/3**, **Full**, **4:3 HD**, **Native**, and **Dot by Dot** (page 39).
- 5 **Channel Numbers (0–9, –/100)** directly tune channels. The **100** button is used to tune digital channels (page 38) or to edit the Favorites List (page 36).
- 6 **INPUT** selects the video input source (page 35).
- 7 **CH ▲▼** cycles through programmed channels when no menu is on-screen (page 30).
- 8 **VOL + –** adjusts the volume level.
- 9 **FAV BROWSER** accesses the Favorites List in the Channel Browser™ (page 36).
- 10 **RECALL** displays TV status information (page 54).
- 11 **CH RTN** returns to the last viewed channel or source (page 39).
- 12 **MUTE** reduces or turns off the sound (page 44).
- 13 **INFO** displays TV status information as well as program details, when available (page 54).
- 14 **BACK** / **NEXT** While watching TV, these buttons open the Channel Browser™ and tune to the previous/next channel in the channel history (page 37). (Also see “Arrow buttons.”)
- 15 **Arrow buttons (▲▼◀▶)** When a menu is on-screen, these buttons select or adjust programming menus. (Also see **BACK** / **NEXT**.)
- 16 **ENTER** activates highlighted items in the main menu system.
- 17 **MENU** accesses the main TV menu system (page 27).
- 18 **EXIT** closes on-screen menus.
- 19 **MODE SELECT switch** switches between TV, CABLE/SAT, AUX 1, and AUX 2 modes (page 22). Set to “TV” to control the TV.

Note: The error message “Not Available” may appear if you press a key for a function that is not available.

Using the remote control to control your other devices

If you have a non-Toshiba device or a Toshiba device that the remote control is not preprogrammed to operate, you must first program the remote control to recognize the device (if you have not already done so) (pages 24–26).

To use your TV remote control to operate a:

- Cable converter box or satellite receiver, set the **MODE SELECT switch** to **CABLE/SAT**.
- VCR, set the **MODE SELECT switch** to **AUX 1**.
- DVD player or HTIB, set the **MODE SELECT switch** to **AUX 2**.

Note: Even after the TV remote control is programmed, it may not operate certain features on any other devices. If this happens and you wish to use those features, you will need to use the device's original remote control.

Point the remote control directly at the device.

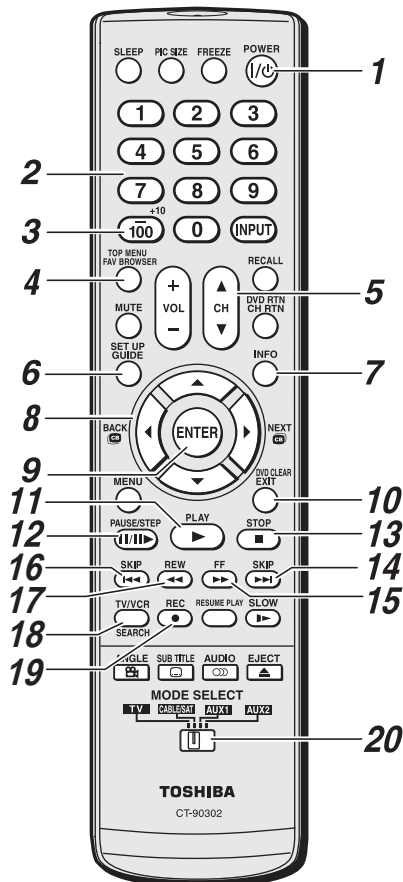

- 1 POWER** Turns the selected device on and off.
- 2 Channel Numbers (0-9)** Press to directly access channels (as opposed to).
- 3 +10** Press to directly access DVD chapters higher than 10.
- 4 TOP MENU** Accesses a DVD's top menu.
- 5 CH ▲▼** For channels programmed into the channel memory (page 38):
▲ selects the next higher channel.
▼ selects the next lower channel.
- 6 GUIDE** Displays the channel guide in the CABLE/SAT mode.
SET UP Accesses a DVD's setup menu in the AUX mode.
- 7 INFO** Displays TV status information on-screen.
- 8 ▲▼◀▶** Press to navigate DVD menus (may not work on some DVD players).
- 9 ENTER** Required by some satellite receivers and DVD players to activate certain functions.
- 10 DVD CLEAR** Press to reset the title and chapter number.
- 11 PLAY** Begins playback of a tape or DVD.
- 12 PAUSE** Press during play or record mode to pause the picture; press again to restart.
- 13 STOP** Stops the tape or DVD.
- 14 SKIP ▶▶** Skips forward to locate later DVD chapters.
- 15 FF** Fast-forwards the tape or DVD. (Press during play mode to view the picture moving rapidly forward.)
- 16 SKIP ◀◀** Skips back to beginning of current DVD chapter, or locates previous chapters.
- 17 REW** Rewinds/reverses the tape or DVD. (Press during play mode to view the picture moving rapidly backward.)
- 18 TV/VCR** To view one program while recording another, press to select TV mode.
SEARCH selects a specific DVD chapter, title or time.
- 19 REC** Starts tape recording.
- 20 MODE SELECT switch** Set to "TV" to control the TV; "CABLE/SAT" to control a cable converter box or satellite receiver; "AUX 1" to control a VCR; "AUX 2" to control a DVD player or HTIB.

Remote Control functional key chart

Note:

- “---” = key does not send a signal in that remote control mode.
- “←TV” = key will affect the TV, even though the remote control is in another mode.
- * Not available for your TV.

REMOTE CONTROL KEY	Toshiba TV	CABLE	SAT (satellite)	AUX 1 (VCR)	AUX 2 (DVD or HTIB)
POWER	Power	Power	Power	Power	Power
SLEEP	Sleep timer	← TV	← TV	← TV	← TV
PIC SIZE	Picture size	← TV	← TV	← TV	← TV
FREEZE	FREEZE	← TV	← TV	← TV	← TV
1-9	Digit 1-9	Digit 1-9	Digit 1-9	Digit 1-9	Digit 1-9
0	Digit 0	Digit 0	Digit 0	Digit 0	Digit 0
100/-/+10	- (sub CH)	---	- (sub CH)	100	+10
INPUT	TV/Video select	← TV	← TV	← TV	← TV
FAV BROWSER/ TOP MENU	FAV BROWSER DVD TOP Menu*	---	---	---	Top Menu
MUTE	Sound mute	← TV	← TV	← TV	← TV
SET UP/GUIDE	Guide*	---	SAT Guide	---	Setup
VOL + -	Volume up/down	← TV	← TV	← TV	← TV
CH▲▼	Channel up/down	Channel up/down	Channel up/down	Channel up/down	Channel up/down
RECALL	RECALL	← TV	← TV	← TV	← TV
CH RTN/DVD RTN	Previous channel DVD previous menu*	---	---	---	DVD Return
INFO	Info	---	Info	---	Display
ENTER	Enter	---	Select, Enter	---	Enter
▲▼	Menu up/down	---	Menu up/down	---	Menu up/down
◀ BACK CB	Menu left/ Channel Browser™	---	Menu left	---	Menu left
▶ NEXT CB	Menu right/ Channel Browser™	---	Menu right	---	Menu right
MENU	Menu	---	Action Menu	---	DVD Menu
EXIT/DVD CLEAR	Exit DVD clear*	---	Exit	---	DVD Clear
PAUSE/STEP	Pause*	---	---	Pause	Pause
PLAY	Play*	---	---	Play	Play
STOP	Stop*	---	---	Stop	Stop
SKIP ◀◀	Skip REV*	---	---	---	Skip REV
SKIP ▶▶	Skip FWD*	---	---	---	Skip FWD
REW	Rewind*	---	---	Rewind	Rewind
FF	Fast FWD*	---	---	Fast FWD	Fast FWD
TV/VCR/ SEARCH	DVD search*	---	---	TV/VCR	DVD search
REC	REC MENU*	---	---	Record (2 click)	Record (2 click)
RESUME PLAY	---	---	---	---	Resume Play
SLOW +	SLOW FWD*	---	---	---	SLOW FWD
ANGLE	Angle*	---	---	---	DVD Angle
SUB TITLE	Sub title*	---	---	---	DVD Sub title
AUDIO	Audio*	---	---	---	DVD Audio
EJECT	Eject*	---	---	---	DVD Eject

Programming the remote control to control your other devices

Your Toshiba TV remote control is preprogrammed to operate most Toshiba devices. To program your TV remote control to operate a non-Toshiba device (or a Toshiba device that it is not preprogrammed to operate), follow the steps below. For details on using the remote control to operate the device, see page 22.

- 1 In the remote control code table (see page 25), find the code for your device. If more than one code is listed, try each one separately until you find one that works.
- 2 Set the **MODE SELECT switch** to the type of device you are programming the remote control to operate — CABLE/SAT (for a cable converter box or satellite receiver), AUX 1 (for a VCR or TV/VCR combo), or AUX 2 (for a DVD player or HTIB [home theater in a box]).
- 3 While holding down **RECALL**, press the Channel Number buttons to enter the 3-digit code for your device.
- 4 To test the code, turn on the device, point the remote control at it, and press **POWER**. See notes below.
 - If the correct code was entered, the device will turn off.
 - If the device does not respond, repeat steps 1–4 using another code.
 - If the device does not respond to another code, you will need to use the remote control that came with the device.
- 5 Remember to set the **MODE SELECT switch** back to “TV” to control the TV.
- 6 For future reference, write down the code(s) you used:

DEVICE	CODE	DEVICE	CODE

Note:

- In addition to **POWER**, confirm that all necessary keys on the TV remote control operate your device. If some keys are not operational, repeat the device code setup using another code (if other codes are listed for your device). If, after trying all listed codes, the necessary keys do not operate your device, use the device’s original remote control.
- Every time you change the batteries, you will need to reprogram the remote control.
- Some newer VCRs respond to either of two codes. These VCRs have a switch labeled “VCR1/VCR2.” If your VCR has this kind of switch and does not respond to the codes for your VCR brand, set the switch to the other position (“VCR1” or “VCR2”) and reprogram the remote control.

Remote control codes

In some cases you may not be able to operate your device with the TV remote control. Your other device may use a code that is not recognized by the TV remote control. If this happens, use the device's remote control.

Cable converter box

ABC	061, 062, 063, 082, 084, 087, 092, 096, 098
Archer	065, 092, 097, 099
Cableview	064, 094
Century	092
Citizen	090, 092, 097
Contec	083, 085, 086, 088, 093, 098
Diamond	093
GE	061, 062
Gemini	069, 070, 094
Hamlin	093
Hitachi	062, 095, 096
Jasco	097
Motorola/GI/Jerrold	062, 069, 071, 082, 086, 089, 096, 107
Magnavox	072, 096
Memorex	092, 104
Multi Canal	090
Novavision	101
Panasonic	081, 083, 085
Philco	087
Philips	066, 067, 068, 070, 072, 073, 074, 075, 092
Pioneer	076, 077
Proscan	061, 062
Radio Shack	092, 097, 099
RCA	064, 081
Realistic	065
Recoton	102
Samsung	077, 090
Scientific Atlanta	063, 078, 079, 080, 088, 098, 101, 105
Sears	095
Signature	062
Signature 2000	096
Sprucer	081, 085
Starcom	069, 082, 087, 096, 103, 104
Stargate	069, 090
Sylvania	095, 100
TeleView	090
Texscan	100
Tocom	071, 084, 085
U. S. Electronics	087, 096, 098
United Cable	082
Universal	065, 092, 097, 099, 102, 103
Wards	096

Satellite receiver

Alphastar	038, 059
Chaparral	034
DISH Network	057

Drake	020, 040, 044, 046, 050, 053
Echostar	018, 041, 051
Express Vu	057
Fujitsu	027
GE	008, 009, 013
General Instruments	010, 011, 012, 022, 023, 031, 049
Hitachi	033
Hughes	033
Hughes Network Systems	019
Intersat	048
Janeil	027
JVC	017, 057
Kenwood	029
Magnavox	060
Optimus	058
Pansat	036, 052
Primestar	015, 042
Proscan	008, 009, 013
Radio Shack	022, 023, 030
RCA	008, 009, 013, 016
Realistic	030
Samsung	059
Sony	014, 055
Star Choice	057, 106
Star Trak	025, 026, 037, 054
STS	024
Toshiba	000, 001, 002, 003, 004, 005, 006, 007, 020, 031, 056
Uniden	021, 028, 030, 032, 035, 039, 043, 045, 047, 058
Zenith	027

TV/VCR Combo

Action	078
GE	059, 062
Goldstar	065
Panasonic	065
Precision	078
Quasar	065
Realistic	079
Sony	074
Toshiba	057
Zenith	065
Totevision	009, 010, 065

DVD/VCR Combo

Go Video	DVD=087, VCR=081
JVC	DVD=088, VCR=082
RCA	DVD=089, VCR=083
Samsung	DVD=090, VCR=084
Sanyo	DVD=091, VCR=085
Zenith	DVD=092, VCR=086

DVD player

Aiwa	006, 015
Apex	016, 017
BOSE	097
Broksonic	018

Clarion	019
Classic	020
Daewoo	021
Denon	022, 023, 024, 025
Emerson	026, 027
Fisher	028
Funai	027
GE	001, 029, 030
Go Video	087
GPX	031
Hitachi	005, 032, 033, 034, 035
JVC	003, 007, 036, 042, 088
Kenwood	037
Konka	008, 009
Magnavox	004, 038
Memorex	039
Mintek	040
NAD	026
Nakamichi	041
Norcent	043
Onkyo	044
Oritron	058
Panasonic	010, 045, 046, 047, 048, 049, 050
Philips	004, 051
Pioneer	052, 053, 054, 055
Proscan	001, 056
Qwestar	057, 058
RCA	001, 002, 059, 089
Sampo	060
Samsung	061, 062, 086, 090
Sansui	073
Sanyo	063, 091
Sharp	064, 067
Sherwood	074
Sony	011, 012, 065, 066, 068, 069, 070
Sylvania	027
Teac	071
Technics	072
Techwood	075
Toshiba	000, 013, 076, 077, 078
Yamaha	079, 080, 081
Zenith	014, 082, 092

Portable DVD player

Aiwa	093
Audiovox	094, 095
Panasonic	024, 096, 099
RCA	098

VCR

Admiral	049
Aiko	019
Aiwa	018
Akai	003, 004, 037, 038, 039, 058, 069
Audiovox	010
Bell & Howell	007, 068
Broksonic	008, 017
Calix	010
Carver	026
CCE	019
Citizen	009, 010, 011, 012, 013, 014, 015, 019, 057, 073
Colortyme	005

(continued)







Chapter 3: Using the remote control

Craig	009, 010, 016, 061, 065, 079	Orion	054, 057, 062, 065, 068, 072	Video Concepts	005, 006, 011, 012, 039, 053
Curtis Mathes	001, 005, 009, 012, 014, 040, 048, 053, 056, 057	Panasonic	036, 045, 046, 057, 061, 072, 079	Wards	009, 010, 011, 016, 018, 020, 024, 025, 031, 035, 049, 051, 056, 057, 060, 065, 066, 079
Daewoo	011, 013, 015, 017, 018, 019, 057, 078	Pentax	012, 024, 025, 035, 042, 053, 063	White Westinghouse	073
Daytron	078	Pentex Research	014	XR-1000	018
Denon	063	Philco	026, 027, 063	Yamaha	005, 006, 007, 014, 037, 053
Dimensia	001, 048	Philips	026, 031, 044, 057	Zenith	004, 032, 034, 041, 047, 069, 086
Electrohome	010, 020, 065	Pioneer	006, 024, 043, 055		
Emerson	003, 008, 010, 011, 017, 018, 020, 028, 039, 054, 057, 062, 065, 068, 072	Portland	012, 013, 015		
Fisher	007, 016, 021, 022, 023, 057, 064, 068, 070, 071, 079	Proscan	001, 002, 048		
Fuji	004, 041	Proton	061		
Funai	018, 073	Quasar	045		
Garrard	018	Radio Shack	010, 031, 065		
GE	001, 002, 009, 040, 042, 048, 056	Radio Shack/Realistic	007, 009, 010, 016, 018, 020, 021, 022, 031, 049		
Go Video	056, 059, 061, 081	Radix	010		
Goldstar	005, 010, 014, 054, 056, 065, 067	RCA	001, 002, 003, 009, 024, 025, 029, 035, 040, 042, 045, 048, 055, 056, 063, 071, 083		
Gradiente	018, 065	Realistic	007, 009, 010, 011, 016, 018, 020, 021, 022, 031, 049, 051, 056, 060, 065, 075, 079		
Harman Kardon	005	Ricoh	047		
Hitachi	024, 025, 035, 037, 042, 063, 070, 080	Runco	034		
JBL	076	Samsung	009, 011, 038, 056, 073, 084		
JC Penney	005, 006, 007, 008, 009, 010, 023, 024, 025, 026, 035, 056, 061, 063, 065	Sansui	006, 037, 043, 061		
Jensen	024, 025, 037, 050	Sanyo	007, 009, 016, 054, 064, 068, 071, 075, 079, 085		
JVC	005, 006, 007, 014, 037, 043, 055, 062, 063, 068, 082	Scott	008, 011, 017, 028, 030, 057, 065, 072		
Kenwood	005, 006, 007, 012, 014, 037, 043, 050, 053, 068, 071	Sears	007, 010, 016, 021, 022, 023, 024, 025, 035, 053, 057, 063, 064, 065, 068, 071, 075, 079		
Kodak	010	Sharp	013, 020, 031, 049, 051, 060, 066		
LG	010	Shintom	004, 025, 032, 061		
Lloyds	053, 073, 079	Signature	049		
Logik	061	Signature 2000	075		
LXI	010	Singer	047, 061		
Magnasonic	061, 065, 078	Sony	004, 032, 033, 041, 052, 058, 070, 074, 076, 077, 080		
Magnavox	026, 027, 034, 044, 057, 061, 072	STS	035		
Marantz	005, 006, 007, 012, 014, 026, 053, 067	Sylvania	018, 026, 027, 028, 044, 072		
Memorex	007, 009, 010, 016, 018, 034, 049, 063, 065, 066, 068, 075, 079	Symphonic	018, 050, 051, 053, 073, 079		
MGA	020, 028, 039	Tandy	007		
MGN	056	Tashiko	010		
Minolta	024, 025, 035, 063	Tatung	037		
Mitsubishi	020, 024, 025, 028, 039, 043, 065	Teac	018, 029, 037		
Montgomery Ward	049	Technics	036		
Motorola	049	Teknika	010, 018, 065		
MTC	009, 046, 061	Toshiba	000, 011, 021, 023, 024, 028, 030, 039, 057, 074, 078, 079, 100, 101		
Multitech	009, 012, 018	Totevision	009, 010, 065		
NEC	005, 006, 007, 012, 014, 037, 043, 053, 054, 067, 070	Unitec	073		
Nikko	010	Unitech	009		
Noblex	009	Vector Research	005, 006, 011, 012, 053		
Optimus	010, 049, 065				
Optonica	031				



Chapter 4: Menu layout and navigation



Main menu layout

To open the main menus (illustrated below), press  on the remote control or TV control panel.

Icon	Item	Page
	Channel Browser™	36
	Favorites Browser	36
	REGZA-LINK Player Control	51
	Mode	42
	Picture Settings	42
	Noise Reduction	56
	ColorMaster	57
	Game Mode	57
	Theater Settings	39
	TheaterLock	43
	Digital Audio Selector	44
	Audio Settings	45
	Advanced Audio Settings	58
	Audio Setup	45
	CC Selector	44
	Base CC Mode	43
	Digital CC Settings	43
	Input Labeling	35
	Channel Labeling	31
	Menu Language	29
	Channel Browser Setup	37
	Enable Rating Blocking	47
	Edit Rating Limits	47
	Channels Block	48
	Input Lock	49
	Control Panel Lock	49
	GameTimer®	49
	New PIN Code	47
	Installation	29
	REGZA-LINK Setup	52
	Sleep Timer	51
	HDMI Settings	53
	PC Settings	50
	Power-On Mode	34

Setup/Installation menu layout

To open the **Installation** menu (illustrated below), press  on the remote control or TV control panel, open the **Setup** menu, select **Installation**, and press .

Icon	Item	Page
	Input Configuration	29
	Channel Program	30
	Channel Add/Delete	30
	Channel Tuning Mode	38
	Signal Meter	33
	Time Zone Setup	33
	System Information	34

Navigating the menu system

You can use the buttons on the remote control or TV control panel to access and navigate your TV's on-screen menu system.

- Press **MENU** to open the menu system.

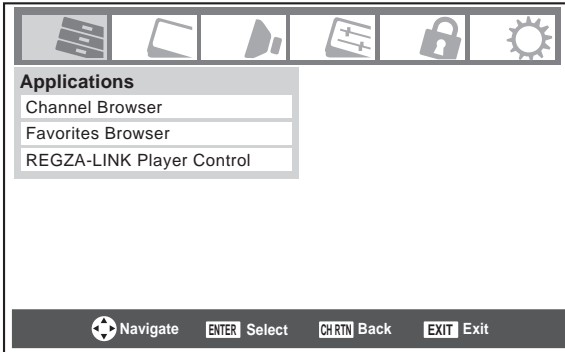

- When a menu is open, use the up/down/left/right arrow buttons (**▲▼◀▶**) on the remote control or TV control panel to move in the corresponding direction in the menu.
- Press **ENTER** to save your menu settings or select a highlighted item. (A highlighted menu item appears in a different color in the menu.)
- All menus close automatically if you do not make a selection within 60 seconds, except the signal meter menu, which closes automatically after about 5 minutes.
- To close a menu instantly, press **EXIT**.

Note:

- *The menu background may sometimes appear black, depending on the signal the TV is receiving. This is not a sign of malfunction.*
- *The Video sub-menu appears with a black background, which looks different from other menus.*

Chapter 5: Setting up your TV

Selecting the menu language

You can choose from three different languages (English, French and Spanish) for the on-screen display of menus and messages.

To select the menu language:

- 1 Press **MENU** and open the **Preferences** menu.
- 2 Highlight **Menu Language** and press **▶**.
- 3 Press **▲** or **▼** to select your preferred menu language and press **ENTER**.

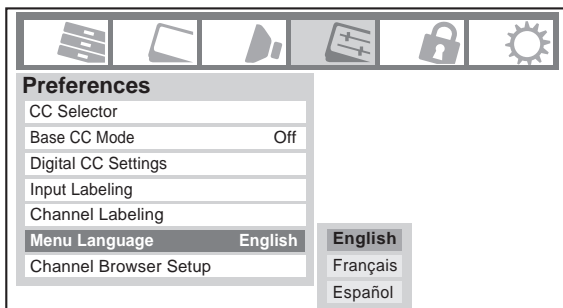

- 4 Press **EXIT** to close the **Preferences** menu.

Configuring the antenna input source for the ANT/CABLE terminal

To configure the ANT/CABLE input source:

- 1 Press **MENU** and open the **Setup** menu.
- 2 Highlight **Installation** and press **ENTER**.

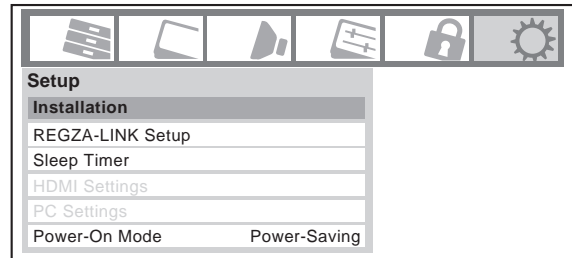

- 3 (A new set of **Installation** menu icons will appear, as shown below.) Open the **Terrestrial** menu, highlight **Input Configuration**, and press **ENTER**.

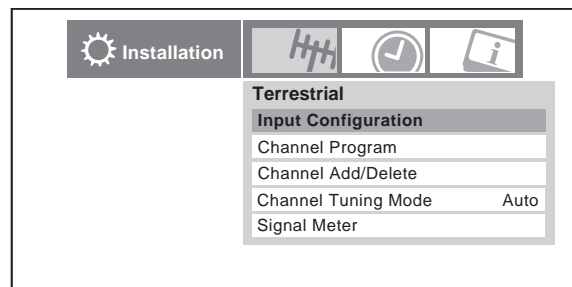

- 4 Press **◀** or **▶** to select the input source (**Cable** or **Antenna**) for the **ANT/CABLE** input on the TV.

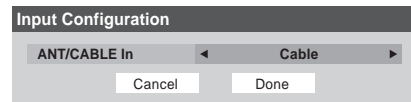

- 5 To save your new settings, highlight **Done** and press **ENTER**. To revert to your original settings, highlight **Cancel** and press **ENTER**.

Programming channels into the TV's channel memory

When you press **ANT/CABLE** or **CH** on the remote control or TV control panel, your TV will stop only on the channels you programmed into the TV's channel memory.

Follow the steps below to program channels into the TV's channel memory.

Programming channels automatically

Your TV can automatically detect all active channels in your area and store them in its memory. After the channels are programmed automatically, you can manually add or erase individual channels in the channel memory.

Note:

- You must configure the ANT/CABLE input source before programming channels (see page 29).
- If the ANT/CABLE input signal type is set to **Cable**, the automatic channel programming process erases channels that were previously programmed into the TV's memory.
- If the ANT/CABLE input signal type is set to **Antenna**, the automatic channel programming process adds newly found channels to the existing set of programmed channels (and does NOT erase channels that were previously programmed into the TV's memory.) To remove an Antenna source channel from the memory, you must manually delete it.
- To tune the TV to a channel not programmed in the channel memory, you must use the Channel Number buttons on the remote control.
- Programming channels when the ANT/CABLE input is configured for **Cable** will take substantially longer than when the antenna input is configured for **Antenna**. This is normal; however, once channel programming is finished, you should not have to repeat the programming process again unless your Cable TV service lineup changes significantly.

To program channels automatically:

- 1 Configure the antenna input source, if you have not already done so (see page 29).
- 2 From the **Setup** menu, highlight **Installation** and press **ENTER**. A new set of **Installation** menu icons will appear.

- 3 Open the **Terrestrial** menu, highlight **Channel Program** to bring up the **Start**, and press **ENTER** again to begin channel programming.

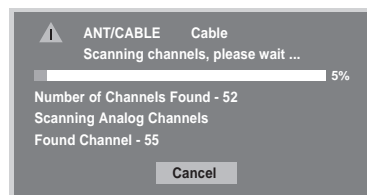

The TV will automatically cycle through all the antenna channels, and store all active channels in the channel memory. While the TV is cycling through the channels, the message “Scanning channels, please wait” appears (as shown above).

- 4 To cancel channel programming, press **EXIT** on the remote control (or highlight **Cancel** in the on-screen display and press **ENTER**).

When channel programming is finished, press **ANT/CABLE** or **CH** to view the programmed channels.

Manually adding and deleting channels in the channel memory

After automatically programming channels into the channel memory, you can manually add or delete individual channels.

To add or delete channels in the channel memory:

- 1 From the **Setup** menu, highlight **Installation** and press **ENTER**. A new set of **Installation** menu icons will appear.
- 2 Open the **Terrestrial** menu, highlight **Channel Add/Delete**, and then press **ENTER**.

To add a channel to the channel memory:

Highlight the unchecked box next to the channel number you want to add, and then press **ENTER** to check the box.

To manually add digital subchannels on a physical channel:

Use the Channel Numbers and the Dash (**100**) on the remote control to enter the channel number (for example, 56-1).

If the channel is found, the number will be added to the list and the box will be checked.

If the channel is not found, a message will appear.

To remove a channel from the channel memory:

Highlight the checked box next to the channel number you want to remove, and then press **ENTER** to uncheck the box.

To save your new settings:

Highlight **Done** and press **ENTER**.

Note: A video preview of the currently highlighted channel is provided to assist you in adding/deleting channels.

To revert to your original settings:

Highlight **Cancel** and press **ENTER** before saving.

To remove all channels from the channel memory:

Highlight **Reset** and press **ENTER**, and then highlight **Done** and press **ENTER**.

To remove encrypted channels from the channel memory:

If an encrypted channel is accidentally added to the channel list by programming channels, you can remove the unwanted encrypted (non-viewable) channel while you are channel surfing. When you tune into an encrypted channel, the following message will appear.



Press **1** while the message is on the screen to remove the unnecessary channel from the channel list.

Labeling channels

A list of common channel labels (logos) for various channels (ABC, CBS, etc.) will be programmed into the TV. You will be able to view and assign these logos from the **Channel Labeling** window. If the desired channel label is not provided in the list, you will be able to manually enter/edit labels using the software keyboard.

To assign channel labels:

- 1 From the **Preferences** menu, highlight **Channel Labeling** and press **ENTER**.
The **Channel Labeling** window opens.
- 2 Press **CH** or **CH** to select the channel you want to label.
- 3 Press **▲▼◀▶** to highlight the desired channel label and press **ENTER**.
- 4 Repeat steps 2 and 3 for other channels.
- 5 To save your settings, highlight **Done** and press **ENTER**.
The maximum number of labels that can be stored is 128.

To remove channel labels:

- 1 Open the **Channel Labeling** window.
- 2 Press **CH** or **CH** to select the channel for which you want to remove the label.
- 3 Press **▲▼◀▶** to highlight **No Label** and press **ENTER**.
- 4 Repeat steps 2 and 3 for other channels.
- 5 To save your settings, highlight **Done** and press **ENTER**.

If the desired channel label is not available from the list of presets, you can create a custom label.

To create and assign a custom label:

- 1 Open the **Channel Labeling** window.
- 2 Press **CH** or **CH** to select a channel you want to label.
- 3 Press **▲▼▶** to highlight **Custom** and press **ENTER**.
The software keyboard will appear.



- 4 Repeatedly press the corresponding key on the remote control to highlight the desired character on the on-screen software keyboard.
- 5 The highlighted character is entered after you either press a different key, press **▶** key, or after a two-second pause.
- 6 Repeat steps 4 and 5 until you have entered all desired text.
- 7 When finished, press **ENTER**.
- 8 New labels will be added to the list in alphabetical order and marked with an icon **✎** to indicate that they are custom. Highlight the new custom label and press **ENTER** to assign.
Assigned channel labels will be displayed in the banner, **Channel Add/Delete**, **Channels Block**, and **Channel Browser**.

To delete the custom label:

- 1 Open the **Channel Labeling** window.
- 2 Highlight the label to be deleted and press **100**.
- 3 Highlight **Yes** from the deletion confirmation window and press **ENTER**.

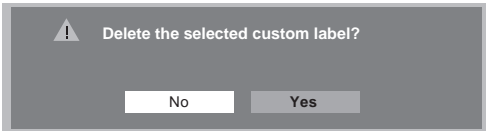

- 4 Highlight **Done** and press **ENTER** to save changes, and go back to the **Channel Labeling** window.

Setting the HDMI™ audio mode

To set the HDMI audio mode:

- 1 From the **Audio** menu, highlight **Audio Setup** and press **ENTER**.
- 2 Press **▲** or **▼** to select **HDMI 1 Audio** and then press **◀** or **▶** to select the HDMI 1 audio mode (**Auto**, **Digital**, or **Analog**). (**Auto** is the recommended mode.) See “Connecting an HDMI or DVI device to the HDMI input” (page 16).

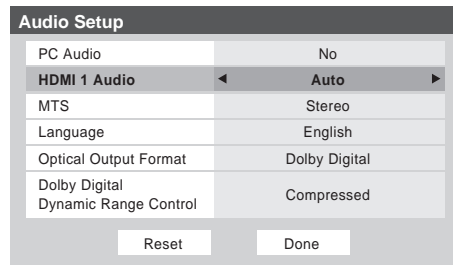

Mode	Description
Auto	When viewing the HDMI 1 input, if digital audio from the HDMI input is available, it will be output. If not, the TV will automatically detect and output analog audio from the PC Audio input.
Digital	When viewing the HDMI 1 input, digital audio from the HDMI input will be output.
Analog	When viewing the HDMI 1 input, analog audio from the PC Audio input will be output.

- 3 To save your settings, highlight **Done** and press **ENTER**.

Note: Because the PC and HDMI 1 inputs share the same set of analog audio inputs, the **PC Audio** menu setting influences the **HDMI 1 Audio** menu setting. If **PC Audio** is set to “No,” the **HDMI 1 Audio** setting changes to “Auto.” If **PC Audio** is set to “Yes,” the **HDMI 1 Audio** setting is set to “Digital” and is grayed out in the menu. (Also see item 4 on page 11 and “Setting the PC Audio” on page 50.)

Viewing the digital signal meter

You can view the digital signal meter in the ANT/CABLE digital TV input source only.

To view the digital signal meter:

- 1 From the **Setup** menu, highlight **Installation** and press **ENTER**. A new set of Installation menu icons will appear.
- 2 Open the **Terrestrial** menu, highlight **Signal Meter**, and press **ENTER**.
- 3 Press **▲▼◀▶** to select the antenna input and digital channel whose signal you want to check.

Note:

- The physical digital channel number listed in the Signal Meter screen may not correspond to a virtual TV channel number. Contact your local broadcasters to obtain the RF channel numbers for your local digital stations.
- The signal strength does not change between virtual channels on the same physical channel.

To close the screen and return to the Terrestrial menu:

Highlight **Done** and press **ENTER**.

To return to normal viewing:

Press **EXIT**.

Setting the time zone

The Time Zone setup will allow you to specify the correct time zone for your region. This feature will allow the TV status information to show the correct time zone information (see page 54).

To set the time zone:

- 1 From the **Setup** menu, highlight **Installation** and press **ENTER**. A new set of Installation menu icons will appear.
- 2 Open the **Time Zone** menu, highlight **Time Zone Setup**, and press **ENTER**.
- 3 Press **◀** or **▶** to select the region, highlight **Done**, and then press **ENTER**.

After the time zone has been set, you will be asked to set the current Daylight Saving Time status.

To set the Daylight Saving Time status:

- 1 Press **◀** or **▶** to select **Yes** or **No**, highlight **Done**, and then press **ENTER**.

Viewing the system status

To view the system status:

- 1 From the **Setup** menu, highlight **Installation** and press **ENTER**. A new set of Installation menu icons will appear.
- 2 Open the **System Status** menu, highlight **System Information**, and press **ENTER**.
- 3 Press **◀▶** to scroll through the menu bar to select the **Software Version** and view the related information.

To close the screen and return to the Installation menu:

Highlight **Done** and press **ENTER**.

To return to normal viewing:

Press **EXIT**.

Reset Factory Defaults

To reset all settings and channels to their factory default values:

- 1 From the **Setup** menu, highlight **Installation** and press **ENTER**. A new set of Installation menu icons will appear.
- 2 Open the **System Status** menu, highlight **System Information**, and press **ENTER**.
- 3 Press **◀▶** to scroll through the menu bar to select **Factory Defaults**.
- 4 Enter your PIN code (or 0000 if no PIN code has been set).
- 5 Highlight **Yes** and press **ENTER**. The TV will turn off automatically after a few seconds. After the TV turns off, unplug the TV power cord and then plug it in again to complete the reset process.

To cancel the reset:

Highlight **No** and press **ENTER**.

Selecting the Power-On Mode

You can select either **Power-Saving** or **Fast** mode.

- **Power-Saving** mode keeps power consumption in standby mode to below 3W. As a result, it takes a bit longer for the TV to turn on.
- **Fast** mode increases power consumption in standby mode. As a result, the TV will turn on more quickly. While in **Fast** mode, the yellow LED on the front of the TV will be lit.

To set the Power-On Mode feature:

- 1 From the **Setup** menu, highlight **Power-On Mode** and press **▶**.
- 2 Press **▲** or **▼** to select either **Power-Saving** or **Fast**, and press **ENTER**.

To return to normal viewing:

Press **EXIT**.

Chapter 6: Using the TV's features

Selecting the video input source to view

To select the video input source to view:

- 1 Press **INPUT** on the remote control or TV control panel.
- 2 And then either:
 - a) Press 0–9; or
 - b) Repeatedly press **▲▼** on the remote control and then press **ENTER** to change the input; or
 - c) Repeatedly press **INPUT** on the remote control or TV control panel to change the input.The current signal source displays in the top right corner of the **Input Selection** screen.

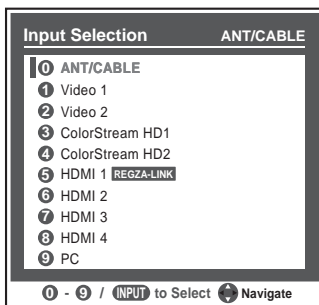

Note:

- You can label the video input sources according to the specific devices you have connected to the TV (see “Labeling the video input sources” at right).
- Sources can also be “hidden” (see “Labeling the video input sources” at right).
- “No Video Signal” will appear randomly on the screen if no signal is received in video input mode.
- If a CEC device is connected to an HDMI input, the REGZA-LINK icon will appear.

If a REGZA-LINK device with HDMI switching capability (e.g. Audio Receiver) is connected to the HDMI input:

Press **INPUT** on the remote or TV control panel repeatedly to highlight **HDMI 1**, **HDMI 2**, **HDMI 3**, or **HDMI 4**.

If the connected CEC device has any connected devices, a separate device selection popup window will appear.

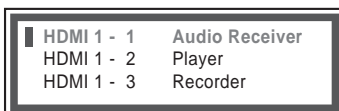

Press **INPUT** repeatedly to highlight the desired input source, and then press **EXIT**.

Note:

- When selecting REGZA-LINK input sources from the popup window using **INPUT**, some REGZA-LINK devices may automatically turn on.
- When selecting input sources using **▲▼**, you will have to press **ENTER** to actually select a particular device from the popup window.

Labeling the video input sources

You can label each video input source according to the type of device you connected to each source, from the following preset list of labels:

- -- (default label)
- Audio Receiver
- Cable
- Compact Disc
- DTV
- DVD
- Game Console
- HD DVD
- HDMI Switch (HDMI inputs only)
- Laser Disk
- Satellite/DSS
- VCR
- Video Recorder
- Hide (to hide an unused input in the **Input Selection** screen and in the Channel Browser Inputs list)

Note: If you select PC in the Input Selection screen, you can choose only “--”, “Game Console”, or “Hide” as the label.

To label the video input sources:

- 1 Press **MENU** and open the **Preferences** menu.
- 2 Highlight **Input Labeling** and press **ENTER**.

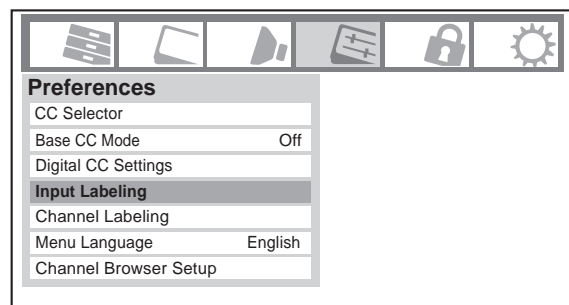

- 3 Press **▲** or **▼** to highlight the video source you want to label.

(continued)

- 4 Press ◀ or ▶ to select the desired label for that input source. If a particular input is not used, you can select **Hide** as the label, which will cause that input to be “grayed out” in the Input Selection screen and skipped over when you press (INPUT) on the remote control.
- 5 To save the new input labels, highlight **Done** and press (ENTER).
To revert to the factory default labels, highlight **Reset** and press (ENTER).

Input labeling example:

The screen below left shows the default **Input Selection** screen (with none of the inputs labeled as a specific device). The screen below right is an example of how you could label the inputs if you connected a VCR to VIDEO 1, Cable TV to VIDEO 2, a video recorder to ColorStream HD1, a DTV set-top box to HDMI 1, a satellite/DSS set-top box to HDMI 2, a DVD player to HDMI 3, and an HD DVD player to HDMI 4. Also note that the ColorStream HD2 input is labeled “Hidden,” which means that input will be skipped over when (INPUT) is pressed.

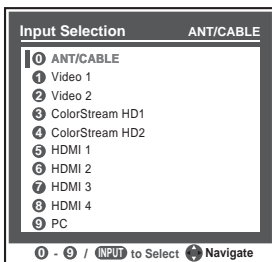

Input Selection screen with no inputs labeled.

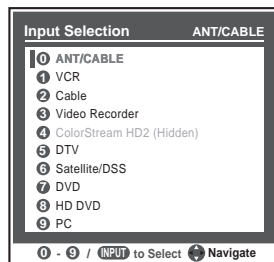

Input Selection screen with all inputs labeled except input 4, which has been hidden.

To clear the input labels:

- 1 From the **Preferences** menu, highlight **Input Labeling** and press (ENTER).
- 2 Highlight **Reset** and press (ENTER).

Tuning channels

Tuning channels using the Channel Browser™

The Channel Browser™ provides an easy navigation interface for all your channels and inputs. This feature allows you to:

- Navigate the contents of all of your inputs.
- Keep a list of your favorite channels (see “Favorites Browser,” below).
- Keep a history of the last 32 channels or inputs viewed.
- Quickly surf and tune your recently viewed channels/inputs from the Channel Browser™ History List (illustrated on the next page).
- Surf via Browse mode (to immediately tune channels as you highlight them in the Channel Browser™) or Select mode (to surf over channels in the Channel Browser™ before you select one to tune).
- Quickly change inputs from the Inputs List.
- Quickly select REGZA-LINK devices from the REGZA-LINK List.

Favorites Browser

The Favorites Browser allows you to quickly set up a favorite channels/inputs list that is integrated into the Channel Browser™.

To add a favorite channel/input:

- 1 Tune to the channel or input.
- 2 Press and hold FAV BROWSER on the remote control for 3 seconds.

Note: Additions are added to the beginning of the Favorites list on the left side of the Channel Browser™.

To delete a favorite channel/input:

- 1 Press FAV BROWSER to open the Favorites browser list.
- 2 Highlight the channel or input to delete by pressing BACK ◀ or ▶ NEXT.
- 3 Press and hold (100) for 3 seconds. The channel/input will be removed from the Favorites list.

To set up the Channel Browser™:

- 1 From the **Preferences** menu, highlight **Channel Browser Setup** and press **ENTER**.
- 2 Press **▲** to highlight **Navigation**, and then press **◀** or **▶** to select either **Browse Mode** or **Select Mode**.

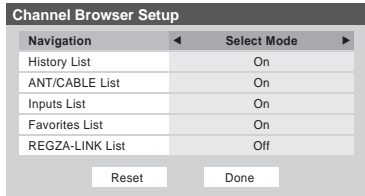

- 3 Press **▼** to highlight **History List**, and then press **◀** or **▶** to select the setting you prefer: either **On** or **Off**.

Note: *History List* will be cleared every time the TV is powered off.

- 4 Press **▼** to highlight **ANT/CABLE List**, and then press **◀** or **▶** to select **On** or **Off**.

- 5 Press **▼** to highlight **Inputs List**, and then press **◀** or **▶** to select **On** or **Off**.

- 6 Press **▼** to highlight **Favorites List**, then press **◀** or **▶** to select **On** or **Off**.

- 7 Press **▼** to highlight **REGZA-LINK List**, and then press **◀** or **▶** to select **On** or **Off**.

Note: *REGZA-LINK List* will be automatically grayed out and set to **Off** when **Enable REGZA-LINK** is switched to **Off**. (See "To set the REGZA-LINK Setup" on page 53 for more information.)

- 8 To save your entries, highlight **Done** and press **ENTER**. To return to factory defaults, highlight **Reset** and press **ENTER**.

To open the Channel Browser™:

- Press **BACK** or **NEXT** on the remote control.
- Press **BACK** to surf backward through the previously tuned 32 channels in the History list, the channels in the ANT/CABLE channel list, the inputs in the Inputs list, the REGZA-LINK devices in the REGZA-LINK list, or the favorite channels/inputs in the Favorites list.
- Press **NEXT** to surf forward through the channel History, the ANT/CABLE channel list, the Inputs list, the REGZA-LINK list, or the favorite channels/inputs in the Favorites list.

Elements of the Channel Browser™

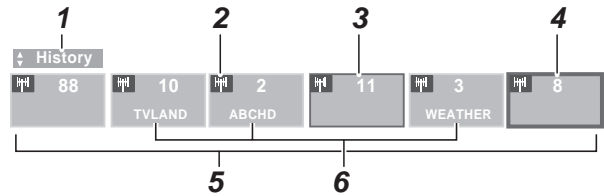

- 1 Current list (**History**, **ANT/CABLE**, **Inputs**, **Favorites**, or **REGZA-LINK**)
- 2 Input type
- 3 Channel or input currently being viewed
- 4 Channel or input that is currently highlighted in the browser
- 5 Channels stored in the History List
- 6 Channel labels

To toggle among the available lists:

After opening the Channel Browser™, press **▲** or **▼** to toggle among **History**, **ANT/CABLE**, **Inputs**, **Favorites**, and **REGZA-LINK**.

Note:

- The Channel Browser™ opens in **History List** by default. Once another list has been selected, the Channel Browser™ will open in the last selected list.
- If all lists are turned off, pressing **BACK**, **NEXT**, or **FAV BROWSER** will not display the Channel Browser™. If **Favorites List** is turned off, **FAV BROWSER** will have no effect.
- Pressing **FAV BROWSER** will bring up the Channel Browser™ Favorites list regardless of the last selected list in the Channel Browser™.

To tune to a channel or input in Browse mode:

- 1 While watching TV, press **BACK** or **NEXT** to open the Channel Browser™ and surf back to a previous item or surf forward to the next item in the list.
In **Browse** mode, when you stop on an item in the Channel Browser™, it will be highlighted and the TV will automatically tune to the channel or input.
- 2 Press **EXIT** to close the Channel Browser™.

To tune to a channel or input in Select mode:

- 1 While watching TV, press **BACK** or **NEXT** to open the Channel Browser™ and surf back to a previous item or forward to the next item in the list.
In **Select** mode, when you stop on an item in the Channel Browser™, it will be highlighted but you must press **ENTER** to tune the TV to the highlighted item.
- 2 Press **ENTER** to tune the TV to the highlighted item.
- 3 Press **EXIT** to close the Channel Browser™.



(continued)

Adding and clearing channels and inputs in the History List

Adding channels and inputs to the History List:

As a channel or input is tuned, the Channel Browser™ adds it to the History List and displays it on the “right side” of the Channel Browser™. Previously tuned channels/inputs are “shifted” to the left, eventually moving off the left side. Press  to surf backward through the previously tuned channels/inputs. Any channel or input that is tuned repeatedly will not be repeated in the History List, but instead is moved to the end of the list on the right side of the Channel Browser™.

The Channel Browser™ will store the following channels:

- All channels that are tuned using the numeric buttons on the remote control.
- All channels that are tuned using  or  on the remote control.

Note: Whenever an item is selected that cannot be tuned (for various reasons), the TV will automatically tune to the previously viewed channel or input.

Clearing channels from the History List:

- Reconfiguring the **ANT/CABLE** input will clear the History List.

Note: See page 29 for details on configuring the antenna input.



- Once 32 channels or inputs are stored in the History List, the oldest item will be removed from the list when a new channel or input is tuned.
- Turning off the TV will clear the History List.

Setting the Channel Tuning Mode

This feature allows you to choose how tuning will be handled for analog and digital channels when the TV is in Antenna mode.





Note: To use this feature, the **Input Configuration** must be set to **Antenna** (see page 29).

The channel tuning mode has three options.

Mode	Description
Standard	Both analog and digital channels can be tuned normally
Auto (default)	Digital channels will have priority when manually entering a channel number using the Channel Number (0-9) on the remote control, analog channels can still be tuned by  /  if available
Digital	Only digital channels can be tuned

Note: Digital mode will be most useful after analog channels are shut down by the government in 2009.

To set the Channel Tuning Mode:



- 1 From the **Setup** menu, highlight **Installation** and press . A new set of **Installation** menu icons will appear.
- 2 Open the **Terrestrial** menu, highlight **Channel Tuning Mode**, press  and  to select your desired mode, and then press .

Note:

- The Channel Add/Delete & Channels Block windows as well as the Channel Browser ANT/CABLE list will be updated automatically when you change the mode. Also, the History List will be cleared, but the Favorites List will be saved.
- Even if the Channel Tuning Mode is set to **Digital**, analog channel 3 will still be the default channel to prevent the initial case where no digital channels have been found in prior channel scans. (Channel Add/Delete will not have anything listed until a scan is done.)

Tuning to the next programmed channel

To tune to the next programmed channel:

Press  or  on the remote control or TV control panel.



Note: This feature will not work unless you program channels into the TV's channel memory (see page 30).

Tuning to a specific channel (programmed or unprogrammed)

Tuning analog channels:

Press the Channel Number (0–9) on the remote control. For example, to select channel 125, press 1, 2, 5, then .

Tuning digital channels:

Press the Channel Number (0–9) on the remote control, followed by the dash () button and then the sub-channel number. For example, to select digital channel 125-1, press 1, 2, 5, –, 1, then .

Note: If a digital channel is not programmed—either through the automatic channel scan (see page 30) or the channel add/delete function (see page 30)—you will have to tune the RF channel using the Channel Number and dash () on the remote control.

Switching between two channels using Channel Return

The Channel Return feature allows you to switch between two channels without entering an actual channel number each time.

- 1 Select the first channel you want to view.
- 2 Select a second channel using the Channel Number buttons (and the dash (100) button if selecting a digital channel).
- 3 Press **CH RTN** on the remote control. The previous channel will display. Each time you press **CH RTN**, the TV will switch back and forth between the last two channels that were tuned.

Note: If you press **CH RTN** from a non-antenna input, the TV will return to the last-viewed input.

Switching between two channels using SurfLock™

The SurfLock™ feature temporarily “memorizes” one channel to the **CH RTN** button, so you can return to that channel quickly from any other channel by pressing **CH RTN**. To memorize a channel to the **CH RTN** button:

- 1 Tune the TV to the channel you want to program into the **CH RTN** button.
- 2 Press and hold **CH RTN** for about 2 seconds until the message “Memorized” appears on-screen. The channel has been programmed to the **CH RTN** button.
- 3 You can then change channels repeatedly, and when you press **CH RTN**, the memorized channel will be tuned.

The TV will return to the memorized channel one time only. Once you press **CH RTN** and then change channels again, the CH RTN memory will be cleared and the button will function as Channel Return, by switching back and forth between the last two channels that are tuned. This feature also works for external inputs.

Selecting the picture size

You can view many program formats in a variety of picture sizes—**Natural**, **TheaterWide 1**, **TheaterWide 2**, **TheaterWide 3**, **Full**, **4:3 HD**, **Native** and **Dot by Dot**.

Note: The “picture size” illustrations are examples only. The format of the image (in any of the picture sizes) will vary depending on the format of the signal you are currently watching. Select the picture size that displays the current program the way that looks best to you.

You can save separate picture size preferences for each input on your TV.

To select the picture size using the remote control:

- 1 Press **PIC SIZE** on the remote control.
- 2 While the **Picture Size** screen is open, you can do one of the following to select the desired picture size:
 - Repeatedly press **PIC SIZE**.
 - Press the corresponding Number button (0–6) while the **Picture Size** screen is open.
 - Press **▲** or **▼** while the **Picture Size** screen is open.

To select the picture size using the menus:

- 1 Select **Picture Size** in the **Theater Settings** menu.
- 2 Press **◀** or **▶** to select the desired picture size setting.
- 3 Highlight **Done** and press **ENTER**.

Note: Some of the picture sizes may not be available depending on the receiving signal format (those will be “grayed out” in the **Picture Size** screen).

Using these functions to change the picture size (i.e., changing the height/ width ratio) for any purpose other than your private viewing may be prohibited under the Copyright Laws of the United States and other countries, and may subject you to civil and criminal liability.

Note: If you select one of the TheaterWide® picture sizes, the top and bottom edges of the picture (including subtitles or captions) may be hidden. To view the hidden edges, either scroll the picture (**TheaterWide 2** and **3** only) or try viewing the program in **Full** or **Natural** picture size.

(continued)

Picture Size

Natural

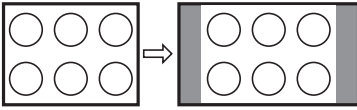

Some program formats will display with sidebars and/or bars at the top and bottom.

TheaterWide 1
(for 4:3 format programs)

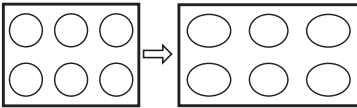

The center of the picture remains close to its original proportion, but the left and right edges are stretched wider to fill the screen.

TheaterWide 2
(for letter box programs)

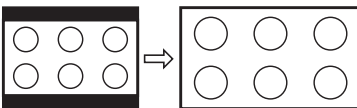

The top and bottom edges of the picture may be hidden*.

TheaterWide 3
(for letter box programs with subtitles)

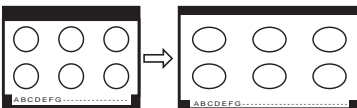

The top and bottom edges are hidden*.

Full
(for 16:9 [480i, 480p] source programs only)

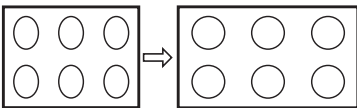

- If receiving a squeezed 4:3 format program, the picture is stretched wider to fill the width of the screen, but not stretched taller.
- None of the picture is hidden.

Picture Size

4:3 HD
(for 720p, 1080i, and 1080p program sources only)

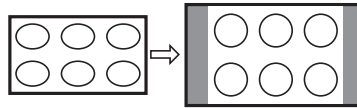

Picture is not distorted from original size.

Native
(for 480i (HDMI), 480p (HDMI), 720p, 1080i, and 1080p signal programs)

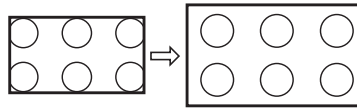

- If receiving a 480i (HDMI), 480p (HDMI), 720p, 1080i, or 1080p signal program, Native mode scales the video to display the entire picture within the borders of the screen (i.e. no overscanning).
- This is especially useful for external HD sources such as HD-DVD, DVHS movies, or PC graphics.

Note:

- This mode is supported only for HDMI (1080p, 1080i, 720p, 480p, and 480i), ColorStream (1080i and 720p), and ANT/CABLE (digital) inputs (1080p, 1080i, and 720p).
- Depending on the input signals, the border of the picture may be hidden, displayed in black, or noisy.

Dot by Dot
(for VGA, SVGA, XGA, WXGA, and SXGA sources only)

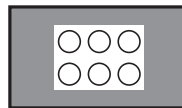

“Dot by Dot” is a non-scaling display. Depending on the input signal format, the picture is displayed with sidebars and/or bars at the top and bottom. (Example: VGA input source)

* To view the hidden areas (such as subtitles or captions), see “Scrolling the TheaterWide® picture” (page 41).

Scrolling the TheaterWide® picture (TheaterWide 2 and 3 only)

You can set separate scroll settings for the TheaterWide 2 and TheaterWide 3 modes for each input.

To set the scroll settings:

- 1 Press **MENU** and open the **Video** menu.
- 2 Highlight **Theater Settings** and press **ENTER**.

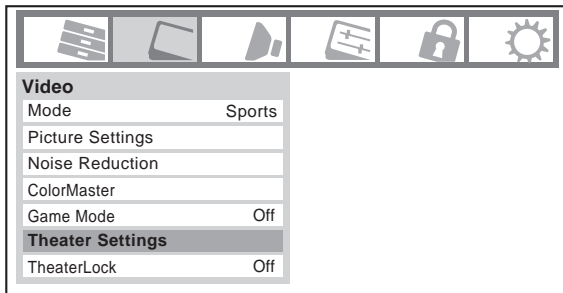

- 3 In the **Picture Size** field, select either **TheaterWide 2** or **TheaterWide 3** (you cannot scroll in any other mode).
- 4 Press **▼** to highlight the **Picture Scroll** field.
- 5 Press **◀** or **▶** to scroll the picture up and down as needed, from -10 to +20.
- 6 To save the new settings, highlight **Done** and press **ENTER**. To revert to the factory defaults, highlight **Reset** and press **ENTER**.

Using the auto aspect ratio feature

When the auto aspect ratio feature is set to **On**, the TV will automatically select the picture size when one of the following input sources is received:

- A 480i, 480p, 720p, 1080i digital signal from the **ANT/CABLE** input
- A 480i signal from the **Video 1** or **Video 2** input
- A 480i, 480p, 720p, 1080i signal from the **ColorStream HD1** or **HD2** input
- A 480i, 480p, 720p, 1080i, 1080p, or VGA (60/72/75Hz) signal from the **HDMI 1/2/3/4** input

Aspect ratio of signal source	Automatic aspect size (automatically selected when Auto Aspect is On)
4:3 normal	Natural (with sidebars)
4:3 letter box	TheaterWide 2
16:9 full	Full
Not defined (no ID-1 data or HDMI aspect data)	The current picture size you set under "Selecting the picture size" on page 39.

Note: The auto aspect ratio feature is not applicable to the PC input.

To turn on the auto aspect ratio feature:

- 1 From the **Video** menu, highlight **Theater Settings** and press **ENTER**.
- 2 In the **Auto Aspect Ratio** field, select **On**.
- 3 To save the new settings, highlight **Done** and press **ENTER**. To revert to the factory defaults, highlight **Reset** and press **ENTER**.

To turn off the auto aspect ratio feature:

Select **Off** in step 2 above.

Selecting the cinema mode (480i and 1080i signals)

When you view a DVD (3:2 pulldown processed) from a DVD player connected to the **Video 1**, **Video 2**, **ColorStream HD1**, **ColorStream HD2** (component video), or **HDMI** inputs on the TV, smoother motion can be obtained by setting the **Cinema Mode** to **Film**.

To set the Cinema Mode to Film:

- 1 From the **Video** menu, highlight **Theater Settings** and press **ENTER**.
- 2 In the **Cinema Mode** field, select **Film**.
- 3 To save the new settings, highlight **Done** and press **ENTER**. To revert to the factory defaults, highlight **Reset** and press **ENTER**.

To set the Cinema Mode to Video:

Select **Video** in step 2 above.

Using the FREEZE feature

To use the FREEZE feature:

- 1 When viewing the TV, press **FREEZE** to make the picture a still picture.
- 2 To return to the moving picture, press **FREEZE** again (or any other button).

Note: If the TV is left in FREEZE mode for more than 15 minutes, the FREEZE mode will automatically be released and the TV will return to moving picture.

Using the FREEZE function for any purpose other than your private viewing may be prohibited under the Copyright Laws of the United States and other countries, and may subject you to civil and criminal liability.

Adjusting the picture

Selecting the picture mode

You can select your desired picture settings from the following modes, as described below.

Mode	Picture Quality
Sports	Bright and dynamic picture
Standard	Standard picture settings
Movie	Lower contrast for darkened room
PC	Designed for viewing of PC tables and documents
Preference	Your personal preferences

Note: PC mode is available for HDMI and PC inputs only (grayed out for other input sources).

- 1 From the **Video** menu, highlight **Mode** and press **ENTER**.
- 2 Press **▲** or **▼** to select the picture mode you prefer and press **ENTER**.

Note: The picture mode you select affects the current input only. You can select a different picture mode for each input.

Adjusting the picture quality

You can adjust the picture quality (Contrast, Backlight, DynaLight™, Brightness, Color, Tint, and Sharpness) to your personal preferences.

Selection	Pressing ◀	Pressing ▶
Contrast	lower	higher
Backlight*	darker	lighter
DynaLight**	On/Off	On/Off
Brightness	darker	lighter
Color	paler	deeper
Tint	reddish	greenish
Sharpness	softer	sharper

* Backlight
This feature adjusts the brightness of the entire screen. When in video mode and no signal is input, this will automatically be set to 0. (Settings are stored in memory.)

**DynaLight
This function automatically strengthens the black coloring of dark areas in the video according to the level of darkness.

To adjust the picture quality:

- 1 From the **Video** menu, highlight **Picture Settings** and press **ENTER**.
- 2 Press **▲** or **▼** to select the picture quality you want to adjust (**Contrast, Backlight, DynaLight, Brightness, Color, Tint, or Sharpness**), and then press **◀** or **▶** to adjust the setting, as described in the table above.
- 3 To save the new settings, highlight **Done** and press **ENTER**. You can use any of the picture modes (ⓘ “Selecting the picture mode,” above left) as a starting point for adjusting the picture settings.
To revert back to the base mode that you began adjusting the picture settings from, highlight **Reset** and press **ENTER**.

The picture qualities you adjusted are automatically saved in the **Preference** mode (ⓘ “Selecting the picture mode,” above left) until **Reset** is selected.

Using the TheaterLock™ feature

The TheaterLock™ feature allows you to “lock” all items that affect the picture mode setting. In other words, those settings that when adjusted cause the Mode setting to automatically change to “Preference” will be grayed out and unavailable when the TheaterLock setting is set to “On”. Items that do not influence Mode status will not be affected e.g., Noise Reduction, Game Mode, etc.

To turn on TheaterLock™:

- 1 From the **Video** menu, press **▲** or **▼** to highlight the **TheaterLock** field, press **▶** and **▲▼** to select **On**, and press **ENTER**.

To turn off TheaterLock™:

Select **Off** in step 1 above.

Using the closed caption mode**Base closed captions**

The closed caption mode has two options:

- **Captions**—An on-screen display of the dialogue, narration, and sound effects of TV programs and videos that are closed captioned (usually marked “CC” in program guides).
- **Text**—An on-screen display of information not related to the current program, such as weather or stock data (when provided by individual stations).

To view captions or text:

- 1 From the **Preferences** menu, highlight **Base CC Mode** and press **▶**.
 - 2 Press **▲** or **▼** to select the desired closed caption mode and press **ENTER**.
- **To view captions:**
Highlight **CC1, CC2, CC3, or CC4**. (**CC1** displays translation of the primary language in your area.)



Note: If the program or video you selected is not closed captioned, no captions will display on-screen.

- **To view text:**
Highlight **T1, T2, T3, or T4**.

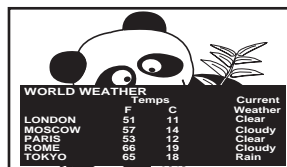

Note: If text is not available in your area, a black rectangle may appear on screen. If this happens, set the Base CC Mode to **Off**.

- **To turn off the closed caption mode:**
Select **Off** in step 2 above.

Note: A closed caption signal may not display in the following situations:

- When a videotape has been dubbed
- When the signal reception is weak
- When the signal reception is non-standard

Digital CC Settings

You can customize the closed caption display characteristics by changing the background color, opacity, text size, type, edge, and color.

(continued)

Note:

- This feature is available for digital channels only.
- You cannot set the Caption Text and Background as the same color.

Mode	Description
Caption Size	Auto, Small, Standard, Large
Caption Text Type	Auto, Default, Mono w. Serif, Prop. w. Serif, Mono w/o Serif, Prop. w/o Serif, Casual, Cursive, Small Capitals
Caption Text Edge	Auto, None, Raised, Depressed, Uniform, Left Drop Shadow, Right Drop shadow
Caption Text Color	Auto, Black, White, Red, Green, Blue, Yellow, Magenta, Cyan
Text Foreground Opacity	Auto, Transparent, Translucent, Flashing, Solid
Background Color	Auto, Black, White, Red, Green, Blue, Yellow, Magenta, Cyan
Text Background Opacity	Auto, Transparent, Translucent, Flashing, Solid
Caption Text Edge Color	Auto, Black, White, Red, Green, Blue, Yellow, Magenta, Cyan

To customize the closed captions:

- 1 From the **Preferences** menu, highlight **Digital CC Settings** and press **ENTER**.
- 2 Press **▲** or **▼** to highlight the characteristic you want to change, and then press **◀** or **▶** to select the format for that characteristic (see table above).
- 3 To save the new settings, highlight **Done** and press **ENTER**. To revert to the factory defaults, highlight **Reset** and press **ENTER**.

CC Selector

You can use the **CC Selector** to temporarily override the default analog caption mode (set in **Base CC Mode**) for a particular channel. However, once you change to another analog channel, the closed caption setting will automatically change back to the current **Base CC Mode** setting.

You can also use the **CC Selector** to select digital closed caption services (if available). When such services are not available, the **CC Selector** presents a default list of services. If the selected service is not available, the next best service will be used instead.

To select closed captions:

- 1 From the **Preferences** menu, highlight **CC Selector** and press **ENTER**.
- 2 Press **▲** or **▼** to select **Closed Caption**, and then press **◀** or **▶** to select the desired service.
- 3 Press **EXIT**.

Adjusting the audio

Muting the sound

Press **MUTE** on the remote control to partially reduce (1/2 MUTE) or turn off (MUTE) the sound. Each time you press **MUTE**, the mute mode will change in the following order:



If the closed caption mode is set to **Off** when you select “MUTE” mode, the closed caption feature is automatically activated if the TV program is Closed Captioned. To mute the audio without automatically activating the closed caption feature, use **Vol** to set the volume to 0. See “Using the closed caption mode” (page 43) for more information on closed caption modes.

Using the digital audio selector

You can use the **Digital Audio Selector** to conveniently switch between audio tracks on a digital channel (for those channels that have multiple audio tracks). This temporarily overrides the audio track chosen by the language option under **Audio Setup** (“Selecting stereo/SAP broadcasts” on page 45).

To use the digital audio selector:

- 1 Press **MENU** and open the **Audio** menu.
- 2 Highlight **Digital Audio Selector** and press **ENTER**.

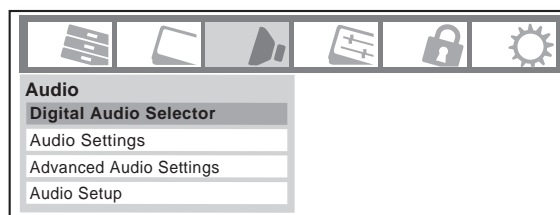

- 3 Press **▲** or **▼** to select **Audio**, and then press **◀** or **▶** to select the desired service.
- 4 Press **EXIT**.

Selecting stereo/SAP broadcasts

The multi-channel TV sound (MTS) feature allows you to output high-fidelity stereo sound. MTS also can transmit a second audio program (SAP) containing a second language, music, or other audio information (when provided by individual stations).

When the TV receives a stereo or SAP broadcast, the word "STEREO" or "SAP" appears on-screen when **RECALL** is pressed. The MTS feature is only available for analog signals on the **ANT/CABLE** input.

To listen to stereo sound:

- 1 From the **Audio** menu, highlight **Audio Setup** and press **ENTER**.
- 2 In the **MTS** field, select **Stereo**.
- 3 To save the new settings, highlight **Done** and press **ENTER**. To reset the settings to the factory defaults, highlight **Reset** and press **ENTER**.

Note:

- You can typically leave the TV in **Stereo** mode because it will automatically output the type of sound being broadcast (stereo or monaural).
- If the stereo sound is noisy, select **Mono** to reduce the noise.

To listen to an alternate language on an ATSC digital station (if available):

Highlight the **Language** field in step 2 above, and then press **◀** or **▶** to select the language you prefer.

To listen to a second audio program on an analog station (if available):

Select **SAP** in step 2.

Note:

- A second audio program (SAP) can be heard only on those TV stations that offer it. For example, a station might broadcast another language as a second audio program. If you have SAP on, you will see the current program on the screen but hear the other language instead of the program's normal audio.
- If you have SAP on and the station you are watching is not broadcasting a second audio program, the station's normal audio will be output. However, occasionally there is no sound at all in **SAP** mode. If this happens, set the **MTS** feature to **Stereo** mode.

Adjusting the audio quality

You can adjust the audio quality by adjusting the bass, treble, and balance.

To adjust the audio quality:

- 1 From the **Audio** menu, highlight **Audio Settings** and press **ENTER**.
- 2 Press **▼** or **▲** to highlight the item you want to adjust (**Bass**, **Treble**, or **Balance**).
- 3 Press **◀** or **▶** to adjust the level.
 - **◀** makes the bass or treble weaker or increases the balance in the left channel (depending on the item selected).
 - **▶** makes the bass or treble stronger or increases the balance in the right channel (depending on the item selected).
- 4 To save the new settings, highlight **Done** and press **ENTER**. To reset the settings to the factory defaults, highlight **Reset** and press **ENTER**.

Using the StableSound® feature

The StableSound® feature limits the highest volume level to prevent extreme changes in volume when the signal source changes (for example, to prevent the sudden increase in volume that often happens when a TV program switches to a commercial).

To turn on the StableSound® feature:

- 1 From the **Audio** menu, highlight **Audio Settings** and press **ENTER**.
- 2 In the **StableSound** field, select **On**.
- 3 To save the new settings, highlight **Done** and press **ENTER**. To revert to the factory defaults, highlight **Reset** and press **ENTER**.

Note: The **RESET** function returns your audio adjustments to the following factory settings:

```
Bass . . . . . center (50)
Treble . . . . . center (50)
Balance . . . . . center (0)
StableSound . . Off
```

Note: This feature will be gray out in digital channels, to turn it **On** or **Off**, it's necessary to be tuned in an analog channel.

To turn off the StableSound feature:

Select **Off** in step 2 above.

(continued)

Selecting the optical audio output format

You can use this feature to select the optical audio output format when you connect a Dolby Digital decoder or other digital audio system to the **DIGITAL AUDIO OUT** terminal on the TV (see “Connecting a digital audio system” on page 18).

To select the optical audio output format:

- 1 From the **Audio** menu, highlight **Audio Setup** and press **ENTER**.
- 2 In the **Optical Output Format** field, select either **Dolby Digital** or **PCM**, depending on your device.
- 3 To save the new settings, highlight **Done** and press **ENTER**. To revert to the factory defaults, highlight **Reset** and press **ENTER**.

Using the Dolby® Digital Dynamic Range Control feature

This dynamic range control feature causes the ATSC dynamic range to be further compressed, allowing you to switch from digital to analog broadcasts at the same dynamic range.

To use the Dolby Digital Dynamic Range Control:

- 1 From the **Audio** menu, highlight **Audio Setup** and press **ENTER**.
- 2 In the **Dolby Digital Dynamic Range Control** field, select **Compressed**. When **Standard** is selected, the audio is output with minimal compression.
- 3 To save the new settings, highlight **Done** and press **ENTER**. To revert to the factory defaults, highlight **Reset** and press **ENTER**.

Note:

- This item will be grayed out for NTSC signals, Video, ColorStream, HDMI, and PC inputs.
- The Dolby Digital Dynamic Range Control will function in relation to Optical Output Format (PCM mode).

Using the Locks menu

The Locks menu includes the Enable Rating Blocking, Edit Rating Limits, Channels Block, Input Lock, Control Panel Lock, Game Timer, and New PIN Code features. You can use these features after entering the correct PIN code.

Entering the PIN code

- 1 On the remote control or TV control panel, press **MENU** and highlight the **Locks** menu icon.

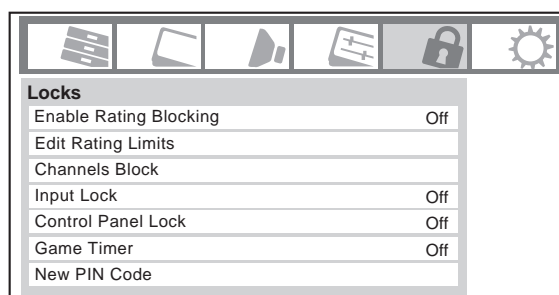

- 2 Press **▼**, which displays the PIN code entry screen.
 - The **Lock System** screen (below) appears if a PIN code has not been stored. Press the Channel Number buttons to enter a new four-digit code, enter the code a second time to confirm, and press **ENTER**.

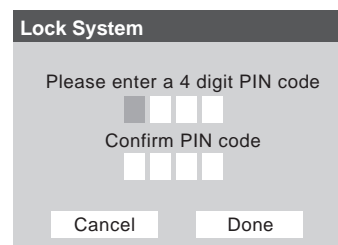

- The **Locks/Active** screen appears if the PIN code is already stored. Use the Number buttons to enter your four-digit code and press **ENTER**.

If the wrong PIN code is entered, the message “Incorrect PIN code, please try again!” appears. Highlight **Retry** and press **ENTER**. Enter the code again and press **ENTER**.

When the correct PIN code is entered, the **Locks** menu opens.

If you cannot remember your PIN code

While the PIN code entering screen is displayed, press **RECALL** four times within five seconds. The PIN code will be cleared and you can enter a new PIN code.

Changing your PIN code

- 1 From the **Locks** menu, press ▼ to display the PIN code entering screen.
- 2 Enter your four-digit PIN code and press **ENTER**.
- 3 Press ▼ to highlight **New PIN Code** and press **ENTER**.
- 4 Press the Number buttons to enter a new four-digit code. Reenter the PIN code to confirm it.
- 5 Press **ENTER**. The new PIN code is now active.

Blocking TV programs and movies by rating (V-Chip)

Some TV programs and movies include signals that classify the content of the program (violence, sex, dialog, language). The V-Chip feature in this TV detects the signals and blocks the programs according to the ratings you select. (For rating descriptions, see the tables on the next page.)

Note: Rating blocking is a function of the V-Chip feature in this TV, which supports the U.S. V-Chip system only.

To block and unblock TV programs and movies:

- 1 From the **Locks** menu, press ▼ to display the PIN code entering screen.
- 2 Enter your four-digit PIN code and press **ENTER**.
- 3 Press ▼ to highlight **Enable Rating Blocking**.
- 4 Press ► and ▼ to select **On**, and then press **ENTER**.
- 5 Press ▼ to highlight **Edit Rating Limits** and press **ENTER**. The **Edit Rating Limits** screen appears.
- 6 Press ▲▼◀▶ and then press **ENTER** to select the level of blocking you prefer. A box with an "X" is a rating that will be blocked. As you highlight a rating, a definition for the rating appears at the bottom of the screen.
- 7 When done selecting the ratings you want to block, highlight **Done** and press **ENTER**.

Downloading an additional rating system for blocking TV programs and movies

In the future, an additional rating system may become available for use in selectively blocking programs.

Note: The currently tuned station must be receiving a digital signal before an additional rating system can be downloaded.

To download the additional rating system (if available):

- 1 From the **Locks** menu, press ▼ to display the PIN code entering screen.
- 2 Enter your four-digit PIN code and press **ENTER**.
- 3 Press ▼ to highlight **Enable Rating Blocking**.
- 4 Press ► and ▼ to select **On**, and press **ENTER**.
- 5 Press ▼ to highlight **Edit Rating Limits** and press **ENTER**. The **Edit Rating Limits** screen appears.
- 6 Highlight **Alt RS** and press **ENTER**. The **Edit Alternate Ratings** screen will appear.

Note:

- The **Alt RS** button will only be available if an additional rating system is currently available.
- It may take several minutes for the TV to download the additional rating system.
- The information displayed in the **Alternate Ratings** screen will depend on the configuration of the additional rating system available at the time of download.

- 7 Press ▲▼◀▶ and then press **ENTER** to select the level of blocking you prefer. A box with an "X" is a rating that will be blocked.
- 8 When you are finished selecting the ratings you want to block, highlight **Done** and press **ENTER**.
- 9 In the **Edit Rating Limits** screen, highlight **Done** and press **ENTER**.

Note:

- The additional rating system can only be downloaded one time. You will not be able to download any updates to the rating system should such updates become available.
- The additional rating system is not designed, transmitted, or controlled by the TV or Toshiba, nor is the availability of an additional rating system determined or controlled by Toshiba. Similarly, the rating of programs in an additional rating system is not determined, transmitted, or controlled by the TV or Toshiba.
- The additional rating system is an evolving technology; therefore, availability, content, and format may vary.

(continued)

Independent rating system for broadcasters	
Ratings	Description and Content themes
TV-MA	Mature Audience Only (This program is specifically designed to be viewed by adults and therefore may be unsuitable for children under 17.) L) Crude or indecent language S) Explicit sexual activity V) Graphic violence
TV-14	Parents Strongly Cautioned (This program contains some material that many parents would find unsuitable for children under 14 years of age.) D) Intensely suggestive dialog L) Strong, coarse language S) Intense sexual situations V) Intense violence
TV-PG	Parental Guidance Suggested (This program contains material parents may find unsuitable for younger children.) D) Some suggestive dialog L) Infrequent coarse language S) Some sexual situations V) Moderate violence
TV-G	General Audience (Most parents would find this program suitable for all ages.)
TV-Y7, TV-Y7FV	Directed to Older Children (This program is designed for children age 7 and above. Note: Programs in which fantasy violence may be more intense or more combative than other programs in this category are designated TV-Y7FV.)
TV-Y	All Children (This program is designed to be appropriate for all children.)

Independent rating system for movies	
Ratings	Description and Content themes
X	X-rated (For adults only)
NC-17	Not intended for anyone 17 and under
R	Restricted (Under 17 requires accompanying parent or adult)
PG-13	Parents Strongly Cautioned (Some material may be inappropriate for children under 13)
PG	Parental Guidance Suggested (Some material may not be suitable for children)
G	General Audience (Appropriate for all ages)

Note:

- If you place an "X" in the box next to "None Rated," programs rated "None" will be blocked; however, programs that do not provide any rating information will not be blocked.
- To display the rating of the program you are watching, press **RECALL** on the remote control. If it is rated "None," the word "NONE" appears in the **RECALL** screen (as shown below right). If rating information is not provided, no rating will appear in the **RECALL** screen.



Blocking channels

With the Channels Block feature, you can block specific channels. You will not be able to tune blocked channels unless you unlock them.

To block channels:

- 1 From the **Locks** menu, press ▼ to display the PIN code entering screen.
- 2 Enter your four-digit PIN code and press **ENTER** (page 46).
- 3 Press ▼ to highlight **Channels Block** and then press **ENTER**. A list of the channels available for that input will be displayed along with the call letters for each channel, if available.
- 4 Press ▲▼ to highlight the channel you want to block and press **ENTER**, which puts an "X" in the box next to that channel.
- 5 Repeat step 4 for other channels you want to block.
- 6 Highlight **Done** and press **ENTER**.

To unblock individual channels:

In step 4 above, press ▲▼ to highlight the channel you want to unblock, press **ENTER** to remove the "X" from the box, highlight **Done** and press **ENTER**.

To block all channels at once:

Highlight **Block All** in step 4 above and then highlight **Done** and press **ENTER**.

To unblock all locked channels at once:

Highlight **Allow All** in step 4 above and then highlight **Done** and press **ENTER**.

Unlocking programs temporarily

If you try to tune the TV to a program that exceeds the rating limits you set, the TV will enter program lock mode and the following message will appear on-screen:

This program exceeds the rating limit you set.
Push 'mute' to enter PIN.

You can either temporarily unlock the program or select an unlocked program to watch.

To temporarily unlock the program:

- 1 Press **MUTE**.
- 2 Enter your four-digit PIN code and press **ENTER**. If the correct code is entered, the program lock mode is released and the normal picture appears. All locking is disabled until the TV is turned off, and will be enabled when the TV is turned on again.

Using the input lock feature

You can use the Input Lock feature to lock the video inputs (**Video 1, Video 2, ColorStream HD1, ColorStream HD2, HDMI 1, HDMI 2, HDMI 3, HDMI 4** and **PC**) and channels 3 and 4. You will not be able to view the input sources or channels until you unlock the inputs.

To lock/unlock the video inputs:

- 1 From the **Locks** menu, press ▼ to display the PIN code entering screen.
- 2 Enter your four-digit PIN code and press **ENTER**.
- 3 Press ▼ to highlight **Input Lock** and press ►.
- 4 Press ▲ or ▼ to select the level of video input locking you prefer, as described below.

Mode	Description
Video	Locks Video 1, Video 2, ColorStream HD1/HD2, HDMI 1, HDMI 2, HDMI 3, HDMI 4, and PC.
Video+	Locks Video 1, Video 2, ColorStream HD1/HD2, HDMI 1, HDMI 2, HDMI 3, HDMI 4, PC and channels 3 and 4. <ul style="list-style-type: none"> • Select Video+ if you play video tapes via an ANT/CABLE input.
Off	Unlocks all video inputs and channels 3 and 4.

- 5 Press **ENTER**.

Using the GameTimer®

You can use the GameTimer to set a time limit for playing a video game (30–120 minutes). When the GameTimer expires, the TV enters Input Lock mode and locks out the input source for the video game device.

To set the GameTimer®:

- 1 From the **Locks** menu, press ▼ to display the PIN code entering screen.
- 2 Enter your four-digit PIN code and press **ENTER**.
- 3 Press ▼ to highlight **Game Timer** and press ►.
- 4 Press ▲ or ▼ to select the length of time until the Input Lock is activated (30, 60, 90, or 120 minutes) and press **ENTER**.

To cancel the GameTimer®:

Select **Off** in step 4 above.

To deactivate the Input Lock once the GameTimer has activated it:

Set the **Input Lock** to **Off** (☞ “Using the input lock feature” as described above).

Note:

- A message will appear when 10 minutes, 3 minutes, and 1 minute remain on the GameTimer.
- If the TV loses power with time remaining on the GameTimer, when power is restored the TV will enter Input Lock mode (as if the GameTimer had been activated) and you will have to deactivate the Input Lock (as described above).

Using the control panel lock feature

You can lock the control panel to prevent your settings from being changed accidentally (by children, for example). When the control panel lock is **On**, none of the controls on the TV control panel will operate except **POWER**.

To lock the control panel:

- 1 From the **Locks** menu, press ▼ to display the PIN code entering screen.
- 2 Enter your four-digit PIN code and press **ENTER**.
- 3 Press ▼ to highlight **Control Panel Lock**.
- 4 Press ► and ▲ ▼ to highlight **On** and press **ENTER**. When the control panel is locked and any button on the control panel (except **POWER**) is pressed, the message “Not Available” appears.

To unlock the control panel:

Highlight **Off** in step 4 above, or press and hold the **VOLUME –** button on the TV control panel for about 10 seconds until the volume icon appears.

Using the PC settings feature

You can view an image from a PC on the TV screen. When a PC is connected to the TV's PC IN terminal, you can use the PC Settings feature to make adjustments to the image. If the edges of the picture are cut off, readjust the **Horizontal Position** and **Vertical Position**. If the picture is affected by interference, readjust the **Clock Phase** and **Sampling Clock**.

To adjust the PC settings:

- 1 Select PC input mode (☞ “Selecting the video input source to view” page 35).
- 2 From the **Setup** menu, highlight **PC Settings** and press .

Note: If a PC is not connected or there is no pc input signal, this feature will be grayed out in the **Setup** menu.
- 3 Press **▲** or **▼** to highlight the item you want to adjust.
- 4 Press **◀** or **▶** to make the appropriate adjustments.

Note: The screen is disrupted momentarily when adjusting the PC settings. This is not a sign of malfunction.

Mode	Description
Horizontal Position	Moves the picture left/right. The adjustment range is within ± 10 from center.*
Vertical Position	Moves the picture up/down. The adjustment range is within ± 10 from center.*
Clock Phase	Helps to reduce noise and sharpen the picture. The adjustment range is within ± 32 from center.*
Sampling Clock	Helps to reduce noise and minimize periodic vertical stripes on the screen. The adjustment range is within ± 5 from center.*

* The default settings and /or adjustment range vary depending on the input signal format.

Setting the PC Audio

This function allows you to output or mute the sound from your PC when connecting using the PC IN terminal and an analog RGB cable.

To set the PC Audio:

- 1 From the **Audio** menu, highlight **Audio Setup** and press .
- 2 Press **▲** or **▼** to select **PC Audio** and then press **◀** or **▶** to select **No** or **Yes**.

Yes: When viewing the PC input, the audio from the PC Audio input can be heard.

No: When viewing the PC input, there will be no audio.

Note: Because the PC and HDMI 1 inputs share the same set of analog audio inputs, the **PC Audio** menu setting influences the **HDMI 1 Audio** menu setting. If **PC Audio** is set to “**No**,” the **HDMI 1 Audio** setting changes to “**Auto**.” If **PC Audio** is set to “**Yes**,” the **HDMI 1 Audio** setting is set to “**Digital**” and is grayed out in the menu. (Also see item 4 on page 11 and “Setting the HDMI™ audio mode” on page 32.)

Setting the sleep timer

You can set the sleep timer to turn off the TV after a set length of time (maximum of 180 minutes).

To set the sleep timer using the remote control:

Press **SLEEP** on the remote control to set the length of time until the TV turns off. Repeatedly press **SLEEP** to increase the time in 10-minute increments, or press **▲** or **▼** to increase or decrease the time in 10-minute increments, to a maximum of 180 minutes.

To set the sleep timer using the on-screen menus:

- 1 From the **Setup** menu, highlight **Sleep Timer** and press **ENTER**.
- 2 Press the Number buttons to enter the length of time in 10-minute increments.
- 3 Highlight **Done** and press **ENTER**.

Note: When a power failure occurs, the sleep timer setting may be cleared.

To display the remaining sleep time:

Press **SLEEP**.

Note: A message will display on-screen when there is one minute remaining on the sleep timer.

To cancel the sleep timer:

Repeatedly press **SLEEP** until it is set to 0 minute.

Using REGZA-LINK

This is a new feature that uses CEC technology and allows you to control Toshiba REGZA-LINK compatible devices from the TV remote via HDMI connection (see page 17).









When the Enable REGZA-LINK in the REGZA-LINK setup menu (see page 52) is set to **On**, the following REGZA-LINK functions will be enabled.

REGZA-LINK playback device (HD DVD player, etc.) control

With your TV's remote control, or using the **REGZA-LINK Player Control** menu, you can control the connected REGZA-LINK playback device you are watching.

Available remote control key functions:

Before using the following key functions, first set the MODE SELECT switch on the remote control to **TV**.

Button	Description
PLAY 	Begins playback.
STOP 	Stops playback.
PAUSE/STEP 	Pauses the picture during play or record mode.
SKIP 	Skips forward.
SKIP 	Skips backward.
FF 	Fast-forwards.
REW 	Rewinds/reverses.
▲ ▼ ◀ ▶	Navigate contents menu, etc.
ENTER 	Enters contents menu, etc.
EXIT 	Returns to the previous menu.

Note: These functions depend on the devices connected.

(continued)

REGZA-LINK Player Control menu functions:

- 1 Press **MENU** and open the **Applications** menu.
- 2 Highlight **REGZA-LINK Player Control** and press **ENTER**.

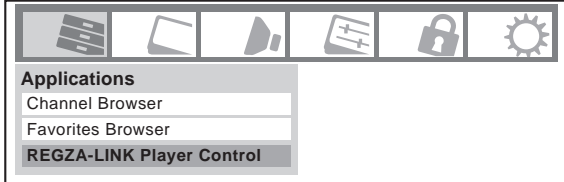

- 3 Press **▲** or **▼** to select the item you want to control and press **ENTER**.

Item	Description
Power	Turns the select device on and off.
Top Menu	Accesses the top menu of a DVD.
Menu	Accesses the menu of a DVD.
Contents Menu	Accesses the contents list when you press ENTER . At this time, the REGZA-LINK Player Control menu will disappear.

Note:

- These functions depend on the devices that are connected.
- The **REGZA-LINK Player Control** item will be grayed out in the following conditions:
 - A non-HDMI input is currently selected.
 - The **Enable REGZA-LINK** item is set to **Off**.
 - The connected CEC device is not a playback or recording device.

REGZA-LINK input source selection

If a REGZA-LINK device with HDMI switching capability (e.g. Audio Receiver) is connected to the HDMI input, you can select another REGZA-LINK device that is connected to the master HDMI device using the TV's INPUT button. See page 35 for details.

VOLUME and MUTE controls of Audio Receiver

With your TV's remote control, you can adjust or mute the sound volume of the Audio Receiver. First, set the MODE SELECT switch on the remote control to **TV**.

- **VOL+** / **VOL-** adjust the volume level.
- **MUTE** turns off the sound.

Note:

- To use this function:
 - Set **Speaker Preference** to **Audio Receiver** in the **REGZA-LINK Setup** menu.
 - Confirm that a connected REGZA-LINK device (such as HD DVD player, etc) is selected for the Audio Receiver input source.
- You can also use this function when the audio receiver is connected to the TV's **DIGITAL AUDIO OUT** terminal (not HDMI connection). In this case, select a digital audio input mode on the Audio Receiver.
- These functions depend on the device connected.

Other REGZA-LINK functions

When the **Enable REGZA-LINK** and each item in the **REGZA-LINK Setup** menu are set to **On**, the following functions will be enabled.

Item	Description
TV Auto Input Switch	If a connected HDMI device starts playing video or audio, the TV will automatically switch to the appropriate HDMI input.
TV Auto Power	If a REGZA-LINK device is turned on, the TV turns on automatically.
Device Auto Standby	If the TV is turned off the TV will send a message to turn off all of the REGZA-LINK devices connected to the TV.
Speaker Preference	From this item, you can set your audio output preference to the TV speakers or the audio receiver speakers. When this item is set to Audio Receiver, the TV remote can be used to adjust or mute the volume of the audio. This item will be grayed out unless a REGZA-LINK compatible audio receiver is connected.

Note: When you turn on the Audio Receiver, change its input source, or adjust the sound volume, the sound will be output from the audio receiver's speakers even if **TV Speakers** has been selected. Turn the TV off and on again to output the sound from the TV speakers.

To set the REGZA-LINK Setup:

- 1 From the **Setup** menu, highlight **REGZA-LINK Setup** and press **ENTER**.
- 2 Press **▲** or **▼** to highlight **Enable REGZA-LINK**.
- 3 Press **◀** or **▶** to select **On**.
*Note: If you set **Enable REGZA-LINK** to **Off**, the other items will be grayed out.*
- 4 Press **▲** or **▼** to highlight the **REGZA-LINK** setup item you want to use, and press **◀** or **▶** to select **On** or desired mode.
 - TV Auto Input Switch: On/Off
 - TV Auto Power: On/Off
 - Device Auto Standby: On/Off
 - Speaker Preference: TV Speakers/Audio Receiver
- 5 To save the new settings, highlight **Done** and press **ENTER**. To revert to the factory defaults, highlight **Reset** and press **ENTER**.

Using the HDMI settings feature

This menu consists of the following 2 items (new HDMI capabilities) and will be grayed out on non-HDMI inputs.

Some HDMI legacy sources may not work properly with your HDMI TV, please try setting the following options (Lip-Sync Latency and Deep Color) to **Off**. Adjusting these settings should allow your HDMI legacy source to operate properly with your TV.

Note: You must disconnect your source device first before settings can be adjusted.

- Lip-Sync Latency: On
This option activates an auto audio/video display timing adjustment function that allows HDMI source devices to accurately perform synchronization automatically.
- Deep Color: On (46" and 52" models only)
This feature allows the HDMI source to increase available colors bits within the boundaries defined by the RGB or YCbCr color space.

All above HDMI settings need proper HDMI source device. If HDMI source products does not support these features, the TV may not work properly by activating these features.

Note: If your HDMI connection is capable of 1080p and/or your TV is capable of refresh rates greater than 60Hz or supports Deep Color, you will need a Category 2 cable. Conventional HDMI/DVI cables may not work properly with this mode.

To set the HDMI Settings:

- 1 Select the appropriate HDMI input mode (HDMI 1, HDMI 2, HDMI 3, or HDMI 4).
- 2 From the **Setup** menu, highlight **HDMI Settings** and press **ENTER**.
- 3 Press **▲** or **▼** to highlight the item you want to set.
- 4 Press **◀** or **▶** to select **On** or **Off**.
- 5 To save the new settings, highlight **Done** and press **ENTER**. To revert to the factory defaults, highlight **Reset** and press **ENTER**.

Displaying TV status information

To display TV status information using RECALL:

Press **RECALL** on the remote control.

The following information will display (if applicable):

- Current input (**ANT/CABLE, Video 1**, etc.)
- If ANT/CABLE is the current input, either “CABLE” (for cable TV) or “ANT” (for over-the-air broadcasts).
- Channel number (if in **ANT/CABLE** mode)
- Channel label (if set)
- Digital signal strength indicator (bar graph in lower right corner of box; for ATSC signal only)
- Stereo, Mono or SAP audio status (when HDMI input mode, Dolby Digital or PCM)
- Video resolution
- Aspect ratio of incoming video signal (4:3 or 16:9)
- V-Chip rating status
- GameTimer (if set)



To close the RECALL screen:

Press **RECALL** again.

To display TV status information using INFO:

(only available for ANT/CABLE input)

Press **INFO** on the remote control.

The following additional information will display for off air digital channels (if applicable):

- Title
- Duration
- Detailed description

To display Next information, press **INFO** on the remote control again. Pressing **INFO** a third time will remove the entire banner.



Note: The location of the banner can be moved to the top or bottom of the screen by pressing **▲** or **▼** while the RECALL or INFO display is on-screen. (The last position will be stored to memory.)

Understanding the auto power off feature

The TV will automatically turn itself off after approximately 15 minutes if it is tuned to a vacant channel or a station that completes its broadcast for the day. This feature functions in **ANT/CABLE** mode only.

Understanding the last mode memory feature

If the power is cut off while you are viewing the TV, the Last Mode Memory feature automatically turns on the TV when the power is resupplied.

Note: If it's possible, and you will be away from the TV for an extended period of time you should unplug the power cord.

Chapter 7: Using the TV's advanced features

Using the advanced picture settings features

Using dynamic contrast

When dynamic contrast is set to **Low**, **Middle**, or **High**, the TV will detect changes in the picture quality that affect the appearance of your contrast settings and then automatically adjust the video.

To select dynamic contrast preferences:

- 1 Press **MENU** and open the **Video** menu.
- 2 Highlight **Picture Settings** and press **ENTER**.

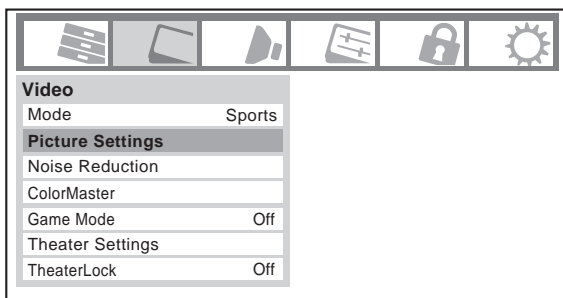

- 3 Highlight **Advanced Picture Settings** and press **ENTER**.
- 4 In the **Dynamic Contrast** field, select either **Off**, **Low**, **Middle** or **High**.
- 5 To save the new settings, highlight **Done** and press **ENTER**. To revert to the factory defaults, highlight **Reset** and press **ENTER**.

Note: If you select one of the factory-set picture modes (**Sports**, **Standard**, **Movie**, or **PC**) and then change the dynamic contrast setting, the picture mode automatically changes to **Preference**.

Using the static gamma feature

The static gamma feature allows you to adjust the levels of black in the picture.

To adjust the static gamma settings:

- 1 From the **Video** menu, highlight **Picture Settings** and press **ENTER**.
- 2 Highlight **Advanced Picture Settings** and press **ENTER**.
- 3 In the **Static Gamma** field, press **◀** or **▶** to adjust the static gamma.

The adjustment range is within ± 5 from center.

- If the setting is moved in the minus direction, the detail of black colors will be decreased.
- If the setting is moved in the plus direction, the detail of black colors will be increased.

- 4 To save the new settings, highlight **Done** and press **ENTER**. To revert the factory defaults, highlight **Reset** and press **ENTER**.

Note: If you select one of the factory-set picture modes (**Sports**, **Standard**, **Movie**, or **PC**) and then change the static gamma setting, the picture mode automatically changes to **Preference**.

(continued)

Selecting the color temperature

You can change the quality of the picture by selecting from three preset color temperatures (Cool, Medium, and Warm), as described below.

Mode	Picture Quality
Cool	blueish
Medium	neutral
Warm	reddish

To select the color temperature:

- 1 From the **Video** menu, highlight **Picture Settings** and press **ENTER**.
- 2 Highlight **Advanced Picture Settings** and press **ENTER**.
- 3 Highlight **Color Temperature** and press **ENTER**.
- 4 In the **Color Temperature** field, select the mode you prefer (**Cool**, **Medium**, or **Warm**).
- 5 Press **▲** or **▼** to select either **B Drive** or **G Drive**, and then press **◀** or **▶** to adjust the settings.
 - B Drive: **▶** makes the picture blueish.
 - G Drive: **▶** makes the picture greenish.
- 6 To save the new settings, highlight **Done** and press **ENTER**. To revert to the factory defaults, highlight **Reset** and press **ENTER**.

Note: The **B Drive** and **G Drive** settings are connected to the **Color Temperature** settings and will change based on which setting is selected in step 4 above.

Note: If you select one of the factory-set picture modes (**Sports**, **Standard**, **Movie**, or **PC**) and then change the color temperature mode, the picture mode automatically changes to **Preference**.

Using CableClear® digital noise reduction

The CableClear® digital noise reduction feature allows you to reduce visible interference in your TV picture. This may be useful when receiving a broadcast with a weak signal (especially a Cable channel) or playing a noisy video cassette or disc.

To change the CableClear settings:

- 1 From the **Video** menu, highlight **Noise Reduction** and press **ENTER**.
- 2 In the **CableClear** field, select your desired setting.

Note:

 - If the current input is **ANT/CABLE**, **Video 1**, or **Video 2**, the menu will display the text "CableClear." The available selections are **Off**, **Auto**, **Low**, **Middle**, and **High**.
 - If the current input is **ColorStream HD1**, **ColorStream HD2**, **HDMI 1**, **HDMI 2**, **HDMI 3**, or **HDMI 4**, the menu will display the text "DNR." The available selections are **Off**, **Auto**, **Low**, **Middle**, and **High**. **Auto** will react proportionally to the strength of the noise. **Low**, **Middle**, and **High** will reduce the noise in varying degrees, from lowest to highest, respectively.
- 3 To save the new settings, highlight **Done** and press **ENTER**. To revert to the factory defaults, highlight **Reset** and press **ENTER**.

Using MPEG noise reduction

The MPEG noise reduction feature allows you to reduce visible interference caused by MPEG compression. Choices for MPEG noise reduction are **Off**, **Low**, **Middle**, and **High**. **Off** is automatically selected when this feature is disabled ("grayed out").

To select the MPEG noise reduction level:

- 1 From the **Video** menu, highlight **Noise Reduction** and press **ENTER**.
- 2 Press **▲** or **▼** to highlight the **MPEG Noise Reduction** field, and then press **◀** or **▶** to select either **Off**, **Low**, **Middle** or **High**.
- 3 To save the new settings, highlight **Done** and press **ENTER**. To revert to the factory defaults, highlight **Reset** and press **ENTER**.

Using the ColorMaster™ feature

The ColorMaster feature allows you to adjust standard colors. The menu will consist of 3 items: ColorMaster, Color Palette Adjustment, and Reset.

To turn on ColorMaster:

- 1 From the **Video** menu, highlight **ColorMaster** and press **ENTER**.
- 2 In the **ColorMaster** field, select **On**.

Note: If you select one of the factory-set picture modes (**Sports**, **Standard**, **Movie**, or **PC**) and then change the ColorMaster setting, the picture mode automatically changes to **Preference**.

To turn off ColorMaster:

Select **Off** in Step 2 above.

Using Color Palette Adjustment

When color palette adjustment is selected, the list of base colors will be displayed. You can select a base color to adjust.

Note: To use **Color Palette Adjustment**, **ColorMaster** must be set to **On**.

To adjust the Base Colors:

- 1 From the **ColorMaster** menu, highlight **Color Palette Adjustment** and press **ENTER**.
- 2 The **Select Standard Color** window will be displayed. Press **▲** or **▼** to highlight the color you want to adjust, and then press **ENTER**.
- 3 The **Color Adjustment** window will be displayed. Press **FREEZE** to freeze the picture. To return to moving picture, press **FREEZE** again.

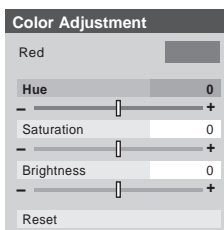

- 4 Press **▲** or **▼** to select either **Hue**, **Saturation**, or **Brightness**, and then press **◀** and **▶** to adjust the setting.

Note: To revert to the factory settings of the **Hue**, **Saturation**, and **Brightness** for the selected color, Highlight **Reset** and press **ENTER**.
- 5 Press **CH RTN** to return to the previous menu.
- 6 Repeat steps 2 through 5 to adjust any other color.

To reset ColorMaster to its factory settings:

- 1 From the **ColorMaster** menu, highlight **Reset**, and then press **ENTER**.
- 2 A confirmation message will appear. Highlight **OK**, and then press **ENTER**.
- 3 Press **EXIT**.

Using the Game Mode feature

You can use the Game Mode feature for shorter frame delays when playing a video game requiring split-second timing between the on-screen display and input from the controller (such as music creation and high-action games).

This feature is more effective for 480i and 1080i input signals.

Note: To use the Game Mode feature, the current video input must be **Video 1**, **Video 2**, **ColorStream HD1**, **ColorStream HD2**, **HDMI 1**, **HDMI 2**, **HDMI 3**, **HDMI 4**, or **PC**. The Game Mode cannot be turned on when the **ANT/CABLE** input is selected.

To turn on Game Mode:

- 1 From the **Video** menu, press **▲** or **▼** to highlight the **Game Mode** field, press **▶** and **▲ ▼** to select **On**, and press **ENTER**.

To turn off Game Mode:

Select **Off** in step 1 above, change the video input, or turn the TV off and then on again.

Note: You can change the video input by pressing **INPUT** on the remote control (▶ page 35).

Using the advanced audio settings features

Using the surround sound features

Stereo Extension, Voice Enhancement, and Dynamic Bass Boost help to create a thrilling surround sound experience with deep, rich bass from stereo sound sources. Your TV's audio will sound fuller, richer, and wider.

To adjust the settings:

- 1 Put the TV in **STEREO** mode (☞ “Selecting stereo/SAP broadcasts” on page 45).
- 2 From the **Audio** menu, highlight **Advanced Audio Settings** and press **ENTER**.
- 3 Press **▼** or **▲** to highlight the feature you want to adjust, and then press **◀** or **▶** to adjust the item.

Mode	Description
Stereo Extension	To turn the surround sound effect On or Off . <i>Note: If the broadcast is monaural, the Stereo Extension effect will not work.</i>
Voice Enhancement	To turn the vocal emphasis effect On or Off .
Dynamic Bass Boost	To select the desired bass expansion level (Off , Low , or High).

- 4 To save the new settings, highlight **Done** and press **ENTER**. To revert to the factory defaults, highlight **Reset** and press **ENTER**.

Chapter 8: Troubleshooting

General troubleshooting

Before calling a service technician, please check this chapter for a possible cause of the problem and some solutions you can try.

Black box on-screen

- The closed caption feature is set to one of the Text modes (**T1**, **T2**, **T3**, or **T4**). Set the closed caption feature to **Off** (ⓘ page 43).

TV stops responding to controls

- If the TV stops responding to the controls on the remote control or TV control panel and you cannot turn off the TV, press and hold the **POWER** button on the TV control panel for 5 or more seconds to reset the TV.

Other problems

- If your TV's problem is not addressed in this Troubleshooting section or the recommended solution has not worked, use the Restore Factory Defaults procedure (ⓘ page 34).

TV will not turn on

- Make sure the power cord is plugged in, and then press **POWER** (ⓘ).
- The remote control batteries may be dead. Replace the batteries or try the control panel buttons.

Picture problems

General picture problems

- Check the antenna/cable connections (ⓘ Chapter 2).
- Press **INPUT** on the remote control or TV and select a valid video input source (ⓘ page 35). If no device is connected to a particular input on the TV, no picture will display when you select that particular input source. For device connection details, see Chapter 2.
- Antenna reception may be poor. Use a highly directional outdoor antenna (if applicable).
- The station may have broadcast difficulties. Try another channel.
- Adjust the picture qualities (ⓘ page 42).
- If you are using a VCR, make sure **TV/VCR** on the remote control is set correctly (ⓘ page 21).
- Do not connect both a standard video cable and an S-video cable to the **VIDEO 1** input at the same time (ⓘ page 13).

Noisy picture

- If you are watching an analog channel (off-air broadcast or Cable TV), you can set the **CableClear®/DNR** feature to **AUTO** to reduce visible interference in the TV picture (ⓘ page 56).

Video Input Selection problems

- If the **Input Selection** window does not appear when you press **INPUT** on the remote control or TV, press **INPUT** a second time, which will change to the next video input source and display the **Input Selection** window.

Cannot view external signals or channel 3 or 4

- If you cannot view signals from external devices connected to **VIDEO 1**, **VIDEO 2**, **ColorStream®**, **HDMI 1**, **HDMI 2**, **HDMI 3**, **HDMI 4**, **PC** or from channels 3 or 4, make sure the **Input Lock** is set to **Off** (ⓘ page 49).

Poor color or no color

- The station may have broadcast difficulties. Try another channel.
- Adjust the **Tint** and/or **Color** (ⓘ page 42).

Poor composite or S-video picture

- If the TV is connected to an external A/V device (e.g., DVD player, video game system, set-top box, etc.) try using a **ColorStream** or **HDMI** video connection instead.
- If you connect an S-video cable, be sure to disconnect the standard (composite) video cable. Do not connect both types of video cable at the same time.

Picture and sound are out of sync

- As with all products that contain a digital display, in rare instances, when viewing certain content (e.g., television broadcasts, video games, DVDs), you may notice that the sound and picture are slightly out of sync. This phenomenon can be caused by various factors including, without limitation, video processing within the TV, video processing in an attached gaming system, and video processing or different compression rates used by broadcasters in their programming. You may want to try one or more of the following suggestions, which may help to reduce the effect of this phenomenon:
 - If the TV is connected to an A/V receiver that has a programmable audio delay feature, use this feature to help synchronize the sound to the picture.
 - If you notice this phenomenon only on certain TV channels, please contact your local broadcast, cable, or satellite provider to inform them of this issue.

LED indications while in reboot from standby

- When you plug the power cord in, the yellow LED will blink until the TV enters standby mode, (plugged in but not powered on). This is normal and is not a sign of malfunction.

Sound problems

- Check the antenna/cable connections (ⓘ Chapter 2).
- The station may have broadcast difficulties. Try another channel.
- The sound may be muted. Press **VOLUME**.
- If you hear no sound, try setting the **MTS** feature to **Stereo** mode (ⓘ page 45).
- If you are not receiving a second audio program from a known SAP source, make sure the **MTS** feature is set to **SAP** mode (ⓘ page 45).
- If you hear audio that seems "incorrect" for the program you are watching (such as music or a foreign language), the SAP mode may be on. Set the **MTS** feature to **Stereo** mode (ⓘ page 45).

(continued)

Remote control problems

- Make sure the remote control is set to the correct device mode (🔍 page 21).
- Remove all obstructions between the remote control and the TV.
- The remote control batteries may be dead. Replace the batteries (🔍 page 20).
- Your TV remote control may not operate certain features on your external device. Refer to the owner's manual for your other device to determine its available features. If your TV remote control does not operate a specific feature on another device, use the remote control that came with the device (🔍 pages 22–26).
- If the TV still does not act as expected, use the Reset Factory Defaults procedure (🔍 page 34).

Channel tuning problems

- Make sure the remote control is set to the correct device mode (🔍 page 21).
- The channel may have been erased from the channel memory by the **Channel Add/Delete** feature. Add the channel to the channel memory (🔍 page 30).
- The channel may be blocked by the **Channels Block** feature. Unblock the channel (🔍 page 48).
- If you are unable to tune digital channels, check the antenna configuration (🔍 page 29). If you are still unable to tune digital channels, clear all channels from the channel list (🔍 page 31) and reprogram channels into the channel memory (🔍 page 30). If you are still unable to tune digital channels, use the Reset Factory Defaults procedure (🔍 page 34). Also see “TV stops responding to controls” and “Other problems” (🔍 page 59).

Closed caption problems

- If the program or video you selected is not closed-captioned, no captions will display (🔍 page 43).
- If text is not available, a black rectangle may appear. If this happens, turn off the closed caption feature (🔍 page 43).
- A closed-caption signal may not display correctly in the following situations: a) when a videotape has been dubbed; b) when the signal reception is weak; or c) when the signal reception is nonstandard (🔍 page 43).

Rating blocking (V-Chip) problems

- If you forget your PIN code: While the PIN code entering screen is displayed, press **RECALL** four times within 5 seconds. The PIN code you previously stored will be cleared (🔍 page 46).
- The V-Chip feature is available for the U.S. V-Chip system only (🔍 page 47).

No REGZA-LINK operation

- The REGZA-LINK feature is available for Toshiba REGZA-LINK compatible devices.
- Make sure the HDMI cables with the HDMI Logo (**HDMI**) are used.
- When the connected REGZA-LINK device does not work correctly after you have changed settings of the device, turn off your TV and unplug the power cord, then plug and turn on again.
- If several devices are connected, REGZA-LINK feature may not operate properly.
- Read the instruction manual furnished with the connected REGZA-LINK device.

HDMI problems

For HDMI cables

- Make sure the HDMI cables with the HDMI Logo (**HDMI**) are used (🔍 page 16).

For Deep Color

- You should need to use Category 2 cable to work properly. Normal HDMI cable or DVI cable may not work with this option (🔍 page 53).

For Legacy HDMI source

- Some of legacy HDMI sources may not work properly with latest HDMI TV products, due to new standard adoption. Please try to set Off the HDMI settings(Lip-Sync Latency, Deep Color). Your legacy HDMI source should operate properly with this TV products (🔍 page 53).

LED indications

The green and yellow LED lights on the TV front indicate the TV's status, as described below.

Note: If the TV loses A/C power (e.g., a power outage occurs or the power cord is unplugged), when power is restored, the yellow LED will blink while the TV is booting until the remote control is usable. This is normal and is not a sign of malfunction.

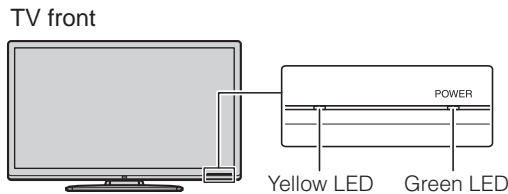

LED Indication

- **Green is ON (solid)**
The TV is operating properly.
- **Yellow is ON (solid)**
Standby with Power-On Mode set to Fast.
See “Selecting the Power-On Mode” (ⓘ page 34).
- **Yellow blinks three times**
TV is powering up.
Wait several seconds until the yellow LED stops blinking.
- **Green blinks slowly**
Abnormal operation of BUS line.
Turn OFF the TV and unplug the power cord. Plug the power cord in again and turn ON the TV.
- **Green blinks quickly**
Power protect detection.
Turn OFF the TV and unplug the power cord. Plug the power cord in again and turn ON the TV.

If, after trying the solutions, the problem still exists:

- In the U.S., call TACP Consumer Solutions at 1-800-575-5469.
- In Canada, locate the nearest Toshiba authorized service depot by directing your web browser to www.toshiba.ca; click “Home Entertainment,” and then click “Support.”

Specifications

Note:

- *This model complies with the specifications listed below.*
- *Designs and specifications are subject to change without notice.*
- *This model may not be compatible with features and/or specifications that may be added in the future.*

Television System

NTSC standard
ATSC standard (8VSB)
Digital Cable (64 QAM, 256 QAM; in-the-clear, unencrypted)

Channel Coverage

VHF: 2 through 13
UHF: 14 through 69
Cable TV: Mid band (A-8 through A-1, A through I)
Super band (J through W)
Hyper band (AA through ZZ, AAA, BBB)
Ultra band (65 through 94, 100 through 135)

Power Source: 120 V AC, 60 Hz

Power Consumption

32RV530U: 1.6 Arms (maximum current)
0.4 W in standby mode
37RV530U: 1.6 Arms (maximum current)
0.4 W in standby mode
42RV530U: 2.1 Arms (maximum current)
0.4 W in standby mode
46RV530U: 2.4 Arms (maximum current)
0.4 W in standby mode
52RV530U: 2.8 Arms (maximum current)
0.4 W in standby mode

Audio Power: 10 W + 10 W

Speaker Type

Main: Two 1-3/8 × 6-3/8 inches (35 × 160 mm)

Video/Audio Terminals

S-VIDEO INPUT:

Y: 1 V(p-p), 75 ohm, negative sync.
C: 0.286 V(p-p) (burst signal), 75 ohm

VIDEO/AUDIO INPUT:

VIDEO: 1 V(p-p), 75 ohm, negative sync.
AUDIO: 150 mV(rms) (30% modulation equivalent, 22 k ohm or greater)

ColorStream® (component video) HD INPUT:

VIDEO: Y: 1V(p-p), 75 ohm
PR: 0.7 V(p-p), 75 ohm
PB: 0.7 V(p-p), 75 ohm
Suggested formats: 1080i, 720p, 480p, 480i
AUDIO: 150 mV(rms), 22 k ohm or greater

HDMI™ INPUT:

HDMI compliant (type A connector)
HDCP compliant
Audio Lip Sync supported
Deep Color supported (10 bit 4:4:4, 12 bit 4:4:4) (only for 46" and 52" models)
Suggested formats: See table on the next page.
HDMI Audio: 2-channel Linear-PCM; 32/44.1/48 kHz sampling frequency; 16/20/24 bits per sample

FIXED AUDIO OUTPUT:

150 mv (rms) (30% modulation equivalent, 2.2 k ohm or less)

DIGITAL AUDIO OUTPUT:

Optical type

IR OUT:

3 V(p-p), 3.5 mm mono socket

PC INPUT:

15-Pin D-sub Analog RGB

Dimensions

32RV530U: Width: 31 inches (786 mm)
Height: 22-3/4 inches (575 mm)
Depth: 9-7/8 inches (250 mm)
37RV530U: Width: 35-5/8 inches (902 mm)
Height: 25 inches (635 mm)
Depth: 9-7/8 inches (250 mm)
42RV530U: Width: 39-3/4 inches (1,009 mm)
Height: 27-3/8 inches (694 mm)
Depth: 12-1/4 inches (308 mm)
46RV530U: Width: 43-5/8 inches (1,108 mm)
Height: 29-3/8 inches (746 mm)
Depth: 12-1/4 inches (308 mm)
52RV530U: Width: 49-3/8 inches (1,252 mm)
Height: 33 inches (837 mm)
Depth: 14-1/2 inches (368 mm)

Mass (weight)

32RV530U: 37.3 lbs (16.9 kg)
37RV530U: 45.2 lbs (20.5 kg)
42RV530U: 60.2 lbs (27.3 kg)
46RV530U: 64.6 lbs (29.3 kg)
52RV530U: 87.8 lbs (39.8 kg)

Operating conditions

Temperature: 32°F - 95°F (0°C - 35°C)
Humidity: 20 - 80% (no moisture condensation)

Supplied Accessories

- Remote control with two size "AAA" batteries
- Owner's manual (this book)
- Securement Clip
Use this clip to attach the TV to a wall stud, pillar, or other immovable structure. See item 20 on page 3 and instructions on page 5.
- Cleaning cloth (to clean the cabinet and control panel)

Acceptable signal formats for PC IN and HDMI terminals

PC IN signal formats

Note: Depending on the connected PC, the following status may occur; incorrect display, false format detection, picture position failure, blur, or judder. But this is not a malfunction of your TV.

Format	Resolution	V. Frequency	H. Frequency	Pixel Clock Frequency
VGA	640 × 480	59.940Hz	31.469kHz	25.175MHz
		72.809Hz	37.861kHz	31.500MHz
		75.000Hz	37.500kHz	31.500MHz
SVGA	800 × 600	60.317Hz	37.879kHz	40.000MHz
		72.188Hz	48.077kHz	50.000MHz
		75.000Hz	46.875kHz	49.500MHz
XGA	1024 × 768	60.004Hz	48.363kHz	65.000MHz
		70.069Hz	56.476kHz	75.000MHz
		75.029Hz	60.023kHz	78.750MHz
WXGA	1280 × 768	59.995Hz	47.396kHz	68.250MHz
		59.870Hz	47.776kHz	79.500MHz
		74.893Hz	60.289kHz	102.250MHz
	1360 × 768	60.015Hz	47.712kHz	85.500MHz
SXGA	1280 × 1024	60.020Hz	63.981kHz	108.000MHz

HDMI signal formats

Format	Resolution	V. Frequency	H. Frequency	Pixel Clock Frequency
VGA	640 × 480	59.940Hz	31.469kHz	25.175MHz
		72.809Hz	37.861kHz	31.500MHz
		75.000Hz	37.500kHz	31.500MHz
SVGA	800 × 600	60.317Hz	37.879kHz	40.000MHz
		72.188Hz	48.077kHz	50.000MHz
		75.000Hz	46.875kHz	49.500MHz
XGA	1024 × 768	60.004Hz	48.363kHz	65.000MHz
		70.069Hz	56.476kHz	75.000MHz
		75.029Hz	60.023kHz	78.750MHz
WXGA	1280 × 768	59.995Hz	47.396kHz	68.250MHz
		59.870Hz	47.776kHz	79.500MHz
		74.893Hz	60.289kHz	102.250MHz
	1360 × 768	60.015Hz	47.712kHz	85.500MHz
SXGA	1280 × 1024	60.020Hz	63.981kHz	108.000MHz
480i	720 × 480i	59.940/60Hz	15.734/15.750kHz	27.000/27.027MHz
480p	720 × 480p	59.940/60Hz	31.469/31.500kHz	27.000/27.027MHz
720p	1280 × 720p	59.940/60Hz	44.955/45.000kHz	74.176/74.250MHz
1080i	1920 × 1080i	59.940/60Hz	33.716/33.750kHz	74.176/74.250MHz
1080p	1920 × 1080p	23.976/24Hz	26.973/27.000kHz	74.176/74.250MHz
1080p	1920 × 1080p	59.940/60Hz	67.433/67.500kHz	148.352/148.500MHz

Limited United States Warranty

for LCD Televisions 26" and Larger

Toshiba America Consumer Products, L.L.C. ("TACP") makes the following limited warranties to original consumers in the United States.

THESE LIMITED WARRANTIES EXTEND TO THE ORIGINAL CONSUMER PURCHASER OR ANY PERSON RECEIVING THIS LCD TELEVISION AS A GIFT FROM THE ORIGINAL CONSUMER PURCHASER AND TO NO OTHER PURCHASER OR TRANSFEREE. LCD TELEVISIONS PURCHASED IN THE U.S.A. AND USED ANYWHERE OUTSIDE OF THE U.S.A., INCLUDING, WITHOUT LIMITATION, CANADA AND MEXICO, ARE NOT COVERED BY THESE WARRANTIES.

LCD TELEVISIONS PURCHASED ANYWHERE OUTSIDE OF THE U.S.A., INCLUDING, WITHOUT LIMITATION, CANADA AND MEXICO, AND USED IN THE U.S.A., ARE NOT COVERED BY THESE WARRANTIES.

Limited One (1) Year Warranty on Parts and Labor

TACP warrants this LCD Television and its parts against defects in materials or workmanship for a period of one (1) year after the date of original retail purchase. DURING THIS PERIOD, TACP WILL, AT TACP'S OPTION, REPAIR OR REPLACE A DEFECTIVE PART WITH A NEW OR REFURBISHED PART WITHOUT CHARGE TO YOU FOR PARTS OR LABOR. During this period, TACP Authorized Service Station personnel will come to your home when warranty service is required. Depending on the type of repair required, the service will either be performed in your home or the LCD Television will be taken to a TACP Authorized Service Station for repair and returned to your home at no cost to you.

Rental Units

The warranty for LCD Television rental units begins on the date of the first rental or thirty (30) days after the date of shipment to the rental firm, whichever comes first.

Limited Warranty for Commercial Units

TACP warrants LCD Televisions that are sold and used for commercial purposes as follows: all parts are warranted against defects in materials or workmanship for a period of ninety (90) days after the date of original retail purchase. DURING THIS PERIOD, TACP WILL, AT TACP'S OPTION, REPAIR OR REPLACE A DEFECTIVE PART WITH A NEW OR REFURBISHED PART WITHOUT CHARGE TO YOU.

Owner's Manual and Product Registration Card

Read this owner's manual thoroughly before operating this LCD Television.

Complete and mail the enclosed product registration card or register your LCD Television online at www.tacp.toshiba.com/service as soon as possible. By registering your LCD Television you will enable TACP to bring you new products specifically designed to meet your needs and help us to contact you in the unlikely event a safety notification is required under the U.S. Consumer Product Safety Act. **Failure to complete and return the product registration card does not diminish your warranty rights.**

Your Responsibility

THE ABOVE WARRANTIES ARE SUBJECT TO THE FOLLOWING CONDITIONS:

- (1) You must retain your original bill of sale or provide other proof of purchase.
- (2) All warranty servicing of this LCD Television must be performed by an Authorized TACP Service Station.
- (3) The warranties from TACP are effective only if this LCD Television is purchased and operated in the Continental U.S.A. or Puerto Rico.
- (4) Labor service charges for set installation, setup, adjustment of customer controls, and installation or repair of antenna systems are not covered by this warranty. Reception problems caused by inadequate antenna systems, misaligned satellite dishes, cable

television distribution, VCRs, DVD players/recorders, personal computer level IEEE-1394 devices, and any other connected signal source device are your responsibility.

- (5) Warranties extend only to defects in materials or workmanship as limited above, and do not extend to any LCD Television or parts that have been lost or discarded by you or to damage to the LCD Television or parts caused by fires, misuse, accident, Acts of God (such as lightning or fluctuations in electric power), improper installation, improper maintenance, or use in violation of instructions furnished by TACP; use or malfunction through simultaneous use of this LCD Television and connected equipment; or to units that have been modified or had the serial number removed, altered, defaced, or rendered illegible.

How to Obtain Warranty Service

If, after following all of the operating instructions in this manual and reviewing the section entitled "Troubleshooting," you find that service is needed:

- (1) To find the nearest TACP Authorized Service Station, visit TACP's website at www.tacp.toshiba.com/service or contact TACP's Consumer Solution Center toll free at 1-800-575-5469.
- (2) You must present your original bill of sale or other proof of purchase to the TACP Authorized Service Station.

**For additional information, visit TACP's website:
www.tacp.toshiba.com**

ALL WARRANTIES IMPLIED BY THE LAW OF ANY STATE OF THE U.S.A., INCLUDING THE IMPLIED WARRANTIES OF MERCHANTABILITY AND FITNESS FOR A PARTICULAR PURPOSE, ARE EXPRESSLY LIMITED TO THE DURATION OF THE LIMITED WARRANTIES SET FORTH ABOVE. WITH THE EXCEPTION OF ANY WARRANTIES IMPLIED BY THE LAW OF ANY STATE OF THE U.S.A. AS HEREBY LIMITED, THE FOREGOING WARRANTY IS EXCLUSIVE AND IN LIEU OF ALL OTHER WARRANTIES, GUARANTEES, AGREEMENTS, AND SIMILAR OBLIGATIONS OF TACP WITH RESPECT TO THE REPAIR OR REPLACEMENT OF ANY PARTS. IN NO EVENT SHALL TACP BE LIABLE FOR CONSEQUENTIAL OR INCIDENTAL DAMAGES (INCLUDING, BUT NOT LIMITED TO, LOST PROFITS, BUSINESS INTERRUPTION, OR MODIFICATION OR ERASURE OF RECORDED DATA CAUSED BY USE, MISUSE OR INABILITY TO USE THIS LCD TELEVISION).

No person, agent, distributor, dealer, or company is authorized to change, modify, or extend the terms of these warranties in any manner whatsoever. The time within which an action must be commenced to enforce any obligation of TACP arising under the warranty or under any statute or law of the United States or any state thereof is hereby limited to ninety (90) days from the date you discover, or should have discovered, the defect. This limitation does not apply to implied warranties arising under the law of any state of the U.S.A.

THIS WARRANTY GIVES YOU SPECIFIC LEGAL RIGHTS AND YOU MAY ALSO HAVE OTHER RIGHTS WHICH MAY VARY FROM STATE TO STATE IN THE U.S.A. SOME STATES OF THE U.S.A. DO NOT ALLOW LIMITATIONS ON THE DURATION OF AN IMPLIED WARRANTY, WHEN AN ACTION MAY BE BROUGHT, OR THE EXCLUSION OR LIMITATION OF INCIDENTAL OR CONSEQUENTIAL DAMAGES. THEREFORE, THE ABOVE PROVISIONS MAY NOT APPLY TO YOU UNDER SUCH CIRCUMSTANCES.

Limited Canadian Warranty

for Toshiba Brand Flat Panel Televisions

Toshiba of Canada Limited ("TCL") makes the following limited warranties to original consumers in Canada. THESE LIMITED WARRANTIES EXTEND TO THE ORIGINAL CONSUMER PURCHASER OR ANY PERSON RECEIVING THIS TOSHIBA BRAND FLAT PANEL TELEVISION (the "TELEVISION(S)" or "Television(s)") AS A GIFT FROM THE ORIGINAL CONSUMER PURCHASER AND TO NO OTHER PURCHASER OR TRANSFEREE.

TELEVISIONS PURCHASED IN CANADA, AND USED ANYWHERE OUTSIDE OF CANADA INCLUDING, WITHOUT LIMITATION, THE UNITED STATES AND MEXICO, ARE NOT COVERED BY THESE WARRANTIES.

TELEVISIONS PURCHASED ANYWHERE OUTSIDE OF CANADA, INCLUDING, WITHOUT LIMITATION, THE UNITED STATES AND MEXICO, AND USED IN CANADA, ARE NOT COVERED BY THESE WARRANTIES.

Limited One (1) Year Warranty on Parts and Labour

Subject to the more limited warranty if the Television is used for any commercial or business purposes as set out below, TCL warrants the Television and its parts against material defects in materials or workmanship that result in the Television failing for a period of one (1) year after the date of original retail purchase. DURING THIS PERIOD, TCL WILL, AT TCL'S OPTION, REPAIR OR REPLACE A DEFECTIVE PART WITH A NEW OR REFURBISHED PART WITHOUT CHARGE TO YOU FOR PARTS OR LABOUR.

- (a) FOR TELEVISIONS 32 INCHES OR LESS: YOU MUST DELIVER THE ENTIRE TELEVISION TO A TCL TELEVISION AUTHORIZED SERVICE PROVIDER ("ASP"). YOU MUST PAY FOR ALL TRANSPORTATION AND INSURANCE CHARGES FOR THE TELEVISION TO AND FROM THE ASP.
- (b) FOR TELEVISIONS OVER 32 INCHES: During this period, ASP personnel will come to your home when warranty service is required. Depending on the type of repair required, the service will either be performed in your home or the Television will be taken to an ASP for repair and returned to your home at no cost to you. **IN-HOME SERVICE ONLY APPLIES WITHIN 100 KILOMETERS OF AN ASP. IF YOU ARE NOT WITHIN 100 KILOMETERS OF AN ASP, YOU MUST DELIVER THE ENTIRE TELEVISION TO AN ASP. YOU MUST PAY FOR ALL TRANSPORTATION AND INSURANCE CHARGES FOR THE TELEVISION TO AND FROM THE ASP.**

Limited Warranty for Commercial Units

TCL warrants Televisions that are used for any commercial or business purposes as follows: all parts are warranted against material defects in materials or workmanship that result in the Television failing for a period of ninety (90) days after the date of original retail purchase. DURING THIS PERIOD, TCL WILL, AT TCL'S OPTION, REPAIR OR REPLACE THE DEFECTIVE PART WITH A NEW OR REFURBISHED PART WITHOUT CHARGE TO YOU.

- (c) FOR TELEVISIONS 32 INCHES OR LESS: YOU MUST DELIVER THE ENTIRE TELEVISION TO AN ASP. YOU MUST PAY FOR ALL TRANSPORTATION AND INSURANCE CHARGES FOR THE TELEVISION TO AND FROM THE ASP.

- (d) FOR TELEVISIONS OVER 32 INCHES: During this period, ASP personnel will come on-site when warranty service is required. Depending on the type of repair required, the service will either be performed on-site or the Television will be taken to an ASP for repair and returned at no cost to you. **ON-SITE SERVICE ONLY APPLIES WITHIN 100 KILOMETERS OF AN ASP. IF YOU ARE NOT WITHIN 100 KILOMETERS OF AN ASP, YOU MUST DELIVER THE ENTIRE TELEVISION TO AN ASP. YOU MUST PAY FOR ALL TRANSPORTATION AND INSURANCE CHARGES FOR THE TELEVISION TO AND FROM THE ASP.**

Rental Units

The warranty for Television rental units begins with the date of first rental or thirty (30) days from the date of shipment to the rental firm, whichever comes first.

Your Responsibility

THE ABOVE WARRANTIES ARE SUBJECT TO THE FOLLOWING CONDITIONS:

- (1) You must provide your bill of sale or other proof of purchase.
- (2) All warranty servicing of this Television must be performed by an ASP.
- (3) The warranties from TCL are effective only if the Television is (i) purchased as new and unopened from TCL or from TCL's authorized distributors, dealers or resellers ("ADR's") and (ii) located/operated in Canada.
- (4) Labour charges for set installation, setup, adjustment of customer controls, and installation or repair of antenna systems are not covered by these warranties. Reception problems caused by inadequate antenna systems are your responsibility.
- (5) Warranties extend only to material defects in materials or workmanship as limited above, and do not extend to:
 - a. Service, repairs or replacement made necessary by accident, misuse, abuse, moisture, liquids, dust, dirt, neglect, accident, damage, 24/7 applications, improper installation, improper operation, improper cleaning, improper maintenance, normal wear and tear, screen burn or image retention caused by prolonged display of static images and/or phosphor aging, or any other external cause or event, act or omission outside the control of TCL, including fire, theft, acts of God, alteration, power failures, power surges or power shortages, lightning, other electrical faults, or repairs, modifications or replacements by persons other than those authorized by TCL to service the Television;
 - b. Replacement of missing, discarded or lost parts, the provision of retrofits, or preventive maintenance;
 - c. Repair of damage that is cosmetic only or does not affect the Television functionality, such as wear and tear, scratches and dents;
 - d. Service on Toshiba-branded accessory items (such accessory items may be covered by their own warranty);
 - e. Service on third party products or service made necessary by use of incompatible third party products;
 - f. Service made necessary by the simultaneous use of this Television and connected equipment;
 - g. Modifications to the Television not approved in writing by TCL, and service made necessary by the use or installation of non-Toshiba modifications to the Television;
 - h. Service of a Television on which the TOSHIBA label or logo, rating label or serial number have been defaced or removed;
 - i. On-site service and repair of the Television; and
 - j. Damage to the Television caused by failure to follow the specifications, User manuals or guides as to usage and/or storage.

(continued)

Disclaimer and Limitation of Remedy

TO THE EXTENT NOT PRECLUDED BY LAW, ALL OTHER EXPRESS AND IMPLIED WARRANTIES, CONDITIONS AND REPRESENTATIONS FOR THIS TELEVISION, INCLUDING THE IMPLIED WARRANTIES, CONDITIONS AND REPRESENTATIONS OF MERCHANTABILITY AND FITNESS FOR A PARTICULAR PURPOSE, ARE HEREBY DISCLAIMED AND EXCLUDED. IF THE APPLICABLE LAW, STATUTORY OR OTHERWISE, PRECLUDES THE EXCLUSION OF ANY IMPLIED WARRANTIES, CONDITIONS AND REPRESENTATIONS THEN SUCH IMPLIED WARRANTIES, CONDITIONS AND REPRESENTATIONS ARE OTHERWISE LIMITED IN DURATION TO THE TERM OF THIS EXPRESS WRITTEN LIMITED WARRANTY. TO THE EXTENT NOT PRECLUDED BY LAW, STATUTORY OR OTHERWISE, THIS WRITTEN WARRANTY SUPERCEDES AND SPECIFICALLY DISCLAIMS ANY OTHER WARRANTY, CONDITION OR REPRESENTATION NOT STATED IN THIS WARRANTY, WHETHER MADE BY TCL, TOSHIBA CORPORATION, THEIR AFFILIATES, ADRs AND ASPs AND WHETHER MADE ORALLY OR IN WRITING (INCLUDING ANY STATEMENT IN ANY BROCHURE, PRESS RELEASE, ANNOUNCEMENT, ADVERTISEMENT, POINT OF SALE DISPLAY, ETC.).

YOU MUST READ AND FOLLOW ALL SET-UP AND USAGE INSTRUCTIONS IN THE APPLICABLE USER GUIDES AND/OR MANUALS. IF YOU FAIL TO DO SO, THIS TELEVISION MAY NOT FUNCTION PROPERLY AND YOU MAY SUFFER DAMAGE. THIS WARRANTY WILL NOT COVER ANY SERVICE THAT IS REQUIRED, IN PART OR IN WHOLE, AS A RESULT OF ANY FAILURE TO FOLLOW THE SET-UP AND USAGE INSTRUCTIONS. THIS WARRANTY DOES NOT APPLY AND SHALL BE VOID AND UNENFORCEABLE IF THE TELEVISION IS OPENED, SERVICED, OR REPAIRED BY PERSONS OTHER THAN THOSE AUTHORIZED BY TCL TO SERVICE OR REPAIR THE TELEVISION.

IF THE TELEVISION FAILS TO WORK AS WARRANTED ABOVE, YOUR SOLE AND EXCLUSIVE REMEDY SHALL BE REPAIR OR REPLACEMENT OF THE DEFECTIVE PART. IN NO EVENT WILL TCL, TOSHIBA CORPORATION, THEIR AFFILIATES, ADRs OR ASPs (THE "RELATED PARTIES") BE LIABLE TO YOU OR ANY THIRD PARTY FOR ANY DAMAGES, MONEY, REIMBURSEMENT, COSTS OR EXPENSES. THIS LIMITATION APPLIES TO DAMAGES, MONEY, REIMBURSEMENT, COSTS OR EXPENSES OF ANY KIND WHATSOEVER INCLUDING ANY DIRECT OR INDIRECT DAMAGES, DAMAGE TO PROPERTY OR PERSON, LOST PROFITS, LOST SAVINGS, INCONVENIENCE OR OTHER SPECIAL, INCIDENTAL, EXEMPLARY OR CONSEQUENTIAL DAMAGES, WHETHER FOR BREACH OF WARRANTY, BREACH OF CONTRACT, TORT (INCLUDING NEGLIGENCE), UNDER A STATUTE OR UNDER ANY OTHER LAW OR FORM OR ACTION, OR WHETHER ARISING OUT OF THE USE OF OR INABILITY TO USE THE TELEVISION, EVEN IF ANY OF THE RELATED PARTIES HAS BEEN ADVISED OF THE POSSIBILITY OF SUCH DAMAGES OR OF ANY CLAIM BY ANY OTHER PARTY.

No person, agent, distributor, dealer or company is authorized to change, modify or extend the terms of these warranties in any manner whatsoever.

Arbitration and Dispute Resolution

To the extent not precluded by law, any claim, dispute, controversy or disagreement (whether for breach of warranty, breach of contract, tort (including negligence), under a statute or under any other law or form of action) against any of the Related Parties arising out of, or otherwise relating to: (i) this warranty; (ii) the Television; (iii) any oral or written representations, statements, brochures, press releases, advertising, announcement, point of sale display, or promotional material relating to the Television; (iv) the relationships that result from this warranty, (the foregoing claims, disputes controversies and disagreements are collectively referred to as the "Dispute"), shall be referred to and resolved by final and binding arbitration (to the exclusion of the courts). To the extent not precluded by law, you agree to waive any right that you may have to commence or participate in any representative or class proceeding against the Related Parties relating to any Dispute. If and where applicable and to the extent not precluded by law, you further

agree to opt out of any such representative or class proceedings. Arbitration of any Dispute will be conducted in the forum and in the manner as agreed to between you and TCL. Failing such agreement, the arbitration will be conducted by one arbitrator pursuant to the laws and rules relating to arbitration generally in force in the jurisdiction in which you reside at the time that the Dispute arises. To the extent not precluded by law, no claim, dispute, controversy or disagreement of any other person may be joined or combined with any Dispute by you, without the prior written consent of TCL.

Critical Applications

The Television you have purchased is not designed for any "critical applications." "Critical applications" means life support systems, medical applications, connections to implanted medical devices, commercial transportation, nuclear facilities or systems or any other applications where Television failure could lead to injury to persons or loss of life or catastrophic property damage.

IF THE CUSTOMER USES THE TELEVISION IN ANY CRITICAL APPLICATION, THE CUSTOMER - AND NOT TCL, ITS AFFILIATES, ADRs OR ASPs - ASSUME SOLE AND FULL RESPONSIBILITY FOR SUCH USE. TCL RESERVES THE RIGHT TO REFUSE TO SERVICE ANY TELEVISION USED IN A CRITICAL APPLICATION. TCL, ITS AFFILIATES, ADRs AND ASPs HEREBY DISCLAIM ANY AND ALL LIABILITY, DAMAGES AND CONSEQUENCES ARISING OUT OF THE SERVICE OR REFUSAL TO SERVICE SUCH TELEVISION AND FURTHER DISCLAIM ANY AND ALL LIABILITY, CONSEQUENCES AND DAMAGES THAT MAY ARISE OR RESULT FROM THE USE OF THE TELEVISION IN ANY CRITICAL APPLICATIONS.

General Provisions

If and to the extent that any provision of this limited warranty should generally be found to be unenforceable, the unenforceable provision shall be severed from the warranty and deemed not to form part of the warranty. The remaining provisions of this warranty shall be and remain valid and enforceable. If and to the extent that any provision of this limited warranty as it relates to any of the Related Parties is found to be invalid or unenforceable in respect of that party (the "Excluded Party"), the Excluded Party shall be deemed to be severed or excluded from the provision, and the provision shall remain valid, enforceable and applicable in respect of the other or remaining Related Parties.

To the extent permitted by law, this limited warranty shall be governed and construed in accordance with the laws of Ontario.

If there is any inconsistency between this limited warranty, on the one hand, and any statement in the packaging of the Television or in any other document enclosed with, or used in the context of the promotion or sale of, the Television, on the other hand, the provisions of this limited warranty shall prevail.

How to Obtain Warranty Services

If, after following all of the operating instructions in this manual and checking the "Troubleshooting" section, you find that service is needed:

- (1) To find the nearest ASP, visit TCL's web site at www.toshiba.ca, or call toll free 1-800-268-3404
- (2) Present your bill of sale or other proof of purchase to the ASP.

For additional information, visit TCL's website at www.toshiba.ca

A copy of the GPL source code in this product may be obtained by contacting Toshiba Consumer Solutions at (800)631-3811. There will be a charge to cover the costs of providing the source code.

A copy of the LGPL source code in this product may be obtained by contacting Toshiba Consumer Solutions at (800)631-3811. There will be a charge to cover the costs of providing the source code.

Portions of this software are copyright © <2007> The FreeType Project (www.freetype.org). All rights reserved.

This software is based in part on the work of the Independent JPEG Group.

Index

- A**
- Antenna input configuration 29
 - Audio quality adjustments 45
 - Audio system connection 18
 - Auto aspect 41
 - Auto power off 54
- B**
- Base closed captions 43
 - Blocking channels 48
- C**
- CableClear® 56
 - CH ▲▼ buttons 21, 38
 - CH RTN button 21, 39
 - Channel Browser™ 36
 - Channel labeling 31
 - Channel Number buttons 21, 38
 - Channel programming
 - Automatic programming 30
 - Manually adding and deleting... 30
 - Channel Tuning Mode 38
 - Cinema mode 42
 - Closed captions 43
 - Color temperature 56
 - ColorMaster™ 57
 - ColorStream® 14
 - Component video 14
- D**
- Deep Color 53
 - Digital Audio Out 18
 - Digital audio selector 44
 - Digital CC Settings 43
 - Digital signal meter 33
 - Dolby Digital 18
 - Dolby Digital Dynamic Range
 - Control 46
 - DVD player connection 14
 - DVI connection 16
 - DynaLight™ 42
 - Dynamic Bass Boost 58
 - Dynamic contrast 55
- F**
- FREEZE 42
- G**
- Game Mode feature 57
 - GameTimer® 49
- H**
- HDMI audio mode 32
 - HDMI settings
 - Deep Color 53
 - Lip-Sync Latency 53
 - HDMI™ connection 16
- I**
- INFO button 54
 - INPUT button 35
 - Integrated digital tuning 9
 - IR blaster 15
 - IR OUT connection 15
- L**
- Labeling video input 35
 - Language selection 29
 - Last mode memory feature 54
 - LED indications 10, 61
 - Lip-Sync Latency 53
 - LOCKS menu
 - Channels, blocking 48
 - Enable rating blocking 47
 - New PIN code 47
 - Panel lock 49
 - Unlocking programs
 - temporarily 48
 - Video inputs, locking 49
 - Locks menu 46
- M**
- MPEG noise reduction 56
 - MTS feature 45
 - MUTE button 44
- O**
- Optical audio output format 46
- P**
- PC Audio 50
 - PC connection 19
 - PC settings 50
 - Picture mode 42
 - Picture quality 42
 - Picture scroll 41
 - Picture size selection 39
 - POWER button 10, 21
 - Power-On Mode 34
- R**
- RECALL button 54
 - REGZA-LINK connection 17
 - REGZA-LINK feature 51
 - Remote control
 - Battery installation 20
 - Device code table 25
 - Functional key chart 23
 - Programming 24
 - Reset Factory Defaults 34
- S**
- SAP sound 45
 - Satellite receiver connection 14
 - Scroll settings 41
 - Sleep timer 51
 - StableSound® 45
 - Stereo Extension 58
 - Stereo sound 45
 - SurfLock™ 39
 - System status 34
- T**
- TheaterLock™ feature 43
 - TheaterWide® picture size 40
 - Time Zone 33
 - TV status information 54
- V**
- V-Chip blocking (Locks menu) 46
 - VCR connection 13, 14
 - Video input label 35
 - Video input lock 49
 - Voice Enhancement 58

Notes

Notes

Notes

Notes

Notes

TOSHIBA AMERICA CONSUMER PRODUCTS, L.L.C.

Corporate Headquarters: 82 TOTOWA ROAD, WAYNE, NJ 07470, U.S.A.

NATIONAL SERVICE DIVISION: 1420-B TOSHIBA DRIVE, LEBANON, TN 37087, U.S.A.

TOSHIBA OF CANADA LTD.

HEAD OFFICE: 191 McNABB STREET, MARKHAM, ONTARIO, L3R 8H2, CANADA – TEL: (905) 470-5400

SERVICE CENTERS:

TORONTO: 191 McNABB STREET, MARKHAM, ONTARIO L3R 8H2, CANADA – TEL: (905) 470-5400

MONTREAL: 18050 TRANS CANADA, KIRKLAND, QUEBEC, H9J 4A1, CANADA – TEL: (514) 390-7766

VANCOUVER: 13551 COMMERCE PARKWAY, SUITE 110, RICHMOND, B.C., V6V 2L1, CANADA – TEL: (604) 303-2500

MANUFACTURED BY

TOSHIBA ELECTROMEX, S.A. DE C.V.

CableClear, ColorStream, GameTimer, StableSound, and TheaterWide are registered trademarks of Toshiba America Consumer Products, L.L.C.

Channel Browser, SurfLock, DynaLight, ColorMaster and TheaterLock are trademarks of Toshiba America Consumer Products, L.L.C.

REGZA is a trademark of Toshiba Corporation.

PRINTED IN USA
(08-01)

TOSHIBA

Free Manuals Download Website

<http://myh66.com>

<http://usermanuals.us>

<http://www.somanuals.com>

<http://www.4manuals.cc>

<http://www.manual-lib.com>

<http://www.404manual.com>

<http://www.luxmanual.com>

<http://aubethermostatmanual.com>

Golf course search by state

<http://golfingnear.com>

Email search by domain

<http://emailbydomain.com>

Auto manuals search

<http://auto.somanuals.com>

TV manuals search

<http://tv.somanuals.com>