

TOSHIBA

OWNER'S MANUAL

Projection Television



COLORSTREAM®



TouchFocus™

46HX83
51HX83
57HX83
65HX83



Owner's Record

The model number and serial number are on the back of your TV. Record these numbers in the spaces below. Refer to these numbers whenever you communicate with your Toshiba dealer about this TV.

Model number:

Serial number:

Introduction

Connecting
your TV

Using the
Remote Control

Setting up
your TV

Using the TV's
Features

Appendix

Index

Dear Customer,

Thank you for purchasing this Toshiba TV. This manual will help you use the many exciting features of your new TV.

Before operating the TV, please read this manual completely, and keep it nearby for future reference.

Safety Precautions

WARNING

TO REDUCE THE RISK OF FIRE OR ELECTRIC SHOCK, DO NOT EXPOSE THIS APPLIANCE TO RAIN OR MOISTURE.

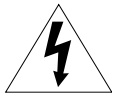

WARNING
RISK OF ELECTRIC SHOCK
DO NOT OPEN



WARNING: TO REDUCE THE RISK OF ELECTRIC SHOCK, DO NOT REMOVE COVER (OR BACK). NO USER-SERVICEABLE PARTS INSIDE. REFER SERVICING TO QUALIFIED SERVICE PERSONNEL.



The lightning symbol in the triangle tells you that the voltage inside this product may be strong enough to cause an electric shock. **DO NOT TRY TO SERVICE THIS PRODUCT YOURSELF.**



The exclamation mark in the triangle tells you that important operating and maintenance instructions follow this symbol.

NOTE TO CATV INSTALLERS IN THE USA

This is a reminder to call the CATV system installer's attention to Article 820-40 of the NEC, which provides guidelines for proper grounding and, in particular, specifies that the cable ground shall be connected to the grounding system of the building, as close to the point of cable entry as practical. For additional antenna grounding information, see items 25 and 26 on page 4.

NOTICE OF POSSIBLE TV STAND INSTABILITY



DANGER: RISK OF SERIOUS PERSONAL

INJURY OR DEATH! Use this TV with

the TOSHIBA TV stand recommended in the

"Specifications" section only. Use with other stands may result in instability, causing possible injury or death.

NOTICE OF POSSIBLE ADVERSE EFFECTS ON TV PICTURE TUBE

If a fixed (non-moving) pattern remains on the TV screen for long periods of time, the image can become permanently engrained in the picture tube. **This type of damage is NOT COVERED BY YOUR WARRANTY.** See item 33 on page 4.

Child Safety

It Makes A Difference Where Your TV Stands



Congratulations on your purchase! As you enjoy your new TV, keep these safety tips in mind:

The Issue

- If you are like most consumers, you have a TV in your home. Many homes, in fact, have more than one TV.
- The home theater entertainment experience is a growing trend, and larger TVs are popular purchases; however, they are not always supported on the proper TV stands.
- Sometimes TVs are improperly secured or inappropriately situated on dressers, bookcases, shelves, desks, audio speakers, chests, or carts. As a result, TVs may fall over, causing unnecessary injury.

Toshiba Cares!

- The consumer electronics industry is committed to making home entertainment enjoyable and safe.
- The Consumer Electronics Association formed the Home Entertainment Support Safety Committee, comprised of TV and consumer electronics furniture manufacturers, to advocate children's safety and educate consumers and their families about television safety.

Tune Into Safety

- One size does NOT fit all! Use appropriate furniture large enough to support the weight of your TV (and other electronic components).
- Use appropriate angle braces, straps, and anchors to secure your furniture to the wall (but never screw anything directly into the TV).
- Carefully read and understand the other enclosed instructions for proper use of this product.
- Do not allow children to climb on or play with furniture and TVs.
- Avoid placing any item on top of your TV (such as a VCR, remote control, or toy) that a curious child may reach for.
- Remember that children can become excited while watching a program and can potentially push or pull a TV over.
- Share our safety message about this hidden hazard of the home with your family and friends. Thank you!



2500 Wilson Blvd.
Arlington, VA 22201 U.S.A.
Tel. 703-907-7600 Fax 703-907-7690
www.CE.org

CEA is the Sponsor, Producer and Manager of the International CES®

Important Safety Instructions

- 1) **Read these instructions.**
- 2) **Keep these instructions.**
- 3) **Heed all warnings.**
- 4) **Follow all instructions.**



- 5) **Do not use this apparatus near water.**



- 6) **Clean only with a dry cloth.**

- 7) **Do not block any ventilation openings.** Install in accordance with the manufacturer's instructions.



- 8) **Do not install near any heat sources** such as radiators, heat registers, stoves, or other apparatus (including amplifiers) that produce heat.

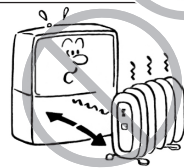

- 9) **Do not defeat the safety purpose of the polarized or grounding type plug.** A polarized plug has two blades with one wider than the other. A grounding type plug has two blades and a third grounding prong. The wide blade or the third prong are provided for your safety. If the provided plug does not fit into your outlet, consult an electrician for replacement of the obsolete outlet.

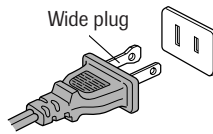

- 10) **Protect the power cord** from being walked on or pinched, particularly at plugs, convenience receptacles, and the point where it exits the apparatus.

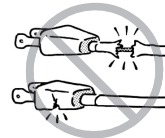

- 11) **Only use attachments/accessories specified by the manufacturer.**

- 12) **Use only with the cart, stand, tripod, bracket, or table specified by the manufacturer, or sold with the apparatus.** When a cart is used, use caution when moving the cart/apparatus combination to avoid injury from tip-over.



- 13) **Unplug this apparatus during lightning storms or when unused for long periods of time.**

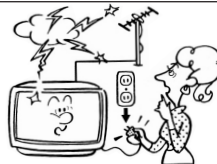

- 14) **Refer all servicing to qualified service personnel.**

Service is required when the apparatus has been damaged in any way, such as power supply cord or plug is damaged, liquid has been spilled or objects have fallen into the apparatus, the apparatus has been exposed to rain or moisture, does not operate normally, or has been dropped.

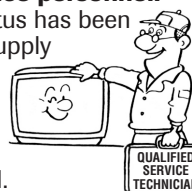

- 15) **CAUTION:** To reduce the risk of electric shock, do not use the polarized plug with an extension cord, receptacle, or other outlet unless the blades can be inserted completely to prevent blade exposure.

Installation, Care, and Service

Installation

Follow these recommendations and precautions and heed all warnings when installing your TV:

- 16) Never modify this equipment. Changes or modifications may void: a) the warranty, and b) the user's authority to operate this equipment under the rules of the Federal Communications Commission.

- 17) **DANGER: RISK OF SERIOUS PERSONAL INJURY, DEATH, OR EQUIPMENT DAMAGE!** Never place the TV on an unstable cart, stand, or table. The TV may fall, causing serious personal injury, death, or serious damage to the TV.



- 18) Never place or store the TV in direct sunlight; hot, humid areas; areas subject to excessive dust or vibration; or locations with temperatures at or below 41°F (5°C).

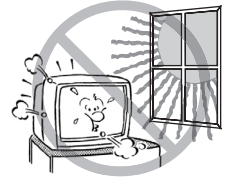

- 19) Always place the TV on the floor or a sturdy, level, stable surface that can support the weight of the unit.



- 20) Never place items such as vases, aquariums, or candles on top of the TV.



- 21) Never block or cover the slots or openings in the TV cabinet back, bottom, and sides. Never place the TV:

- on a bed, sofa, rug, or similar surface;
- too close to drapes, curtains, or walls; or
- in a confined space such as a bookcase, built-in cabinet, or any other place with poor ventilation.



The slots and openings are provided to protect the TV from overheating and to help maintain reliable operation of the TV.



- 22) Never allow anything to rest on or roll over the power cord, and never place the TV where the power cord is subject to wear or abuse.

- 23) Never overload wall outlets and extension cords.



- 24) Always operate this equipment from a 120 VAC, 60 Hz power source only.

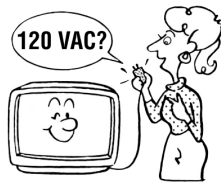

- 25) Always make sure the antenna system is properly grounded to provide adequate protection against voltage surges and built-up static charges (see Section 810 of the National Electric Code).

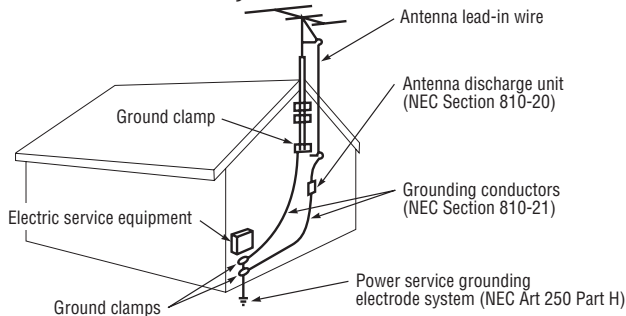

- 26) **! DANGER: RISK OF SERIOUS PERSONAL INJURY OR DEATH!**
- Use extreme care to make sure you are never in a position where your body (or any item you are in contact with, such as a ladder or screwdriver) can accidentally touch overhead power lines. Never locate the antenna near overhead power lines or other electrical circuits.
 - Never attempt to install any of the following during lightning activity:
 - a) an antenna system; or b) cables, wires, or any home theater component connected to an antenna or phone system.

Care

For better performance and safer operation of your TOSHIBA TV, follow these recommendations and precautions:

- 27) Always sit approximately 10–25 feet away from the TV and as directly in front of it as possible. The picture can appear dull if you sit too far to the left or right of the TV, or if sunlight or room lights reflect on the screen. Turn the TV off to check for reflections on the screen, and then remove the source of reflections while viewing the TV.

- 28) Always unplug the TV before cleaning. Never use liquid or aerosol cleaners.

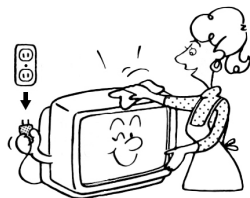

- 29) **! WARNING: RISK OF ELECTRIC SHOCK!** Never spill liquids or push objects of any kind into the TV cabinet slots.

- 30) [This item applies to projection TVs only.] If the air temperature rises suddenly (for example, when the TV is first delivered), condensation may form on the lenses. This can make the picture appear distorted or the color appear faded. If this happens, turn off the TV for 6 to 7 hours to allow the condensation to evaporate.

- 31) For added protection of your TV from lightning and power surges, always unplug the power cord and disconnect the antenna from the TV if you leave the TV unattended or unused for long periods of time.

- 32) During normal use, the TV may make occasional snapping or popping sounds. This is normal, especially when the unit is being turned on or off. If these sounds become frequent or continuous, unplug the power cord and contact a Toshiba Authorized Service Center.

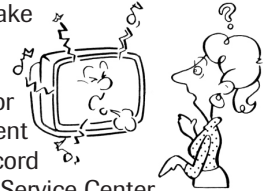

- 33) **Possible Adverse Effects on TV Picture Tube:** If a fixed (non-moving) pattern remains on the TV screen for long periods of time, the image can become permanently engrained in the picture tube and cause subtle but permanent ghost images. **This type of damage is NOT COVERED BY YOUR WARRANTY.** Never leave your TV on for long periods of time while it is displaying the following formats or images:

- **Fixed Images**, such as PIP/POP windows, stock tickers, video game patterns, TV station logos, and websites.
- **Special Formats** that do not use the entire screen. For example, viewing letterbox style (16:9) media on a normal (4:3) display (gray bars at top and bottom of screen); or viewing normal style (4:3) media on a widescreen (16:9) display (gray bars on left and right sides of screen).

Service

- 34) **! WARNING: RISK OF ELECTRIC SHOCK!** Never attempt to service the TV yourself. Opening and removing the covers may expose you to dangerous voltage or other hazards. Refer all servicing to a Toshiba Authorized Service Center.

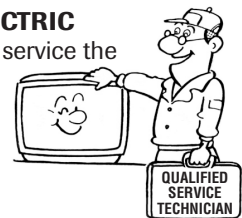

- 35) If you have the TV serviced:

- Ask the service technician to use only replacement parts specified by the manufacturer.
- Upon completion of service, ask the service technician to perform routine safety checks to determine that the TV is in safe operating condition.

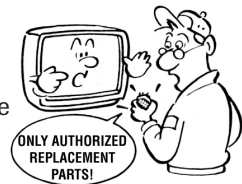

- 36) When the TV reaches the end of its useful life, ask a qualified service technician to properly dispose of the TV. Improper disposal may result in a picture tube implosion and possible personal injury.

Important Safety Precautions for Split Cabinet Feature

(Models 57HX83 and 65HX83 only)

Toshiba TV models 57HX83 and 65HX83 have a split cabinet feature that allows disassembly of the cabinet into two sections during installation.

For details, please refer to the insert titled “Disassembly/ Reassembly Instructions for Split Cabinet Feature” that accompanied this owner’s manual in the accessory pack. If you do not have the insert, you can download a copy of it from our Web site (www.toshiba.com/tacp in the U.S.A. or www.toshiba.ca in Canada). If you do not have access to the Internet, call 1-800-631-3811 in the U.S.A. or 1-800-268-3404 in Canada.



WARNING: If you split the cabinet for any purpose, NEVER energize the bottom section until it is completely and properly installed.

Energizing the disassembled bottom section and subjecting it to intentional misuse (for example, exposing it to a foreign object) creates the potential for an electrical shock hazard that could result in death or serious injury.

CAUTION: If you use the split cabinet feature, ALWAYS handle and treat the top section of the TV cabinet, which contains a glass mirror, with great care. If subjected to excessive mechanical abuse (for example, if bumped or dropped), the mirror may break, creating exposed glass fragments with sharp edges. Contact with these glass fragments may result in injury.

Installation, Care, and Service

CAUTION: The split cabinet feature (models 57HX83 and 65HX83 only) allows disassembly of the cabinet into two sections during installation. If you use the split cabinet feature, follow these precautions while the two sections of the TV cabinet are disassembled:

- 1) Always handle and treat the top section of the TV cabinet (with the viewing screen), which contains a glass mirror, with great care. If subjected to excessive mechanical abuse (for example, if bumped or dropped), the mirror may break, creating exposed glass fragments with sharp edges. Contact with these glass fragments may result in injury.
- 2) Never temporarily locate the disassembled bottom section in an area where it may be exposed to foreign objects or abuse (for example, areas where children may be playing, where items may fall on top of the unit, or where liquids may spill into the unit). Failure to follow this instruction may result in damage to the optic components of the TV. **SUCH DAMAGE IS NOT COVERED UNDER THE TOSHIBA LIMITED WARRANTY.**
- 3) Always keep the top and bottom sections of the TV cabinet in an upright position while disassembled. Failure to follow this instruction may result in damage to the TV, including but not limited to the optic components, cabinet, bezel, and glass mirror. **SUCH DAMAGE IS NOT COVERED UNDER THE TOSHIBA LIMITED WARRANTY.**
- 4) **Never energize the bottom section of the TV cabinet while disassembled. Failure to follow this instruction could result in death or serious injury.**
- 5) Never place anything on top of the bottom section of the TV cabinet. Failure to follow this instruction may result in damage to the optic components. **SUCH DAMAGE IS NOT COVERED UNDER THE TOSHIBA LIMITED WARRANTY.**
- 6) Never store or transport the unit while it is disassembled. Failure to follow this instruction may result in damage to the TV, including but not limited to the optic components, cabinet, bezel, and glass mirror. **SUCH DAMAGE IS NOT COVERED UNDER THE TOSHIBA LIMITED WARRANTY.**

Important Safety Information	2-5
Introduction	7
Welcome to Toshiba	7
Exploring your new TV	7
Note regarding Quick Connect Guide	7
Connecting your TV	8
Connecting a VCR	8
Connecting a cable converter box	9
Connecting a cable converter box and VCR	9
Connecting a DVD player or satellite receiver without component video and a VCR	10
Connecting a DVD player with component video and a VCR	11
Connecting a DTV receiver/set-top box with component video and a VCR	12
Connecting two VCRs	13
Connecting a camcorder	13
Connecting a device to the DVI/HDCP input	14
Connecting devices to the TheaterLink (IR pass-through) OUT jack	15
Connecting an audio system	16
Connecting an A/V receiver	16
Using the remote control	17
Preparing the remote control for use	17
Installing the remote control batteries	17
Remote Control functional key chart	18
Programming the remote control for use with your audio/video devices	20
Device code setup	20
Searching and sampling the code of a device (8500)	20
Using the volume lock feature (8000)	21
Operational feature reset (8900)	21
Multi-brand remote control device codes	22
Learning about the remote control	24
Setting up your TV	25
Learning about the menu system	25
Using the Quick Connect Guide	26
Changing the on-screen display language	27
Selecting the antenna input	27
Adding channels to the TV's memory	28
Programming channels automatically	28
Adding and erasing channels manually	29
Setting up the TheaterLink on-screen IR device control feature	29
Accessing the TheaterLink on-screen IR device control bar	31
TheaterLink™ IR device codes	32
Changing channels	35
Changing channels using SpeedSurf	35
Adjusting the color convergence	35
Automatically adjusting the color convergence using TouchFocus™	35
Manually adjusting the color convergence	36
Using the TV's features	37
Adjusting the channel settings	37
Switching between two channels using Channel Return	37
Switching between two channels using SurfLock™	37
Programming your favorite channels	37
Labeling channels	39
Viewing the wide-screen picture formats	41
Selecting the picture size	41
Scrolling the Theater Wide picture (Theater Wide 2 and 3 only)	42

Using the auto aspect feature	43
Selecting the cinema mode	43
Using the POP double-window feature	44
Switching the main and POP pictures	45
Freezing the POP picture	45
Adjusting the size of the double-window	45
POP/double-window aspect ratio	46
Using the programmed channel search function	46
Using the favorite channel search function	47
About the auto favorite feature	47
Using the LOCKS menu	48
Entering the PIN code	48
If you cannot remember your PIN code	48
Using the V-CHIP menu	49
ENABLE BLOCKING	49
TV RATING (Independent rating system for broadcasters)	49
MPAA RATING (Independent rating system for movies)	50
BLOCKING OPTION	50
Unlocking programs temporarily	51
Locking channels	51
Locking video inputs	52
Using the game timer	53
Using the front panel lock feature	53
Changing the PIN code	53
Adjusting the picture	54
Selecting the picture mode	54
Adjusting the picture quality	54
Saving your new preferences	55
Using the ALS (Ambient Light Sensor) feature	55
Using the flesh tone feature	55
Using the CableClear™ DNR feature (digital noise reduction)	56
Selecting the Scan Velocity Modulation (SVM)	56
Selecting the color temperature	57
Resetting picture adjustments	57
Selecting the display format (480p signals only)	57
Selecting the video input source	58
Labeling the video input sources	58
Using the closed caption feature	59
Setting the ON-timer	60
Setting the sleep timer	60
Setting the clock	61
Adjusting the sound	62
Muting the sound	62
Selecting stereo/SAP broadcasts	62
Using the WOW™ surround sound feature	63
Adjusting the sound quality	63
Resetting your audio adjustments	64
Using the sub-bass system (SBS)	64
Turning off the built-in speakers	65
Selecting the Audio OUT sound	65
Using the StableSound® feature	66
Selecting the background of the menu display	66
Displaying on-screen information	66
Viewing the demo mode	67
Understanding the auto power off feature	67
Understanding the last mode memory feature	67
Appendix	68
Specifications	68
Troubleshooting	69
Limited United States Warranty	70
Limited Canada Warranty	71
Index	75

Introduction

Welcome to Toshiba

Congratulations! You have purchased one of the finest projection TVs on the market. The goal of this manual is to guide you through setting up and operating your Toshiba TV as quickly as possible.

This manual applies to models 46HX83, 51HX83, 57HX83, and 65HX83. Before you start reading, check the model number on the back of your TV.

Instructions in this manual are based on using the remote control. You can also use the controls on the TV if they have the same name as those on the remote control.

Please read all the safety and operating instructions carefully, and keep the manual for future reference.

Exploring your new TV

You can operate your TV using the buttons on the front panel or the remote control. The back panel and front panel (behind the door) provide all the terminal connections you will need to connect other equipment to your TV. See "Connecting your TV" on page 8.

Model 57HX83 is used in this manual for illustration purposes.

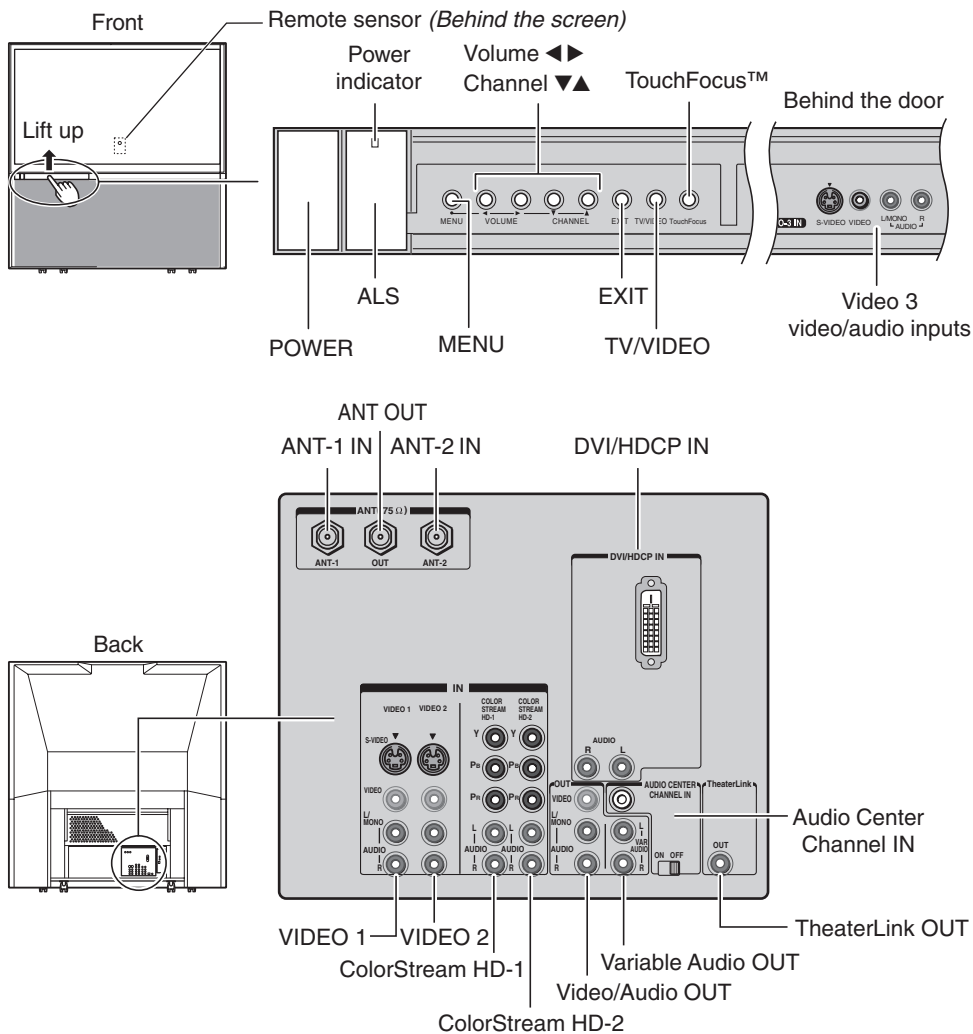

Remote control

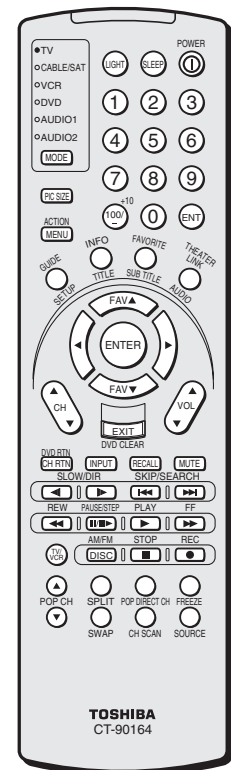

Connecting your TV

Note: Cables are not supplied with your TV.

- **Coaxial cable** is the cable that comes in from your antenna, cable TV service, or cable converter box. Coaxial cable uses “F” connectors.
- **Standard A/V (audio/video) cables** usually come in sets of three, and are typically color-coded according to use: yellow for video, red for stereo right audio, and white for stereo left (or mono) audio. On your TV’s back panel, the standard A/V connectors are color-coded in the same manner as the cables.
- **S-Video cable** is for use with video equipment with S-Video.
- **Component video cables** come in sets of three, and are for use with video equipment that has component video. (ColorStream® is Toshiba’s brand of component video.)
- **DVI-D digital double-link cable** is for use with video equipment that has a DVI-D digital double-link connector (see page 15).

NOTE REGARDING PICTURE QUALITY

When connecting video equipment to your Toshiba TV:

- **For GOOD picture quality:** Use a standard yellow video cable.
- **For BETTER picture quality:** If your equipment has S-video, use an S-video cable *instead of* a standard yellow video cable. (You still must connect the standard red and white audio cables for full system connection, but *do not connect the standard yellow video cable at the same time*, or the picture performance will be unacceptable.)
- **For BEST picture quality:** If your equipment has component video (or DVI), use either component video cables (or a DVI cable) *instead of* a standard video or S-video cable. (You still must connect the standard red and white audio cables for full system connection.)

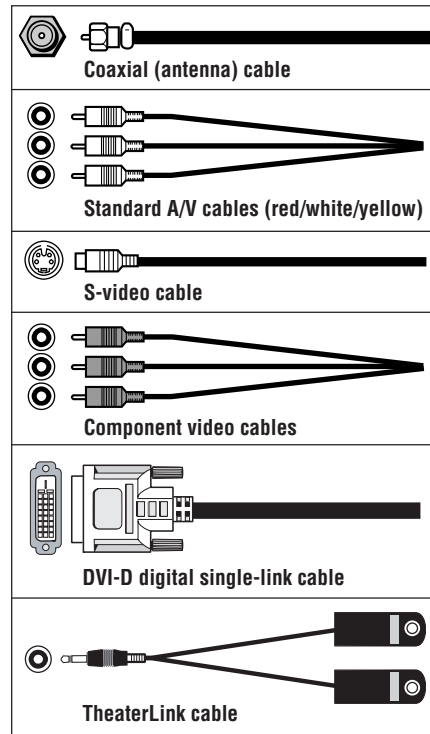

CAUTION:

Do not plug in any power cords until you have finished connecting all equipment.

Connecting a VCR

This connection allows you to watch local channels and video programs, play or record on the VCR while watching TV, and record from one channel while watching another channel.

You will need:

- two coaxial cables
- one set of standard A/V cables

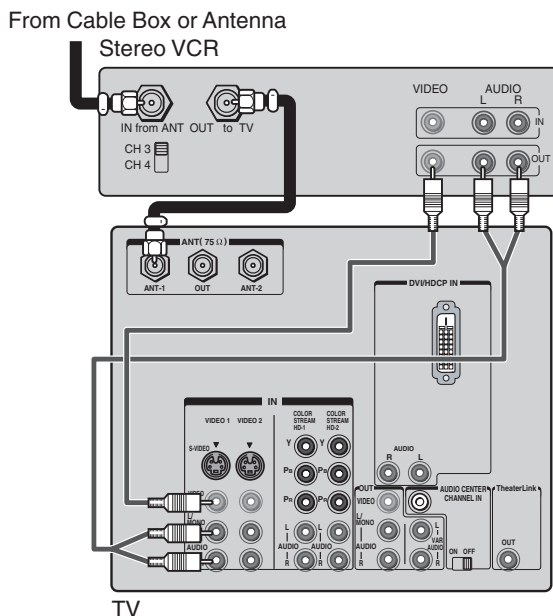

Note:

If you have a mono VCR, connect L/Mono to VCR Audio OUT using only one audio cable.

If you have a VCR with S-video, use an S-video cable instead of a standard video cable.

Do not connect a standard video cable and an S-video cable to VIDEO 1 (or VIDEO 2) at the same time, or the picture performance will be unacceptable.

The unauthorized recording, use, distribution, or revision of television programs, videotapes, DVDs, and other materials is prohibited under the Copyright Laws of the United States and other countries, and may subject you to civil and criminal liability.

Connecting a cable converter box

This connection allows you to watch basic and premium cable channels.

To watch basic cable and use the TV's features, select ANT-1. To view premium channels, select ANT-2, tune the TV to channel 3 or 4 (whichever channel is vacant in your area), and use the converter box to change channels.

You will need:

- three coaxial cables

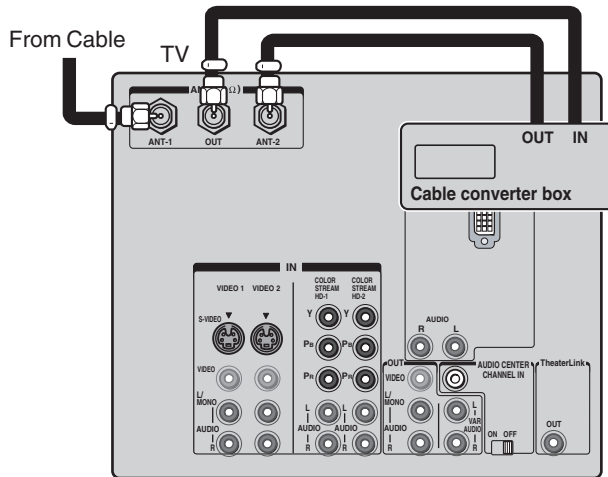

Connecting a cable converter box and VCR

This connection allows you to watch and record basic and premium cable channels, watch videotapes, and record one channel while watching another channel. To watch basic cable and use the TV's features, select ANT-1.

To view premium channels or record with the VCR, select ANT-2, tune the TV to channel 3 or 4 (whichever channel is vacant in your area), and use the converter box to change channels.

You will need:

- four coaxial cables
- one set of standard A/V cables

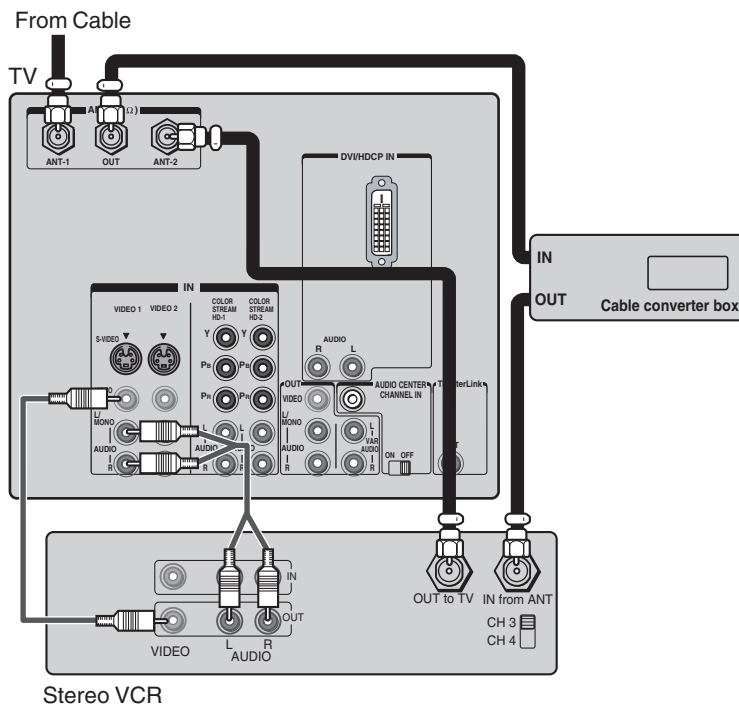

Note:

When you use a converter box with your TV, the remote control will not operate some features, such as programming your favorite channels, labeling channels, and locking channels.

Note:

If you have a mono VCR, connect L/Mono to VCR Audio OUT using only one audio cable.

If you have a VCR with S-video, use an S-video cable instead of a standard video cable. Do not connect a standard video cable and an S-video cable to VIDEO 1 (or VIDEO 2) at the same time or the picture performance will be unacceptable.

When you use a converter box with your TV, the remote control will not operate some features, such as programming your favorite channels, labeling channels, and locking channels.

The unauthorized recording, use, distribution, or revision of television programs, videotapes, DVDs, and other materials is prohibited under the Copyright Laws of the United States and other countries, and may subject you to civil and criminal liability.

Connecting a DVD player or satellite receiver without component video and a VCR

This connection allows you to watch DVD/satellite, VCR, and TV programs, and record one TV channel while watching another channel.

You will need:

- two coaxial cables (three if satellite receiver is used)
- one set of standard A/V cables (between the TV and VCR)
- one pair of audio cables (between the TV and DVD player/satellite receiver)
- one S-video cable (between the TV and DVD player/satellite receiver)

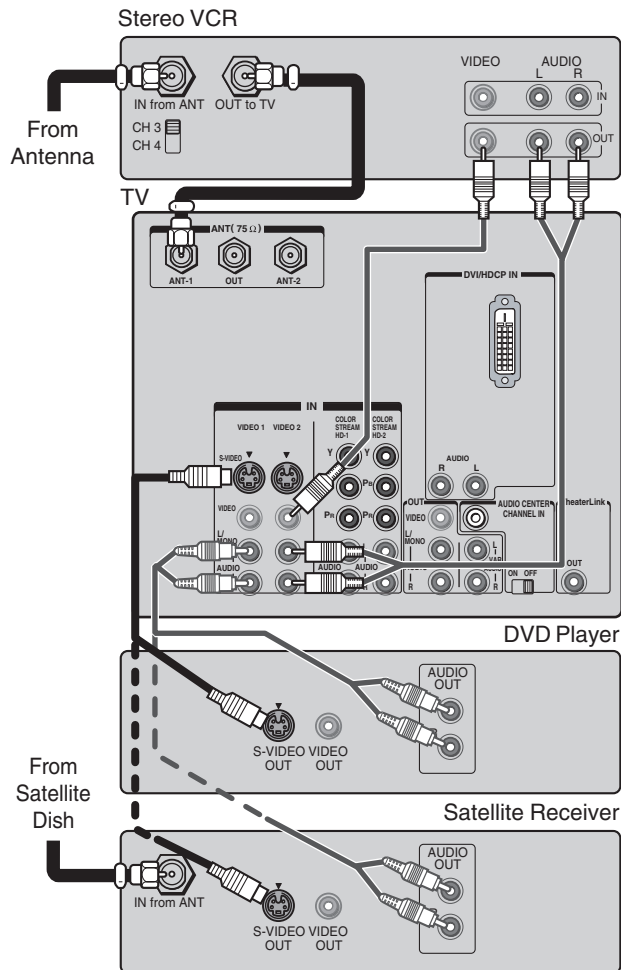

Note:

For the highest possible picture quality from a DVD player/satellite receiver without component video or DVI/HDCP, use an S-video cable. (If your DVD player/satellite receiver has component video, see page 11. If your DVD player/satellite receiver has DVI/HDCP, see page 14).

Do not connect both an S-video cable and a standard video cable to VIDEO 1 (or VIDEO 2) at the same time or the picture performance will be unacceptable.

Do not connect the DVD player/satellite receiver and VCR to the same set of A/V inputs on the TV. (See the illustrations, which show the DVD player/satellite receiver connected to VIDEO 1 on the TV, and the VCR connected to VIDEO 2 on the TV.)

The unauthorized recording, use, distribution, or revision of television programs, videotapes, DVDs, and other materials is prohibited under the Copyright Laws of the United States and other countries, and may subject you to civil and criminal liability.

Connecting a DVD player with component video and a VCR

This connection allows you to watch DVD, VCR, and TV programs, and record TV programs. You can record one channel while watching another channel.

Your TV has ColorStream® (component video) inputs. Connecting a DVD player with component video outputs (such as a Toshiba DVD player with ColorStream®) can greatly enhance picture quality and realism.

- To record one TV program while watching another TV program, tune the VCR to the channel to record and tune the TV to the channel to watch.
- To record a TV program while watching a DVD, tune the VCR to the channel to record and select ColorStream HD-1 on the TV (see “Selecting the antenna input” on page 27).

You will need:

- two coaxial cables
- one set of standard A/V cables
- one pair of audio cables
- one set of component video cables

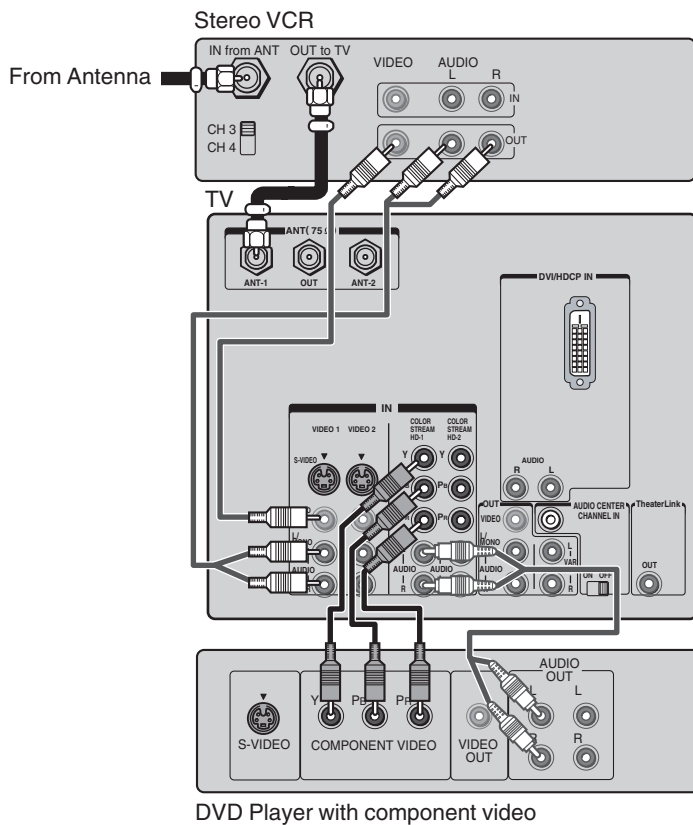

Note:

For the highest possible picture quality, use component video cables (or a DVI-D digital single-link cable) between the TV and DVD player.

You can connect component video cables from the DVD player to either ColorStream jack on the TV (HD-1 or HD-2).

The ColorStream HD-1 and HD-2 jacks can be used with Progressive (480p) and Interlaced (480i, 1080i) scan systems. A 1080i signal will provide the best picture performance.

If your DVD player is not compatible with component video (or DVI/HDCP), use an S-video cable (plus the standard audio cables) instead.

Do not connect both S-Video and standard video cables to VIDEO 1 (or VIDEO 2) at the same time or the picture performance will be unacceptable. See page 10.

The unauthorized recording, use, distribution, or revision of television programs, videotapes, DVDs, and other materials is prohibited under the Copyright Laws of the United States and other countries, and may subject you to civil and criminal liability.

Connecting a DTV receiver/set-top box with component video and a VCR

This connection allows you to watch DTV (digital TV), VCR, and TV programs, and record DTV and TV programs.

Your TV has ColorStream (component video) inputs. Connecting a DTV receiver with component video can greatly enhance picture quality and realism.

- To record and watch a DTV program, select LINE IN on the VCR, and select ColorStream HD-2 on the TV (see “Selecting the antenna input” on page 27).
- To record a TV program while watching a DTV program, tune the VCR to the channel to record, and select ColorStream HD-2 on the TV.
- To record and watch the same TV program, tune the VCR to the channel to record, and select VIDEO 1 on the TV.
- To record one TV program while watching another TV program, tune the VCR to the channel to record, and tune the TV to the channel to watch.

You will need:

- three coaxial cables
- two sets of standard A/V cables
- one pair of audio cables
- one set of component video cables

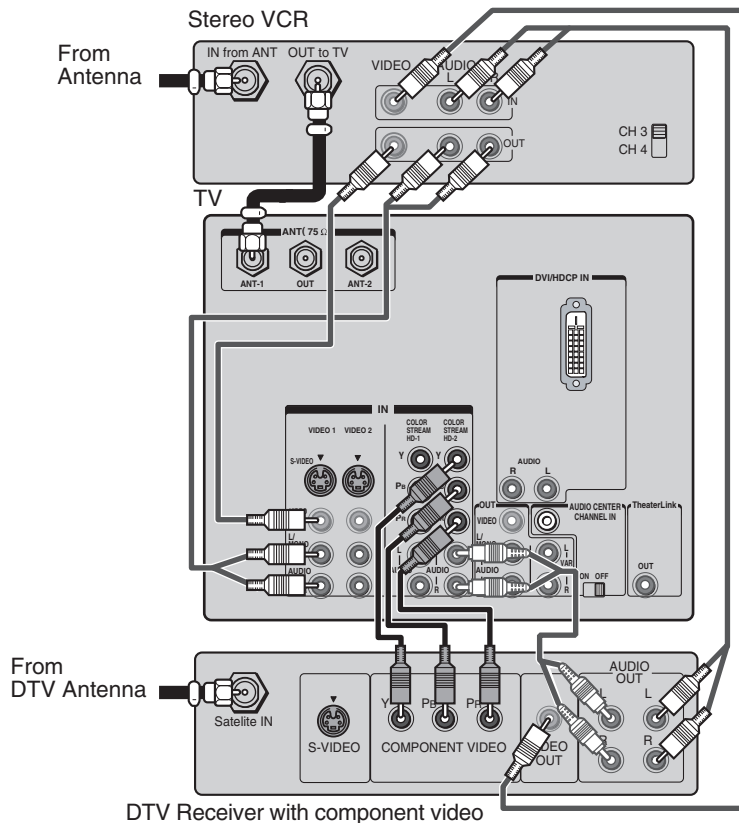

Note:

For the highest possible picture quality, use component video cables (or a DVI-D digital single-link cable) between the TV and DTV receiver/set-top box.

You can connect component video cables to either set of ColorStream jacks on the TV (HD-1 or HD-2).

The ColorStream HD-1 and HD-2 jacks can be used with Progressive (480p) and Interlaced (480i, 1080i) scan systems. A 1080i signal will provide the best picture performance.

For DVI/HDCP connection, see page 14.

If your DTV receiver or set-top box is not compatible with component video (or DVI/HDCP), use the S-video connection (plus the standard audio connections) instead.

Do not connect both S-Video and standard video cables to VIDEO 1 (or VIDEO 2) at the same time or the picture performance will be unacceptable.

To record from the DTV receiver, set the VCR to Line IN. To monitor recording from the DTV receiver, set the VCR to Line IN and set the TV to VIDEO 1.

The unauthorized recording, use, distribution, or revision of television programs, videotapes, DVDs, and other materials is prohibited under the Copyright Laws of the United States and other countries, and may subject you to civil and criminal liability.

Connecting two VCRs

This connection allows you to record (dub/edit) from one VCR to another VCR while watching a videotape. You also can record from one TV channel while watching another TV channel.

You will need:

- two coaxial cables
- two sets of standard A/V cables

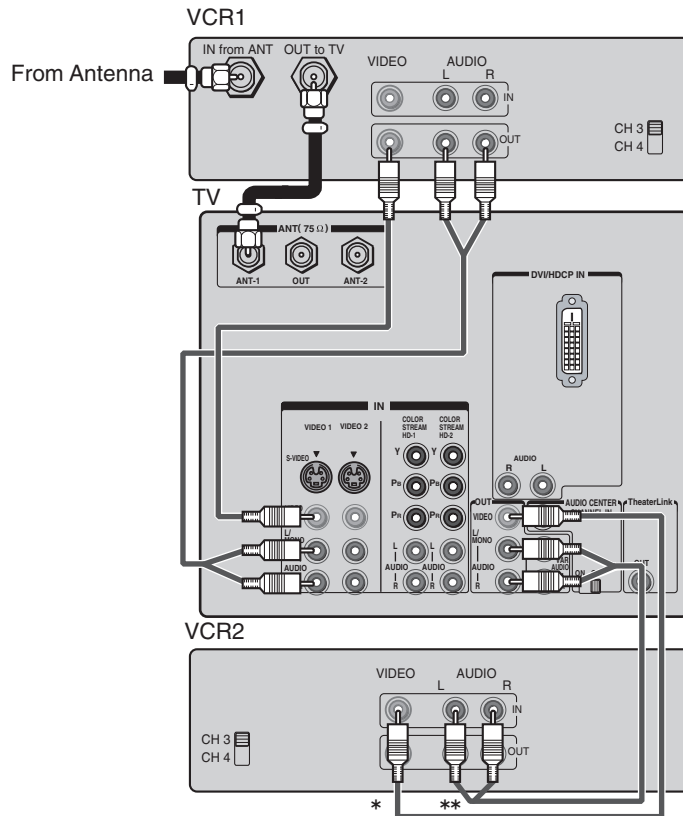

Note:

If VCR1 has S-video, you can use an S-video cable instead of a standard video cable for better picture performance. Do not connect both a standard video cable and an S-video cable to VIDEO 1 (or VIDEO 2) at the same time or the picture performance will be unacceptable.

Do not connect the same VCR to the output and input jacks on the TV at the same time.

To dub or edit, VCR 2 must select Line IN, and the TV must select VIDEO 1 (see "Selecting the antenna input" on page 27).

* The Video OUT jack does not output the POP picture.

** The Audio OUT jacks can output the sound of either the Main or POP picture (see "Selecting the Audio OUT sound" on page 65).

The unauthorized recording, use, distribution, or revision of television programs, videotapes, DVDs, and other materials is prohibited under the Copyright Laws of the United States and other countries, and may subject you to civil and criminal liability.

Connecting a camcorder

This connection allows you to watch video materials recorded on a camcorder.

You will need:

- one set of standard A/V cables

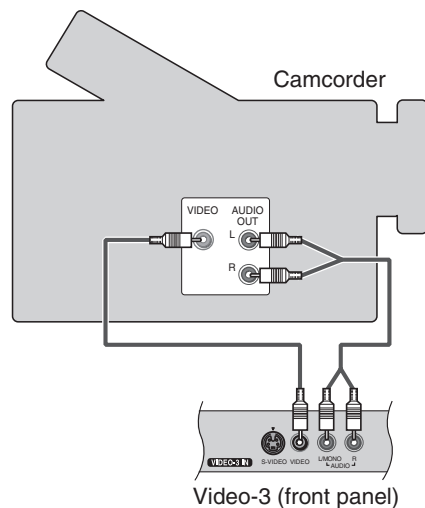

Note:

If you have a camcorder with S-video, use an S-video cable instead of a standard video cable. Do not connect both a standard video cable and an S-video cable at the same time or the picture performance will be unacceptable.

Connecting a device to the DVI/HDCP input

The DVI/HDCP¹ input on your TV is designed to accept HDCP program material in digital form from EIA/CEA-861-compliant² consumer electronic devices, such as a set-top box or DVD player with a DVI-D digital single-link output connection.³

The DVI/HDCP input is designed for best performance with 1080i high-definition video signals. The DVI/HDCP input also will accept and display 480p and 480i picture signals.

Note: This TV is not intended for connection to and should not be used with a PC (personal computer).

You will need:

- one coaxial cable
- one DVI-D digital single-link cable

Note: For proper operation, the DVI-D cable length should not exceed 3m (9.8 ft). The recommended length is 2m (6.6 ft).

- one pair of standard audio cables

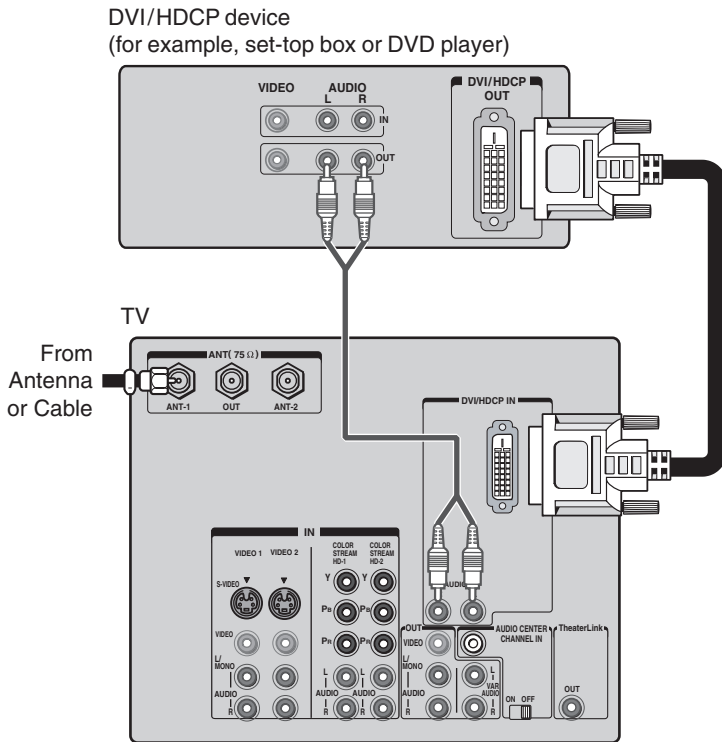

Note:

¹ DVI/HDCP = Digital Visual Interface/ High-bandwidth Digital Content Protection.

² EIA/CEA-861 compliance covers the transmission of uncompressed digital video with high-bandwidth digital content protection, which is being standardized for future reception of high-definition video signals.

³ Consult your consumer electronics dealer for availability.

Caution:

To ensure that the DVI/HDCP device is reset properly, it is recommended that you follow these procedures:

- When turning on your electronic components, **turn on the TV first**, and then the DVI/HDCP device.
- When turning off your electronic components, **turn off the DVI/HDCP device first**, and then the TV.

Connecting devices to the TheaterLink™ (IR pass-through) OUT jack

The TheaterLink IR (infra-red) pass-through feature allows you to remotely operate (through the TV) many infrared-controlled devices (such as a Toshiba infrared-controlled VCR or DVD player) enclosed within an entertainment center or similar cabinet. Without the TheaterLink connection, the device typically would need to be visible to operate it remotely.

You can use the TV's remote control (programmed to operate the device; see pages 18–24) or the device's remote control. Point the remote control at the front of the TV and press the button for the desired function. The signal passes from the remote control through the TV to the device via the TheaterLink cable (included with your TV).

To connect, align the TheaterLink cable's infrared "eye" with the device's infrared sensor and attach it using double-sided mounting tape. Plug the other end of the TheaterLink cable into the TV's TheaterLink OUT jack. You can connect up to two devices with the TheaterLink cable included in the TV's original packaging.

You will need:

- one TheaterLink cable (included)
- two pieces of double-sided mounting tape

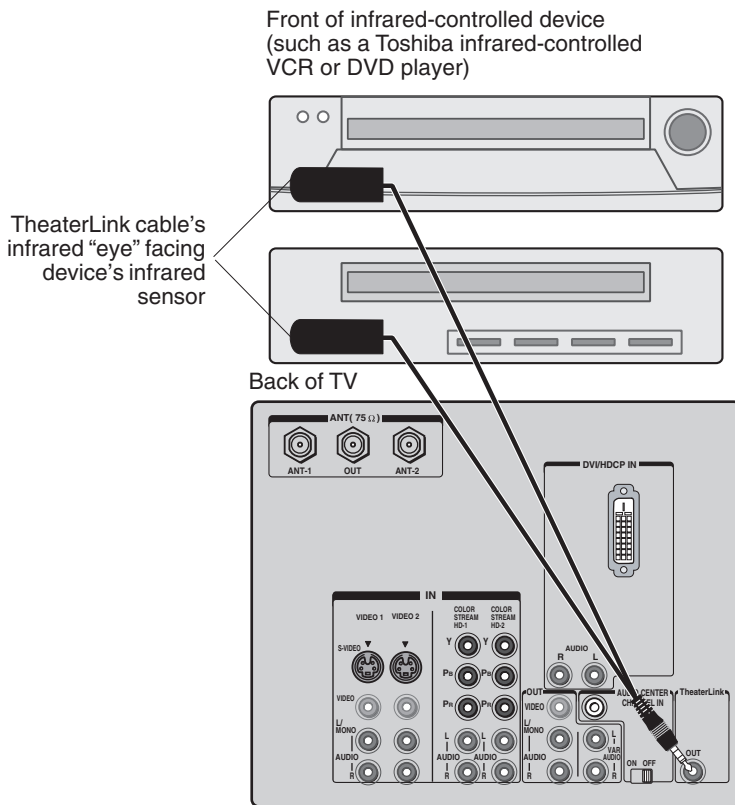

Point the TV remote control at the front of the TV to operate both the TV and the infrared-controlled device. (You also can point the device's remote control at the TV to operate the device, but you also will need to use the TV's remote control to operate the TV.)

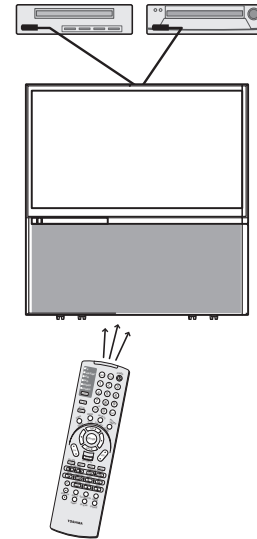

For additional control options for your home theater system, set up the TheaterLink on-screen IR device control feature as described on pages 29–34. You can use this feature to control many infrared-controlled devices using the TV's on-screen control icons.

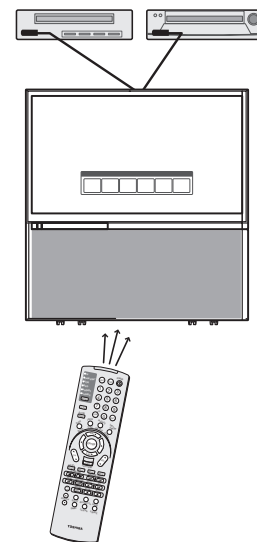

Connecting an audio system

This connection allows you to use an audio amplifier to adjust the audio level. This also allows you to use external speakers.

To control the audio, turn on the TV and the stereo amplifier, and turn off the built-in speakers (see “Turning off the built-in speakers” on page 65).

You will need:

- one pair of audio cables

Note:

To hear sound when using an external audio amplifier, the volume of both the TV and the amplifier must be set above 0 (zero).

For example, if the volume of the TV is set to 0, you will not be able to hear any sound, even the volume of the amplifier is at its highest level.

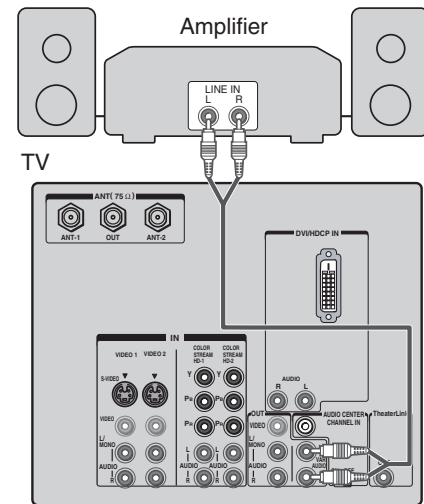

Connecting an A/V receiver

This connection allows you to use an audio/video (A/V) receiver to enhance your TV's sound.

If you have a sound system with “Dolby Surround Pro Logic,” you can add to the realism of the sound by using the TV's internal speakers as center channel speakers.

You will need:

- one set of standard A/V cables
- one single audio cable for the audio center channel

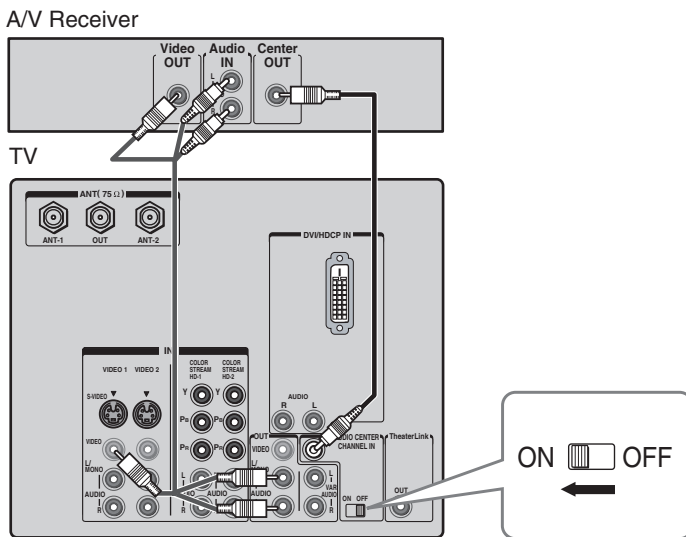

Note:

Refer to the instructions provided with your A/V receiver for details about your surround sound system.

When the Audio Center Channel ON/OFF switch is in the ON position, the TV speakers will function only as center channel speakers. At this time, the SBS feature should be set OFF. See page 64.

Adjust the volume for the center channel speakers using the center level control on the A/V receiver.

To use the TV speakers as normal speakers, set the Audio Center Channel ON/OFF switch to the OFF position.

Caution:

To avoid damaging the speakers:

- Turn off the TV off before connecting or disconnecting the Audio Center Channel cable.
- Do not connect from the A/V receiver's Center Speaker OUT (amplified signal) to the TV's Audio Center Channel IN.

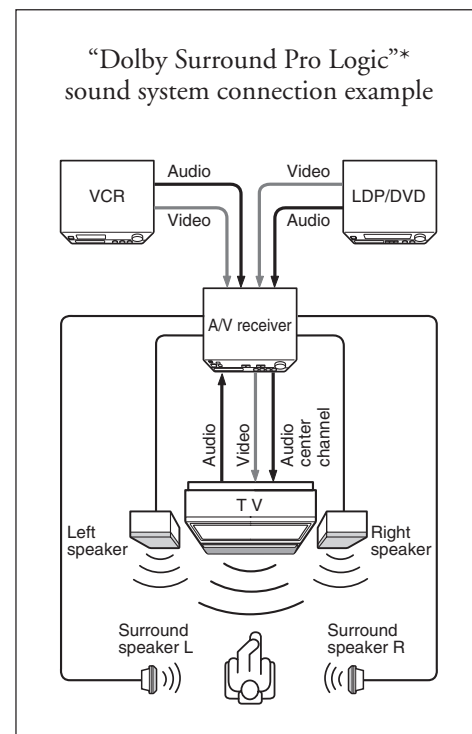

* “Dolby” and “Pro Logic” are trademarks of Dolby Laboratories.

Using the remote control

Preparing the remote control for use

Your Toshiba TV remote control has one dedicated TV mode and five multi-brand modes: VCR, Cable/SAT, DVD, Audio1, and Audio2. The target devices and default devices being programmed for each mode are as follows:

Target device/Mode mapping

Mode	Device
TV	Toshiba TV
CABLE/SAT	Multi-brand Cable, Satellite
VCR	Multi-brand VCR, DVD, LD, Cassette
DVD	Multi-brand DVD, VCR, LD, Cassette
AUDIO1	Multi-brand Audio: Amp., Tuner, Misc.Audio, CD/MD
AUDIO2	Multi-brand Audio: CD/MD, Amp., Tuner, Misc. Audio

Default device codes

Mode	Default device
TV	Toshiba TV
CABLE/SAT	Toshiba Satellite receiver
VCR	Toshiba VCR
DVD	Toshiba DVD
AUDIO1	Pioneer Audio receiver
AUDIO2	Pioneer LD

Repeatedly press MODE to cycle among the modes. If you own different brands of audio/video devices, you must first program your remote control (see “Programming the remote control for use with your audio/video devices” on page 20).

Installing the remote control batteries

To install the batteries:

- Slide the battery cover off the back of the remote control.

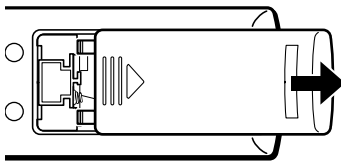

- Install two “AA” size alkaline batteries. Match the + and – signs on the batteries to the signs on the battery compartment.

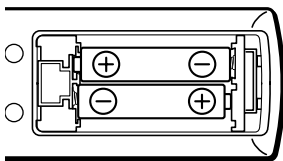

- Slide the battery cover back on to the remote control until the lock snaps.

Note:

Although your new TV's remote control includes codes for many devices, it may not include codes for some or all of the features on certain devices you wish to control. If you are unable to program the TV's remote control to operate your device or some of the features on that device, use the device's remote control or the controls on the device.

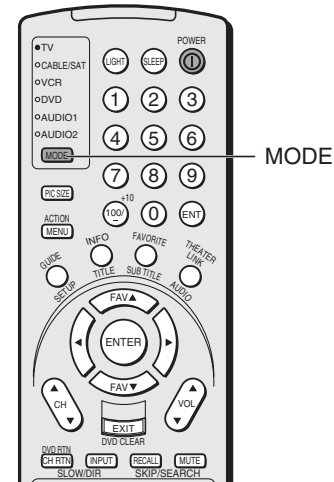

Caution:

- Dispose of batteries in a designated disposal area. Do not throw batteries into a fire.
- Do not mix battery types or combine used batteries with new ones.
- If the remote control does not operate correctly, or if the operating range becomes reduced, replace both batteries with new ones.
- If the batteries are dead or if you will not use the remote control for a long time, remove the batteries to prevent battery acid from leaking into the battery compartment.

Remote Control functional key chart

Key Label	Toshiba TV (TV)	Cable (CBL/SAT)	Satellite (CBL/SAT)	VCR	DVD/LD	Receiver (AUDIO)	CD/MD (AUDIO)	Cassette (VCR)
LIGHT	Lights the remote key, and toggles between enabled and disabled Illumination mode.							
SLEEP	Sleep timer	---	---	---	---	---	---	---
POWER	Power	Power	Power	Power	Power	Power	Power	Power
1	Digit 1	Digit 1	Digit 1	Digit 1	Digit 1	AV input 1	Digit 1	Digit 1
2	Digit 2	Digit 2	Digit 2	Digit 2	Digit 2	AV input 2	Digit 2	Digit 2
3	Digit 3	Digit 3	Digit 3	Digit 3	Digit 3	AV input 3	Digit 3	Digit 3
4	Digit 4	Digit 4	Digit 4	Digit 4	Digit 4	AV input 4	Digit 4	Digit 4
5	Digit 5	Digit 5	Digit 5	Digit 5	Digit 5	CD	Digit 5	Digit 5
6	Digit 6	Digit 6	Digit 6	Digit 6	Digit 6	Tuner	Digit 6	Digit 6
MODE	Remote control device mode selection							
PIC SIZE	Selects the image shape.	← TV	← TV	← TV	← TV	← TV	← TV	← TV
7	Digit 7	Digit 7	Digit 7	Digit 7	Digit 7	Phono	Digit 7	Digit 7
8	Digit 8	Digit 8	Digit 8	Digit 8	Digit 8	Cassette	Digit 8	Digit 8
9	Digit 9	Digit 9	Digit 9	Digit 9	Digit 9	Aux	Digit 9	Digit 9
ACTION	---	---	Action, Menu	---	Menu	---	---	---
100/-	100	---	100/-	---	+10	---	---	---
0	Digit 0	Digit 0	Digit 0	Digit 0	Digit 0	Digit 0	Digit 0, 10	Digit 0
ENT (CH Enter)	---	CH Enter	---	---	---	---	---	---
GUIDE/SETUP	---	---	Guide	---	DVD setup	---	---	---
INFO/TITLE	---	---	INFO	---	TITLE= Top menu	---	---	---
FAVORITE/ SUBTITLE	Favorites	---	Favorites	---	Subtitle	---	---	---
THEATERLINK/ AUDIO	TheaterLink	---	---	---	Audio	---	---	---
MENU/ ACTION	Menu	---	Action, Menu	---	Menu	---	---	---
▲▼ (FAV ▲▼)	Menu select FAV ▲▼	---	Menu select	---	Menu select	---	---	---
◀▶	Menu select	---	Menu select	---	Menu select	---	---	---
ENTER	Enter	---	Select	---	Enter	---	---	---
VOL ▲▼	Volume up/down*	Volume up/down*	Volume up/down*	Volume up/down*	Volume up/down*	Volume up/down*	Volume up/down*	Volume up/down*
EXIT/ DVD CLEAR	Exit	---	Exit	---	DVD clear	---	---	---
CH ▲▼	Channel up/down	Channel up/down	Channel up/down	Channel up/down	---	Channel up/down	---	---
INPUT	TV/Video select	← TV	← TV	VCR input	← TV	---	← TV	← TV
MUTE	Sound mute*	Sound mute*	Sound mute*	Sound mute*	Sound mute*	Sound mute*	Sound mute*	Sound mute*
RECALL	On-screen display	On-screen display	On-screen display	On-screen display	On-screen display	---	---	---
CH RTN/ DVD RTN	Previous channel	Previous channel	Previous channel	---	DVD return	---	---	---
SLOW/ DIR	► ◄	---	---	Slow FWD ---	Slow FWD Slow REV	---	---	---
SKIP/ SEARCH	► ◄	---	---	---	Skip FWD Skip REV	---	Skip FWD Skip REV	---
REW	VCR →	VCR →	VCR →	Rewind	Rewind	---	Rewind	Rewind
PAUSE/STEP	VCR →	VCR →	VCR →	Pause	Pause	---	Pause	Pause
PLAY	VCR →	VCR →	VCR →	Play	Play	---	Play	Play
FF	VCR →	VCR →	VCR →	Fast FWD	Fast FWD	---	Fast FWD	Fast FWD

Key Label	Toshiba TV (TV)	Cable (CBL/SAT)	Satellite (CBL/SAT)	VCR	DVD/LD	Receiver (AUDIO)	CD/MD (AUDIO)	Cassete (VCR)
TV/VCR	VCR →	---	TV/SAT	TV/VCR	---	---	---	Reverse
AM/FM DISC	---	---	---	---	Disc shift	AM/FM	Disc shift	Deck side A/B switch
STOP	VCR →	VCR →	VCR →	Stop	Stop	---	Stop	Stop
REC**	VCR →	VCR →	VCR →	Record**	---	---	---	Record**
POP CH ▲▼	POP channel up/down	← TV	← TV	← TV	← TV	← TV	← TV	← TV
SPLIT	POP Split	← TV	← TV	← TV	← TV	← TV	← TV	← TV
POP DIRECT CH	POP Direct ch	← TV	← TV	← TV	← TV	← TV	← TV	← TV
FREEZE	POP Freeze	← TV	← TV	← TV	← TV	← TV	← TV	← TV
SWAP	POP Swap	← TV	← TV	← TV	← TV	← TV	← TV	← TV
CH SCAN	POP Ch scan	← TV	← TV	← TV	← TV	← TV	← TV	← TV
SOURCE	POP Source	← TV	← TV	← TV	← TV	← TV	← TV	← TV

Notes:

- “---” will send nothing.
- “← TV” will jump to TV.
- “→VCR” will jump to last active VCR or DVD. Active VCR/DVD is defined as the mode that remains for a minimum of 5 seconds, or if a key is pressed in that mode.
- * The VOLUME and MUTE will jump to “TV” by default. When the volume is unlocked, all the devices will have their own volume. The AUDIO1/2 (Receiver, CD) modes will have their own volume even if Volume Lock is on TV, CABLE/SAT, VCR, or DVD. See “Using the Volume Lock feature” on page 21.
- ** Press the REC button twice within 5 seconds to record each audio/video source.

Programming the remote control for use with your audio/video devices

Device code setup

1. Refer to the multi-brand remote control device code table on pages 22–23 to find the code for the brand of your device.
If more than one code is listed, try each one separately until you find the one that works.
2. Press MODE until the Mode indicator for the device (CABLE/SAT, VCR, DVD, AUDIO1, AUDIO2) lights up.
3. While holding down the RECALL button, press the Channel Number buttons to enter the four-digit code for your brand of device. If a valid code is entered, the mode indicator will blink twice. If an invalid code is entered, the mode indicator will blink one long blink.
4. Point the remote control at the device and press POWER to test the code.

If the device turns on, you have entered the correct code.

If the device does not respond to the remote control, you may have entered the wrong code. Repeat steps 3 and 4 using another code.

Note: In addition to POWER, confirm that all necessary keys on the TV remote control operate your device. If some keys are not operational, repeat the device code setup using another code (if other codes are listed for your device). If, after trying all listed codes, the necessary keys do not operate your device, use the device's original remote control.

5. Press MODE to select the TV mode to control the TV.

Searching and sampling the code of a device (8500)

If you do not know the device code for a particular device, you can cycle the remote control through the available codes for that device mode and sample the functions to find the code that operates the target device. The keys available to be sampled, provided they are applicable to that mode, are POWER, 1, VOL ▲, CH ▲, and PLAY. Invalid keys will be ignored while in program mode.

To cycle through each available device code and sample its functions:

1. Press MODE to select the mode you want to set up.
2. While holding down the RECALL button, press 8 –5 –0 –0.
The remote control will enter program mode.
3. Point the remote control at the target device and press POWER (or other function buttons that are available to be sampled).
4. If the device responds to the remote control:
Press RECALL to store the device code.
The mode indicator will blink twice and the remote control will exit the program mode.

If the device does not respond to the remote control:

- Press ▲, and then press POWER.
Repeat this step until the device responds to the remote control, and then press RECALL.

Note: When a search cycle is completed, the mode indicator will blink three times. The remote control will begin to cycle through the available codes again. If no key is pressed within 10 seconds while programming, the remote control will exit the program mode and return to the previous code.

Note:

- Although your new TV's remote control includes codes for many devices, it may not include codes for some or all of the features on certain devices you wish to control. If you are unable to program the TV's remote control to operate your device or some of the features on that device, use the device's remote control or the controls on the device.

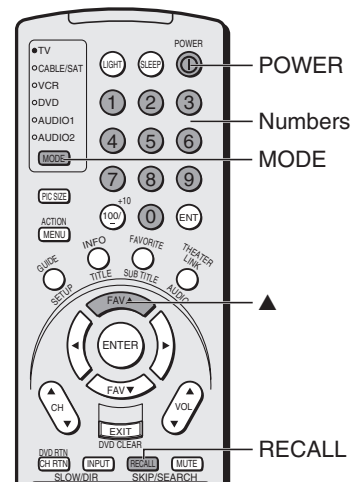

Using the volume lock feature (8000)

For the TV, CABLE/SAT, VCR, and DVD modes, the volume controls (VOL ▲▼ and MUTE) can be programmed (locked) to the selected device mode. This feature does not apply to the AUDIO1/2 modes.

For example, to lock the volume controls to always jump to the CABLE/SAT mode:

1. Repeatedly press MODE to select the CABLE/SAT mode.
 2. While holding down the RECALL button, press 8 –0 –0 –0.
 3. Press VOL ▲.
- The Mode indicator will blink two times (locked).

The following table describes in more detail the Volume Lock implementation.

Volume Locked to	TV	CBL/SAT	VCR	DVD	AUD1	AUD2
TV (default)	TV	TV	TV	TV	AUD1	AUD2
CBL/SAT	CBL/SAT	CBL/SAT	CBL/SAT	CBL/SAT	AUD1	AUD2
VCR	VCR	VCR	VCR	VCR	AUD1	AUD2
DVD	DVD	DVD	DVD	DVD	AUD1	AUD2
AUD1	AUD1	AUD1	AUD1	AUD1	AUD1	AUD1
AUD2	AUD2	AUD2	AUD2	AUD2	AUD2	AUD2

To reset the volume controls to the original device code:

1. While holding down the RECALL button, press 8 –0 –0 –0.
 2. Press VOL ▼.
- The Mode indicator will blink four times (unlocked).

Operational feature reset (8900)

This feature clears all setup features not related to “Device code set up” and resets the Volume Lock to “TV.”

To reset the features:

- While holding down the RECALL button, press 8 –9 –0 –0.
The Mode indicator will blink two times, and then pause and blink two more times.

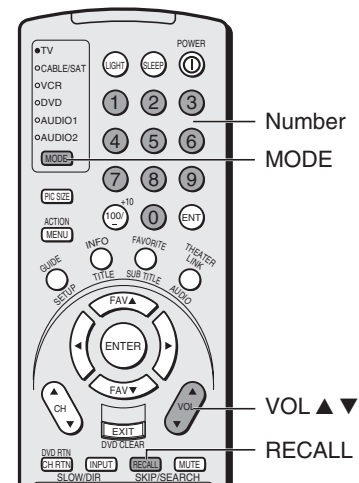

Multi-brand remote control device codes

VCRs

Brand	Code
ADMIRAL	0135
AIWA	0127, 0132, 0181
AKAI	0129, 0114, 0115, 0116
AUDIO DYNAMIC	0139, 0111
BELL&HOWELL	0105, 0113
BROKSONIC	0120, 0126, 0180
CANON	0123, 0125
CCE	0143
CITIZEN	0106
CRAIG	0105, 0129, 0106
CURTIS MATHES	0145, 0124, 0127
DAEWOO	0143, 0101, 0124, 0175
DBX	0139, 0110, 0111
DIMENSIA	0145
EMERSON	0143, 0126, 0119, 0103, 0125, 0142, 0120, 0118
FISHER	0105, 0108, 0109, 0107, 0113, 0165
FUNAI	0127, 0126, 0120, 0134
GE	0133, 0145, 0124
GO VIDEO	0137, 0151, 0163, 0149, 0150, 0182
GOLDSTAR	0106
GRADIENTE	0170, 0171, 0168, 0134, 0156
HITACHI	0123, 0145, 0100, 0127, 0168
INSTANT REPLAY	0124, 0123
JENSEN	0139
JVC	0139, 0110, 0111, 0134, 0157, 0158, 0184, 0185
KENWOOD	0139, 0110, 0106, 0111
LG	0159
LXI	0127, 0106, 0100, 0107, 0108, 0105, 0109
MAGNAVOX	0131, 0123, 0124, 0173
MARANTZ	0139, 0110, 0111
MARTA	0106
MEMOREX	0124, 0109
MGA	0138, 0140, 0147, 0148, 0141, 0142
MINOLTA	0100, 0145
MITSUBISHI	0138, 0140, 0147, 0148, 0141, 0142, 0161, 0164
MULTITECH	0147, 0127, 0104
NEC	0139, 0110, 0111, 0134
OLYMPIC	0124, 0123
OPTIMUS	0128, 0121, 0135, 0106
ORION	0126, 0120, 0132
PANASONIC	0123, 0124, 0121, 0122
PENNEY	0124, 0100, 0145, 0105, 0139, 0110, 0111
PENTAX	0100, 0111, 0145

VCRs (cont.)

Brand	Code
PHILCO	0131, 0124, 0127, 0123, 0126, 0120, 0143
PHILIPS	0131, 0123, 0124, 0173
PIONEER	0123
PROSCAN	0145, 0100, 0123, 0124, 0131, 0146, 0101, 0102, 0133, 0174
QUASAR	0121, 0122, 0123, 0124
RADIO SHACK	0133, 0124, 0105, 0136, 0109, 0140, 0127
RCA	0133, 0145, 0100, 0123, 0124, 0131, 0146, 0101, 0102, 0170, 0172, 0174, 0176, 0183
REALISTIC	0124, 0105, 0136, 0109, 0140, 0127
SAMSUNG	0137, 0102, 0104, 0133
SAMTRON	0163
SANSUI	0139, 0126, 0120, 0152
SANYO	0105, 0109, 0113
SCOTT	0101, 0102, 0104, 0109, 0138, 0140, 0147, 0148, 0126, 0120
SEARS	0105, 0106, 0107, 0108, 0100
SHARP	0135, 0136, 0167, 0162
SHINTOM	0117
SIGNATURE 2000	0127, 0135
SINGER	0117
SONY	0128, 0129, 0130, 0153, 0154, 0155
SV2000	0127
SYLVANIA	0131, 0123, 0124, 0127, 0178
SYMPHONIC	0127, 0168, 0177
TASHIRO	0106
TATUNG	0139, 0110, 0111
TEAC	0139, 0110, 0127, 0111
TECHNICS	0121, 0122, 0123, 0124
TEKNICA	0124, 0127, 0112
THOMSON	0179, 0183
TOSHIBA	0101, 0146, 0166, 0160
VECTOR RESEARCH	0111
WARDS	0135, 0136, 0109, 0144, 0106
YAMAHA	0105, 0139, 0110, 0111
ZENITH	0144, 0106, 0169, 0180

Cable converter boxes

Brand	Code
ABC	1124
ARCHER	1132, 1125
CABLEVIEW	1105, 1132
CITIZEN	1122, 1105
CURTIS	1112, 1113
DIAMOND	1124, 1132, 1125
EAGLE	1129
EASTERN	1134
GCBRAND	1132, 1105
GEMINI	1122, 1143
G.I./JERROLD	1119, 1124, 1125, 1126, 1127, 1120, 1121, 1122, 1111, 1123, 1152
HAMLIN	1140, 1141, 1142, 1145, 1118, 1112
HITACHI	1103, 1124
MACOM	1103, 1104, 1105, 1108
MAGNAVOX	1133
MEMOREX	1130
MOVIE TIME	1132, 1105
OAK	1139, 1137, 1102
PANASONIC	1109, 1110, 1114, 1151, 1153
PHILIPS	1128, 1129, 1130, 1106, 1107, 1150, 1131
PIONEER	1101, 1116
PULSAR	1105, 1132
PUSER	1132
RCA	1115
REALISTIC	1132
REGAL	1112, 1118, 1140, 1141, 1142, 1145, 1149
REGENCY	1134
REMBRANT	1137, 1132, 1105, 1138
SAMSUNG	1105
S.A.	1111, 1112, 1113
SLMARK	1105, 1101
SPRUCER	1105, 1110
STARGATE	1132, 1105
TELECATION	1148
TELEVIEW	1101, 1105
TEXSCAN	1144
TOCOM	1135, 1136, 1147
TOSHIBA	1104, 1146
UNIKA	1132, 1125
UNIVERSAL	1122, 1132
VIDEOWAY	1106
VIEWSTAR	1129, 1130
ZENITH	1117, 1100
ZENITH/DRAKE	
SATELLITE	1100

Multi-brand remote control device codes (cont.)

CD players

Brand	Code
ADMIRAL	6126
AIWA	6133, 6135
CARVER	6129
DENON	6142, 6151
EMERSON	6139
FISHER	6105, 6106
GARRARD	6117
HARMAN KARDON	6120, 6121, 6123, 6119
HITACHI	6107
JENSEN	6134
JVC	6140, 6141, 6145, 6148, 6151
KENWOOD	6100, 6101, 6111, 6145
LXI	6136
MAGNAVOX	6129, 6132
MARANTZ	6129
MCINTOSH	6121
NAKAMICHI	6110
ONKYO	6114, 6115
OPTIMUS	6108, 6118, 6120, 6122
PANASONIC	6124, 6125, 6127, 6150
PHILIPS	6129, 6130, 6149
PIONEER	6108
QUASAR	6125, 6127, 6124
RCA	6147, 6137, 6138, 6131, 6152
SANSUI	6110, 6146, 6113
SANYO	6105
SCOTT	6110, 6146
SHARP	6142, 6143
SHERWOOD	6120
SONY	6128
SOUNDE-SIGH	6144
TEAC	6112, 6116, 6118
TECHNICS	6127, 6124, 6125
VICTOR	6140, 6141, 6145
YAMAHA	6102, 6103, 6104

Receivers

Brand	Code
ADMIRAL	4120
AIWA	4125, 4126, 4146
DENON	4134, 4135, 4136, 4143
FISHER	4104
GARRARD	4113
HARMAN KARDON	4115, 4123, 4145
JENSEN	4129
JVC	4132, 4133, 4140, 4144
KENWOOD	4100, 4108, 4141, 4142, 4147
MAGNAVOX	4127, 4128
MARANTZ	4124
MCINTOSH	4116
MITSUBISHI	4148
NAKAMICHI	4106, 4117
ONKYO	4109, 4114
OPTIMUS	4103, 4127, 4131, 4130
PANASONIC	4119, 4118, 4121
PHILIPS	4123

Receivers (cont.)

Brand	Code
PIONEER	4105, 4107, 4150
QUASAR	4119, 4118, 4121
RCA	4103, 4105, 4127, 4131, 4130, 4149
SANSUI	4103, 4111, 4139
SHARP	4134, 4137
SONY	4122
SOUNDE-SIGH	4138
TEAC	4112, 4113, 4111, 4110
TECHNICS	4121, 4118, 4119
VICTOR	4132, 4133
YAMAHA	4101, 4102

Cassette players

Brand	Code
AIWA	7123, 7124, 7125
DENON	7131
FISHER	7103
JENSEN	7114
JVC	7129, 7130, 7132, 7133
KENWOOD	7100, 7107
MARANTZ	7102
NAKAMICHI	7105
ONKYO	7108, 7109, 7113
PANASONIC	7116, 7118
PHILIPS	7122, 7121
PIONEER	7104, 7106
RCA	7126, 7127, 7128, 7134, 7135
SANSUI	7105, 7110, 7112
SHARP	7131
SONY	7119, 7120
TEAC	7110, 7111, 7115
TECHNICS	7116, 7118, 7117
YAMAHA	7101, 7102

Laser disc players

Brand	Code
DENON	5114
HITACHI	5100
KENWOOD	5102, 5103
MAGNAVOX	5101
MARANTZ	5114
MITSUBISHI	5114, 5118, 5119
NEC	5114
PANASONIC	5104, 5105, 5106, 5115
PHILIPS	5111
PIONEER	5114
PROSCAN	5114
QUASAR	5104, 5105, 5106, 5115
RCA	5114
SAMSUNG	5112
SANYO	5114, 5117
SHARP	5113, 5116
SONY	5107, 5108, 5109, 5110
TEAC	5114
TOSHIBA	5114
YAMAHA	5101

DVD players

Brand	Code
AIWA	3123
APEX	3120
DENON	3100, 3117
FERGUSON	3101
HITACHI	3111
JVC	3109
KENWOOD	3115, 3129
KONKA	3119
MITSUBISHI	3105
NORDMENDE	3101
ONKYO	3121
ORITRON	3124
PANASONIC	3100
PHILIPS	3103, 3116
PIONEER	3102
RAITE	3113
RCA	3101, 3106
SABA	3101
SAMPO	3114
SAMSUNG	3110
SHARP	3108
SILVANIA	3132, 3118
SMC	3125
SONY	3104, 3126, 3127, 3128
TECHNICS	3100
THOMSON	3101
TOSHIBA	3103
WAVE	3122
YAMAHA	3100, 3130
ZENITH	3107, 3112
VIALTA	3131
FUNAI	3132, 3118

Satellite receivers

Brand	Code
DISH NETWORK (Echostar)	2105, 2115, 2116, 2117
ECHOSTAR	2105
EXPRESS VU	2105, 2115
G.E.	2106
G.I. (GENERAL INSTRUMENT)	2108
GRADIENTE	2114
HITACHI	2103, 2111, 2112
HNS (Hughes)	2103
MAGNAVOX	2101, 2102
PANASONIC	2104
PHILIPS	2101, 2102, 2118
PRIMESTAR	2108
PROSCAN	2106, 2109, 2110, 2113
RCA	2106, 2109, 2110, 2113
SONY	2107
STAR CHOICE	2103, 2108
TOSHIBA	2100, 2103, 2119, 2120, 2121
UNIDEN	2101, 2102

Learning about the remote control

The buttons used for operating the TV only are described here. For a complete list of the remote control's functions, see the "Remote Control functional key chart" on pages 18–19.

POWER turns the TV on and off

SLEEP allows access to the automatic TV shut-off function (page 60)

LIGHT The first press of the LIGHT button lights the keypad and turns on the Illumination mode. With the Illumination mode on, pressing any other key lights the keypad for 5 seconds (10 seconds if you're in programming mode). Subsequent presses of the LIGHT button toggle between turning the Illumination mode on and off.

Channel Numbers (0-9, 100) allow direct access to channels (page 35)

MODE cycles through the six device modes: TV, CABLE/SAT, VCR, DVD, AUDIO1, and AUDIO2. The mode indicator light will remain lit for a few seconds (page 20).

PIC SIZE cycles through the five pictures sizes: Natural, Theater Wide 1, 2, 3, and Full (page 40)

FAVORITE allows access to the favorite channel search function (page 47)

THEATER LINK allows access to the on-screen IR device control system (page 31)

MENU allows access to on-screen programming menus (page 25)

ENTER sets programming menu information (page 25)

▲▼◀▶ select or adjust programming menus (page 25)

FAV ▲▼ cycles through favorite channels (page 38)

CH ▲▼ cycles through programmed channels (page 35)

VOL ▲▼ adjusts the volume level

EXIT exits the programming menus (page 25)

INPUT selects the video input source (page 58)

MUTE mutes the sound (page 62)

RECALL displays on-screen information (page 66)

CH RTN returns to the last viewed channels (page 37)

POP CH ▲▼ selects the POP (picture-out-picture) channel (page 44)

SPLIT turns the POP feature on and off (page 44)

CH SCAN allows access to the programmed channel search function (page 46)

FREEZE freezes the POP picture (page 45)

SWAP switches the main and POP pictures (page 45)

POP DIRECT CH allows direct access to POP channels (page 44)

SOURCE selects the POP picture source (page 44)



Note:

The error message "Not Available" will appear if you press a key for a function that is not available.

Setting up your TV

Learning about the menu system

After you have installed the batteries and programmed the remote control, you will need to set some preferences on the TV using the menu system. You can access the menu system using the buttons on your TV or remote control.

1. Press MENU to display the menu system.
2. Press ◀ or ▶ to select a menu.
3. Press ▲ or ▼ select an item.
4. Press ◀ or ▶ to select or adjust a setting.

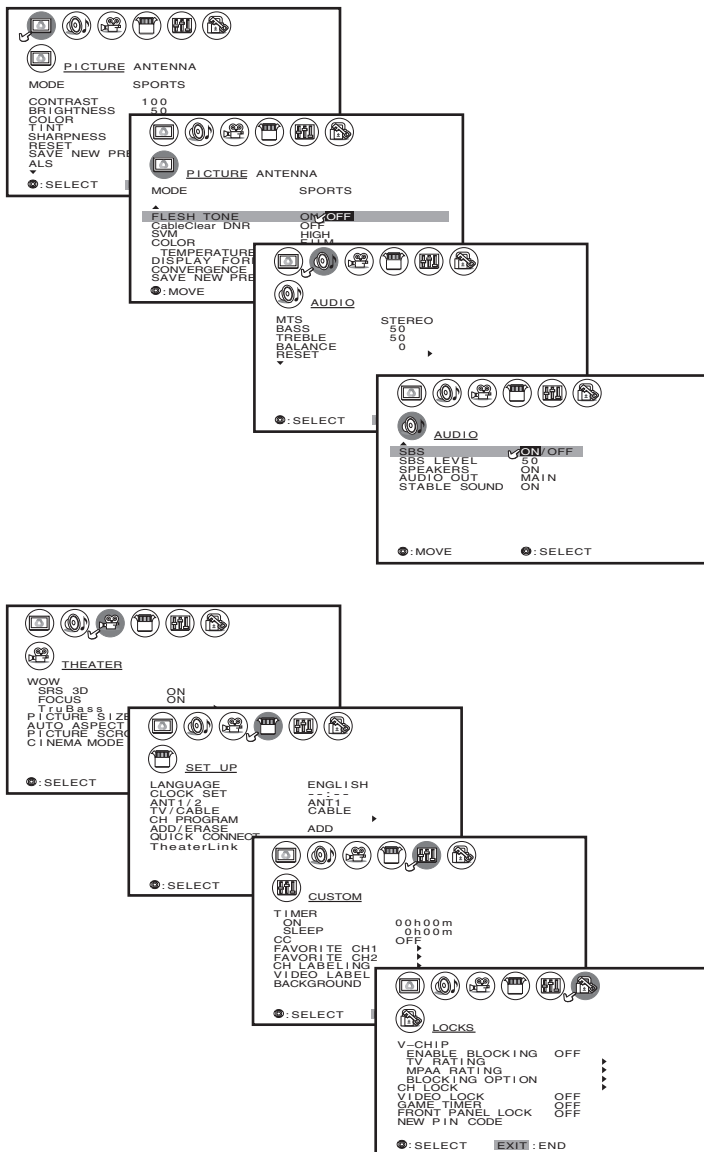

- Press ENTER to activate the function settings in the menus.
- If you do not make a selection within 15 seconds, the main menu display closes automatically; the other displays close automatically within 6 seconds (except the Convergence menu, which will remain until a button is pressed).
- To close an on-screen display instantly, press EXIT.

Note regarding Quick Connect Guide

The **Quick Connect Guide** automatically appears on-screen the first time the TV is turned on. This feature provides on-screen instructions to guide you through initial setup of your TV.

See page 26 for details.

To stop the **Quick Connect Guide**, either press EXIT or turn off the TV.

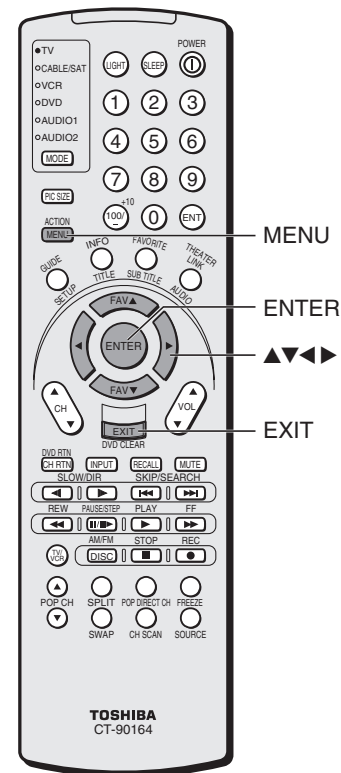
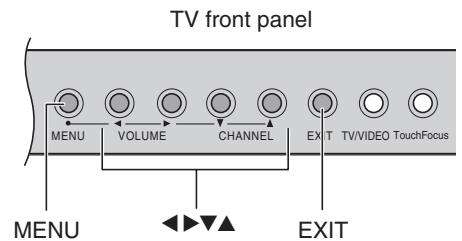

Note:

You can change the background of the menu. See page 66 for details.

Using the Quick Connect Guide

The Quick Connect Guide automatically starts the first time the TV is turned on. This feature provides on-screen instructions to guide you through initial setup of your TV.

To manually access the Quick Connect Guide:

1. Press MENU, and then press ◀ or ▶ until the SET UP menu appears.
2. Press ▲ or ▼ to highlight QUICK CONNECT GUIDE.

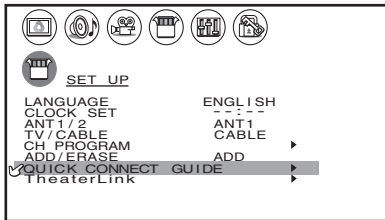

3. Press ◀ or ▶ to enter the Quick Connect Guide mode. Advance through the setup according to the guide displayed on-screen.
 - Press ◀ or ▶ to make a selection.
 - Press MENU to continue to the next screen.

Note:

To stop the Quick Connect Guide, press EXIT or turn off the TV.

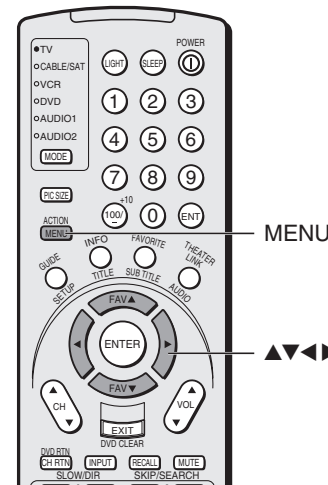
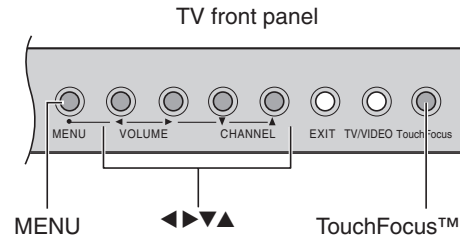

The Quick Connect Guide will guide you through the following items:

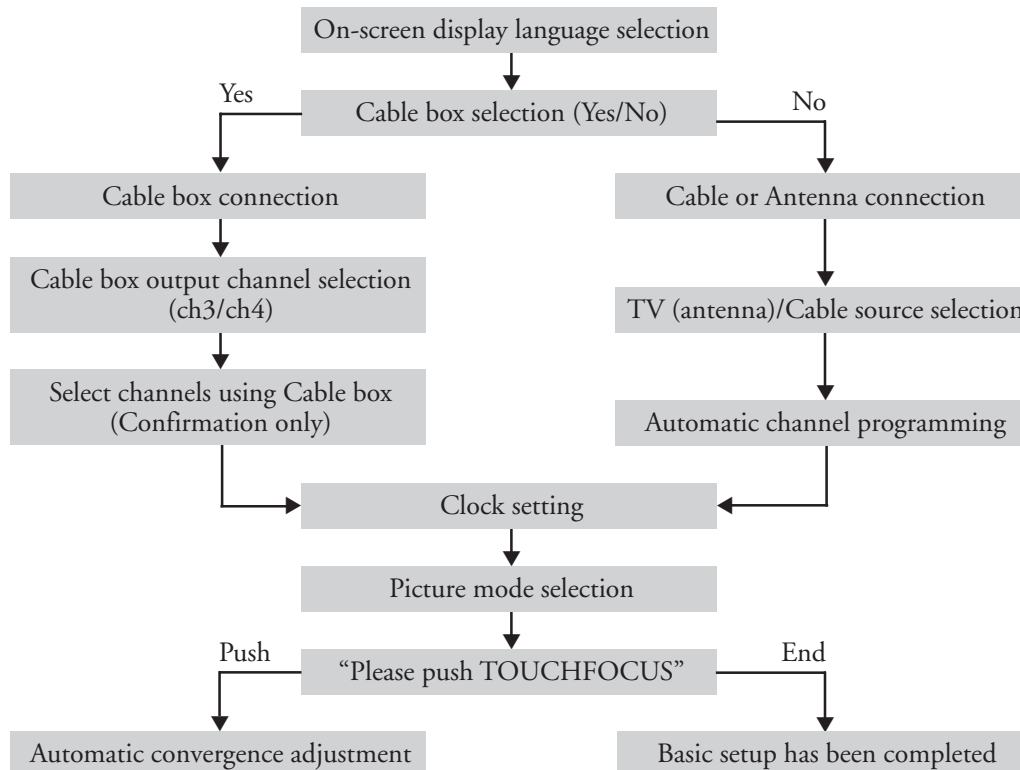

Changing the on-screen display language

You can choose from three different languages (English, French and Spanish) for the on-screen display of adjustment menus and messages.

To select a language:

1. Press MENU, and then press ◀ or ▶ until the SET UP menu appears.
2. Press ▲ or ▼ to highlight LANGUAGE.

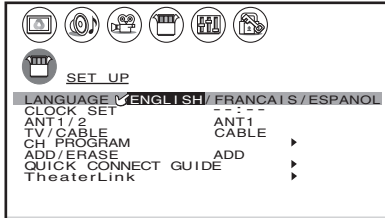

3. Press ◀ or ▶ to highlight your desired language.

Selecting the antenna input

You can connect to two different antenna input sources (ANT 1 or ANT 2).

To select the antenna input using the INPUT or TV/VIDEO button:

1. Press INPUT button on the remote control or TV/VIDEO on the TV (see illustrations below). The current signal source displays in purple.
2. Continue pressing INPUT or TV/VIDEO button to select ANT 1 or ANT 2.

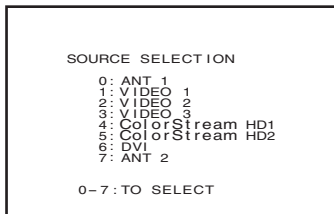

Pressing INPUT on the remote control displays the current signal source (press INPUT again or 0-7 to change)

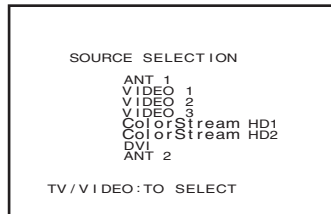

Pressing TV/VIDEO on the TV changes the current signal source

To select the antenna input using the menu system:

1. Press MENU, and then press ◀ or ▶ to highlight the SET UP menu.
2. Press ▲ or ▼ to highlight ANT 1/2.

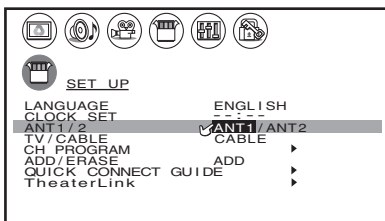

3. Press ◀ or ▶ to highlight either ANT 1 or ANT 2, depending on the antenna terminal you wish to use.

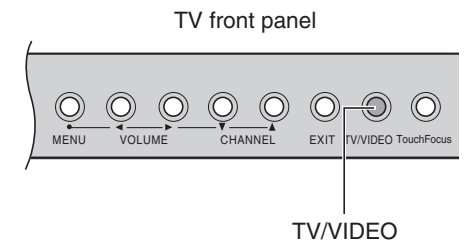
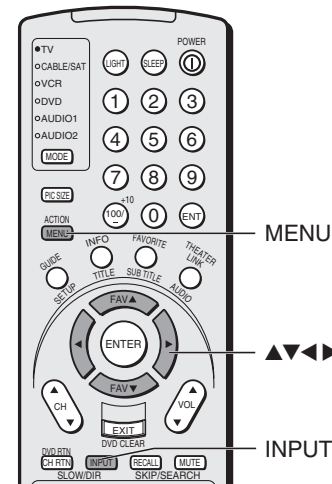
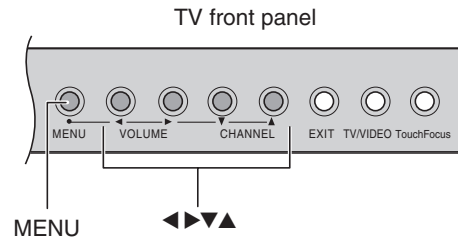

Please note the following regarding the DVI source selection:

This TV is not intended for connection to and should not be used with a PC (personal computer). See "Connecting a device to the DVI/HDCP input" on page 14 for details.

Adding and erasing channels manually

After you have programmed the channels automatically, you can manually add or erase specific channels in the channel memory.

To add or erase channels:

1. Select the channel you want to add or erase. If you are adding a channel, you must select the channel using the Channel Number buttons.
2. Press MENU, and then press ◀ or ▶ until the SET UP menu appears.
3. Press ▲ or ▼ to highlight ADD/ERASE.

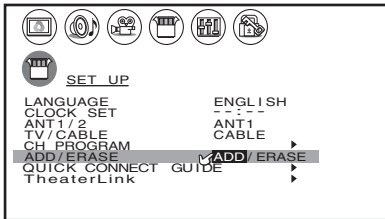

4. Press ◀ or ▶ to select ADD or ERASE, depending on the function you want to perform.
5. Repeat steps 1–4 for other channels you want to add or erase.

Setting up the TheaterLink on-screen IR device control feature

With this setting, you can use the TV's remote control to control various devices (such as a VCR, DVD player, DVR, or laser disc player) by using the control icons displayed on the TV screen.

To set up the TheaterLink IR device control feature:

1. Make sure you have properly connected the TheaterLink cable to your IR-controlled device(s). See page 15 for details.
2. Press MENU, and then press ◀ or ▶ until the SET UP menu appears.
3. Press ▲ or ▼ to highlight TheaterLink.

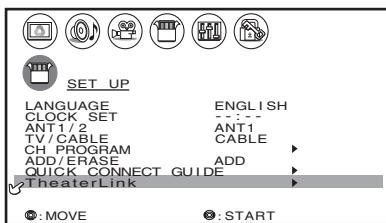

(continued on next page)

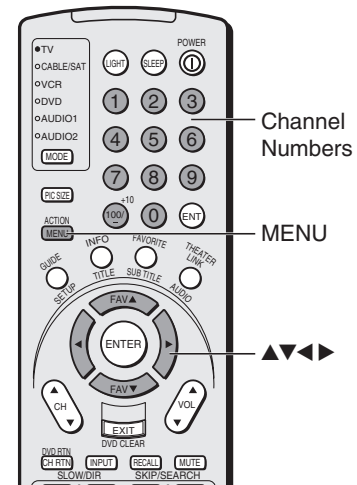
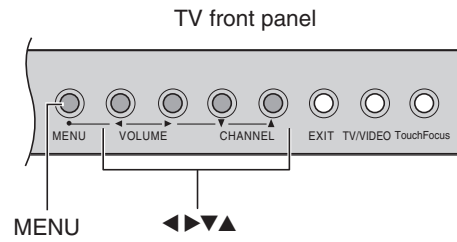

Note:

Although the TheaterLink on-screen IR device control feature includes codes for many devices, it may not include codes for some or all of the features on certain devices you wish to control. If you are unable to program the TheaterLink feature to operate your device or some of the features on that device, use the device's remote control or the controls on the device.

4. Press ◀ or ▶ to enter the TheaterLink setup mode.

5. Press ▲▼ to select the input terminals that the device is connected to.

Press ENTER to continue.

6. Press ▲▼◀▶ to select the category of the device.

Press ENTER to continue.

7. Press ▲▼◀▶ to select the brand of the device.

Press ENTER to continue.

8. • If you select one of the brands listed on-screen, select a code using the ◀▶ buttons.
• If you select “Others” in step 7, refer to the TheaterLink IR device code table on pages 32–34 to find the code for the brand of your device. Enter the code using the number buttons on the remote control.
Press ENTER to continue.

9. Press ◀ or ▶ to select “TEST” to test whether the device responds to the code.
Press ENTER to continue.

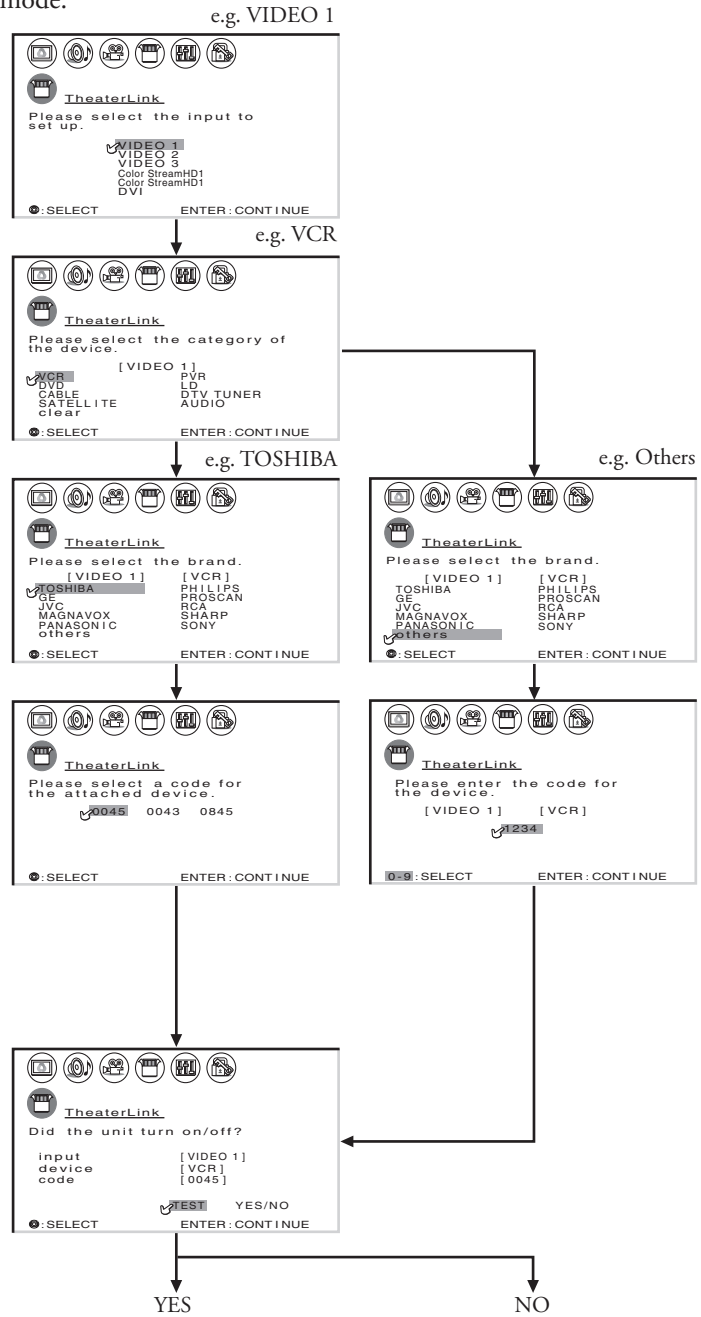

- If the device responds to the code, press **◀▶** to select “YES.”
 - If the device does not respond to the code, press **◀▶** to select “NO.”

Press ENTER to continue.

- To set up another device or try another code for the same device, select “CONTINUE.”
 - To end, select “END.”

Press ENTER to continue.

- The TheaterLink control setup status will appear on-screen.

Press EXIT to close the screen.

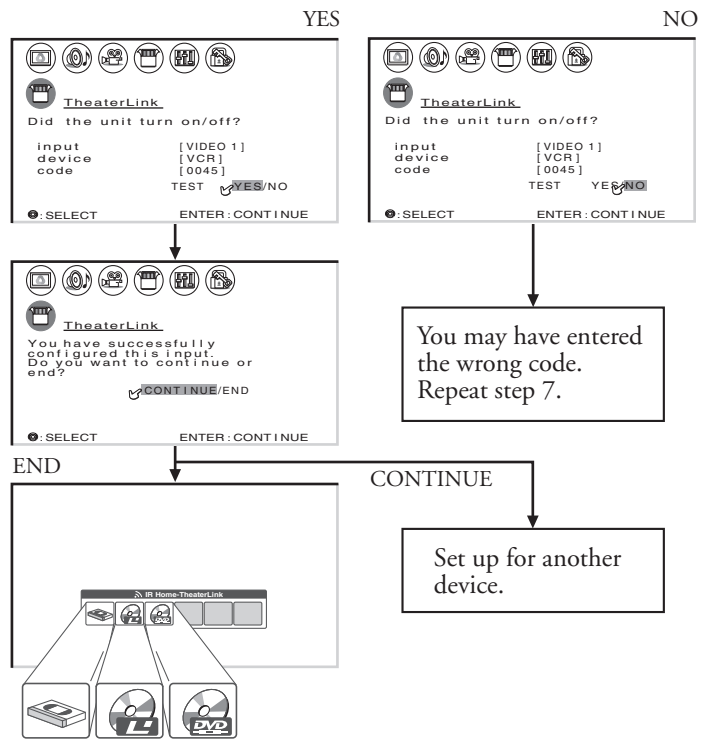

Accessing the TheaterLink on-screen IR device control bar

- You must first set up the TheaterLink feature, if you have not already done so (see page 29).
- Press THEATER LINK on the remote control to display the TheaterLink IR device control bar on-screen.
- Press **◀** or **▶** to highlight the device you want to control with the TV's remote control.

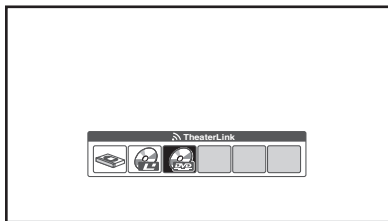

- Press ENTER to display the function control bar for the device.



- Press **◀** or **▶** to highlight the function you want to control and then press ENTER.

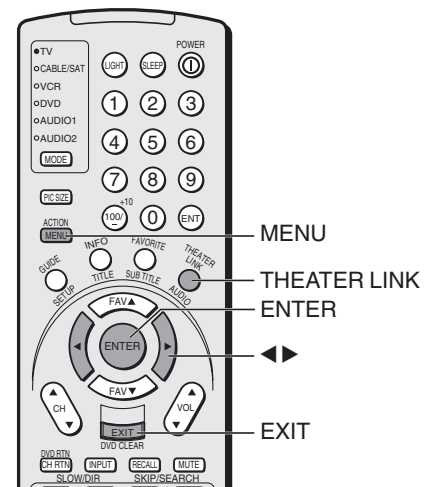

Amplifiers

Brand	Code
Aiwa	0406
Bose	0674
Carver	0269
Curtis Mathes	0300
Denon	0160
GE	0078
Harman/Kardon	0892
JVC	0331
Left Coast	0892
Linn	0269
Luxman	0165
Magnavox	0269
Marantz	0892, 0321, 0269
NEC	0264
Nakamichi	0321
Optimus	0395, 0300
Panasonic	0308, 0521
Parasound	0246
Philips	0892, 0269
Pioneer	0013, 0300
Polk Audio	0892, 0269
RCA	0300
Realistic	0395
Sansui	0321
Shure	0264
Sony	0689, 0220
Soundesign	0078, 0211
Technics	0308, 0521
Victor	0331
Wards	0078, 0013, 0211
Yamaha	0354, 0133

Cable converter boxes

Brand	Code
ABC	0003, 0008, 0014, 0007, 0011, 0017
Americast	0899
Bell & Howell	0014
Bell South	0899
Contec	0019
Director	0476
Everquest	0015
Gemini	0015
General Instrument	0476, 0003, 0276, 0011, 0810
GoldStar	0144
Hamlin	0009, 0020, 0273
Hitachi	0011
Hytex	0007
Jasco	0015
Jerrold	0476, 0003, 0276, 0012, 0014, 0015, 0011, 0810
Memorex	0000
Motorola	0476, 1106, 0276, 0810
Oak	0019, 0007
Pace	0237
Panasonic	0000, 0107
Paragon	0000
Philips	0305, 0317
Pioneer	0877, 0144, 0533, 1877
Pulsar	0000
Quasar	0000
RadioShack	0015
Regal	0020, 0273, 0279

Cable converter boxes (cont.)

Brand	Code
Rembrandt	0011
Runco	0000
Samsung	0144
Scientific Atlanta	0877, 0008, 0017, 0477, 1877
Signal	0015
Signature	0011
sony	1006
Starcom	0003, 0015
Stargate	0015
Starquest	0015
Supercable	0276
Tocom	0012
Torx	0003
Toshiba	0000
Tusa	0015
United Artists	0007
Zenith	0000, 0525, 0899

CD players

Brand	Code
Aiwa	0157, 0124
Burmester	0420
California Audio Labs	0029, 0303
Carver	0157, 0179, 0437
Classic	1297
DKK	0000
DMX Electronics	0157
Denon	0873, 0003
Emerson	0305
Fisher	0174, 0179, 1325
GPX	1296
Garrard	0393, 0420
Genexxa	0032, 0305
Harman/Kardon	0157, 0173
Hitachi	0032
JVC	0072, 1294
KLH	1318, 1372, 1373
Kenwood	0681, 0826, 0626, 0028, 0037, 0190
Koss	1317
Krell	0157
LXI	0305
Linn	0157
MCS	0029
MTC	0420
Magnavox	0157, 0305
Marantz	0626, 0029, 0157, 0180
Miro	0000
Mission	0157
NSM	0157
Nikko	0174
Onkyo	0868, 0101
Optimus	1063, 0000, 0032, 0037, 0145, 0179, 0305, 0420, 0437, 0468
Panasonic	0029, 0303
Parasound	0420
Philips	0626, 0157
Pioneer	1063, 1062, 0032, 0305, 0468
Polk Audio	0157
Proton	0157
QED	0157
Quasar	0029

CD players (cont.)

Brand	Code
RCA	1062, 0032, 0053, 0179, 0305, 0468, 0764
Realistic	0179, 0180, 0420
Rotel	0157, 0420
SAE	0157
Sansui	0157, 0305
Sanyo	0179
Scott	0305
Sears	0305
Sharp	0861, 0037, 0180
Sherwood	1067, 0180
Sonic Frontiers	0157
Sony	0490, 0000, 0100, 0185, 0604, 1364
Soundesign	0145
TDK	1208
Tascam	0420
Teac	0174, 0180, 0393, 0420
Technics	0029, 0303
Victor	0072
Wards	0157, 0053
Yamaha	0888, 0036, 0187, 1292
Yorx	0461

Laser disk players

Brand	Code
Aiwa	0203
Carver	0064, 0194, 0323
Denon	0059, 0172
Disco Vision	0023
Funai	0203
Harman/Kardon	0194
Hitachi	0023
Magnavox	0194, 0217
Marantz	0064, 0194
Mitsubishi	0059
NAD	0059
Optimus	0059
Panasonic	0204
Philips	0064, 0194
Pioneer	0059, 0023
Polk Audio	0194
Quasar	0204
Realistic	0203
Samsung	0323
Sega	0023
Sony	0193, 0201
Technics	0204
Theta Digital	0194
Yamaha	0217

Miscellaneous audio devices

Brand	Code
Aiwa	0010, 0159, 0404
Fisher	0052
JVC	0073
Jerrold	0520, 0459
Scientific Atlanta	0460
Sony	0010, 0159, 0576
Starcom	0459

TheaterLink IR device codes (cont.)

Video Accessory (HDTV Decoder)

Brand	Code
Panasonic	1120
Pioneer	1010
Princeton	0113, 0295
Samsung	1190
Sensory Science	1126
Sharp	1010

Receivers

Brand	Code
ADC	0531
Aiwa	1089, 1405, 0121, 0158, 0189, 0405, 1388, 1641
Alco	1390
Anam	1609
Apex Digital	1257
Arcam	1120
Audiotronic	1189
Audiovox	1390
Bose	1229
Cambridge Soundworks	1370
Capetronic	0531
Carver	1089, 1189, 0042, 0189
Casio	0195
Clarinette	0195
Compaq	1136
Curtis Mathes	0080
Daewoo	1250
Denon	1104, 1160, 0004, 1360
Fisher	0042, 1801
Garrard	0463
Harman/Kardon	0110, 0189, 0891
Hewlett Packard	1181
JBL	0110, 1306
JVC	0074, 1374
KLH	1390
Kenwood	1313, 1027, 1570, 1569, 0027, 0042, 0186
Koss	1366
LXI	0181
Lasonic	1798
Linn	0189
Lloyd's	0195
MCS	0039
Magnavox	1089, 1189, 0189, 0195, 0391, 0531
Marantz	1089, 1189, 0039, 0189
Modulaire	0195
Musicmagic	1089
Nakamichi	0097
Onkyo	0135, 0842, 1298
Optimus	1023, 0042, 0080, 0181, 0186, 0531, 0670, 0738, 0801
Panasonic	1518, 0039, 0309, 0367
Penney	0195
Philips	1089, 1189, 1269, 0189, 0391, 1120
Pioneer	1023, 0014, 0080, 0150, 0244, 0531, 0630, 1384
Polk Audio	0189

Receivers (cont.)

Brand	Code
Proscan	1254
Quasar	0039
RCA	1023, 1254, 0080, 0531, 1390, 1609
Realistic	0181, 0195
Samsung	1295
Sansui	1089, 0189
Sanyo	0801, 1251
Sharp	0186, 1286
Sherwood	0491, 0502, 1653
Sony	1058, 1258, 1158, 1558, 1658, 1758
Soundesign	0670
Stereophonics	1023
Sunfire	1313
Teac	0463
Technics	1308, 1309, 1518, 0039, 0309
Thorens	1189
Venturer	1390
Victor	0074
Wards	0014, 0080, 0158, 0189
Yamaha	0176, 0186, 1176
Yorx	0195
Zenith	0857

Satellite receivers

Brand	Code
AlphaStar	0772
Chaparral	0216
Crossdigital	1109
DishPro	1005, 0775
Echostar	1005, 0775
Expressvu	0775
GE	0566
GOI	0775
General Instrument	0869
HTS	0775
Hitachi	0819
Hughes Network Systems	1142, 0749, 1749
JVC	0775
Magnavox	0724, 0722
Memorex	0724
Mitsubishi	0749
Motorola	0869
Next Level	0869
Panasonic	0247, 0701
Paysat	0724
Philips	1142, 0749, 0724, 1076, 0722, 1749
Proscan	0392
RCA	0392, 0566, 0855, 0143
RadioShack	0869
SKY	0856
Samsung	1109
Sony	0639
Star Choice	0869
Toshiba	0749, 0790, 1052, 1053, 1054, 1285, 1286, 1287, 1289, 1749
Uniden	0724, 0722
Zenith	0856, 1856

VCRs

Brand	Code
Admiral	0048, 0209
Adventura	0000
Aiko	0278
Aiwa	0037, 0000
Akai	0041
America Action	0278
American High	0035
Asha	0240
Audiovox	0037, 0278
Beaumarck	0240
Bell & Howell	0104
Broksonic	0184, 0121, 0209, 0002, 0479, 1479
CCE	0072, 0278
Calix	0037
Canon	0035
Carver	0081
Cineral	0278
Citizen	0037, 0278, 1278
Colt	0072
Craig	0037, 0047, 0240, 0072
Curtis Mathes	0060, 0035, 0162, 0041, 0760, 1035
Cybernex	0240
Daewoo	0045, 0278, 1278
Denon	0042
Dynatech	0000
Electrohome	0037
Electrohome	0037
Emerex	0032
Emerson	0037, 0184, 0000, 0121, 0043, 0209, 0002, 0278, 0479, 1278, 1479
Fisher	0047, 0104
Fuji	0035, 0033
Funai	0000
GE	0060, 0035, 0240, 0760, 0807, 1035, 1060
Garrard	0000
Go Video	0432
GoldStar	0037, 0038, 1237
Gradiente	0000
HI-Q	0047
Harley Davidson	0000
Harman/Kardon	0081, 0038
Harwood	0072
Headquarter	0046
Hitachi	0000, 0042, 0041
Hughes Network Systems	0042
JVC	0067, 0041
Jensen	0041
KEC	0037, 0278
KLH	0072
Keen	0693
Kenwood	0067, 0041, 0038
Kodak	0035, 0037
LXI	0037
Lloyd's	0000
Logik	0072
MEI	0035
MGA	0240, 0043
MGN Technology	0240
MTC	0240, 0000
Magnasonic	1278

TheaterLink IR device codes (cont.)

VCRs (cont.)

Brand	Code
Magnavox	0035, 0039, 0081, 0000, 0149, 0563, 1781
Magnin	0240
Marantz	0035, 0081
Marta	0037
Matsushita	0035, 0162, 0454
Memorex	0035, 0162, 0037, 0048, 0039, 0047, 0240, 0000, 0104, 0209, 0046, 0454, 0479, 1037, 1162, 1237, 1262
Minolta	0042
Mitsubishi	0067, 0043, 0807
Motorola	0035, 0048
Multitech	0000, 0072
NEC	0104, 0067, 0041, 0038
Nikko	0037
Noblex	0240
Olympus	0035
Optimus	1062, 0162, 0037, 0048, 0104, 0432, 0454, 1048, 1162, 1262
Orion	0184, 0209, 0002, 0479, 1479
Panasonic	1062, 0035, 0162, 0225, 0454, 0616, 1035, 1162, 1262
Penney	0035, 0037, 0240, 0042, 0038, 1035, 1237
Pentax	0042
Philco	0035, 0209, 0479
Philips	0035, 0081, 0618, 1081, 1181
Pilot	0037
Pioneer	0067
Polk Audio	0081
Profitronic	0240
Proscan	0060, 0760, 1060
Protec	0072
Pulsar	0039
Quarter	0046
Quartz	0046
Quasar	0035, 0162, 0454, 1035, 1162
RCA	0060, 0240, 0042, 0149, 0760, 0807, 1035, 1060
RadioShack	0000, 1037
Radix	0037
Randex	0037
Realistic	0035, 0037, 0048, 0047, 0000, 0104, 0046
ReplayTV	0614, 0616
Runco	0039
STS	0042
Samsung	0240, 0045
Sanky	0048, 0039
Sansui	0000, 0067, 0209, 0041, 0479, 1479
Sanyo	0047, 0240, 0104, 0046
Scott	0184, 0045, 0121, 0043

VCRs (cont.)

Brand	Code
Sears	0035, 0037, 0047, 0000, 0042, 0104, 0046, 1237
Semp	0045
Sharp	0048, 0807, 0848
Shintom	0072
Shogun	0240
Singer	0072
Sonic Blue	0614, 0616
Sony	0035, 0032, 0000, 0033, 0636, 1032, 1232
Sylvania	0035, 0081, 0000, 0043, 1781
Symphonic	0000
TMK	0240
Tatung	0041
Teac	0000, 0041
Technics	0035, 0162
Teknika	0035, 0037, 0000
Thomas	0000
Tivo	0618, 0636
Toshiba	0045, 0043, 0845
Totevision	0037, 0240
Unitech	0240
Vector	0045
Vector Research	0038
Video Concepts	0045
Videomagic	0037
Videosonic	0240
Villain	0000
Wards	0060, 0035, 0048, 0047, 0081, 0240, 0000, 0042, 0072, 0149, 0760
White Westinghouse	0209, 0072, 1278
XR-1000	0035, 0000, 0072
Yamaha	0038
Zenith	0039, 0000, 0209, 0033, 0479, 1479

DVD players

Brand	Code
Aiwa	0641
Apex Digital	0672, 0717, 0755, 0794, 0796, 0797, 0830, 0856, 1100
Audiologic	0736
B & K	0655, 0662
Blue Parade	0571
Broksonic	0695
DVD2000	0521
Daewoo	0784
Denon	0490, 0634
Emerson	0591
Enterprise	0591
Fisher	0670
GE	0522, 0717
GPX	0699, 0769
Go Video	0715
Gradiente	0651
Greenhill	0717
Harman/Kardon	0582, 0702
Hitachi	0573, 0664
Hiteker	0672
JBL	0702
JVC	0558, 0623, 0867

DVD players (cont.)

Brand	Code
KLH	0717
Kenwood	0490, 0534, 0682, 0737
Konka	0711, 0719, 0720, 0721
Koss	0651
Lasonic	0798
Magnavox	0503, 0675
Malata	0782
Marantz	0539
Microsoft	0522
Mintek	0717
Mitsubishi	0521
Nesa	0717
Next Base	0826
Norcent	0872
Onkyo	0503, 0627
Oritron	0651
Panasonic	0490, 0632, 1362, 1462, 1490
Philips	0503, 0539, 0646, 0854
Pioneer	0525, 0571, 0632
Polk Audio	0539
Princeton	0674
Proscan	0522
RCA	0522, 0571, 0717, 0822
Rotel	0623
Rowa	0823
Sampo	0698
Samsung	0573, 0820
Sansui	0695
Sanyo	0670
Sharp	0630
Sherwood	0633
Shinsonic	0533
Sony	0533, 0864, 1533
Sylvania	0675, 0821
Technics	0490
Techwood	0692
Theta Digital	0571
Toshiba	0503, 0695, 1045
Tredex	0800
Urban Concepts	0503
XBox	0522

Changing channels

To change to a specific channel (programmed or unprogrammed):

Press the Channel Number buttons (0–9 and 100).

For channels 100 and higher, press the 100 button, and then the next two numbers. For example, to select channel 125, press 100, 2, 5.

To change to the next programmed channel:

Press Channel ▲ or ▼ on the TV or remote control.

Changing channels using SpeedSurf

To use SpeedSurf to change to a specific programmed channel:

1. Press and hold Channel ▲ or ▼ for about one second. The TV will enter the SpeedSurf mode.

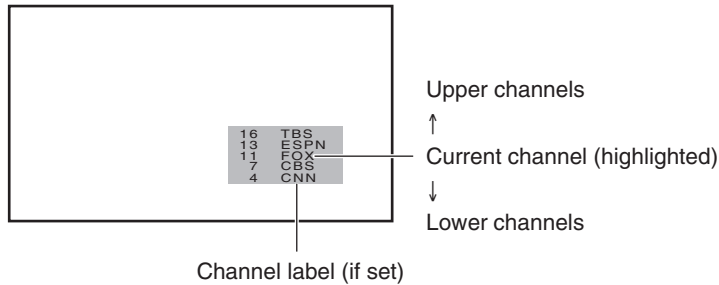

2. Repeatedly press or hold Channel ▲ or ▼ while the SpeedSurf mode is on-screen to scroll the channel list. Release the button to display the highlighted channel.

Adjusting the color convergence

This projection TV uses three separate TV tubes: red, green, and blue. The red, green, and blue images are projected onto the screen where they converge to form a full-color picture. You can see a clear picture only when the three images converge correctly. Convergence may drift over time or if you move the TV. If you can see clear images on your TV screen, skip this procedure.

This adjustment should be made only after the TV has been on for at least 30 minutes.

Automatically adjusting the color convergence using TouchFocus™

Press TouchFocus on the TV once. The TV will enter the auto convergence mode, and adjust convergence automatically.

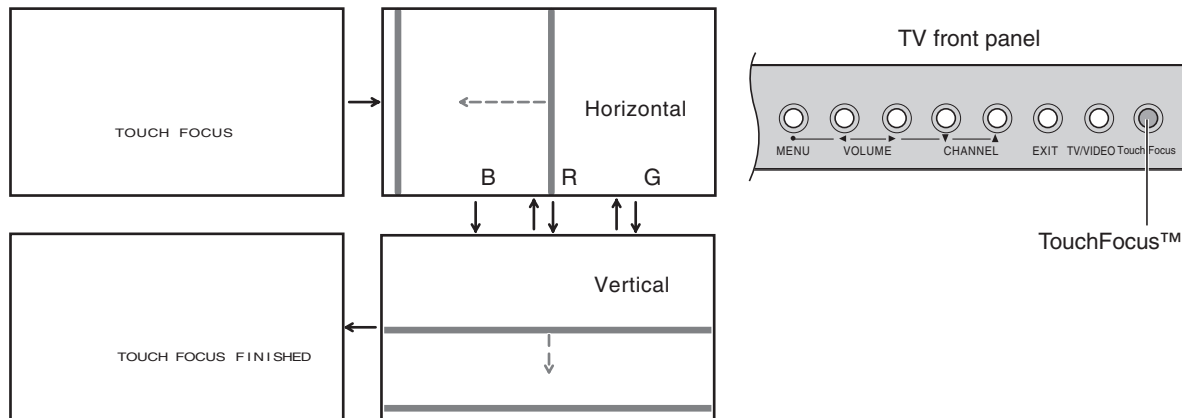

When the adjustment is complete, the normal picture will reappear. If error message “Touch Focus Error” appears, retry the TouchFocus adjustment or adjust the convergence manually, as described below.

(continued on next page)

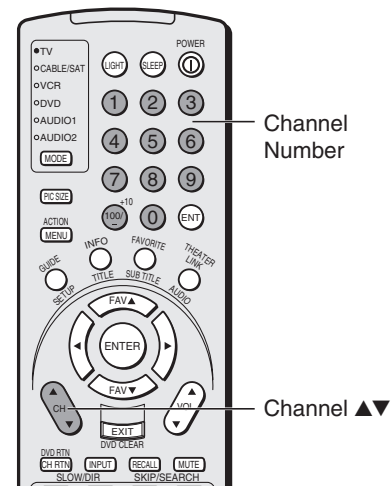

Manually adjusting the color convergence

To check and adjust the color convergence manually:

1. Press MENU, and then press ◀ or ▶ until the PICTURE menu appears.
2. Press ▲ or ▼ to highlight CONVERGENCE (below left).
3. Press ◀ or ▶ to display the Center Convergence menu (below right).

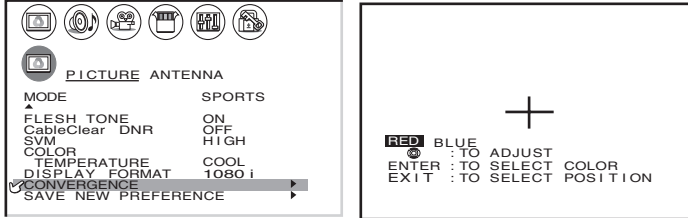

If you see separate red, blue, or green crossed lines (or red or blue shadows next to white lines), you need to adjust the convergence.

4. Press ENTER to highlight RED or BLUE, depending on which color needs adjusting. If both red and blue need adjusting, you will need to perform steps 4 and 5 twice.
5. Press ▲ (up), ▼ (down), ◀ (left), or ▶ (right) on the remote control to converge the red or blue line into the green line, which will turn completely white when correctly adjusted. When color convergence is correctly adjusted, you will see two single crossed white lines.
6. Press EXIT to display the Circumference Convergence menu.
7. Press the corresponding Number button (1–4 and 6–9) to select the area you want to adjust.

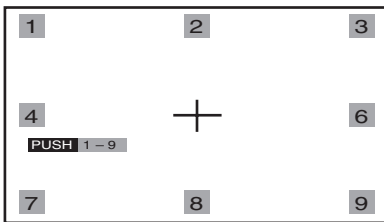

8. Press ENTER to highlight RED or BLUE, depending on which color needs adjusting. If both red and blue need adjusting, you will need to perform steps 8 and 9 twice for the selected area.

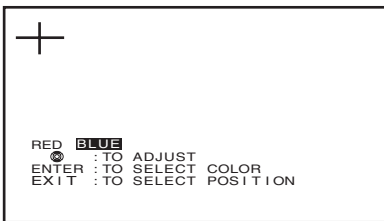

9. Press ▲▼◀▶ to converge the red or blue line into the green line, which will turn completely white when correctly adjusted. Repeat steps 8 and 9 until you see two single crossed white lines.
10. Press EXIT once to select another area to adjust, and then repeat steps 7–9.
11. Press EXIT twice to close the Convergence menu.

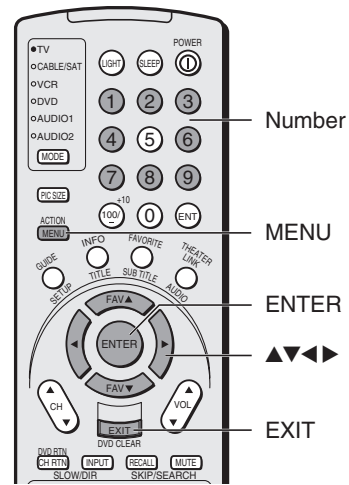

Using the TV's features

Adjusting the channel settings

Switching between two channels using Channel Return

The Channel Return feature allows you to switch between two channels without entering an actual channel number each time.

1. Select the first channel (or video mode) you want to view.
2. Select a second channel using the Channel Number buttons (0–9, 100).
3. Press CH RTN. The previous channel will display.

Each time you press CH RTN, the TV will switch back and forth between the last two channels that were selected.

Switching between two channels using SurfLock™

The SurfLock™ feature temporarily “memorizes” one channel in the CH RTN button, so you can return to that channel quickly from any other channel by pressing CH RTN.

To memorize a channel in the CH RTN button:

1. Select the channel you want to program into the CH RTN button.
2. Press and hold CH RTN for about 2 seconds until the message “Channel Memorized” appears (flashing) on the screen. The channel has been programmed into the CH RTN button.
3. Continue to change channels until your desired channel is selected.
4. Press CH RTN. The memorized channel will be selected.

The TV will return to the memorized channel one time only. Once you press CH RTN and then change channels again, the SurfLock memory will be cleared and the button will function as Channel Return, by switching back and forth between the last two channels that were selected.

Programming your favorite channels

You can preset up to 7 of your favorite channels each for FAVORITE CH1 and FAVORITE CH2 modes using the Favorite Channel Programming feature. Because this feature scans through only your favorite channels, it allows you to skip other channels you do not normally watch.

To program your favorite channels:

1. Press MENU, and then press ◀ or ▶ until the CUSTOM menu appears.
2. Press ▲ or ▼ to highlight FAVORITE CH1 or FAVORITE CH2.

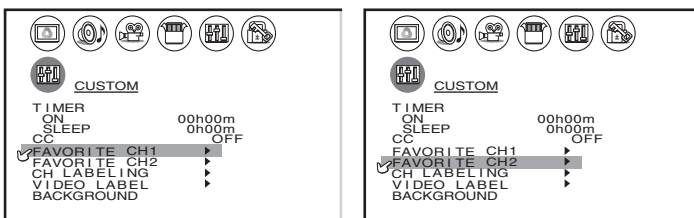

(continued on next page)

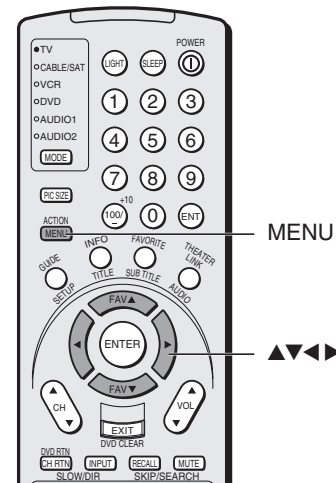
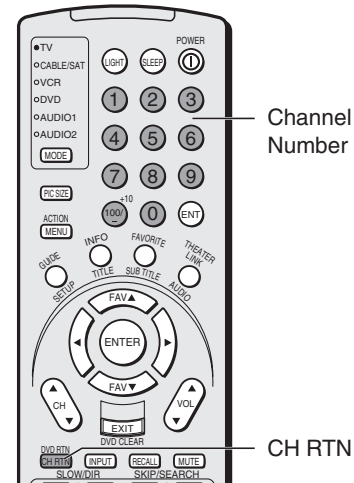

- Press ◀ or ▶ to display the FAVORITE CH1 menu, for example. CH INPUT will be highlighted.

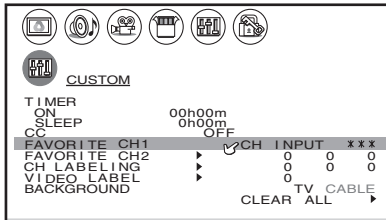

- Press the Channel Number buttons to enter one of your favorite channels.
- Press ENTER.
- Repeat steps 4 and 5 for other channels.

To select your favorite channels:

Press FAV ▼ or ▲.

To quickly scan through your favorite channels in a seven-picture multi-window:

Press FAVORITE (see page 47).

To clear a favorite channel:

- Press MENU, and then press ◀ or ▶ until the CUSTOM menu appears.
- Press ▲ or ▼ to highlight FAVORITE CH2, for example.
- Press ◀ or ▶ to display the FAVORITE CH2 menu.

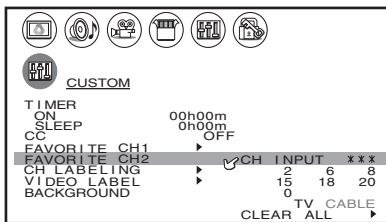

- Press ▲▼◀▶ to highlight the channel you want to clear, then press ENTER.

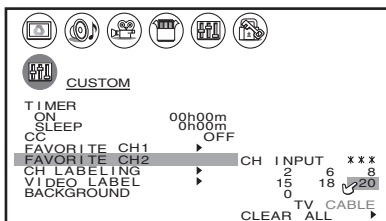

- Repeat step 4 for other channels.

To clear all favorite channels at once:

Press ▲ or ▼ to highlight CLEAR ALL in step 4 above, and then press ◀ or ▶ to clear all favorite channels at once.

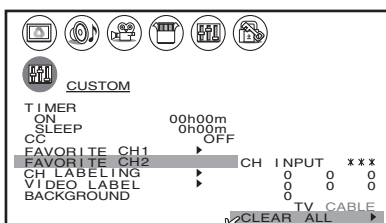

Notes:

- The FAV ▲▼ buttons operate as MENU ▲▼ buttons when a menu is on-screen.
- The favorite channel feature is not available in ANT2 mode.

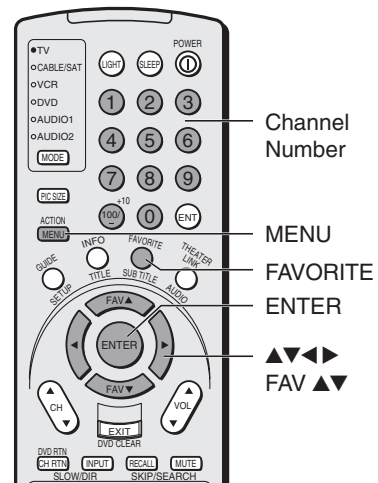

Labeling channels

Channel labels appear above the on-screen channel number display each time you turn on the TV, change a channel, or press RECALL. You can choose any four characters to identify a channel.

To create channel labels:

1. Press MENU, and then press ◀ or ▶ until the CUSTOM menu appears.
2. Press ▲ or ▼ to highlight CH LABELING.
3. Press ◀ or ▶ to display the CH LABELING menu. CH INPUT will be highlighted.

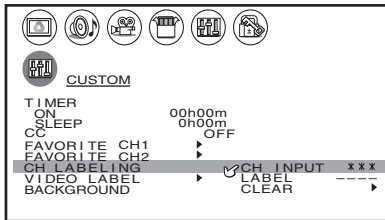

4. Press the Channel Number buttons to select a channel you want to label.

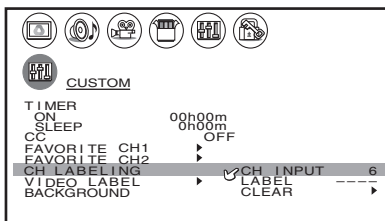

5. Press ▼ to highlight LABEL.
6. Press ◀ or ▶ repeatedly to select a character for the first space, and then press ENTER.

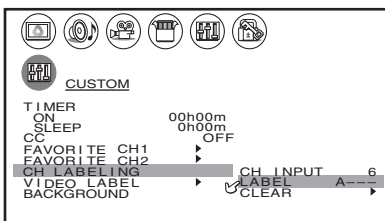

7. Repeat step 6 to enter the rest of the characters.

If you would like a blank space in the label name, you must choose an empty space from the list of characters. Otherwise, a dash “-” will appear in that space.
8. Repeat steps 4–7 for other channels. You can assign labels to a maximum of 32 channels.

To erase channel labels:

1. Press MENU, and then press ◀ or ▶ until the CUSTOM menu appears.
2. Press ▲ or ▼ to highlight CH LABELING.
3. Press ◀ or ▶ to display the CH LABELING menu.
4. Press ▼ to highlight CH INPUT, then select the channel you want to clear with the Channel Number buttons.

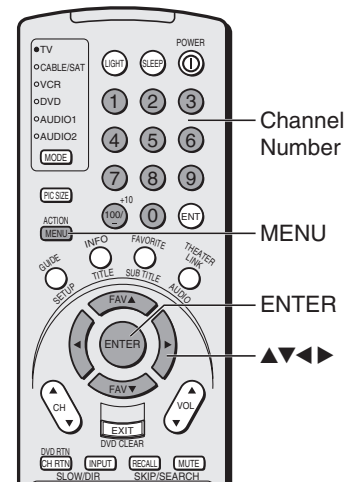

(continued on next page)

5. Press ▼ to highlight CLEAR.
6. Press ◀ or ▶ to erase the channel label.
7. Repeat steps 4–6 to erase other channel labels.

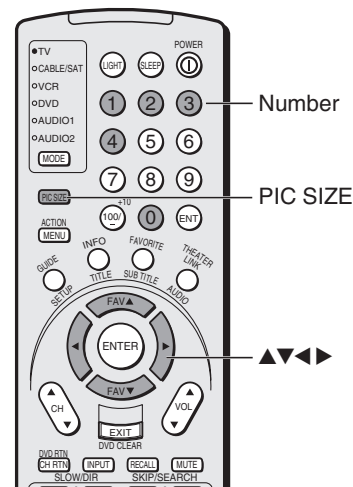
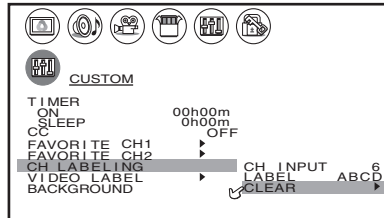

Viewing the widescreen picture formats

You can view programs that have the conventional TV picture format (4:3 aspect ratio) or the widescreen format (16:9 aspect ratio) in a variety of picture sizes.

Selecting the picture size

Repeatedly press PIC SIZE to select either Natural, Theater Wide 1, Theater Wide 2, Theater Wide 3, or Full picture size, as described below.

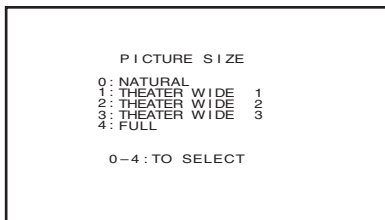

While the above menu is on the screen, you can select the desired picture size by pressing the corresponding number button.

- 480i/480p signal source : 0-4
- 1080i/720p signal source : fixed to 0 (Natural mode only)

Viewing a 480i/480p signal

Natural

The Natural picture size displays the picture in the conventional 4:3 aspect ratio, with bars at the left and right.

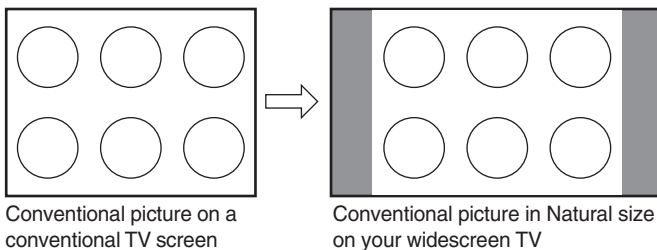

Conventional picture on a conventional TV screen

Conventional picture in Natural size on your widescreen TV

Full

This mode is to enjoy the wide-screen format (16:9 aspect ratio).

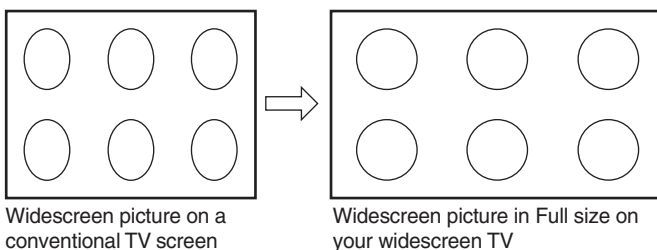

Widescreen picture on a conventional TV screen

Widescreen picture in Full size on your widescreen TV

Note:

When selecting the picture size, the way the image displays will vary depending on the format of the program you are currently watching. See "Notice of possible adverse effects on TV picture tube" below.

NOTICE OF POSSIBLE ADVERSE EFFECTS ON TV PICTURE TUBE

Avoid displaying stationary images on your TV screen for extended periods of time. Fixed (non-moving) images (such as still PIP/POP windows or black/gray bars in wide-screen picture or PIP/POP formats) can become permanently engrained in the picture tube. **This type of damage is NOT COVERED BY YOUR WARRANTY** because it is the result of misuse. See item 33 on page 4.

Note:

If you select the Full picture size for a conventional TV picture signal (4:3 aspect ratio), the picture will be horizontally stretched.

Theater Wide 1

- The picture is non-uniformly enlarged—the center of the picture remains close to its true proportion, but the left and right edges are stretched wider to fill the screen.

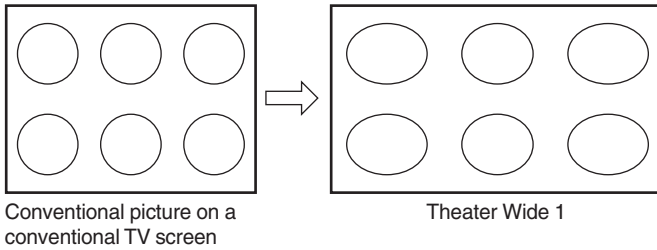

Theater Wide 2

- The entire picture is uniformly enlarged—it is stretched the same amount both wider and taller (retains its true proportion).
- Part of the picture at the top and bottom is hidden. To view the hidden areas, see “Scrolling the Theater Wide picture” on page 42.

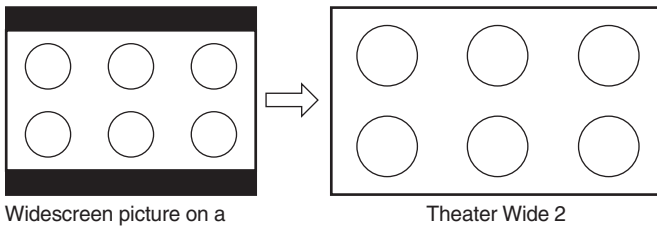

Theater Wide 3

- The picture is non-uniformly enlarged—it is stretched wider to fill the width of the screen, but only slightly stretched taller.
- A small part of the picture at the top and bottom is hidden. To view the hidden areas (Subtitle, Caption, etc), see “Scrolling the Theater Wide picture” on page 42.

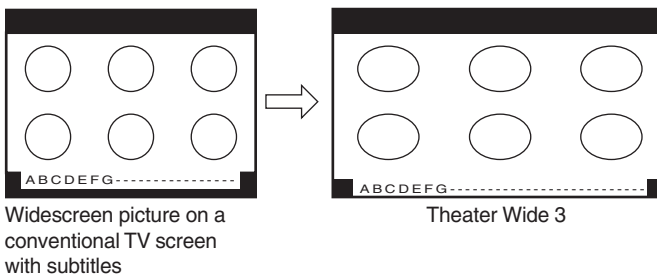

Note:

You can also change the Theater Wide 1, 2, 3 using the menu system. Select PICTURE SIZE in the THEATER menu.

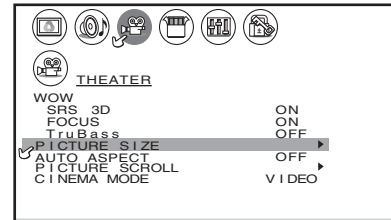

Note:

- If you select the Theater Wide picture mode for conventional size programs, parts of the picture at the top and bottom of the screen may be hidden.
- When selecting the picture size, the way the image displays will vary depending on the format of the program you are currently watching. See “Notice of possible adverse effects on TV picture tube” below.

NOTICE OF POSSIBLE ADVERSE EFFECTS ON TV PICTURE TUBE

Avoid displaying stationary images on your TV screen for extended periods of time. Fixed (non-moving) images (such as still PIP/POP windows or black/gray bars in wide-screen picture or PIP/POP formats) can become permanently engrained in the picture tube. **This type of damage is NOT COVERED BY YOUR WARRANTY** because it is the result of misuse. See item 33 on page 4.

Using the special functions to change the size of the displayed image (i.e. changing the height/width ratio) for the purpose of public display or commercial gain may infringe on copyright laws.

Scrolling the Theater Wide picture (Theater Wide 2 and 3 only)

1. Press PIC SIZE to select the Theater Wide 2 or 3 mode.
2. Press MENU, and then press ◀ or ▶ until THEATER menu appears.
3. Press ▲ or ▼ to highlight PICTURE SCROLL.

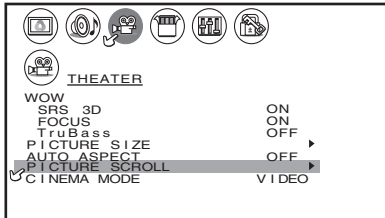

4. Press ◀ or ▶ to display the Scroll Adjustment mode.

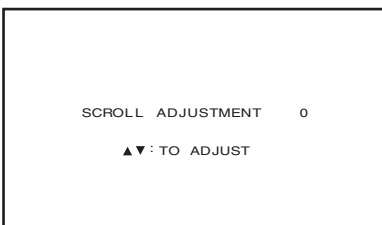

5. Press ▲ or ▼ to adjust the vertical position of the picture.
 - Normal (center) position

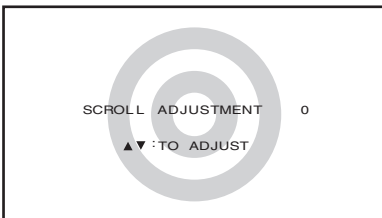

- To raise the picture, press ▲.

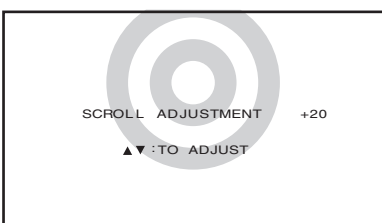

- To lower the picture, press ▼.

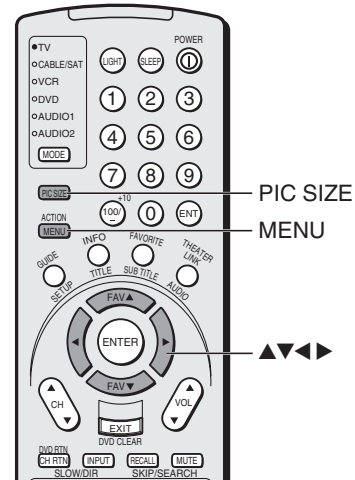
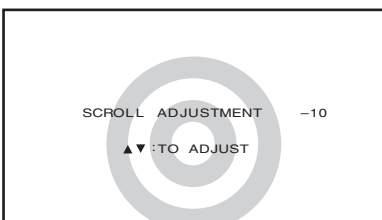

Note:

You can scroll the picture in Theater Wide 2 and Theater Wide 3 only. The scroll amounts are as follows:

- 480i signal source:
 - Wide 1 : Not adjustable
 - Wide 2 : +20 to -10
 - Wide 3 : +20 to -10
- 480p signal source:
 - Wide 1 : Not adjustable
 - Wide 2 : +20 to -10
 - Wide 3 : +20 to -10
- 720p signal source: Not adjustable
- 1080i signal source: Not adjustable

NOTICE OF POSSIBLE ADVERSE EFFECTS ON TV PICTURE TUBE

Avoid displaying stationary images on your TV screen for extended periods of time. Fixed (non-moving) images (such as still PIP/POP windows or black/gray bars in wide-screen picture or PIP/POP formats) can become permanently engrained in the picture tube. **This type of damage is NOT COVERED BY YOUR WARRANTY** because it is the result of misuse. See item 33 on page 4.

Using the AUTO ASPECT feature (480i signals only)

When the AUTO ASPECT feature is set to ON and the TV receives a 480i signal, the picture size is automatically selected (as described in the following table).

Aspect ratio of signal source	Automatic aspect size (automatically selected when AUTO ASPECT is ON)
4:3	Theater Wide 2
16:9	Full
Not defined (no ID-1 data)	User-selected picture size (pgs. 40–41)

1. Press MENU, and then press ◀ or ▶ until the THEATER menu appears.

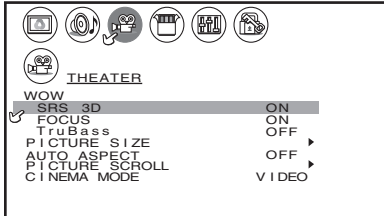

2. Press ▲ or ▼ to highlight AUTO ASPECT, and then press ◀ or ▶ to select ON.

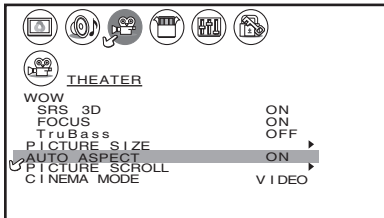

Selecting the cinema mode

When you view a DVD movie (3-2 pulldown processed) from a DVD player connected to the ColorStream (component video) or DVI/HDCP inputs on the TV, smoother and more natural motion can be obtained by setting the CINEMA MODE to FILM (auto).

To set the CINEMA MODE to FILM (auto):

1. Press MENU, and then press ◀ or ▶ until the THEATER menu appears.
2. Press ▲ or ▼ to highlight CINEMA MODE.
3. Press ◀ or ▶ to select FILM (auto).

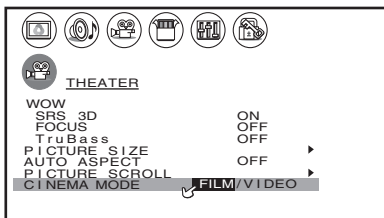

To set the CINEMA MODE to VIDEO (off):

Press ◀ or ▶ to select VIDEO in step 3 above.

Note:

The AUTO ASPECT feature is not available when viewing antenna (cable) or DVI input sources.

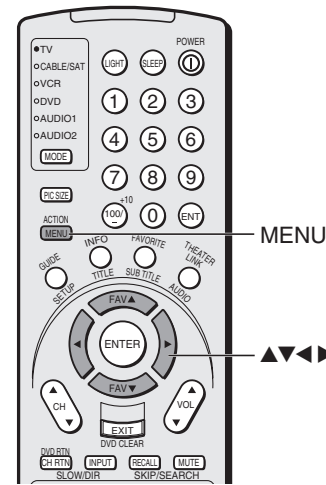

NOTICE OF POSSIBLE ADVERSE EFFECTS ON TV PICTURE TUBE

Avoid displaying stationary images on your TV screen for extended periods of time. Fixed (non-moving) images (such as still PIP/POP windows or black/gray bars in wide-screen picture or PIP/POP formats) can become permanently engrained in the picture tube. **This type of damage is NOT COVERED BY YOUR WARRANTY** because it is the result of misuse. See item 33 on page 4.

Using the POP double-window feature

The POP (picture-out-picture) feature splits the screen into a double window that allows you to watch two programs at the same time. The POP program can come from a TV broadcast or an external source, such as a VCR.

To display a TV broadcast in the POP window:

1. Press SPLIT to display the POP window.

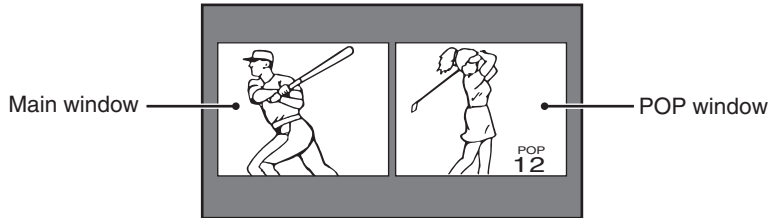

2. Select channels of the POP window in the following two ways:
 - To change to a specific channels, press POP DIRECT CH. While “POP” is on the screen, press the Channel Number buttons (0-9 and 100).
 - To change the next programmed channels, press POP CH ▲▼.

If the V-CHIP feature is active and you try to watch a TV program that exceeds your set rating limits, the program will be blocked (see “Using the V-CHIP menu” on page 49).

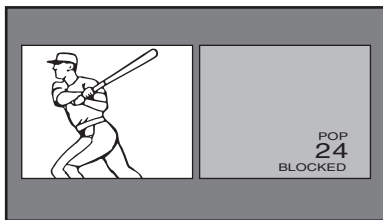

To display a picture from an external source in the POP window:

1. Connect the external source equipment (see “Connecting your TV” on page 8).
2. Select the TV program you want to watch in the main window.
3. Press SPLIT to display the POP window.
4. Repeatedly press SOURCE to select the input source for the POP window (VIDEO 1, VIDEO 2, VIDEO 3, ColorStream HD1, or ColorStream HD2 only; you cannot select DVI in POP mode). The current source will display in purple.
5. You can play a tape as the POP picture, or select a channel for the POP window using the VCR’s channel keys.

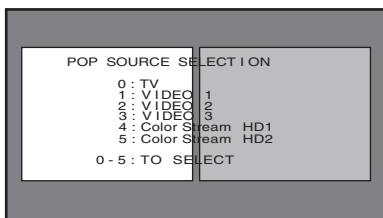

While the above menu is on the screen, you can select the desired signal input source by pressing the corresponding number button (0-5).

To close the POP window:

Press SPLIT again or EXIT.

Note:

- You cannot access POP features when viewing DVI input.
- You cannot display the ANT-2 signal source in the POP window.
- You can choose to hear the sound of either the main or POP program (see “Selecting the Audio OUT sound” on page 65).

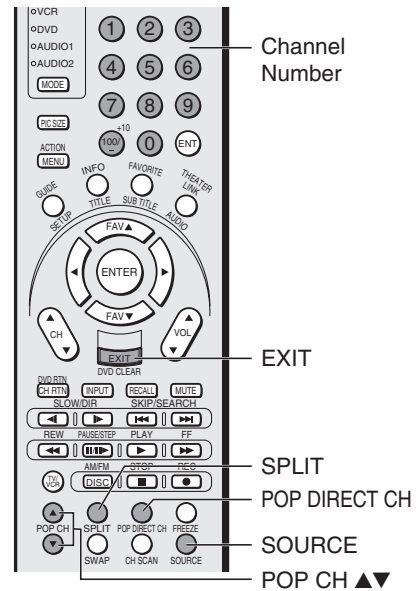

NOTICE OF POSSIBLE ADVERSE EFFECTS ON TV PICTURE TUBE

Avoid displaying stationary images on your TV screen for extended periods of time. Fixed (non-moving) images (such as still PIP/POP windows or black/gray bars in wide-screen picture or PIP/POP formats) can become permanently engrained in the picture tube. **This type of damage is NOT COVERED BY YOUR WARRANTY** because it is the result of misuse. See item 33 on page 4.

Switching the main and POP pictures

Press SWAP while you are using the POP feature to switch the main and POP pictures.

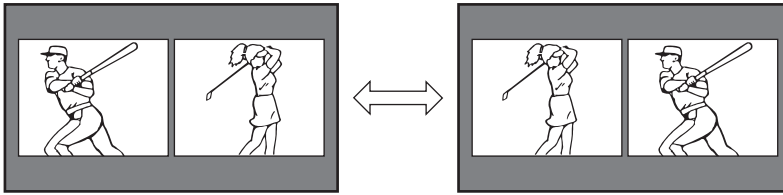

Freezing the POP picture

1. Press FREEZE while the POP is not on the screen. The POP window will appear with a still picture.
2. Press FREEZE again to renew the still picture.

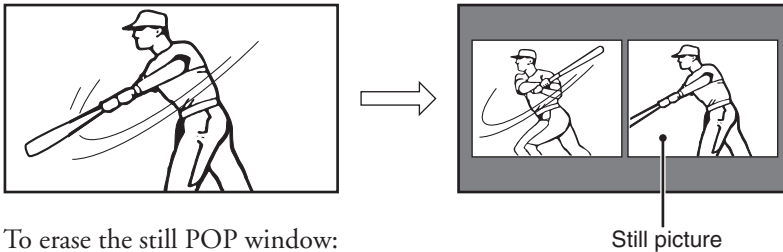

To erase the still POP window:
Press EXIT.

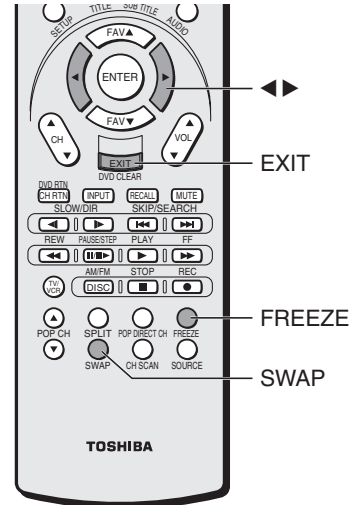

Adjusting the size of the double-window

When the input signals of the main and POP pictures are 480i, you can adjust the size of each window. Continuously pressing ◀ or ▶ changes the size in 9 steps.

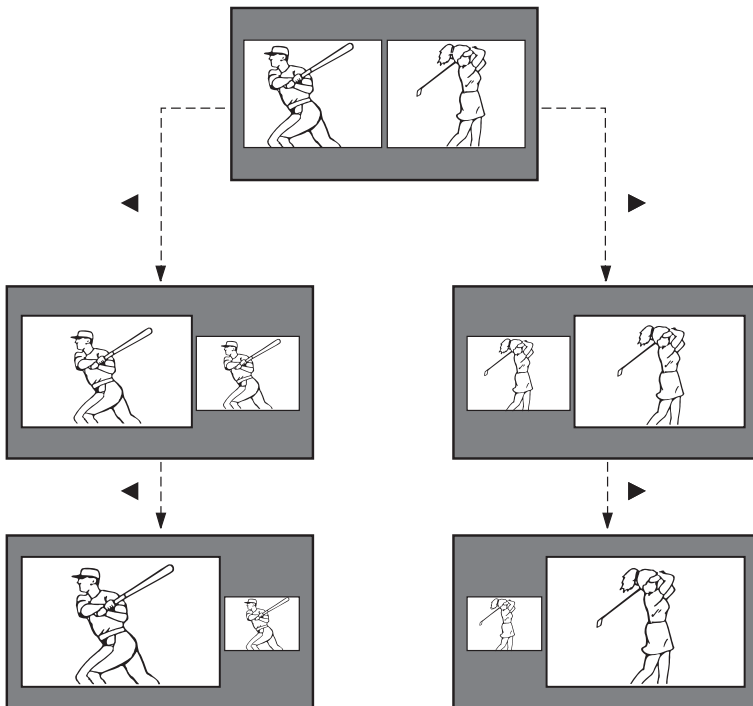

Note:

If a signal format other than 480i is received, this feature is not available. "Not available" will appear on the screen.

NOTICE OF POSSIBLE ADVERSE EFFECTS ON TV PICTURE TUBE

Avoid displaying stationary images on your TV screen for extended periods of time. Fixed (non-moving) images (such as still PIP/POP windows or black/gray bars in wide-screen picture or PIP/POP formats) can become permanently engraved in the picture tube. **This type of damage is NOT COVERED BY YOUR WARRANTY** because it is the result of misuse. See item 33 on page 4.

POP double-window aspect ratio

The POP double-window feature displays each picture according to its input signal aspect ratio, as illustrated below.

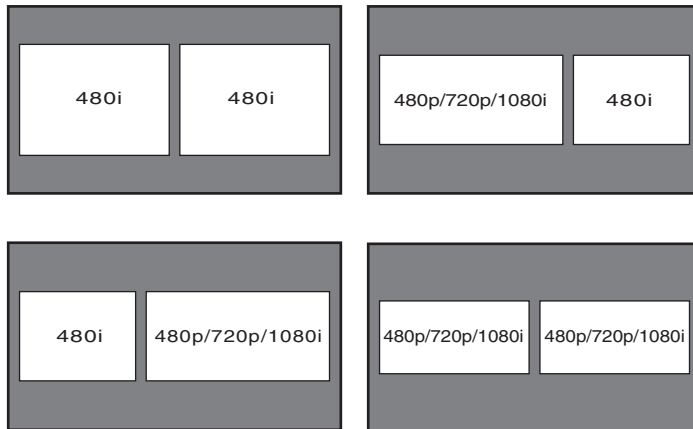

Using the programmed channel search function

You can use the programmed channel search function to quickly scan your programmed channels (see “Adding channels to TV’s memory” on page 28).

1. Press CH SCAN.

The TV automatically enters POP mode, and begins a seven-picture scan of your programmed channels in the POP window.

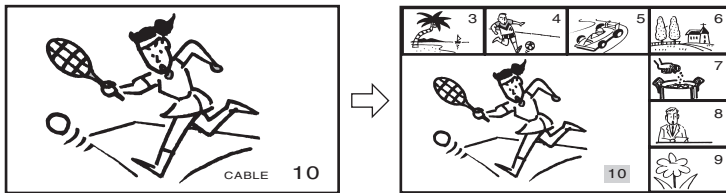

2. Press ▲▼◀▶ to select one of the seven pictures (becomes a moving picture). The main picture is an always moving picture.
3. Press ENTER to display the channel you selected in step 2 as a normal picture.

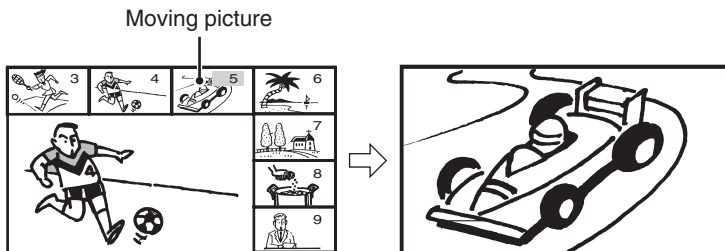

Note:

The AUTO ASPECT feature (page 43) does not operate in POP double-window mode.

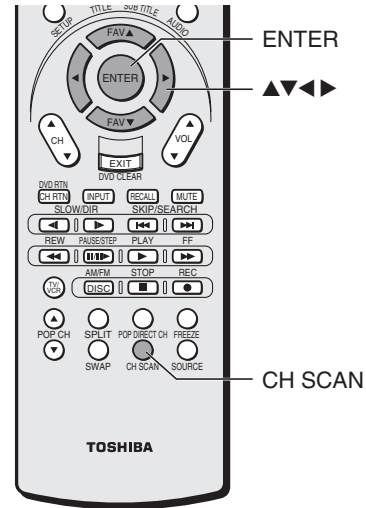

Note:

During the programmed channel search, all main and POP windows display in 16:9 aspect ratio, regardless of the signal format.

NOTICE OF POSSIBLE ADVERSE EFFECTS ON TV PICTURE TUBE

Avoid displaying stationary images on your TV screen for extended periods of time. Fixed (non-moving) images (such as still PIP/POP windows or black/gray bars in wide-screen picture or PIP/POP formats) can become permanently engrained in the picture tube. **This type of damage is NOT COVERED BY YOUR WARRANTY** because it is the result of misuse. See item 33 on page 4.

Using the favorite channel search function

You can use the favorite channel search function to quickly scan your favorite channels (see “Programming your favorite channels” on page 37).

1. Press FAVORITE.
The TV automatically enters POP mode, and begins a seven-picture scan of your favorite channels in the POP window.

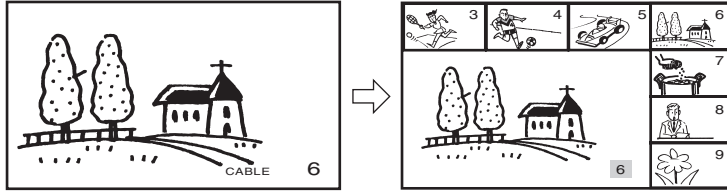

2. Press ▲▼◀▶ to select one of the seven pictures (becomes a moving picture). The main picture is an always moving picture.
3. Press ENTER to display the channel you selected in step 2 as a normal picture.

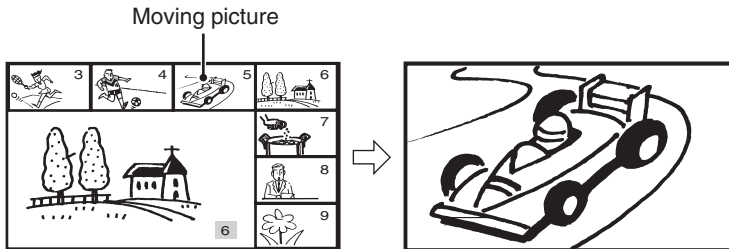

Every time you press FAVORITE, the POP window scans your favorite channels in the following order:

FAVORITE CH1 — FAVORITE CH2 — Off

About the auto favorite feature

If your TV is in the program lock mode, after 4 seconds, the TV starts the auto favorite channel search function. See page 51 for details.

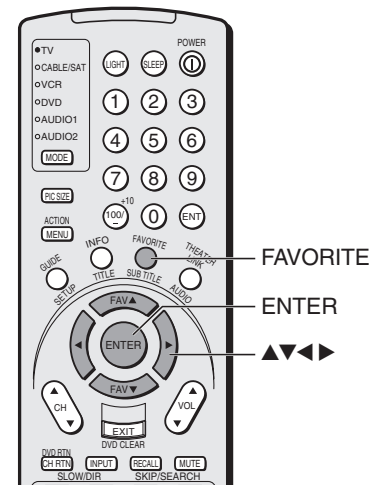
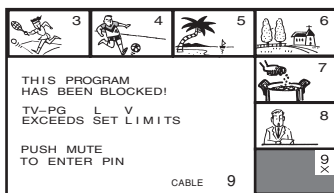

Note:

This feature does not operate in the DVI mode.

NOTICE OF POSSIBLE ADVERSE EFFECTS ON TV PICTURE TUBE

Avoid displaying stationary images on your TV screen for extended periods of time. Fixed (non-moving) images (such as still PIP/POP windows or black/gray bars in wide-screen picture or PIP/POP formats) can become permanently engraved in the picture tube. **This type of damage is NOT COVERED BY YOUR WARRANTY** because it is the result of misuse. See item 33 on page 4.

Using the LOCKS menu

The LOCKS menu includes the V-Chip, CH Lock, Video Lock, and New PIN Code functions. You can use these functions after entering the correct PIN code.

Entering the PIN code

1. Press MENU, and then press ◀ or ▶ until the LOCKS menu appears.

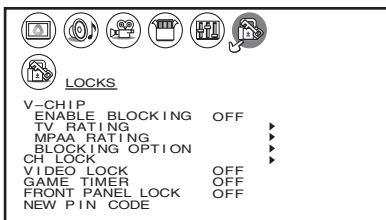

2. Press ▲ or ▼ to display the PIN code entering mode.

- Blocking Reset status: Set your 4-digit code by pressing the Number buttons (0–9), and then press ENTER.
- When the PIN code is already stored: Press the Number buttons (0–9) to enter the 4-digit PIN code used for blocking channels, and then press ENTER.



If the wrong PIN code is entered, the message “Incorrect” appears. Enter the code again, and then press ENTER.

If you cannot remember your PIN code

While the PIN code entering screen is displayed, press RECALL four times within five seconds. The PIN code will be released (blocking reset status restored).

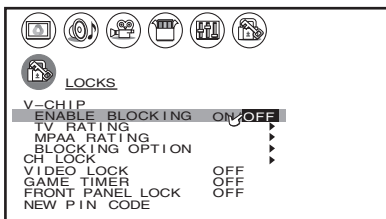

Continue to set each item following the steps on the next page.

Note:

The V-Chip function is available only for the U.S. V-Chip system. The Canadian V-Chip system is not supported.

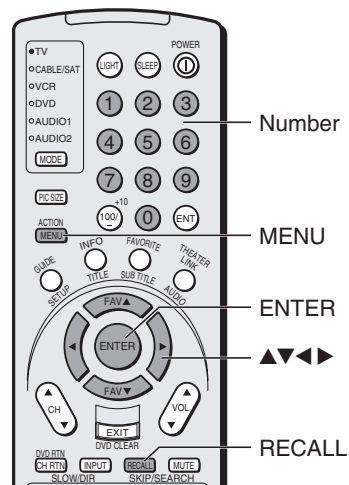

Using the V-CHIP menu

Some TV programs and movies include signals that classify the content of the program (violence, sex, dialog, language). The V-CHIP control feature in this TV detects the signals and blocks the programs according to your selections. To use this feature, perform the following setup.

ENABLE BLOCKING

1. From the LOCKS menu, select ENABLE BLOCKING.
2. Press ◀ or ▶ to select ON or OFF.
ON : To enable your setting (Lock)
OFF: To release your setting (Unlock)

Note: The CH LOCK function is not affected with this selection.

TV RATING (Independent rating system for broadcasters)

1. From the LOCKS menu, select TV RATING.
2. Press ◀ or ▶ to display the TV RATING menu.
3. Press ▼ or ▲ to select item.
4. Press ▶ to lock (display "X")
Press ◀ to unlock (display "✓")
5. Repeat steps 3 and 4 to set the next item.

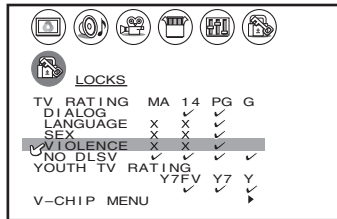

The TV age-based ratings and content themes you can be lock are listed in the table below.

Ratings	Description and Content themes
MA	Mature Audience Only (This program is specifically designed to be viewed by adults and therefore may be unsuitable for children under 17.) L) Crude or indecent language S) Explicit sexual activity V) Graphic violence
14	Parents Strongly Cautioned (This program contains some material that many parents would find unsuitable for children under 14 years of age.) D) Intensely suggestive dialog L) Strong, coarse language S) Intense sexual situations V) Intense violence
PG	Parental Guidances Suggested (This program contains material that parents may find unsuitable for younger children.) D) Some suggestive dialog L) Infrequent coarse language S) Some sexual situations V) Moderate violence
G	General Audience (Most parents would find this program suitable for all ages.)
Y7, Y7FV	Directed to Older Children (This program is designed for children age 7 and above. Note: Programs in which fantasy violence may be more intense or more combative than other programs in this category are designated Y7FV.)
Y	All Children (This program is designed to be appropriate for all children.)

Note:

The V-Chip function is available only for the U.S. V-Chip system. The Canadian V-Chip system is not supported.

LOCKS menu

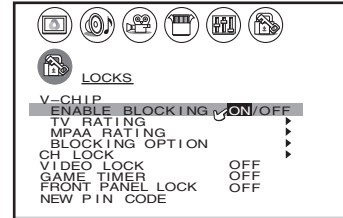

To select each item:

Press ▼ or ▲.

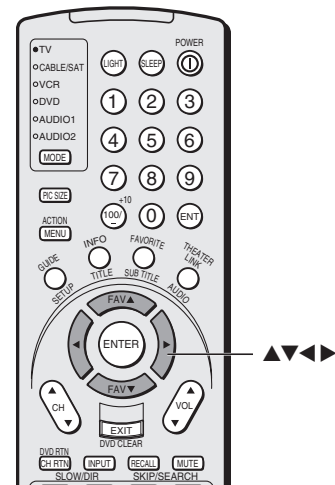

Press RECALL to display the rating of the TV program you are currently watching.

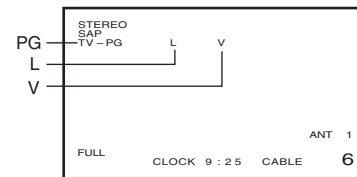

MPAA RATING (Independent rating system for movies)

1. From the LOCKS menu, select MPAA RATING.
2. Press ◀ or ▶ to display the MPAA RATING menu, then press ▼ or ▲ to highlight MPAA RATING.
3. Press ◀ or ▶ to display the MPAA RATING menu.

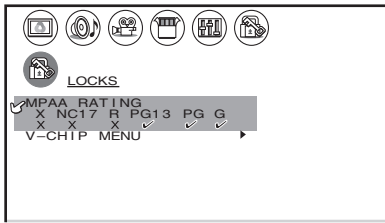

4. Press ▶ to lock ("X") or press ◀ to unlock ("✓").

The movie ratings you can lock are described as follows:

- X : X-rated (For adults only)
- NC17: Not intended for anyone 17 and under
- R : Restricted (Under 17 requires accompanying parent or adult guardian.)
- PG13 : Parents Strongly Cautioned (Some material may be inappropriate for children under 13)
- PG : Parental Guidance Suggested (Some material may not be suitable for children)
- G : General Audience (Appropriate for all ages)

BLOCKING OPTION

1. From the LOCKS menu, select BLOCKING OPTION.
2. Press ◀ or ▶ to display the BLOCKING OPTION menu, then press ▲ or ▼ to select item.

MPAA UNRATED:

Press ◀ or ▶ to select ON (Lock) or OFF (Unlock) for unrated programs in the MPAA rating system.

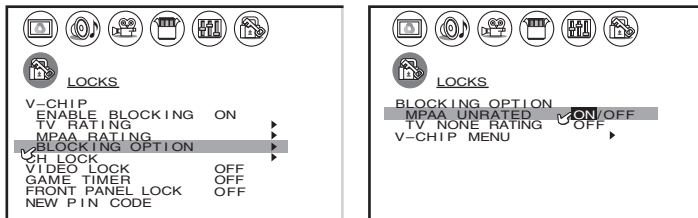

TV NONE RATING

Press ◀ or ▶ to select ON (Lock) or OFF (Unlock) for programs rated NONE in the TV PARENTAL GUIDELINES.

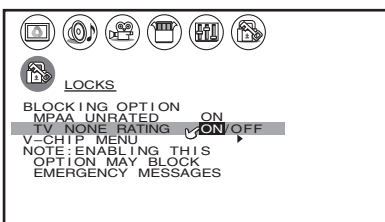

V-CHIP MENU:

Press ◀ or ▶ to return to the LOCKS menu.

LOCKS menu

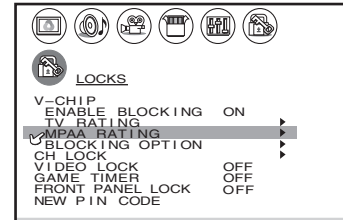

To select each item:

Press ▼ or ▲.

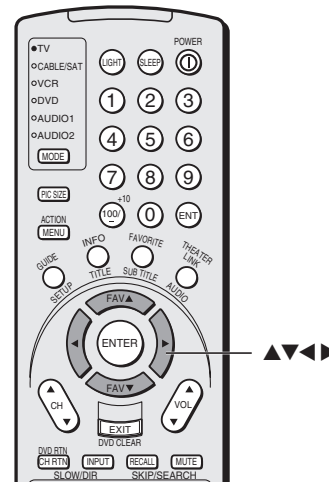

Caution

Be aware that setting the TV None Rating to ON may block the broadcast of emergency information. The menu will display the note, "Enabling this option may block emergency messages" to warn you of this possibility.

Unlocking programs temporarily

1. If you try to watch a TV program that exceeds the rating limits you set, the TV enters program lock mode. After 4 seconds, the TV starts the auto favorite channel search function (see page 47). You can either unlock the program temporarily (see steps 2-4) or select a non-locked program to watch.

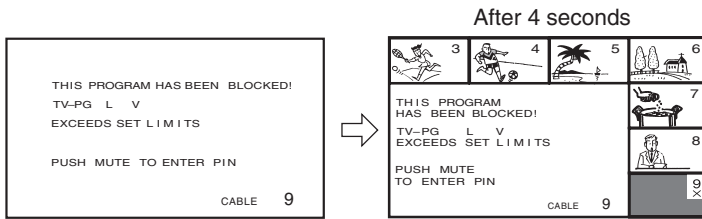

2. To temporarily unlock the program, press MUTE.
3. Press the Number buttons (0-9) to enter your 4-digit PIN code.

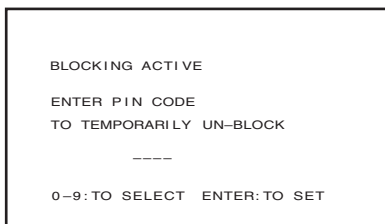

4. Press ENTER.

If the correct code is entered, the program lock mode is released and the normal picture appears.

All locking is disabled until the TV is turned off, and will be enabled when the TV is turned on again.

Locking channels

With the CH LOCK feature, you can lock specific channels. The TV will not be able to tune locked channels with the Channel \blacktriangle \blacktriangledown buttons or Channel Number buttons, unless you clear the setting.

You can lock a maximum of nine channels.

To lock channels:

1. From the LOCKS menu, select CH LOCK.
2. Press \blacktriangleleft or \blacktriangleright to display the CH LOCK menu. CH INPUT will be highlighted.
3. Press the Channel Number buttons to enter the channel you want to lock.
4. Press ENTER.

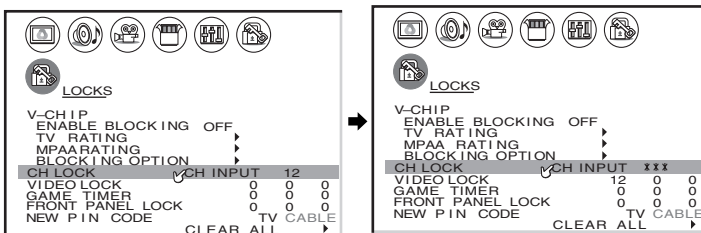

5. Repeat steps 3 and 4 for other channels.

NOTICE OF POSSIBLE ADVERSE EFFECTS ON TV PICTURE TUBE

Avoid displaying stationary images on your TV screen for extended periods of time. Fixed (non-moving) images (such as still PIP/POP windows or black/gray bars in wide-screen picture or PIP/POP formats) can become permanently engrained in the picture tube. **This type of damage is NOT COVERED BY YOUR WARRANTY** because it is the result of misuse. See item 33 on page 4.

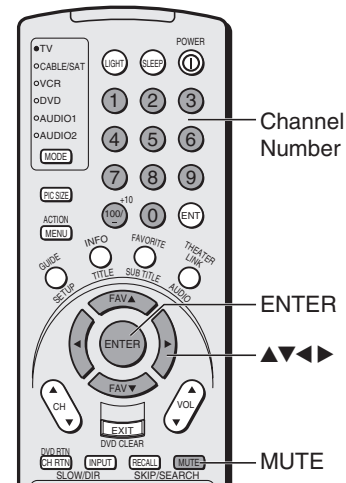

LOCKS menu

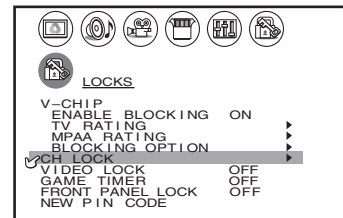

To select each item:

Press \blacktriangledown or \blacktriangle .

To unlock individual channels:

1. From the LOCKS menu, select CH LOCK.
2. Press ◀ or ▶ to display the CH LOCK menu.
3. Press ▲▼◀▶ to highlight the channel you want to unlock, then press ENTER.

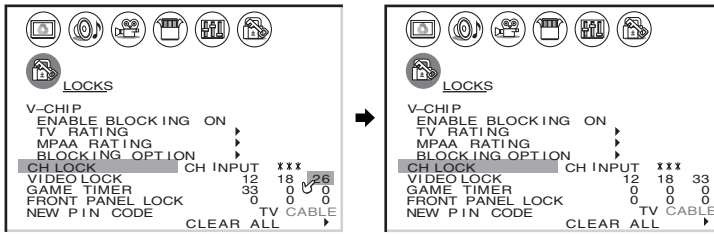

4. Repeat step 3 for other channels.

To unlock all locked channels at once:

Press ▲ or ▼ to highlight CLEAR ALL, and then press ◀ or ▶.

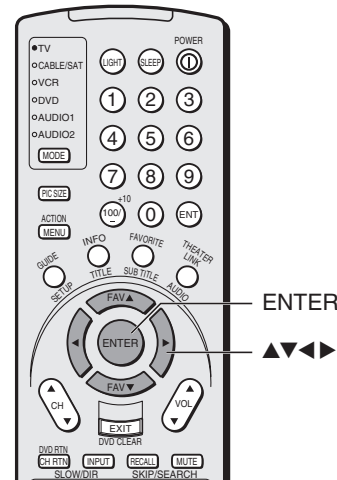
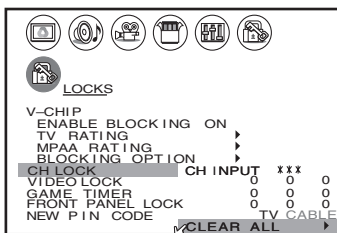

Locking video inputs

With the VIDEO LOCK feature, you can lock out the input sources (Video 1, Video 2, Video 3, ColorStream HD1, ColorStream HD2, DVI/HDCP) and channels 3 and 4.

You will not be able to select the input sources with the TV/VIDEO button or Channel buttons unless you clear the setting.

To set up the video lock:

1. From the LOCKS menu, select VIDEO LOCK.
2. Press ◀ or ▶ to highlight the level of video locking you want (Video, Video+, or Off), as follows:
 VIDEO : Locks Video 1, Video 2, Video 3, ColorStream HD1, HD2, and DVI/HDCP.

VIDEO+ : Locks Video 1, Video 2, Video 3, ColorStream, HD1/HD2, DVI/HDCP, and channels 3 and 4. This option should be used if you use the antenna terminal to play a video tape.

Note: Make sure the POP is not on channel 3 or 4.

OFF : Unlocks all video input sources.

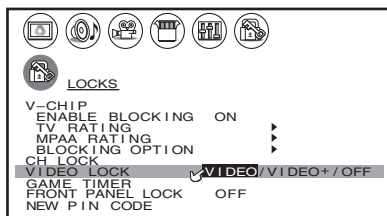

Using the game timer

This feature allows you to restrict the time which has chosen the video mode. When the time set up beforehand is passed, the last tuned channel will be selected automatically (The VIDEO LOCK is set to VIDEO).

To set the game timer:

1. From the LOCKS menu, select GAME TIMER.
2. Press ◀ or ▶ to select the length of time until the video mode is blocked from among 30, 60, 90 and 120 minutes. When the number is highlighted, the timer will start countdown.

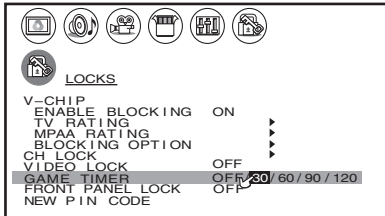

To cancel the timer:

Select OFF in step 2 above.

Using the front panel lock feature

Lock the front panel buttons to prevent the buttons from being pressed accidentally (by children, for example). When the front panel lock is in ON, all control buttons on the TV front panel (except POWER) do not operate.

To lock the front panel:

1. From the LOCKS menu, select FRONT PANEL LOCK.
2. Press ◀ or ▶ to highlight ON.

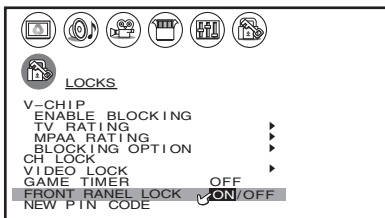

If a button on the front panel is pressed, the message “Not Available” appears.

To unlock the front panel:

Highlight OFF in step 2 above, or press and hold the VOL ◀ button on the TV for about 10 seconds until the message “Front Panel Lock: Off” appears on the screen.

Changing the PIN code

1. From the LOCKS menu, select NEW PIN CODE.
2. Press the Number buttons (0-9) to enter a 4-digit code. The numbers you enter will replace the dashes in the display.

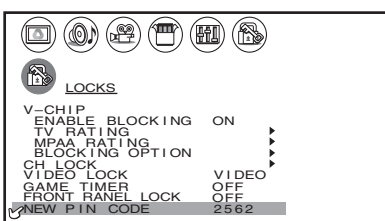

3. Press ENTER.
The new PIN code is now active.

Note:

After the game timer set is operated, set the VIDEO LOCK to “OFF” is necessary.

TV front panel

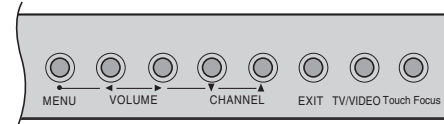

Buttons to be locked

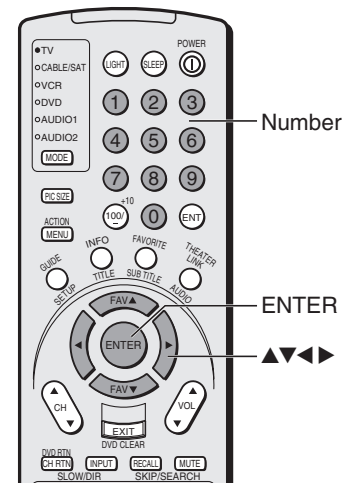

Adjusting the picture

Selecting the picture mode

You can select your desired picture type from four picture modes: Sports, Standard, Movie, and Preference.

Mode	Picture Quality
Sports	Bright and dynamic picture (factory setting)
Standard	Standard picture setting (factory setting)
Movie	Movie-like picture setting (factory setting)
Preference	Your personal preference*

*(see “Saving new preference” on page 55.)

To select the picture mode:

1. Press MENU, and then press ◀ or ▶ until the PICTURE menu appears.
2. Press ▼ or ▲ to select MODE.
3. Press ◀ or ▶ to highlight the mode you prefer.

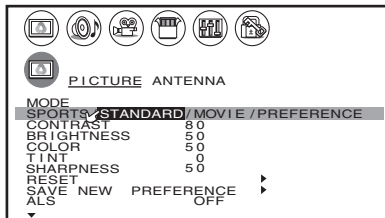

Note:

If you select one of the factory-set picture modes (SPORTS, STANDARDS, or MOVIE) and then change a picture quality setting (for example, increase the contrast), the picture mode automatically changes to PREFERENCE in the Picture menu.

To save your new picture quality settings, you must select SAVE NEW PREFERENCE (see page 55) before closing the Picture menu or the TV will return to the previous picture mode.

TV front panel

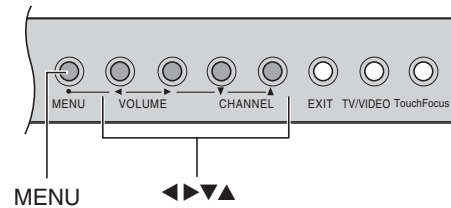

Adjusting the picture quality

You can adjust the picture quality to your personal preferences, including the contrast, brightness, color, tint, sharpness, flesh tone, noise reduction and color temperature.

Selection	◀ Pressing ▶	
contrast	lower	higher
brightness	darker	lighter
color	paler	deeper
tint	reddish	greenish
sharpness	softer	sharper

To adjust the picture quality:

1. Press MENU, and then press ◀ or ▶ until the PICTURE menu appears.
2. Press ▼ or ▲ until the item you want to adjust is highlighted.
3. Press ◀ or ▶ to adjust the level.

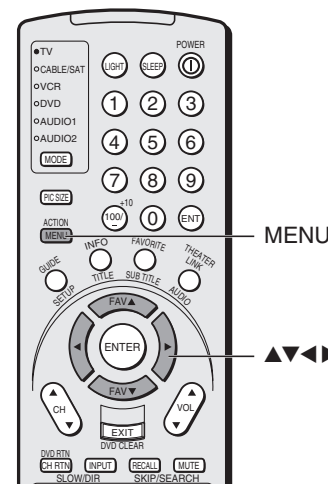
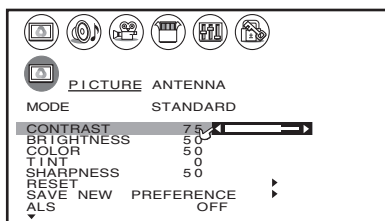

The PICTURE qualities you adjusted can be saved in the TV's memory with the SAVE NEW PREFERENCE feature (see page 55). You can keep these settings or choose factory set options, as described under “Selecting the picture mode” above.

Saving your new preferences

You can save the PICTURE qualities (contrast, brightness, color, tint, and sharpness) you adjusted in the picture preference mode.

To save your new preferences:

1. Press MENU, and then press ◀ or ▶ until the PICTURE menu appears.
2. Press ▲ or ▼ to highlight SAVE NEW PREFERENCE.
3. Press ◀ or ▶. When complete, the menu displays “DONE”.

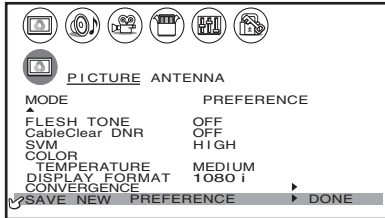

The mode automatically change to PREFERENCE (see “Selecting the picture mode” on page 54).

Using the ALS (ambient light sensor) feature

ALS senses the room ambient light and automatically adjusts the picture contrast for varying light conditions. For example, when the room is dark, the ALS will automatically reduce the contrast (which reduces eye strain). ALS is energized when the ALS menu is set to ON.

To activate the ALS:

1. Press MENU, and then press ◀ or ▶ until the PICTURE menu appears.
2. Press ▲ or ▼ to highlight ALS.
3. Press ◀ or ▶ to highlight ON. The CONTRAST setting changes to AUTO, and is not adjustable while the ALS feature is on.

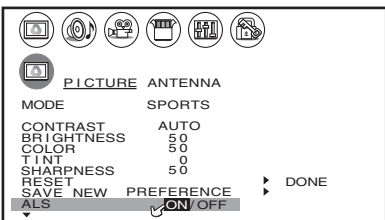

To deactivate the ALS:

Highlight OFF in step 3 above.

Using the flesh tone feature

This feature displays natural flesh tones by correcting the tint.

To turn on the flesh tone feature:

1. Press MENU, and then press ◀ or ▶ until the PICTURE menu appears.
2. Press ▲ or ▼ to highlight FLESH TONE.
3. Press ◀ or ▶ to highlight ON.

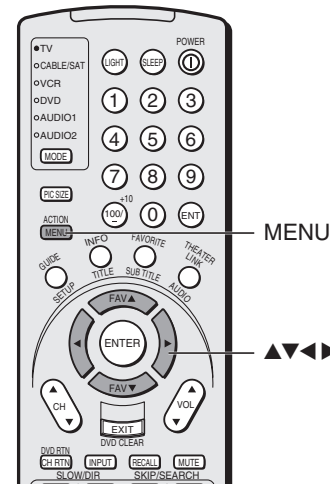
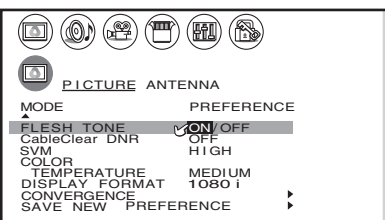

Note:

Do not cover the ALS sensor on the front panel of the TV.

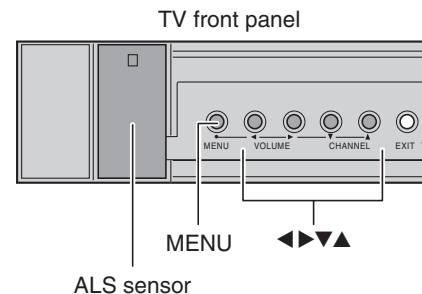

Using CableClear™ DNR (digital noise reduction)

This feature allows you to reduce visible interference in your TV picture. This is useful when receiving a broadcast with a weak signal (especially a Cable channel) or playing back a video cassette or disc damaged by repeated use.

To turn on CableClear DNR:

1. Press MENU, and then press ◀ or ▶ until the PICTURE menu appears.
2. Press ▲ or ▼ to highlight CableClear DNR.
3. Press ◀ or ▶ to highlight AUTO.

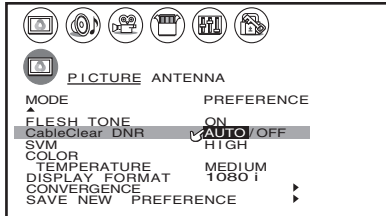

To turn off CableClear DNR:

Highlight OFF in step 3 above.

Selecting the Scan Velocity Modulation (SVM)

The SVM feature enhances picture contrast and sharpness. This feature has three modes: HIGH, LOW, and OFF.

To select the SVM feature:

1. Press MENU, and then press ◀ or ▶ until the PICTURE menu appears.
2. Press ▲ or ▼ to highlight “SVM”.
3. Press ◀ or ▶ to highlight the mode you prefer (HIGH, LOW, or OFF).

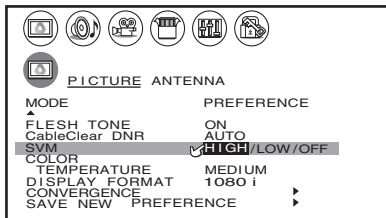

Note:

The CableClear DNR feature is not available for the DVI mode (fixed to OFF).

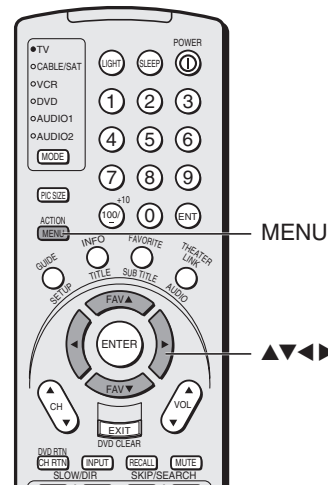

Note:

SVM is not required when viewing some high-quality video material. If you are watching high-quality video material, you may want to set SVM to OFF.

Selecting the color temperature

You can change the quality of the picture by selecting from three preset color temperatures: cool, medium, and warm.

To select the color temperature:

1. Press MENU, and then press ◀ or ▶ until the PICTURE menu appears.
2. Press ▲ or ▼ to highlight COLOR TEMPERATURE.
3. Press ◀ or ▶ to highlight the mode you prefer.

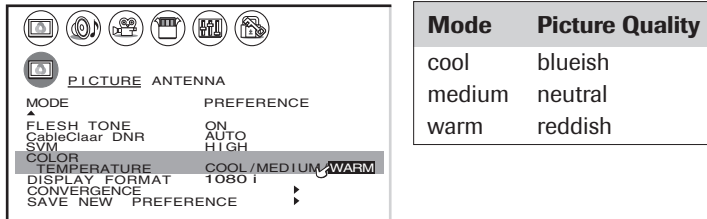

Resetting your picture adjustments

The RESET function adjusts the picture qualities to the following factory settings:

Contrast	max (100)	Color temperature	cool
Brightness	center (50)	CableClear DNR	auto
Color	center (50)	Mode	sports
Tint	center (0)		
Sharpness	center (50)		

To reset the picture adjustments:

1. Press MENU, and then press ◀ or ▶ until the PICTURE menu appears.
2. Press ▲ or ▼ to highlight RESET.
3. Press ◀ or ▶. The menu displays “DONE”.

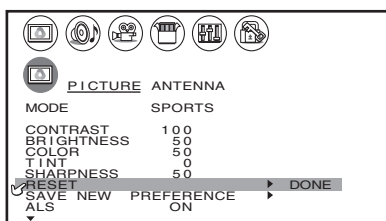

Selecting the display format (for 480p signals only)

You can use this feature to convert a 480p input signal to 540p or 1080i.

To select the display format:

1. Press MENU, and then press ◀ or ▶ until the PICTURE menu appears.
2. Press ▲ or ▼ to highlight DISPLAY FORMAT.
3. Press ◀ or ▶ to select either 540p or 1080i.

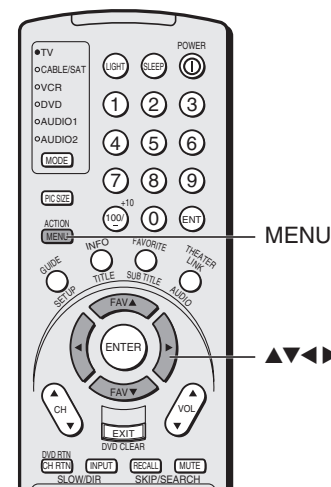
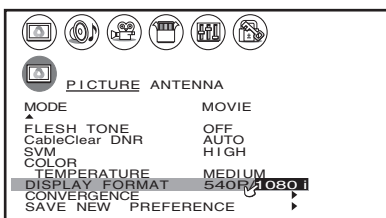

Note:

- Input signals other than 480p are automatically converted to 1080i.
- If you notice flicker in a 480p image, try setting the DISPLAY FORMAT feature to 540p.

Selecting the video input source

Press INPUT on the remote control or TV/VIDEO on the TV to view a signal coming from another device connected to your TV, such as a VCR or video disc player (see illustrations below). You can select ANT 1, VIDEO 1, VIDEO 2, VIDEO 3, ColorStream HD1, ColorStream HD2, DVI, or ANT 2 depending on which input jacks are used for connecting the devices (see “Connecting your TV” on page 8).

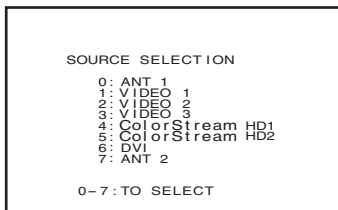

Pressing INPUT on the remote control displays the current signal source (press INPUT again or 0-7 to change)

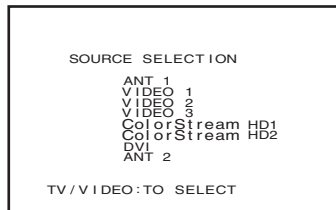

Pressing TV/VIDEO on the TV changes the current signal source

Note:

- When ColorStream HD 1 or HD 2 is selected, the video OUT jack does not output a signal. To receive a video OUT signal, use a standard video or S-video IN connection instead of the ColorStream connection.
- If you select ColorStream HD1 or HD2 while the POP picture is active, the POP window will close.

Please note the following regarding the DVI source selection:

This TV is not intended for connection to and should not be used with a PC (personal computer). See “Connecting a device to the DVI/HDCP input” on page 14 for details.

Labeling the video input sources

The video label feature allows you to label each input source for your TV from the following preset list of labels:

- : Uses the default label name
- VCR : Video cassette recorder
- DVD : DVD video
- DTV : Digital TV set-top box
- SAT : Satellite box
- CBL : Cable box
- HD : DVI/HDCP device (see page 14.)

To label the video input sources:

- Press MENU, and then press ◀ or ▶ until the CUSTOM menu appears.
- Press ▲ or ▼ to highlight VIDEO LABEL.

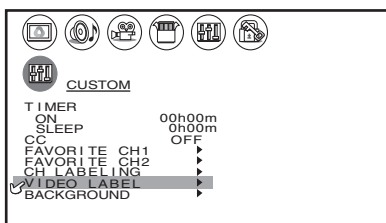

- Press ◀ or ▶ to display the VIDEO LABEL menu.
- Press ▲ or ▼ to highlight the video source you want to label.
- Press ◀ or ▶ to select the desired label for that input source.

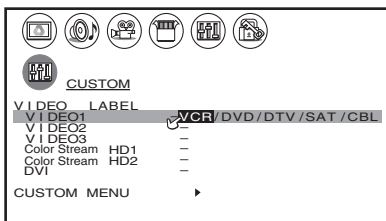

- Finish labeling the other video sources as desired. To return to the previous menu, press ▲ or ▼ to highlight CUSTOM MENU, and then press ◀ or ▶.
- To exit the menu, press EXIT.

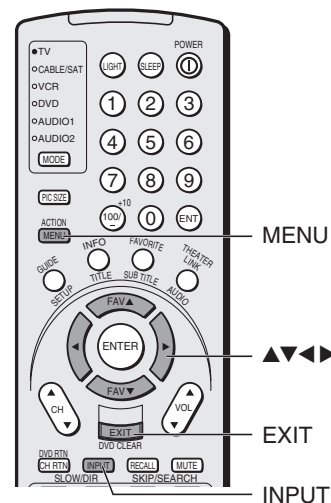
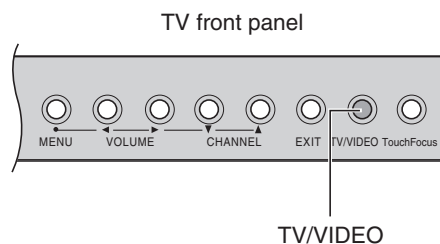

Note:

The HD (high-definition) label is available for DVI mode only (see “Selecting the video input source” above, and “Connecting a device to the DVI/HDCP input” on page 14).

Using the closed caption feature

The closed caption feature has two options:

- Captions—An on-screen display of the dialogue, narration, and sound effects of TV programs and videos that are closed captioned (usually marked as “CC” in TV listings).
- Text—An on-screen display of information not related to the current program, such as weather or stock data (when provided by individual stations).

To view captions or text:

1. Tune the TV to the desired program.
2. Press MENU, and then press ◀ or ▶ to display CUSTOM menu.
3. Press ▲ or ▼ to highlight CC.

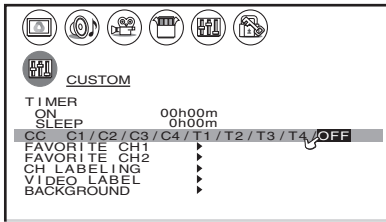

4. Press ◀ or ▶ to highlight the desired closed caption mode, as follows:
 - To view captions, highlight C1, C2, C3, or C4 (C1 displays translation of the primary language in your area).

Note: If the program or video you selected is not closed captioned, no captions will display on the screen.



- To view text, highlight T1, T2, T3, or T4.

Note: If text is not available in your area, a black rectangle may appear on your screen. If this happens, turn the Closed Caption feature OFF.

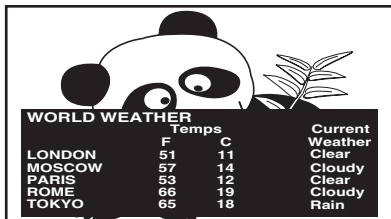

To turn off the Closed Caption feature:
Highlight OFF in step 4.

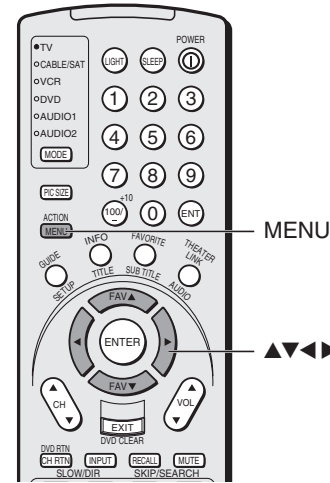

Note:

A closed caption signal may not display in the following situations:

- when a videotape has been dubbed
- when the signal reception is weak
- when the signal reception is nonstandard

Setting the ON timer

To set the ON-timer to turn the TV on automatically:

1. Press MENU, and then press ◀ or ▶ until the CUSTOM menu appears.
2. Press ▲ or ▼ to highlight ON.
3. After the number position starts to blink, press the Number buttons (0-9) to enter the length of time until the TV turns on automatically.
You can set the ON-timer by 10 minutes, up to 12h00m.
4. Press ENTER to start the timer.

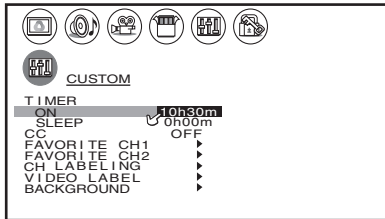

5. Press POWER to turn off the TV.
The TV will turn on automatically after the time you preset.

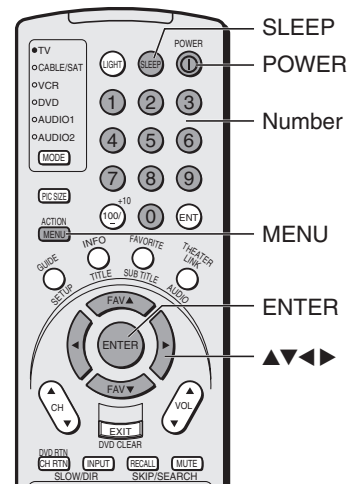

Setting the sleep timer

To set the sleep timer to turn the TV off automatically:

1. Press SLEEP to set the length of time until the TV turns off.

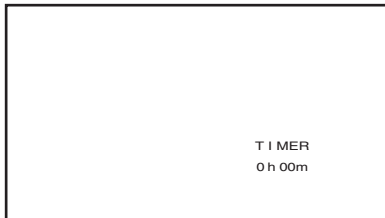

Every time you press the button, the time display will increase by 10 minutes, up to 3 hours.

0h00m → 0h10m → 0h20m → ----- → 2h50m → 3h00m → 0h00m

To cancel the sleep timer:

Press SLEEP until it is set to 0h00m.

The timer can also be set using the on-screen menu:

1. Press MENU, and then press ◀ or ▶ until the CUSTOM menu appears.
2. Press ▲ or ▼ to highlight SLEEP.
3. After the number position starts to blink, press the Number buttons (0-9) to enter the length of time until the TV turns off automatically.
4. Press ENTER to start the timer.

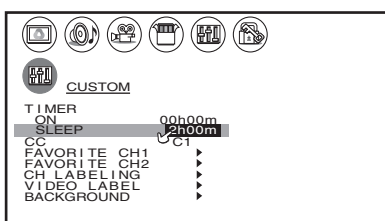

Note:

- When an instant power failure occurs, the ON timer and sleep timer settings may be cleared.
- To display the amount of time left until the TV turns on or off automatically, press RECALL.

Setting the clock

To set the clock:

1. Press MENU, and then press ◀ or ▶ until the SET UP menu appears.
2. Press ▲ or ▼ to highlight CLOCK SET.
3. After the number position starts to blink, press the Number buttons (0-9) to enter the correct time. The clock operates on a 24-hour cycle.
4. Press ENTER to start the clock.

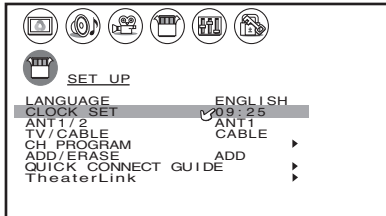

To display the time on-screen:

Press RECALL.

Note :

If the TV's power source is interrupted (the power cord is unplugged or a power failure occurs), the clock must be reset.

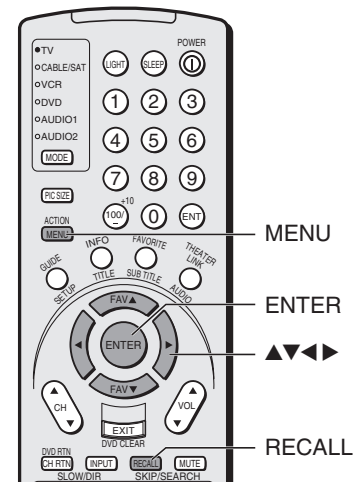

Adjusting the sound

Muting the sound

Press MUTE to temporarily reduce (1/2 MUTE) or turn off (MUTE) the sound. While the sound is off, the screen will display “1/2 MUTE” or “MUTE” in the lower right corner. Every time you press the button, the mute mode will change in the following order.

→ Normal → 1/2 MUTE → MUTE →

When you select “MUTE” mode, the closed caption feature is automatically activated. To deactivate this feature, deactivate MUTE. This feature works only when the closed caption mode is set to OFF. See “Using the closed caption feature” on page 59 for more information.

Selecting stereo/SAP broadcasts

The multi-channel TV sound (MTS) feature allows you to listen to high-fidelity stereo sound while watching TV. MTS can also transmit a second audio program (SAP) containing a second language, music, or other audio information (when provided by individual stations).

When the TV receives a stereo or SAP broadcast, the word STEREO or SAP appears on-screen every time the TV is turned on, the channel is changed, or the RECALL button is pressed.

The MTS feature is not available when the TV is in VIDEO mode.

To listen to stereo sound:

1. Press MENU, and then press ◀ or ▶ until the AUDIO menu appears.
2. Press ▲ or ▼ to highlight MTS.
3. Press ◀ or ▶ to highlight STEREO.

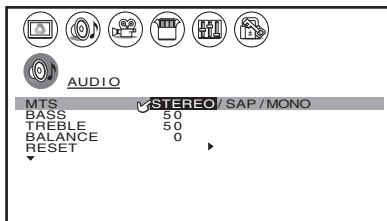

You can leave your TV in STEREO mode because it will automatically output the type of sound being broadcast (stereo or monaural). The word “STEREO” or “SAP” displays in yellow in the menu when the TV receives the signal.

If the stereo sound is noisy, select MONO to reduce the noise.

To listen to SAP (if available):

1. Press MENU, and then press ◀ or ▶ until the AUDIO menu appears.
2. Press ▲ or ▼ to highlight MTS.
3. Press ◀ or ▶ to highlight SAP. You will hear the station's second audio program (if available) from the speakers, while viewing the original program's picture (see note at right).

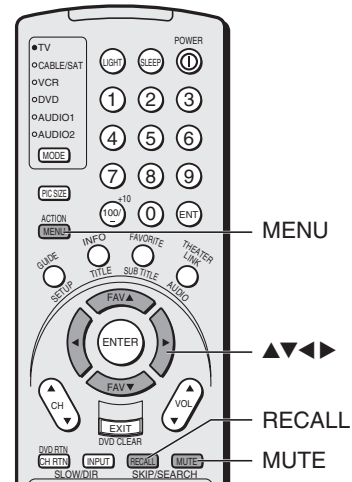

TV front panel

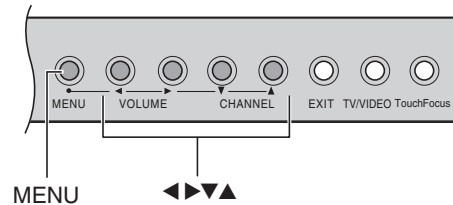

Note :

A second audio program (SAP) can be heard only on those TV stations that offer it.

For example, a station might broadcast music as a second audio program. If you have SAP on, you will see the current program on the screen but hear music instead of the program's normal audio.

If you have SAP on and the station you are watching is not broadcasting a second audio program, the station's normal audio will be output.

However, occasionally there is no sound at all in this instance.

If this happens, set the MTS feature to STEREO mode.

Using the WOW™ surround sound feature

WOW is a special combination of SRS audio technologies that creates a thrilling surround sound experience with deep, rich bass from mono or stereo sound sources. Your audio will sound fuller, richer, and wider.

To adjust the WOW feature:

1. Select STEREO mode (See “Selecting stereo/SAP broadcasts” on page 62).
2. Press MENU, and then press ◀ or ▶ until the THEATER menu appears.
3. Press ▲ or ▼ to highlight the desired WOW feature you want to adjust, then press ◀ or ▶ to adjust the item.

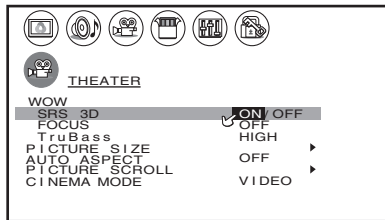

- SRS 3D — To turn on or off the surround sound effect.
- FOCUS — To turn on or off the vocal emphasis effect.
- TruBass — To select the desired bass expansion level (HIGH, LOW, or OFF).

Adjusting the sound quality

You can change the quality of your TV's sound by adjusting the bass, treble, and balance.

To adjust the sound quality:

1. Press MENU, and then press ◀ or ▶ until the AUDIO menu appears.
2. Press ▲ or ▼ to highlight the item you want to adjust.

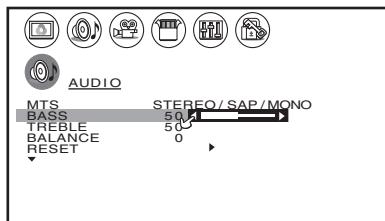

3. Press ◀ or ▶ to adjust the level.
 - ◀ makes the sound quality weaker or decreases the balance in the right channel, depending on the item selected.
 - ▶ makes the sound quality stronger or decreases the balance in the left channel, depending on the item selected.

Note:

If the broadcast is monaural, the SRS 3D effect does not work.

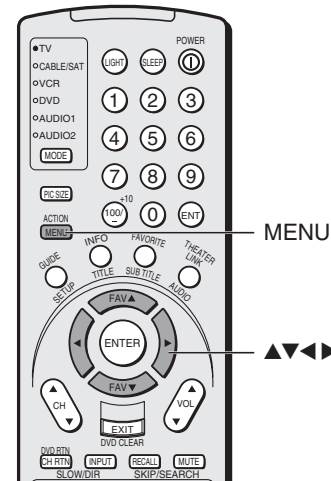

Resetting your audio adjustments

The RESET function returns the audio adjustments to the following factory settings:

- Bass center (50)
- Treble center (50)
- Balance center (0)

To reset the audio adjustments:

1. Press MENU, and then press ◀ or ▶ until the AUDIO menu appears.
2. Press ▲ or ▼ to highlight RESET.
3. Press ◀ or ▶. The menu displays “DONE”.

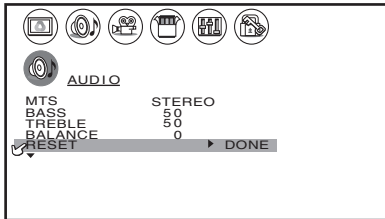

Using the sub-bass system (SBS)

The sub-bass system allows you to enhance bass performance, even when the sound volume is low.

To turn on the SBS:

1. Press MENU, and then press ◀ or ▶ until the AUDIO menu appears.
2. Press ▲ or ▼ to highlight SBS.
3. Press ◀ or ▶ to highlight ON.

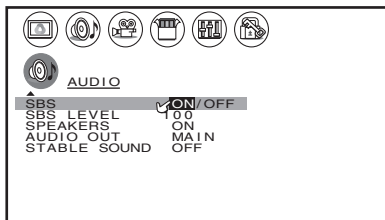

To adjust the SBS level:

4. Press ▲ or ▼ to highlight SBS LEVEL.
5. Press ◀ or ▶ to adjust the SBS level.

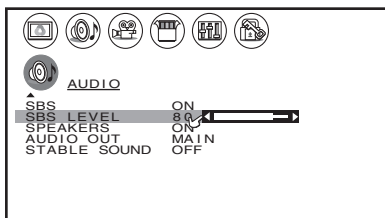

To turn off the SBS:

Highlight OFF in step 3 above.

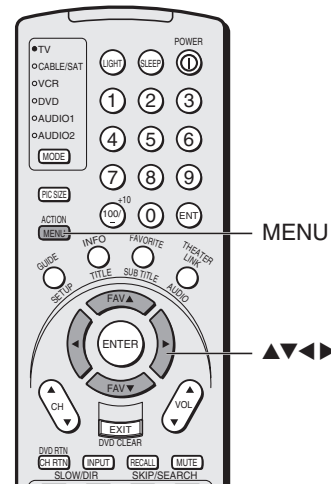

Note:

While in the SBS OFF mode, if the SBS level is adjusted, the SBS is automatically set ON.

Turning off the built-in speakers

Use this feature to turn the TV speakers off when you connect an audio system (See “Connecting an audio system” on page 16).

To turn off the built-in speakers:

1. Press MENU, then press ◀ or ▶ until AUDIO menu appears.
2. Press ▲ or ▼ to highlight SPEAKERS.
3. Press ◀ or ▶ to highlight OFF.



To turn on the built-in speakers:

Highlight ON in step 3 above.

Selecting the Audio OUT sound

This feature allows you to select the sound source (MAIN or POP) that is output from the Audio OUT jacks (See “Connecting two VCRs” on page 13).

This is useful when amplifying or recording the POP sound with external equipment while hearing the sound of the main picture through the built-in speakers.

To select the Audio OUT sound:

1. Press MENU, and then press ◀ or ▶ until the AUDIO menu appears.
2. Press ▲ or ▼ to highlight AUDIO OUT.
3. Press ◀ or ▶ to select MAIN or POP.

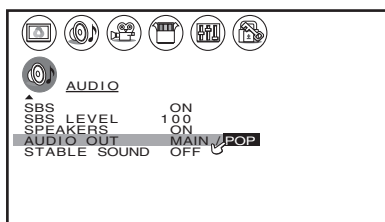

- MAIN: Outputs the sound of the main program to the AUDIO OUT jacks.
- POP: Outputs the sound of the POP program to the AUDIO OUT jacks.

Note:

Make sure the volume control of your audio amplifier is set to a moderate listening level.

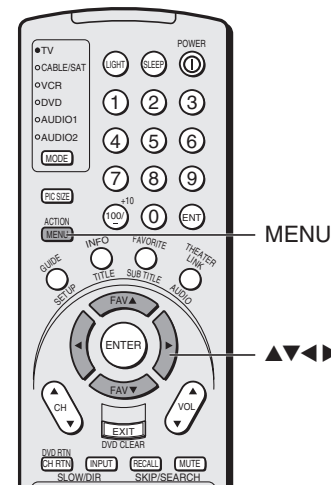

Note:

- When the POP window is open, the sound of the main program is output through the AUDIO OUT jacks, even if POP is selected in the AUDIO OUT menu.
- The sound of the main program is always output through the TV speakers, regardless of the AUDIO OUT setting.

Using the StableSound® feature

When the signal source is changed, the StableSound® feature limits the highest volume level to prevent extreme changes in volume (for example, to prevent the sudden increase in volume that often happens when a TV program switches to a commercial).

To turn on the StableSound® feature:

1. Press MENU, and then press ◀ or ▶ until the AUDIO menu appears.
2. Press ▲ or ▼ to highlight STABLE SOUND.
3. Press ◀ or ▶ to select ON.

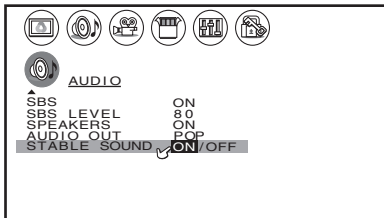

To turn off the StableSound feature:

Highlight OFF in step 3 above.

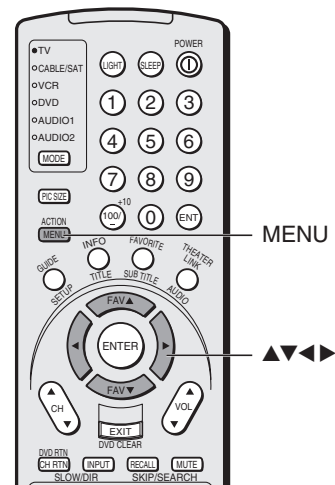

Selecting the background of the menu display

You can change the background of the menu display by selecting from two preset types: shaded and solid (gray).

To select the background:

1. Press MENU, and then press ◀ or ▶ until the CUSTOM menu appears.
2. Press ▲ or ▼ to highlight BACKGROUND.
3. Press ◀ or ▶ to select either a SHADED or SOLID background.

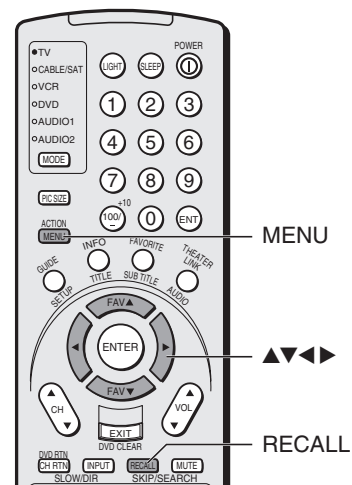
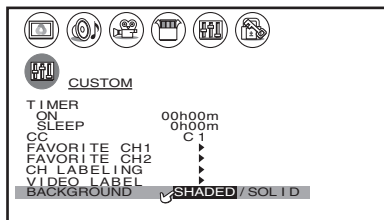

Displaying on-screen information

Press RECALL to display the following information on-screen:

- Antenna mode (when in TV mode)
- Channel number or VIDEO mode selected
- Time (if set)
- Remaining time of ON/SLEEP timer (if set)
- Channel label (if set)
- Stereo or SAP audio status
- V-CHIP rating status
- Picture size

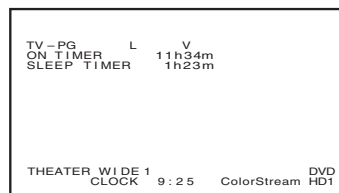
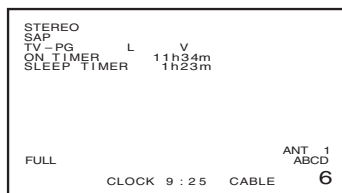

Viewing the demo mode

The demo mode automatically demonstrates several of your TV's features. This function is provided for demonstration purposes only.

To start the demo:

Press and hold MENU on the TV front panel for 4 seconds.

To stop the demo:

Press RECALL, EXIT, or POWER.

Understanding the auto power off feature

The TV will automatically turn itself off after approximately 15 minutes if it is tuned to a vacant channel or a station that completes its broadcast for the day. This feature does not work in VIDEO mode.

Understanding the last mode memory feature

If the power is cut off while you are viewing the TV, the Last Mode Memory feature turns the TV on automatically when the power is resupplied.

If the power is going to be off for a long time and you are going to be away from your TV, unplug the power cord to prevent the TV from turning on in your absence.

Appendix

Specifications

Design and specifications are subject to change without notice.

Television System

NTSC standard

Channel Coverage

VHF: 2 through 13

UHF: 14 through 69

Cable TV: Mid band (A-8 through A-1, A through I)

Super band (J through W)

Hyper band (AA through ZZ, AAA, BBB)

Ultra band (65 through 94, 100 through 125)

Power Source

120 V AC, 60 Hz

Power Consumption

190 W

Audio Power

20 W + 20 W

Speaker Type

Two 6-5/16 inches (16 cm) round

Video/Audio Terminals

S-VIDEO INPUT

Y : 1 V(p-p), 75 ohm, negative sync.

C : 0.286 V(p-p) (burst signal), 75 ohm

VIDEO/AUDIO INPUT

VIDEO: 1 V(p-p), 75 ohm, negative sync.

AUDIO: 150 mV(rms) (30% modulation equivalent, 47 k ohm)

ColorStream® (component video) INPUT

Y : 1V(p-p), 75 ohm

PR: 0.7 V(p-p), 75 ohm

PB: 0.7 V(p-p), 75 ohm

AUDIO: 150 mV(rms), 47 k ohm

VIDEO/AUDIO OUTPUT

VIDEO: 1 V(p-p), 75 ohm, negative sync.

AUDIO: 150 mV(rms) (30% modulation equivalent, 4.7 k ohm)

VARIABLE AUDIO OUTPUT

0–300 mV(rms) (30% modulation equivalent, 4.7 k ohm)

AUDIO CENTER CHANNEL INPUT

300 mV(rms) (30% modulation equivalent, 10 k ohm)

DVI/HDCP INPUT

HDCP compliant

E-EDID* 1.3 compliant

DVI-D uncompressed, high-speed, digital single-link connection

Suggested scan rates: 1080i, 480p, 480i

TheaterLink OUT: 3 V(p-p), 10 k ohm

Dimensions

46HX83: Width 43-3/8 inches (1102 mm)

Height 40-1/2 inches (1029 mm)

Depth 21-7/8 inches (556 mm)

51HX83: Width 47-9/16 inches (1208 mm)

Height 50-1/2 inches (1283 mm)

Depth 22-1/2 inches (572 mm)

57HX83: Width 52-3/4 inches (1340 mm)

Height 55-3/4 inches (1416 mm)

Depth 23-7/8 inches (606 mm)

65HX83: Width 59-7/8 inches (1521 mm)

Height 59-7/8 inches (1521 mm)

Depth 26-1/4 inches (667 mm)

Mass

46HX83: 165 lbs (74.8 kg)

51HX83: 169 lbs (76.6 kg)

57HX83: 204 lbs (92.5 kg)

65HX83: 240 lbs (109 kg)

Supplied Accessories

TheaterLink cable

Remote Control with two size “AA” alkaline batteries

Optional TV stand

46HX83: ST4663

* E-EDID = Enhanced-Extended Display Identification

Troubleshooting

Before calling a service technician, please check the following table for a possible cause of the problem and some solutions.

Problem	Solution
TV will not turn on	<ul style="list-style-type: none"> • Make sure the power cord is plugged in, then press POWER. • The remote control batteries may be dead. Replace the batteries.
No picture, no sound	<ul style="list-style-type: none"> • Check the antenna/cable connections.
No sound, picture OK	<ul style="list-style-type: none"> • The sound may be muted. Press VOLUME. • The station may have broadcast difficulties. Try another channel. • Check that the SPEAKERS function in AUDIO menu is set properly. • Check that the AUDIO CENTER CHANNEL switch is set properly.
Poor picture, sound OK	<ul style="list-style-type: none"> • Check the antenna connections. • The station may have broadcast difficulties. Try another channel. • Adjust the PICTURE menu.
Poor reception of broadcast channels	<ul style="list-style-type: none"> • The station may have broadcast difficulties. Try another channel. • Check the antenna connections. • If you are using a VCR, make sure the TV/VCR button is set correctly.
Cannot receive above channel 13	<ul style="list-style-type: none"> • Make sure the TV/CABLE switch is set to the mode that corresponds with the signal source type (cable company or outside antenna).
Black box appears on the screen	<ul style="list-style-type: none"> • The closed caption feature may be set to one of the Text modes (T1, T2, T3, or T4). Turn closed captioning OFF.
Unable to select a certain channel	<ul style="list-style-type: none"> • The channel may be locked out with the CH LOCK feature, or erased with the ADD/ERASE feature.
Multiple images	<ul style="list-style-type: none"> • The station may have broadcast difficulties. Try another channel. • Antenna reception may be poor. Use a highly directional outdoor antenna.
Poor color or no color	<ul style="list-style-type: none"> • The station may have broadcast difficulties. Try another channel. • Adjust the TINT and/or COLOR in the PICTURE menu.
No stereo or SAP sound from a known MTS broadcast	<ul style="list-style-type: none"> • Make sure the MTS feature is set properly.
The front panel buttons do not operate	<ul style="list-style-type: none"> • Check the FRONT PANEL LOCK feature.
The remote control does not operate	<ul style="list-style-type: none"> • Check whether the appropriate device mode is selected. • Remove all obstructions between the remote control and the remote control sensor in the TV. • The remote control batteries may be dead. Replace the batteries.
Cannot access signal input sources (Video1, Video2, Video3, ColorStream HD1/HD2, DVI/HDCP) and/or Channels 3 and 4.	<ul style="list-style-type: none"> • Check the VIDEO LOCK feature.

Limited United States Warranty

for 27" FST PURE® and All Larger Television Models

Toshiba America Consumer Products, Inc. ("TACP") and Toshiba Hawaii, Inc. ("THI") make the following limited warranties to original consumers in the United States. THESE LIMITED WARRANTIES EXTEND TO THE ORIGINAL CONSUMER PURCHASER OR ANY PERSON RECEIVING THIS TELEVISION AS A GIFT FROM THE ORIGINAL CONSUMER PURCHASER AND TO NO OTHER PURCHASER OR TRANSFEREE.

PRODUCTS PURCHASED IN THE U.S.A. AND USED IN CANADA ARE NOT COVERED BY THESE WARRANTIES.

PRODUCTS PURCHASED IN CANADA AND USED IN THE U.S.A. ARE NOT COVERED BY THESE WARRANTIES.

Limited One (1) Year Warranty on Parts and Labor*

TACP/THI warrant this television and its parts against defects in materials or workmanship for a period of one (1) year after the date of original retail purchase. DURING THIS PERIOD, TACP/THI WILL, AT TACP/THI'S OPTION, REPAIR OR REPLACE A DEFECTIVE PART WITH A NEW OR REFURBISHED PART WITHOUT CHARGE TO YOU FOR PARTS OR LABOR. TACP/THI Authorized Service Station personnel will come to your home when warranty service is required. Depending on the type of repair required, either the service will be performed in your home or the set will be taken to the TACP/THI Authorized Service Station for repair and returned to your home at no cost to you.

Limited Two (2) Year Warranty on Picture Tube*

TACP/THI further warrant the picture tube in this television against defects in materials or workmanship for a period of two (2) years after the date of original retail purchase. DURING THIS PERIOD, TACP/THI WILL, AT TACP/THI'S OPTION, REPAIR OR REPLACE A DEFECTIVE PICTURE TUBE WITH A NEW OR REFURBISHED PICTURE TUBE WITHOUT CHARGE TO YOU, EXCEPT THAT, IF A DEFECTIVE PICTURE TUBE IS REPAIRED OR REPLACED AFTER ONE (1) YEAR FROM THE DATE OF THE ORIGINAL RETAIL PURCHASE, YOU PAY LABOR CHARGES INVOLVED IN THE REPAIR OR REPLACEMENT.

Rental Units

The warranty for rental units begins with the date of first rental or thirty (30) days from the date of shipment to the rental firm, whichever comes first.

*Commercial Units

Televisions sold and used for commercial purposes have a limited ninety (90) day warranty for all parts, labor, and picture tubes.

Owner's Manual and Product Registration Card

Read this owner's manual thoroughly before operating this television. Complete and mail the enclosed product registration card within ten days after you, or the person who has given you this product as a gift, purchased this television. Returning the product registration card will enable TACP/THI to provide you with better customer service and improved product support. Failure to return the product registration card will not affect your rights under this warranty.

Your Responsibility

THE ABOVE WARRANTIES ARE SUBJECT TO THE FOLLOWING CONDITIONS:

- (1) You must provide your bill of sale or other proof of purchase.
- (2) All warranty servicing of this television must be made by an Authorized TACP/THI Service Station.
- (3) The warranties from TACP and THI are effective only if the television is purchased and operated in the U.S.A. or Puerto Rico.
- (4) Labor service charges for set installation, setup, adjustment of customer controls, and installation or repair of antenna

systems are not covered by these warranties. Reception problems caused by inadequate antenna systems are your responsibility.

- (5) Warranties extend only to defects in materials or workmanship as limited above and do not extend to any television or parts that have been lost or discarded by you or to damage to television or parts caused by misuse, accident, Acts of God (such as lightning or fluctuations in electric power), improper installation, improper maintenance, or use in violation of instructions furnished by TACP/THI; or to units that have been modified or had the serial number removed, altered, defaced, or rendered illegible.

How to Obtain Warranty Services

If, after following all of the operating instructions in this manual and checking the "Troubleshooting" section, you find that service is needed:

- (1) To find the nearest TACP/THI Authorized Service Station:

For televisions purchased in the United States, except Hawaii, visit TACP's web site at www.toshiba.com/tacp, or call toll free 1-800-631-3811.

For televisions purchased in Hawaii, contact Toshiba Hawaii, Inc., 327 Kamakee Street, Honolulu, HI 96814, (808) 591-9281.

- (2) Present your bill of sale or other proof of purchase to the Authorized Service Station. Authorized TACP/THI Service Station personnel will come to your home when warranty service is required. Depending on the type of repair required, either the service will be performed in your home or the set will be taken to the Authorized Service Station for repair and returned to your home at no cost to you.

**For additional information, visit TACP's web site:
www.toshiba.com/tacp.**

ALL WARRANTIES IMPLIED BY THE LAW OF ANY STATE OF THE U.S.A., INCLUDING THE IMPLIED WARRANTIES OF MERCHANTABILITY AND FITNESS FOR A PARTICULAR PURPOSE, ARE EXPRESSLY LIMITED TO THE DURATION OF THE LIMITED WARRANTIES SET FORTH ABOVE. WITH THE EXCEPTION OF ANY WARRANTIES IMPLIED BY THE LAW OF ANY STATE OF THE U.S.A. AS HEREBY LIMITED, THE FOREGOING WARRANTY IS EXCLUSIVE AND IN LIEU OF ALL OTHER WARRANTIES, GUARANTEES, AGREEMENTS, AND SIMILAR OBLIGATIONS OF TACP OR THI WITH RESPECT TO THE REPAIR OR REPLACEMENT OF ANY PARTS. IN NO EVENT SHALL TACP OR THI BE LIABLE FOR CONSEQUENTIAL OR INCIDENTAL DAMAGES.

No person, agent, distributor, dealer, or company is authorized to change, modify, or extend the terms of these warranties in any manner whatsoever. The time within which action must be commenced to enforce any obligation of TACP or THI arising under this warranty or under any law of the United States or of any state thereof is hereby limited to 90 days from the date you discover, or should have discovered, the defect. This limitation does not apply to implied warranties arising under the law of any state of the U.S.A.

THIS WARRANTY GIVES YOU SPECIFIC LEGAL RIGHTS, AND YOU MAY ALSO HAVE OTHER RIGHTS, WHICH MAY VARY FROM STATE TO STATE IN THE U.S.A. SOME STATES OF THE U.S.A. DO NOT ALLOW LIMITATIONS ON THE DURATION OF AN IMPLIED WARRANTY, LIMITATIONS ON THE TIME WITHIN WHICH AN ACTION MAY BE BROUGHT, OR THE EXCLUSION OR LIMITATION OF INCIDENTAL OR CONSEQUENTIAL DAMAGES; THEREFORE, THE ABOVE LIMITATIONS OR EXCLUSIONS MAY NOT APPLY TO YOU UNDER SUCH CIRCUMSTANCES.

FST PURE® is a registered trademark of Toshiba America Consumer Products, Inc.
REV. MAR02

Limited Canada Warranty

for 27" FST PURE® and All Larger Television Models

Toshiba of Canada Limited ("TCL") makes the following limited warranties to original consumers in Canada.

THESE LIMITED WARRANTIES EXTEND TO THE ORIGINAL CONSUMER PURCHASER OR ANY PERSON RECEIVING THIS TELEVISION AS A GIFT FROM THE ORIGINAL CONSUMER PURCHASER AND TO NO OTHER PURCHASER OR TRANSFEREE.

PRODUCTS PURCHASED IN THE U.S.A. AND USED IN CANADA ARE NOT COVERED BY THESE WARRANTIES.

PRODUCTS PURCHASED IN CANADA AND USED IN THE U.S.A. ARE NOT COVERED BY THESE WARRANTIES.

Limited One (1) Year Warranty on Parts and Labor*

TCL warrants this television and its parts against defects in materials or workmanship for a period of one (1) year after the date of original retail purchase. DURING THIS PERIOD, TCL WILL, AT TCL'S OPTION, REPAIR OR REPLACE A DEFECTIVE PART WITH A NEW OR REFURBISHED PART WITHOUT CHARGE TO YOU FOR PARTS OR LABOR. TCL Authorized Service Depot personnel will come to your home when warranty service is required. Depending on the type of repair required, either the service will be performed in your home or the set will be taken to the TCL Authorized Service Depot for repair and returned to your home at no cost to you. IN-HOME SERVICE ONLY APPLIES WITHIN 100 KILOMETERS OF AN AUTHORIZED TCL SERVICE DEPOT.

Limited Two (2) Year Warranty on Picture Tube*

TCL further warrants the picture tube in this television against defects in materials or workmanship for a period of two (2) years after the date of original retail purchase. DURING THIS PERIOD, TCL WILL, AT TCL'S OPTION, REPAIR OR REPLACE A DEFECTIVE PICTURE TUBE WITH A NEW OR REFURBISHED PICTURE TUBE WITHOUT CHARGE TO YOU, EXCEPT THAT, IF A DEFECTIVE PICTURE TUBE IS REPAIRED OR REPLACED AFTER ONE (1) YEAR FROM THE DATE OF THE ORIGINAL RETAIL PURCHASE, YOU PAY LABOR CHARGES INVOLVED IN THE REPAIR OR REPLACEMENT.

Rental Units

The warranty for rental units begins with the date of first rental or thirty (30) days from the date of shipment to the rental firm, whichever comes first.

*Commercial Units

Televisions sold and used for commercial purposes have a limited ninety (90) day warranty for all parts, labor, and picture tubes.

Owner's Manual

Read this owner's manual thoroughly before operating this television.

Your Responsibility

THE ABOVE WARRANTIES ARE SUBJECT TO THE FOLLOWING CONDITIONS:

- (1) You must provide your bill of sale or other proof of purchase.
- (2) All warranty servicing of this television must be made by an Authorized TCL Service Depot.
- (3) The warranties from TCL are effective only if the television is purchased in Canada from an authorized TCL dealer and operated in Canada.
- (4) Labor service charges for set installation, setup, adjustment of customer controls, and installation or repair of antenna systems are not covered by these warranties. Reception problems caused by inadequate antenna systems are your responsibility.

- (5) Warranties extend only to defects in materials or workmanship as limited above and do not extend to any television or parts that have been lost or discarded by you or to damage to television or parts caused by misuse, accident, Acts of God (such as lightning or fluctuations in electric power), improper installation, improper maintenance, or use in violation of instructions furnished by TCL; or to units that have been modified or had the serial number removed, altered, defaced, or rendered illegible.

How to Obtain Warranty Services

If, after following all of the operating instructions in this manual and checking the "Troubleshooting" section, you find that service is needed:

- (1) To find the nearest TCL Authorized Service Depot, visit TCL's web site: www.toshiba.ca.
- (2) Present your bill of sale or other proof of purchase to the Authorized Service Depot. Authorized TCL Service Depot personnel will come to your home when warranty service is required. Depending on the type of repair required, either the service will be performed in your home or the set will be taken to the Authorized Service Depot for repair and returned to your home at no cost to you. IN-HOME SERVICE ONLY APPLIES WITHIN 100 KILOMETERS OF AN AUTHORIZED TCL SERVICE DEPOT.

**For additional information, visit TCL's web site:
www.toshiba.ca**

ALL WARRANTIES IMPLIED BY THE LAW OF ANY PROVINCE OF CANADA, INCLUDING THE IMPLIED WARRANTIES OF MERCHANTABILITY AND FITNESS FOR A PARTICULAR PURPOSE, ARE EXPRESSLY LIMITED TO THE DURATION OF THE LIMITED WARRANTIES SET FORTH ABOVE. WITH THE EXCEPTION OF ANY WARRANTIES IMPLIED BY THE LAW OF ANY PROVINCE OF CANADA AS HEREBY LIMITED, THE FOREGOING WARRANTY IS EXCLUSIVE AND IN LIEU OF ALL OTHER WARRANTIES, GUARANTEES, AGREEMENTS, AND SIMILAR OBLIGATIONS OF TCL WITH RESPECT TO THE REPAIR OR REPLACEMENT OF ANY PARTS. IN NO EVENT SHALL TCL BE LIABLE FOR CONSEQUENTIAL OR INCIDENTAL DAMAGES.

No person, agent, distributor, dealer, or company is authorized to change, modify, or extend the terms of these warranties in any manner whatsoever. The time within which action must be commenced to enforce any obligation of TCL arising under this warranty or under any law of Canada or of any province thereof, is hereby limited to 90 days from the date you discover, or should have discovered, the defect. This limitation does not apply to implied warranties arising under the law of any province of Canada.

THIS WARRANTY GIVES YOU SPECIFIC LEGAL RIGHTS, AND YOU MAY ALSO HAVE OTHER RIGHTS, WHICH MAY VARY FROM PROVINCE TO PROVINCE IN CANADA. SOME PROVINCES OF CANADA DO NOT ALLOW LIMITATIONS ON THE DURATION OF AN IMPLIED WARRANTY, LIMITATIONS ON THE TIME WITHIN WHICH AN ACTION MAY BE BROUGHT, OR THE EXCLUSION OR LIMITATION OF INCIDENTAL OR CONSEQUENTIAL DAMAGES; THEREFORE, THE ABOVE LIMITATIONS OR EXCLUSIONS MAY NOT APPLY TO YOU UNDER SUCH CIRCUMSTANCES.

FST PURE® is a registered trademark of Toshiba America Consumer Products, Inc.
REV. MAR02

Notes

Notes

Notes

Index

A

ALS (Ambient Light Sensor)	55
A/V receiver connection	16
ANT 1/2	27
Antenna cables	8
AUDIO OUT sound, selecting	65
Audio system connection	16
Auto aspect	43
Auto convergence	35
Auto power off	67

B

BACKGROUND selection	66
Back of the TV	7

C

CableClear™ DNR	56
Cable converter box connection	9
Camcorder connection	13
CH ▲▼ buttons	28
CH LABELING	39
CH LOCK	51
CH RTN button	37
CH SCAN button	46
Channel Number buttons	35
Channel programming	
ADD/ERASE	29
Automatic programming	28
TV/CABLE selection	28
Cinema mode	43
Clock, setting	61
Closed caption	59
Color temperature	57
Component video cables	8
Convergence adjustment	35

D

Demonstration mode	67
Display format	57
DNR (Digital Noise Reduction)	56
Double-Window ("POP") feature	44
Double-Window, size adjustment	45
DTV receiver connection	12
DVD connection	10, 11
DVI/HDCP connection	14

F G I

FAV ▲▼ buttons	38
FAVORITE button	47
Favorite channels	37
FOCUS feature	63
Front of the TV	7
Front panel lock	53
Game timer	53
INPUT button	27, 58

L M

Labeling channels	39
Labeling video inputs	58
Language selection	27
Last mode memory	67
Locking channels	51
Locking video inputs	52
Locks menu	48
Menu system	25
MTS feature	62
MUTE button	62

O P

ON-timer	60
----------------	----

Picture adjustments	
COLOR TEMPERATURE	57
FLESH TONE	55
Picture mode	54
Picture quality	54

Picture-out-picture (POP)	
FREEZE button	45
POP CH ▲▼ buttons	44
POP DIRECT CH button	44
SOURCE button	44
SPLIT button	44
SWAP button	45
Picture scroll	42
Picture size selection	40

R

RECALL button	66
Remote control	
Battery installation	17
Device code table	22-23
Functional key chart	18-19
Learning about the buttons	24
Operational feature reset	21
Programming	20
Searching and sampling the code	20
Volume Lock feature	21
RESET	57, 64

S

SAP sound	62
Satellite receiver connection	10
Scrolling the Theater Wide picture	42
Sleep timer	60
Sound quality adjustments	63
SPEAKERS on/off	65
Specifications	68
SpeedSurf	35
SRS 3D	63
StableSound®	66
Stereo sound	62
Sub-bass system (SBS)	64
SurfLock™	37
S-video cables	8
SVM	56

T

TheaterLink, button	31
TheaterLink, connection	15
TheaterLink setup	29
Theater wide picture	41
TouchFocus™	35
Troubleshooting	69
TruBass	63
TV/VIDEO button	27

V

V-CHI P	
BLOCKING OPTION	50
ENABLE BLOCKING	49
MPAA RATING	50
NEW PIN CODE	53
TV RATING	49
Unlocking programs temporarily	51
VCR connection	8-13
Video cables	8
VIDEO LABEL	58
VIDEO LOCK	52

W

Warranty	70, 71
WOW feature	63

TOSHIBA AMERICA CONSUMER PRODUCTS, INC.

HEAD OFFICE: 82 TOTOWA ROAD, WAYNE, NJ 07470, U.S.A.
NATIONAL SERVICE DIVISION: 1420-B TOSHIBA DRIVE, LEBANON, TN 37087, U.S.A.

TOSHIBA HAWAII, INC.

HEAD OFFICE: 327 KAMAKEE STREET, HONOLULU, HI 96814, U.S.A. – TEL: (808) 591-9281

TOSHIBA OF CANADA LTD.

HEAD OFFICE: 191 McNABB STREET, MARKHAM, ONTARIO, L3R 8H2, CANADA – TEL: (905) 470-5400

SERVICE CENTERS:

TORONTO: 191 McNABB STREET, MARKHAM, ONTARIO L3R 8H2, CANADA – TEL: (905) 470-5400

MONTREAL: 1643 NORTH SERVICE RD., TRANS-CANADA HIGHWAY, DORVAL QUEBEC, H9P 1J1, CANADA – TEL: (514) 856-4100

VANCOUVER: 22171 FRASERWOOD WAY, RICHMOND, B.C., V6W 1J5, CANADA – TEL: (604) 303-2500

MANUFACTURED BY

TOSHIBA AMERICA CONSUMER PRODUCTS, INC.

ColorStream and StableSound are registered trademarks of Toshiba America Consumer Products, Inc.
CableClear, TouchFocus, SurfLock and Theaterlink are trademarks of Toshiba America Consumer Products, Inc.

Free Manuals Download Website

<http://myh66.com>

<http://usermanuals.us>

<http://www.somanuals.com>

<http://www.4manuals.cc>

<http://www.manual-lib.com>

<http://www.404manual.com>

<http://www.luxmanual.com>

<http://aubethermostatmanual.com>

Golf course search by state

<http://golfingnear.com>

Email search by domain

<http://emailbydomain.com>

Auto manuals search

<http://auto.somanuals.com>

TV manuals search

<http://tv.somanuals.com>