

# **TOSHIBA**

TOSHIBA Bar Code Printer

## **Printer Driver**

# **Operating Manual**

8th Edition: March 5, 2012

**TOSHIBA TEC CORPORATION**

# Table of Contents

<b>Introduction</b> .....	<b>1</b>
<b>1. General Description</b> .....	<b>2</b>
1.1 Features .....	2
1.2 Applicable printers .....	2
1.3 Notation.....	3
1.4 Screens Used in This Document .....	3
1.5 Trademark and Copyright .....	3
1.6 Operational Conditions .....	4
1.6.1 Operation System .....	4
1.6.2 Hardware.....	4
1.7 Cautions for Installation (IMPORTANT).....	4
<b>2. Installation Procedure</b> .....	<b>14</b>
Preparatory Procedure Common to All Models .....	14
2.1 Preparation for Installation .....	16
2.2 Installation under Windows XP/Server2003 .....	18
2.3 Installation under Windows Vista/Server2008/7/Server2008R2 .....	25
2.4 Installation under Windows 2000 (USB with Plug & Play Enabled) .....	34
2.5 Installation under Windows XP/Server2003 (USB with Plug & Play enabled) .....	37
2.6 Installation under Windows Vista/Server 2008/7/Server2008R2 (USB with Plug & Play Enabled) .....	39
2.7 Installation under Windows 2000 (Parallel interface with Plug & Play Enabled).....	40
2.8 Installation under Windows XP/Server2003 (Parallel interface with Plug & Play Enabled) .....	43
2.9 Installation under Windows Vista/Server2008/7/Server2008R2 (Parallel Interface with Plug & Play Enabled).....	45
2.10 Uninstalling the Printer Driver .....	46
2.10.1 To delete the printer drivers except for V6.5 Build75 and V6.5 Build77 .....	46
2.10.2 To delete the V6.5 Build75 or V6.5 Build77 .....	49
<b>3. Functions</b> .....	<b>50</b>
3.1 Page Setup Tab .....	56
3.1.1 Registering a new stock or editing the existing stock .....	57
3.1.2 Preset.....	59
3.1.3 Advanced Options .....	60
3.2 Graphics Tab .....	63
3.3 Stock Tab.....	64
3.4 Options Tab.....	67
3.4.1 Multiple Part Print Area Settings (B-419 and B-EV4-G only).....	68
3.4.2 Ribbon Adjustments .....	70
3.5 Fonts Tab .....	71
3.5.1 Bar Code Font.....	75
3.6 Tools Tab.....	77
3.7 Designation of Printer Font.....	85
<b>4. System Configuration</b> .....	<b>89</b>
4.1 System Configuration Example .....	90
<b>5. Addition/Deletion of Standard TCP/IP Port</b> .....	<b>92</b>
5.1 Addition .....	93
5.2 Deletion.....	96
<b>6. Appendix</b> .....	<b>97</b>
6.1 How to Enable Bi-directional Communication Support.....	97
6.2 Parameter Setting on the Printer .....	98
6.3 How to Connect the Printer to LAN.....	99

# Introduction

---

Thank you for purchasing the TOSHIBA bar code printer.

This document gives you a general description of the installation, operation, and functions of the TPCL\*-enabled printer driver (BDRV-WBX8-Z31 Version 7.2.4 M-3).

The latest printer driver can be downloaded from TOSHIBA TEC bar code system website at the following URL:

[http://www.toshibatec-ris.com/download\\_overseas/printer/printer\\_driver/](http://www.toshibatec-ris.com/download_overseas/printer/printer_driver/)

\* TPCL: Abbreviation of TEC Printer Control Language

# 1. General Description

## 1.1 Features

This product is a printer driver designed for TOSHIBA bar code printer and used under Windows 2000, Windows XP, Windows Server 2003, Windows Vista, Windows Server 2008, Windows 7 or Windows Server 2008 R2.

**Note:** Windows 2000 is not supported though installation of this product is possible.

- Enables easy printing from Windows applications.
- Enables a use of the bar code printer just like an office-use laser or ink jet printer, even if you do not know bar code printer specific commands.
- Enables easy setup of the label size, sensors, cut operation, and other functions unique to the bar code printer.
- The host PC is connectable to the printer with RS-232C, Parallel, USB or LAN.

**Note:** Usable interface type varies depending on the printer models. For details, please refer to the Owner's Manual of the printer. Bluetooth and IrDA are not supported.

- The bar code printer's built-in fonts can be used as well as Windows TrueType fonts.
- Bar codes and 2D codes can be printed only by registering a desired code as a font in the printer driver.

## 1.2 Applicable printers

B-372	B-372-QP	B-EP2DL-G	B-EP2DL-GH20/GH30/GH40-QM-R
B-415	B-415-GH24/25-QM	B-EP4DL-G	B-EP4DL-GH20/GH30/GH40-QM-R
B-419	B-419-GS10-QQ, B-419-GS12-QP, B-419-GS12-CN	B-EV4-G	B-EV4D-G, B-EV4T-G
B-431	B-431-QP/CN	B-EV4-T	B-EV4D-T, B-EV4T-T
B-452	B-452-TS10-QQ/QQ-US, B-452-TS11-QQ-PAC, B-452-TS12-QP/QP-PAC/CN	B-SA4G	B-SA4TM-GS12-QM-R, B-SA4TP-GS12-QM-R
B-452-R	B-452-TS-R	B-SA4G-CN	B-SA4TM-GS12-CN-R, B-SA4TP-GS12-CN-R
B-452H	B-452-HS12-QQ/QQ-US/QP/CN	B-SA4T	B-SA4TM-TS12-QM-R, B-SA4TP-TS12-QM-R
B-472	B-472-QQ/QQ-US/QP, B-472-GH12-QQ	B-SA4T-CN	B-SA4TM-TS12-CN, B-SA4TP-TS12-CN
B-472-CN	B-472-GH12-CN, B-472-GH14-CN	B-SP2D	B-SP2D-GH20/GH30/GH40-QM/QM-R
B-482	B-482-TS10-QQ/QQ-US/QP	B-SV4	B-SV4D-QM/QM-R/CGE/CGE-R/CN/QQ-US B-SV4T-QM-R
B-492	B-492L/R-TH10-QQ/QP	B-SX4	B-SX4T-GS10-QQ/QQ-US/QP, B-SX4T-GS20-QQ/QQ-US/QP/QM-R
B-572	B-572-QQ/QQ-US/QP	B-SX4-CN	B-SX4T-GS10-CN, B-SX4T-GS20-CN/CN-R
B-672	B-672-QQ/QQ-US/QP	B-SX5	B-SX5T-TS12-QQ/QQ-US/QP, B-SX5T-TS22-QQ/QQ-US/QP/QM-R
B-682	B-682-TS10-QQ/QQ-US/QP	B-SX5-CN	B-SX5T-TS12-CN, B-SX5T-TS22-CN/CN-R
B-852	B-852-TS12-QQ/QQ-US/QP	B-SX6T-R	B-SX6T-TS12-QM-R
B-852-R	B-852-TS22-QQ/QP-R	B-SX8T-R	B-SX8T-TS12-QM-R
B-872	B-872-QQ/QQ-US/QP	CB-416-T3	CB-416-T3-QQ/QQ-US/QP
B-882	B-882-TS10-QQ/QQ-US/QP	CB-426-T3	CB-426-T3-QQ/QQ-US/QP
B-EX4T1-G	B-EX4T1-GS12-QM/CN-R	B-EX4T1-T	B-EX4T1-TS12-QM/CN-R
B-EX4T2-G	B-EX4T2-GS12-QM/CN-R	B-EX4T2-T	B-EX4T2-TS12-QM/CN-R
B-EX4T2-H	B-EX4T2-HS12-QM/CN-R		

## 1.3 Notation

- Names of menus, screens, icons, buttons, tabs, and items are enclosed in square brackets ([ ]).  
For example: Click the [OK] button.
- Wordings shown on the computer monitor and the LCD message display of your printer are enclosed in double quotation marks (“ ”).  
For example: “ON LINE”.
- Titles of the chapters and sections to be referred to are expressed in bold and Italic.  
For example: Please refer to ***Section 1.1 Features***.

## 1.4 Screens Used in This Document

Screens shown in this document are examples used for explaining operations. Unless otherwise specified, an operation system used in this document is Windows XP. Please note that the screens shown may differ depending on your usage environment and conditions.

## 1.5 Trademark and Copyright

Microsoft and Windows are trademarks of Microsoft Corporation in the United States and other countries. Other company and product names may be registered trademarks or trademarks of others. Each company's registered trademarks and trademarks are not marked with TM or ®. This document uses the following abbreviations.

- Microsoft® Windows® 2000 Professional operating system and Microsoft® Windows® 2000 Server operating system: Windows 2000
- Microsoft® Windows® XP Home Edition operating system and Microsoft® Windows® XP Professional operating system: Windows XP
- Microsoft® Windows® Server 2003, Standard Edition operating system, Microsoft® Windows® Server 2003, Enterprise Edition operating system, Windows® Server 2003, Datacenter Edition operating system, Windows® Server 2003, Web Edition operating system, Microsoft® Windows® Server 2003 R2, Standard Edition operating system, Microsoft® Windows® Server 2003 R2, Enterprise Edition operating system, Microsoft® Windows® Server 2003 R2, Datacenter Edition operating system, and Microsoft® Windows® Server 2003 R2, Web Edition operating system: Windows Server 2003
- Microsoft® Windows® Vista Ultimate operating system and Microsoft® Windows® Vista Enterprise operating system and Microsoft® Windows® Vista Business operating system and Microsoft® Windows® Vista Home Premium operating system and Microsoft® Windows® Vista Home Basic operating system: Windows Vista
- Microsoft® Windows® Server 2008, Standard Edition operating system, Microsoft® Windows® Server 2008, Enterprise Edition operating system, Microsoft® Windows® Server 2008, Datacenter Edition operating system and Microsoft® Windows® Web Server 2008 Edition operating system: Windows Server 2008
- Microsoft® Windows® 7 Ultimate operating system and Microsoft® Windows® 7 Enterprise operating system and Microsoft® Windows® 7 Professional operating system and Microsoft® Windows® 7 Home Premium operating system: Windows 7
- Microsoft® Windows® Server 2008 R2, Standard Edition operating system, Microsoft® Windows® Server 2008 R2, Enterprise Edition operating system, Microsoft® Windows® Server 2008 R2, Datacenter Edition operating system and Microsoft® Windows® Web Server 2008 R2 Edition operating system: Windows Server 2008 R2

## 1.6 Operational Conditions

This product can be used under the following system requirements.

### 1.6.1 Operation System

Windows 2000, Windows XP, Windows Server 2003, Windows Vista, Windows Server 2008, Windows 7 (32 bit/64 bit) or Windows Server 2008 R2

- Notes:**
1. 64-bit operating systems except Windows 7 and Windows Server 2008 R2 are not applicable.
  2. Windows 2000 is not supported though installation of this product is possible.

### 1.6.2 Hardware

A DOS/V (IBM AT compatible) machine running the above Windows operation system must be used along with the following mandatory or recommended requirements.

	Requirement	Recommendation
CPU	Intel® Pentium® II 400MHz or greater	Intel® Pentium® III 1GHz or greater
Memory	64MB or more	256MB or more
HDD	10MB or more free size	

## 1.7 Cautions for Installation (IMPORTANT)

Please be sure to read the following cautions before using this product.

- When you are going to install an upgraded version of the TEC printer driver, you must first uninstall the older version in advance. For how to uninstall the printer driver, refer to **Section 2.10 Uninstalling the Printer Driver**.  
Failure to do so may cause unstable printing operations due to the influences of the files and registry related to the old version remaining in the system. Follow the procedure in **Section 2.10 Uninstalling the Printer Driver**, and the files and registry related to the printer driver will be deleted from the system.  
  
**Note:**
  - This printer driver uses common program for the all applicable printer models.
  - Even if the printer model is different, TPCL printer driver of different version cannot be used on the same PC.
  - When installing TPCL printer driver for a new model on the PC in which the TPCL printer driver of different version for another printer model has been already installed, the existing printer driver needs to be deleted.
- When you are asked to select “Network” or “Local” in the Add Printer Wizard during the installation of the printer driver, be sure to choose “Local”. Even when the printer will be used as a network printer, first install the printer driver as a local printer, then specify a network path for the printer port later.

## ■ Specifying a network path for the printer port

1. Right-click the printer icon and select the [Properties]. Select the [Ports] tab in the Properties screen and click the [Add Port] button.

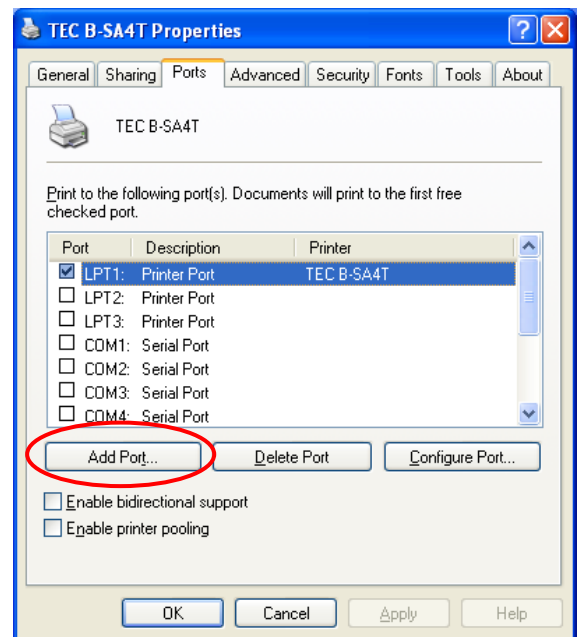

2. Select the "Local Port" and click the [New Port] button.

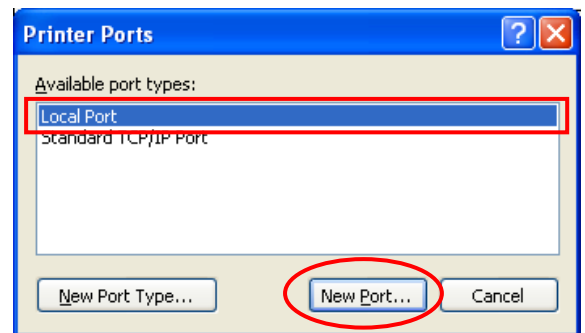

3. Enter a port name.  
Port name: \\Printer server name\<shared name>.

**Note:** The "printer server name" is a computer name to which the shared printer is connected. The "shared name" is the name of the shared printer.

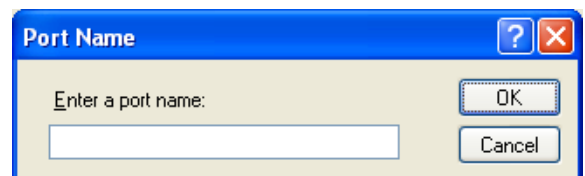

- Be sure to set the [Printer Status Monitoring] as shown in the table below. The status monitor has been disabled as default. Wrong setting disables proper printing.

### ■ Configuration for the Status Monitor

When the [Printer Status Monitoring] is set to other than “Disabled”, it is possible to monitor the printer status from the host computer. When this feature is not supported or is unnecessary, choose the “Disabled” for the [Printer Status Monitoring]. Doing so reduces the load on the printer driver and increases the print efficiency.

O: Any setting X: Disabled

	Interface					
	RS-232C <sup>1</sup> (Serial interface cable)	Parallel (Printer cable) <sup>2</sup> Conforming to IEEE1284 (Compatible/ECP mode)		USB	LAN/WLAN 10BASE-T/100BASE-TX	
Conditions Printer model	—	Other than the right column	CENTRO.MODE=ECP PLUG&PLAY=ON	Ver1.1/2.0	Standard TCP/IP Port(RAW)	Other Port
B-SX6T-R B-SX8T-R	○	X	Not supported	○	○	X
B-EX4T1-G B-EX4T1-T	○	X	Not supported	○	○	X
B-EX4T2-G B-EX4T2-T B-EX4T2-H	○	X	Not supported	○	○	X
B-EV4-G	X	X	Not supported	X	X	X
B-EV4-T	X	X	Not supported	X	X	X
B-EP2DL-G	○	Not supported	Not supported	○	○	X
B-EP4DL-G	Not supported	Not supported	Not supported	○	○	X
B-452-R	○	X	Not supported	○	○	X
B-852-R	○	X	Not supported	○	○	X
B-SA4G, B-SA4G-CN, B-SA4T, B-SA4T-CN	○	X	Not supported	○	○	X
B-SX4, B-SX4-CN B-SX5, B-SX5-CN	○	X	○	○	○	X
B-SV4	○	X	Not supported	○	Not supported	Not supported
B-372	X	X	Not supported	Not supported	X	X
B-472 B-472-CN	X	X	Not supported	Not supported	X	X
B-572	X	X	Not supported	Not supported	Not supported	Not supported
B-672 B-872	X	X	Not supported	Not supported	X	X
B-682 B-882	X	X	Not supported	Not supported	X	X
B-415	X	Not supported	Not supported	Not supported	Not supported	Not supported
B-419	X	Not supported	Not supported	X	Not supported	Not supported
B-431	X	Not supported	Not supported	Not supported	Not supported	Not supported
B-452, B-452H	X	X	Not supported	Not supported	X	X
B-482	X	X	Not supported	Not supported	X	X
B-492	X	X	Not supported	Not supported	X	X
B-852	X	X	Not supported	Not supported	X	X
B-SP2D	X	Not supported	Not supported	Not supported	X	X
CB-416-T3 CB-426-T3	X	X	Not supported	Not supported	Not supported	Not supported

#### Notes:

1. When RS-232C (Serial interface) is used for connection, it will take time until printing starts. It is recommended to use other interfaces as far as possible.



2. Whenever the “CENTRO. MODE” is set to “ECP” in the printer system mode, be sure to set the “PLUG & PLAY” to ON. And, whenever the “CENTRO. MODE” is set to “SPP”, be sure to set the “PLUG & PLAY” to OFF. (The “CENTRO. MODE” and “PLUG & PLAY” have been set to “SPP” and “OFF” as the factory default settings, respectively).

To enable the bi-directional communication, be sure to set the “CENTRO. MODE” to “ECP” and “PLUG & PLAY” to “ON”.

For details of the printer parameter setting, refer to **Section 6.2 Parameter Setting on the Printer**.

- If printing is performed with the status monitor enabled though this feature is not available or not necessary, delete the print job and disable the [Printer Status Monitoring].
- If you start the status monitor by mistake, close the status monitor and disable the [Printer Status Monitoring].
- When the status monitor is used to monitor the printer statuses, do not install more than one printer driver specifying the same output port in one host PC. When more than one printer driver is installed in a PC, disable the [Printer Status Monitoring]. Also, when multiple computers connect to the same printer, specify that printer as the shared printer or disable the [Printer Status Monitoring].

- When using this product for the B-419 printer, select the standard COM port for the output port. Also, place the B-419 printer in the “high speed graphic mode” and configure the port settings as shown below. For how to set the printer mode, refer to the Owner’s Manual of the printer.

Bits/sec.:	38400
Data bit:	8
Parity:	Even
Stop bit:	1
Flow control:	XON/XOFF

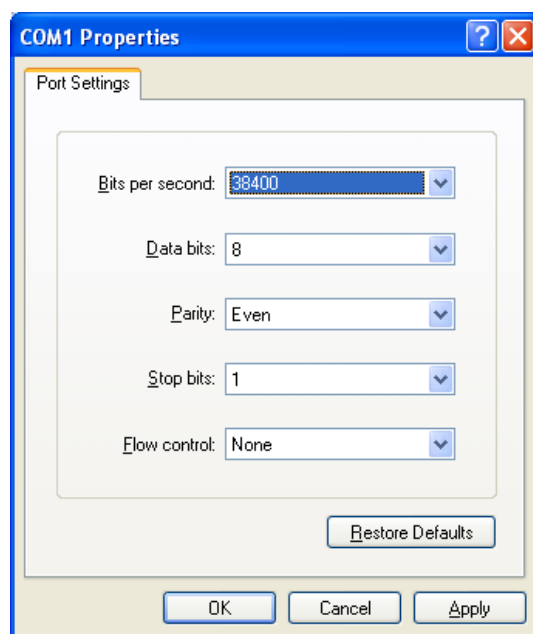

- When Kanji characters are used as bar code font data, click the [Tool] tab – [Configure] button – [Printer Options], and select the “ESC/LF/NUL” for the “Control Codes” of the “Command Protocol”.

- Bar code font types that accept Kanji data: PDF417, MicroPDF417, Data Matrix, Maxicode, QR code
- The default setting of the “Control Codes” is “Standard”. Be sure to change this setting when you print Kanji characters as bar code data, otherwise an error results.

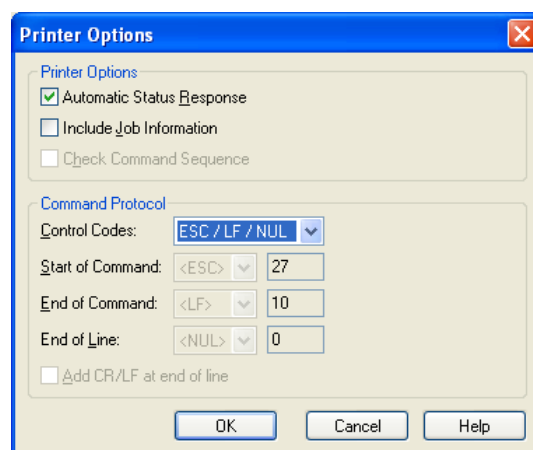

- The default setting of the function character is a caret “^” (5EH). When using bar code fonts like QR code and if you want to specify a function character as bar code data, you need to specify two function characters consecutively. For example, when a caret “^” is used as the function character, enter “^ ^” as bar code data.

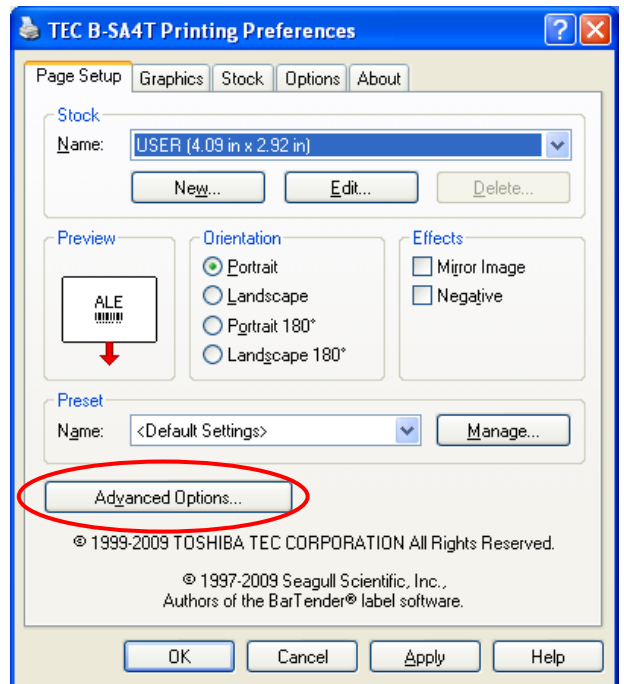

Click the [Page Setup] tab, [Advanced Options] button, and specify the Function Character. This is used when binary data is specified as bar code data.

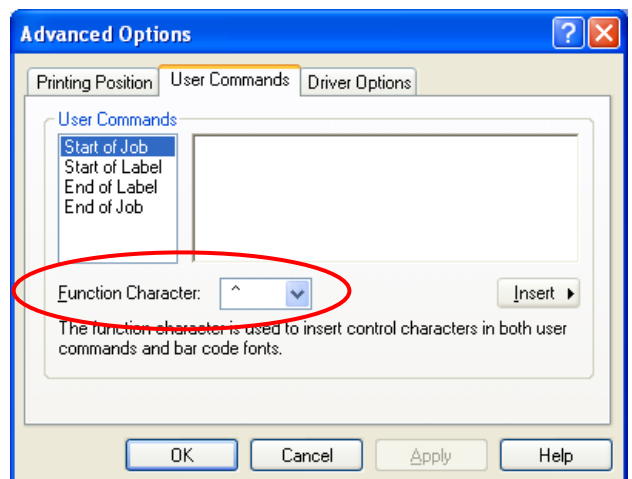

- When installing the printer driver via USB with “Plug & Play” enabled, the messages like “Insert Disk” and “Files Needed” dialog boxes may be displayed. In this case, click the [OK] button in the “Insert Disk” dialog box, and specify the folder (C:\TEC\_DRV) for the “Files Needed” dialog box.

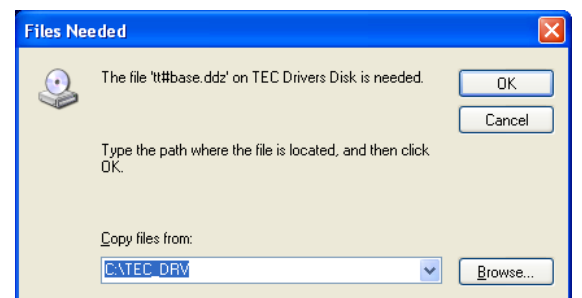
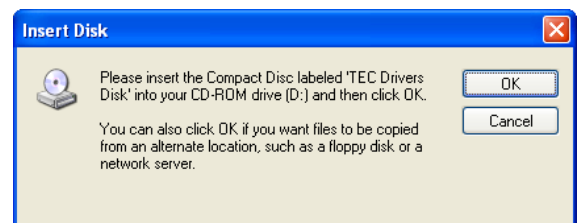

- When using this product for the B-SP2D, B-EP2DL-G or B-EP4DL-G, set the printer mode to “TPCL-LE”, “TPCL-LE1”, “TPCL”, or “TPCL1” by using the Printer Setting Tool or the keys on the printer. For the key operations, refer to the B-EP Series Key Operation Specification.
- When a device font is used, the actual print result looks different from the print preview. Print the label format, and check and adjust the label format.
- RFID fonts are not supported.
- The stock sizes, A4, A5, and A6, shown in this product do not define the paper size in DEVMODE (DMPAPER\_A4, DMPAPER\_A5, and DMPAPER\_A6). They are the stock IDs unique to this product.

The following table shows the stock IDs for the standard stock types registered to the printer driver. When a new stock type is additionally registered, an ID will be assigned in the order of registration, starting from 257. The stock ID can be changed on the Edit Stock screen. Use these IDs when specifying or checking a stock size of dmPaperSize.

Stock name	Stock ID	
	Current	Old
USER	256	256
2x4	32000	257
4x4	32001	258
4x6	32002	259
200x85	32004	260
A4	32005	261
A5	32006	262
A6	32007	263
JAMA L	32010	267
JAMA M	32011	268
JAMA S	32012	269
Form-F	32009	270
Form-A	32008	271
185x85	32003	272
6x4	32013	---
2x2	32014	---

**ATTENTION:**

The IDs for the standard stock types have been totally changed from Version 7.2 M-2, which causes mismatching in the IDs between the older printer driver and the new printer driver. Therefore, when printing is performed from the application which manages the stock types for Excel, Access, etc. by their IDs assigned by the older printer driver version, a wrong stock may be selected.

In this case, change the stock IDs back to the former ones using the following procedure.

- (1) For the user-added stocks, import the settings of the previous printer driver to the new printer driver. (User-added stocks are imported with their original IDs.)
- (2) For the standard stock types, the stock IDs registered to the new printer driver are unchangeable. So, select the standard stock type, click on the [New], and save it as a new stock assigning the former ID listed the table on the left.

The stock list is sorted by ascending order of stock name (Symbol, number, alphabet, Kana, and Kanji), regardless of the stock ID.

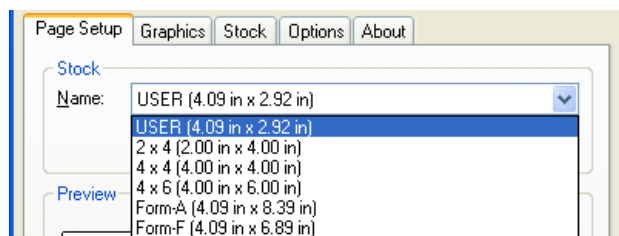

- In the case an export file of the previous version is imported, the preset paper settings may be reset. After importing the preset settings, check the settings.
- When Access2007 is used, some paper names may not be correctly shown. To set the paper names, click the [Page Setup] and open the “Edit Stock” dialog.
- When the LPT or COM port configuration is changed under Windows Vista/Server2008, conduct it with administrative privilege.
- When the port configuration is changed under Windows Vista/Server2008, the dialog box on the right may be displayed. In this case, change the port configuration with administrative privilege.

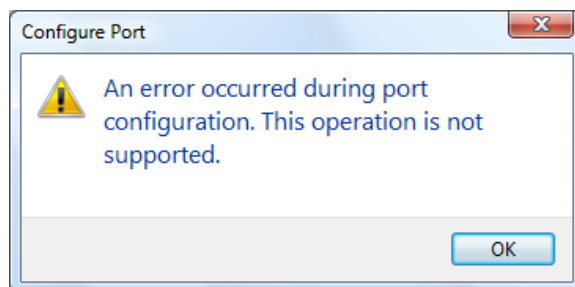

- Bitmap fonts cannot be used for Access. When using Access, remove the check from the “List Bitmap Font” checkbox in the “Font Settings” dialog.

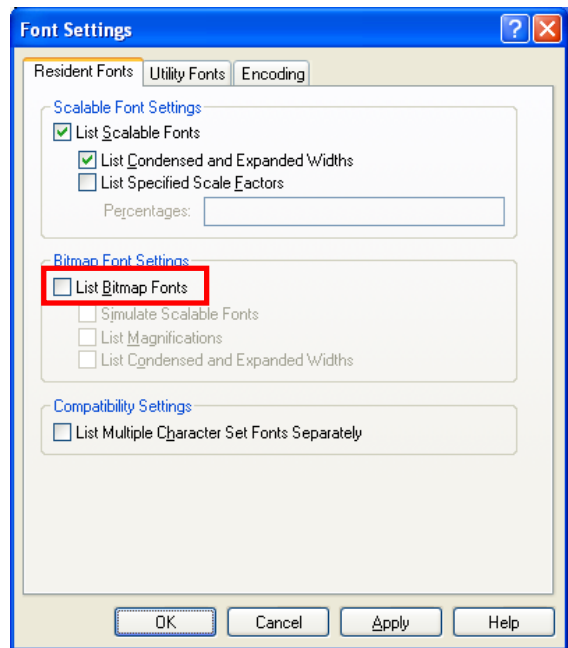

- Do not install other Seagull Scientific printer drivers in the PC where this product has been installed. If you installed any by mistake, uninstall the all printer drivers by the DriverWizard, then reinstall this product only.
- When printing is performed from an application created by Active Reports, open the Properties, click the [Advanced] tab, and remove the check from the “Enable advanced printing features” checkbox.

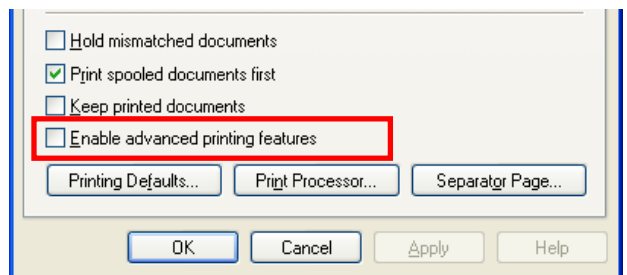

- When data with a large number of digits is encoded into a bar code (or 2D code), and if that bar code cannot be printed within a page width, such data will be invalid.

When you use data with a large number of digits, click the [Fonts] tab, select the bar code font, click the [Font] button and the [Edit], then, check the “Join Multiple Lines” checkbox. When this checkbox is checked, every data specifying the same font will be incorporated into one bar code. If you want to print more than one bar code of the same font with this feature enabled, register required number of bar code fonts.

Example: When you want to print three Code128 symbols in a page with the “Join Multiple Lines” enabled, register three Code128 bar code fonts and specify one to one:

- Barfont Code128-1
- Barfont Code128-2
- Barfont Code128-3

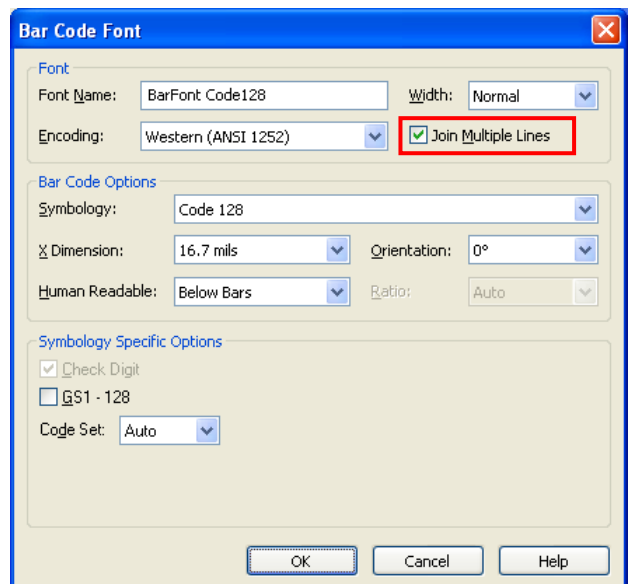

- If data including a space at the beginning or at the end is printed in bar code font, such space is deleted from the data. Multiple data with the same Y-coordinate and same bar code font specified are all connected. To avoid this, click the [Fonts] tab and [Tools] button, select the “Font Settings”, click the [Utility Fonts] tab, then remove the check from the “Combine Adjacent Bar Code & RFID Fields” checkbox.

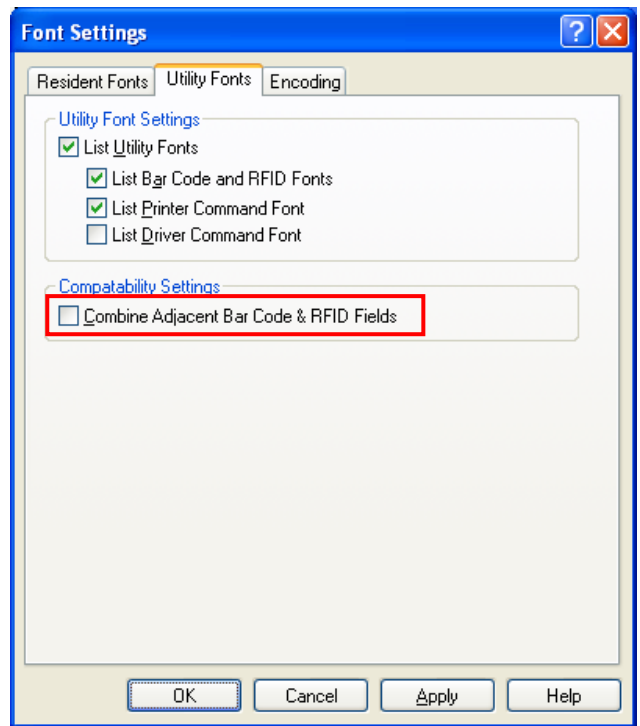

- In the case more than one print job is continuously printed, these jobs may not be printed in the order displayed in the print queue. To avoid this, check the checkbox of “Print spooled documents first.”

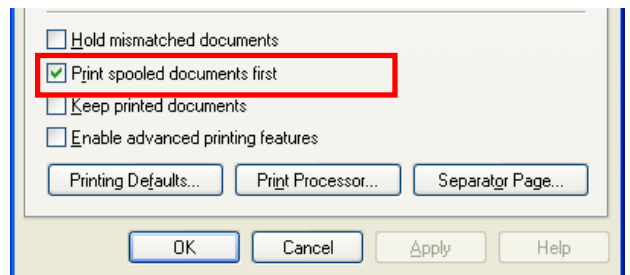

- When the OS is Windows Vista or Windows7, changing the printer name with “Enable bi-directional support” unchecked may cause the setup information to be non-editable. In this case, check the “Enable bidirectional support” checkbox and click the [OK] button. Then, open the same screen again and remove the check from the “Enable bidirectional support” checkbox. It is possible to save the setup information by temporarily enabling the bi-directional support after changing the printer name.

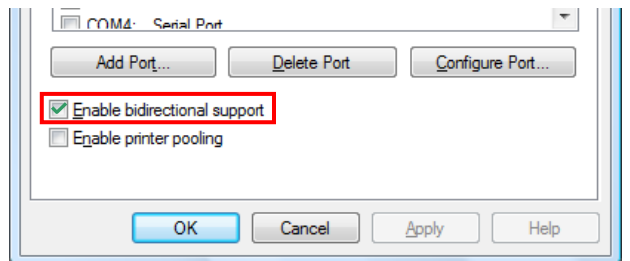

## ■ How to open the Properties with the administrative privilege

To change some of the settings under Windows Vista/Server2008, the administrative privilege is necessary. Right-click the printer icon, select the “Run as administrator “, and click the “Properties”.

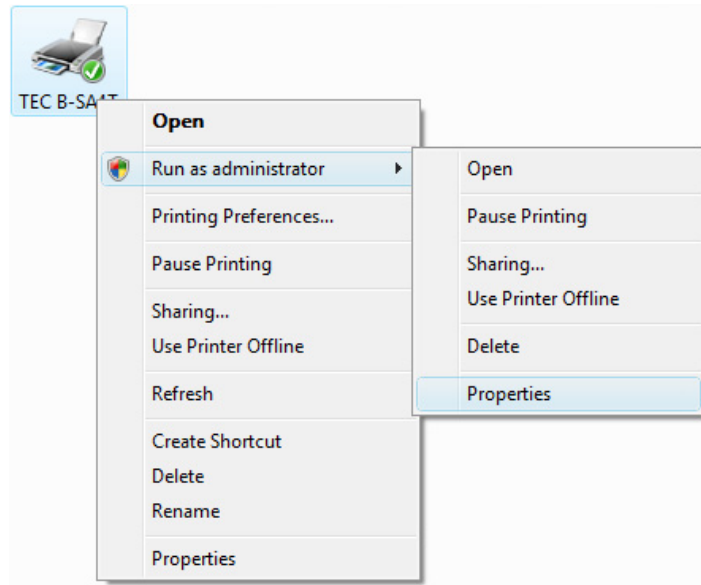

**Note:** The “User account control” dialog box may be displayed. In that case, click the [Allow].

## ■ How to set up Windows Vista/Server2008/7/Server2008R2 again

If you uninstall the printer driver, set up the Windows again. This should be also conducted when the installation does not succeed.

1. Select the “Start”, “All programs”, “TOSHIBA TEC”, “TPCL Printer Driver”, and “TECDRVIN”.

**Note:** Log on as the user with administrative privilege.  
The “User account control” dialog may be displayed. In that case, click the [Allow].

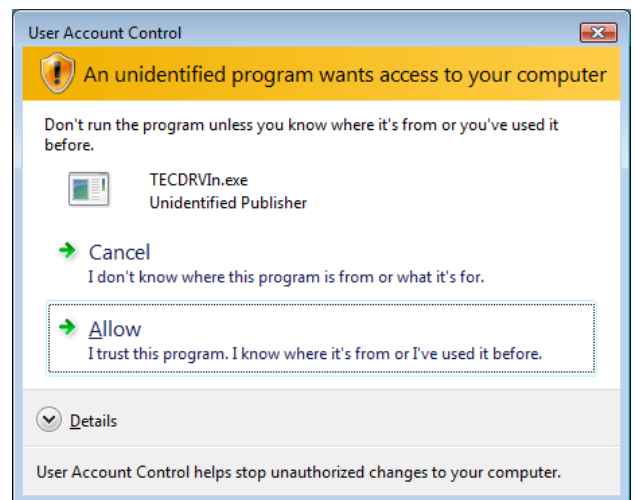

2. When the screen on the right appears, click the “Install this driver software anyway”.

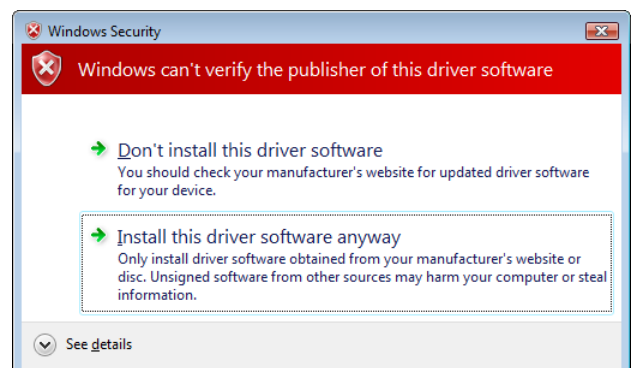

■ **If plug-and-play installation fails under Windows Vista/Server2008/7/Server2008R2**

If an undefined device is created after a plug-and-play installation, follow the procedure below.

1. Select the “Start”, “All programs”, “TOSHIBA TEC”, “TPCL Printer Driver”, and “PnP recovery”.

**Note:** Log on as the user with administrative privilege.  
The “User account control” dialog may be displayed. In that case, click the [Allow].

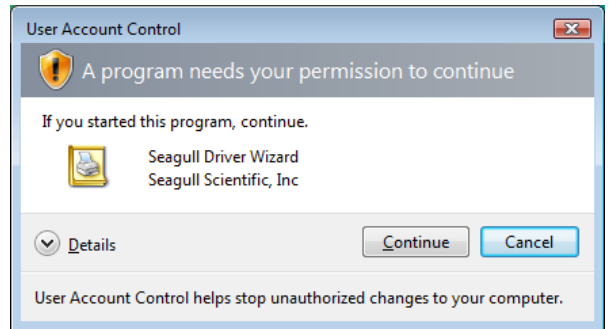

2. When the screen on the right appears, click the “Install this driver software anyway”.

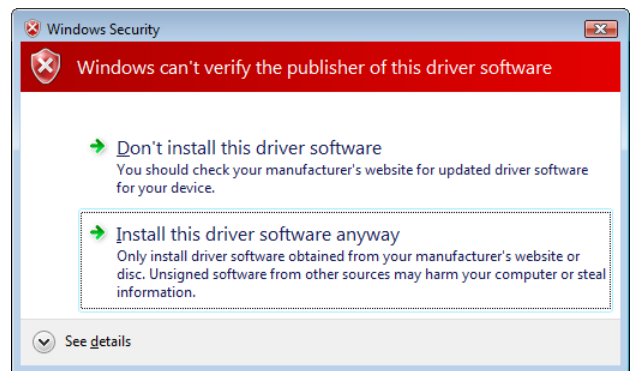

## 2. Installation Procedure

The installation procedure of this printer driver differs depending on the printer models and the connection methods. Follow the procedure for the appropriate condition to install the printer driver.

If the older version of this printer driver has been already installed, be sure to uninstall it first, restart the printer, and install the latest printer driver.

☞ **Section 2.10 Uninstalling the Printer Driver.**

### Preparatory Procedure Common to All Models

Before installing the printer driver, refer to **Section 2.1 Preparation for Installation** and follow the instructions.

#### ■ Printer driver installation method

○: Connectable X: Not connectable

Printer model	Connection method				
	Plug and Play is not used.			Plug and Play is used.	
	RS232C	LAN	Parallel	USB	Parallel
B-372	○	○	○	X	X
B-472, B-472-CN	○	○	○	X	X
B-572	○	○	○	X	X
B-672/B-682	○	○	○	X	X
B-872/B-882	○	○	○	X	X
B-415	○	X	X	X	X
B-419	○	X	X	○	X
B-431	○	○	○	X	X
B-452	○	○	○	X	X
B-452H	○	○	○	X	X
B-482	○	○	○	X	X
B-492	○	○	○	X	X
B-852	○	○	○	X	X
B-SX8T-R	○	○	○	○	○
B-SX6T-R	○	○	○	○	○
B-SV4	○	○	○	○	X
B-EV4-G, B-EV4-T	○	○	○	○	X
B-SP2D	○	○	X	X	X
B-EP2DL-G	○	○	X	○	X
B-EP4DL-G	○	○	X	○	X
B-452-R	○	○	○	○	○
B-852-R	○	○	○	○	○
B-SA4G, B-SA4G-CN, B-SA4T, B-SA4T-CN	○	○	○	○	○
B-SX4, B-SX4-CN	○	○	○	○	○
B-SX5, B-SX5-CN	○	○	○	○	○
B-EX4T1-G, B-EX4T1-T	○	○	○	○	○
B-EX4T2-GS12/TS12/HS12	○	○	○	○	○
CB-416-T3	○	X	○	X	X
CB-426-T3	○	X	○	X	X

**Note:** The above table does not show the all interface types that each printer supports.

Check that your actual connection method is ○ (connectable), refer to the **Installation method by operating systems** on the following page, and follow the appropriate installation procedure.



■ Installation method by operating systems

OS	Connection method				
	Plug and Play is not used.			Plug and Play is used.	
	RS-232C	LAN	Parallel	USB	
Windows 2000	<b>Section 2.2 Install under Windows 2000/XP/Server2003</b>			<b>Section 2.4 Install under Windows 2000 (USB interface with plug and play enabled)</b>	<b>Section 2.7 Install under Windows 2000 (Parallel interface with plug and play enabled)</b>
Windows XP				<b>Section 2.5 Install under Windows XP/Server2003 (USB interface with plug and play enabled.)</b>	<b>Section 2.8 Install under Windows XP/Server2003 (Parallel interface with plug and play enabled)</b>
Windows Server 2003					
Windows Vista	<b>Section 2.3 Install under Windows Vista/Server2008/7</b>			<b>Section 2.6 Install under Windows Vista/Server2008/7 (USB connection with plug and play enabled)</b>	<b>Section 2.9 Install under Windows Vista/Server2008/7 (Parallel interface with plug and play enabled)</b>
Windows Server 2008					
Windows 7					
Windows Server 2008 R2					

\*1: If you choose the parallel interface with plug and play enabled, you need to change some parameter settings on the printer. The “plug and play” feature has been disabled as default for the parallel interface connection. See the following.

In the case installing a shared printer, follow the procedure described in “To print on the shared printer” in **Section 2.2 Installation under Windows 2000/XP/Server2003** and **Section 2.3 Installation under Windows Vista/Server2008/7/Server2008R2**. When you want to use Plug and Play, follow the above procedure.

- Printer parameter settings when installing the printer driver via parallel interface with plug and play enabled:

**B-SX4, B-SX4-CN, B-SX5, and B-SX5-CN**

Start the printer in the system mode, enter the <2>PARAMETER SET menu, and set the following parameters as below:

CENTRO. MODE: .....ECP (Default: SPP) Enables an installation of the printer driver with plug and play

PLUG & PLAY: ON (Default: OFF) .....Enables monitoring the printer status. (☞ **Status Window Preferences in Section 3.6 Tools Tab.**)

When you use the bi-directional communication, set the CENTRO. MODE to ECP and PLUG & PLAY to ON, respectively. The parameter setting procedure is provided in **Section 6.2 Parameter Setting on the Printer**.

**B-SA4G, B-SA4G-CN, B-SA4T, B-SA4T-CN, B-852-R, B-452-R, B-SX6T-R, and B-SX8T-R**

Start the printer in the system mode, enter <2>PARAMETER SET menu, and set the following parameter:

PLUG & PLAY: ON (Default: OFF).....Enables an installation of the printer driver with plug and play

Since the printer status monitor cannot be used, disable the “Bi-directional support” in the Properties of the printer driver.

## 2.1 Preparation for Installation

1. Access Toshiba TEC web site at the following address and download the printer driver install file “TPCL-drv\_7.2.4\_M-3\_E.exe” to the local disc.

[http://www.toshibatec-ris.com/download\\_overseas/printer/printer\\_driver/](http://www.toshibatec-ris.com/download_overseas/printer/printer_driver/)

**Note:** If you do not agree with the Software License Agreement, you cannot download the file.

2. Double-click the downloaded “TPCL-drv\_7.2.4\_M-3\_E.exe”, and the “TPCL PRINTER DRIVER – Installshield Wizard” is displayed. Click the [Next] button.  
**Note:** Log on as the user with administrative privilege. When the User Account Control screen is displayed under Windows Vista/Server2008/7/Server2008R2, click on the “Allow”.

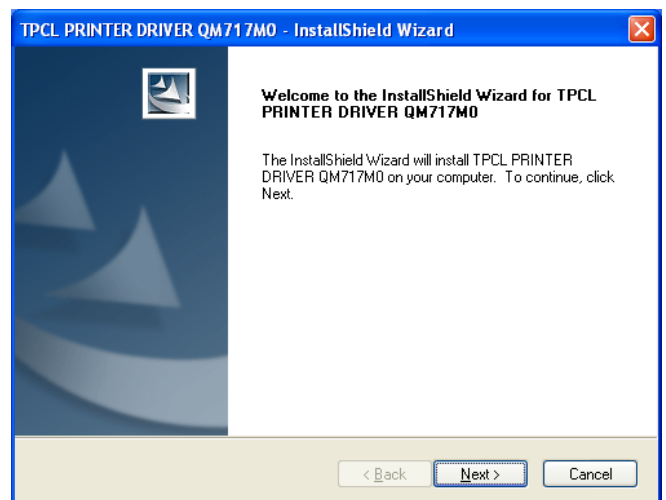
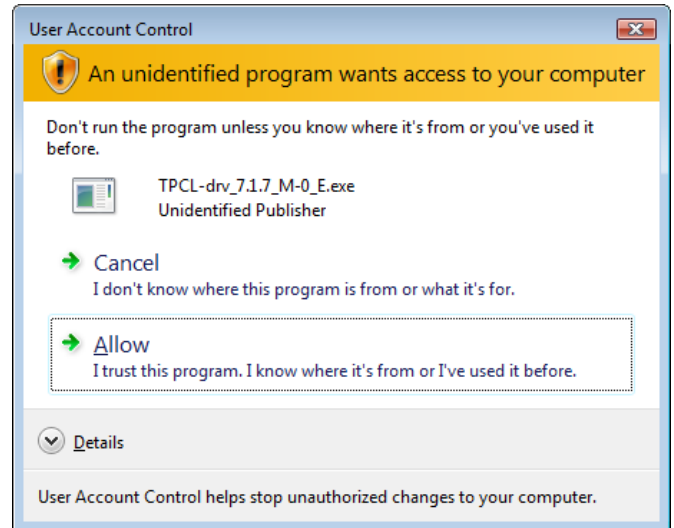

3. The “Software License Agreement” is displayed. Select “I accept the terms of the license agreement” and click the [Next] button.  
**Note:** If you do not agree with the Software License Agreement, you cannot download the file.

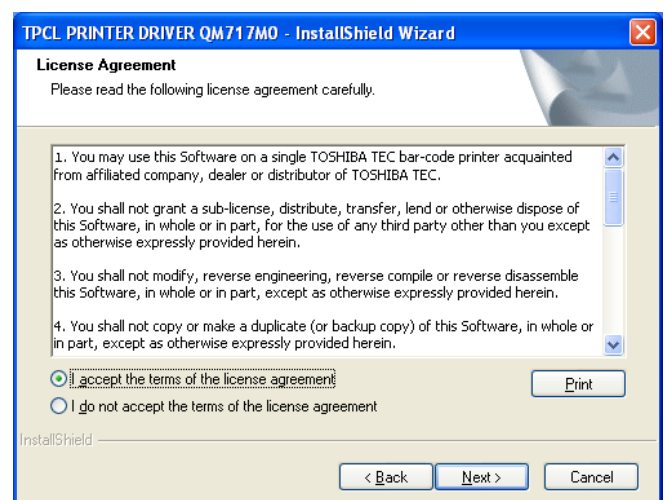

4. When you click the [Install] button, the printer driver install file is created in “C:\TEC\_DRV”.  
**Note:** The folder name cannot be changed from “C:\TEC\_DRV”.

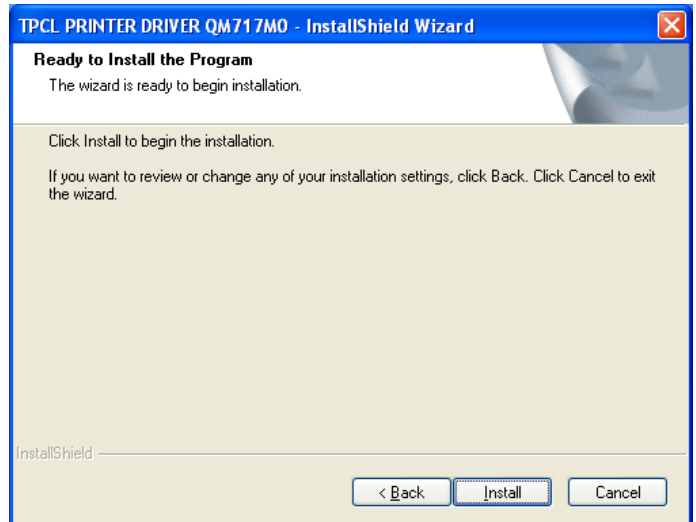

5. When the installation is completed, click the [Finish] button.

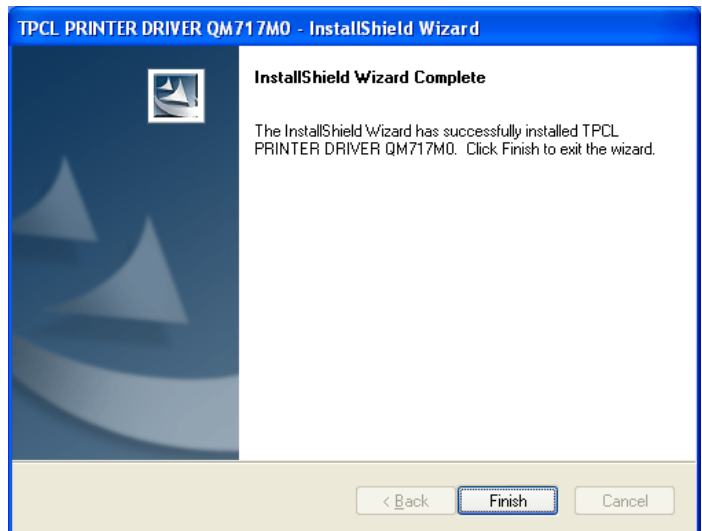

**Note:** In the case of Windows Vista/Server2008/7/ Server2008R2, the screen on the right will appear. Click the “Install this driver software anyway”.

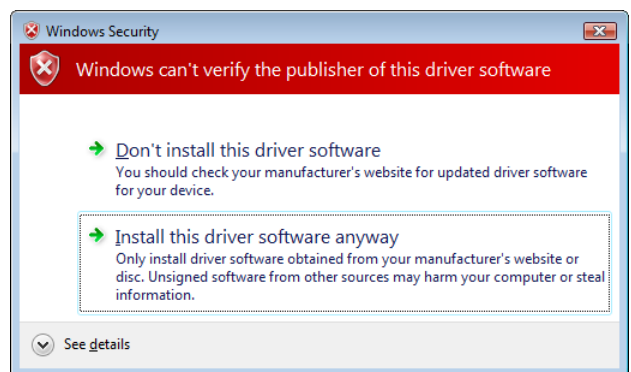

## 2.2 Installation under Windows XP/Server2003

**Note:** Proper operation is not guaranteed on the PC running Windows 2000.

1. Turn on the PC.

**Note:** Log on as the user with administrative privilege.

2. Select the “Start”, “Printer and FAX” to show the printer folder.

**Supplement:** In the case of Windows 2000, select “Start”, “Setting”, and “Printer”. If the “Printer and FAX” folder is not found, click the “Control Panel” and select the “Printer and FAX”.  
In the case of the category view, click the “Printer and Other Hardware” and select the “Printer and FAX”.

3. Select the “Add printer” from the File menu. The “Add Printer Wizard” is displayed.

4. Click the [Next] button in the “Add Printer Wizard”.

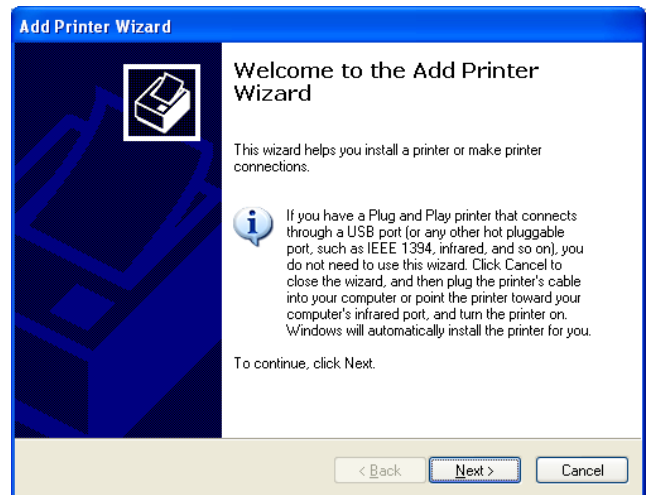

5. Select the “Local printer attached to this computer” and click the [Next] button.

**Note:** Do not check the “Automatically detect and install my Plug and Play printer” checkbox.

Even in the case of specifying the network printer or a printer connected to other PC, be sure to choose the local printer in this step. This setting is changed after the installation is completed. (☞ **To print on the shared printer.**)

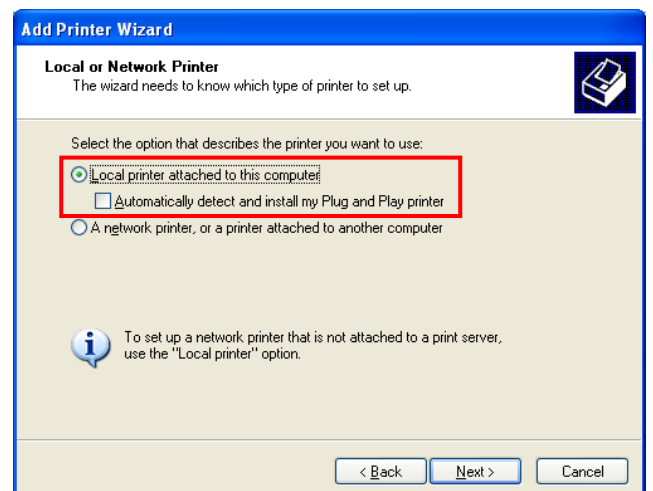

6. Specify a printer port and click the [Next] button.

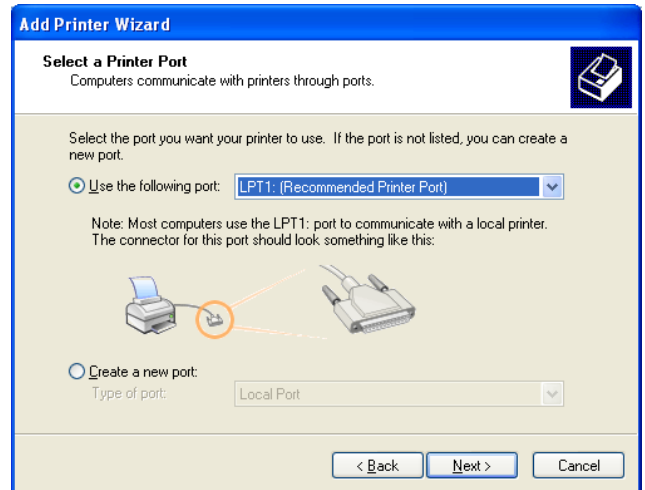

7. When the "Install Printer Software" screen appears, click the [Have Disk] button.

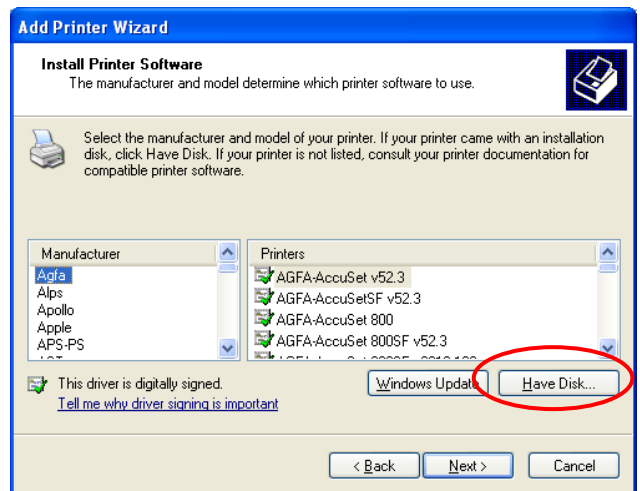

8. Specify the printer driver install folder (C:/TEC\_DRV) created in **Section 2.1 Preparation for Installation**, and click the [Open] button. Select the "TEC.inf" and click the [OK] button.

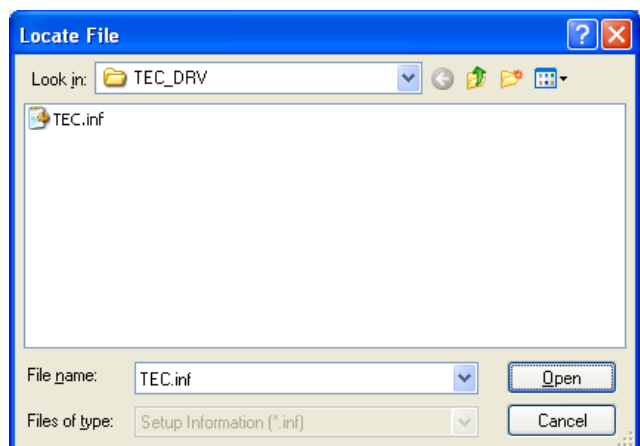

9. The list of the installable printer is displayed.

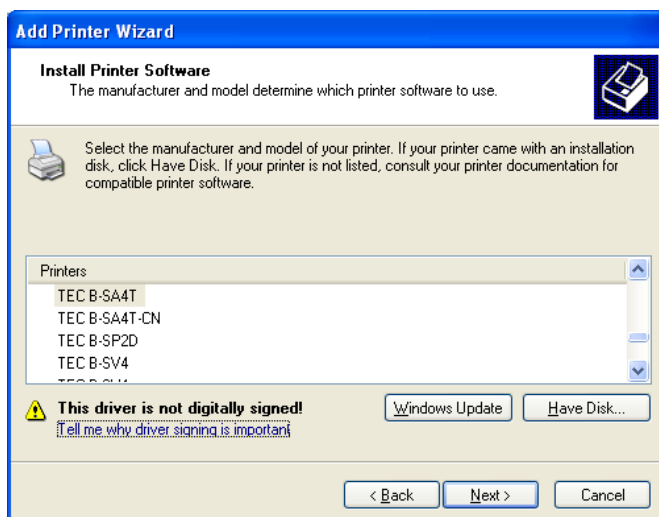

Driver name	Model	Driver name	Model	Driver name	Model
TEC B-372	B-372-QP	TEC B-415	B-415-GH24-QM B-415-GH25-QM	TEC B-419	B-419-GS10-QQ B-419-GS12-QP B-419-GS12-CN
TEC B-431	B-431-GS10-QP B-431-GS10-CN	TEC B-452	B-452-TS10-QQ B-452-TS10-QQ-US B-452-TS11-QQ-PAC B-452-TS12-QP B-452-TS12-QP-PAC B-452-TS12-CN	TEC B-452H	B-452-HS12-QQ B-452-HS12-QQ-US B-452-HS12-QP B-452-HS12-CN
TEC B-472	B-472-QQ B-472-QQ-US B-472-GH12-QQ B-472-QP	TEC B-472-CN	B-472-GH12-CN B-472-GH14-CN	TEC B-482	B-482-TS10-QQ B-482-TS10-QQ-US B-482-TS10-QP
TEC B-492	B-492L-TH10-QQ B-492R-TH10-QQ B-492L-TH10-QP B-492R-TH10-QP	TEC B-572	B-572-QQ B-572-QQ-US B-572-QP	TEC B-672	B-672-QQ B-672-QQ-US B-672-QP
TEC B-682	B-682-TS10-QQ B-682-TS10-QQ-US B-682-TS10-QP	TEC B-852	B-852-TS12-QQ B-852-TS12-QQ-US B-852-TS12-QP	TEC B-852-R	B-852-TS22-QQ-R B-852-TS22-QP-R
TEC B-872	B-872-QQ B-872-QQ-US B-872-QP	TEC B-882	B-882-TS10-QQ B-882-TS10-QQ-US B-882-TS10-QP	TEC B-SA4G	B-SA4TM-GS12-QM-R B-SA4TP-GS12-QM-R
TEC B-SA4T	B-SA4TM-TS12-QM-R B-SA4TP-TS12-QM-R	TEC B-SA4G-CN	B-SA4TP-GS12-CN-R	TEC B-SA4T-CN	B-SA4TM-TS12-CN B-SA4TP-TS12-CN
TEC B-SP2D	B-SP2D-GH20-QM B-SP2D-GH30-QM B-SP2D-GH30-QM-R B-SP2D-GH20-QM-R B-SP2D-GH30-QM-R B-SP2D-GH30-QM-R	TEC B-SV4	B-SV4D-GS10-QM B-SV4D-GC10-QM B-SV4D-GS10-QM-R B-SV4D-GC10-QM-R B-SV4D-GS10-CN B-SV4D-GH10-QQ-US B-SV4T-GS10-QM-R	TEC B-SX4	B-SX4T-GS10-QQ B-SX4T-GS10-QQ-US B-SX4T-GS10-QP B-SX4T-GS20-QQ B-SX4T-GS20-QQ-US B-SX4T-GS20-QP B-SX4T-GS20-QM-R
TEC B-SX4-CN	B-SX4T-GS10-CN B-SX4T-GS20-CN B-SX4T-GS20-CN-R	TEC B-SX5	B-SX5T-TS12-QQ B-SX5T-TS12-QQ-US B-SX5T-TS12-QP B-SX5T-TS22-QQ B-SX5T-TS22-QQ-US B-SX5T-TS22-QP B-SX5T-TS22-QM-R	TEC B-SX5-CN	B-SX5T-TS12-CN B-SX5T-TS22-CN B-SX5T-TS22-CN-R
TEC B-SX6T-R	B-SX6T-TS12-QM-R	TEC B-SX8T-R	B-SX8T-TS12-QM-R	TEC CB-416-T3	CB-416-T3-QQ CB-416-T3-QQ-US CB-416-T3-QP
TEC CB-426-T3	CB-426-T3-QQ CB-426-T3-QQ-US CB-426-T3-QP	TEC B-452-R	B-452-TS22-QQ/QP-R B-452-TS22-CN	TEC B-EP2DL-G	B-EP2DL-GH20-QM-R B-EP2DL-GH30-QM-R B-EP2DL-GH40-QM-R
TEC B-EP4DL-G	B-EP4DL-GH20-QM-R B-EP4DL-GH30-QM-R B-EP4DL-GH40-QM-R	TEC B-EV4-G	B-EV4D-GS14-QM-R B-EV4T-GS14-QM-R	TEC B-EV4-T	B-EV4D-TS14-QM-R B-EV4T-TS14-QM-R
TEC B-EX4T1-G	B-EX4T1-GS12-QM-R B-EX4T1-GS12-CN-R	TEC B-EX4T1-T	B-EX4T1-TS12-QM-R B-EX4T1-TS12-CN-R	TEC B-EX4T2-G	B-EX4T2-GS12-QM-R B-EX4T2-GS12-CN-R
TEC B-EX4T2-T	B-EX4T2-TS12-QM-R B-EX4T2-TS12-CN-R	TEC B-EX4T2-H	B-EX4T2-HS12-QM-R B-EX4T2-HS12-CN-R		

10. Select the model to be installed, and click the [Next] button.

11. Select the “Replace existing driver”, and click the [Next] button.

**Supplement:** This step will be omitted when the printer driver is installed for the first time.

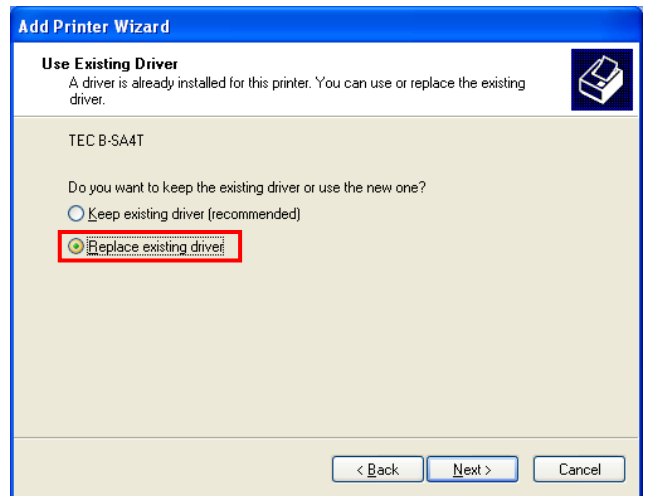

12. Select whether or not to use the printer as a default printer, then click the [Next] button.

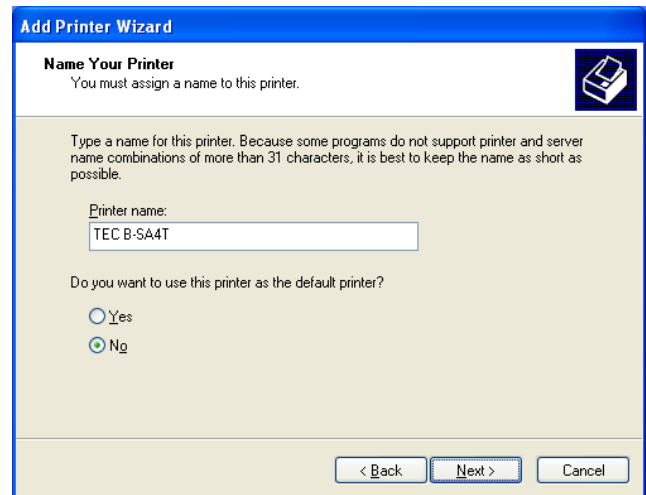

13. Select whether or not to share the printer with other users on the network, then click the [Next] button.

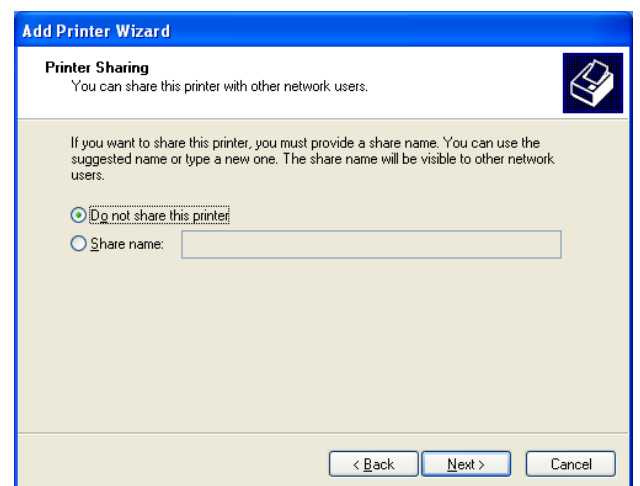

14. Select whether or not to perform a print test, then click the [Next] button.

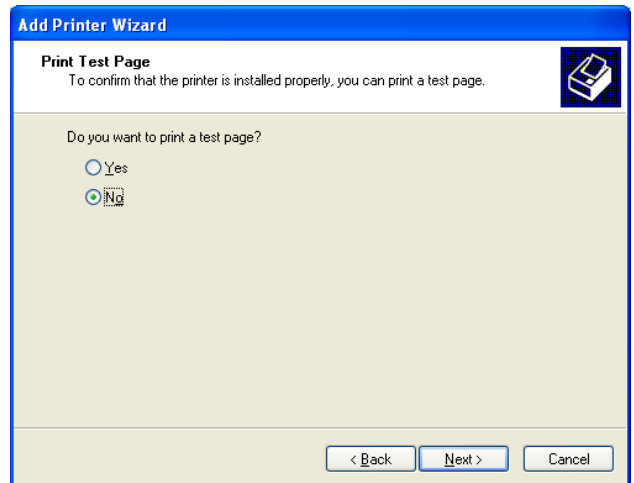

15. When the “Completing the Add Printer Wizard” is displayed, click the [Finish] button.

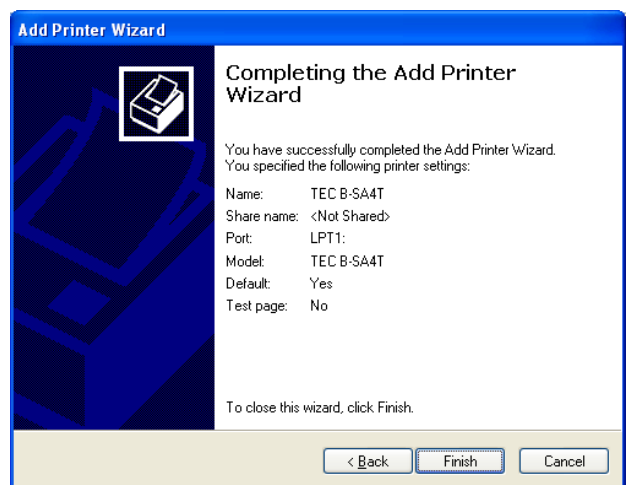

16. When the screen on the right appears, click the [Continue Anyway] button.

**Note:** “Digital Signature Not Found” message may be displayed. In that case, click the [Yes] button.

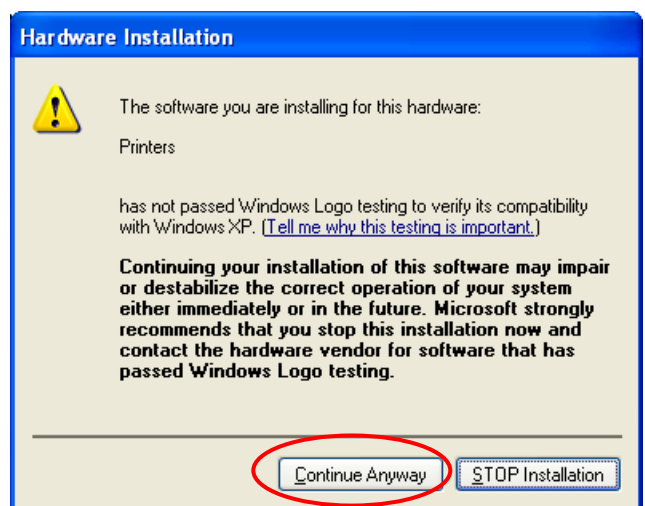

17. Installation of the printer driver starts.

18. When the installation is completed, a new printer icon will be added to the “Printer” folder.



■ To print on the shared printer

1. Conduct above-mentioned steps 1 through 18.

2. Log on as the user which is allowed to access the PC with which the printer is shared.

**Note:** This work requires the administrative privilege. For the user with no administrative privilege, grant it temporarily.

3. Right-click the newly added icon, and select the "Properties" to open the "Properties" screen.

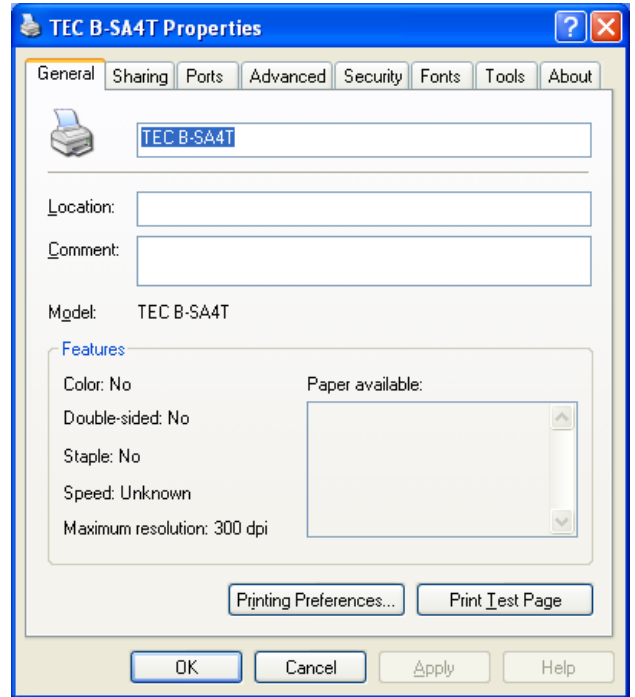

4. Click the [Port] tab, then click the [Add Port] button.

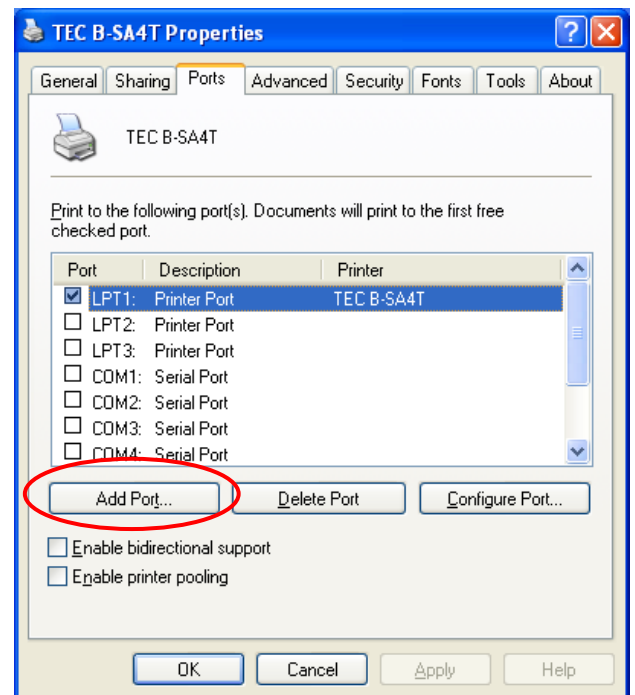

5. Select the “Local Port”, and click the [New Port] button.

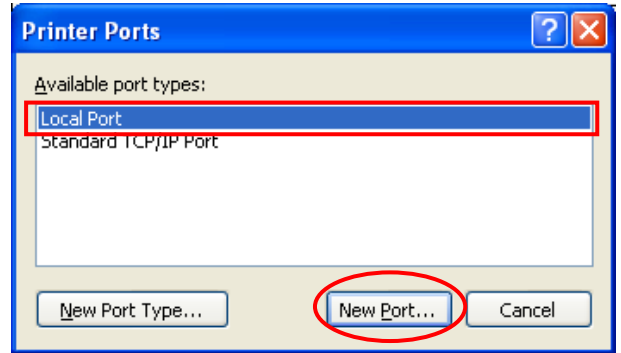

6. Enter the network path of the shared printer (e.g. \\\*\*\*\*\*\TECB-SA4), then click the [OK] button.

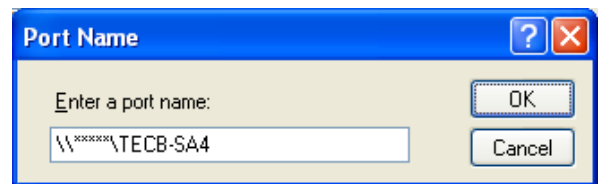

7. When the port setting is completed, click the [OK] button to close the “Properties” screen.

**Note:** After installing this printer driver, be sure to disable the Bi-directional support. For details, refer to **Section 6.1 How to Enable Bi-directional Communication Support.**

Since the setup information is stored in each PC that shares the printer, please configure the printer driver settings after the completion of the port setting.

## 2.3 Installation under Windows Vista/Server2008/7/Server2008R2

**Note:** If the installation did not succeed, follow the procedure described in *How to set up Windows Vista/Server2008/7/Server2008R2 again*.

1. Turn on the PC.

**Note:** Log on as the user with administrative privilege.

2. Select “Start”, “Control Panel”, “Hardware and Sound”, and “Printer” to open the printer folder.

**Supplement:** Entering “Printer” in the Search box of the Start menu causes the “Printer” to be shown in the Program.

3. Click the “Install a Printer” to start adding a printer.

4. Select the “Add a local printer”.

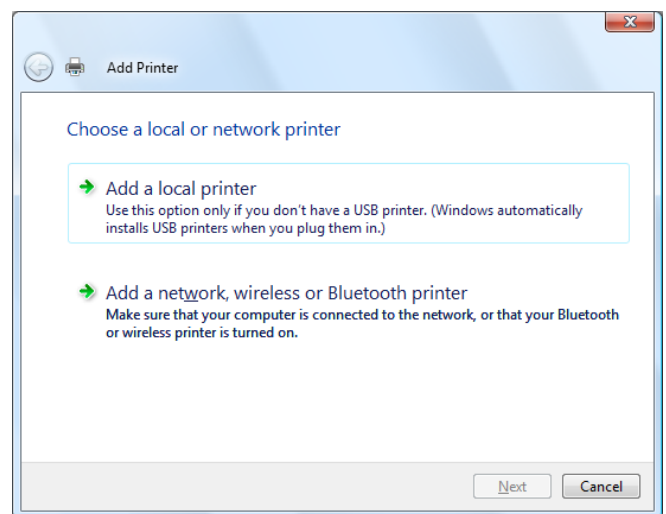

5. Select a printer port, and click the [Next] button.

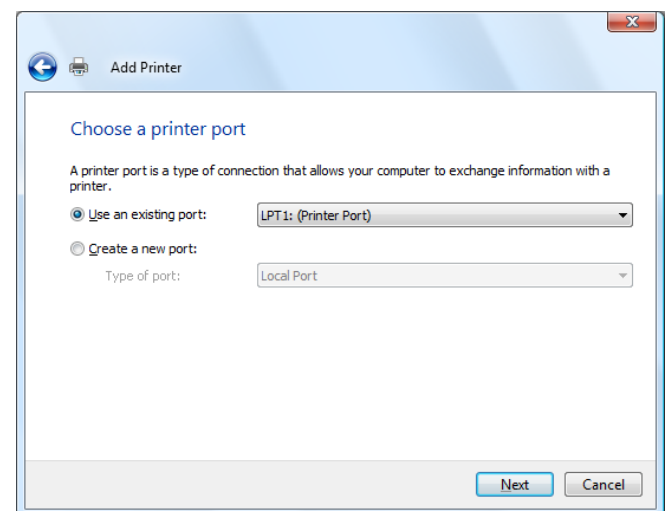

6. When the screen on the right appears, select "TEC" from the Manufacturer list.

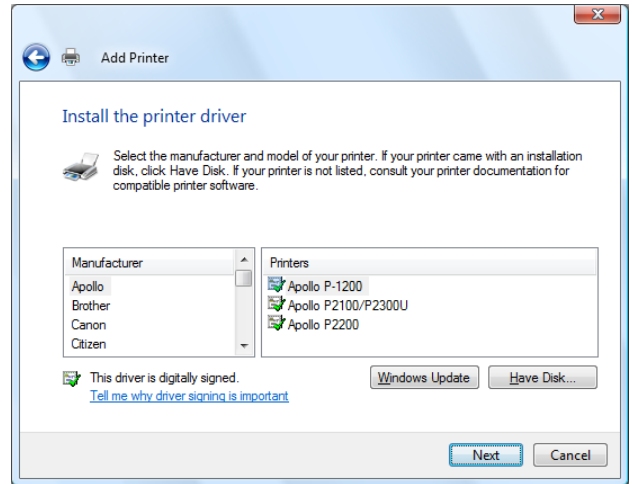

7. The list of the installable printer models are displayed.

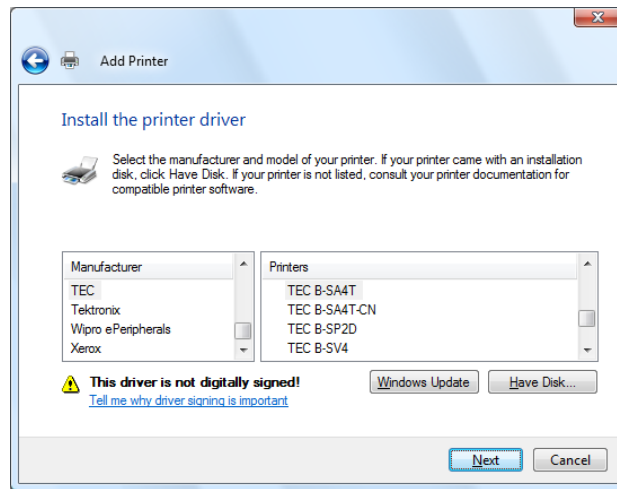

Driver name	Model	Driver name	Model	Driver name	Model
TEC B-372	B-372-QP	TEC B-415	B-415-GH24-QM B-415-GH25-QM	TEC B-419	B-419-GS10-QQ B-419-GS12-QP B-419-GS12-CN
TEC B-431	B-431-GS10-QP B-431-GS10-CN	TEC B-452	B-452-TS10-QQ B-452-TS10-QQ-US B-452-TS11-QQ-PAC B-452-TS12-QP B-452-TS12-QP-PAC B-452-TS12-CN	TEC B-452H	B-452-HS12-QQ B-452-HS12-QQ-US B-452-HS12-QP B-452-HS12-CN
TEC B-472	B-472-QQ B-472-QQ-US B-472-GH12-QQ B-472-QP	TEC B-472-CN	B-472-GH12-CN B-472-GH14-CN	TEC B-482	B-482-TS10-QQ B-482-TS10-QQ-US B-482-TS10-QP
TEC B-492	B-492L-TH10-QQ B-492R-TH10-QQ B-492L-TH10-QP B-492R-TH10-QP	TEC B-572	B-572-QQ B-572-QQ-US B-572-QP	TEC B-672	B-672-QQ B-672-QQ-US B-672-QP
TEC B-682	B-682-TS10-QQ B-682-TS10-QQ-US B-682-TS10-QP	TEC B-852	B-852-TS12-QQ B-852-TS12-QQ-US B-852-TS12-QP	TEC B-852-R	B-852-TS22-QQ-R B-852-TS22-QP-R
TEC B-872	B-872-QQ B-872-QQ-US B-872-QP	TEC B-882	B-882-TS10-QQ B-882-TS10-QQ-US B-882-TS10-QP	TEC B-SA4G	B-SA4TM-GS12-QM-R B-SA4TP-GS12-QM-R
TEC B-SA4T	B-SA4TM-TS12-QM-R B-SA4TP-TS12-QM-R	TEC B-SA4G-CN	B-SA4TP-GS12-CN-R	TEC B-SA4T-CN	B-SA4TM-TS12-CN B-SA4TP-TS12-CN
TEC B-SP2D	B-SP2D-GH20-QM B-SP2D-GH30-QM B-SP2D-GH30-QM B-SP2D-GH20-QM-R B-SP2D-GH30-QM-R B-SP2D-GH30-QM-R	TEC B-SV4	B-SV4D-GS10-QM B-SV4D-GC10-QM B-SV4D-GS10-QM-R B-SV4D-GC10-QM-R B-SV4D-GS10-CN B-SV4D-GH10-QQ-US	TEC B-SX4	B-SX4T-GS10-QQ B-SX4T-GS10-QQ-US B-SX4T-GS10-QP B-SX4T-GS20-QQ B-SX4T-GS20-QQ-US B-SX4T-GS20-QP

Driver name	Model	Driver name	Model	Driver name	Model
TEC B-SX4-CN	B-SX4T-GS10-CN B-SX4T-GS20-CN B-SX4T-GS20-CN-R	TEC B-SX5	B-SV4T-GS10-QM-R B-SX5T-TS12-QQ B-SX5T-TS12-QQ-US B-SX5T-TS12-QP B-SX5T-TS22-QQ B-SX5T-TS22-QQ-US B-SX5T-TS22-QP B-SX5T-TS22-QM-R	TEC B-SX5-CN	B-SX4T-GS20-QM-R B-SX5T-TS12-CN B-SX5T-TS22-CN B-SX5T-TS22-CN-R
TEC B-SX6T-R	B-SX6T-TS12-QM-R	TEC B-SX8T-R	B-SX8T-TS12-QM-R	TEC CB-416-T3	CB-416-T3-QQ CB-416-T3-QQ-US CB-416-T3-QP
TEC CB-426-T3	CB-426-T3-QQ CB-426-T3-QQ-US CB-426-T3-QP	TEC B-452-R	B-452-TS22-QQ/QP-R B-452-TS22-CN	TEC B-EP2DL-G	B-EP2DL-GH20-QM-R B-EP2DL-GH30-QM-R B-EP2DL-GH40-QM-R
TEC B-EP4DL-G	B-EP4DL-GH20-QM-R B-EP4DL-GH30-QM-R B-EP4DL-GH40-QM-R	TEC B-EV4-G	B-EV4D-GS14-QM-R B-EV4T-GS14-QM-R	TEC B-EV4-T	B-EV4D-TS14-QM-R B-EV4T-TS14-QM-R
TEC B-EX4T1-G	B-EX4T1-GS12-QM-R B-EX4T1-GS12-CN-R	TEC B-EX4T1-T	B-EX4T1-TS12-QM-R B-EX4T1-TS12-CN-R	TEC B-EX4T2-G	B-EX4T2-GS12-QM-R B-EX4T2-GS12-CN-R
TEC B-EX4T2-T	B-EX4T2-TS12-QM-R B-EX4T2-TS12-CN-R	TEC B-EX4T2-H	B-EX4T2-HS12-QM-R B-EX4T2-HS12-CN-R		

8. Select a model to be installed, then click the [Next] button.

9. Select the “Replace the current driver”, and click the [Next] button.

**Supplement:** This step will be omitted when the printer driver is installed for the first time.

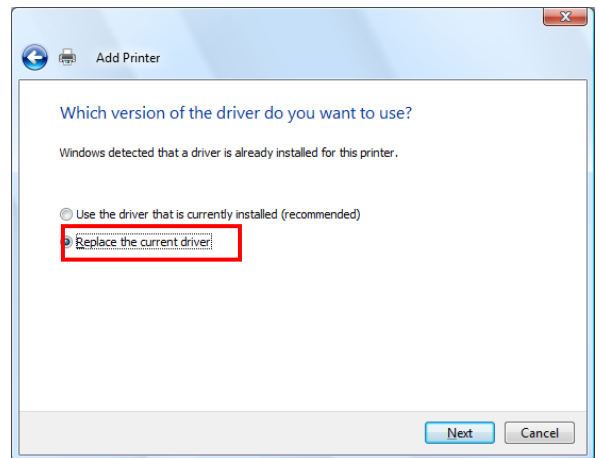

10. Select whether or not to use the printer as a default printer, then click the [Next] button.

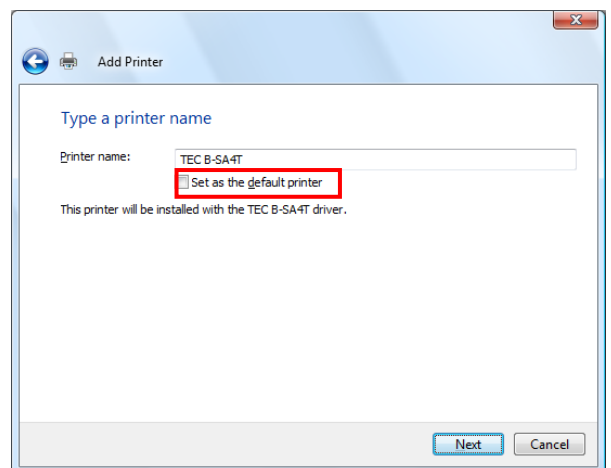

11. Installation starts.

12. When the installation is completed, the “Add Printer” screen is displayed. At this time, a new printer icon is added to the “Printer” folder. Click the [Finish] button. If you want to perform a print test, click the [Print a test page] button.

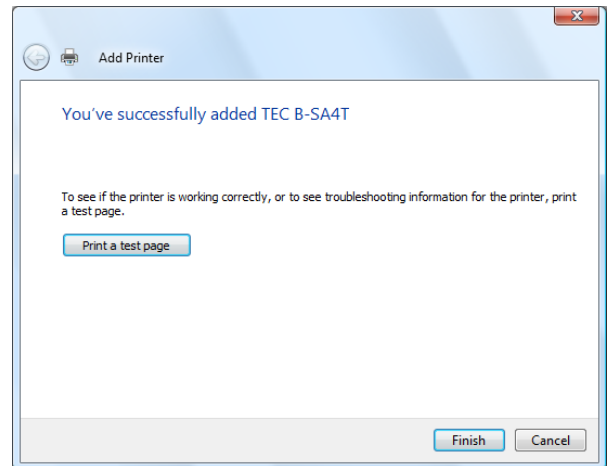

■ To print on the shared printer (1)

1. Conduct above-mentioned steps 1 through 12.

2. Log on as the user which is allowed to access the PC with which the printer is shared.

**Note:** This work requires the administrative privilege. For the user with no administrative privilege, grant it temporarily.

3. Right-click the newly added icon, and select the “Properties” to open the “Properties” screen.

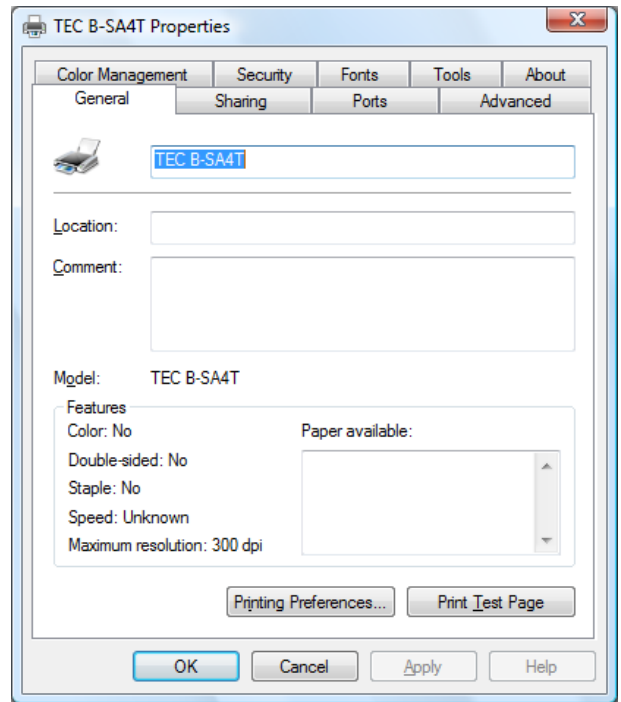

4. Click the “Ports” tab, and remove the check from the “Enable bi-directional support” checkbox. Click the [Add Port] button.

**Note:** After installing this printer driver, be sure to disable the bi-directional support. For details, refer to **Section 6.1 How to Enable Bi-directional Communication Support.**

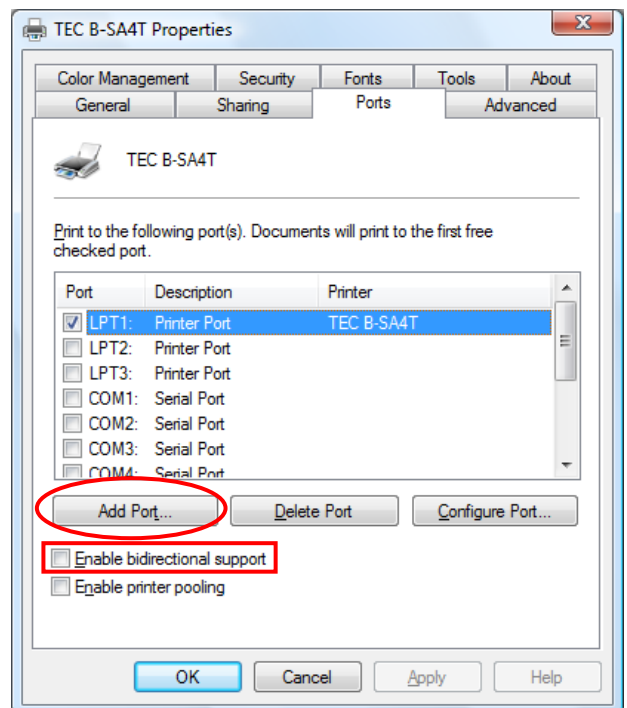

5. Select the “Local Port”, and click the [New Port] button.

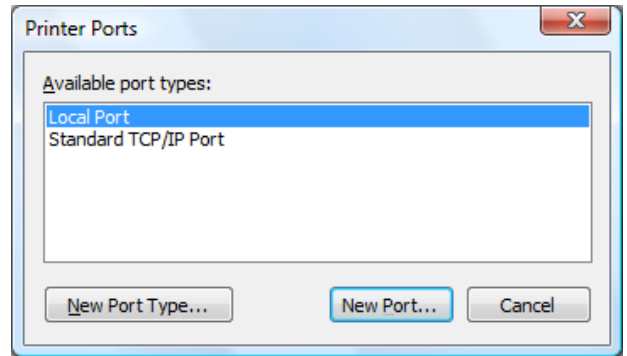

6. Enter the network path of the shared printer (e.g. \\\*\*\*\*\*\TECB-SA4), then click the [OK] button.

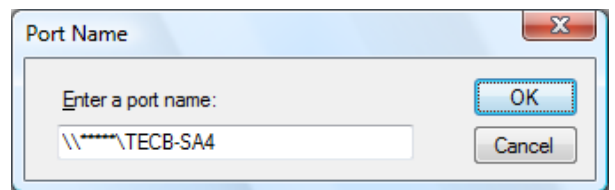

7. When the port setting is completed, click the [OK] button to close the “Properties” screen.

**Note:** After installing this printer driver, be sure to disable the Bi-directional support. For details, refer to **Section 6.1 How to Enable Bi-directional Communication Support.**

Since the setup information is stored in each PC that shares the printer, please configure the printer driver settings after the completion of the port setting.



## ■ To print on the shared printer (2)

**Note:** If the printer driver of different version has been already installed, first uninstall it, then install this printer driver. The version of the printer drivers in the server PC and client PC must be the same.

### ◆ Read before installation

The printer driver installed in the server PC must support Windows Vista/Server 2008/7/Server2008R2.

For the client PC, the printer driver needs to be installed in or uninstalled from each user account.

Configure the network settings for the Server PC's shared printer driver, as shown in the screen on the right.

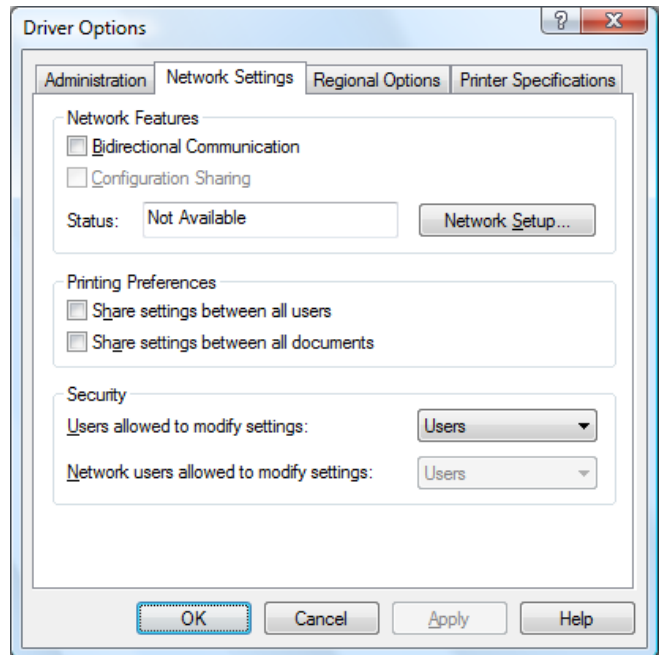

1. Turn on the PC.

**Note:** Log on as the user with administrative privilege.

2. Follow the procedure described in **Section 2.1 Preparation for Installation**.

3. Log on as the user which is allowed to access the PC with which the printer is shared.

4. Select the "Start", "Control Panel", "Hardware and Sound", and "Printer" to open the printer folder.

**Supplement:** Entering "Printer" in the Search box of the Start menu causes the "Printer" to be shown in the Program.

5. Click the "Install a Printer" to start adding a printer.

6. Select the “Add a network, wireless or Bluetooth printer”.

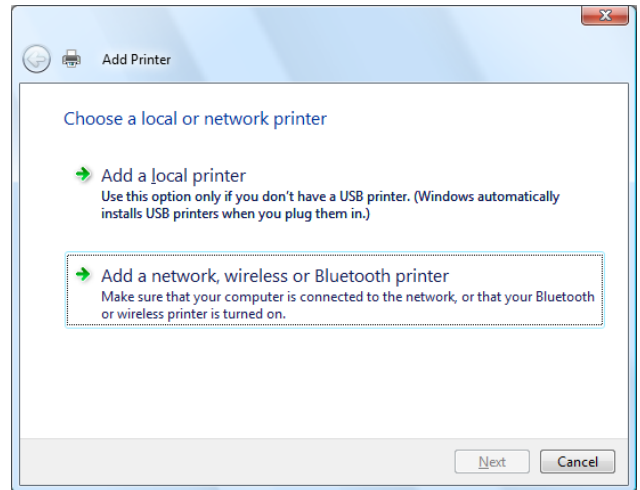

7. Click the “The printer that I want isn't listed”.

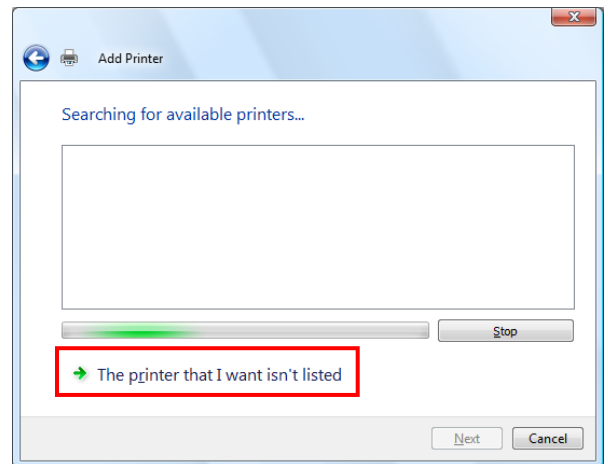

8. Click the “Select a shared printer by name”, enter the network path of the shared printer (e.g. \\\*\*\*\*\*\TECB-SA4), then click the [OK] button.

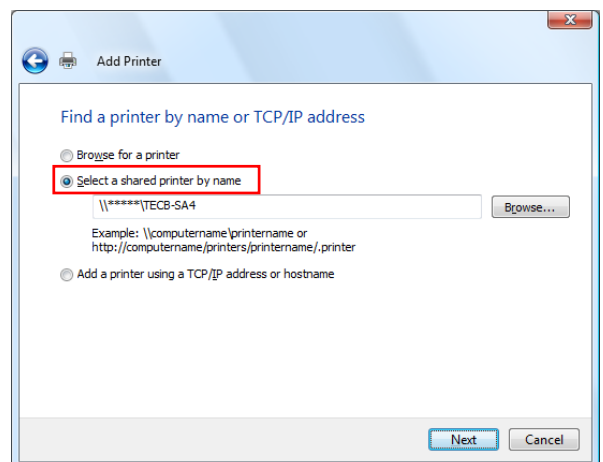

9. Installation starts.

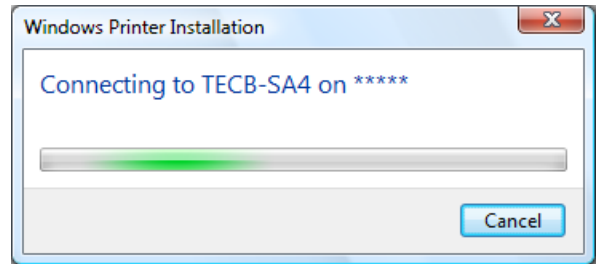

**Supplement:** If the dialog box on the right appears after the installation, click the [Disable] button.

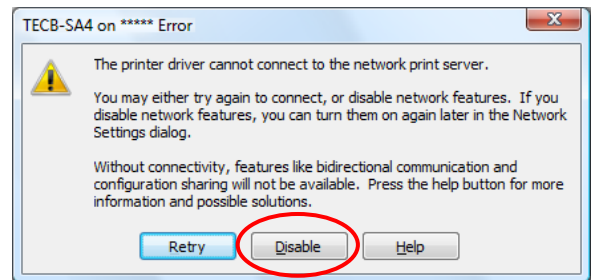

10. Select whether or not to use the printer as a default printer, then click the [Next] button.

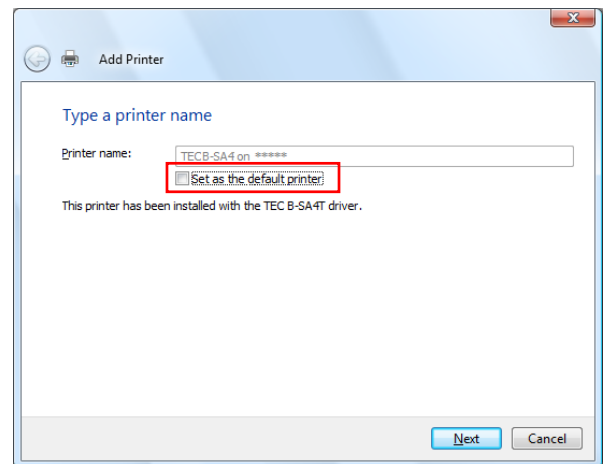

11. When the installation is completed, the screen on the right will appear. At this time, a new printer icon is added to the "Printer" folder. Click the [Finish] button. If you want to perform a print test, click the [Print a test page] button.

**Note:** Since the setup information is stored in each PC that shares the printer, please configure the printer driver settings after the completion of the port setting.

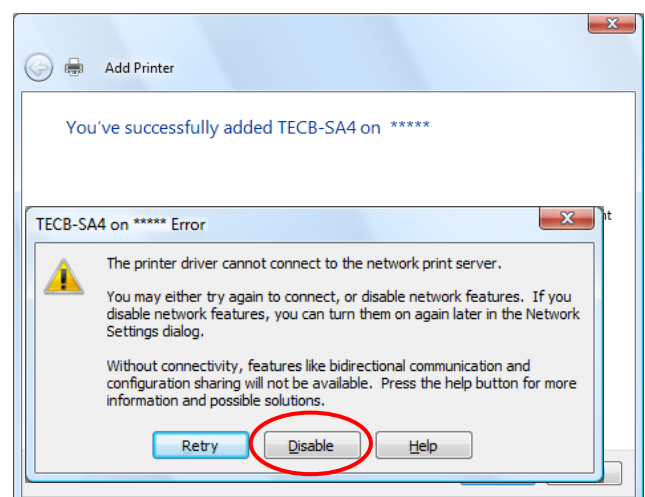

## 2.4 Installation under Windows 2000 (USB with Plug & Play Enabled)

**Note:** Proper operation is not guaranteed on the PC running Windows 2000.

1. Turn on the PC.  
**Note:** Log on as the user with administrative privilege.
2. Turn on the printer and connect it to the PC with a USB cable.
3. "USB DEVICE" is detected and "USB Print support" is automatically installed.
4. After a while, the "Found New Hardware Wizard" is displayed. Click the [Next] button.



5. Select the "Search for a suitable driver for my device (recommended)", and click the [Next] button.



6. Check the "Specify a location" checkbox, then click the [Next] button.

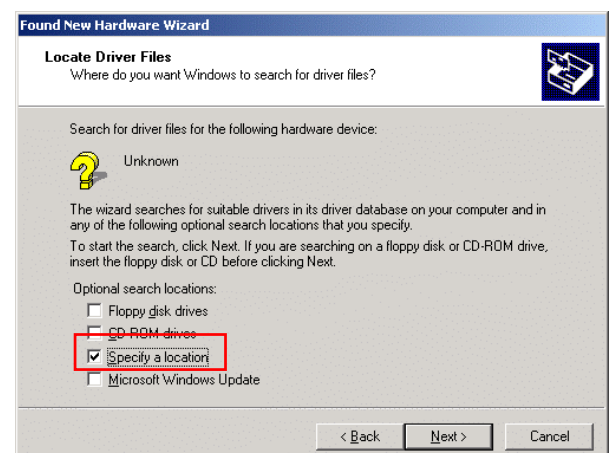

7. Click the [Browse] button. Specify the folder (C:\TEC\_DRV) created in **Section 2.1**, and click the [Next] button.

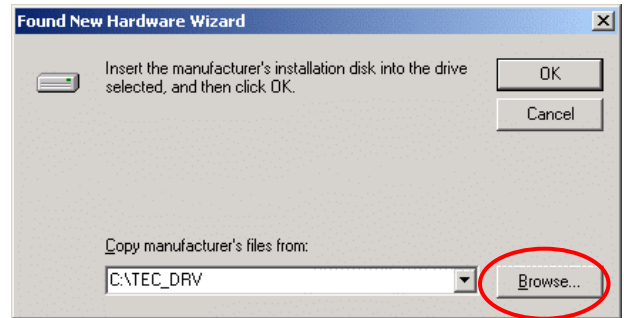

8. Make sure the driver of this device has been detected, then click the [Next] button.

Device driver name

B-852-R, B-SA4G, B-SA4G-CN, B-SA4T, B-SA4T-CN, B-SX4, B-SX4-CN, B-SX5, B-SX5-CN, B-SX6T-R, B-SX8T-R, B-SV4, B-452-R, B-EP2DL-G, B-EP4DL-G, B-EV4-G, B-EV4-T, B-EX4T1-G, B-EX4T1-T, B-EX4T2-G, B-EX4T2-T, B-EX4T2-H

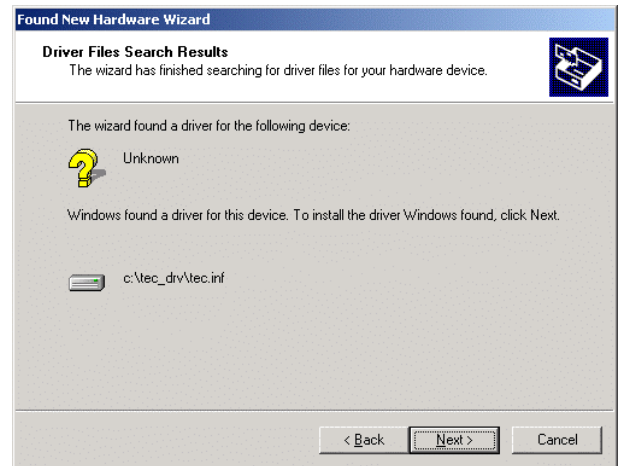

9. When the screen on the right is displayed, click the [Yes] button.



10. When the “Completing the Found New Hardware Wizard” is displayed, click the [Finish] button.

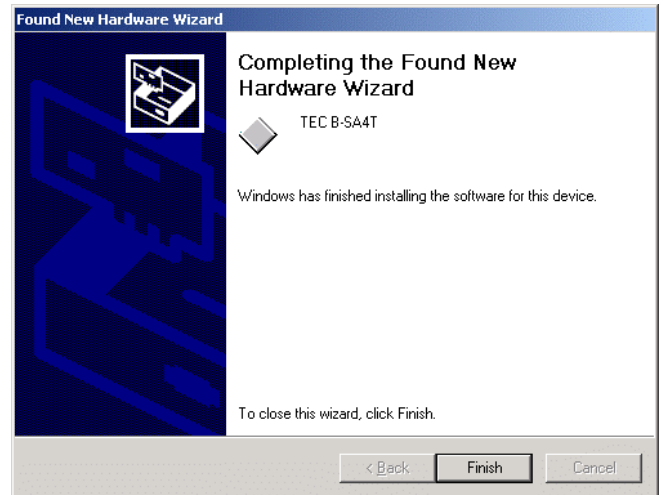

11. When the installation is completed, a new printer icon is added to the Printer folder.

**Note:** For the TEC-B-419, be sure to disable the bi-directional support after the installation of this driver. For details, refer to **Section 6.1 How to Enable Bi-directional Communication Support.**

## 2.5 Installation under Windows XP/Server2003 (USB with Plug & Play enabled)

1. Turn on the PC.

**Note:** Log on as the user with administrative privilege.

2. Turn on the printer, and connect it to the PC with a USB cable.

3. "USB DEVICE" is detected, and the "USB Print Support" is automatically installed.

4. After a while, new devices are detected.

New device names

B-852-R, B-SA4G, B-SA4G-CN, B-SA4T, B-SA4T-CN, B-SX4, B-SX4-CN, B-SX5, B-SX5-CN, B-SX6T-R, B-SX8T-R, B-SV4, B-452-R, B-EP2DL-G, B-EP4DL-G, B-EV4-G, B-EV4-T, B-EX4T1-G, B-EX4T1-T, B-EX4T2-G, B-EX4T2-T, B-EX4T2-H

5. When the "Found New Hardware Wizard" is displayed, select "Install from a list or specific location [Advanced]" and click the [Next] button.

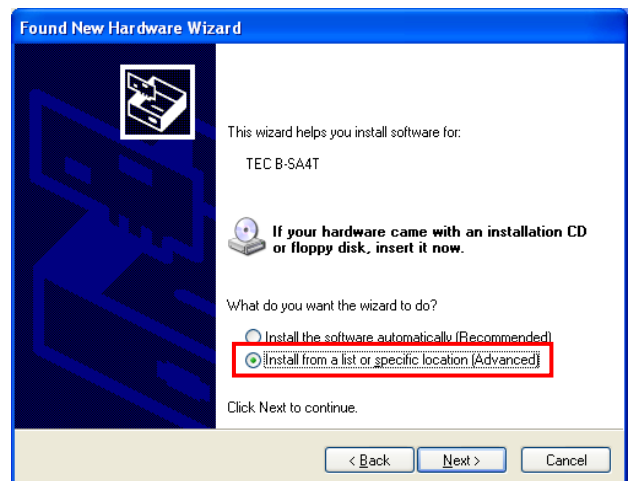

6. Select the "Search for the best driver in these locations", check the "Include this location in the search" checkbox, and click the [Browse] button. Specify the folder (C:\TEC\_DRV) created in **Section 2.1**, and click the [Next] button.

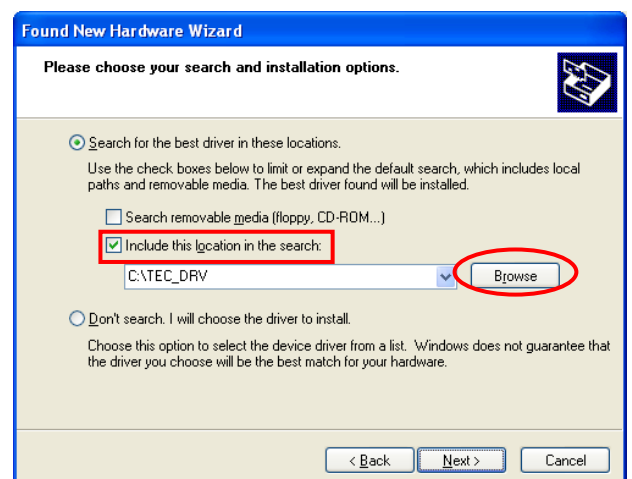

7. When the screen on the right appears, click the [Continue Anyway] button.

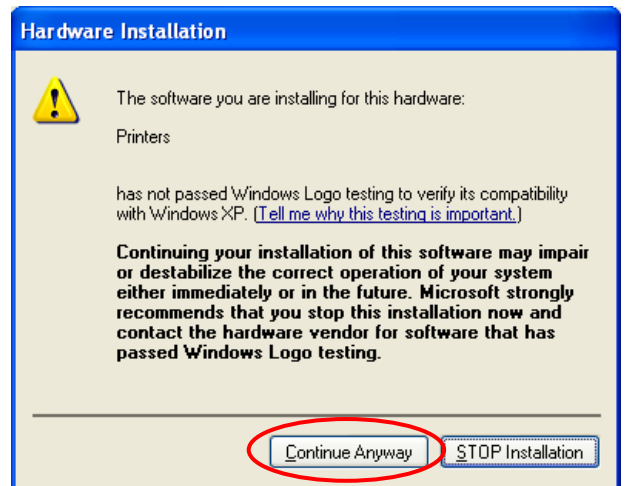

8. When the “Completing the Found New Hardware Wizard” is displayed, click the [Finish] button.

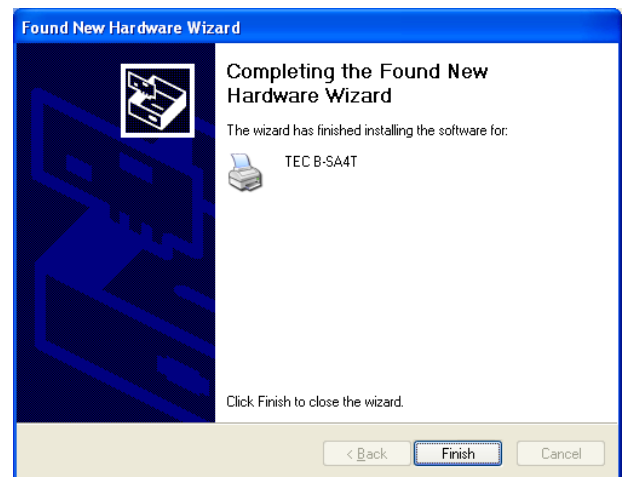

9. When the installation is completed, a new printer icon is added to the Printer folder.

**Note:** For the B-419, be sure to disable the Bi-directional support. For details, refer to **Section 6.1 How to Enable Bi-directional Communication Support.**



## 2.6 Installation under Windows Vista/Server 2008/7/Server2008R2 (USB with Plug & Play Enabled)

**Note:** If an undefined device is created after installation of the printer driver, follow the procedure described in the section *If plug-and-play installation fails under Windows Vista/Server2008/7/Server2008R2*.

1. Turn on the PC.

**Note:** Log on as the user with administrative privilege.

2. Turn on the printer and connect it to the PC with a USB cable.

3. Installation of the device driver software is automatically started.

4. After a while, the printer driver installation is completed.

5. When the installation is completed, a new printer icon is added to the Printer folder.

**Note:** For the B-419, be sure to disable the "Bi-directional support" after the installation of the printer driver. For details, refer to **Section 6.1 How to Enable Bi-directional Communication Support**.

## 2.7 Installation under Windows 2000 (Parallel interface with Plug & Play Enabled)

**Note:** Proper operation is not guaranteed on the PC running Windows 2000.

1. Connect the printer to the PC with a parallel interface cable.
2. Turn on the printer.
3. Set the printer parameters in the system mode.

**B-SX4, B-SX4-CN, B-SX5, and B-SX5-CN**

CENTRO. MODE → ECP

PLUG & PLAY → ON

**B-SA4G, B-SA4G-CN, B-SA4T, B-SA4T-CN, B-852-R, B-452-R, B-SX6T-R, B-SX8T-R, B-EX4T1-G, B-EX4T1-T, B-EX4T2-G, B-EX4T2-T, B-EX4T2-H**

PLUG & PLAY → ON

**Note:** For the parameter setting procedure, refer to **Section 6.2 Parameter Setting on the Printer**.

4. Turn on the PC.

**Note:** Log on as the user with administrative privilege.

5. After the system started, new hardware is detected. When the “Welcome to the Found New Hardware Wizard” is displayed, click the [Next] button.



6. Select “Search for a suitable driver for my device (recommended)”, then click the [Next] button.



7. Check the "Specify a location" check box, and click the [Next] button.

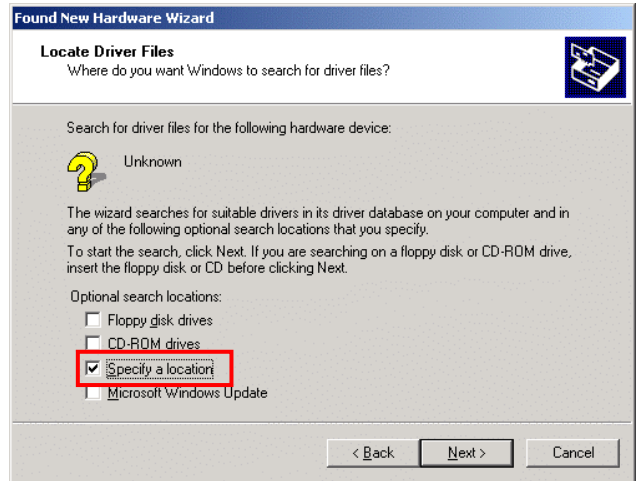

8. Click the [Browse] button, specify the folder (C:\TEC\_DRV) created in **Section 2.1 Preparation for Installation**, and click the [Next] button.

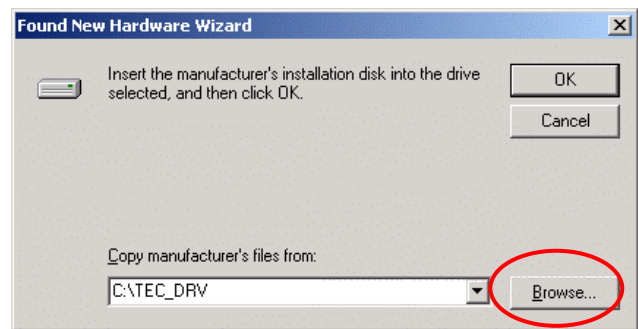

9. Make sure the applicable drivers are detected, then click the [Next] button.

Device driver name

B-852-R, B-452-R, B-SA4G, B-SA4G-CN,  
 B-SA4T, B-SA4T-CN, B-SX4, B-SX4-CN,  
 B-SX5, B-SX5-CN, B-SX6T-R, B-EX4T1-G,  
 B-EX4T1-T, B-EX4T2-G, B-EX4T2-T,  
 B-EX4T2-H

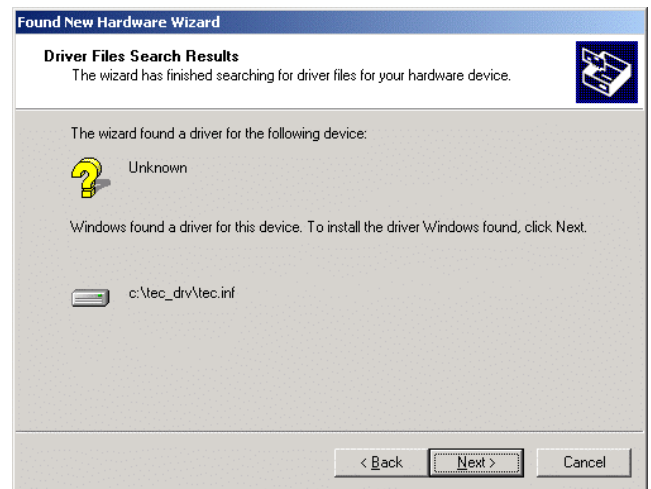

10. When the screen on the right is displayed, click the [Yes] button.

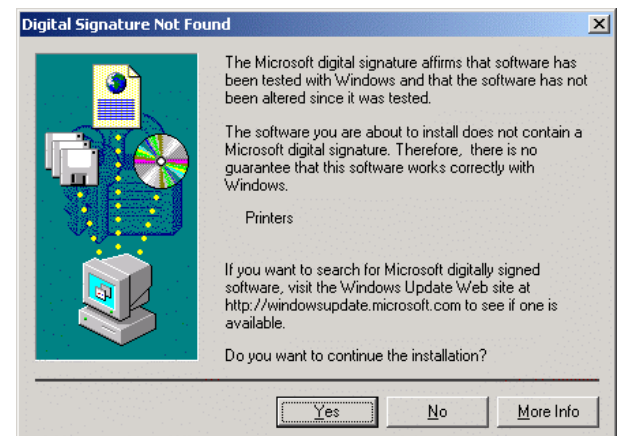

11. When the “Completing the Found New Hardware Wizard” is displayed, click the [Finish] button.

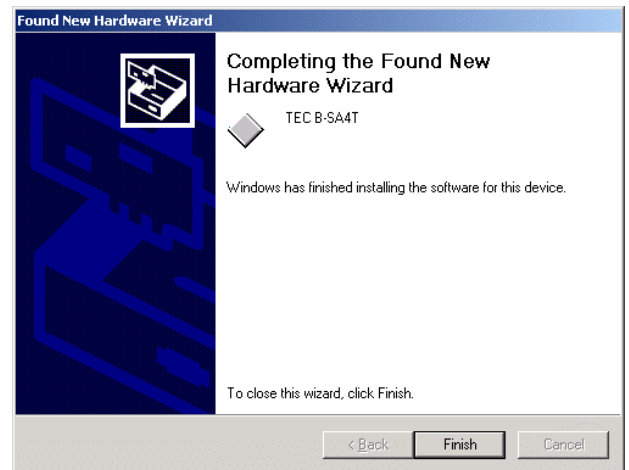

12. When the installation is completed, a new printer icon is added to the Printer folder.

**Note:** For the models other than B-SX4, B-SX4-CN, B-SX5, or B-SX5-CN, be sure to disable the bi-directional support after installing this printer driver. For details, refer to **Section 6.1. How to Enable Bi-directional Communication Support.**

## 2.8 Installation under Windows XP/Server2003 (Parallel interface with Plug & Play Enabled)

1. Connect the printer to the PC with a parallel interface cable.
2. Turn on the printer.
3. Set the printer parameters in the system mode.

**B-SX4, B-SX4-CN, B-SX5, and B-SX5-CN**

CENTRO. MODE → ECP

PLUG & PLAY → ON

**B-SA4G, B-SA4G-CN, B-SA4T, B-SA4T-CN, B-852-R, B-452-R, B-SX6T-R, B-SX8T-R, B-EX4T1-G, B-EX4T1-T, B-EX4T2-G, B-EX4T2-T, and B-EX4T2-H**

PLUG & PLAY → ON

**Note:** For the parameter setting procedure, refer to **Section 6.2 Parameter Setting on the Printer**.

4. Turn on the PC

**Note:** Log on as the user with administrative privilege.

5. After the system is started, new hardware is detected. When the “Found New Hardware Wizard” is displayed, select the “Install from a list or specific location (Advanced)”, then click the [Next] button.

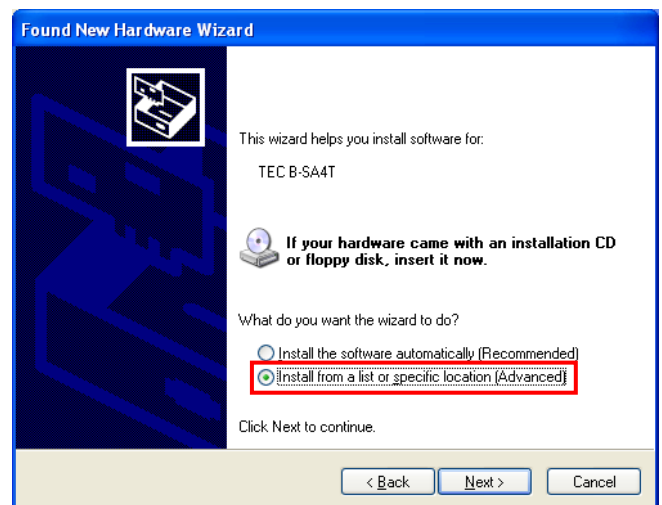

6. Select the “Search for the best driver in these locations”, check the “Include this location in the search” checkbox, then click the [Browse] button. Specify the folder (C:\TEC\_DRV) created in **Section 2.1**, and click the [Next] button.

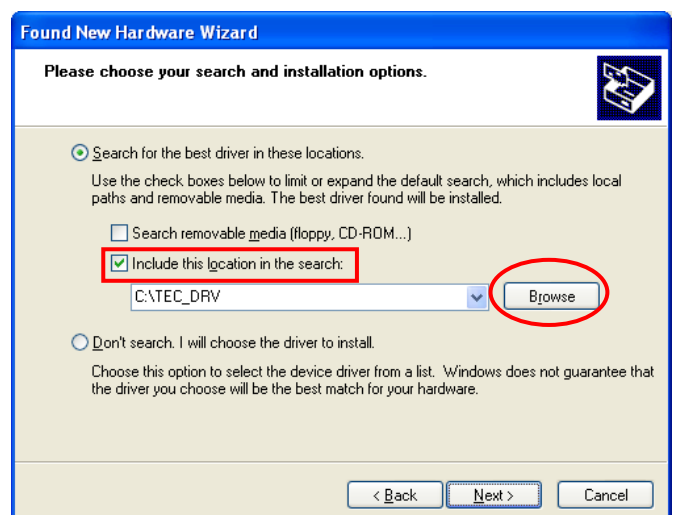

7. When the screen on the right appears, click the [Continue Anyway] button.

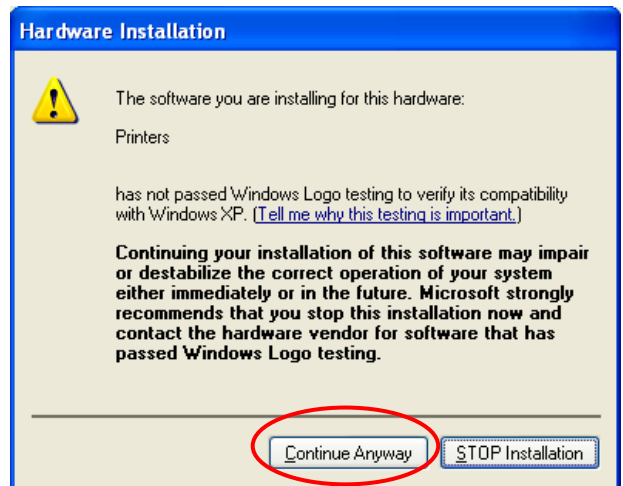

8. When the “Completing the Found New Hardware Wizard” is displayed, click the [Finish] button.

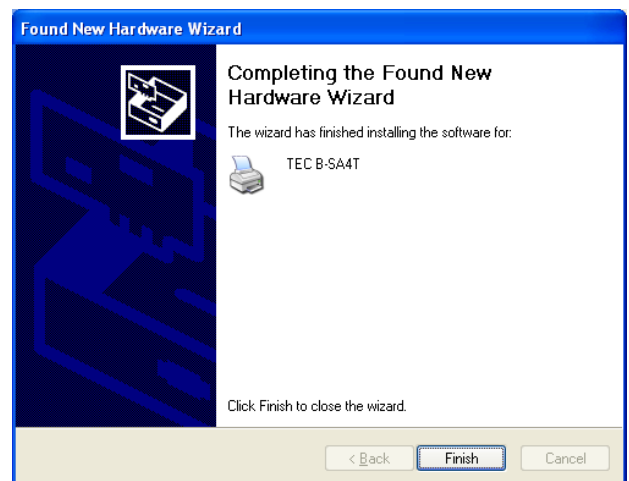

9. When the installation is completed, a new printer icon is added to the Printer folder.

**Note:** For other models than the B-SX4, B-SX4-CN, B-SX5, or B-SX5-CN, be sure to enable the bi-directional support after installing the printer driver. For details, refer to **Section 6.1 How to Enable Bi-directional Communication Support.**

## 2.9 Installation under Windows Vista/Server2008/7/Server2008R2 (Parallel Interface with Plug & Play Enabled)

**Note:** If an undefined device is created after installation of the printer driver, follow the procedure described in the section *If plug-and-play installation fails under Windows Vista/Server2008/7/Server2008R2*.

1. Connect the printer to the PC with a parallel interface cable.

2. Turn on the printer.

3. Set the printer parameters in the system mode.

**B-SX4, B-SX4-CN, B-SX5, and B-SX5-CN**

CENTRO. MODE → ECP

PLUG & PLAY → ON

**B-SA4G, B-SA4G-CN, B-SA4T, B-SA4T-CN, B-852-R, B-452-R, B-SX6T-R, B-SX8T-R, B-EX4T1-G, B-EX4T1-T, B-EX4T2-G, B-EX4T2-T, and B-EX4T2-H**

PLUG & PLAY → ON

**Note:** For the parameter setting procedure, refer to *Section 6.2 Parameter Setting on the Printer*.

4. Turn on the PC.

**Note:** Log on as the user with administrative privilege.

5. After the system is started, the installation of the device driver software is automatically started.

6. After a while, the installation of the printer driver is completed.

7. When the installation is completed, a new printer icon is added to the Printer folder.

**Note:** For the other models than the B-SX4T/SX5T, be sure to disable the bi-directional support after installing this printer driver. For details, refer to *Section 6.1 How to Enable Bi-directional Communication Support*.

## 2.10 Uninstalling the Printer Driver

### 2.10.1 To delete the printer drivers except for V6.5 Build75 and V6.5 Build77

In the following cases, be sure to uninstall the printer driver using the procedure below.

- When the same version is installed again.
- When an older version has been already installed.
- When the installation is canceled on the way or when the [No] is selected at a confirmation of the digital signature.
- When the printer driver cannot be installed for some reason.

**Notes:** 1. When installing the printer driver with Plug & Play enabled, turn OFF the printer first.  
2. When the printer driver is deleted, the information of the registered stocks and bar codes are also deleted. This information can be saved in a file beforehand by using the export function, and restored by using the import function after re-installation of the printer driver.

#### ● In the case of deleting the printer drivers except for V7.2.4 M-3

Before deleting the printer driver except for V7.2.4 M-3, follow the procedure described in **Section 2.1 Preparation for Installation**. Doing this causes the previously installed printer driver to be updated and creates the shortcut of the Driver Wizard in the TPCL Printer Driver of TOSHIBA TEC folder. However, it is not possible to update the printer driver which is older than V6.9.3 M-0. For such versions, first delete "C:\TEC\_DRV" folder, then conduct the Preparation for Installation. When the preparation is completed, the shortcut of the "Driver Wizard" is created in the TPCL Printer Driver folder.

#### ● In the case of deleting the printer driver of "To print on the shared printer (2)"

Before deleting the printer driver, delete the printer icon that was created when the shared printer was installed.

#### ● Uninstalling the printer driver

1. Select the "Start", "All programs", "TOSHIBA TEC", "TPCL Printer Driver", and "Driver Wizard".

**Note:** Log on as the user with administrative privilege. Exit the all Windows applications before performing the above operation. Confirm that there is no print job in the spooler, then close the spooler and the printer folder.

In the case of Windows Vista/Server 2008/7/Server2008R2, the User Account Control screen may appear. In that case, click the [Allow].

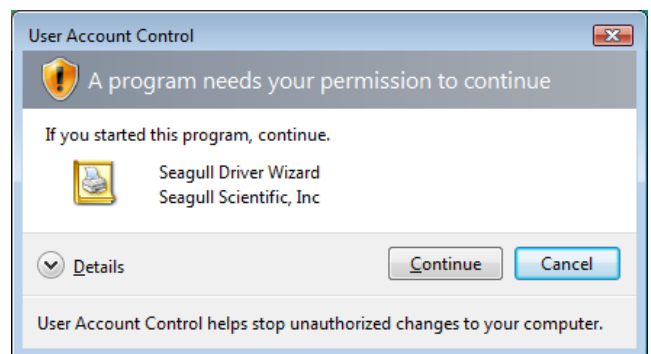



2. Select the “Remove printer drivers”, and click the [Next] button.

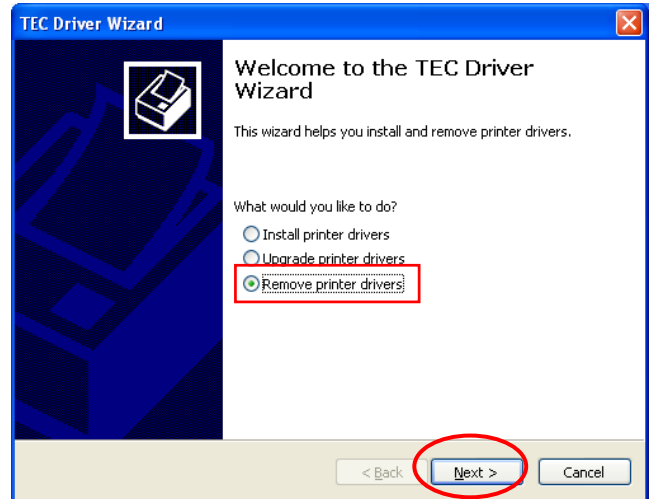

3. Select the “Automatically remove all TEC Printer Drivers”, and click the [Next] button.

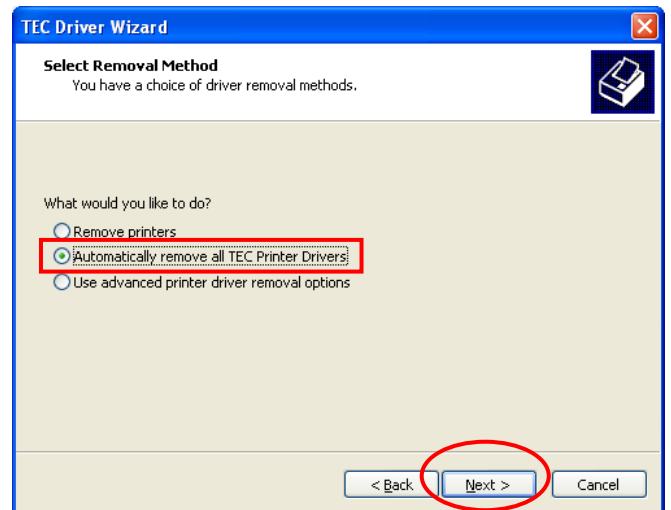

4. Click the [Finish] button to start to delete the printer drivers.

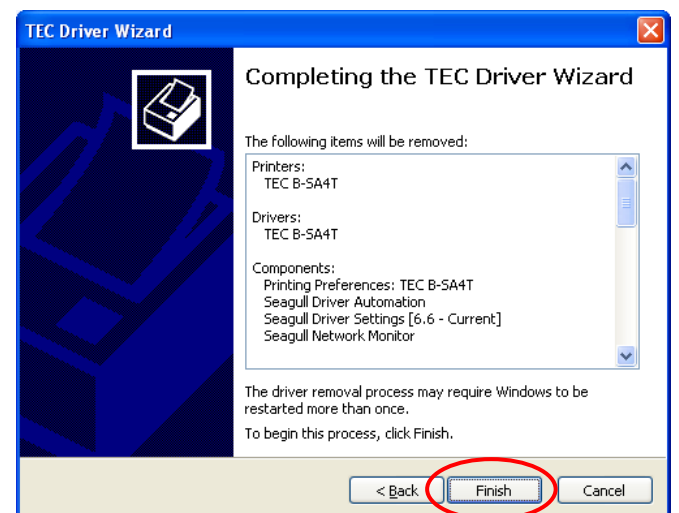

5. When the “Restart System” screen is displayed, click the [Restart] button.

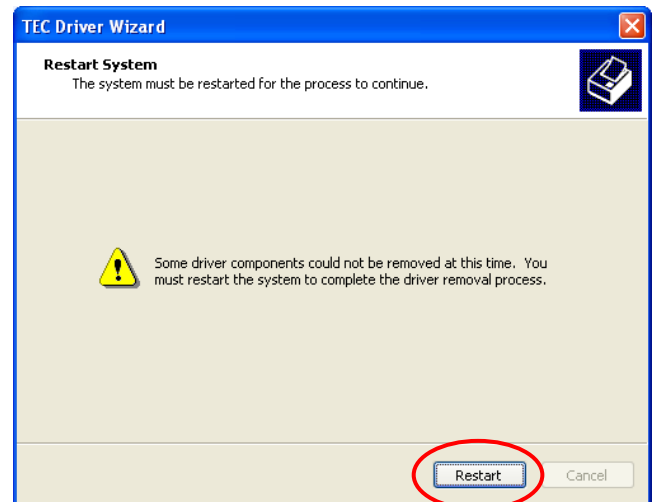

6. When the printer driver is deleted successfully, the screen on the right is displayed.

**Note:** If the deletion of the printer driver failed, retry from Steps 1 to 5 until the deletion succeeds.

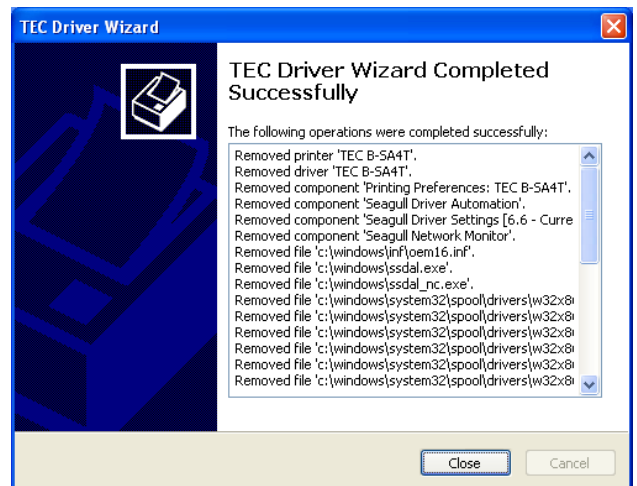

**Note:** When you deleted the printer driver from Windows Vista/Server2008/7/Server2008R2 and reinstall the printer driver again, follow the procedure described in *How to Setup Windows Vista/Server 2008/7/Server2008R2 again*.

In the case a network printer has been installed in multiple user accounts under Windows Vista/server 2008/7/Server2008R2, it is not possible to delete the printer driver. First, delete the printer icon from each user account, then delete the printer driver.

#### ● Deleting the setup information configured during the preparation

1. Select the “Start”, “Control Panel”, and “Add/Remove Programs”.  
**Note:** Log on as the user with administrative privilege.
2. Select the “TPCL Printer Driver Vx.x (version)” or “TEC Printer Driver Install file” from the list, then click the [Delete] button.
3. When the confirmation message is displayed, click the [Yes] button.
4. When the “Uninstall completed” screen appears, click the [Finish] button.

## 2.10.2 To delete the V6.5 Build75 or V6.5 Build77

1. Select the “Start”, “Control Panel”, and “Add/Remove Programs”.  
**Note:** Log on as the user with administrative privilege.
2. Select the “TEC \*\*\*\* printer” from the “Edit/Remove Programs”, and click the [Add and delete].  
(\*\*\*\* indicates a printer model name. For example, B-452, B-419, etc.)
3. Confirm that the selected file in the “File Delete confirmation” window is correct, then click the [Yes] button.
4. When “Uninstall completed” is displayed, click the [OK] button.  
**NOTE:** If you deleted the printer icon without performing Steps 1 to 4 above, delete the setup information through the “Add/Remove Programs” after re-installing the printer driver.
5. When the deletion is completed, reboot the PC.

## 3. Functions

You can set various functions of this printer driver in the “Properties” and “Printing Preferences”.

### ■ Property setting menus in the “Printing Preferences”

Right-click the printer icon, and select the “Printing Preferences”.

The following tabs are provided.

#### 3.1 Page setup

#### 3.2 Graphics

#### 3.3 Stock

#### 3.4 Options

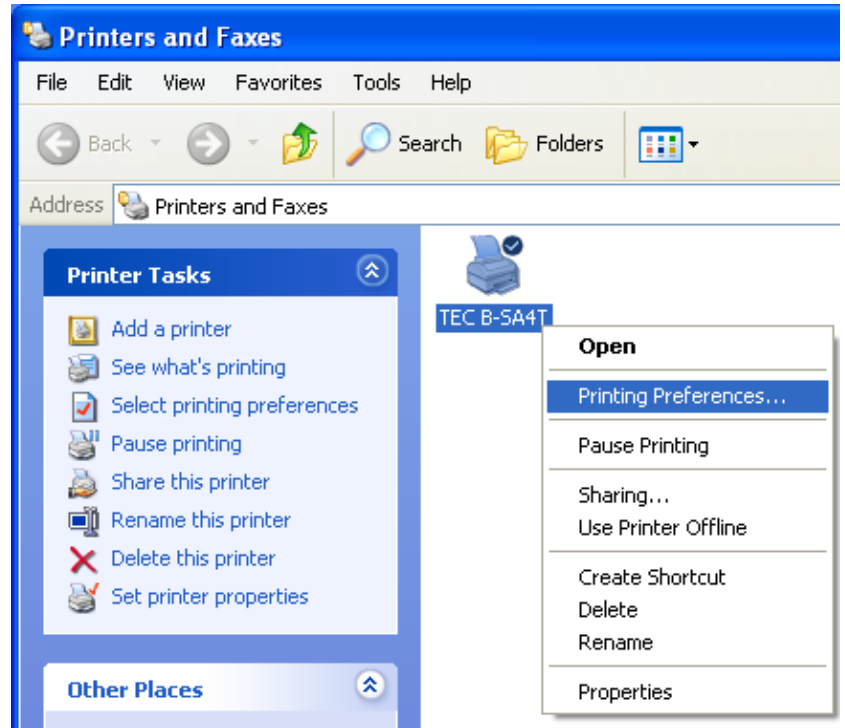

O: Fully supported. X: Use the default.

Function	Description	Support	
Page Setup tab	Stock	Allows configuring the size of the label stock and registering it with a name in advance.	O
	Orientation	Allows specifying the orientation of an image.	O
	Effects	<Mirror image> When enabled, the print will be a mirror image.	O
		<Negative> When enabled, the print will be white on black. When disabled, the print will be black on white.	
	Preset	Allows saving the settings of this printer driver such as fine adjustment values. When a preset setting file is selected, the current settings will be replaced by the settings of that preset file.	O
	Advanced Options		
Printing position tab	<Position Adjustment> Allows specifying the offset in horizontal and vertical directions.	X	
	<Default Orientation> Allows selecting the default print orientation between 0° (bottom first) and 180° (top first).	X	
User Commands tab	<User Commands> Allows setting the printer command to be sent at the start and the end of the job or at the start and the end of the label in the print job.	O	
	<Function character> Allows inserting binary data in bar code font.	O	

Function		Description	Support
	Driver Options tab	<Device Line Substitution> When enabled, the driver will try to use the printer's Line Commands to draw lines. When disabled, lines are drawn by using the Graphic Command.	○
		<Default Copies> Allows setting the number of copies to be printed as default. If the number of copies is not changed in the application, this value will be effective.	○
		<Disable Copies Limit> When enabled, a value exceeding "9999" can be set for the "Default Copies".	X
		<Disable User-Defined Paper Size> When this checkbox is checked, the user-defined paper size "USER" cannot be used.	X
Graphics tab	Resolution	Shows the printer's available resolution.	○
	Dithering	Allows creating the illusion of different shades of gray by varying the pattern of dots.	○
		<Color Adjustment> Allows the flip horizontal, flip vertical, rotation, color balance adjustment, etc.	○
		<Dithering Setup> Allows detailed setting for the selected dithering method.	○
	Color	<Color Control> Allows setting the color processing.	○
Stock	Media settings	<Print Method> Allows selecting whether the ribbon is used (thermal transfer) or not (Direct thermal).	○
		<Sensor> Allows selecting a sensor type used to detect a print start position.	○
		<Label Gap> Allows setting the length of the gap between labels.	○
	Issue Settings	<Issue Mode> Allows selecting whether the labels are issued in the strip mode.	○
		<Post-Print> Allows selecting whether the labels are issued in the cut mode. Note that the Pause is not supported.	○
		<Occurrence> Allows selecting the cutter operation and specifying how often labels should be cut.	○
		<Interval> Specifies the number of labels to be printed before a cut operation. The cutter will cut labels after the specified number of labels is printed.	○
		<Print Speed> Allows setting the print speed.	○
	Fine Adjustment	<Feed> Specifies the length of label that will feed after printing.	○
		<Backfeed> Specifies the length of label stock that is retracted before printing. This entry window is only available in cut or strip mode.	○
		<Cut/Strip> For the cut issue, specifies the length of label to feed before cutting the label. For the strip issue, specifies the length of label to feed before peeling the label.	○

Function		Description	Support
		<Print Shrinkage> Used to compensate for label print shrinkage or expansion.	○
Options tab	Graphic Options	<Transfer Mode> Allows selecting the method used to download graphics to the printer.	○
	Print Density Adjustment	<Direct thermal> Allows adjusting the print density for the direct thermal mode.	○
		<Thermal transfer> Allows adjusting the print density for the thermal transfer mode.	○
		<Optimization> Allows selecting the printer's optimization level from Quality, Balanced (middle), and Speed. This feature is provided only for the B-EP series.	○
	Feed Adjustment	<Feed Adjustment> Specifies the length of label to feed after printing (feed). Before a next printing is started, the label is fed in the reverse direction to the print start position.	○
	Supply Options	Allows setting the printing energy for each of the direct thermal and thermal transfer.	○
	Multiple Part Print Area	Allows specifying the duplicate printing area and the print density for that area. (B-419 and B-EV4 only)	○
	Ribbon Adjustments	Used to set the conditions related to the ribbon.	○
About tab	License	Shows the license information.	○
	Version	Shows the driver version, settings, and PC information. The shown information can be stored in a file.	○

## ■ Property setting menus in the “Properties”

Right-click the printer icon, and select the “Properties”.

### 3.5 Font

### 3.6 Tools

### 3.7 Printer font

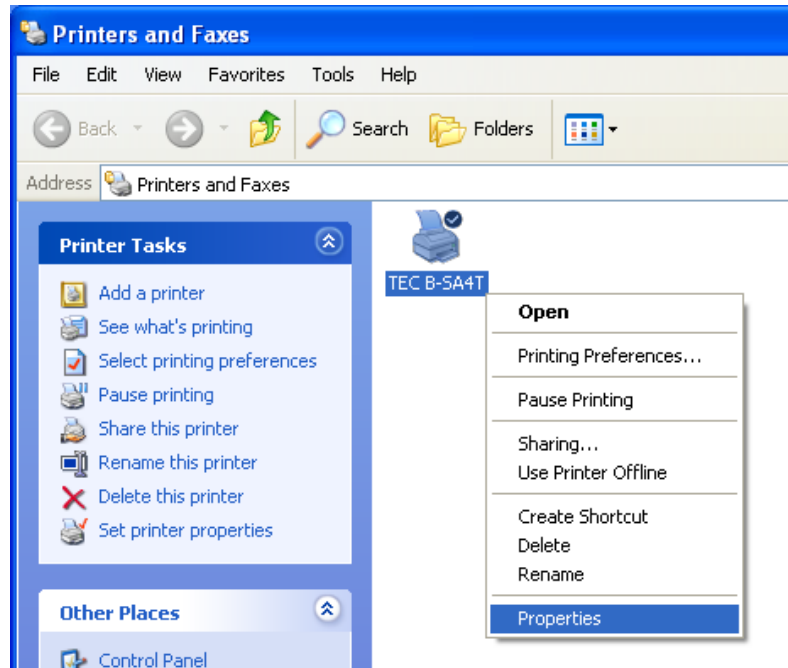

O: Fully supported. X: Use the default.

Function	Description	Support
Font tab	[Font] button	○
	[View] button	○
	[Tool] button	
Font settings [Resident Fonts]	<List Scalable Fonts> When selected, the scalable fonts are usable.	○
	<List Condensed and Expanded Widths> When selected, the fonts of which character width is condensed or expanded are usable.	○
	<List Specified Scale Factors> When selected, the fonts of which character width is scalable at any scale ratio are usable.	X
	<Percentages> Allows specifying the scale ratio.	X
	<List Bitmap Fonts> When selected, the bitmap fonts are usable.	○
	<Simulate Scalable Fonts> When selected, the bitmap fonts of same size with the outline fonts are specified.	X
	<List Magnifications> When selected, the magnified fonts are usable.	○
	<List Condensed and Expanded Widths> When selected, the fonts of which character width is condensed or expanded are usable.	○
	<List Multiple Character Set Fonts Separately> When selected, print fonts are printed with different code page.	X
[Utility Fonts]	<List Utility Fonts> When selected, the utility fonts are usable.	○
	<List Bar Code and RFID Fonts> When selected, bar code fonts and RFID fonts are usable. At present, RFID fonts are not supported.	○

Function		Description	Support	
		<List Printer Command Font> When selected, specified data are sent to the printer as they are.	○	
		<List Driver Command Font> When selected, the font which converts the data in the specified format into a command is usable.	X	
		<Combine Adjacent Bar Code & RFID Fields> When selected, the characters are combined if the same bar code font is specified for them.	○	
	[Encoding]	Allows specifying the method of encoding the data into bar codes.	X	
	Bitmap Font Settings	Refer to the Driver Option of the [Tool] tab.	---	
Tool tab	[Print]	Allows performing print tests.	○	
	[Action]	<Form Feed> The printer feeds one label.	○	
		<Cut> The printer cuts the label immediately.	○	
		<Read Printer Information> Shows the printer version and option information obtained from the printer.	X	
		<Manage XML Print Files> Allows managing the files of label formats, graphics, and fonts stored in the printer.	X	
		<Reset Printer> Resets the printer.	○	
		<Test Print Head> Allows execution of the printer's broken element test.	○	
		<Send Printer Command> Sends the generated printer commands to the printer. When the bi-directional communication is enabled, the printer status is obtained and shown after sending the commands.	○	
		<Send File To Printer> Sends the command file to the printer.	○	
		[Configure] Printer Options	<Automatic Status Response> When selected, the printer status is automatically sent at the end of a job or the occurrence of an error.	○
			<Include Job Information> When selected, the job information obtained from the printer via SNMP is included in the print job.	○
	<Check Command Sequence> When selected, a command, which checks whether any command is missing from a command string the printer received, is attached.		○	
	<Command Protocol> Specifies the command control code.		○	
	<Auto Feed Setting> Allows selecting whether to enable or disable the auto feed feature.		○	
	<Configure memory> Allocates the built-in or expanded memory of the printer.		○	
	<Format memory> Formats the specified area of the flash memory.		○	
	<Ribbon Setting> Allows setting the fine adjustment for the ribbon motor voltages.		○	
	[Driver Options]			



Function		Description	Support
	Administration	<Import and Export> Allows importing previously saved printer driver settings and exporting the settings of this printer driver.	○
	Network settings	<Network Setting> When the shared printer is installed as a network printer, the setting or status information can be shared between the server and the client.	X
	Regional Options	<Language> Allows selection of the desired language to be used in the printer driver property screens.	○
		<Units> Allows the selection of the desired units of measurement.	○
		<Windows Setting> Displays the “Regional and Language Options” of Windows.	○
	Printer Specifications	<Unprintable width> Specifies the unprintable area.	X
		<Model Specifications> Specifies the resolution, stock size, etc. for the printer model to be used.	X
	[Logging Options]	<Logging> Allows logging printed pages and jobs debugging purposes.	○
		<Printer Code Recording> Allows recording the command data of the print jobs to files.	○
	[Status Monitoring]	<Printer Status Monitoring> Allows selecting the printer status monitoring method.	○
		<Status Display Option> Allows setting the properties of the status monitor.	○
		<Job Verification> Allows selecting the timing of status monitoring.	X
		<Communication> Allows setting the timeout and polling interval.	X
	About tab	License	Shows the license information.
Version		Shows the driver version, settings, and PC information. The shown information can be stored in a file.	○

**Reference:**

A part of the above settings can be changed in the print dialog box of the application, but such changes may only temporary take effect.

## 3.1 Page Setup Tab

Clicking on the Page Setup tab allows you to specify the default media size, orientation, and other properties of the media.

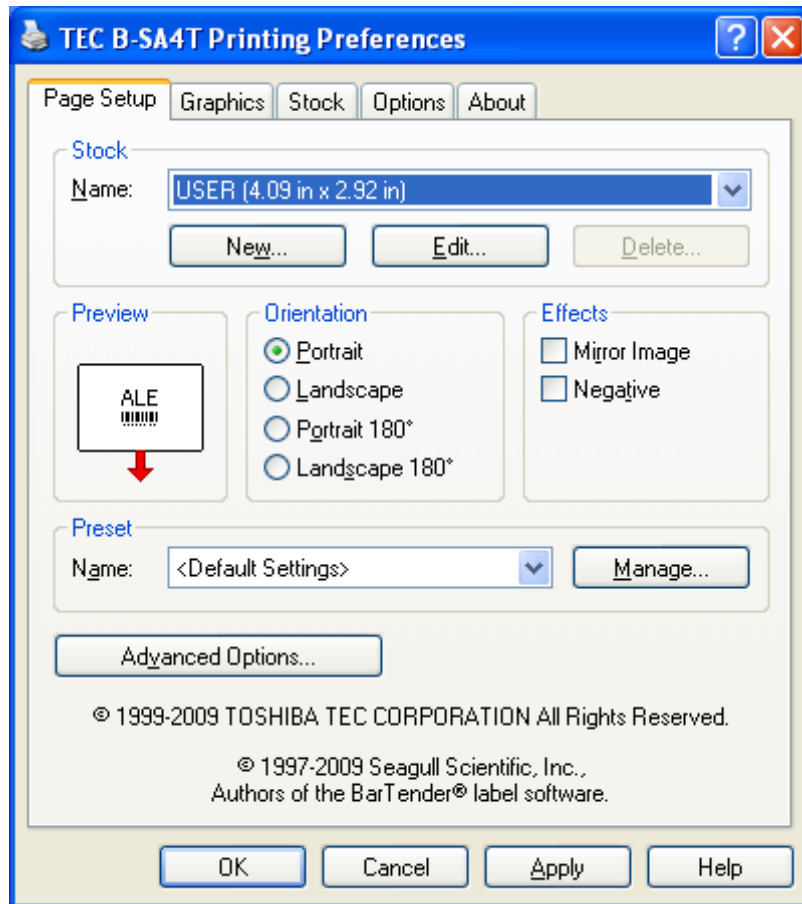

**Note:** When printing on the shared printer, specify the orientation and media size on the client PC from which a print job is sent. Even if the media size and the orientation are registered to the shared printer, it is not possible to share such information with the client PC.

### ■ Stock

#### • Name

Allows specifying a previously loaded stock by name to use, modify, or delete.

#### • New, Edit, Delete

Allows adding a new label stock specification to the list, editing or deleting a label stock already on the list.

☞ **Section 3.1.1 Registering a new stock or editing the existing stock.**

The number of registerable stocks is unlimited.

### ■ Orientation

By clicking on the "Portrait", "Landscape", "Portrait rotated 180°", or "Landscape rotated 180°" radio button, the print orientation can be changed. The preview page to the left of the orientation buttons will change to reflect the selected orientation.

Depending on the printer models, the orientation of the "Portrait" may differ.

## ■ Effects

- **Mirror Image**

When this checkbox is checked, the print will be a mirror image.



- **Negative**

When this checkbox is checked, the print will be white on black.



Depending on the printer models, the selectable options differ.

## ■ Preset

Allows saving the settings of this printer driver so that they may be imported into a different or freshly installed printer driver.

☞ **Section 3.1.2 Preset**

### 3.1.1 Registering a new stock or editing the existing stock

By clicking either the [New] button or the [Edit] button, the following screen will appear.

To register a new stock, click the [New] button and enter the stock name and the size.

To edit the label stock already on the list, click the [Edit] button. The changes will be applied to the other printer drivers' stock information.

## ■ Stock

- **Name**

Displays the stock name. When a new stock is registered, any stock name can be set. (2-byte characters are acceptable.)

- **ID**

Displays the ID for the stock being edited. (257 to 32767)

Change the stock ID if mismatching in the stock IDs between the older printer driver and the new one causes an error. For example, when printing is performed from the application which manages stock types for Excel, Access, etc. by their stock IDs assigned by the older printer driver, a wrong stock may be selected even though the correct one has been registered.

## ■ Label Size

### • Width, Height

Specifies the height and width of a label stock size.

## ■ Exposed liner width

### • Left, Right

Specifies the distance between the edges of the paper backing and the edges of the label. (Set the same value for the left and right.)

**Note:** For the B-SP2D, B-419, and B-431 models, set the both exposed liner widths to 0 mm. Instead, set the label width to the 'effective print width + left and right exposed liner widths'. Adjust the print position on the label format with the application.

## ■ Automatic Preset Selection

### • Selecting stock loads settings from preset

Specifies whether to designate preset print settings for the selected stock.

However, this feature is unavailable and invisible unless a preset setting file has been registered. When invisible, the printer behaves in the same way when this feature is unselected.

When this checkbox is unchecked, printing is performed according to the current settings, regardless of the stock type.

When checked, printing is performed based on the preset settings designated for each stock type.

<Procedure>

- (1) Set the print settings, such as sensor fine adjustment and print density adjustment, for the selected stock, and save them as a preset setting file. (☞ **3.1.2 Preset.**)
- (2) Check the "Selecting stock loads settings from preset" checkbox, and select the created preset file from the list.
- (3) When a stock for which a preset has been designated is used, the print settings saved in such preset file are called and reflected in printing.

**Note:** When this feature is used under the condition more than one stock type is used in turns, designate a preset for each stock type to be used one by one.

Presets need to be created for each printer driver. Since the stock types are shared among different printer drivers, care must be taken not to designate different presets for the same stock type registered to each printer driver.

Be sure to create a preset and stock type in pairs for each printer driver.

In the case of the standard stock types, the preset settings are not succeeded with the import/export functions. Therefore, it is necessary to register the preset settings again after exporting.

### 3.1.2 Preset

By clicking the [Manage] button in the Page Setup page, the following screen display will appear to allow you to manage the printer settings with a name.

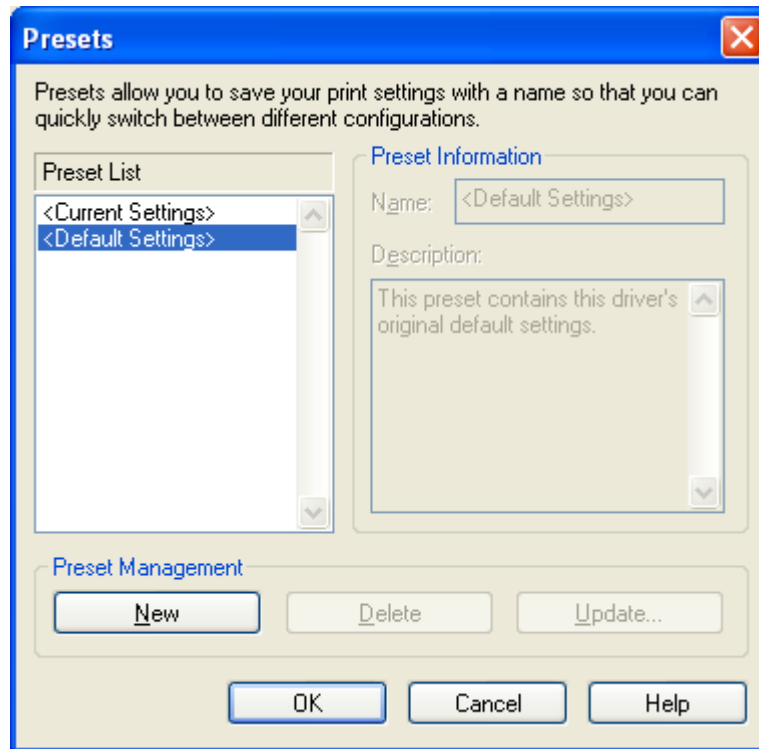

#### ■ Preset Management

##### • New

After configuring the necessary print settings for a selected stock, click the [New] button, name these print settings to manage them as a preset, and enter a description of these settings in the “Description” box. Click the [OK] button to save.

Settings saved:

[Page Setup] tab:	Label size
	Orientation
	Effects
	Advanced setting
[Graphics] tab	Dithering
[Stock] tab	Print method
	Issue mode
	Print speed
	Fine adjustment
[Option] tab	Graphic options
	Print density adjustment
	Feed adjustment
	Multiple Part Print Area Settings
	Ribbon Adjustments

##### • Delete

Clicking the [Delete] button enables deletion of a selected preset name. When the [OK] button is clicked, the changes are saved.

##### • Update

To reflect the changes in the settings of the existing preset, select the preset name and click the [Update] button. When the [OK] button is clicked, the changes are saved.

### 3.1.3 Advanced Options

Clicking the [Advanced Options] button allows control of the printer options for which the printer driver does not provide explicit control.

#### ■ Printing Position

##### ◆ Position Adjustment tab

- **Horizontal Offset**

Enables adjustment of the print position in the horizontal direction.  
Since this feature is not supported, do not change the default setting.

- **Vertical offset**

Enables adjustment of the print position in the vertical direction.  
Since this feature is not supported, do not change the default setting.

##### ◆ Orientation Adjustment

- **Default Orientation**

Enables specifying the default orientation.

0°: Bottom first

180°: Top first

Since this feature is not supported, do not change the default setting.

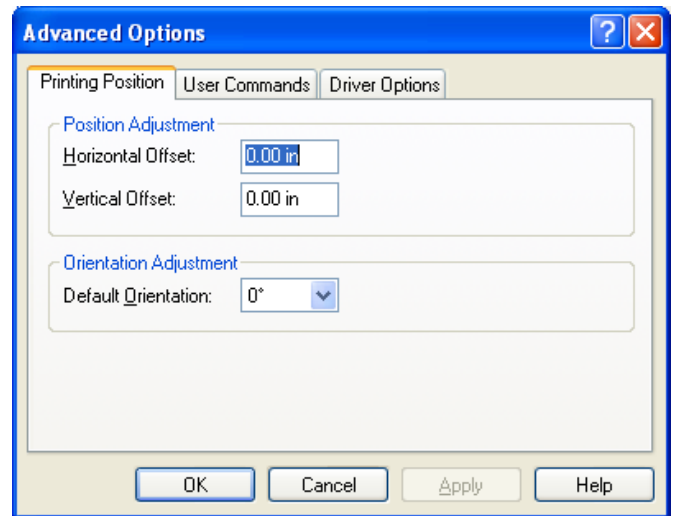

#### ■ User Commands tab

You can program printer command strings which are to be sent to the printer at “Start of Job”, “Start of Label”, “End of Label” or “End of Job” to make up for the functions that cannot be covered by this printer driver.

**Supplement:** For details of the commands, please refer to the External Equipment Interface Specification.

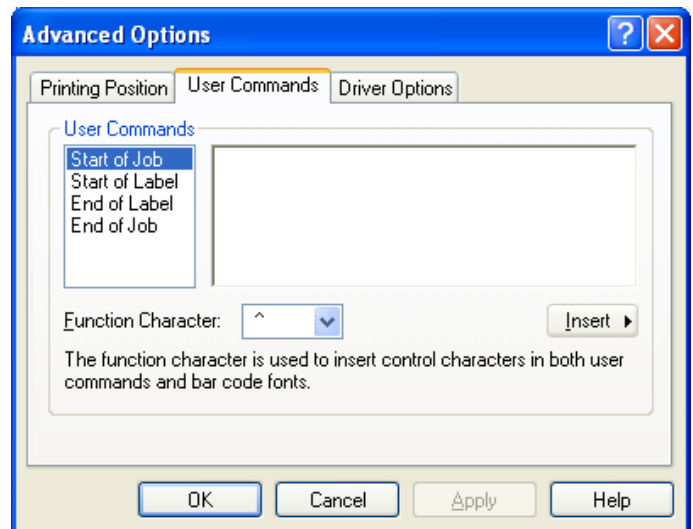

• **Function Character**

When a bar code font is used for printing, use of the function character enables encoding binary data. The default setting is a caret [^] (5EH).

The following explanation is based on an assumption that the caret [^] (5EH) is used.

Entry in hex. format

^#nn

<Example> To specify binary data of 00 to 06:

^00^01^02^03^04^05^06

Entry with abbreviation

^<ccc>

<Example> To specify binary data of 00 to 06:

^<NUL>^<SOH>^<STX>^<ETX>^<EOT>^<ENQ>^<ACK>

Entry of the function character

When using the function character as bar code data, send the function character twice.

^^

Binary data

<NUL> 00	<DLE> 10
<SOH> 01	<DC1> 11
<STX> 02	<DC2> 12
<ETX> 03	<DC3> 13
<EOT> 04	<DC4> 14
<ENQ> 05	<NAK> 15
<ACK> 06	<SYN> 16
<BEL> 07	<ETB> 17
<BS> 08	<CAN> 18
<HT> 09	<EM> 19
<LF> 0A	<SUB> 1A
<VT> 0B	<ESC> 1B
<FF> 0C	<FS> 1C
<CR> 0D	<GS> 1D
<SO> 0E	<RS> 1E
<SI> 0F	<US> 1F
	<DEL> 7F

■ **Driver Option tab**

◆ **Device Line Substitution**

• **Enable Substitution**

This option allows selecting whether or not to substitute a line drawn in a print image with a Line Command.

When this checkbox is not checked, the line is processed as a Graphic Command.

When checked, the line is drawn using the printer's line drawing function, which may result in higher throughput.

• **Minimum Length**

The minimum length of a line that is to be recognized as a Line Command. The line shorter than this value is processed as a Graphic Command.

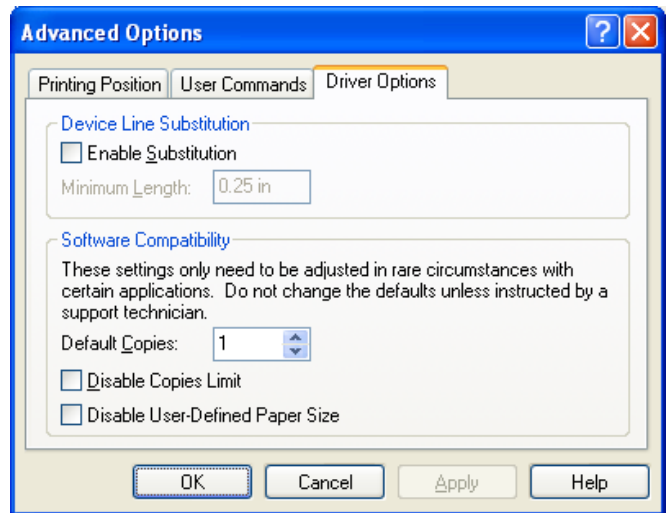

**Note:** Some applications do not always print correctly with this feature enabled. In such case, remove the check from the check box.

◆ **Software Compatibility**

• **Default Copies**

The number of labels to be printed as default. Unless this number is changed with the application, this value will be effective.

- **Disable Copies Limit:**

When this checkbox is checked, a value greater than 9999 can be set for the Default Copies. Since this feature is not supported, do not change the default setting.

- **Disable User-Defined Paper Size:**

This feature disables the user-defined paper size "USER". When this checkbox is checked, "USER" cannot be used. Since this feature is not supported, do not change the default setting.



## 3.2 Graphics Tab

Clicking the Graphics tab enables adjustment of dithering or color tone.

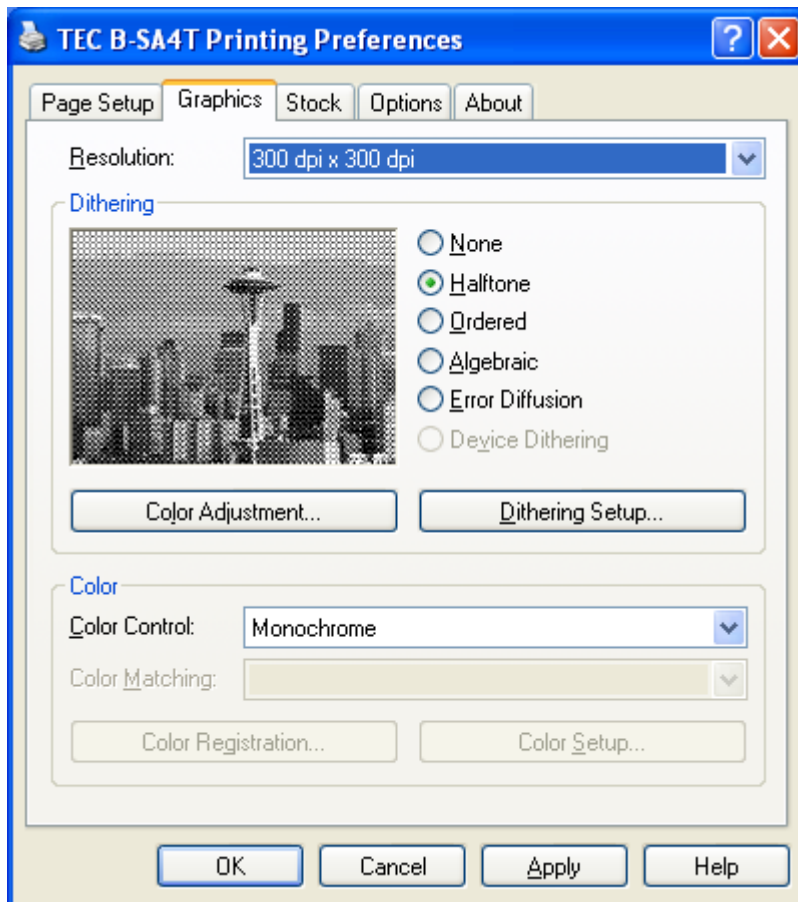

### ■ Resolution

Enables selecting the print head resolution. Only the resolutions supported by the printer model can be specified.

### ■ Dithering

Enables creating the illusion of different shades of gray by varying the pattern of dots. The more dither patterns that a device or program supports, the more shades of gray it can represent.

- None
- Halftone
- Ordered
- Algebraic
- Error Diffusion

When the [Dithering Setup] button is clicked, you can select an algorithm from multiple options. The algorithm differs according to the dithering patterns.

### ■ Color Control

Enables selecting whether to print monochrome or color.

### 3.3 Stock Tab

Clicking the Stock tab allows setting various print conditions specific to the printer, such as the media settings, issue settings, and fine adjustments.

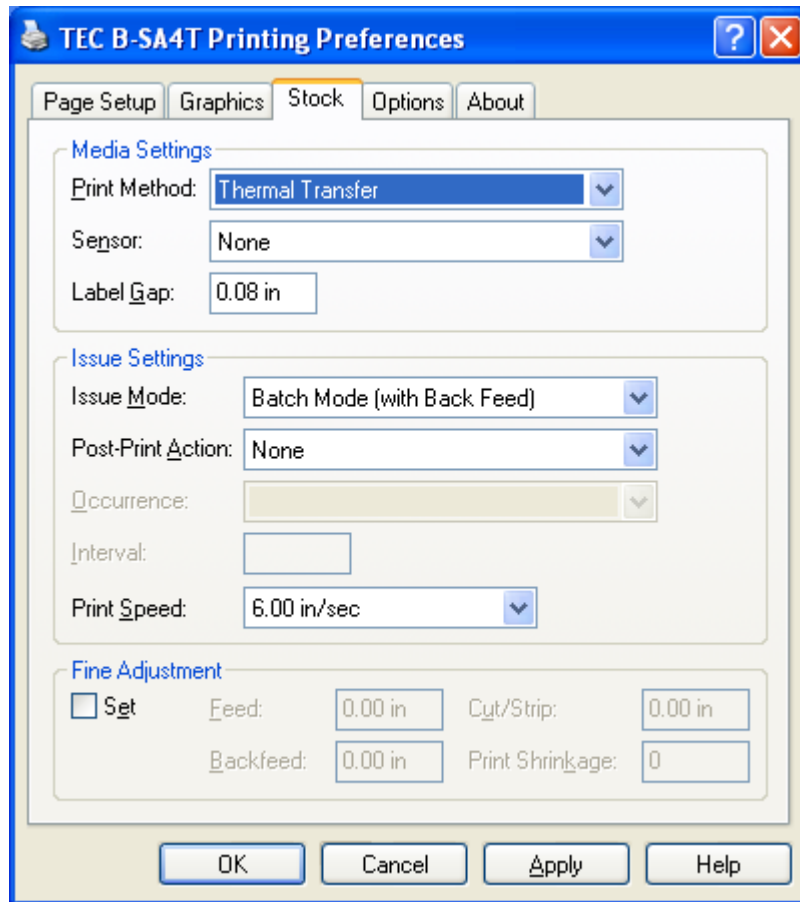

#### ■ Media Settings

##### • Print Method

Enables selecting the print method.

- Direct thermal
- Direct thermal (Head up)
- Thermal transfer
- Thermal transfer (Ribbon save)

The “Thermal transfer (Ribbon save)” is available only to the printer supporting the ribbon saving function.

The “Direct thermal (Head up)” is available only to the RFID-enable printer. The print head is lifted to avoid RFID tag embedded area to protect the RFID tag. If you select the “Direct thermal (Head up)” for non RFID-enable printer, an error occurs on the printer.

- **Sensor**

Enables selecting a sensor type.

- None
- Reflective
- Transmissive
- Transmissive (Manual Threshold)
- Reflective (Manual Threshold)
- Transmissive (Clothing Tags)
- Lower Reflective (Black mark on the reverse side)
- Lower Reflective (Manual Threshold)
- Upper Reflective (Black mark on the print side)
- Lower Reflective (Punch hole)

Select the “Transmissive (Preprinted Labels)” or “Reflective (Manual Threshold)” when the threshold has been set through the key operation in the printer system mode.

The “Transmissive (Clothing Tags)” is available only to the B-431.

The “Lower Reflective (Black mark on the reverse side)”, “Lower Reflective (Manual Threshold)”, “Upper Reflective (Black mark on the print side)”, and “Lower Reflective (Punch hole)” are selectable for the B-852 or B-852R.

- **Label Gap**

Enables setting the inter-label gap size. In the case of tag paper, enter the non-printable area size.

## ■ Issue Settings

- **Issue Mode**

- Batch Mode (with Back Feed)
- Strip Mode (with Back feed)
- Strip Mode (when using the applicator)
- Partial Cut (without Back Feed)
- Batch Mode
- Cut Mode

When the cutter unit is installed on the printer to perform the cut issue, select the “Batch Mode (with Back Feed)” or the “Cut Mode”.

When the strip module is installed on the printer to perform the strip issue, select the “Strip Mode (with Back Feed)” or the “Strip Mode (when using the applicator)”.

When the “Partial Cut (without Back Feed)” is selected, this option will be always specified.

- **Post-Print Action**

Enables selecting whether the cut operation is performed or not.

- None
- Cut
- Partial Cut
- Cut and Pause
- Pause (This is not supported.)

When the “Partial Cut” is selected, the “Partial Cut (without Back Feed)” will be always set for the Issue Mode.

The “Cut and Pause” and “Pause” are not supported at present.

**• Occurrence**

Enables specifying how often labels should be cut. If the “Strip Mode (with Back Feed)” is selected for the Issue Mode, this feature is disabled.

- After every page -----Cuts labels after each label is finished printing.
- After specified interval -----Cuts labels after the number of labels specified in the Interval setting.
- After specified interval (Per Page)-----Cuts labels after the number of labels specified in the interval setting and at the end of the identical copy.
- After identical copies -----Cuts after the identical copy is finished printing.
- After job -----Cuts labels only after the entire print job is finished printing.
- After specified interval-----If the special printer control (partial cut, etc.) is required, cuts labels after (depending on printers) the number of labels specified in the Interval setting.

Example: 4 pages are issued by 5 copies each

	Cut Interval	▲: Cut operation
Every page	---	1▲1▲1▲1▲1▲2▲2▲2▲2▲2▲3▲3▲3▲3▲3▲4▲4▲4▲4▲4▲
Specified interval	3	1 1 1▲1 1 2▲2 2 2▲2 3 3▲3 3 3▲4 4 4▲4 4▲
Specified interval (Per page)	3	1 1 1▲1 1 2▲2 2 2▲2 3 3▲3 3 3▲4 4 4▲4 4▲
Identical copies	---	1 1 1 1 1▲2 2 2 2 2▲3 3 3 3 3▲4 4 4 4 4▲
After job	---	1 1 1 1 1 2 2 2 2 2 3 3 3 3 3 4 4 4 4 4▲
Specified interval (depending on the printers)	3	1 1 1▲1 1 2▲2 2 2▲2 3 3▲3 3 3▲4 4 4▲4 4▲

**• Interval**

Enables specifying the cut interval.

**• Print Speed**

Enables specifying the print speed. Selectable speed differs according to the printer models.

**■ Fine Adjustment**

**• Set**

When the “Set” checkbox is checked, you can set fine adjustment values. When not checked, the adjustments are grayed out and the printer operates according to its current settings.

Adjustable settings differ depending on the printer models.

- Feed
- Backfeed
- Cut/Strip
- Print Shrinkage

**• Feed**

Specifies the length of label stock that will feed after printing.

**• Backfeed**

Specifies the length of label stock that is retracted before printing.

**• Cut/Strip**

In the case of the cut issue, this specifies the length of label to feed before cutting the label. In the case of the strip issue, the length of label to feed before peeling the label is specified.

**• Print Shrinkage**

Used to compensate for label print shrinkage or expansion.

## 3.4 Options Tab

Models other than B-EP2DL-G and B-EP4DL-G

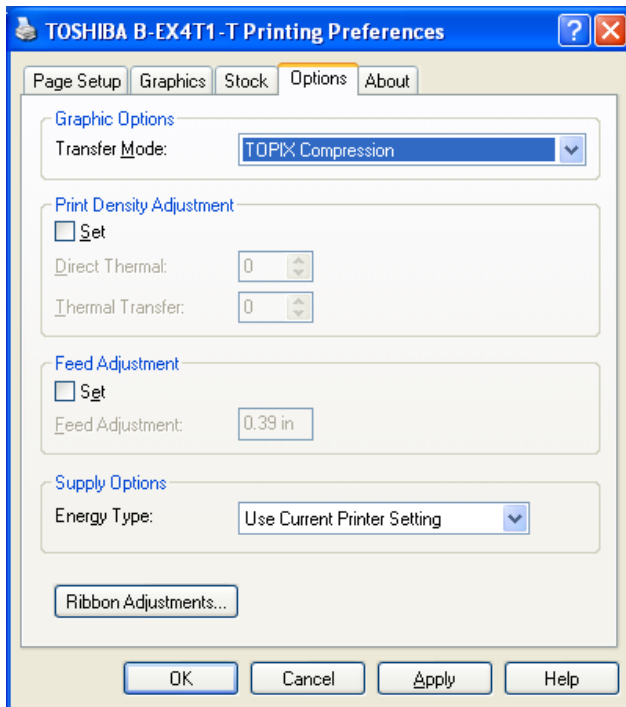

B-EP2DL-G and B-EP4DL-G

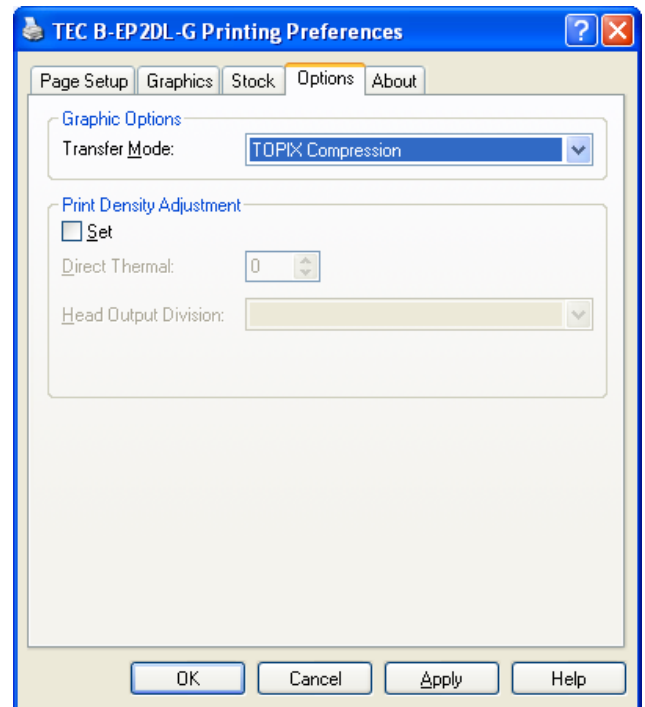

### ■ Graphic Options

#### • Transfer Mode

Allows selecting the method used to download graphics to the printer. Basically, select the “TOPIX compression” mode.

For the models which are not supporting the TOPIX compression mode, select “Uncompressed 8-bit (overwrite)”.

The “TOPIX compression (XOR)” method improves the throughput by processing only a different part from the previous page. Choose this option when you print a fixed format partly including variable data.

However, the throughput may not improve depending on the image to be printed.

#### Printer models supporting the TOPIX compression mode

- B-372 ROM version V2.4 or later
- B-472 ROM version V2.4 or later
- B-872 ROM version V1.3 or later
- The all versions of the other models than above.

### ■ Print Density Adjustment

When the “Set” checkbox is checked, you can set the print density (print head voltage) for each of the Direct thermal and Thermal transfer.

When not checked, the printer operates according to its current setting.

For the B-EP2DL-G and B-EP4DL-G, the “Head Output Division” feature is provided, which enables properly changing the print quality and print speed depending on the selected print head control. When the “Set” checkbox is not checked, the printer operates according to its current setting.

### ■ Feed Adjustment

When the “Set” checkbox is checked, you can set the length of the label the printer automatically feeds after printing. Before printing the next label, the printer will automatically feed the label in the reverse direction to the print start position.

When not checked, the printer operates according to its current setting.

This feature is not available to the B-419, B-SP2D, B-EP2DL-G, and B-EP4DL-G.

## ■ Supply Options

Allows setting the printing energy for each of the “Direct thermal” and “Thermal transfer”. When “Use Current Print Setting” is selected, the printer operates according to the currently selected setting. Selection of “Direct thermal” or “Thermal transfer” depends on which is selected for the “Print Method” on the Stock page.

## ■ Ribbon Adjustments

When the thermal transfer method is selected, setting the conditions related to the ribbon is allowed.  
(☞ 3.4.2 Ribbon Adjustments.)

## ■ Multiple Part Print Area Settings

Enables setting the duplicate print area on double-layer thermal paper. This feature is available only to the B-419 and B-EV4-G. For the B-EV4-G, “Variable Speed A” or “Variable Speed B” specified for the “Print Speed” on the Stock page is reflected in the printer behavior.

### 3.4.1 Multiple Part Print Area Settings (B-419 and B-EV4-G only)

Clicking the “Multiple Part Print Area Settings” button on the Options page enables setting the duplicate print area properties for the double-layer thermal paper.

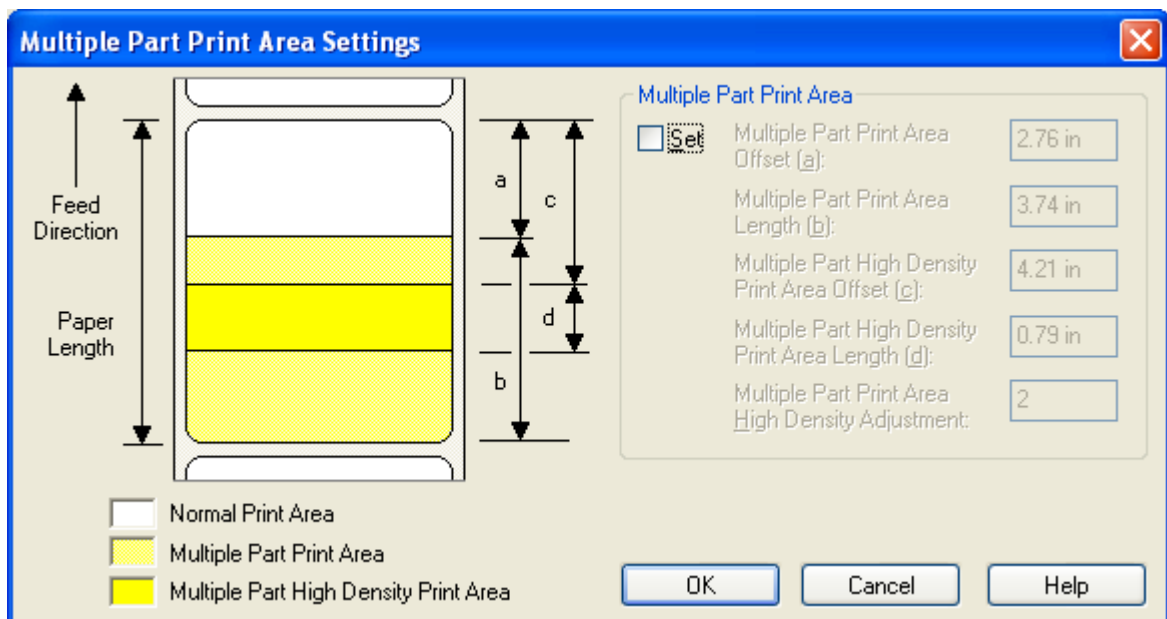

## ■ Multiple Part Print Area

When the “Set” checkbox is checked, you can specify the details of the “Multiple Part Print Area”. The “Multiple Part Print Area” is the area where the printer prints both sheets of the double-layered thermal paper at the same time by applying the higher print energy. When not checked, the printer operates according to its current settings.

### • Multiple Part Print Area

Enables setting the “Multiple Part Print Area Offset (a)” (X-coordinate of the multiple part print area start position) and “Multiple Part Print Area Length (b)”. The print on the specified area will become darker than the normal print areas.

- Multiple Part Print Area Offset: 0.0mm to 390.0 mm
- Multiple Part Print Area Length: 0.0mm to 390.0 mm

• **Multiple Part High Density Print Area**

Enables setting the “Multiple Part High Density Print Area Offset (c)” (X-coordinate of the multiple part high density print area start position) and “Multiple Part High Density Print Area Length (d)”.

This area is to be printed with much higher print energy than the multiple part print area to enable clearly printing small or fine characters and bar codes on the second sheet. The extra energy level can be specified by entering a value in the “Multiple Part Area High Density Adjustment” box. (If the “Multiple Part Area High Density Adjustment” is set to “0”, which means no difference, and both areas are printed with the same print density.)

- Multiple Part High density Print Area Offset: 0.0mm to 390.0mm
- Multiple Part High density Print Area Length: 0.0mm to 390.0mm

• **Multiple Part Print Area High Density Adjustment**

Enables specifying how much extra energy is applied for the “Multi Part Print High Density Area” than the “Multiple Part Print Area”.

- Multiple Part Print Area High Density Adjustment: 0 to 10

**Supplement:**

1. Duplicate printing is available only to double-layer thermal paper. Triple- or more layer paper is not accepted.
2. If the print on the second sheet is too light, specifying this print area as a Multiple Part High Density Print Area. Doing this improves the print result.
3. It is possible to specify a Multiple Part Print Area and a Multiple Part High Density Print Area independently.
4. It is not necessary to specify both the Multiple Part Print Area and the Multiple Part High Density Print Area.
5. The Multiple Part High Density Print Area is not necessarily within a Multiple Part Print Area.
6. The Print Density Adjustment value, set in the Options page, is reflected in the Multiple Part Print Area a Multiple Part High Density Print Area.

• Print density of normal print area =

• Print density for the Multiple Part Print Area =  +

• Print density for the Multiple Part High Density Print Area =  +  +

: Print density adjustment value

: Standard print density for the Multiple Part Print Area

: Fine adjustment value for the Multiple Part High Density Print Area

### 3.4.2 Ribbon Adjustments

Clicking on the [Ribbon Adjustments] button on the Options page enables ribbon settings.

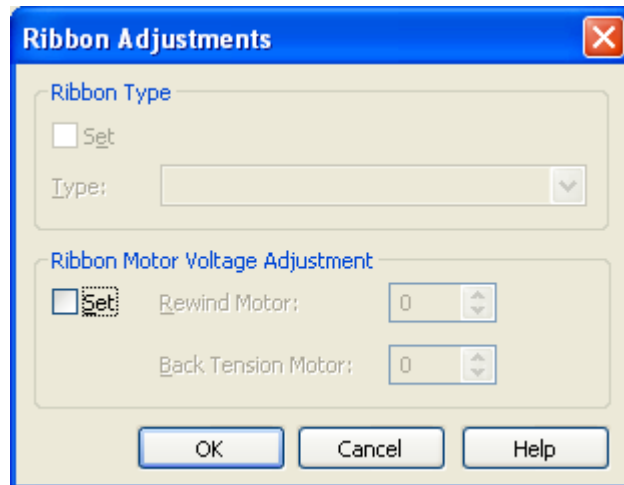

#### ■ Ribbon Type

When the “Set” checkbox is checked, configurations related to the ribbon is allowed. When unchecked, the printer operates according to the currently selected settings.

This menu is provided only to the models for which a ribbon type is selectable.

#### • Type

Enables selecting a ribbon type used on the printer. Selectable ribbon types are different depending on the printer model.

#### ■ Ribbon Motor Voltage Adjustment

When the “Set” checkbox is checked, the ribbon motor voltage can be adjusted for preventing ribbon wrinkles. When unchecked, the printer operates according to the currently selected settings.

#### • Rewind Motor

The rewind motor which drives the ribbon take-up core takes up the used ribbon.

When the value is reduced, the rewind motor torque turns down, causing a decrease in the ribbon tension. The setting value range varies depending on the printer model.

#### • Back Tension Motor

The back tension motor which drives the ribbon feed core pulls the ribbon backward to maintain the ribbon tension.

When the value is reduced, the back tension motor torque turns down, causing a decrease in the ribbon tension. The setting value range varies depending on the printer model.



## 3.5 Fonts Tab

Clicking the Fonts tab of the Properties screen enables adding, deleting, modifying, importing, exporting, and viewing currently defined bar code fonts. These fonts will be listed in many Windows applications that normally do not support printing bar codes. Although they will not appear as bar codes on the screen, they will print as bar codes. An unlimited number of bar fonts can be created, each of which may have different bar code parameters.

### Notes:

- Bar code fonts need to be registered to each printer driver.  
In the case you print on a shared printer, register bar code fonts to both the client PC and the printer server PC. It is not possible to share the bar code fonts between the client PC and the printer server PC.  
The Import and Export features are useful to easily register the bar code font list to other printer drivers. Refer to **Driver Options**.
- To use Kanji as bar code font, click the [Tools] tab, [Configure] button, select "Printer Options", and set the "ESC/LF/NUL" for the Control Codes.

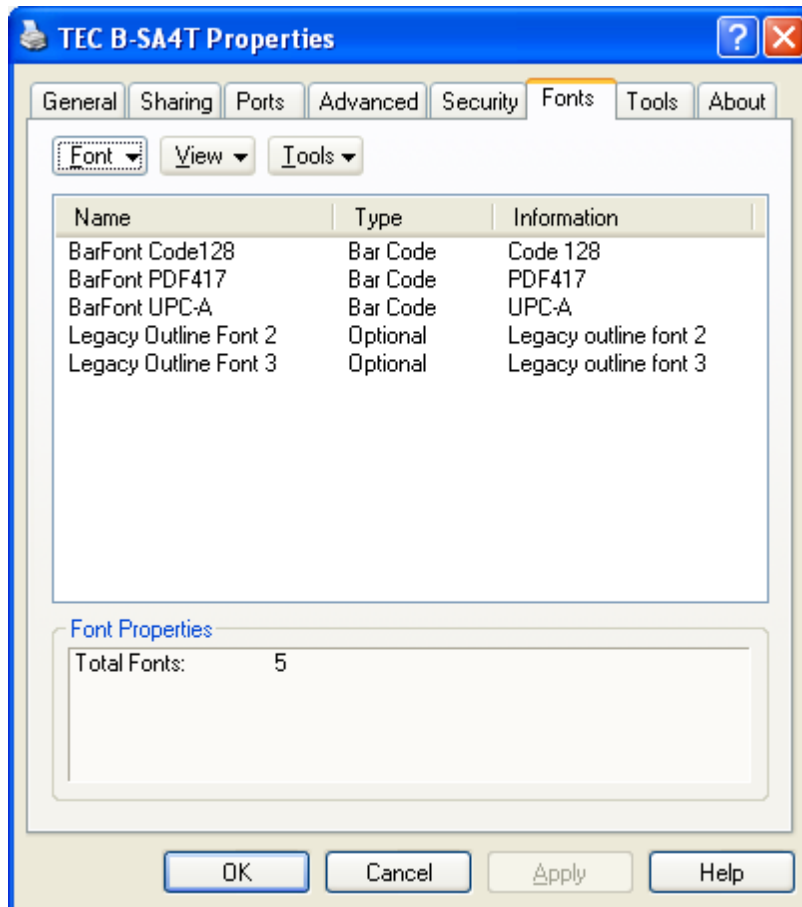

### ■ Font

Enables adding, deleting, and editing the bar code fonts.



#### • New Bar Code Font

Enables adding a new bar code font to the list. There is no limit for the number of bar code fonts to be registered.

☞ Refer to **Section 3.5.1 Bar Code Font**.

#### • Edit

Enables modifying the currently selected bar code font.

Select a bar code font and open the "Bar Code Font" screen by clicking the [Font] button and the "Edit" or right-clicking the font and selecting the "Edit".

- **Delete**

Enables deleting the currently selected bar code font.

Select a bar code font, then click the [Font] button and the “Delete” or right-click the font and select the “Delete”.

- **View**

Enables filtering the bar code font types to display. “Resident Fonts” and “Bar code fonts” are available.



**Supplement:** The bar code font list on the [Fonts] page only shows the font types usable by the applicable printer driver. Bar code fonts registered to other printer driver installed in the same PC are not displayed.

- **Tools**

Enables setting the resident fonts and the printer driver options.

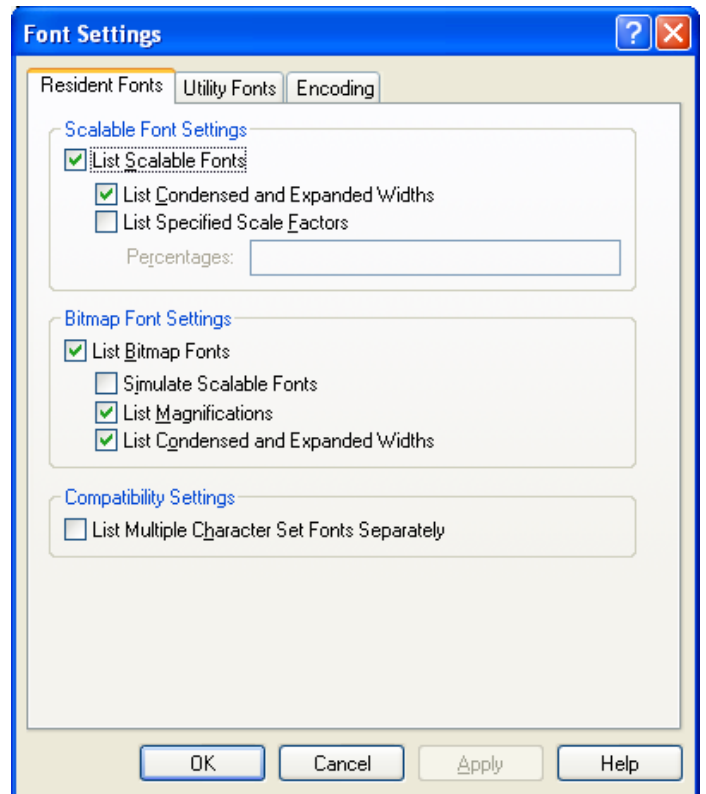

- ◆ **Resident Fonts tab**

- **Scalable Font Settings**

**List Scalable Fonts:** When this checkbox is checked, the scalable fonts (outline fonts) can be used on the application. When not checked, the scalable fonts cannot be used.

**List Condensed and Expanded Widths:** When this checkbox is checked, scalable fonts (outline fonts) with the width condensed or expanded can be used.

**List Specified Scale Factors:** When this checkbox is checked, the scalable fonts (outline fonts) with the width reduced or enlarged at an optional scale factor can be used. Since this feature is not supported, do not change the default setting.

**Percentages:** Checking the “List Specified Scale Factors” checkbox enables specifying a scale factor. Since this feature is not supported, do not change the default setting.

## • Bitmap Font Settings

**List Bitmap Fonts:** When this checkbox is checked, the bitmap fonts can be used on the application. When not checked, the bitmap fonts cannot be used.

**Simulate Scalable Fonts:** When this checkbox is checked, the size of bitmap fonts can be specified to the same size of outline fonts. Since this feature is not supported, do not change the default setting.

**List Magnifications:** When this checkbox is checked, magnified bitmap fonts can be used.

**List Condensed and Expanded Widths:** When this checkbox is checked, bitmap fonts with the width condensed or expanded can be used.

## • Compatibility Settings

**List Multiple Character Set Fonts Separately:** When this checkbox is checked, printer font data can be printed with another code page.

## ◆ Utility Fonts tab

**Supplement:** Utility font do not correspond to actual text fonts on the printer, but are used to control advanced printer features, such as bar codes, RFID, and sending direct commands to the printer.

### • Utility Font Settings

**List Utility Fonts:** When this checkbox is checked, the utility fonts can be used on the application. When not checked, the utility fonts cannot be used.

**List Bar Code and RFID Fonts:** When this checkbox is checked, bar code fonts and RFID fonts can be used. However, the RFID fonts is not supported.

**List Printer Command Font:** When this checkbox is checked, specified data can be sent to the printer as it is.

**List Driver Command Font:** When this checkbox is checked, the font used to generate commands from data in the specified format can be used. Since this feature is not supported, do not change the default setting.

### • Compatibility Settings

**Combine Adjacent Bar Code & RFID Fields:** When this checkbox is checked, it is possible to prevent one bar code font from being separated into two or more bar codes when using a specific application such as MS Word and PowerPoint.

If data beginning or ending with a space is printed in a bar code font, such a space is deleted from the data. Also, when the same bar code font and the same Y position are specified for different data, they are all connected.

This feature is enabled as default. When unnecessary, you may disable it.

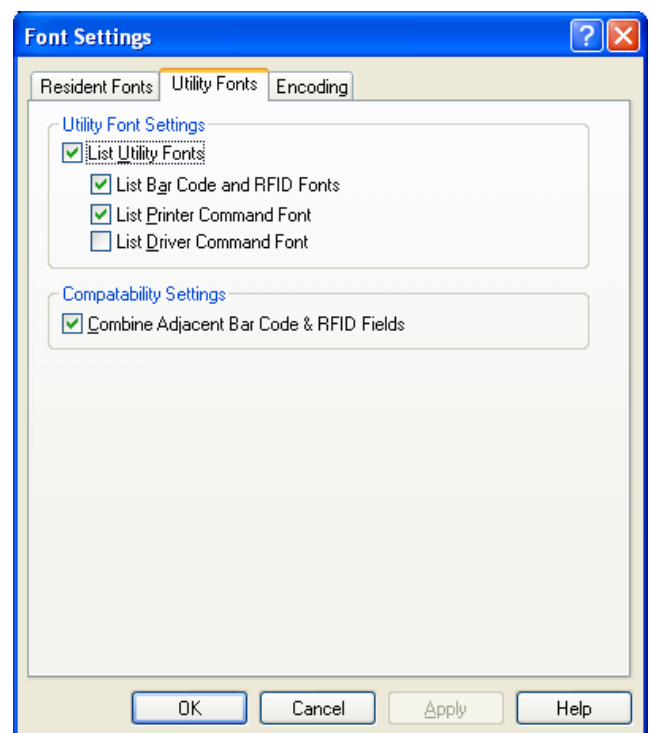

## ◆ Encoding tab

### • Text Encodings

Enables setting the code page for the data to be printed in the resident fonts. Wrong code page setting causes the printer not to print properly. Since this feature is not supported, do not change the default setting.

In the case the code page of B-850, B-852, or Arabic is selected for the printer, the data is printed as it looks with the printer font. But unsupported characters are not processed as the printer font. For the code page other than B-850, B-852 and Arabic, some characters may not be printed as they look or processed as the printer font.

Only the characters in the code page provided in the External Equipment Interface Specification of each printer model are usable.

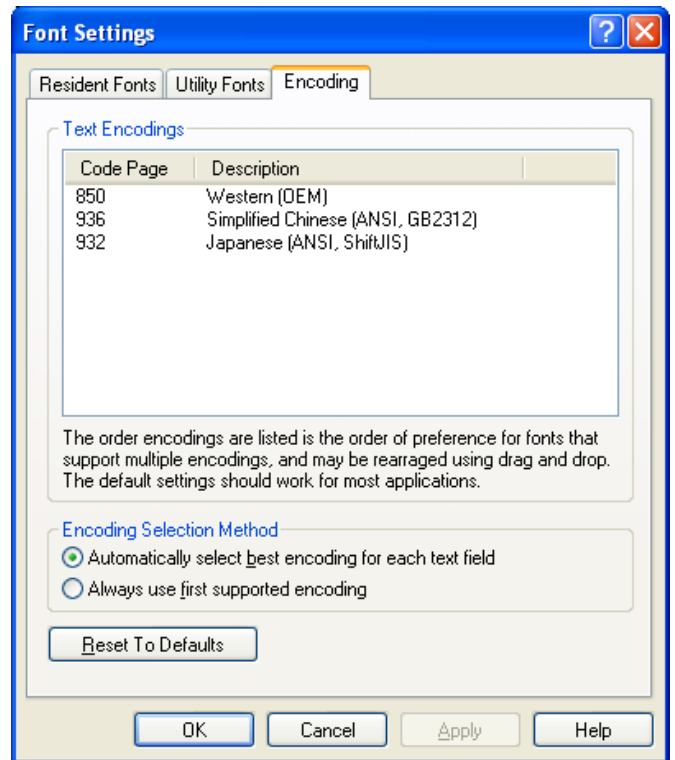

### 3.5.1 Bar Code Font

When you click the [Font] button in the [Fonts] page and select the “New Bar Code Font”, the following screen appears to enable addition of a new bar code font.

Also, you can modify the registered bar code font properties. First select the bar code font to edit, then click the [Font] button in the [Fonts] page and select the “Edit” or right-click the bar code font and select the “Edit” to open the Bar Code Font screen.

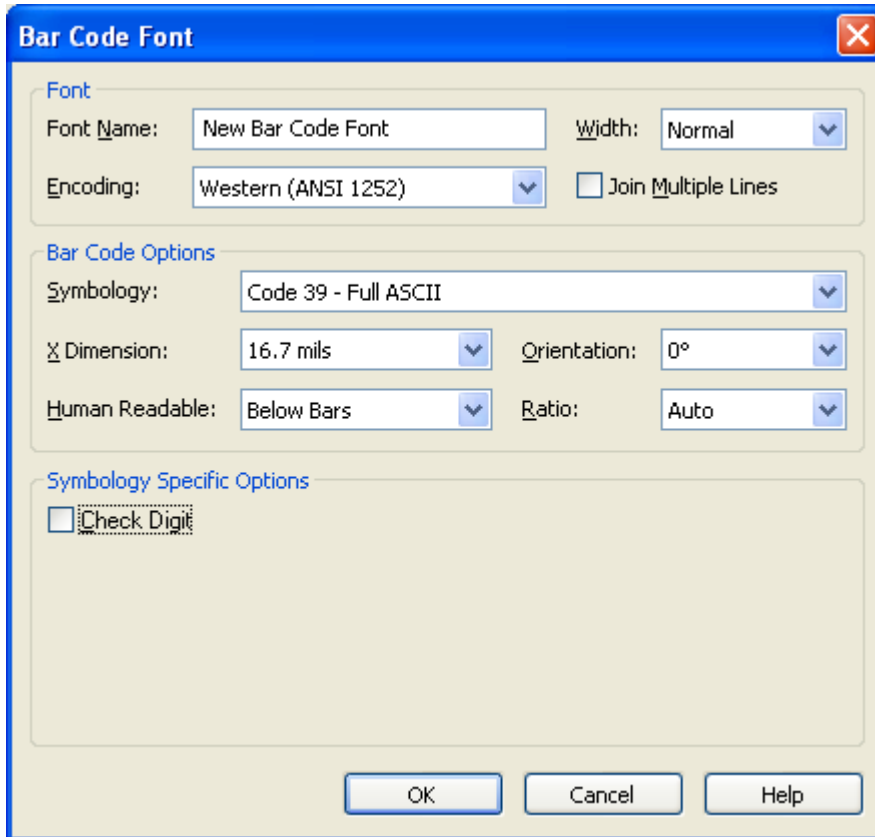

#### ■ Font

- **Font Name**

Enables entering a bar code font name using alphanumeric characters, Kanji, or Kana.

- **Encoding**

Enables specifying the code page for encoding characters. In the case 2-byte characters like Kanji are used, specify “Japanese”.

- **Join Multiple Lines**

When this checkbox is checked, multiple-line data specifying the same bar code font is combined into a single bar code. This allows paragraph text to be encoded into one bar code. When this setting is not enabled, each row of text will generate a separate bar code.

**Supplement:** The all texts specifying the same bar code font in a page are combined and printed as one bar code.

- **Width**

Enables specifying the width of the text data, to be encoded into a bar code, on the application screen.

**Supplement:** This feature is useful when the text data does not fit in a page. Depending on the applications, however, this feature may not work. In that case, or when encoding a large number of texts in a single bar code, enable the “Join Multiple Lines.”

## ■ Bar Code Options

### • Symbology

Enables selecting a type of the bar code or two dimensional code from the following.

- Code 39 - Full ASCII
- Code 39 - Regular
- Code 93
- Code 128
- Codabar (NW-7)
- Data Matrix
- EAN/JAN-8
- EAN/JAN-13
- GS-1 Composite
- GS-1 DataBar (RSS)
- Interleaved 2-of-5(ITF)
- Japanese 4-State Customer Code
- KIX 4-State Customer Code
- MaxiCode
- MicroPDF417
- Micro QR Code
- MSI Plessey
- PDF417
- QR Code
- Royal Mail 4-State Customer Code
- UPC-A
- UPC-E
- US POSTNET (Zip, Zip+4, & DPBC)

### • X Dimension

Enables specifying the width of a narrow bar or a cell. (It differs depending on the printer models or selected bar code symbologies.)

**Supplement:** The height of a bar code is adjustable by specifying the font size on the application.

### • Human Readable

Enables specifying the visibility of the human readable characters displayed with the bar codes on the labels. (Depending on the bar code symbologies, this feature may not be available.)

- None
- Below Bars

### • Orientation

Enables specifying the orientation of the bar code on the label.

- 0°
- 90°
- 180°
- 270°

### • Ratio

Enables specifying the wide-to-narrow element ratio of the bar code. (Depending on the bar code symbologies, this feature may not be available.)

- Auto
- 2.0 to 3.0

## ■ Symbology Specific Options

Enables setting options specific to the selected bar code symbology.

## 3.6 Tools Tab

Clicking the Tools tab enables testing the printer operations or setting variable options.

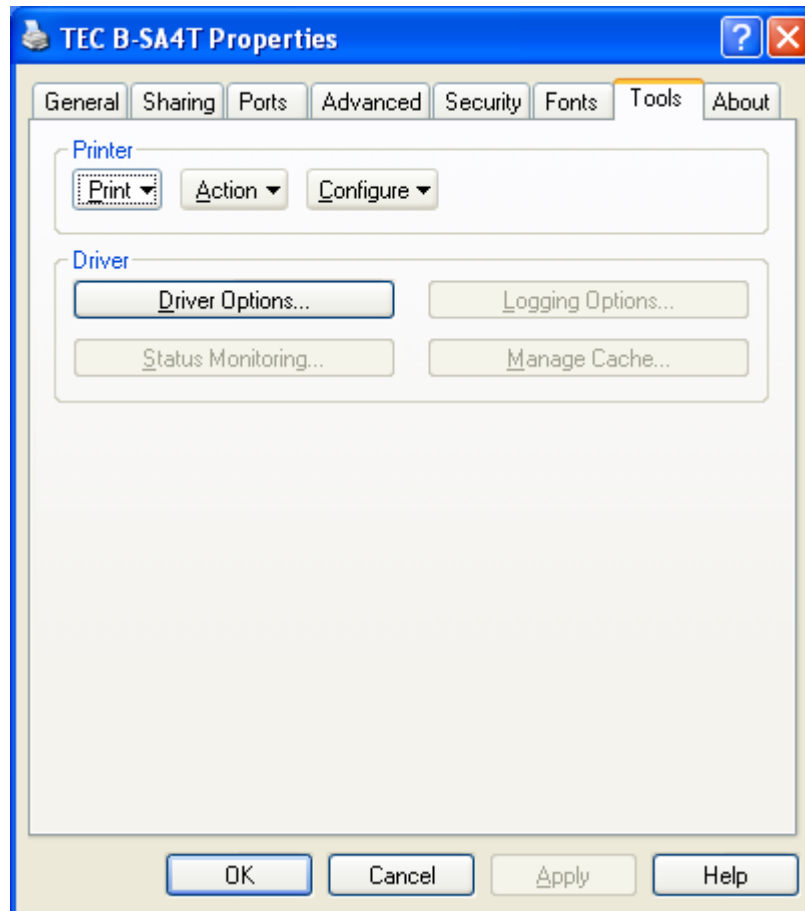

### ■ Printer

#### ◆ Print



- **Generic test**  
Prints an image "TEST" on a label on the print conditions (Media size, position adjustment, sensor type, etc.) specified in the Stock page. This should help verify that the computer being used is communicating with the printer.
- **Blank page**  
Prints a blank label on the specified conditions (Media size, position adjustment, sensor type, etc.)

#### ◆ Action

Available features differ depending on the printer models.

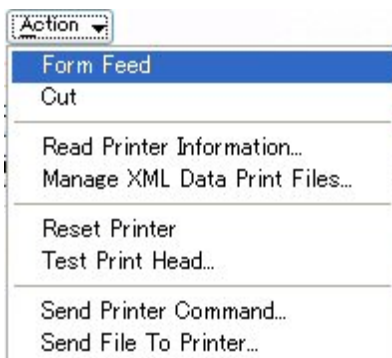

- **Form Feed**  
Feeds a label on the specified conditions Media size, position adjustment, sensor type, etc.)
- **Cut**  
Cuts the label immediately.
- **Read Printer Information**  
Displays the version and option information obtained from the printer. The information to be obtained differs depending on the printer models and interfaces. This feature is not supported.

- **Manage XML Data Print Files**

Enables managing the format, graphic, and font files related to the XML data in the printer. This feature is not supported

- **Reset Printer**

Enables resetting the printer. This is available only when the RS-232C interface is used.

- **Test Print Head**

Allows execution of the printer's broken pins test. The test will detect if thermal elements in the print head are open. A failed test would suggest a need to replace the print head to ensure perfect print quality. Clicking this menu will bring up the display window on the right.

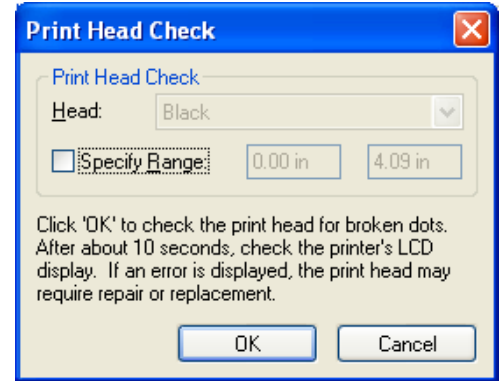

- **Send Printer Command**

Allows sending the programmed printer commands to the printer. Clicking the [Query] button enables displaying the printer status returned in response to the printer command. The Query feature is available only when the bi-directional communication is enabled and the query commands are sent to the printer. For details of the printer commands, refer to the *External Equipment Interface Specification* of each printer model.

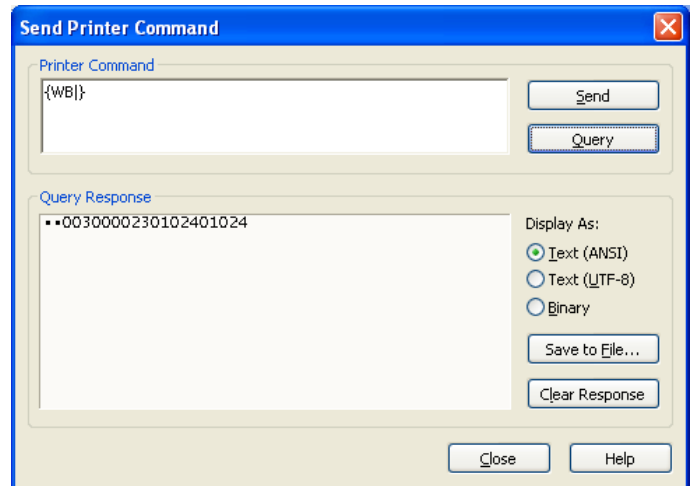

- **Send File To Printer**

Allows sending a command file directly to the printer.

## ◆ Configure

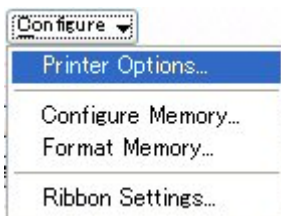

- **Printer Options**

**Automatic Status Response:** When this checkbox is checked, the printer will automatically send the status to the host at the end of print or occurrence of an error.

**Note:** This feature is enabled as default though the printer driver does not use its status. When this is not necessary, remove the check.

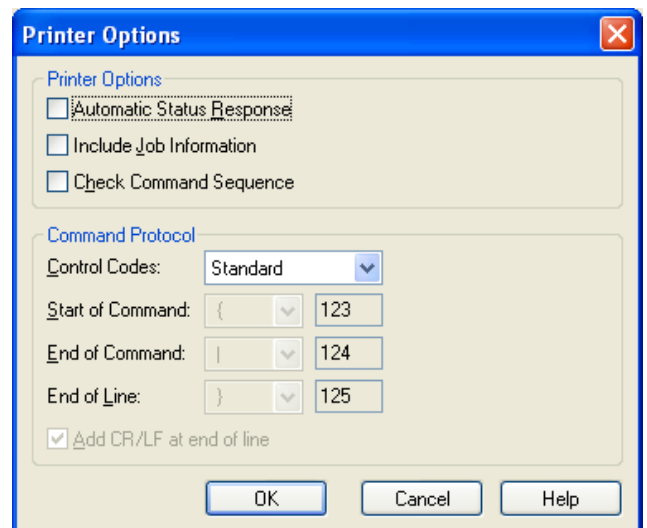



**Include Job Information:** When this checkbox is checked, the job information obtained from the printer through the SNMP feature is added to those to be printed. This information is displayed on the Network Tool.

**Note:** This feature is disabled as default. If you do not need the job information on the SNMP, do not change the default setting.

**Check Command Sequence:** When this checkbox is checked, a command, which checks whether any necessary command is missing from a command string the printer received, is attached. This function is available only to the B-EV4-T and B-EV4-G.

#### • Command Protocol

**Control Codes:** Enables setting the control code for the printer commands. It must be the same as the control code specified on the printer.

**Note:** By default, the "Standard" is specified. When Kanji code is specified for the printer font, PEF417, MicroPDF417, Data Matrix, Maxicode, or QR code, set the "Control Codes" to "ESC/LF/NUL". Failure to do so causes an error.

**Auto Feed Setting (B-419 only):** Allows selecting whether to enable or disable the auto feed feature. When the [OK] button is clicked, the setting is sent to the printer, and this is possible while the printer and the PC are communicable with each other and the printer is not printing.

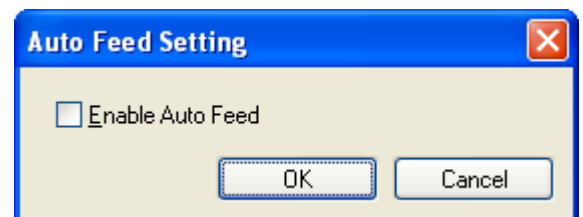

**Supplement:** If the printer does not perform the auto feed feature even if it is enabled, the printer will have a sensor error. The setting can be changed during an error state.

For the B-419 with the auto feed feature enabled, the printer automatically feeds the media to the print start position on the following conditions:

- When the media is manually inserted while the standby switch is turned on.
- The media is already loaded at the time the standby switch is turned on.
- When the top cover is closed after the media is loaded.

**Note:** To use the auto feed feature, the media must have black marks at the specified position on the reverse side.

#### • Configure Memory

If the allocated memory sizes are different. When the "Configure Memory" is clicked, the screen on the right is displayed to enable partitioning the internal memory or the expansion memory into areas of the specified size. When the [OK] button is clicked, the changed memory allocation will be set to the printer.

If the specified memory size is different from those of the printer, the printer automatically re-allocates in order of priority.

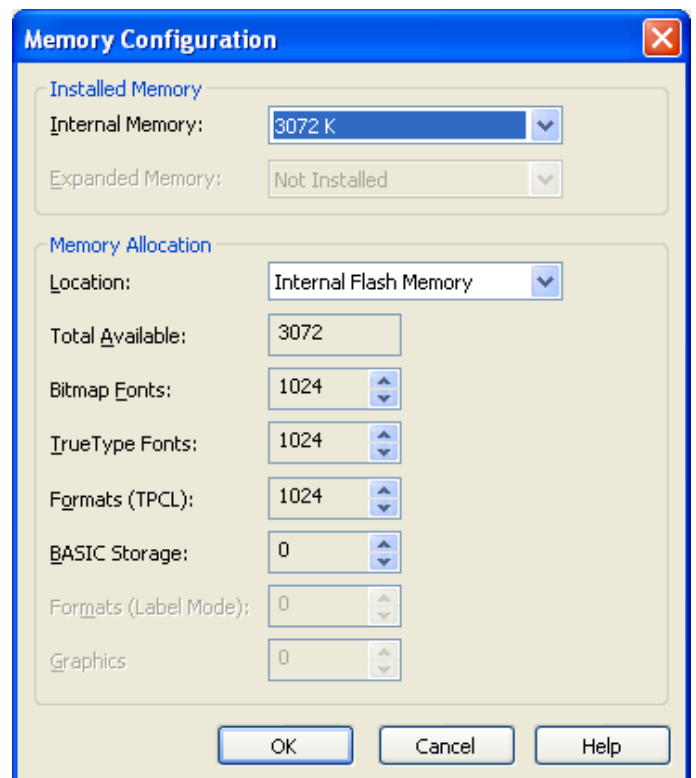

- **Format Memory**

When the “Format Memory” is clicked, the screen on the right is displayed to enable formatting the specified flash memory. When the [OK] button is clicked, the memory format is executed.

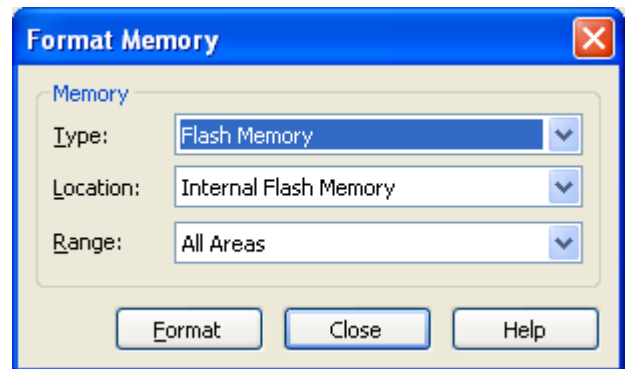

- **Ribbon Settings**

When the “Ribbon Settings” is clicked, the screen on the right appears to enable fine adjustment of the ribbon motor voltages. Adjusting the ribbon motor voltage is effective to improve ribbon slack or wrinkles.

Before changing the default settings, refer to the manual of each printer model. When the [OK] button is clicked, the changes are sent to the printer.

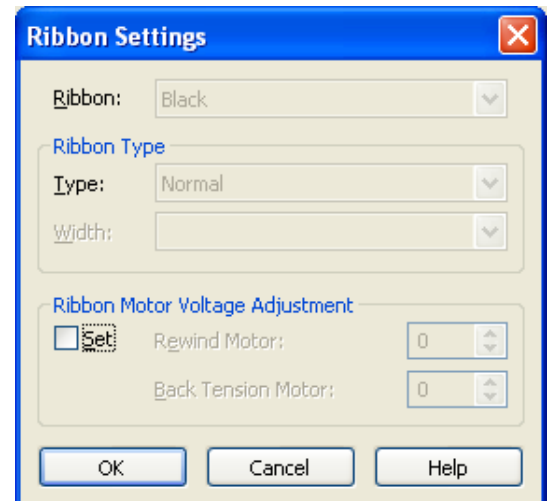

- **Driver**

- ◆ **Driver Options**

- **Administration tab**

Enables saving the settings of this printer driver in a file or importing the settings into a different or freshly installed printer driver. It also allows importing previously saved settings to replace the current settings of this printer driver.

**Import:** Allows reading the checked items from the “Driver Setting File (\*.sds)” to replace the current settings. The files of the older versions having a file extension of “sfm”, “sbf”, “spr”, or “sdm” can be also used, however, a part of the items cannot be replaced.

**Export:** Allows saving the checked items in a “Driver Setting File (\*.sds).”

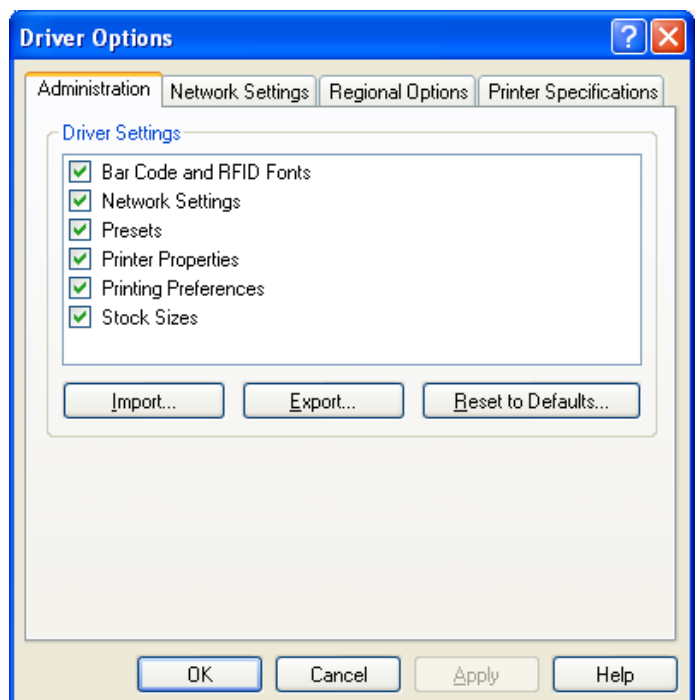

**Reset to Defaults:** Allows restoring the checked items to the factory default.

- Bar Code and RFID Fonts ..... Registered bar code fonts
- Network Settings ..... Setup information of the [Network Settings]
- Presets ..... Registered preset lists
- Printer Properties ..... Settings of stocks, graphics, print conditions, and various print configurations.
- Printing Preferences ..... Settings configured in the Printer Options, Driver Options, Font Settings, etc.
- Stock Sizes ..... Registered stock settings

• **Network Settings tab**

When the shared printer is installed as a network printer, its setup information or statuses can be shared between the server and the client.

This feature is not supported. To set the printer as a network printer, refer to **To print on the shared printer** and follow the procedure.

**Note:** Disable the “Bidirectional support” on the client PC.

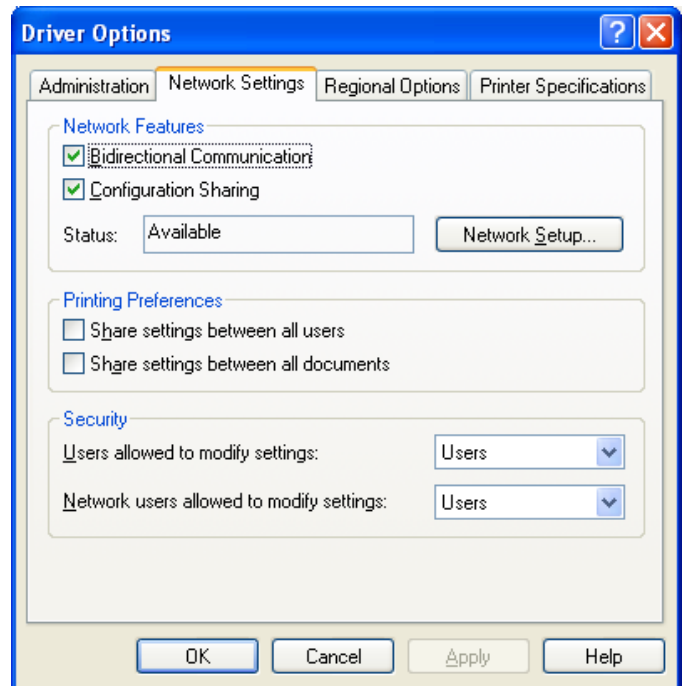

• **Regional Options tab**

Allows changing the language and units of measurement to agree with the region in which these printers are being used.

**Language Selection:** Allows selecting the desired language to be used.

Language

- Use Windows Setting
- English
- Dutch
- German
- Portuguese (Brazil)
- Chinese (Simplified)
- Italian
- Spanish
- French
- Japanese
- Chinese (Traditional)

**Measurement System:** Allows selecting the desired unit of measure.

Units

- Use Windows Setting
- Inches
- Millimeters
- Centimeters

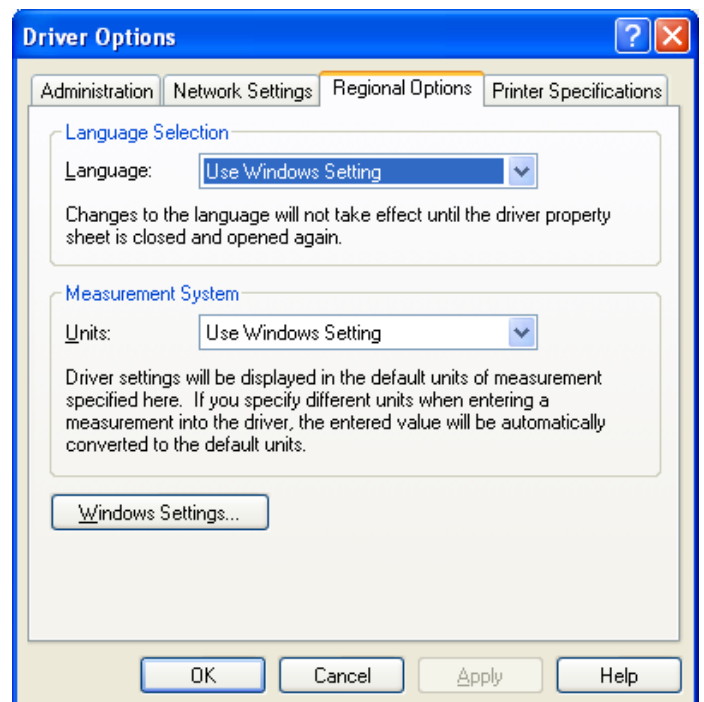

**Windows Settings:** Displays the “Regional and Language Options” of Windows.

• **Printer Specifications tab**

**Unprintable Width:** Allows making minor adjustments in the horizontal positioning of the printed image on the label. Since this feature is not supported, do not change the default setting.

**Model Specifications:** Allows setting the specification of the printer, such as the resolution and media size. Since this feature is not supported, do not change the default settings. If they are changed, printing cannot be performed properly.

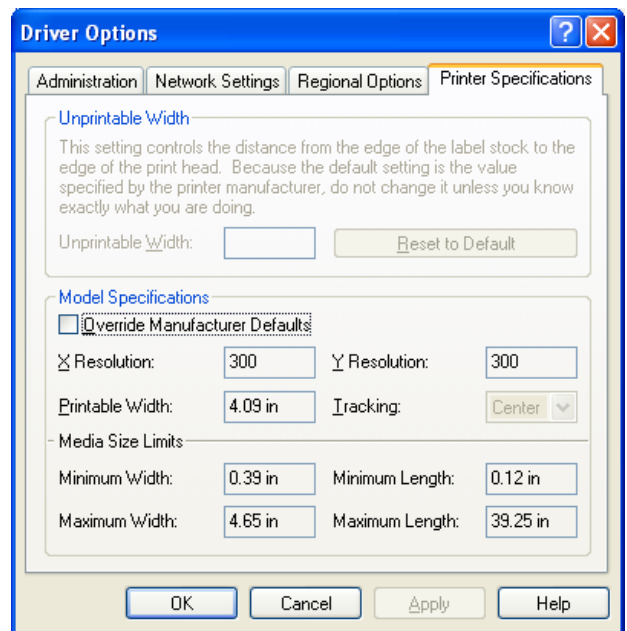

◆ **Logging Options**

Supports logging print jobs and recording printer code to files for debugging purposes. This feature is available only when the “Bi-directional support” is enabled.

• **Logging tab**

Enables recording printed pages and job history to a file or as event logs. Only the Legacy Log, created by clicking the [Tools] button and “Add Legacy Log”, is supported.

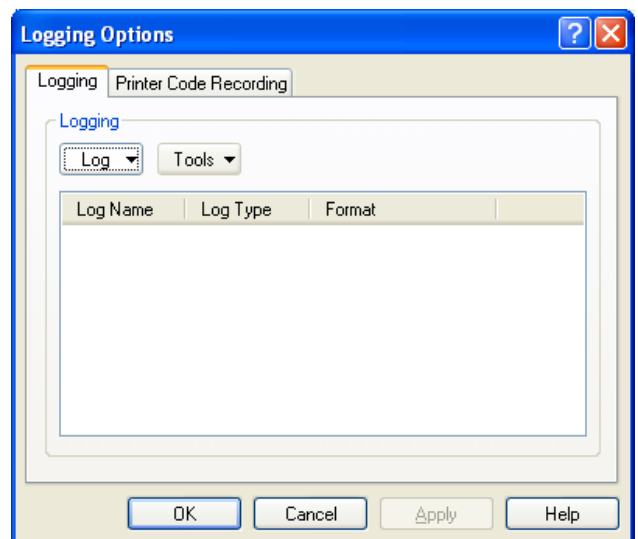

• **Printer Code Recording tab**

Allows recording of all of the commands sent to the printer to a file. When the “Record Printer Code” checkbox is checked, the printer codes are recorded to the specified directory. Unlike using the “Print to File” option in most applications, “Printer Code Recording” allows printing to the printer and to a file simultaneously.

To reduce the load of the hard disk, the created files need to be deleted periodically.

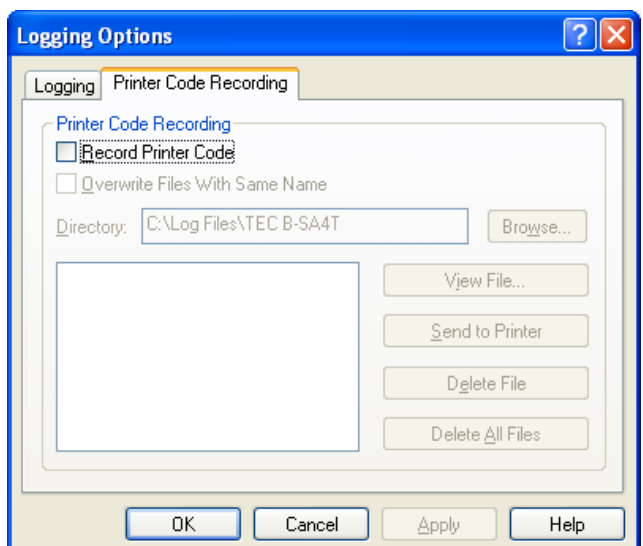

## ◆ Status Monitoring

### • Status tab

Enables monitoring the printer status.

Applicable printer models:

B-SX4, B-SX4-CN, B-SX5, B-SX5-CN, B-SV4, B-SA4G, B-SA4G-CN, B-SA4T, B-SA4T-CN, B-852-R, B-452-R, B-EP2DL-G, B-EP4DL-G, B-SX6T-R, B-SX8T-R, B-EX4T1-G, B-EX4T1-T, B-EX4T2-G, B-EX4T2-T, and B-EX4T2-H

Requirements to use the status monitor:

- The printer and the PC are connected with a serial interface cable.
- The printer and the PC are connected with a parallel interface cable and the “CENTRO.MODE” and “PLUG & PLAY” are set to “ECP” and “ON”, respectively. (B-SX4T/SX5T only)
- The printer and the PC are connected with a USB cable.
- The printer and the PC are connected with a LAN cable.

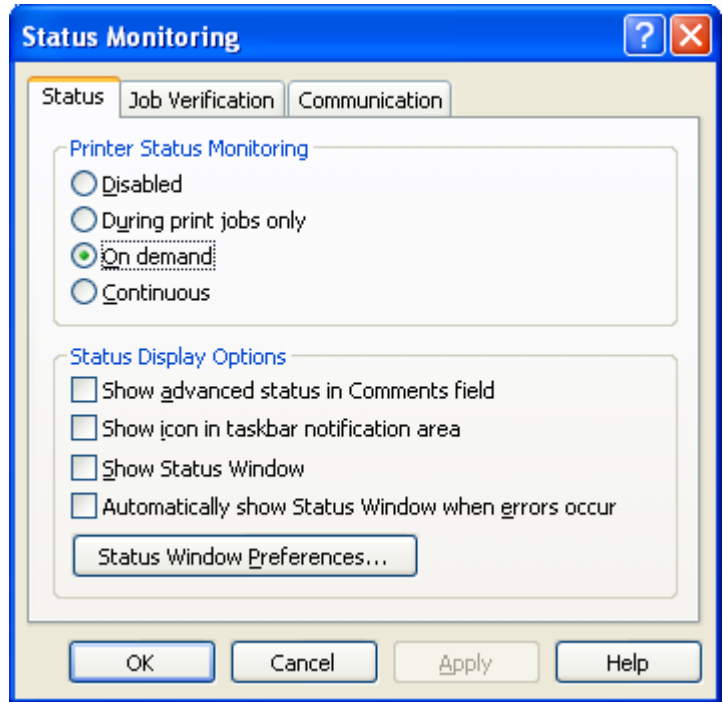

**Printer Status Monitoring:** Enables selecting how to start the status monitor.

- Disabled: Printer status is not monitored.
- During print jobs only: Printer status is monitored while a print job exists in the print queue.
- On demand: Printer status is monitored only while printing.
- Continuous: Printer status is always monitored.

### Status Display Options:

**Show advanced status in Comments field:** When checked, a printer status is displayed on the Comment column of the “Printer & FAX” window. Since this feature is not supported, do not change the default settings.

**Show icon in taskbar notification area:** When checked, the status monitor icon is displayed on the task bar and the printer statuses are periodically monitored.

**Show Status Window:** When checked, the status monitor’s status window is displayed. Remove the check or click the [X] button to close the window.

- Printer: Name of the printer monitored.
- Port: Output port monitored. The printer uses this port for printing.
- Status: Printer status This is equivalent to the message displayed on the printer LCD. This windows only shows the printer statuses, not detailed information like the number of unprinted labels.

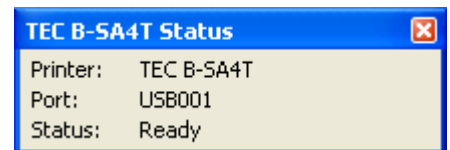

Ready	Paused	Printing
Ready, Ribbon Low	Paused, Ribbon Low	Printing, Ribbon Low
Ready, Paper near end	Pause, Paper near end	Printing, Paper near end
Command Error	Offline	Out of Paper
Out of Ribbon	Head Open	Paper Jam
Cutter Error	Ribbon Error	Sensor Error
Door Open	RFID Write Error	RFIE Error
Label Present	I/O Error	Motor Temperature High
Head Temperature High	Ambient Temperature Error	Output Full
Battery Temperature High	Low Battery	Charge Error
Bluetooth Setting Error	Battery Warning	Head Temperature Warning
Motor Temperature Warning	Memory Write Error	Memory Error
Memory Card Error	Busy	RFID Setting Error

[How to recover from an error]

When an error like “NO PAPER” occurred on the printer, clear the cause of the error, and press the [RESTART] key on the printer.

For details, please refer to the Owner’s Manual of each printer.

**Automatically show Status Windows when errors occur:** When checked, the printer status is periodically monitored and if an error occurred during printing, the status window is displayed.

### Status Window Preferences:

**Always on top:** When checked, the status window is always displayed on the top of all other windows.

**Hide titlebar:** When checked, the titlebar of the status window is hidden.

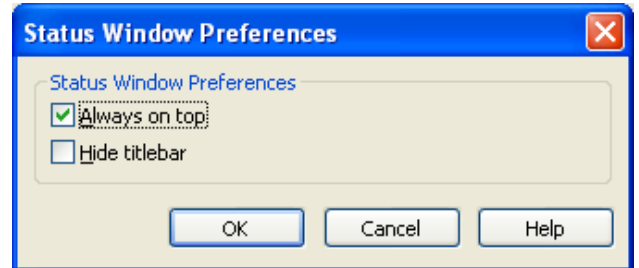

### • Job Verification tab

Enables setting the print job monitoring method. When either checkbox is checked, printing is performed while verifying a completion of printing. Since this feature is not supported, do not change the default settings.

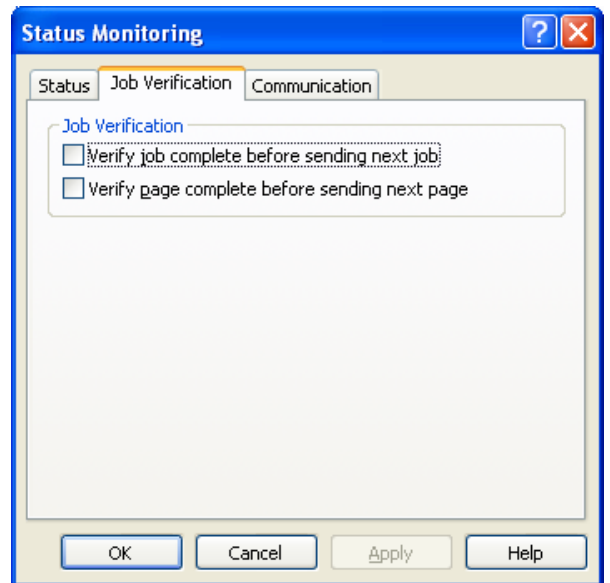

### • Communication tab

Enables setting the timeout and polling interval for the status monitoring are set. Do not change the default settings.

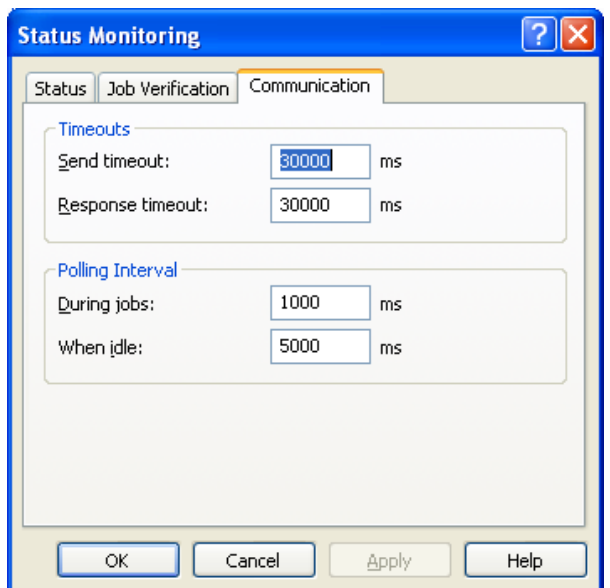

### Notes:

- Be sure to disable the status monitor when uninstalling the printer driver or changing the output port.
- When the printer is used as a shared printer, the status monitor window is not displayed on the client PC.
- While the status monitor is displayed, the ON LINE LED blinks periodically. This is not a failure.
- DO NOT enable the status monitor for the printers other than B-SX4, B-SX4-CN, B-SX5, B-SX5-CN, B-SV4, B-SA4G, B-SA4G-CN, B-SA4T, B-SA4T-CN, B-852-R, B-452-R, B-EP2DL-G, B-EP4DL-G, B-SX6T-R, B-SX8T-R, B-EX4T1-G, B-EX4T1-T, B-EX4T2-G, B-EX4T2-T, and B-EX4T2-H.
- It takes time to detect an OFFLINE status. (30 sec. at least)
- If the “Show icon in taskbar notification area” and “Show Status Window” checkboxes are checked, the status monitor may not work properly when the PC is started. If the “OFFLINE” is displayed at the start of the PC, remove the checks from these options.

## 3.7 Designation of Printer Font

It is possible to use the printer's resident fonts and bar code symbologies within any Windows application by selecting the printer fonts like "TEC Kanji" for the data to be converted.

### ■ Example of selecting a font on the application

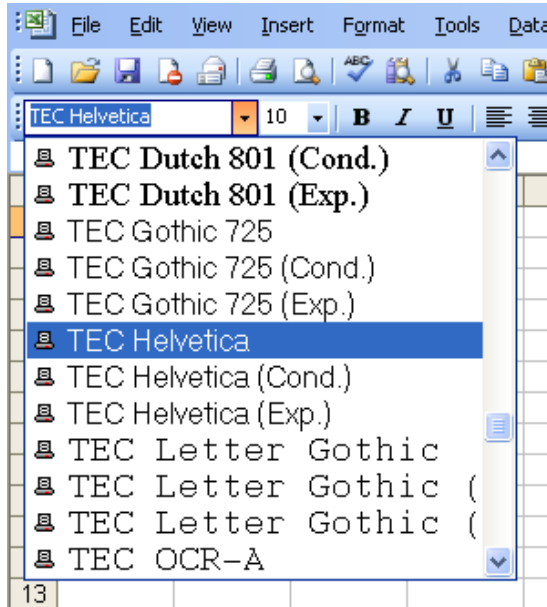

**Character font**

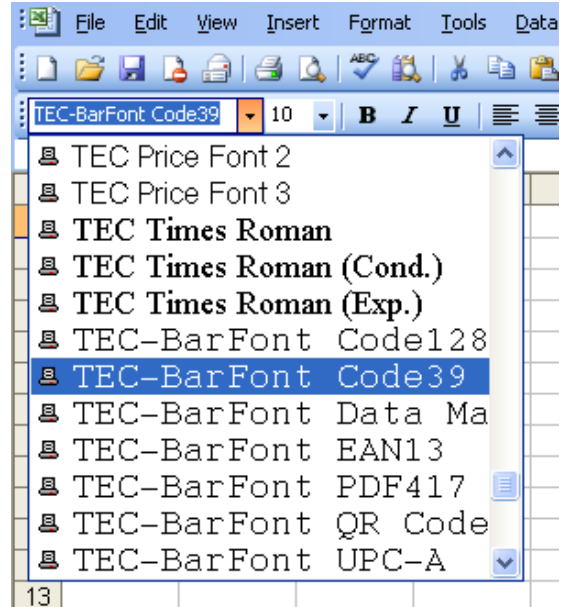

**Bar code font**

#### Supplement:

- The name of the printer fonts (bar code or 2D code fonts) for the Toshiba TEC bar code printers starts with "TEC", like "TEC Kanji". Although the "TEC \*\*\*" fonts do not appear as bar codes on the screen, they will be converted by the driver into the desired bar codes.
- It is possible to expect an increase of the printing throughput if the printer font is used.
- Printer fonts (including bar code fonts) shown on the application screen look different from the actually printed ones in on appearance and size.
- To use the TEC Kanji Outline fonts on the B-372, B-472, and B-872, separately sold fonts are required.

### ■ Example of bar code font programming (Visual Basic 5.0/6.0)

In the case the registered bar code font name is "BarFont Code 39":

```
Private Sub Command1_Click()  
Printer.FontName = "TEC-BarFont Code39"  
Printer.FontSize = 36  
Printer.FontBold = False  
Printer.FontItalic = False  
Printer.CurrentX = 1000  
Printer.CurrentY = 1000  
Printer.Print "1234567"  
Printer.EndDoc  
End Sub
```

**Note:** The Visual Studio.NET (VB/C#) or later does not support the above processing.

## ■ Restrictions of Bar Code Fonts

- Depending on the applications, bar code fonts may not be listed in the font types. Make sure that the application used supports the printer fonts.
- Bar code fonts do not appear as bar codes on the document of the application. Instead, characters or symbols are displayed.
- If a bar code rotation is specified, the actual print position differs from the position specified by the application. Print the data and adjust the position of the printed image.
- The height of bar code is specified by the character size point. The character size points are converted into millimeters on the basis of the following table, or there may be a case that the bar code font is converted into other character font and no bar code is printed.

Point	Bar height (mm)	Point	Bar height (mm)
8	2.8	36	12.7
9	3.2	48	16.9
10	3.5	60	21.2
11	3.9	72	25.4
12	4.2	108	38.1
14	4.9	144	50.8
18	6.4	180	63.5
24	8.5	216	76.2
30	10.6		

- In the case Kanji code is included in data, select the Tool tab, the [Configure] button, “Printer options”, and set the “Control Codes” to “ESC/LF/NUL”.

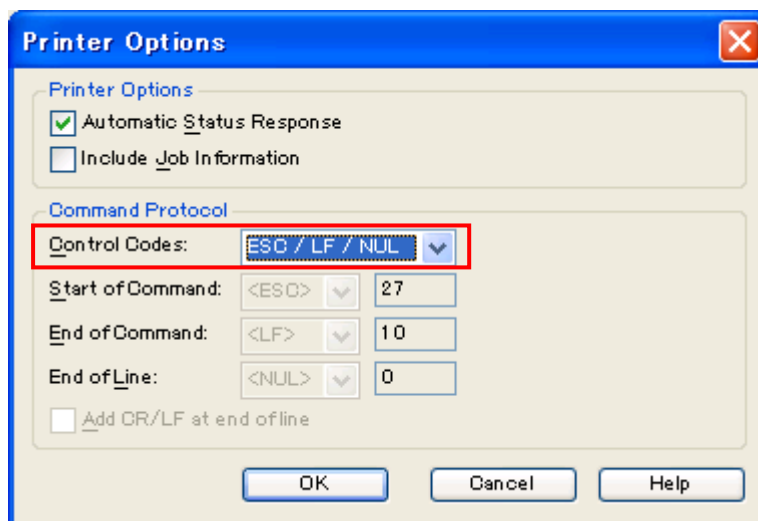



- When a control code or special code is used with the bar code font specified, refer to the following table and enter the corresponding data.  
In the case a caret “^” is used, enter “^^” because the caret “^” is the default function character. If the function character is changed from “^” to the other in the [User Commands] of the [Advanced Options], replace the “^” with the specified character.

Control code	Input data	Control code	Input data	Control code	Input data
>@ (00H)	N/A	>P (10H)	^<DLE>	>0	>
>A (01H)	^<SOH>	>Q (11H)	^<DC1>	>1	^<DEL>
>B (02H)	^<STX>	>R (12H)	^<DC2>	>2	^3
>C (03H)	^<ETX>	>S (13H)	^<DC3>	>3	^2
>D (04H)	^<EOT>	>T (14H)	^<DC4>	>4	^s or ^S
>E (05H)	^<ENQ>	>U (15H)	^<NAK>	>5	^c or ^C
>F (06H)	^<ACK>	>V (16H)	^<SYN>	>6	^b or ^B
>G (07H)	^<BEL>	>W (17H)	^<ETB>	>7	^a or ^A
>H (08H)	^<BS>	>X (18H)	^<CAN>	>8	^1
>I (09H)	^<HT>	>Y (19H)	^<EM>		
>J (0AH)	^<LF>	>Z (1AH)	^<SUB>		
>K (0BH)	^<VT>	>[ (1BH)	^<ESC>		
>L (0CH)	^<FF>	>¥ (1CH)	^<FS>		
>M (0DH)	^<CR>	>] (1DH)	^<GS>		
>N (0EH)	^<SO>	>^ (1EH)	^<RS>		
>O (0FH)	^<SI>	>_ (1FH)	^<US>		

■ Correspondence table of the specified size of TEC Kanji and actually printed size

Unit: Point

305dpi		300dpi	
Specified size	Print size	Specified size	Print size
1.0 to 2.0	1.9	1.0 to 2.5	1.9
2.5 to 3.0	2.8	3.0 to 3.0	2.9
3.5 to 5.0	3.8	3.5 to 5.0	3.8
5.5 to 7.0	5.6	5.5 to 7.0	5.8
7.5 to 9.0	7.5	7.5 to 9.0	7.7
9.5 to 10.0	9.4	9.5 to 10.5	9.6
10.5 to 14.0	11.3	11.0 to 14.5	11.5
14.5 to 16.0	15.1	15.0 to 16.5	15.4
16.5 to 18.0	16.9	17.0 to 18.5	17.3
18.5 to 21.5	18.8	19.0 to 22.0	19.2
22.0 to 27.0	22.6	22.5 to 27.5	23.0
27.5 to 32.5	28.2	28.0 to 33.0	28.8
33.0 to 50.0	33.9	33.5 to 50.0	34.6

203dpi		600dpi	
Specified size	Print size	Specified size	Print size
1.0 to 3.5	2.8	1.0 to 1.0	1.0
4.0 to 5.0	4.3	1.5 to 1.5	1.4
5.5 v 7.5	5.7	2.0 to 2.5	1.9
8.0 to 10.0	8.5	3.0 to 3.5	2.9
10.5 to 13.5	11.3	4.0 to 4.5	3.8
14.0 to 15.5	14.2	5.0 to 5.0	4.8
16.0 to 21.0	17.0	5.5 to 7.0	5.8
21.5 to 27.0	22.7	7.5 to 8.0	7.7
27.5 to 32.5	28.4	8.5 to 9.0	8.6
33.0 to 57.5	34.0	11.5 to 13.5	11.5
		14.0 to 16.5	14.4
		17.0 to 25.0	17.3

## 4. System Configuration

---

The system requirements for this printer driver are as follows:

Computer	IBM PC-AT compatible
Windows NT	Microsoft Windows 2000/XP/Server 2003/Vista/Server 2008/7/Server 2008 R2
Windows 9X	Microsoft Windows 98/Me
Printer	TOSHIBA TEC Bar Code Printer
Centronics	Centronics interface cable
Printer server	Connection method to Ethernet <u>B-482</u> : Optional LAN Board <u>B-SV4</u> : Optional LAN adapter <u>B-482/B-852/B-SX</u> : Optional PCMCIA board and LAN card <u>B-SX</u> : Optional LAN board <u>B-SA4/B-852-R/B-452-R/B-SP2D/B-EP2DL-G/B-EP4DL-G/B-EV4/B-SX6T/8T/B-EX4T1/B-EX4T2</u> : The LAN interface is provided as standard.

**Notes:**

1. When the printer server is used, set the port by following the guideline of the printer server device.
2. When the Toshiba TEC optional LAN board or a set of the optional PCMCIA board and a LAN card is used to connect the printer to the LAN, refer to **Section 6.3 How to Connect the Printer to LAN**.
3. When the printer is used as the network printer, refer to **To print on the shared printer** described in the installation procedure by OS.

## 4.1 System Configuration Example

### ■ Example 1 In the case a Windows PC is directly connected to the printer.

Install the printer driver (for Windows 9X or Windows NT) in the PC #1.

Specify the LPT1 (local port) for the output port.

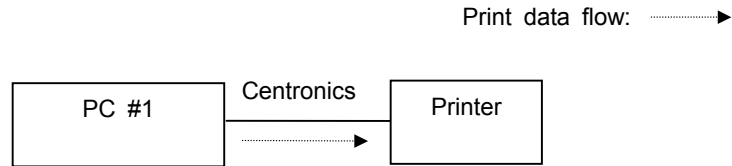

### ■ Example 2 In the case the printer is directly connected to the Windows PC #1 and printing is initiated from another Windows PC #2 via TCP/IP

1. Install the printer driver (for Windows 9X or Windows NT) in the PC #1.

Specify the LPT1 (local port) for the output port.

2. Right-click the printer icon, open the Properties, and specify the printer connected to the PC #1 as a shared printer.

3. Install the printer driver (for Windows 9X or Windows NT) in the PC #2.

4. Specify the network path of the printer connected to the PC # 1 and install it as a network printer.

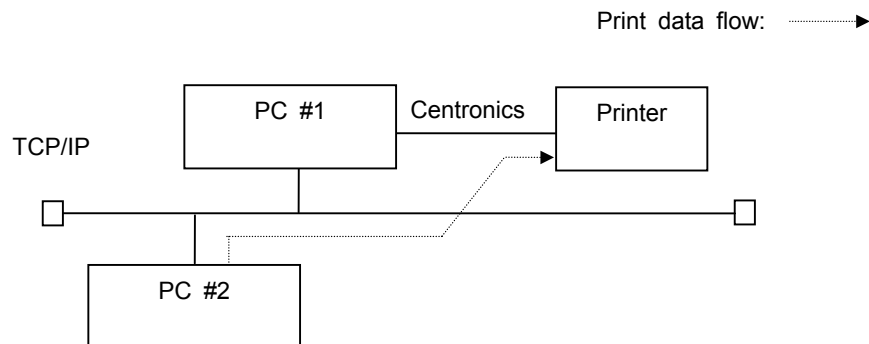

■ **Example 3** In the case print jobs are sent from Windows PC #2 (Windows 9x) and Windows PC #3 (Windows NT) to the Windows PC #1 (Windows NT) via TCP/IP, and these print jobs are sent from the PC #1 to multiple printers

1. Install the printer drivers (for Windows NT) in the PC #1 for the number of printers connected.
2. Right-click the printer icon on the PC#1, open the Properties and add the LPR port specifying the printer server address.
3. In the Properties screen, specify the printer on the network as the shared printers.
4. Install the printer driver (for Windows 9X) in the PC #2.
5. Specify the network path of the printer connected to the PC # 1 and install it as a network printer.
6. Install the printer driver (for Windows NT) in the PC #3.
7. Specify the network path of the printer connected to the PC #1 and install it as a network printer.

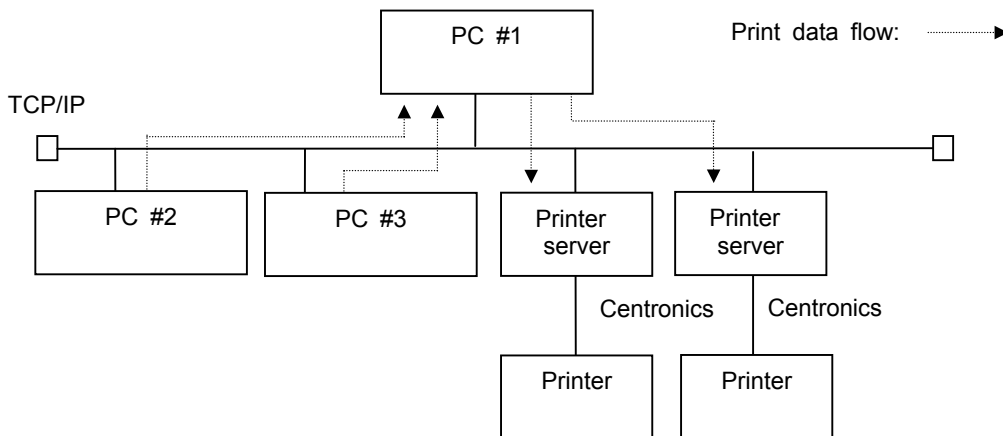

■ **Example 4** In the case print jobs are sent from Windows PC #1 (Windows 9x) and Windows PC #2 (Windows NT) to the multiple printers via TCP/IP

1. Install the printer drivers (for Windows 9X) in the PC #1 for the number of printers connected.
2. Add the LPR port specifying the printer server address. (Use other software like the printer server specific setting utility to add the LPR port.)
3. Specify the LPR Port added in Step 2 above as the print port of the PC #1.
4. Install the printer drivers (for Windows NT) in the PC #2 for the number of printers connected.
5. Right-click the printer icon on the PC #2, open the Properties, and add the LPR port specifying the printer server address.
6. Specify the LPR Port added in Step 5 above as the print port of the PC #2.

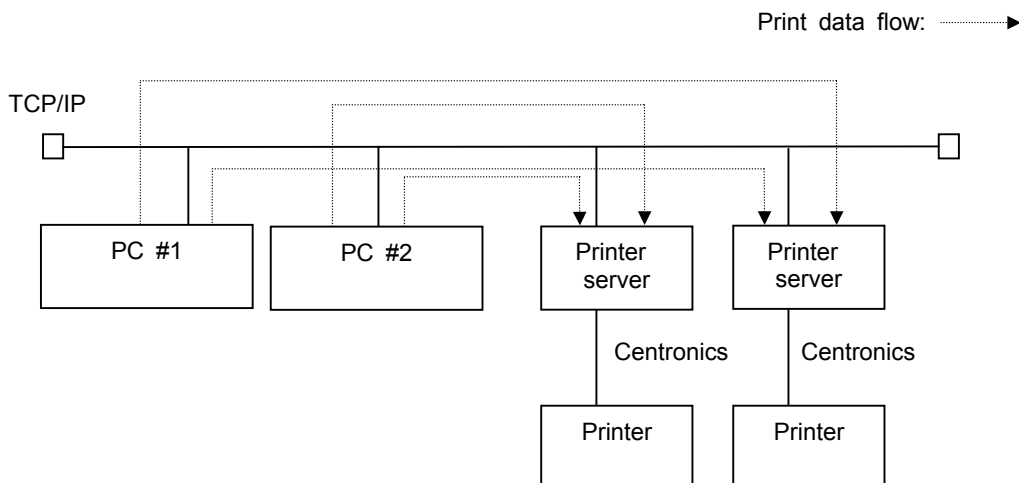

## 5. Addition/Deletion of Standard TCP/IP Port

---

When connecting the printer via LAN interface, configure the following settings on the printer using the printer system mode menu <7>IP ADDRESS.

- PRINTER IP ADDRESS
- GATEWAY IP ADDRESS
- SUBNET MASK
- SOCKET PORT

The above PRINTER IP ADDRESS and SOCKET PORT are used as the “Printer Name or IP address” and “Port No.”, respectively when adding a port.

**Note:** When the “Bi-directional support” is used, do not specify the same output port for the multiple printer drivers on a computer. When you want to specify the same output port for the multiple printer drivers, disable the [Printer Status Monitoring].

Also, when multiple computers connect to the same printer, specify that printer as the shared printer or disable the [Printer Status Monitoring].

## 5.1 Addition

1. Right-click the printer icon, and click the “Properties” to open the printer properties screen.

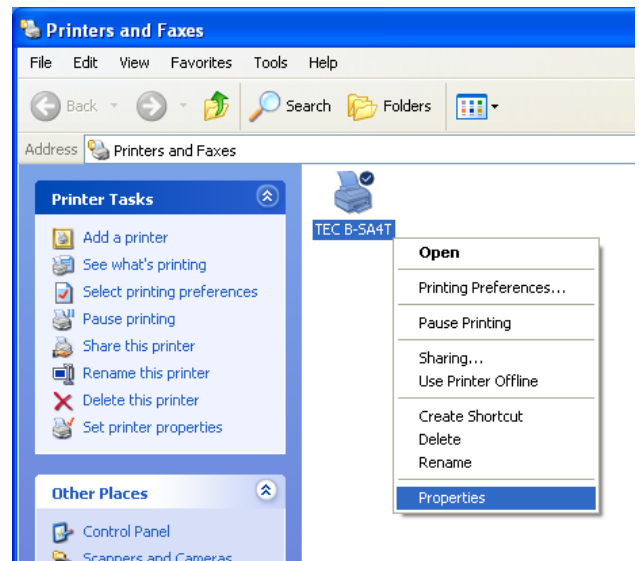

2. Select the [Ports] tab and click the [Add Port] button.

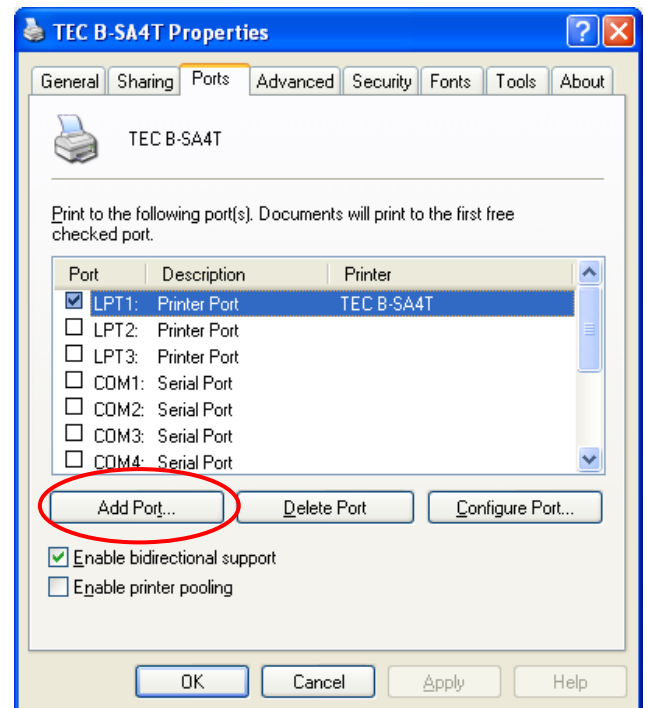

3. Select the “Standard TCP/IP Port” from the “Available port types” list, then click the [New Port] button.

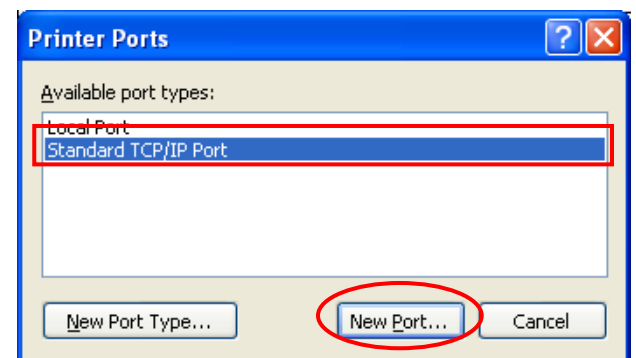

4. After the “Add Standard TCP/IP Printer Port Wizard” is started, click the [Next] button.

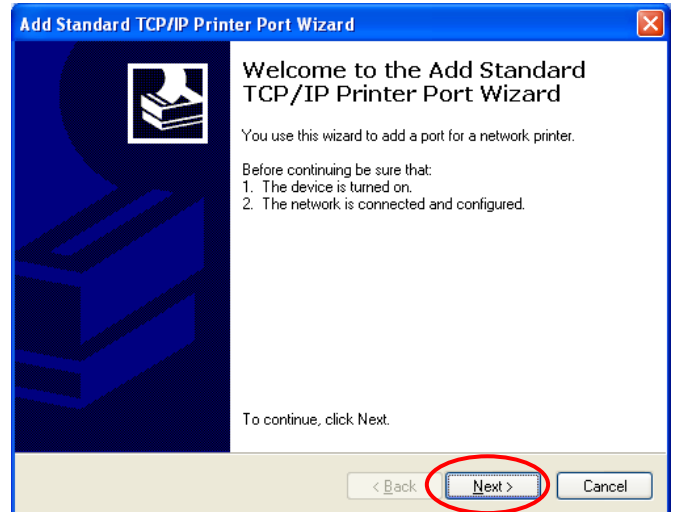

5. Type in the “Printer Name or IP Address” and click the [Next] button.

**Note:** The Port Name is automatically set when the “Printer Name or IP Address” is entered.

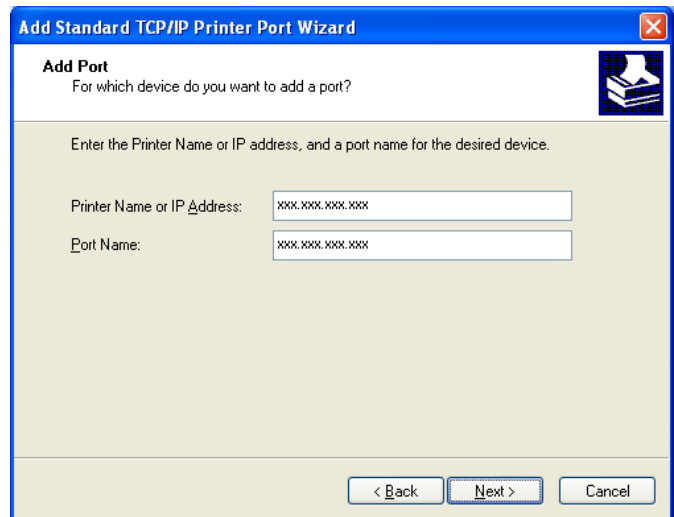

6. Select the “Device Type” to the “Custom”, then click the [Settings] button.

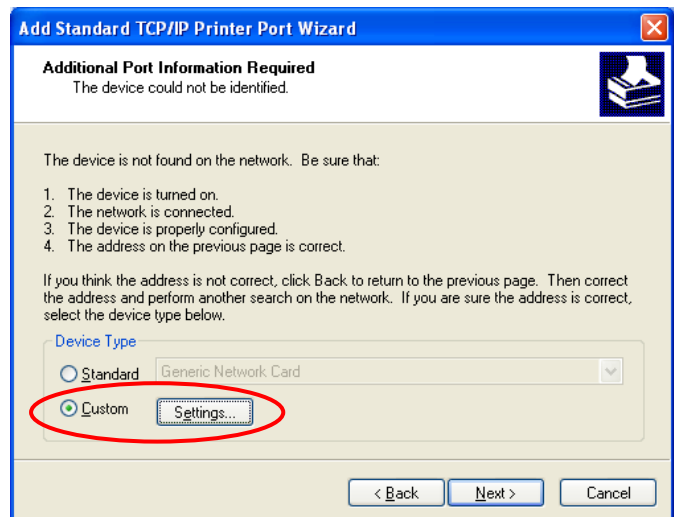



7. When you choose the “Raw” for the Protocol, enter the printer SOCKET PORT as the “Port Number” and click the [OK] button. The default port number is “8000”. Do not check the “SNMP Status Enabled” checkbox.

When you choose the “LRP” for the Protocol, enter any queue name (e.g. “lpr”) and click the [OK] button. Do not check the “LPR Byte Counting Enabled” and “SNMP Status Enabled” checkboxes.

**Note:** When the status monitor feature is used with the bi-directional support, select the “Raw”.

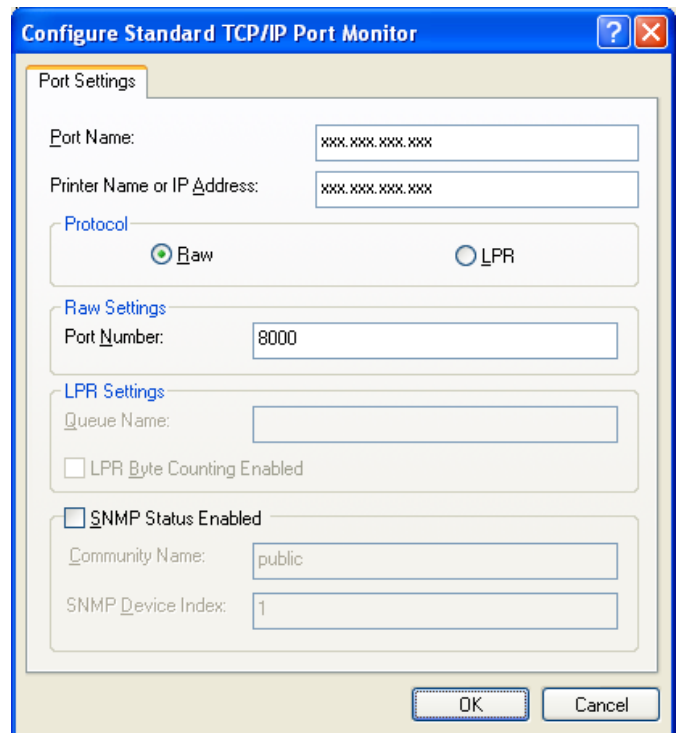

8. Click the [Next] button, and [Finish] button.



9. When the “Add Standard TCP/IP Printer Port Wizard” is finished, a new port is added.

## 5.2 Deletion

1. Right-click the printer icon, and click the "Properties" to open the printer properties screen.

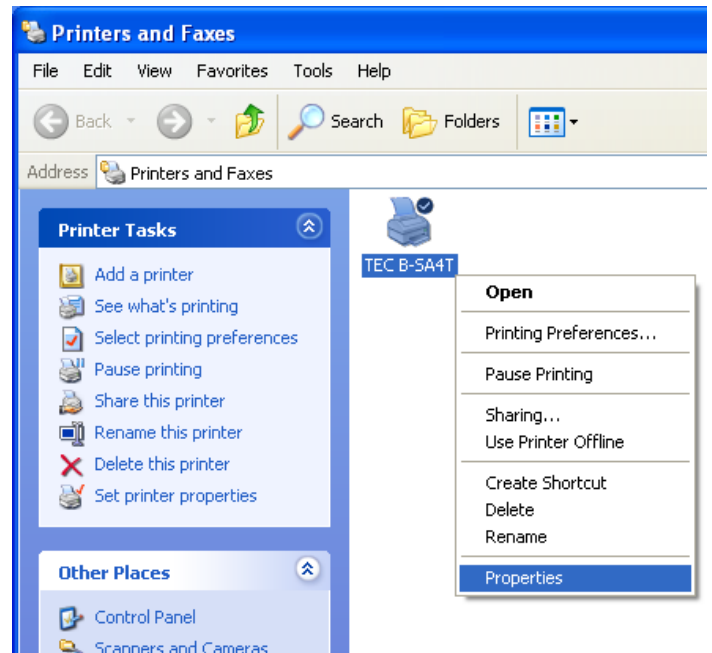

2. Select the [Ports] tab and click the [Delete Port] button.

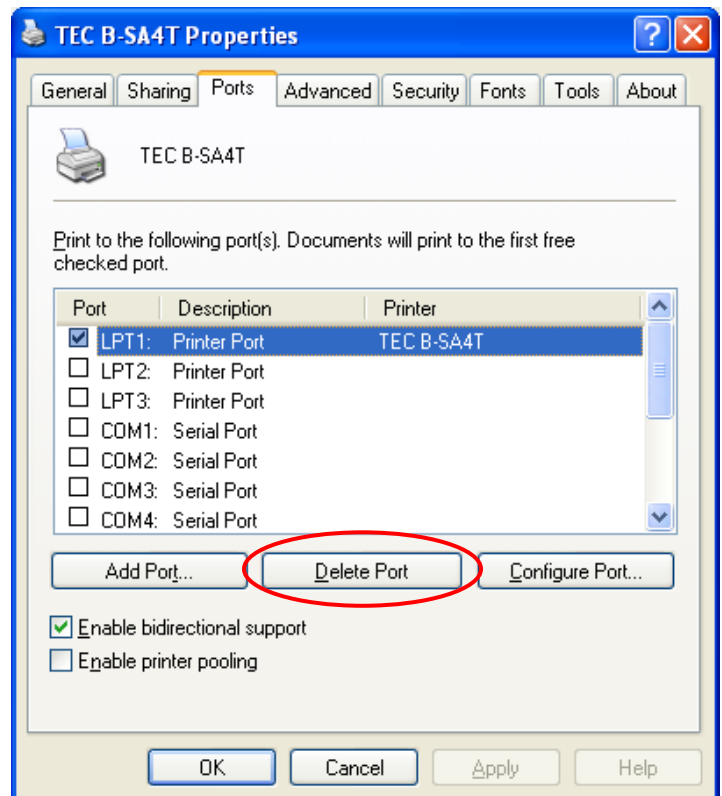

3. When the deletion of the port is completed, it is deleted from the print port.

## 6. Appendix

### 6.1 How to Enable Bi-directional Communication Support

1. Right-click the printer icon and open the Properties.

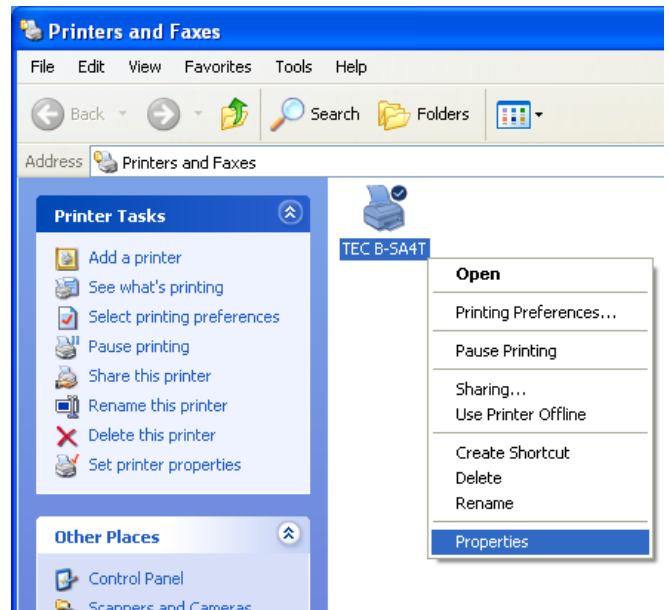

2. Click the [Port] tab.
3. To enable the bi-directional support, check the "Enable bi-directional support" checkbox.  
To disable the bi-directional support, remove the check from the "Enable bi-directional support" checkbox.

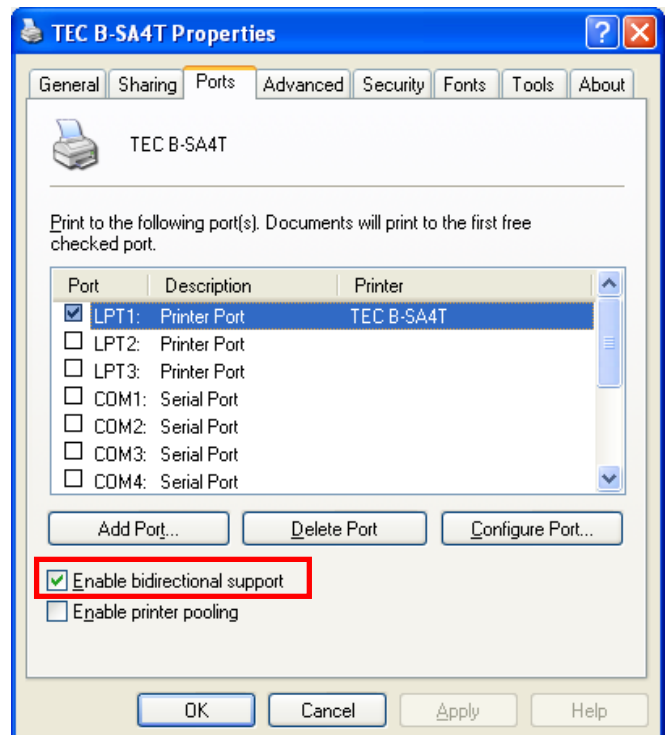

## 6.2 Parameter Setting on the Printer

For how to set the parameters, please refer to the Owner's Manual supplied with the connected TOSHIBA bar code printer.

**Note:** The following example is the parameter setting procedure for the B-SX5T.  
The "CENTRO. MODE" is set to "ECP" and "PLUG & PLAY" is set to "ON", respectively.

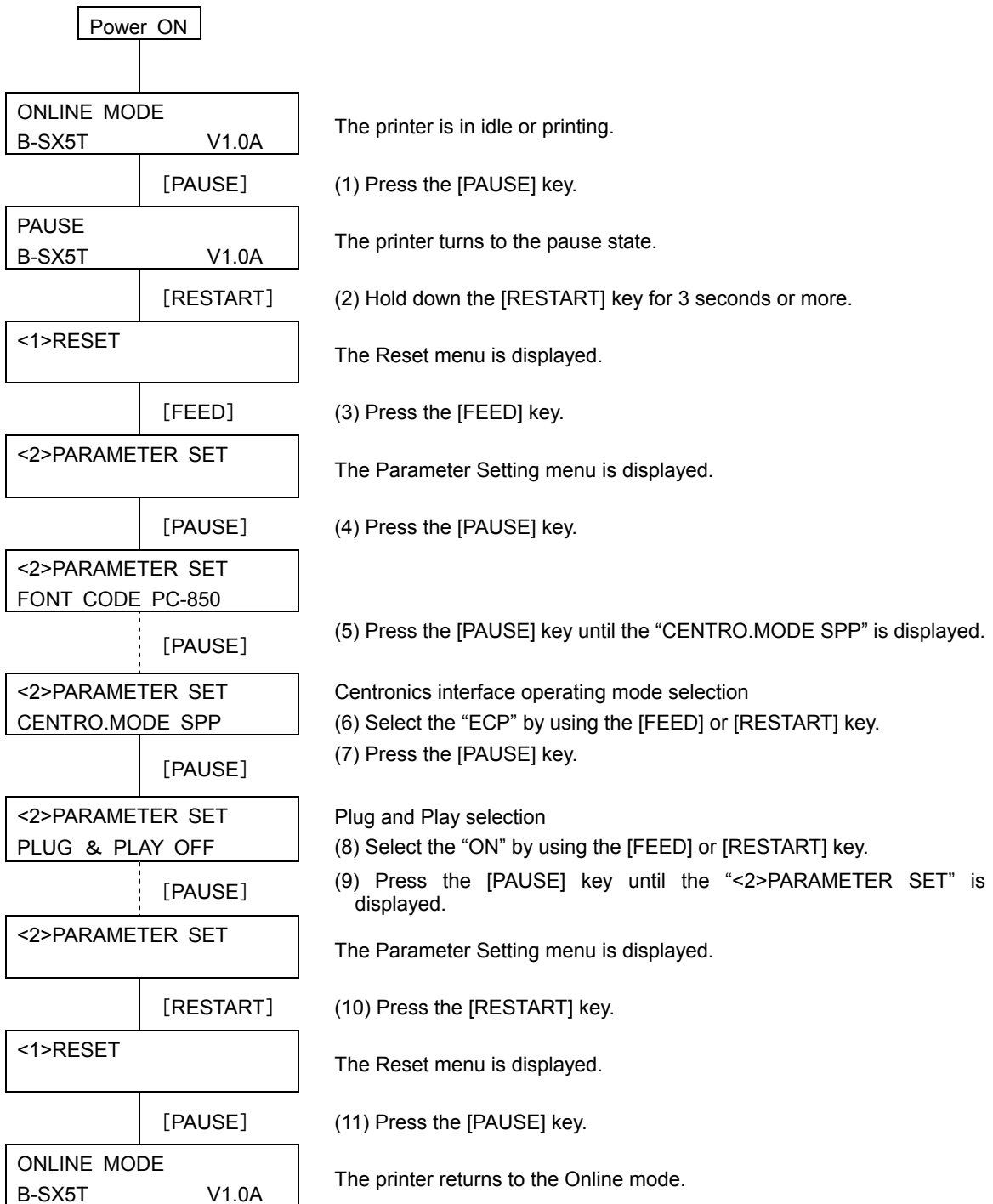

## 6.3 How to Connect the Printer to LAN

Right-click the printer icon, open the Properties, add a printer port, and specify it as an output port.

The output port to be used differs depending on the printer models and communication methods (unidirectional/bi-directional).

### ■ Printer Port Types

LAN interface	Printer model	Method	Printer board Standard TCP/IP Port
Optional LAN board			
B-7704-LAN-QM	B-452-TS	Unidirectional	Raw or LPR protocol
B-7708-PC-QM	B-852 B-492	Unidirectional	Raw or LPR protocol
B-8700-PC-QM	B-482 B-682 B-882	Unidirectional	Raw or LPR protocol
B-SV704-LAN-QQ/ QP-R	B-SV4D (Except GS12) B-SV4T	Unidirectional	Raw or LPR protocol
B-9700-PCM-QM-R	B-SX4T B-SX5T	Unidirectional	Raw or LPR protocol
B-9700-LAN-QM-R		Bi-directional	Raw protocol
Standard feature			
B-SA4 B-852-R B-452-R B-SP2D-GH40 B-EP2DL-G B-EP4DL-G B-SV4D-GS12-QM-R B-EV4-G B-EV4-T B-SX6T B-SX8T B-EX4T1-G B-EX4T1-T B-EX4T2-G B-EX4T2-T B-EX4T2-H		Unidirectional	Raw or LPR protocol
		Bi-directional	Raw protocol

**Note:** In the case of the unidirectional communication, be sure to disable the [Printer Status Monitoring].



**TOSHIBA TEC CORPORATION**

## Free Manuals Download Website

<http://myh66.com>

<http://usermanuals.us>

<http://www.somanuals.com>

<http://www.4manuals.cc>

<http://www.manual-lib.com>

<http://www.404manual.com>

<http://www.luxmanual.com>

<http://aubethermostatmanual.com>

Golf course search by state

<http://golfingnear.com>

Email search by domain

<http://emailbydomain.com>

Auto manuals search

<http://auto.somanuals.com>

TV manuals search

<http://tv.somanuals.com>