

User's Manual

TOSHIBA FOLIO 100

Introduction

Welcome and thank you for choosing a TOSHIBA product.

For your convenience, your TOSHIBA product is furnished with two guides:

- a Quick Start Guide, and
- this comprehensive PDF User's Manual.

We recommend to backup the User's Manual onto an external device.

Please backup your data that is saved in internal storage before updating the platform.

Table of Contents

Introduction	2
Check the components	6
Safety instructions	6
Getting Started & Grand Tour	
Getting Started	9
Grand Tour	14
Power conditions	17
Basic Operations & Home screen	
Using the Touch Screen	18
Getting to know the TOSHIBA HOME Menu screen	19
Opening and switching applications	21
Opening the Settings screen	21
Working with menus	21
Monitoring your device's status	22
Managing Notifications	23
Locking your screen	24
Customizing the Home screen	24
Changing the Screen Orientation	26
Screen Capture	26
Factory Reset	26
Connecting to networks	
Connecting to mobile networks	27
Connecting to Wi-Fi networks	28
Connecting to Bluetooth devices	31
Applications & Widgets	
Analog clock	33
Browser	33
Calculator	35
Camera	35
Clock	37
Contacts	38
Documents To Go	40
Email	40

Evernote	41
FBReader.....	41
fring	42
Gallery	42
Messaging.....	43
Music	45
Online Manual.....	46
Opera Mobile.....	46
Picture frame.....	47
Power Control.....	47
Search	47
SingleClick Connect.....	47
Sound Recorder	48
TOSHIBA File Manager.....	49
TOSHIBA Media Player.....	51
TOSHIBA Service Station.....	52
Settings	
Settings	54
Desktop settings.....	60
Hardware & Options Operation	
Hardware.....	61
Optional devices.....	69
Optional accessories	77
Troubleshooting	
Problem solving process.....	78
Hardware and system checklist	79
TOSHIBA Support.....	81
Specifications	
Physical Dimensions	82
Environmental Requirements	82
Regulatory information	
Copyright.....	83
Disclaimer	83
Trademarks	84
AVC/H.264 License Notice	85
CE compliance	85
Indication of the countries.....	85
Indication of restrictions of use	85
Working environment.....	86
Additional environments not related to EMC.....	86

REACH - Compliance Statement	86
Following information is only valid for EU-member States:	87
Wireless LAN and your Health	87
Additional information	88

Check the components

Check to make sure you have all of the following items:

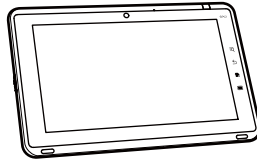

TOSHIBA FOLIO 100

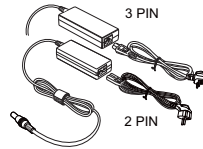

AC Adaptor
(2 pin or 3 pin)

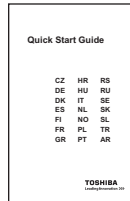

Quick Start Guide

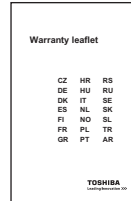

Warranty leaflet

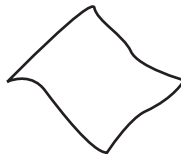

Cleaning cloth

Safety instructions

- Always read the safety instructions carefully:
- Do not disassemble, modify, tamper with or repair your product. Disassembly, modification, tampering or repairing the product could cause fire or electric shock, possibly resulting in serious injury. Please contact an authorized Toshiba service provider for any repair service.
- When handling the power cable/cord, follow these precautions:
 - Never tamper with the power cable/cord or plug.
 - Never splice, alter, bend or twist a power cable/cord.
 - Never pull on a power cable/cord to remove a plug from a socket.
 - Never place heavy objects on a power cable/cord.
 - Never run a power cable/cord through a pinch point such as a door or window.
 - Never place a power cable/cord near a heat source.
 - Never use nails, staples or similar objects to fasten or attach cord in place.

- Never attempt to disassemble or repair an AC adaptor.

Doing any of the above may damage the cables, and/or result in a fire or electric shock, possibly resulting in serious injury.

- Always confirm that the power plug (and extension cable plug if used) has been fully inserted into the socket, to ensure a secure electrical connection. Failure to do so may result in a fire or electric shock, possibly resulting in serious injury.
- Be careful if you use a multiple connector. An overload on one socket could cause a fire or electric shock, possibly resulting in serious injury.
- If dust gets on the power plug connectors or connector base, turn the power off and disconnect the power plug. Then clean the connector and/or connector base with a dry cloth. Continuing to use the product without cleaning the power plug may result in a fire or an electric shock, possibly resulting in serious injury.
- Always use the TOSHIBA AC adaptor that was provided with your product, or use AC adaptors specified by TOSHIBA to avoid any risk of fire or other damage to the product. Use of an incompatible AC adaptor could cause fire or damage to the product possibly resulting in serious injury. TOSHIBA assumes no liability for any damage caused by use of an incompatible adaptor or charger.
- Never plug the AC adaptor into a power source that does not correspond to both the voltage and the frequency specified on the regulatory label of the unit. Failure to do so could result in a fire or electric shock, possibly resulting in serious injury.
- Never attempt to connect or disconnect a power plug with wet hands. Failure to follow this instruction could result in an electric shock, possibly resulting in serious injury.
- Never leave small parts such as covers, caps and screws within the reach of infants or small children. Swallowing a small part may cause choking and suffocation resulting in death or serious injury. If a part is swallowed, immediately take appropriate emergency action and consult a doctor.
- Never allow any liquids to spill into any part of your product, and never expose the product to rain, water, seawater or moisture. Exposure to liquid or moisture can cause electric shock or fire, resulting in damage or serious injury. If any of these eventualities should accidentally occur, immediately:
 1. Turn off the product.
 2. Disconnect the AC adaptor from the power plug socket and product. Do not turn on the power again, until you have taken the product to an authorized service center. Failure to follow these instructions could result in serious injury or permanent damage to the product.
- Never place your product or AC adaptor on a wooden surface, furniture, or any other surface that could be marred by exposure to heat since the product base and AC adaptor's surface increase in temperature during normal use.

- Always place your product or AC adaptor on a flat and hard surface that is resistant to heat damage.
- Never place your product where it will be exposed to excess heat, such as in direct sunlight, an unventilated vehicle or near a heater. This may result in a system failure, malfunction, loss of data or damage to the product.
- Never place your product in a location where it will be exposed to extremely low temperatures. This may result in a system failure, malfunction or loss of data.
- Never subject your product to sudden temperature variations. This may result in condensation, causing a system failure, malfunction or loss of data.
- Never operate your product on AC power during a thunderstorm. If you see lightning or hear thunder, immediately turn off the product. An electric surge caused by the storm, may result in a system failure, loss of data or hardware damage.
- Always use the battery pack supplied as an accessory or an equivalent battery pack specified in the User's Manual. Other battery packs have different voltage and terminal polarities. Use of non-conforming battery packs could generate smoke or cause fire or rupture, possibly resulting in serious injury.

Getting Started & Grand Tour

This chapter provides an equipment checklist, grand tour of your device and basic information to start using your device.



Some of the features described in this manual may not function properly if you use an operating system that was not pre-installed by TOSHIBA.

Getting Started



■ All users should be sure to read the section [Initial Setup](#).

This section provides basic information to start using your device. It covers the following topics:

- Connecting the AC adaptor
- Turning on the power
- Initial Setup
- Device options menu
- Turning off the power



- *Use a virus-check program and make sure it is updated regularly.*
- *Never format storage media without checking its content - formatting destroys all stored data.*
- *It is a good idea to periodically back up main storage device to external media. General storage media is not durable or stable over long periods of time and under certain conditions may result in data loss.*

Connecting the AC adaptor

The AC adaptor can automatically adjust to any voltage ranging from 100 to 240 volts and to a frequency of either 50 or 60 hertz, enabling you to use this product in almost all country/region. The adaptor converts AC power to DC power and reduces the voltage supplied to this device.

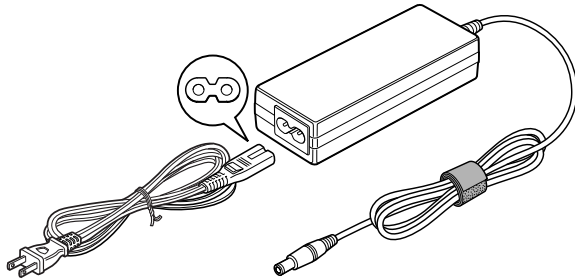

(Sample Illustration) The AC adaptor (2-pin plug)

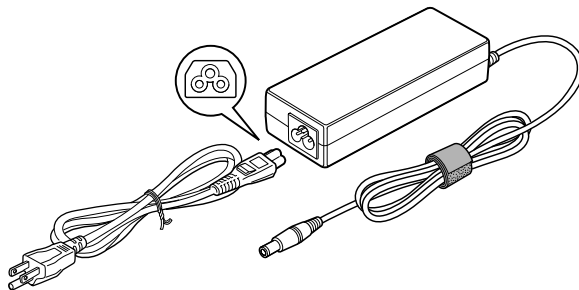

(Sample Illustration) The AC adaptor (3-pin plug)



- Depending on the model, either a 2-pin or 3-pin adaptor/power lead will be bundled with the device.
- Do not use a 3-pin to 2-pin conversion plug.
- The supplied power cord conforms to safety rules and regulations in the region the device is bought and should not be used outside of this region. In order to use the adaptor/device in other regions, you should please buy a power cord that conforms to the safety rules and regulations in that particular region.

Attach the AC adaptor when you need to charge the battery or you want to operate from AC power. It is also the fastest way to get started, because the battery pack will need to be charged before you can operate from battery power.



- *Always use the TOSHIBA AC adaptor that was included with your device, or use AC adaptors specified by TOSHIBA to avoid any risk of fire or other damage to the device. Use of an incompatible AC adaptor could cause fire or damage to the device possibly resulting in serious injury. TOSHIBA assumes no liability for any damage caused by use of an incompatible adaptor.*
- *Never plug the AC adaptor into a power source that does not correspond to both the voltage and the frequency specified on the regulatory label of the unit. Failure to do so could result in a fire or electric shock, possibly resulting in serious injury.*
- *Always use or purchase power cables that comply with the legal voltage and frequency specifications and requirements in the country of use. Failure to do so could result in a fire or electric shock, possibly resulting in serious injury.*
- *The supplied power cord conforms to safety rules and regulations in the region the device is bought and should not be used outside this region. For use in other regions, please buy power cords that conform to safety rules and regulations in the particular region.*
- *Do not use a 3-pin to 2-pin conversion plug.*
- *When you connect the AC adaptor to the device, always follow the steps in the exact order as described in the User's Manual. Connecting the power cable to a live electrical outlet should be the last step otherwise the adaptor DC output plug could hold an electrical charge and cause an electrical shock or minor bodily injury when touched. As a general safety precaution, avoid touching any metal parts.*
- *Never place your device or AC adaptor on a wooden surface, furniture, or any other surface that could be marred by exposure to heat since the device base and AC adaptor's surface increase in temperature during normal use.*
- *Always place your device or AC adaptor on a flat and hard surface that is resistant to heat damage.*

1. Connect the power cord to the AC adaptor.
2. Connect the AC adaptor's DC output plug to the DC IN 19V jack on the right side of the device.
3. Plug the power cord into a live wall outlet - the **Power/Battery** indicator on the display panel of the device should glow.

Turning on the power

This section describes how to turn on the power - the **Power/Battery** indicator will then indicate the status.



- After you turn on the power for the first time, do not turn it off until you have set up the operating system. Please refer to the section [Initial Setup](#) for more information.

Press the power button at the top of the device to turn on the power.

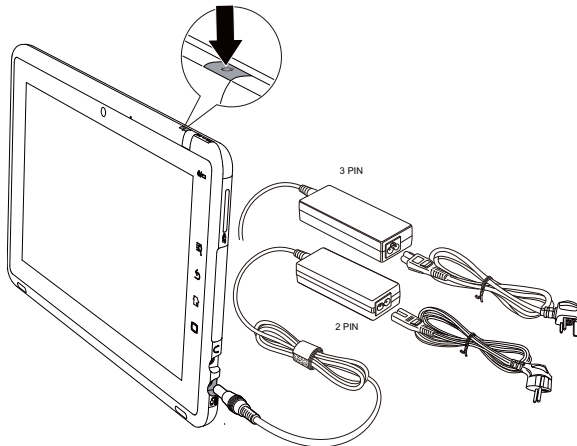

(Sample Illustration) Turn on the device

Initial Setup

The Setup Screen will be the first screen displayed when you turn on the power. Setup your device according to the following steps:

1. In **Language/Date & Time Settings**, choose the language as you want and then set the time zone, date and time. Tap **Next** to continue.
2. In **Wi-Fi Settings**, turn on the **Wifi**. Choose an available network and connect to it. Tap **Next** to continue.
You may also skip this section and turn Wifi on later in **Settings** window.
3. In **EULA Agreement**, tap **I accept** and then tap **Finish setup** to complete the whole setup process.

Device options menu

The device provides you with an option menu where you can quickly change the mode of your device:

To open the Device options menu, press the power button for about two seconds. The menu will be displayed with the following options: **Silent mode**, **Airplane mode**, **Power off** and **Suspend**.

Turning off the power

The power can be turned off in one of two modes, either Shut Down Mode or Suspend Mode. You can also turn the LCD off in order to extend the battery life.

Shut Down Mode

When you turn off the power in Shut Down Mode no data will be saved and the device will boot to the operating system's main screen the next time it is turned on.

1. If you have entered data, either save it to flash memory or to other storage media.

- Select **Power off** from the Device options menu.



- *Never turn off the power while an application is running. Doing so could cause loss of data.*
- *Never turn off the power, disconnect an external storage device or remove storage media during data read/write. Doing so can cause data loss.*
- *In any emergency case, you can also press the power button for about six seconds to force power off.*

2. Turn off any peripheral devices connected to the TOSHIBA FOLIO 100 device.



Do not turn the device or peripheral devices back on immediately - wait a short period to avoid any potential damage.

Suspend Mode

If you have to interrupt your work, you can turn off the power without exiting from your software by placing the device into Suspend Mode.



- *Before entering Suspend Mode, be sure to save your data.*
- *Do not remove the battery pack while the device is in Suspend Mode unless the device is connected to an AC power source. Data in memory could be lost.*

Executing Suspend Mode

You can enter Suspend Mode in one of the following ways:

- Select **Suspend** from the Device options menu.
- Press the power button.

When you turn the power back on, you can continue where you left when the system went into Suspend mode.

Resuming from Suspend Mode

You can resume from Suspend Mode in the following way:

- Press the power button again.

Turn the LCD off/on

You can turn the LCD off (while the system is still on) in the following ways:

- Press the power button.
- Set the screen timeout in the **Settings**.

To turn the LCD on:

- Press the power button again.

Grand Tour



Please handle your product carefully to avoid scratching or damaging the surface.



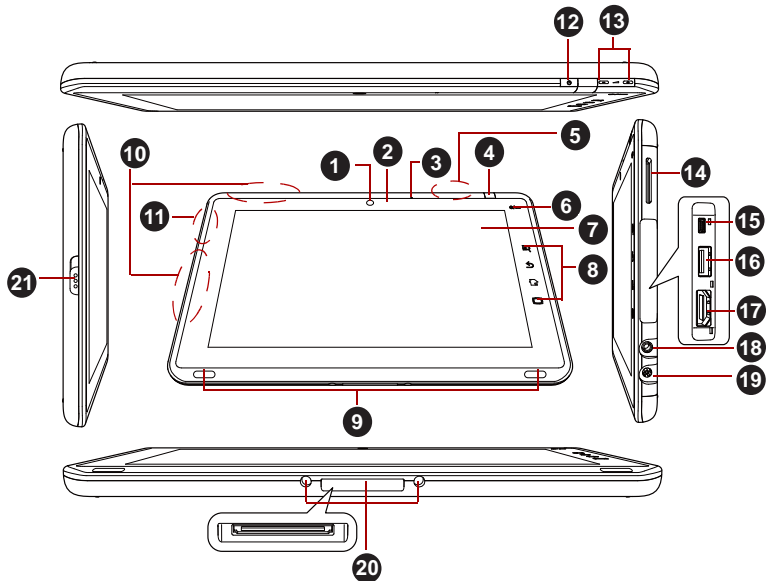

The following figures show the grand tour of your device.



- | | |
|--------------------------------------|---|
| 1. Web Camera | 12. Power button |
| 2. Web Camera LED | 13. Volume down/up buttons |
| 3. Microphone | 14. SD card slot |
| 4. CIR in Window | 15. Mini USB port |
| 5. Wireless LAN antenna (not shown)* | 16. Universal Serial Bus (USB 2.0) port |
| 6. Power/Battery indicator LED | 17. HDMI out port |
| 7. Display screen | 18. Headphone/Microphone jack |
| 8. Operation buttons | 19. DC IN 19V jack |
| 9. Speakers | 20. Docking interface |
| 10. 3G antennas (not shown)* | 21. Cover lock |
| 11. Bluetooth antenna (not shown)* | |

*Provided with some models.

(Sample Illustration) Grand tour of the device

	Web Camera	Web Camera is a device that allows you to record video or take photographs with your product.
	Web Camera LED	The Web Camera LED will glow blue when the Web Camera is in operation.
	Microphone	A built-in microphone allows you to import and record sounds for your application.
	CIR in window	CIR in window receives signals from the remote controller to control your device or applications.
	Wireless LAN antenna	Some models are equipped with a Wireless LAN antenna.
	Power/Battery indicator LED	The Power/Battery indicator LED normally glows white when the device is turned on and the AC adapter is connected. It will blink amber when the device is in Suspend mode. For details, please refer to Power conditions section.
	Display screen	Display screen brightness can be adjusted in the Display settings .
	Operation buttons	There are four operation buttons provided on the display panel: Search (⌕), Back (⏪), Home (🏠) and Menu (☰).
	speakers	The speakers emit sound generated by your software as well as audio alarms, such as low battery condition, generated by the system.
	3G antennas	some models are equipped with the 3G antennas.
	Bluetooth antenna	Some models are equipped with a Bluetooth antenna.
	Power button	Press this button to turn the device's power on and off.
	Volume down/up buttons	Press these buttons to increase or decrease the volume.
	SD card slot	This slot lets you insert an SD™/SDHC™ memory card and miniSD™/microSD™ Card. Please refer to the SD card slot section in “Hardware & Options Operation” chapter for details.



Keep foreign metal objects, such as screws, staples and paper clips, out of the SD card slot. Foreign metal objects can create a short circuit, which can cause damage and fire, possibly resulting in serious injury.



Mini USB port

Mini USB port allows you to connect this device to your computer, which can be used to transfer files.

Please refer to the [Mini USB port](#) section in “Hardware & Options Operation” chapter for details.



Universal Serial Bus (USB 2.0) port

One Universal Serial Bus port, which complies to the USB 2.0 standard, is provided.

Please refer to the [USB device](#) section in “Hardware & Options Operation” chapter for details.



Keep foreign metal objects, such as screws, staples and paper clips, out of the USB port. Foreign metal objects can create a short circuit, which can cause damage and fire, possibly resulting in serious injury.



Please note that it is not possible to confirm the operation of all functions of all USB devices that are available. In view of this it may be noted that some functions associated with a specific device might not operate properly.



HDMI out port

HDMI out port can connect with Type A connector HDMI cable.

You can send video and audio signals via HDMI cable. In addition to this, you can send and receive control signals via it.

Please refer to the [HDMI device](#) section in “Hardware & Options Operation” chapter for details.



Headphone/ Microphone jack

A 3.5 mm mini headphone/microphone jack enables connection of a monaural microphone or a stereo headphone.



Both the internal and external microphones will be disabled if you use a headset other than a 4-pin headset headphone.

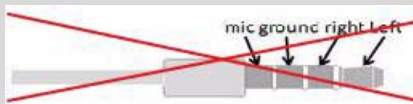

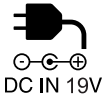
**DC IN 19V jack**

The AC adaptor connects to this jack in order to power the device and charge its internal batteries. Please note that you should only use the model of AC adaptor supplied with the device at the time of purchase - using the wrong AC adaptor can cause damage to the device.

Docking interface

The interface enables the connection of an optional dock described in *Hardware & Options Operation* chapter.

Cover lock

Slide this lock to the unlock () position in order to remove the back cover.

Power conditions

The device's operating capability and battery charge status are affected by different power conditions, including whether an AC adaptor is connected, whether a battery pack is installed and what the charge level is for that battery.

		Power on	Suspend	Power off (no operation)
AC adaptor not connected	Battery fully charged	• LED: Green	• LED: Blink amber slowly	
	Battery partially charged or no charge	• LED: Amber or blink amber quickly	• LED: Blink amber slowly	• LED: Off
	No battery installed	• LED: Off	• LED: Off	
AC adaptor connected	Battery fully charged			• LED: Green
	Battery partially charged or no charge	• LED: White	• LED: Blink amber slowly	• LED: Amber
	No battery installed			• LED: Off

Basic Operations & Home screen

This chapter describes the basic operations of your device and the Home screen.

Using the Touch Screen

You can use your finger to manipulate icons, buttons, menu items, the onscreen keyboard, and other items on the touch screen. You can also change the screen's orientation.

■ Tap

Simply tap your finger on the touch screen to act on items on the screen, such as application and settings icons, to type letters and symbols using the onscreen keyboard, or to tap onscreen buttons.

■ Tap & hold

Tap & hold an item on the screen by tapping it and not lifting your finger until an action occurs. For example, to open a menu for customizing the Home screen, you tap an empty area on the Home screen until the menu opens.

■ Drag

Tap & hold an item for a moment and then, without lifting your finger, move your finger on the screen until you reach the target position. You can drag items on the Home screen to reposition them.

■ Swipe or slide

To swipe or slide, you quickly move your finger across the surface of the screen, without pausing when you first touch it (so you don't drag an item instead). For example, you slide the screen up or down to scroll a list.

Getting to know the TOSHIBA HOME Menu screen

The **TOSHIBA HOME Menu** screen is your starting point for using all the installed applications on your device. You can customize the **TOSHIBA HOME Menu** screen to display the application icons, shortcuts and folders you prefer.

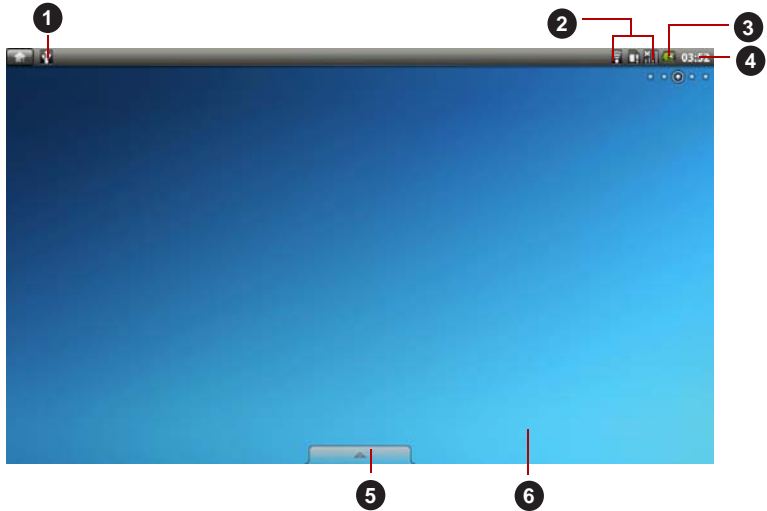

- 1. Notification area
- 2. Signal strength
- 3. Battery Status

- 4. Time
- 5. Launcher tab
- 6. Desktop

(Sample Illustration) Home screen

Item	Description
Notification area	Indicates a new event, such as an Email received.
Signal strength	Indicates the connection status and signal strength.
Battery Status	Indicates the battery charge status.
Time	Shows the time and date.
Launcher tab	Shows all the applications installed in your system.
Desktop	Shows the icons of any applications, widgets or folders you put on the screen.

The Launcher tab

At the bottom of your screen is the **Launcher** tab. Tap the launcher tab icon () to open it as shown below:



(Sample Illustration) Tapping the Launcher tab

This shows icons for all the applications/widgets installed on your device. You may also switch the view mode to tile mode by tapping the tile mode icon in the lower right of the Home menu screen.

Extending of the Home screen

The Home screen extends beyond the screen width to provide more space for adding icons, widgets, shortcuts and other items. You may move to the right or left side of the extended home screen by:

- Sliding your finger on the touch screen.
- Pressing and holding the left mouse button, and then moving the mouse towards left or right.

If you have already setup a screen name, a tooltip message showing the screen name (such as **MyHome**) will be displayed for 3 seconds when switching the screen automatically.

Small dots at the top right corner of the screen indicate which screen is currently being viewed.

Opening and switching applications

The Launcher tab, which you can open from the Home screen, holds icons for all the applications on your device, including any applications that you downloaded and installed.

Opening an application

You may open any application by:

- Tapping an application icon on the Home screen
- Tapping an application icon from the Launcher tab.

Switch to a recently used application

You may switch to any recently used application by:

- Tapping **HOME** () for about two seconds.



*The executed applications will be hidden if you tap **HOME** ()*.

Opening the Settings screen

This device provides several ways to open the **Settings** screen where settings can be customized.

- Tap **Menu** () , and then tap **Settings**.
- Tap the **Launcher** tab -> **Settings** -> **Settings**.

Working with menus

There are two kinds of menus: the **Options** menu and the **Context** menu.



- *When you tap and hold on an icon or thumbnail picture, a sub menu will be displayed if it's available.*
- *If an application has a sub menu, you can display it by tapping **Menu**.*

Options Menu

The **Options** menu contains tools that apply to the activities related to the current screen or application, not to any specific item on the screen. Not all screens have an **Options** menu. Some screens have more **Options** menu items than can fit in the main menu. You can tap **More** to open a menu of additional items.

Context Menu

The **Context** menu contains tools that apply to a specific item on the screen. You may open a context menu by tapping and holding an item on the screen. Not all items have context menus.

Monitoring your device's status

The status bar appears at the top of every screen. It displays icons indicating that you have received notifications and icons indicating the device's status, along with the current time.



The following icons are only some sample icons. Not all status icons are listed here.







Status icons

The following icons indicate the status of your device.

	Connected to a Wi-Fi network		Battery is very low
	Bluetooth is on		Battery is partially drained
	Connected to a Bluetooth device		Battery is full
	Airplane mode		Battery is charging

Notification icons

The following icons indicate different types of notifications. In addition to these icons, applications you installed on your device may use their own notification icons.

	Uploading data		Downloading data
	Problem with sign in or sync		Alarm is set
	An open Wi-Fi network is available		TOSHIBA Service Station

Managing Notifications

Notification icons report the arrival of new messages, calendar events, and alarms, as well as ongoing events.

When you receive a notification, its icon appears in the Status bar, along with a summary that appears only briefly. For a table of notification icons, see “Notification icons”.

You can open the Notifications panel to view a list of all your notifications. Depending on your settings and the model of your device, you may also hear a notification sound.

Adjusting sound volume and other general notifications settings is described in the [Sound](#) settings in “Settings” chapter.

Applications that produce notifications, such as Email, have their own settings, which you can use to configure whether and how they send notifications. See the sections on those applications for details.

Opening the Notifications panel

Tap the status bar to open the notifications panel. The notifications panel displays a scrolling list of your current notifications. Notifications about ongoing activities are listed first, followed by notifications about events, such as a new mail notifications.

Responding to a notification

To respond to a notification, follow the below steps:

1. Open the notifications panel.
Your current notifications are listed in the panel, each with a brief description.
2. Tap a notification to respond to it.
The notifications panel closes. What happens next depends on the notification. For example, network disconnect notifications open the list of configured networks so you can reconnect.

Clearing all notifications

To clear all notifications, follow the steps listed below:

1. Open the notifications panel.
2. Tap **Clear** at the top right of the panel.
All event-based notifications will be cleared while ongoing notifications remain in the list.

Closing the Notifications panel

Tap the tab at the bottom of the notifications panel to the top of the screen. The panel also closes when you tap a notification to respond to it.

Locking your screen

You can lock your screen so that only you can unlock it to access your data, run applications and so on. See [Location & security](#) section for other ways to protect your device and privacy.

Locking your screen

1. Open the **Location & security** settings by tapping the **Launcher** tab -> **Settings** -> **Settings** -> **Location & security**.
2. Tap **Set up unlock pattern** -> **Pattern**.

The first time you open it, a short tutorial about creating an unlock pattern will appear. Then you're prompted to draw and redraw your own pattern. Follow the onscreen instructions to finish the creation.

The next time you turn on your device or wake up the screen, you will be prompted to draw your unlock pattern to unlock the screen.

Customizing the Home screen

You can add application icons, folders, shortcuts, widgets and other items to any part of the Home screen. You can also change the wallpaper.

Adding an item to the Home screen

To add an item to the Home screen, follow the steps listed below:

1. Open the Home screen pane where you want to add the item.
2. Tap the **Launcher** tab and select the category **Applications**, **Widgets**, **Bookmarks** or **Settings**.
3. Tap on an item and hold until its icon magnifies.
4. Drag the item to desktop area.

You can also add the **Shortcuts**, **Widgets**, **Folders** and **Wallpapers** to the Home screen by:

- Tapping and holding an empty area of the Home screen.
- Tapping **Menu** and then tapping **Add**.

A dialog with four options will appear where you can make your selection.

■ Shortcuts

Add shortcuts to applications, a bookmarked webpage, a favorite contact, a music playlist, and many other items.

The shortcuts available depend on the applications you have installed.

■ Widgets

Add any of a variety of miniature applications (widgets) to your Home screen, including a clock, a music player, a picture frame, the Google search bar. You can also download widgets from other websites.

■ Folders

Add a folder where you can organize Home screen items, or folders that contain all your contacts, Bluetooth received, contacts with phone numbers. Your folders' contents are kept up to date automatically.

■ Wallpapers

Add a wallpaper you wish or change the wallpaper for your Home screen from the **Gallery**, **Live wallpapers** or **Wallpaper gallery**.

You can also change the wallpaper from the **Desktop settings**. See the [Desktop settings](#) section in "Settings" chapter for details.

Moving an item on the Home screen

To move an item on the Home screen, follow the steps below:

1. Tap and hold the item you want to move until its icon is magnified. Don't lift your finger from the screen or release the mouse.
2. Drag the item to a new location on the screen.
It will pause at the left or right edge of the screen to drag the item onto extended Home screen.
3. When the item is at where you want it, lift your finger or release the mouse.

Removing an item from the Home screen

To remove an item from the Home screen, follow the steps below:

1. Tap and hold the item you want to remove until its icon is magnified.
The Launcher tab icon changes to a Trash bin icon.
2. Drag the item to the Trash bin icon.
3. When the icon glows, lift your finger or release the mouse.

Renaming a folder

To rename a folder, follow the below steps:

1. Tap the folder to open it.
2. Tap and hold the folder window's title bar.
3. Enter a new name in the dialog that appears.
4. Tap **OK**.

Changing the Screen Orientation

You can change the screen orientation to Portrait mode by rotating the device sideways. The screen orientation automatically changes according to the rotation angle detected.

You can also lock the auto rotation and use the device always in Portrait or Landscape mode. These settings can be performed in the **Display** settings. Please refer to [Display](#) section for details.



- *Always make sure to keep the Web camera on the top (Landscape mode) or on the right (Portrait mode) while rotating.*
- *In the Portrait mode, some drivers/utilities may not perform install and uninstall operation. If it occurs, switch to the Landscape mode to proceed.*

Screen Capture

This device allows you to perform the screen capture function.

You can start to capture in the following way:

- Tap and hold **Search** (🔍) and then tap **Menu** (☰).

Factory Reset

The device provides you the function to reset your device. Before executing this function, you need to backup the system settings, application settings, user installed applications and data in the internal storage.

To perform the factory data reset, please follow the steps below:

1. Tap **Settings** -> **Privacy** -> **Factory data reset**.
2. The factory data reset would be done.



- *Please note that the following data will be erased:*
 - *System settings and application settings*
 - *user installed applications*
 - *internal storage files, such as music or photos*
 - *Data in the removable media will not be erased.*

You can also reset the device by powering on your device while pressing the **Volume up** button (⏮).



- *You need to press the **Volume up** button until a message appears on the screen.*

Connecting to networks

Your device can connect to a variety of networks and devices, mobile networks for voice and data transmission, Wi-Fi data networks and Bluetooth devices, such as headsets. This chapter will describe how to connect to different networks.

Connecting to mobile networks



This section only applies to models with 3G modules.

When you assemble your device with a SIM card from your wireless service provider, your device is configured to use your provider's mobile networks for transmitting data.

Your device is configured to work with many mobile carriers' networks. If your device does not connect to a network when you insert a SIM card and turn it on, contact your carrier to obtain the details of its access point name.

The icons in the Status bar indicate which kind of data network you're connected to and the voice and data network signal strength.

	Connected to the fastest 3G networks (UMTS or HSDPA)
	Connected to the second-fastest network (EDGE)
	Connected to a 2G network (GPRS)
	The more bars are lit, the stronger the wireless signal
	Connected to another wireless service provider's network (roaming)

Determining what network you're using

1. Open the **Settings** screen.
2. Tap **Wireless & networks** -> **Mobile networks** -> **Access Point Names**.
The name of the wireless service provider you are currently registered with is selected in the list.

Disabling data when roaming

1. Open the **Settings** screen.
2. Tap **Wireless & networks** -> **Mobile networks**, and uncheck **Data roaming**.
With **Data roaming** unchecked, you can still transmit data with a Wi-Fi connection.

Editing or creating a new access point

If you and your wireless service provider determine that you need to change the settings of your current access point name (APN) or to create a new one, you must obtain the APN and detailed settings from your provider.

1. Open the **Settings** screen.
2. Tap **Wireless & networks** -> **Mobile networks** -> **Access Point Names**.
3. Tap an existing APN to edit it, or tap **Menu** and tap **New APN** to create a new one.
Enter the APN settings that you obtained from your wireless service provider by tapping each setting that you need to edit.
4. When you are finished, tap **Menu** and then tap **Save**.
If you have created a new APN, tap it in the APNs screen to start using it.

Connecting to Wi-Fi networks



Wi-Fi is a wireless networking technology that can provide Internet access at distances of up to 100 meters, depending on the Wi-Fi router and your surroundings.

To use Wi-Fi on your device, you need to access a wireless access point, or "hotspot". Some access points are open and you can simply connect to them. Others are hidden or implement other security features, so you must configure your device so it can connect to them.

There are numerous systems for securing Wi-Fi connections, including some that rely on secure certificates or other schemes to ensure that only authorized users can connect.

Turn off Wi-Fi when you are not using it to extend the life of your battery.

The Status bar displays icons that indicate Wi-Fi status.

	Connected to a Wi-Fi network (waves indicate connection strength)
	Notification that an open Wi-Fi network is in range

Turning Wi-Fi on and connecting to a Wi-Fi network

You may turn on and connect to a Wi-Fi network by following steps:

1. Open the **Settings** screen.
2. Tap **Wireless & networks** -> **Wi-Fi settings**.
3. Tap **Wi-Fi** to turn it on.

The device scans for available Wi-Fi networks and displays the names of those it finds. Secured networks are indicated with a Lock icon.



If the device finds a network that you connected to previously, it will connect to it automatically.

4. Tap a network to connect it.

If the network is open, you are prompted to confirm that you want to connect to that network by tapping **Connect**.

If the network is secured, you're prompted to enter a password or other credentials. (Ask your network administrator for details.)

When you're connected to a network, tap on the network name in the Wi-Fi settings screen for details about the speed, security, address, and related settings.

Connecting to a Wi-Fi network through WPS

If the network you want to connect is secured, you can also connect to it through WPS instead of entering a network name (SSID) and wireless security manually.

WPS (Wi-Fi Protected Setup) is a standard for easy and secure setup of a wireless home network. It enables you to establish a wireless network connection by pushing the WPS buttons (either physical or virtual) on both the access point and the new wireless client device.

To connect to a Wi-Fi network through WPS:

1. Tap **Wi-Fi Settings** -> **WPS** in the **Wireless & network settings**.
2. Push the WPS button on the access point.

Receiving notifications when open networks are in range

By default, when Wi-Fi is turned on, you will receive notifications in the Status bar when your device detects an open Wi-Fi network.

1. Turn on Wi-Fi if it is not already on.
2. In the **Wi-Fi settings** screen, check **Network notification**.
You can uncheck this option to stop receiving notifications.

Adding a Wi-Fi network

You can add a Wi-Fi network so the device will remember it, along with any security credentials, and connect to it automatically when it is in range. You must also add a Wi-Fi network to connect to it, if it does not broadcast its name (SSID), or to add a Wi-Fi network when you are out of range.

To join a secured network, you need to contact the network's administrator to learn what security scheme is deployed on it and to obtain the password or other required security credentials.

1. Turn on Wi-Fi if it is not already on.
2. In the **Wi-Fi settings** screen, check **Add Wi-Fi network**.
3. Enter the SSID (name) of the network. If the network is secured, tap the **Security** menu and then tap the type of security deployed on the network.
4. Enter any required security credentials.
5. Tap **Save**.

The device will connect to the wireless network. Any credentials that you enter will be saved, so you can connect automatically the next time you come within range of this network.

Forgetting a Wi-Fi network

You can make your device forget about the details of a Wi-Fi network that you added. For example, if you don't want the device to connect to it automatically or if it is a network that you no longer use.

1. Turn on Wi-Fi if it's not already on.
2. In the **Wi-Fi settings** screen, tap the name of the connected network.
3. Tap **Forget** in the dialog that opens.



Connecting to Bluetooth devices

Bluetooth is a short-range wireless communications technology that devices can use to exchange information over a distance of about 8 meters. The most common Bluetooth devices are headphones for making calls or listening to music, hands-free kits for cars, and other portable devices, including cell phones.

To connect to a Bluetooth device, you must turn on your device's Bluetooth radio. The first time you use a new device with the TOSHIBA FOLIO 100 device, you must "pair" them, so that they know how to connect securely to each other. After that, you can simply connect to a paired device.

Turn off Bluetooth when you're not using it, to extend the life of your battery between charges. You may also be required to turn Bluetooth off in some locations. Bluetooth is turned off in Airplane mode.

The Status bar displays icons that indicate Bluetooth status.

	Bluetooth is on
	Connected to a Bluetooth device

Turning Bluetooth on or off

1. Open the **Settings** screen.
2. Tap **Wireless & networks**.
3. Check or uncheck **Bluetooth** to turn it on or off.

Changing your device's Bluetooth name

Your device has a generic Bluetooth name by default, which is visible to other devices when you connect them. You can change the name so that it is more recognizable.

1. Open the **Settings** screen
2. Tap **Wireless & networks** -> **Bluetooth settings**.
The Bluetooth settings screen will be displayed.
3. If Bluetooth isn't turned on, check **Bluetooth** to turn it on.
4. Tap **Device name**. Enter a name and tap **OK**.

Pairing your device with a Bluetooth device

You must pair this device with another device before you can connect to it. Once you pair this device with another device, they stay paired unless you unpair them.

1. Open the **Settings** screen.
2. Tap **Wireless & networks** -> **Bluetooth settings**.
3. If Bluetooth is not turned on, check **Bluetooth** to turn it on.
Your device will scan for and display the Bluetooth names of all available Bluetooth devices in range.
4. If the device you want to pair with is not included in the list, make it discoverable. See the documentation that came with your device to learn how to make it discoverable by this device, and for other instructions for pairing.
5. If this device stops scanning before you make the other device discoverable, tap **Scan for devices**.
6. Tap on the Bluetooth name of the device in the list in settings to pair them.

The devices pair with each other. If you're prompted to enter a passcode, try entering 0000 or 1234 (the most common passcodes), or consult the documentation that came with the device to learn its passcode. If the pairing is successful, your device connects to the device.

Connecting to a Bluetooth device

Once paired, you can connect to a Bluetooth device. For example, to switch devices or to reconnect after your TOSHIBA FOLIO 100 device and this device come back into range.

1. Open the **Settings** screen.
2. Tap **Wireless & networks** -> **Bluetooth settings**.
3. In the list of Bluetooth devices, tap a paired but unconnected device.
If the device you expected isn't displayed, tap **Scan for devices**.
When your device and this device are connected, this device is shown as connected in the list.

Disconnecting from a Bluetooth device

1. Tap the device in the Bluetooth settings screen.
2. Tap **OK** to confirm that you want to disconnect.

Unpairing a Bluetooth device

You can unpair a Bluetooth device to erase all pairing information related to a specific device.

1. Tap and hold the device in the Bluetooth settings screen.
2. Tap **Unpair** or **Disconnect & unpair** in the menu that opens.

Applications & Widgets

This chapter describes the applications & widgets and how to use them.

Analog clock

Analog clock is a widget to display a clock in the Home screen based on the system time, so that you can watch time directly from the clock.

Simply launch it by tapping the **Launcher** tab -> **Widgets** -> **Analog clock**.

You can also use it to set an alarm clock. For details, please refer to the [Clock](#) section.

Browser

Browser is used to view webpages and to search for information on the web.

To open the Browser, tap the **Launcher** tab -> **Applications** -> **Browser**.

Browser can also open when you tap a web link, for example, in an email or text message.

When you open Browser, the last webpage you were viewing is displayed. If you have not used Browser recently, your home page will open.

Go to a webpage

1. Tap the URL box at the top of the Browser screen.
If the URL box isn't visible, drag the page down until the URL box comes into view.
2. Enter the address (URL) of the webpage by using the onscreen keyboard.
As you enter the address, Google web search will make suggestions of webpages and queries.
3. Tap a suggestion or enter an address and tap **Go**.
If you want to stop opening or refresh the page, tap **Menu** (☰) and then tap **Stop** or **Refresh**.



- The **Browser** cannot display some webpages correctly if the web page has a complicated layout. This is dependent on the web page.
- The **Browser** does not support file uploading function.
- The **Browser** might connect to a "mobile" web site rather than a "PC" web site, depending on the site. If you want to access the PC web site, please manually select the correct site or try using the Opera mobile browser.

Zoom in or zoom out on a webpage

1. Tap on the screen and slide slightly to reveal the zoom control icon ().
2. Tap the plus or minus side of the zoom control to zoom in or out.

Multiple Browser window operations

You can open several Browser windows (up to eight) and switch between them.

Open a new Browser window

You may open a new Browser window in the following ways:

- Tap **Menu** and select **New window**.
- Tap **Menu** and select **Windows**. In the screen that opens, tap **New window**.

New windows will open with your home page.

Switch between Browser windows

You may switch between different Browser windows.

Tap **Menu** and select **Windows**. All open windows are displayed. Select an existing window and tap to open it.

Close a Browser window

1. Tap **Menu** and select **Windows**.
All open windows are displayed in a scrolling list of thumbnails.
2. Tap the **Close** icon to close it.

View your Browser history

As you browse the web, Browser will keep track of the pages you visit, to help you find your way back later.

1. Tap the bookmark icon () at the top right of the screen.
2. Tap the **History** tab.
The pages you've visited are grouped chronologically. Bookmarked pages have a gold star.
3. Tap a time period to view the pages you've visited.
4. Tap a page in the history to reopen it.

Web page options

By tapping **Menu** () , you can access a number of settings to manage related web page settings: **New window**, **Bookmarks**, **Windows**, **Refresh**, **Forward**, **More**.

Browser settings

You can configure a number of Browser settings, including some that you can use to manage your privacy.

To open the Browser settings screen, tap **Menu** and tap **More** -> **Settings**.

There are four categories: **Page content settings**, **Privacy settings**, **Security settings** and **Advanced settings**.

Calculator

You can use **Calculator** to solve simple arithmetical problems or use its advanced operators to solve more complex equations.

1. Open Calculator as following:
Tap the **Launcher** tab -> **Applications** -> **Calculator**.
2. Enter numbers and arithmetical operators on the basic screen.
3. Tap **Menu** () to display **Advanced panel** or **Clear history**.
4. Tap and hold the Calculator's display to open a menu where you can copy what you've entered and access other tools.
5. Tap **CLEAR** to delete the last number or operator you entered. Tap and hold **CLEAR** to delete everything in the display.

Camera

Camera is a combination camera and camcorder that you use to shoot and share pictures and videos. Pictures and videos are stored in the Gallery.

Open Camera and take pictures/videos

You can take pictures and shoot videos with the Camera.

To open the Camera, tap the **Launcher** tab -> **Applications** -> **Camera**.

Camera will open in Landscape mode, ready to take a picture or shoot a video.

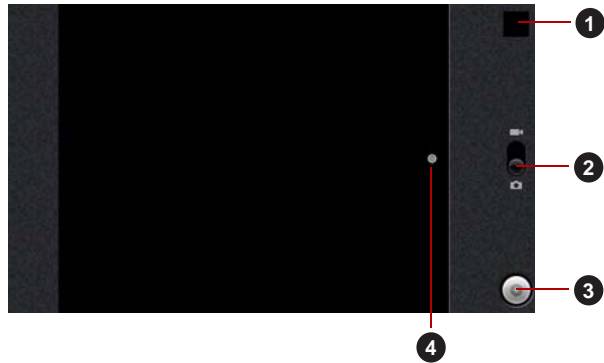

(Sample Illustration) Camera screen

1	Tap to preview your pictures or videos.
2	Drag up to record videos, or drag down to take photos.
3	Tap to take a picture or shoot a video.
4	Tap to change settings.

Review your pictures/videos

You can review the pictures/videos you've taken in **Camera**.

You can also view your pictures within the **Gallery** application, as described in the [Gallery](#) section.

1. Tap the thumbnail image at the top right of the Camera screen.
2. The picture/video view screen opens, displaying your most recent pictures/videos.
3. Use the onscreen buttons or options to view your pictures and videos.

Camera settings

Many Camera settings are displayed on the screen.

- **Settings** (⊙): Tap to open a scrolling list of settings.

Picture size

Tap to select the size of the pictures you take.

Picture quality

Tap to select the quality of the pictures you take.

Camera settings

Tap to restore all of the Camera's settings to their default values.

Camcorder settings

As in Camera mode, Camcorder settings are displayed on screen.

- **Camera Settings** (): Tap to choose to restore all of the Camcorder's settings to their default values.
- **Video quality (High)**: Tap to select the quality of the videos you take.



Clock

In addition to displaying the date and time, the **Clock** application plays slideshows and music. You can also use Clock to set an alarm clock.

To open Clock, tap the **Launcher** tab -> **Applications** -> **Clock**.

Playing a slideshow

You can play a slideshow of the pictures in your Gallery, in place of the date and time.

Tap the **Slideshow** icon () at the bottom of the Clock screen, and tap **Back** () to end the show.

Playing music



You can play music while the Clock is displayed.

Tap the **Music** icon () at the bottom of the Clock screen.



The Music application will open, where you can select music to play. You can return to Clock or use another application while the music is playing.

Dimming the Clock display

If you want to use your device as a bedside clock, you can set the screen brightness very low.

Tap the **Dimmer** icon () to dim the clock. Tap and hold the Dimmer icon to show the clock only while the background is dark. Tap anywhere on the screen again to restore normal brightness. If you can't see the Dimmer icon, tap and hold **Home** () and tap the Clock icon to reopen Clock at normal brightness.

Setting an alarm

1. Tap the Alarm icon () at the bottom of the Clock screen.
2. Tap the () icon next to an alarm to turn it on or off. Alarms that are set are underlined in green.
3. Tap an existing alarm clock to change its time and other attributes. Or tap **Menu** () and then tap **Add alarm** to add a new one.

4. Tap **Time** to set the time of the alarm.
In the dialog that opens, you can change the time by tapping the **+** or **-** buttons and the **AM** or **PM** buttons. You can also tap a time to type the time you want directly.
5. Tap **Ringtone** to select a ringtone for the alarm.
The ringtone plays briefly when you select it.
6. Tap **Repeat** to set the days when you want the alarm to sound.
If you don't set a repeat, the alarm sounds only one time.
7. Tap **Label** to enter a name for the alarm.
8. When you're finished, tap **Done**.

Changing alarm clock settings

You can change a number of settings for the alarms you set by tapping **Menu**.

■ Alarm in silent mode

Check to play alarms even when the device is in Silent mode.

■ Alarm volume

Tap to open a dialog where you can set the volume of alarms.

■ Snooze duration

Tap to open a dialog where you can set how long the clock waits before playing an alarm again.

Contacts

Contacts gives you quick and easy access to the people you want to reach. Information about your contacts is shared with other applications, such as Messaging, Gallery (for sharing photos and videos) and so on.

If you have more than one account with contact information, **Contacts** merges duplicate contacts into a single entry. You can also manage that process manually.

Open Contacts

To open your contact, tap the **Launcher** tab -> **Applications** -> **Contacts**.

All of your contacts are displayed alphabetically in a scrolling list. Each contact is followed by the default phone number.

If you haven't added any contacts yet, **Contacts** will display a message with hints on how to start adding contacts to your device.

Tap a contact to view the details. Entries for communicating with the contact are followed by details. Tap a communication method to start texting or emailing the contact by using the listed number, address and so on.

Add Contacts

You can add contacts on your device and synchronize them with the contacts in your Google Account, Microsoft Exchange ActiveSync account, or other accounts that support syncing contacts.

Import and export contacts

If you have contacts stored in vCard format in the Internal storage, you can import them into Contacts on your device. You can also copy contacts from SD card by TOSHIBA File Manager. You can export contacts in vCard format into the Internal storage and copy onto an SD card to backup using TOSHIBA File Manager. You can also send a contact via email.

Search for a contact

You can search for a contact by name.

1. Open your **Contacts**.
2. Tap **Search** (🔍). The search box appears.
3. Start entering the name of the contact you're searching for. As you type, contacts with matching names appear below the search box.
4. Tap a matching contact in the list to open its details screen.

Display options

You can hide contacts that don't have phone numbers. You can also configure which groups of contacts, for each account, you want to display in the Contacts list.

1. Open your **Contacts**.
2. Tap **Menu** (☰) and then tap **Display options**.
3. Check or uncheck **Only contacts with phones** to set whether contacts without phone numbers are displayed, and check or uncheck the groups whose contacts you want to view in Contacts.

Display options menu

You can change or add details about your contacts.

Tap and hold the contact you want to edit. The menu with following options will appear.

- **View contact**
Tap to view the details of the selected contact.
- **Edit contact**
Tap to edit the details of the selected contact.
- **Delete contact**
Tap to delete the selected contact.

Documents To Go

Documents To Go is a suite of applications, with one application for each supported file format: Word To Go for Microsoft Word, Sheet To Go for Microsoft Excel, Slideshow to Go for Microsoft PowerPoint and PDF To Go for Adobe PDF.



Depending on the contents of the documents, it might not be able to display some documents correctly.

Email

You can use the **Email** application to read and send emails. **Email** includes a wizard that makes it easy to configure it for several popular email service providers.

To open the **Email**, tap the **Launcher** tab -> **Applications** -> **Email**.

The first time you open Email, a setup wizard will open to help you add an email account.

After the initial setup, Email will open to the last screen you were viewing. If you have not used Email recently, it will display the contents of your Inbox (if you have only one account) or the Accounts screen (if you have multiple accounts).

If you have configured Email to send and receive emails from more than one account, you can view all emails sent to all accounts in your Combined Inbox.

Read an email

You can read emails in your Combined Inbox or in the Inbox or other folders for individual accounts.

1. Open the combined Inbox, an account's Inbox or another folder of emails.
2. Tap the email to read. The email opens in a screen with information about who sent it, the date it was sent and related information at the top, followed by the contents of the email.

Send an email

You can send an email to your contacts or to other people.

To send an email:

1. Tap **Menu** () and then tap **Compose**.
2. Address the message. You can tap **Menu** and then tap **Add Cc/Bcc** to address a copy or blind copy of the email.
3. Enter a subject for the email and then enter the text.
4. Tap **Send**.

If you're not ready to send the email, tap **Save as draft** to save it in a Drafts folder. To delete the email, select **Discard**.

Respond to an email

You can reply to or forward an email that you've received. You can also delete emails and manage them in other ways.

While reading an email, tap **Menu** () and then tap **Reply**, **Reply all**, **Forward** or **Delete**.

Manage email accounts

The Email application enables you to add email accounts from popular web-based email service providers. You can also delete an email account or edit an email account settings.

- To add an email account:
 1. Tap **Menu** and then tap **Accounts**.
 2. Tap **Menu** and then tap **Add account**.
- To delete an email account:
 1. Tap **Menu** and then tap **Accounts**.
 2. Tap and hold the account you want to delete. On the **Account options** menu, tap **Remove account** and then tap **OK**.
- To edit an email account settings:
 1. Tap **Menu** and then tap **Account settings**.

You can make any changes to general, notification or server settings from this screen.

Evernote

Evernote can be used to save your ideas, things you see and things you like by capturing text notes, tasks, snapshots and audio memos, as well as file uploading. You can access these notes on your device, computer or the web, and find anything quickly by title, tag or even printed and handwritten text inside images.

FBReader

FBReader is an e-book reader. It can support several e-book formats: oeb, epub, fb2, etc.

You can configure FBReader to read books with customized settings. colors, fonts, key bindings and many other properties can be changed in the Preferences dialog.

There are several ways to start and add a book into FBReader library:

- Copy a book file into the directory /storage/Books (or any its subdirectory).
FBReader will add this book automatically.
- Tap a book link (i.e. on a link to a file with extension .epub, .oeb, .fb2 or .fb2.zip) in the web browser.
A book will be downloaded and opened in FBReader.



- Get some contents from the menu in FBReader directly.
- *You need to download e-book contents from e-book web sites.*
- *Though FBReader has a touch panel settings, it can not work in this device.*

fring

fring is an instant messenger which supports multiple IM protocols. You can use them to communicate in real time with other people who also use the same tool on a phone, on the web or with a desktop application.

Gallery

You may use **Gallery** to view pictures and play videos that you've taken with the Camera, downloaded or copied onto your device.

Open Gallery

To open Gallery to view your pictures and videos, tap the **Launcher** tab -> **Applications** -> **Gallery**.

Gallery presents the pictures and videos on your device, including those you've taken with Camera and those you downloaded from the web or other locations.



- *If you have a great many pictures or videos on your device, it may take Gallery a few minutes when you open it to discover and organize them.*
- *Gallery will display all images and videos without distinction of internal or external storage.*

View and browse pictures/videos

All the albums are displayed in the screen. You can peek the album into a stack by tapping it with two fingers and spreading them apart. Slide left or right to view more albums.

1. Tap an album to open it and view its contents.
The pictures and videos in the album are displayed in chronological order. You can view the pictures and videos in your albums in a chronological grid or in stacks, sorted by the date and the location where they were taken. You can switch album views with the Album View switch at the top right of the screen.
2. Tap an arrow in the scroll tool at the bottom of the screen to scroll images a screenful at a time. Drag the scroll tool to the left or right to scroll more or less quickly. The date of the images in view is displayed, so you can scroll by date. You can also scroll through an album by swiping left or right.

3. Tap a picture or video in an album to view it.
You can pinch the picture by two fingers to zoom in or zoom out. Slide left or right to view other pictures/videos.
You can also return to the main Gallery screen at any time by tapping its icon () at the top left of the screen.

Take pictures/videos

You can also tap the camera icon on the top right corner of the screen to take pictures or videos directly. Please refer to the [Camera](#) section for more information.

Work with pictures/videos

After selecting one album, you can multiselect pictures/videos, slideshow and make slideshow settings by tapping **Menu**.

1. Open the album to view the pictures and videos to work with.
2. Tap **Menu** twice.
3. Check or uncheck the items you want to work with.
You can uncheck all items you've checked by tapping **Deselect All** at the top right of the window.
4. Use the controls at the bottom of the screen to act on the checked items.
The controls available depend on the mix of items you've selected.



For the details of supported codec, please refer to [TOSHIBA Media Player](#) in this chapter.

Messaging

You can use **Messaging** to exchange text messages (SMS) with your friends on their mobile phones.



The Messaging function is only supported by 3G models.

To open Messaging, tap the **Launcher** tab -> **Applications** -> **Messaging**.
The Messaging window opens, where you can create a new message or open an ongoing message thread. Tap **New message** to start a new text or multimedia message. Tap an existing message thread to open it.

Exchanging messages

You can send text (SMS) message to a mobile phone.

Send a text message

1. On the Messaging screen, tap **New Message**.
2. Enter a mobile phone number in the **To** field.
As you enter the phone number, the matching contacts will appear. You can tap a suggested recipient or continue entering the phone number.
You can also enter the name of a contact with a mobile number.

3. Tap the composition text box to start entering your message.
4. Tap **Send**.
The message window opens with your message after your name. Responses appear in the window. As you view and send additional messages, a message thread is created.

Respond to messages you receive

If you're working in a message window, messages that you receive are displayed in it. Otherwise, you will receive a new message notification and a new message icon will appear in the Status bar. When you tap the new message notification, the Message window will open, where you can reply to the message.

Messaging options

Tap and hold a message to open a menu with number of options for working with the message and its sender's information.

Messaging Settings

You can change a number of Messaging settings.

To change Messaging settings, tap **Menu** in the Messaging window and then select **Settings**.

Storage settings

■ **Delete old messages**

Check to delete older messages in a thread when the Text message limit is reached. Uncheck to keep all messages.

■ **Text message limit**

Tap to set the number of messages to save per thread of text messages. When the limit is reached, older messages are deleted if Delete old messages is checked.

Text message (SMS) settings

■ **Delivery reports**

Check to receive delivery reports for the messages you send.

Notification settings

■ **Notifications**

Check to receive a notification whenever you receive a new message.

■ **Select ringtone**

Tap to open a dialog where you can select the ringtone to sound when you receive new message notifications.

Music

You can use **Music** to organize and listen to music and other audio files that are in your device, SD card or memory card.

Music supports a wide variety of audio files formats so it can play music that you purchase from online stores, music that you copy from your CD collection and so on. For the details of supported formats, please refer to [TOSHIBA Media Player](#) in this chapter.

To open the Music screen, tap the **Launcher** tab -> **Applications** -> **Music**.

The Music library screen will open with tabs that you can tap to view your music library organized by **Artists**, **Albums**, **Songs**, **Playlists** or **Now playing**.

Play Music

You can listen to music by using your device's built-in speaker.

To play music:

- Tap a song in your library to listen to it.
- While viewing a list of tracks in an album, tap **Menu** () and then tap **Play all**. The playback screen opens and the first song in the album start to play.

Work with playlists

You can create playlists to organize your music files into sets of songs, which you can play in the order you set or in a shuffle.

To create a playlist:

1. When viewing a list of songs in the library, tap and hold the first song you want to add to the new playlist.
2. Tap **Add to playlist**.
3. Tap **New**.
4. Enter a name and tap **Save**.
The new playlist is added to the Playlist library.

You can add other songs that are playing in the Playback screen in a playlist by tapping **Menu** and tapping **Add to playlist**. You can also tap **Save as playlist** to save all the songs in an album that you're playing as a playlist.

You can remove songs from a playlist or delete a playlist by tapping **Menu** () and then select appropriate options.

Online Manual

Online manual is a widget to launch the pre-installed online manual (this manual) for this device.

You can open the online manual according to the following steps:

1. Add the widget onto the Home screen.
2. Tap the widget on the Home screen to open the online manual.

Opera Mobile

Opera Mobile is a fast and compact Web browser. With Opera Mobile, you can access Web sites and content, including your mail, community sites, news, blogs and more.

Opera Mobile includes a “Speed Dial” feature, which allows the user to add links shown as thumbnail images in a page displayed when a new tab is opened. Once set up, this feature allows you to more easily navigate to the selected web pages, and visual tabs, that allow the browsing multiple Web sites at one time. It also includes a Password manager, Pop-up handler, and supports copy & paste, address auto-complete, zooming, history and bookmarks.

Opera Mobile provides you with the following features:

■ Navigation bar

At the bottom of the screen, there is an Opera Mobile navigation bar: Backward, Forward, Refresh, Tabs and Settings.

■ Multiple tabs

Enjoy surfing several Web pages at once with multiple tabs. Tabs are available by tapping the **Tabs** button on the navigation bar at the bottom of the screen. You can add a new tab by tapping the empty tab to the right, and close a tab by tapping the red **X** in the top right corner of a tab.

■ Add sites to your speed Dial

Add web sites to your Speed Dial by tapping and holding on an empty dial. Choose “Assign” and type a web address or select one from the list. You can also delete and edit your Speed Dial by tapping and holding on a dial and choosing “Clear” or “Edit”.

For more details, please refer to the online help of Opera mobile by tapping **My Opera** in the main page.



The Opera mobile browser might connect to a “mobile” web site rather than a “PC” web site, depending on the site. If you want to access the PC web site, please manually select the correct site.

Picture frame

Picture frame is a widget to display the pictures or photos on the screen as if in a container. This makes it easier for users to enjoy the pictures. You can select pictures directly.

Power Control

Power control is a widget to quickly control the power of your device. You can save power by disabling wireless, Bluetooth, 3G and decrease the display brightness.

Just simply tap the widget icon to enable or disable this application.

Search

Search is a widget to launch Search toolbar which enables you to search contents through your device or via the network.

1. Tap this widget from the **Launcher** tab -> **Widgets** -> **Search**.
2. Choose the search type and then input the content you want to search in the Search toolbar and tap **Go** to start search.

SingleClick Connect

SingleClick Connect is a simple and useful tool which helps users to set up Remote Desktop feature and easily share printers between your device and your computers, and also access your SingleClick Connect account settings.

In order to use this application to access all the devices on your network, firstly you have to install this application onto your computers and finish the Remote Access setup process. Please follow the steps below:

1. Download the Windows application setup file from your computer's web browser by entering the following URL:
<http://toshiba.singleclickconnect.com>
2. Install the Windows application in your Windows system. Follow the on-screen instructions to finish the installation.

SingleClick is now installed and set up for you to connect and share your network.

1. Tap **SingleClick Connect** in your TOSHIBA FOLIO 100 device.
2. Enter the username and password you created when you installed the SingleClick application on your computer.
3. Now you can successfully log into your account and the main application screen will be displayed.

You can control the devices in your network via the Remote Desktop feature or print a file from your TOSHIBA FOLIO 100 device to a printer in your network. There is also an Account Setting menu to manage your account information.

Access my Computers

SingleClick Connection enables you to use Remote Desktop feature from your TOSHIBA FOLIO 100 device.

Print a File or Web Page

SingleClick Connection enables you to print files from your TOSHIBA FOLIO 100 device to a printer on the remote network.

Access my Account Settings

Tap **Access my Account Settings** to get information about your account including your subscription information.



Login to a Different Account

Tap **Login to a Different Account** to login to a different account by entering the username and password.

Sound Recorder

Sound Recorder is useful for quickly recording thoughts. You can also record your voice and set it as a ringtone.

Record your voice

1. Open the Sound Recorder application as follows:
Tap the **Launcher** tab -> **Applications** -> **Sound Recorder**.
2. Hold the device's microphone near your mouth.
3. Tap () to start recording a voice clip. Tap () to stop recording.
4. Tap () to playback the voice recording.

Use your recordings

You can play, use and delete your recordings in Music.

1. Once you finish recording your voice, an onscreen menu will be displayed with two options: **using this recording** or **Discard**.
2. Select **using this recording**.
3. Open the **Music** screen. Select **My recordings** from the **Playlists** tab.
4. Tap your recordings to play them. Tap and hold your recordings to open a menu where you can edit them.

TOSHIBA File Manager

You can use this file manager for managing files and folders in your storage. You can create folders, rename, move, copy or delete files or folders in the device's storage, SD card and USB storage.

To open TOSHIBA File Manager:

Tap the **Launcher** tab -> **Applications** -> **TOSHIBA File Manager**.



- *TOSHIBA File Manager will only show files and folders in the storage area. System files are not shown and cannot be accessed.*
- *TOSHIBA File Manager may not be able to open a file if there is no associated application for this file.*

File Browsing Window

The window of this application includes four areas: **Device**, **Path**, **File** and **Control**.

■ Device

Internal storage, SD card, USB storage and Screen capture will be shown. You can tap any device icon to open its content.

■ Path

The device name would be shown in the left side and the relative path will be shown in the right side.

■ File

Folders and files are listed in multi-columns with thumbnails which show the file information such as Name, Modified date time, etc. The selected files or folders would be tagged as red.

■ Control

You can select files, create folders and go up to the upper level directory by selecting different options.

Files & Folders Operation

After you tap **Select File**, a file selecting window will be opened which enables you multiselect, copy, cut and delete selected files or folders. There are six options: **Select All**, **Deselect All**, **Cancel**, **Copy**, **Cut** and **Delete**.

■ Select All

Tap to select all the folders and files in the current path.

■ Deselect All

Tap to deselect all the folders and files in the current path.

■ Cancel

Tap to cancel file operation and return to file browsing window.

■ Copy

Tap to copy the selected files or folders to the target path. After choosing the right path, tap **Paste** to copy files or folders into the target directory.

■ Cut

Tap to cut the selected files or folders and paste them to the target path. After choosing the right path, tap **Paste** to move files or folders into the target directory.

■ Delete

Tap to delete the selected files. A dialog is shown asking you to confirm deletion. Tap **OK** or **Cancel** to continue.

By tapping and holding on a file or folder icon, a pop-up menu will be displayed which enables you **Cut**, **Copy**, **Delete** or **Rename** the selected file or folder.

Rename Files or Folders

You can rename a file or folder using the following steps:

1. Tap and hold the selected file or folder.
2. Tap **Rename** from the menu to input a new name for the selected file or folder.
3. Tap **OK**.

Create Folders



You can also create a new folder using the following steps:



1. Choose the right directory in the file browsing window, and tap **Create a folder**.
2. A new dialog will be shown to let users input a new folder name. Tap **OK** to continue.

For detailed information, please refer to the TOSHIBA File Manager Help file.

Storage Structure

The following table describes the meaning of the device icons in TOSHIBA File Manager.

Icon	Name	Description
	Internal Storage	It shows all the contents in the device's flash memory except the system files and files in SD card, USB storage and Screen capture.
	SD card	It shows all the contents in the SD card.

Icon	Name	Description
	USB storage	It shows a menu of existing USB devices (totally support a maximum of eight disk partitions).
	Screen capture	It shows all the contents in the Screen capture folder.

TOSHIBA Media Player

TOSHIBA Media Player is a multimedia player where users can experience outstanding multimedia enjoyment.

The TOSHIBA Media Player supports a number of multimedia content formats as follows:

Video	H.264 (CABAC 720p, CAVLC 1080P), MPEG-4 (SP, ASP), H.263 (with 3GP, MOV), WMVv9 Advanced Profile (VC-1), MJPEG
Audio	MP3, AAC-LC, HE-AAC v1/v2, AMR, AMR-NB, MIDI, WAVE, WMA9 Std, WMA
Photo	JPEG, GIF, PNG, BMP



TOSHIBA does not guarantee that all the audio/video files with the above codec will be played correctly.

The main screen of this player contains two parts: one is the Mode Icons, the other is the Main Menu area. This player contains the following modes: **Audio**, **Video**, **Photo**, **DMP** and **Podcast**. You can switch mode by selecting the mode icon. The content of the Main Menu area will be changed automatically with current mode. In the main window, tap **Menu** to open the following options:

- **About**
Show version information, etc.
- **Capture Photo**
Start the Camera application in photo mode.
- **Capture Video**
Start the Camera application in movie mode.



- *DMP (Digital Media Player) function supports to connect Windows media player 12 on Windows® 7 only.*
- *Some “double-byte” characters might not be displayed correctly. This is the Operating System limitation.*

For detailed information, please refer to the TOSHIBA Media Player Help file.

TOSHIBA Service Station

The TOSHIBA Service Station utility is used to provide you with updates for both application and system software. It will notify you when new versions of your software are available, as well as download and install them.

To open TOSHIBA Service Station:

Tap the **Launcher** tab -> **Applications** -> **TOSHIBA Service Station**.

Window

When you run the TOSHIBA Service Station for the first time, you are prompted to accept the access agreement. The agreement authorizes the utility to collect certain basic information about your device and send it to the TOSHIBA servers as part of the process of obtaining updates. Accept or Decline the agreement by tapping the buttons. While it is possible to decline the agreement, it is not recommended, as this means the Service Station utility will not run, and you will not be notified of new software updates for your device.

Main Window

The main window of this application includes three areas: **Header**, **Buttons**, and **Information**.

■ Header

This section runs along the top of the screen, and contains basic information about your system such as the version of the OS, the device part number and serial number.

■ Buttons

Buttons are displayed on the screen. These buttons will change, depending on what actions you have available on the current screen.

■ Information

The main part of the screen displays information such as the list of available updates, or more detailed information about a specific update.

Check for Updates

During normal operations, the TOSHIBA Service Station will periodically check to see if there are any updates for your system. This is done automatically. If there are new updates available, you will be notified with the TOSHIBA Service Station icon in the status bar of your device.

While the TOSHIBA Service Station will periodically check for updates in the background, you can request that it check for updates immediately. Tap the **Check for Updates** button, and the application will refresh the list of available updates.



- *It is not normally necessary to check for updates manually, as the utility checks for them automatically and informs you when one is available.*
- *Please connect the AC adapter before updating.*

Downloading Updates

When an update is available, it will appear on the information area of the screen. Tap the item displayed. More detail for that item is displayed on the screen.

To download the update, tap the **Download** button. This will begin the download process. A progress indicator is displayed.



- *Tapping **Home** (🏠) allows the download to continue while you use your device. A notification of the download completion will appear in the system status bar.*
- *Tapping the **Back** button will abort the download process.*

Installing Updates

Once an update has been downloaded, it can be installed. If you are not on the display showing the information for that item, go to the screen by launching the TOSHIBA Service Station utility, or by tapping the download completion notice on the system status bar.

Tap the **Install** button. This will launch the application installer. Continue with installation.

Downloading and Installing System Updates

The TOSHIBA Service Station will download both application and system update. System updates require that your device be rebooted during the update.

Downloading a system update is the same as an application update.

Installing a system update is similar to an application update, but you will be reminded that the device will be rebooted during the installation process. Make sure to close any other applications and save all work prior to installing a system update.



It is important that a system update not be interrupted once it has begun. Make sure the AC power is plugged in before beginning the installation and don't turn the device off while the installation is in progress.

Note that the system may reboot more than once during an system update, depending on the update itself.



This application only updates system area in the internal storage. User data area is kept after the system is updated.

Settings

This chapter will describe different setting options in the **Settings** application. **Settings** contains two categories: **Settings** and **Desktop Settings**.

Settings

You can use **Settings** to configure how your device sounds, communicates and operates in many other ways.



A scrollbar is displayed in right side of the screen. This scrollbar is only used to show the position of the displayed area. You can scroll the settings items using your fingers or USB mouse.

Wireless & networks

You can use **Wireless & networks** settings to configure and manage connections to networks and devices by using Wi-Fi, Bluetooth and mobile networks. You can also use wireless controls to turn off all radios with Airplane mode. See [Connecting to networks](#) chapter for detailed information.

■ Airplane mode

Check this option to disable all wireless radios.

■ Wi-Fi

Check this option to turn on Wi-Fi so you can connect to Wi-Fi networks.

■ Wi-Fi settings

Tap to set up and manage wireless access points.

■ Bluetooth

Check this option to turn on Bluetooth so you can connect to Bluetooth devices.

■ Bluetooth settings

Tap to manage connections, set device name & discoverability.

■ 3G device

Check this option to turn on 3G so you can connect to mobile networks.



This function is only supported by 3G models.

■ VPN settings

Tap to set up and manage Virtual Private Networks (VPNs).

■ Mobile networks

Tap to set options for roaming, networks and APNs.



This function is only supported by 3G models.

Sound

You can use **Sound** settings to configure many aspects of notification ringtones, music and other audio.

Sound settings contains the following options:

■ **Notification ringtone**

Tap to open a dialog where you can set the default notification tone when you receive a notification.

■ **Silent mode**

Check this option to silence all sounds (including notification ringtones).

■ **Volume**

Tap to open a dialog where you can drag a slider to set the volume for music, video soundtracks and other media.

Display

You can use **Display** settings to configure the brightness and other screen settings.

Display settings contains the following options:

■ **Brightness**

Tap to open a dialog that contains a slider for adjusting the screen brightness.

■ **Animation**

Tap to open a dialog where you can select whether to show animations.

■ **Auto-rotate screen**

Tap to open a dialog where you can select whether to rotate the orientation of the screen as you turn your device sideways.



Always make sure to keep the Web camera on the top (Landscape mode) or on the right (Portrait mode) while rotating.

■ **Screen timeout**

Tap to open a dialog where you can set how long to wait before the screen automatically turns off.

Location & security

You can use **Location & security** settings to configure settings that help secure your device and its data.

Location & security contains the following options:

- **Set up screen lock**

Tap to open a screen where you can configure the device to lock screen with a pattern, PIN or password.

- **Visible passwords**

Check this option to briefly show each password character as you enter them, so that you can see what you enter.

- **Select device administrators**

Tap to open a screen where you can add or remove device administrators.

- **Use secure credentials**

Check this option to allow applications to access your device's encrypted store of secure certificates and related passwords and other credentials. You can use credential storage to establish some kinds of Wi-Fi connections. If you have not set a password for credential storage, this setting is dimmed.

- **Install from storage**

Tap to install a secure certificate from the storage.

- **Set password**

Tap to open a dialog where you can set or change the password for your secure credential storage. Your password must have at least 8 characters.

- **Clear storage**

Tap to delete all secure certificates and related credentials and erases the secure storage's own password, after prompting you to confirm that you want to do this.

Applications

You can use the **Applications** settings to view details about the applications installed on your device, to manage their data and force them to stop, and to set whether you want to permit installation of non-Market applications that you obtain from web sites and email.

- **Unknown sources**

Check this option to permit installation of applications that you obtain from websites, email or other locations.

- **Quick launch**

Tap to open a screen where you can set shortcuts to launch applications.

■ Manage applications

Tap to open a list of all the applications and other software installed on your device, along with their size. By default, only downloaded applications are shown, and these are sorted in alphabetical order.

■ Running services

Tap to open a list of services - applications or parts of applications that provide services to other applications or that run even when their main application isn't running. Above each service, one or more gray bars show which processes the running service needs and how much memory it's using. Depending on the service, when you tap it in the list it will either open a dialog in which you can stop it or open its Settings screen.

■ Development

This option contains settings that are useful for developing applications.



- *This device cannot access the Android™ Market.*
- *This device does not support another Operating System.*
- *TOSHIBA cannot guarantee or support applications that are installed by a user.*

Privacy

You can use the **Privacy** settings to manage your personal information.

■ Factory data reset

Tap to erase all user data in the internal storage. Follow the on-screen instructions to reset it. Please note that data in the removable media won't be erased. See [Factory Reset](#) section in “Basic Operations & Home screen” chapter for details.

Device storage

Device storage settings show your internal device storage and external storage status.

Internal storage

Internal storage contains the following options:

- **Total space**

Shows the total space amount of internal storage in your device.

- **Available space**

The amount of internal storage used by the operating system, its components, applications (including those you downloaded) and their permanent and temporary data.

External storage

External storage may contain the following options depending on the devices that you inserted:

- **If only an SD card is inserted**

- **Unmount sdcard**

Tap to unmount the SD card for safe removal.

- **If a USB memory device and an SD card are inserted**

- **Unmount sdcard**

Tap to unmount the SD card for safe removal.

- **Unmount usb0 - Unmount usb7**

Tap to unmount the USB memory device for safe removal.

Search

You can use **Search** settings to configure Google search, and the data on the device that you want to include in searches.

Web

Web contains the following option:

- **Google search**

Tap to open a screen where you can set your preferences for whether Google search on the web makes suggestions. You can also open the Google web search history settings page in Browser.

Device

Device contains the following options:

- **Searchable items**

Tap to open a screen where you can select the kinds of data to be included in searches.

- **Clear shortcuts**

Tap to erases the list of recently chosen search results.

Language & keyboard

You can use **Language & keyboard** settings to select the language for the text on your device and for configuring the onscreen keyboard, including words that you've added to its dictionary.

Date & time

You can use **Date & time** settings to set your preferences for how dates are displayed. You can also use these settings to set your own time and time zone, rather than obtaining the current time from the mobile network.

■ Automatic

Uncheck this option to set the date, time and time zone on the device manually rather than obtaining the current time from the mobile network.



This option is only supported by 3G models.

■ Set date

If **Automatic** is unchecked, tapping it will open a dialog where you can manually set the device's date.

■ Select time zone

If **Automatic** is unchecked, tapping it will open a dialog where you can set the device's time zone.

■ Set time

If **Automatic** is unchecked, tapping it will open a dialog where you can manually set the device's time.

■ Use 24-hour format

Check this option to display the time using 24-hour time format - for example, 13:00 rather than 1:00 pm.

■ Select date format

Tap to open a dialog where you can select the format for displaying dates.

About device

About device includes information about your device.

- **Status**

Tap to open the Status screen with a long list of information about your battery, mobile network connection and other details.

- **Battery use**

Tap to open a list of the applications and operating system components you have used since you last connected the device to a power source, sorted by the amount of power they have used.

- **Legal information**

Tap to open a screen where you can obtain legal information about the softwares included with your device.

- **System information**

Tap to open a screen that displays some basic information of your device, such as Manufacture, Product name, Product version and Serial number, etc.

- **Model number**

Display the model number of your device

- **Android version**

Display the current Android version installed in your device.

- **Baseband version**

Display the baseband version.

- **Kernel version**

Display the kernel version.

- **Build number**

Display the build number.

Desktop settings

You can use **Desktop settings** to customize the desktop.

- **Auto-Switch Desktop**

Check this option to permit switching your desktop based automatically on the location.

- **Set up My Desktops**

Tap to open a screen where you can set your desktop's name, such as My Home, My Office, etc.

- **Select Wallpaper**

Tap to open a screen where you can set your desktop's wallpaper.

Hardware & Options Operation

This chapter identifies the various components and the hardware of the device - it is recommended that you become familiar with each before you operate the device.



- *Please handle your device carefully to avoid scratching or damaging the surface.*
- *This device does not support CD/DVD/Blu-ray Disc.*
- *This device cannot be used as a mobile phone.*
- *Content that is copyright protected or has limited access rights, cannot be played on this device.*

Hardware

This section describes the hardwares of your device.

The actual specifications may vary depending on the model you purchased.

Processor

CPU	Your device is equipped with an NVIDIA® Tegra™ 250 Mobile Processor..
------------	---

Memory

Memory on board	This device is equipped with a 512MB or 1GB memory on board. The actual amount of useable system memory will be less than the installed memory modules. This device does not support memory expansion.
Flash Memory	This device is equipped with a 8GB, 16GB or 32GB flash memory.

Power

Battery pack	The device is powered by one detachable lithium-ion battery pack.
AC adaptor	<p>The AC adaptor provides power to the system and recharges the batteries when they are low. It comes with a detachable power cord which will either have a 2-pin or 3-pin plug enclosure.</p> <p>As the AC adaptor is universal, it can receive a range of AC voltages from 100 to 240 volts, however you should note that the output current varies among different models. Using the wrong adaptor can damage your device.</p>

Display

The device's internal display panel supports high-resolution video graphics and can be set to a wide range of viewing angles for maximum comfort and readability.

Display panel	<p>25.7cm (10.1") LCD screen, 262,144 color (6-bit gray scale), configured with the following resolution:</p> <ul style="list-style-type: none">■ 1024 horizontal x 600 vertical pixels
Graphics controller	The graphics controller maximizes display performance.

Multimedia

Web Camera	Web Camera is a device that allows you to record video or take photographs with your device. You can use it for video chatting or video conferences using a communication tool.
-------------------	--

Communications

Bluetooth	Some models have Bluetooth wireless communication function which eliminates the need for cables between electronic devices such as computers, printers and mobile phones. When it is enabled, Bluetooth provides the wireless personal area network environment which is safe and trustworthy, that is quick and easy.
------------------	--

Wireless LAN

The device is equipped with a Wireless LAN module that is compatible with other Wireless LAN systems based on Direct Sequence Spread Spectrum/Orthogonal Frequency Division Multiplexing radio technology that complies with the IEEE 802.11 Standard.

3G

Some models are equipped with a 3G module.



FCC compliance and Industry Canada (IC) compliance does not apply to this product with a 3G module installed.

CAUTION

Bluetooth™ and Wireless LAN devices operate within the same radio frequency range and may interfere with one another. If you use Bluetooth™ and Wireless LAN devices simultaneously, you may occasionally experience a less than optimal network performance or even lose your network connection.

If you should experience any such problem, immediately turn off either one of your Bluetooth™ or Wireless LAN.

Please visit the following website:

In Europe visit <http://www.toshiba-europe.com/computers/tnt/bluetooth.htm>

In the United States visit <http://www.pc.support.global.toshiba.com>

Battery pack

This section explains battery pack use, recharging methods and handling. When the AC adaptor is not connected, the device's main power source is a removable lithium ion battery pack. You can purchase additional battery packs for extended use of the device away from an AC power source although you should not change the battery pack while the AC adaptor is connected.

Before you remove the battery pack, save your data and shut down the device.

Care and use of the battery pack

This section provides the important safety precautions in order to handle your battery pack properly.

Refer to the enclosed **Instruction Manual for Safety and Comfort** for detailed precautions and handling instructions.



- *Make sure the battery is securely installed in the device before attempting to charge the battery pack. Improper installation could generate smoke or fire, or cause the battery pack to rupture.*
- *Keep the battery pack out of reach of infants and children. It can cause injury.*



- *The battery pack are lithium ion batteries, which can explode if not replaced, used, handled or disposed of properly. Dispose of the battery as required by local ordinances or regulations. Use only batteries recommended by TOSHIBA as replacements.*
- *Charge the battery pack only in an ambient temperature between 5 and 35 degrees Celsius. Otherwise, the electrolyte solution might leak, battery pack performance might deteriorate and the battery life might be shortened.*
- *Never install or remove the battery pack without first turning off the power and disconnecting the AC adaptor. Never remove the battery pack while the device is in Suspend Mode. Data could be lost.*

Charging the batteries

When the power in the battery pack becomes low, the **Power/Battery** indicator will blink amber to indicate that only a few minutes of battery power remain.

You must recharge a battery pack when it becomes discharged.

Procedures

To recharge a battery pack while it is installed in the device, connect the AC adaptor to the DC IN 19V jack and plug the other end into a working outlet.



Use only the device connected to an AC power source or TOSHIBA FOLIO 100 TV KIT to charge the battery pack. Never attempt to charge the battery pack with any other charger.

Battery charging notice

The battery may not begin charging immediately under the following conditions:

- The battery is extremely hot or cold (if the battery is extremely hot, it might not charge at all). To ensure the battery charges to its full capacity, you should charge it at room temperature of between 5°C to 35°C (41°F to 95°F).
- The battery is nearly completely discharged. In this instance you should leave the AC adaptor connected for a few minutes and the battery should begin charging.

The **Power/Battery** indicator may show a rapid decrease in battery operating time when you try to charge a battery under the following conditions:

- The battery has not been used for a long time.
- The battery has completely discharged and been left in the device for a long time.
- A cool battery is installed in a warm device.

In such cases you should follow the steps as detailed below:

1. Fully discharge the battery by leaving it in the device with the power on until the system automatically turns itself off.
2. Connect the AC adaptor to the DC IN 19V jack of the device, and to a wall outlet that is supplying power.
3. Charge the battery until the **Power/Battery** indicator glows white.

Repeat these steps two or three times until the battery recovers normal capacity.

Charging time

The following table shows the approximate time required to fully charge a discharged battery.

Charging time (hours)

Battery type	Power on	Power off
Battery pack (22.6Wh, 6 cell)	about 5	about 3.5



Please be aware that the charging time when the device is on is affected by ambient temperature, the temperature of the device and how you are using the device - if you make heavy use of external devices for example, the battery might scarcely charge at all during operation.

Battery life

The following table shows the approximate battery life of a fully charged battery.

Battery life

Battery type	Time
Battery pack (22.6Wh, 6 cell)	about 7 ~ 20 hours (in use) about 5 days (Suspend Mode)



Please be aware that the battery life will be affected by how you are using the device.

Replacing the Battery Pack

Please be aware that the battery pack is classified as a consumable item. The operating life of the battery pack will gradually reduce through repeated charging and discharging, and will need to be replaced when it reaches the end of its operating life. In addition to this, you might also replace a discharged battery pack with a charged spare when you are operating your device away from an AC power source for an extended period of time.

This section explains how to remove and install the battery pack, and begins with the removal process which is detailed through the following steps.



Do not touch the battery release latch while holding the device or the battery pack might fall out due to the unintentional release of the battery release latch and cause injuries.

Removing the battery pack

To remove a discharged battery, follow the steps as detailed below:

1. Save your work.
2. Turn the device's power off.
3. Remove all cables and peripherals that are connected to the device.
4. Turn the device upside down.
5. Slide the cover lock into its unlock () position.
6. Slide your finger under the cover recess and lift this corner up first.

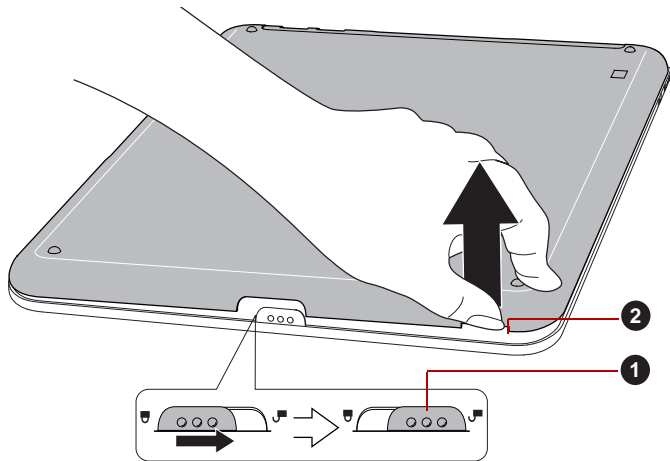

1. Cover lock

2. Cover recess

(Sample Illustration) Removing the cover-1

- Lift the cover up according to the following figure and then remove the cover.

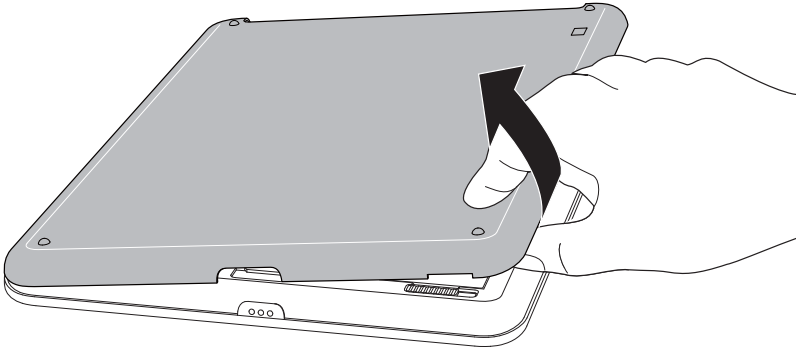

(Sample Illustration) Removing the cover-2

- Slide the battery lock into its unlock (⌚) position.
- Slide and hold the battery release latch to disengage the battery pack and then lift it up to remove it from the device.

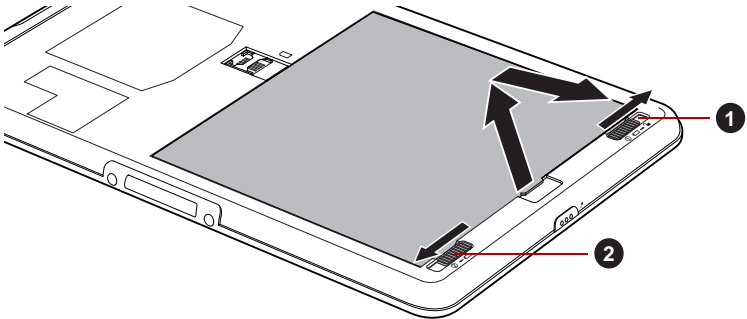

1. Battery lock

2. Battery release latch

(Sample Illustration) Removing the battery pack

Installing the battery pack

To install a battery pack, follow the steps as detailed below:

1. Align the connectors of the battery pack with that of the device and gently insert the battery pack into the device at about a 30 degree angle.

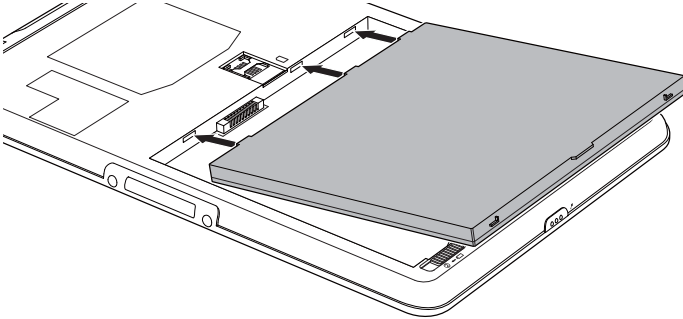

(Sample Illustration) Installing the battery pack

2. Ensure that the battery pack is securely in place and the battery lock is in its lock (☐) position.
3. Seat the cover in place and slide the cover lock to its lock (🔒) position.

Mini USB port

This device is equipped with a mini USB port that enables you to connect to a computer.

To connect to a computer:

1. Plug the Mini USB connector of a USB cable into the Mini USB port on this device.
2. Plug the other end of the USB cable into the USB port on the computer.
3. Tap the “USB connected” notification in the notifications panel and then tap the “Mount” button.

Then this device becomes a removable USB mass storage device and you can access its content from the computer.

To remove this device from the computer, tap the “Turn off USB storage” notification in the notifications panel and then tap the “Turn Off” button.



- *Make sure the connector is properly aligned with the socket. Do not try to force the connection, doing so can damage the connecting pins.*
- *Mini USB port only supports slave mode.*

Optional devices

Optional devices can expand your device's capabilities and its versatility. This section describes the connection or installation of the following devices:

Cards

- SD card slot
 - Secure Digital™ (SD) Card (SD memory card, SDHC memory card, miniSD Card, microSD Card)
- SIM card slot

Peripheral devices

- USB device
- HDMI device
- TOSHIBA FOLIO 100 TV KIT

SD card slot

The device is equipped with an SD card slot that can accommodate some kinds of memory media with various memory capacities so that you can easily transfer data from devices, such as digital cameras and Personal Digital Assistants.



- *This Bridge media slot supports the following memory media.*
 - *Secure Digital (SD) Card (SD memory card, SDHC memory card, miniSD Card, microSD Card)*
- *Please note that an adaptor is required to use miniSD/microSD Card.*
- *Please note that not all memory media have been tested and verified to work correctly. Therefore, it is not possible to guarantee that all memory media will operate properly.*
- *The slot does not support Magic Gate functions.*

Memory media

This section provides the important safety precautions in order to handle your memory media.

Points to note about the SD/SDHC memory card

SD/SDHC memory cards comply with SDMI (Secure Digital Music Initiative), which is a technology adopted to prevent unlawful copy or playback of digital music. For this reason, you cannot copy or playback protected material on another device or other device, and you may not reproduce any copyrighted material except for your personal enjoyment.

Below is a simple explanation for distinguishing SD memory cards from SDHC memory cards.

- SD and SDHC memory cards appear the same externally. However, the logo on SD and SDHC memory cards is different, so pay careful attention to the logo when purchasing.



- The SD memory card logo is ().

- The SDHC memory card logo is ().

- The maximum capacity of SD memory cards is 2GB. The maximum capacity of SDHC memory cards is 32GB.

Card Type	Capacities
SD	8MB, 16MB, 32MB, 64MB, 128MB, 256MB, 512MB, 1GB, 2GB
SDHC	4GB, 8GB, 16GB, 32GB

Memory media format

New media cards are formatted according to specific standards. If you wish to reformat a media card, be sure to do so with a device that uses media cards.

Formatting an SD/SDHC memory card

SD/SDHC memory cards are sold already formatted in conformity to specific standards. If you reformat an SD/SDHC memory card, be sure to reformat it with a device such as digital camera or digital audio player that uses the SD/SDHC memory cards, not with the format command provided within Windows.



Should you need to format all areas of the memory card, including the protected area, you will need to obtain an appropriate application that applies the copy protection system.

Media care

Observe the following precautions when handling the card.

Card care

- Do not twist or bend cards.
- Do not expose cards to liquids or store in humid areas or lay media close to containers of liquid.
- Do not touch the metal part of a card or expose it to liquids or let it get dirty.
- After using card, return it to its case.
- The card is designed so that it can be inserted only one way. Do not try to force the card into the slot.

- Do not leave a card partially inserted in the slot. Press the card until you hear it click into place.

Memory card care

- Set the write-protect switch to the lock position, if you do not want to record data.
- Memory cards have a limited lifespan, so it is important to backup important data.
- Do not write to a card if the battery power is low. Low power could affect writing accuracy.
- Do not remove a card while read/write is in progress.



For more details on using memory cards, see manuals accompanying the cards.

About the write-protect

The following memory media have a function for protect.

- SD Card (SD memory card, SDHC memory card)



Set the write-protect switch to the lock position, if you do not want to record data.

Inserting a memory media

The following instructions apply to all types of supported media devices. To insert a memory media, follow the steps as detailed below:

1. Turn the memory media so that the contacts (metal areas) are face down.
2. Insert the memory media into the Bridge media slot on the right side of the device.
3. Push the memory media gently to ensure a firm connection is made.

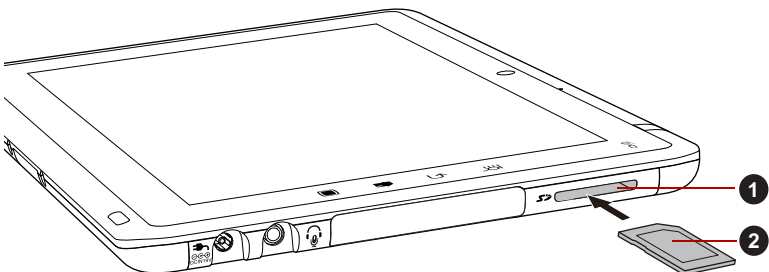

1. SD card slot

2. Memory media

(Sample Illustration) Inserting a memory media



- *Make sure memory media is oriented properly before you insert it. If you insert the media in wrong direction, you may not be able to remove it.*
- *When inserting memory media, do not touch the metal contacts. You could expose the storage area to static electricity, which can destroy data.*
- *Do not turn the device off or switch to Suspend Mode while files are being copied - doing so may cause data to be lost.*

Removing a memory media

The following instructions apply to all types of supported media devices. To remove a memory media, follow the steps as detailed below:

1. Make sure all file operations are finished.
2. Tap the **Launcher** tab -> **Settings** -> **Settings** -> **Device storage** -> **Unmount sdcard**.
3. Press the memory media to partially extend it out of the computer.
4. Grasp the media and remove it.



- *Do not remove the memory media while the device is in Suspend mode. The device could become unstable or data in the memory media could be lost.*
- *Do not remove only the miniSD/microSD Card while leaving the adaptor in the Bridge Media slot.*

SIM card slot

This device is equipped with a SIM card slot that allows you to assemble a SIM card from your wireless service provider to use your provider's mobile networks for transmitting data.



This section only applies to models with 3G modules.

Inserting a SIM card

To insert a SIM card, follow the steps as detailed below:

1. Turn off your device. Remove the cover and the battery pack as described in the [Removing the battery pack](#) section.
2. Locate the SIM card slot beside the battery pack slot.
3. Slide your SIM card into the SIM card slot with your finger as shown on the figure below.
You can slide the SIM card with your finger in the opposite direction to remove the SIM card.

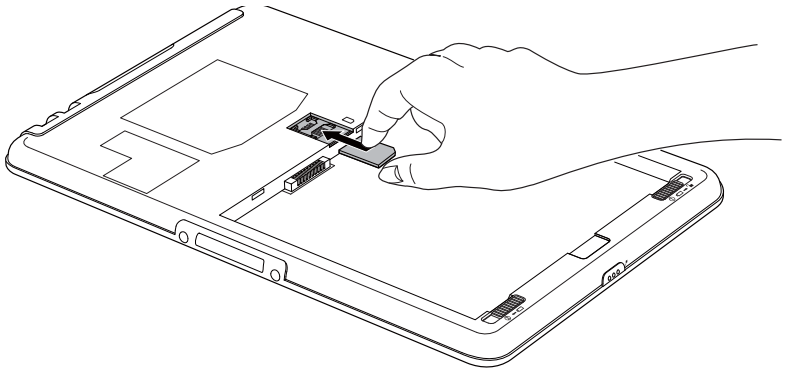

(Sample Illustration) Inserting a SIM card

4. Install the battery pack and the cover in place.
Now you can power on your device to use your provider's mobile networks.

USB device

This device is equipped with a USB port that can accommodate the following USB devices: USB flash memory, External USB HDD, HID (Keyboard and Mouse) and USB hub. This port complies with USB 2.0 standard.

To connect a USB device, plug the device's connector into the USB port on your device.



Make sure the connector is properly aligned with the socket. Do not try to force the connection, doing so can damage the connecting pins.



As the port operation of all USB devices has not been confirmed, some USB devices may not function properly.

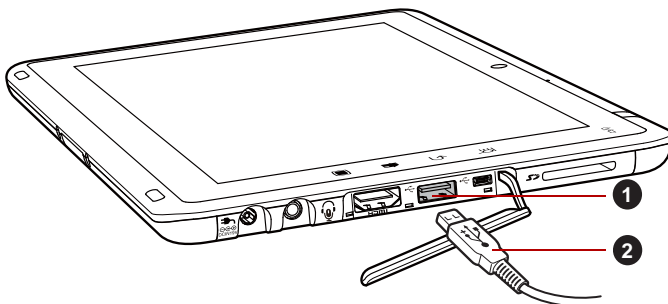

1. USB port

2. USB connector

(Sample Illustration) Connecting a USB device



- *This device does not support a printer connected to the USB port.*
- *This device only support external USB HDD (FAT only) and USB Flash Memory (FAT only) for data copy.*
- *Though USB hubs, USB flash memory and USB HDDs are also supported, the proper function and behavior of all such devices is not guaranteed.*
- *If the USB device you connected is not supported by this device, a notification will be shown.*
- *This device supports FAT12/16/32 format for USB memory and USB hard drives.*

HDMI device

The device is equipped with an HDMI out port that can send video by connecting with external devices. 1080p, 720p, 576p and 480p signal formats are supported, but actually available signal format depends on each HDMI device.

To connect external devices, follow the steps as detailed below:



As the port operation of all HDMI (High-Definition Multimedia Interface) monitors has not been confirmed, some HDMI monitors may not function properly.

1. Plug one end of the HDMI cable into the HDMI port of the HDMI device.
2. Plug the other end of the HDMI cable into the HDMI out port on your device.

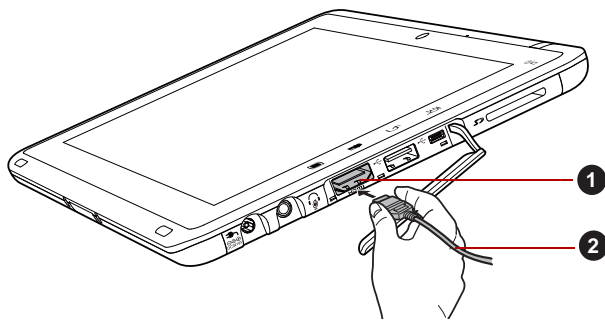

1. HDMI out port

2. HDMI cable

(Sample Illustration) Connecting a HDMI cable



- *When you connect a television or external monitor to the HDMI port and the display mode will be changed to mirror mode. When you unplug the HDMI cable and re-plug it in please wait at least 5 seconds before you re-plug the HDMI cable again.*

TOSHIBA FOLIO 100 TV KIT

The TOSHIBA FOLIO 100 TV KIT includes a dock and a remote controller.

The Dock

The dock provides several kinds of ports in addition to the ports available on your device. It connects directly to the docking interface on the bottom of your device. The AC adaptor connects this dock to a power source.



- You must connect the AC adaptor before you connect to the dock.
- When the dock is connected to your device, you can not use the following ports on your device: DC IN 19V jack and HDMI out port.

The following ports are available on the dock.

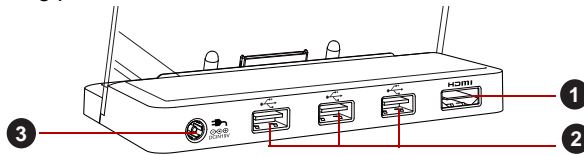

1. HDMI out port
2. Universal Serial Bus 2.0 ports
3. DC IN 19V jack

(Sample Illustration) The dock

To connect your device with this dock, follow the steps below.

1. Connect the power cord to the AC adaptor.
2. Connect the AC adaptor's DC output plug to the DC IN 19V jack on the rear side of this dock.
3. Plug the power cord into a live wall outlet.
4. Remove the protection rubber at the bottom of your device.
5. Align the docking interface on the bottom of your device with the docking ports on the dock.

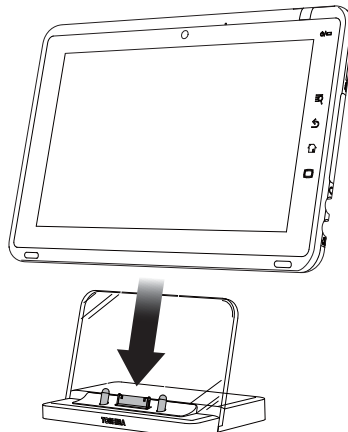

(Sample Illustration) Connect your device with the dock

The Remote Controller

The remote controller is mainly used to turn on or suspend your TOSHIBA FOLIO 100 device, or play music/video or run a slideshow with TOSHIBA Media Player.

The following buttons are provided on the remote controller:

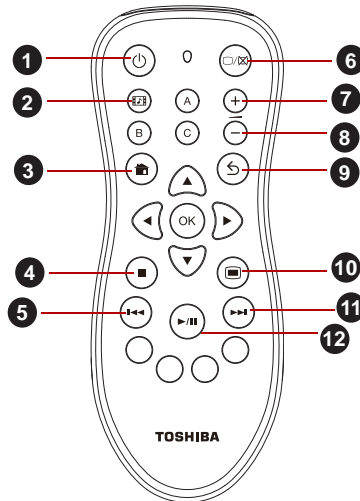

- | | |
|-------------------------|----------------|
| 1. Power | 7. Volume up |
| 2. TOSHIBA Media Player | 8. Volume down |
| 3. HOME | 9. Back |
| 4. Stop | 10. Menu |
| 5. Previous | 11. Next |
| 6. Screen | 12. Play/Pause |

(Sample Illustration) The Remote Controller

Optional accessories

You are able to add a number of options and accessories in order to make your device even more powerful and convenient to use. For reference, the following list details some of the items that are available from your reseller or TOSHIBA dealer:

Universal AC Adaptor	If you frequently use your device at more than one site, it may be convenient to purchase an additional AC adaptor to be kept at each site in order to remove the need to always carry the adaptor with you.
Battery Pack	An additional battery pack can be purchased for use as either a spare or replacement.
TOSHIBA FOLIO 100 TV KIT	The TOSHIBA FOLIO 100 TV KIT provides the ports available on your device in addition to a HDMI out port, three Universal Serial Bus ports (USB 2.0) and a DC IN 19V jack. It also provides you a remote controller for operating the TOSHIBA Media Player and switching your device's status.

Troubleshooting

TOSHIBA have designed this device for durability, however, should problems occur you are able to use the procedures detailed in this chapter to help determine the cause.

All users should become familiar with this chapter as knowing what might go wrong can help prevent problems from occurring in the first place.

Problem solving process

Resolving problems will be much easier if you observe the following guidelines:

- Stop immediately when you recognize a problem exists as taking further action may result in data loss or damage, or you may destroy valuable problem related information that can help solve the problem.
- Observe what is happening - write down what the system is doing and what actions you performed immediately before the problem occurred.

Please also be aware that the questions and procedures described in this chapter are meant only as a guide, they are not definitive problem solving techniques. In reality many problems can be solved simply, but a few may require help from your reseller, dealer or service provider - if you find you need to consult others, be prepared to describe the problem in as much detail as possible.

Preliminary checklist

You should always consider the simplest solution first - the items detailed in this checklist are easy to fix and yet can cause what appears to be a serious problem:

- Make sure you turn on all peripheral devices before you turn on the device - this includes any other external device you are using.
- Before you attach an external device you should first turn the device off, then when you turn your device back on again it will recognize the new device.
- Make sure all optional accessories are configured properly in the device's setup program (please refer to the documentation included with the optional accessories for further information on its installation and configuration).
- Check all cables to ensure they are correctly and firmly attached to the device - loose cables can cause signal errors.
- Inspect all connecting cables for loose wires and all connectors for loose pins.

Always try to make detailed notes of your observations and keep them in a permanent error log - this will help you to describe your problems to your reseller, dealer or service provider. In addition, if a problem recurs, the log you have made will help to identify the problem faster.

Hardware and system checklist

This section discusses problems caused by your device's hardware or attached peripherals. Basic problems may occur in the following areas:

- Internal display panel
- Memory Card
- USB device
- Sound system
- External monitor
- Wireless LAN
- Bluetooth

Internal display panel

Apparent device's display panel problems may be related to the device's setup and configuration.

Problem	Procedure
Markings appear on the device's display panel.	These marks may have come from contact with the touch screen. You should try to remove the marks by gently wiping the display panel with a clean dry cloth or, if this fails, with a good quality LCD screen cleaner. In this latter instance you should always follow the instructions with the screen cleaner and always ensure you let the display panel dry properly before closing it.
Problems above remain unresolved or other problems occur	You should initially refer to the documentation supplied with you software to determine if it is this that is causing the problems. If you are still unable to resolve the problem, contact your reseller, dealer or service provider.

Memory Card

Problem	Procedure
Memory Card error occurs	Remove the Memory Card from the device and then reinsert it in order to ensure it is firmly connected. If the problem persists, then you should refer to the documentation supplied with your Memory card for further information.
You cannot write to a Memory Card	Remove the Memory Card from the device and check to ensure that it is not write protected.

Problem	Procedure
You cannot read a file	Check to ensure the required file is actually on the Memory Card that is inserted into the device. If you are still unable to resolve the problem, contact your reseller, dealer or service provider.

USB device

In addition to the information in this section, please also refer to the documentation supplied with your USB device.

Problem	Procedure
USB device does not work	Remove the USB device from the device and then reconnect it in order to ensure it is firmly attached.

Sound system

In addition to the information in this section, please also refer to the documentation supplied with your audio device.

Problem	Procedure
No sound is heard	Adjust the volume. Check the software volume settings. Please check to see if Mute is turned to Off Check to make sure the headphone connection is secure.

External monitor

Please also refer to the documentation supplied with your monitor for further information.

Problem	Procedure
Monitor does not turn on	After confirming that the monitor's power switch is on, you should check the connections to make sure that the power cord/adaptor is firmly connected to the monitor and to a working power outlet.
No display	Try adjusting the contrast and brightness controls on the external monitor.

Problem	Procedure
Display error occurs	<p>Check that the cable connecting the external monitor to the device is firmly attached.</p> <p>If you are still unable to resolve the problem, contact your reseller, dealer or service provider.</p>

Wireless LAN

If the following procedures do not restore LAN access, consult your LAN administrator.

Problem	Procedure
Cannot access Wireless LAN	<p>Make sure the device's Wireless communication functionality is set to on.</p> <p>If problems persist, contact your LAN administrator.</p>

Bluetooth

Problem	Procedure
Cannot access Bluetooth device	<p>Check to ensure the device's Wireless Communication functionality is set to on.</p>

TOSHIBA Support

If you require any additional help using your device or if you are having problems operating the device, you may need to contact TOSHIBA for additional technical assistance.

Need help?

For the latest driver updates, User's Manuals & FAQs please have a look at the TOSHIBA options & services support page: computers.toshiba.eu/options-support

Please see computers.toshiba.eu/options-warranty for the TOSHIBA hotline numbers.

Specifications

This appendix summarizes the device's technical specifications.

Physical Dimensions

Size	282 (w) x 180.9 (d) x 14 (h) millimeters (not including parts that extend beyond the main body).
-------------	---

Environmental Requirements

Conditions	Ambient temperature	Relative humidity
Operating	5°C (41°F) to 40°C (104°F)	0% to 85% (noncondensing)
Non-operating	-30°C (-22°F) to 60°C (140°F)	0% to 90% (noncondensing)

Conditions	Altitude (from sea level)
Operating	0 to 10,000 feet (3,048 meters)
Non-operating	0 to 40,000 feet (12,192 meters)

Power Requirements

AC adaptor	100-240 volts AC 50 or 60 hertz (cycles per second)
device	19V DC

Regulatory information

Copyright

© 2010 by TOSHIBA Corporation. All rights reserved. Under the copyright laws, this manual cannot be reproduced in any form without the prior written permission of TOSHIBA. No patent liability is assumed, with respect to the use of the information contained herein.

TOSHIBA FOLIO 100 User's Manual

First edition September 2010

Disclaimer

This manual has been validated and reviewed for accuracy. The instructions and descriptions it contains are accurate for this device at the time of this manual's production. However, succeeding devices and manuals are subject to change without notice. TOSHIBA assumes no liability for damages incurred directly or indirectly from errors, omissions or discrepancies between this device and the manual.

This product incorporates copy protection technology that is protected by U.S. and foreign patents, including patent numbers 5,315,448; 5,583,936; 6,836,549; and 7,050,698 and other intellectual property rights. The use of Rovi Corporation's copy protection technology in the product must be authorized by Rovi Corporation. Reverse engineering or disassembly is prohibited.

TO THE MAXIMUM EXTENT PERMITTED BY APPLICABLE LAW, TOSHIBA CORPORATION, ITS AFFILIATES AND/OR SUPPLIERS ("TOSHIBA") DISCLAIM ALL WARRANTIES WITH REGARD TO THE SOFTWARE, EITHER EXPRESS -IMPLIED, OR STATUTORY, INCLUDING, BUT NOT LIMITED TO, THE WARRANTY OF NONINFRINGEMENT OF THIRD PARTY RIGHTS, AND THE IMPLIED WARRANTIES AND CONDITIONS OF MERCHANTABILITY AND FITNESS FOR A PARTICULAR PURPOSE. THE ENTIRE RISK AS TO THE QUALITY AND PERFORMANCE OF THE SOFTWARE IS WITH YOU. TOSHIBA SHALL NOT WARRANT THAT THE FUNCTIONS CONTAINED IN THE SOFTWARE WILL MEET YOUR REQUIREMENTS OR THAT THE OPERATION OF THE SOFTWARE WILL BE UNINTERRUPTED OR ERROR-FREE.

Notwithstanding the above, portions of the software include software files subject to certain open source license agreements, and such open source software files are subject to the notices and additional terms and conditions that are referenced in the End User License Agreement ("EULA") shown when you first sets up this product. (EULA document is also in this package.) Such open source software files are provided on an "AS IS" basis to the maximum extent permitted by applicable law.

Please carefully read “Open source license” section of the “Legal Information” available under the “About Device” tab on the “Setting” menu for the relevant copyright and licensing terms. If there is any discrepancy between the terms and conditions of the applicable open source license agreement and the EULA, the terms and conditions of the applicable open source license agreement prevail with respect to the applicable open source software.

Until the date that is three years after you acquired the Software, you may obtain a copy of the source code corresponding to the binaries for GPL-licensed file by sending a request to TOSHIBA customer service at [http://support.toshiba-tie.co.jp/android/index_e.htm], and TOSHIBA will send you a link to such source code.

Trademarks

Google, the stylized Google logo, Google Talk, and YouTube are trademarks of Google Inc. Availability of Google applications, services, and features may vary by country, carrier, and manufacturer.

Android is a trademark of Google Inc. Use of this trademark is subject to Google Permissions.

Windows, Microsoft and Windows logo are registered trademarks of Microsoft Corporation.

Bluetooth is a trademark owned by its proprietor and used by TOSHIBA under license.

Wi-Fi is a registered trademark of the Wi-Fi Alliance.

Secure Digital and SD are trademarks of SD Card Association.

HDMI, the HDMI logo and High-Definition Multimedia Interface are trademarks or registered trademarks of HDMI Licensing LLC.

“fring” and the fring logo are trademarks of fring. Other product names or service marks mentioned herein may be trademarks or registered trademarks of their respective owners and are hereby acknowledged.

Twitter is a trademark of Twitter, Inc., and is used under license.

Adobe, Adobe PDF, Flash, and the Flash logo are either registered trademarks or trademarks of Adobe Systems Incorporated in the United States and/or other countries.

Other trademarks and registered trademarks not listed above may be used in this manual.

AVC/H.264 License Notice

THIS PRODUCT IS LICENSED UNDER THE AVC PATENT PORTFOLIO LICENSE FOR THE PERSONAL AND NON-COMMERCIAL USE OF A CONSUMER TO (i)ENCODE VIDEO IN COMPLIANCE WITH THE AVC STANDARD (“AVC VIDEO”) AND/OR (ii)DECODE AVC VIDEO THAT WAS ENCODED BY A CONSUMER ENGAGED IN A PERSONAL AND NON-COMMERCIAL ACTIVITY AND/OR WAS OBTAINED FROM A VIDEO PROVIDER LICENSED TO PROVIDE AVC VIDEO. NO LICENSE IS GRANTED OR SHALL BE IMPLIED FOR ANY OTHER USE. ADDITIONAL INFORMATION MAY BE OBTAINED FROM MPEG LA,L.L.C. SEE [HTTP://WWW.MPEGLA.COM](http://WWW.MPEGLA.COM)

CE compliance



This product is CE marked in compliance with the essential requirements and other relevant provisions of Directive 1999/5/EC. Responsible for CE marking is Toshiba Europe GmbH, Hammfelddamm 8, 41460 Neuss, Germany. A copy of the official Declaration of Conformity can be obtained from following website: <http://eps.toshiba-teg.com>.

Indication of the countries

This device is for use in:

AT, BE, CZ, CY, DK, EE, FI, FR, DE, EL, HU, IE, IT, LV, LT, LU, MT, NL, PL, PT, SK, SI, ES, SE, UK, IS, NO, CH, LI

Indication of restrictions of use

France:	Outdoor use limited to 10mW e.i.r.p. within the band 2454-2483.5MHz	Military Radiolocation use. Refarming of the 2.4GHz band has been ongoing in recent years to allow current relaxed regulation Full implementation planned 2012
Italy:	-	For private use, a general authorization is required if WAS/ RLAN's are used outside own premises. For public use, a general authorization is required
Luxembourg:	Implemented	General authorization required for network and service supply
Norway:	Implemented	This subsection does not apply for the geographical area within a radius of 20 km from the centre of Ny-Alesund

Working environment

The Electromagnetic Compliance (EMC) of this product has been verified typically for this product category for a so called Residential, Commercial & Light Industry Environment. Any other working environment has not been verified by Toshiba and the use of this product in these working environments is maybe restricted or cannot be recommended. Possible consequences of the use of this product in non verified working environments can be: Disturbances of other products or of this product in the nearby surrounding area with temporarily malfunction or data loss/ corruption as result. Example of non verified working environments and related advices:

Industrial environment (e.g. where 3-phase 380V mains is being used mainly): Danger of disturbances of this product due to possible strong electromagnetic fields especially near to big machinery or power units.

Medical environment: The compliance to the Medical Product Directive has not been verified by Toshiba, therefore this product cannot be used as a medical product without further verification. The use in usual office environments e.g. in hospitals should be no problem if there is no restriction by the responsible administration.

Automotive environment: Please search the owner instructions of the related vehicle for advices regarding the use of this product (category).

Aviation environment: Please follow the instructions of the flight personnel regarding restrictions of use.

Additional environments not related to EMC

Outdoor use: As a typical home/office equipment this product has no special resistance against ingress of moisture and is not strong shock proofed.

Explosive atmosphere: The use of this product in such special working environment (Ex) is not allowed.

REACH - Compliance Statement

The new European Union (EU) chemical regulation, REACH (Registration, Evaluation, Authorization and Restriction of Chemicals), entered into force on 1 June 2007. Toshiba will meet all REACH requirements and is committed to provide our customers with information about the chemical substances in our products according to REACH regulation.

Please consult the following website

www.toshiba-europe.com/computers/info/reach for information about the presence in our articles of substances included on the candidate list according to article 59(1) of Regulation (EC) No 1907/2006 ("REACH") in a concentration above 0.1 % weight by weight.

Following information is only valid for EU-member States:

Disposal of products



The crossed out wheeled dust bin symbol indicates that products must be collected and disposed of separately from household waste. Integrated batteries and accumulators can be disposed of with the product. They will be separated at the recycling centres.

The black bar indicates that the product was placed on the market after August 13, 2005.

By participating in separate collection of products and batteries, you will help to assure the proper disposal of products and batteries and thus help to prevent potential negative consequences for the environment and human health.

For more detailed information about the collection and recycling programmes available in your country, please visit our website (<http://eu.computers.toshiba-europe.com>) or contact your local city office or the shop where you purchased the product.

Disposal of batteries and/or accumulators



Pb, Hg, Cd

The crossed out wheeled dust bin symbol indicates that batteries and/or accumulators must be collected and disposed of separately from household waste.

If the battery or accumulator contains more than the specified values of lead (Pb), mercury (Hg), and/or cadmium (Cd) defined in the Battery Directive (2006/66/EC), then the chemical symbols for lead (Pb), mercury (Hg) and/or cadmium (Cd) will appear below the crossed out wheeled dust bin symbol.

By participating in separate collection of batteries, you will help to assure the proper disposal of products and batteries and thus help to prevent potential negative consequences for the environment and human health.

For more detailed information about the collection and recycling programmes available in your country, please visit our website (<http://eu.computers.toshiba-europe.com>) or contact your local city office or the shop where you purchased the product.



These symbols may not stick depending on the country and region where you purchased.

Wireless LAN and your Health

Wireless LAN products, like other radio devices, emit radio frequency electromagnetic energy. The level of energy emitted by Wireless LAN devices however is far much less than the electromagnetic energy emitted by wireless devices like for example mobile phones.

Because Wireless LAN products operate within the guidelines found in radio frequency safety standards and recommendations, TOSHIBA believes Wireless LAN is safe for use by consumers. These standards and recommendations reflect the consensus of the scientific community and result from deliberations of panels and committees of scientists who continually review and interpret the extensive research literature.

In some situations or environments, the use of Wireless LAN may be restricted by the proprietor of the building or responsible representatives of the organization. These situations may for example include:

- Using the Wireless LAN equipment on board of airplanes, or
- In any other environment where the risk of interference to other devices or services is perceived or identified as harmful.

If you are uncertain of the policy that applies on the use of wireless devices in a specific organization or environment (e.g. airports), you are encouraged to ask for authorization to use the Wireless LAN device prior to turning on the equipment.

Additional information

© 2010 TOSHIBA Europe GmbH. All rights reserved.

TOSHIBA reserves the right to make technical changes. TOSHIBA assumes no liability for damages incurred directly or indirectly from errors, omissions or discrepancies between this product and the documentation.

GMH300112E10

Free Manuals Download Website

<http://myh66.com>

<http://usermanuals.us>

<http://www.somanuals.com>

<http://www.4manuals.cc>

<http://www.manual-lib.com>

<http://www.404manual.com>

<http://www.luxmanual.com>

<http://aubethermostatmanual.com>

Golf course search by state

<http://golfingnear.com>

Email search by domain

<http://emailbydomain.com>

Auto manuals search

<http://auto.somanuals.com>

TV manuals search

<http://tv.somanuals.com>