

# User's Manual

**Qosmio G50**

**TOSHIBA**

Leading Innovation >>>

# Table of Contents

## **Preface**

## **General Precautions**

### *Chapter 1*

## **Introduction**

Equipment checklist .....	1-1
Hardware .....	1-3
Special features .....	1-11
TOSHIBA Value Added Package .....	1-13
Utilities and Applications .....	1-14
Optional accessories .....	1-18

### *Chapter 2*

## **The Grand Tour**

Front with the display closed .....	2-1
Left side .....	2-2
Right side .....	2-4
Back .....	2-5
Underside .....	2-7
Front with the display open .....	2-8
System indicators .....	2-11
Optical disc drives .....	2-13
AC adaptor .....	2-15

### *Chapter 3*

## **Getting Started**

Connecting the AC adaptor .....	3-2
Opening the display .....	3-4
Turning on the power .....	3-5
Starting up for the first time .....	3-5
Turning off the power .....	3-6
Restarting the computer .....	3-10
System Recovery Options .....	3-10
Restoring the pre-installed Software .....	3-11

**Chapter 4 Operating Basics**

Using the Touch Pad .....	4-1
AV Controller .....	4-2
Using the Fingerprint Sensor (optional) .....	4-2
Web Camera .....	4-10
Using the TOSHIBA Face Recognition .....	4-11
Using optical disc drives .....	4-15
Writing CD/DVDs on DVD Super Multi (+-R DL) drives .....	4-18
Media care .....	4-27
TV Tuner (optional) .....	4-29
Sound system .....	4-31
Modem .....	4-33
Wireless communications .....	4-37
LAN .....	4-40
Computer Handling .....	4-42

**Chapter 5 The Keyboard**

Typewriter keys .....	5-1
Function keys: F1 ... F9 .....	5-2
Soft keys: FN key combinations .....	5-2
Hot keys .....	5-2
Windows special keys .....	5-4
Desktop-style Keyboard .....	5-5
Generating ASCII characters .....	5-5

**Chapter 6 Power**

Power conditions .....	6-1
Monitoring of power condition .....	6-2
Battery .....	6-4
Replacing the battery pack .....	6-8
TOSHIBA Password Utility .....	6-11
Starting the computer by password .....	6-12
Power-up modes .....	6-13
Panel power on/off .....	6-13
System automatic Sleep/Hibernation .....	6-13

**Chapter 7 HW Setup**

Accessing HW Setup .....	7-1
HW Setup window .....	7-1

**Chapter 8 AV functions**

Media Center .....	8-1
Front operation panel .....	8-2
Remote controller .....	8-4
Using the remote controller .....	8-8
Installing/Removing batteries .....	8-9

Set-top box Connection Method and Watching TV on the Media Center . . . . .	8-11
Listen to radio . . . . .	8-13
TOSHIBA DVD PLAYER . . . . .	8-14

*Chapter 9* **Optional Devices**

ExpressCard . . . . .	9-2
Bridge media slot . . . . .	9-3
Additional memory module . . . . .	9-8
Battery Packs . . . . .	9-12
Universal AC Adaptor . . . . .	9-12
Battery Charger . . . . .	9-13
USB . . . . .	9-13
eSATA (External Serial ATA) . . . . .	9-15
External monitor . . . . .	9-16
HDMI . . . . .	9-17
i.LINK (IEEE1394) . . . . .	9-19
Security lock . . . . .	9-21

*Chapter 10* **Troubleshooting**

Problem solving process . . . . .	10-1
Hardware and system checklist . . . . .	10-3
TOSHIBA support . . . . .	10-26

*Chapter 11* **Legal Footnotes**

*Appendix A* **Specifications**

*Appendix B* **Display Controller and Video mode**

*Appendix C* **Wireless LAN**

Card Specifications . . . . .	C-1
Radio Characteristics . . . . .	C-2
Supported Frequency Sub-bands . . . . .	C-2

*Appendix D* **Bluetooth wireless technology Interoperability**

Bluetooth wireless technology and your Health . . . . .	D-2
Regulatory statements . . . . .	D-2

*Appendix E* **AC Power Cord and Connectors**

*Appendix F* **Usage Restrictions**

*Appendix G* **If your computer is stolen**

**Glossary**

**Index**

## Copyright

© 2008 by TOSHIBA Corporation. All rights reserved. Under the copyright laws, this manual cannot be reproduced in any form without the prior written permission of TOSHIBA. No patent liability is assumed, with respect to the use of the information contained herein.

*TOSHIBA Qosmio G50 Portable Personal Computer User's Manual*

First edition June 2008

Copyright authority for music, movies, computer programs, databases and other intellectual property covered by copyright laws belongs to the author or to the copyright owner. Copyrighted material can be reproduced only for personal use or use within the home. Any other use beyond that stipulated above (including conversion to digital format, alteration, transfer of copied material and distribution on a network) without the permission of the copyright owner is a violation of copyright or author's rights and is subject to civil damages or criminal action. Please comply with copyright laws in making any reproduction from this manual.

Please note that you may infringe the owner's rights protected by the copyright laws if you use the screen mode switching functions (e.g. Wide mode, Wide Zoom mode, etc.) of this product to display enlarged images/video at coffee shops or hotels for the purposes of profits or providing these to the public.

## Disclaimer

This manual has been validated and reviewed for accuracy. The instructions and descriptions it contains are accurate for the TOSHIBA Qosmio G50 Portable Personal Computer at the time of this manual's production. However, succeeding computers and manuals are subject to change without notice. TOSHIBA assumes no liability for damages incurred directly or indirectly from errors, omissions or discrepancies between the computer and the manual.

## Trademarks

IBM is a registered trademark and IBM PC is a trademark of International Business Machines Corporation.

Intel, Intel SpeedStep, Intel Core, Celeron and Centrino are trademarks or registered trademarks of Intel Corporation.

Windows, Microsoft and Windows Vista are registered trademarks of Microsoft Corporation.

Photo CD is a trademark of Eastman Kodak Company.

Bluetooth is a trademark owned by its proprietor and used by TOSHIBA under license.

Memory Stick, Memory Stick Duo, Memory Stick PRO, Memory Stick PRO Duo and i.LINK are trademarks or registered trademarks of Sony Corporation.

DVD MovieFactory is a registered trademark of Ulead Systems, Inc.

Manufactured under license from Dolby Laboratories.  
Dolby and the double-D symbol are trademarks of Dolby Laboratories.  
Dolby Home Theater is a trademark of Dolby Laboratories.  
PalmCheck and TouchPad are trademarks of Synaptics Incorporated.  
ExpressCard is a trademark of PCMCIA.  
ConfigFree is a trademark of Toshiba Corporation.  
Wi-Fi is a registered trademark of the Wi-Fi Alliance.  
Secure Digital and SD are trademarks of SD Card Association.  
MultiMediaCard and MMC are trademarks of MultiMediaCard Association.  
xD-Picture Card is a trademark of FUJIFILM Corporation.  
Other trademarks and registered trademarks not listed above may be used in this manual.

## Macrovision License

This product includes copyright protection technology and intellectual property that are patented in the U.S. and other countries. These patents are the property of Macrovision Corporation. The use of copyright protection must be authorized by Macrovision Corporation. It is intended for home and other restricted-use applications, unless Macrovision Corporation expressly authorizes otherwise. All forms of reverse engineering or decompiling are forbidden.

## Safety Instructions

Use the following safety guidelines to help protect yourself and your computer.

### When Using Your Computer



*Do not operate your portable computer for an extended period of time with the base resting directly on your body. With extended operation, heat can potentially build up in the base. Allowing sustained contact with the skin could cause discomfort or, eventually, a burn.*

- Do not attempt to service the computer yourself. Always follow installation instructions closely.
- Do not carry a battery in your pocket, purse, or other container where metal objects (such as car keys) could short-circuit the battery terminals. The resulting excessive current flow can cause extremely high temperatures and may result in damage from burns.
- Be sure that nothing rests on your AC adapter's power cable and that the cable is not located where it can be tripped over or stepped on.
- Place the AC adapter in a ventilated area, such as a desk top or on the floor, when you use it to run the computer or to charge the battery. Do not cover the AC adapter with papers or other items that will reduce cooling; also, do not use the AC adapter while it is inside a carrying case.

- Use only the AC adapter and batteries that are approved for use with this computer. Use of another type of battery or AC adapter may risk fire or explosion.
- Before you connect the computer to a power source, ensure that the voltage rating of the AC adapter matches that of the available power source. 115V/60 Hz in most of North and South America and some Far Eastern countries such as Taiwan. 100 V/50 Hz in eastern Japan and 100 V/60 Hz in western Japan. 230 V/50 Hz in most of Europe, the Middle East, and the Far East.
- If you use an extension cable with your AC adapter, ensure that the total ampere rating of the products plugged in to the extension cable does not exceed the ampere rating of the extension cable.
- To remove power from the computer, turn it off, remove the battery, and disconnect the AC adapter from the electrical outlet.
- To help avoid the potential hazard of electric shock, do not connect or disconnect any cables or perform maintenance or reconfiguration of this product during an electrical storm.
- When setting up the computer for work, place it on a level surface.

## EU Declaration of Conformity



This product is carrying the CE-Mark in accordance with the related European Directives. Responsible for CE-Marking is TOSHIBA Europe GmbH, Hammfelddamm 8, 41460 Neuss, Germany.

The complete and official EU Declaration of Conformity can be found on TOSHIBA's web site <http://epps.toshiba-teg.com> on the Internet.

### **CE compliance**

This product is labelled with the CE Mark in accordance with the related European Directives, notably Electromagnetic Compatibility Directive 89/336/EEC for the notebook and the electronic accessories including the supplied power adapter, the Radio Equipment and Telecommunications Terminal Equipment Directive 1999/5/EC in case of implemented telecommunication accessories and the Low Voltage Directive 73/23/EEC for the supplied power adapter.

This product and the original options are designed to observe the related EMC (Electromagnetic Compatibility) and safety standards. However, TOSHIBA cannot guarantee that this product still observes these EMC standards if options or cables not produced by TOSHIBA are connected or implemented. In this case the persons who have connected / implemented those options / cables have to provide assurance that the system (PC plus options / cables) still fulfils the required standards. To avoid general EMC problems, the following guidance should be noted:

- Only CE marked options should be connected / implemented
- Only best shielded cables should be connected

## GOST



### Important Safety Information for Computers with TV tuner

IEC60950-1/EN60950-1 Information technology equipment - Safety - Coaxial cable connection to this computer must only be used if the cable outer conductive shielding has been grounded by the cable installer at the building premises as close to the point of cable entrance, or attachment, as practicable and the connection complies with all local cable installation requirements that are applicable in your area.

### Modem warning notice



*This information is applicable to the models equipped with a built-in modem.*

### Conformity Statement

The equipment has been approved to [Commission Decision “CTR21”] for pan-European single terminal connection to the Public Switched Telephone Network (PSTN).

However, due to differences between the individual PSTNs provided in different countries/regions the approval does not, of itself, give an unconditional assurance of successful operation on every PSTN network termination point.

In the event of problems, you should contact your equipment supplier in the first instance.



## Network Compatibility Statement

This product is designed to work with, and is compatible with the following networks. It has been tested to and found to conform with the additional requirements conditional in EG 201 121.

Germany	ATAAB AN005,AN006,AN007,AN009,AN010 and DE03,04,05,08,09,12,14,17
Greece	ATAAB AN005,AN006 and GR01,02,03,04
Portugal	ATAAB AN001,005,006,007,011 and P03,04,08,10
Spain	ATAAB AN005,007,012, and ES01
Switzerland	ATAAB AN002
All other countries/regions	ATAAB AN003,004

Specific switch settings or software setup are required for each network, please refer to the relevant sections of the user guide for more details.

The hookflash (timed break register recall) function is subject to separate national type approvals. It has not been tested for conformity to national type regulations, and no guarantee of successful operation of that specific function on specific national networks can be given.

## Following information is only for EU-member States

### Disposal of products



The symbol indicates that this product may not be treated as household waste. Please ensure this product is properly disposed as inappropriate waste handling of this product may cause potential hazards to the environment and human health.

For more detailed information about recycling of this product, please contact your local city office, your household waste disposal service or the shop where you purchased the product.

### Disposal of batteries and/or accumulators



Pb, Hg, Cd

The crossed out wheeled dust bin symbol indicates that batteries and/or accumulators must be collected and disposed of separately from household waste. If the battery or accumulator contains more than the specified values of lead (Pb), mercury (Hg), and/or cadmium (Cd) defined in the Battery Directive (2006/66/EC), then the chemical symbols for lead (Pb), mercury (Hg) and/or cadmium (Cd) will appear below the crossed out wheeled dust bin symbol.



*This symbol may not be displayed depending on the country and region where you purchased.*

## Disposing of the computer and the computer's batteries

- Discard this computer in accordance with applicable laws and regulations. For further information, contact your local government.
- This computer contains rechargeable batteries. After repeated use, the batteries will finally lose their ability to hold a charge and you will need to replace them. Under certain applicable laws and regulation, it may be illegal to dispose of old batteries by placing them in the trash.
- Please be kind to our shared environment. Check with your local government authority for details regarding where to recycle old batteries or how to dispose of them properly. This product contains mercury. Disposal of this material may be regulated due to environmental considerations. For disposal, reuse or recycling information, please contact your local government.

## ENERGY STAR® Program



Your computer model may be Energy Star® qualified. If the model you purchased is compliant, it is labeled with the ENERGY STAR logo on the computer and the following information applies.

TOSHIBA is a partner in the Environmental Protection Agency's (EPA) ENERGY STAR® Program and has designed this computer to meet the latest ENERGY STAR® guidelines for energy efficiency. Your computer ships with the power management options preset to a configuration that will provide the most stable operating environment and optimum system performance for both AC power and battery modes.

To conserve energy, your computer is set to enter the low-power Sleep mode which shuts down the system and display within 15 minutes of inactivity in AC power mode. TOSHIBA recommends that you leave this and other energy saving features active, so that your computer will operate at its maximum energy efficiency. You can wake the computer from Sleep mode by pressing the power button.

Products that earn the ENERGY STAR® prevent greenhouse gas emissions by meeting strict energy efficiency guidelines set by the US EPA and the EU Commission. According to the EPA, a computer meeting the new ENERGY STAR® specifications will use between 20% and 50% less energy depending on how it is used.

Visit <http://www.eu-energystar.org> or <http://www.energystar.gov> for more information regarding the ENERGY STAR Program.

Visit <http://www.energystar.gov> or <http://www.energystar.gov/power> management for more information regarding the ENERGY STAR Program.

## Optical disc drive standards

TOSHIBA Qosmio G50 computer is shipped with the following drive preinstalled: DVD Super Multi ( $\pm$ R DL).



- *The drive employs a laser system. To ensure proper use of this product, please read this instruction manual carefully and retain for future reference.  
Should the unit ever require maintenance, contact an authorized service location.*
- *Use of controls, adjustments or the performance of procedures other than those specified may result in hazardous radiation exposure*
- *To prevent direct exposure to the laser beam, do not try to open the enclosure.*

The drive has one of the following labels:

**CLASS 1 LASER PRODUCT**

**LASER KLASSE 1**

**LUOKAN 1 LASERLAITE**

**APPAREIL A LASER DE CLASSE1**

**KLASS 1 LASER APPARAT**

CLASS 1 LASER PRODUCT  
LASER KLASSE 1 PRODUKT  
TO EN 60825-1  
クラス1レーザー製品

CLASS 1 LASER PRODUCT  
LASERSCHUTZKLASSE 1  
PRODUKT  
TOEN60825-1

ADVERSEL:USYNLIG  
LASERSTRÅLING VED  
ÅBNING, NÅR  
SIKKERHEDSAF-BRYDER  
ER UDE AF FUNKTION.  
UNDGÅ UDSÆTTSELSE  
FOR STRÅLING

Before it is shipped, the Class 1 Laser is certified to meet the United States Chapter 21 Standards of the Department of Health and Human Services (DHHS 21 CFR).

For any other country, the drive is certified to meet the Class 1 Laser standards of IEC825 and EN60825.

This computer is equipped with one of the optical drives in the following list:

Manufacturer	Type
TEAC	DVD Super Multi ( $\pm$ R Double Layer) DV-W28S
Panasonic Communications	DVD Super Multi ( $\pm$ R Double Layer) UJ870

## Important notice

Copyrighted works including, but not limited to music, video, computer program, databases are protected by copyright laws. Unless specifically permitted under applicable copyright laws, you cannot copy, modify, assign, transmit or otherwise dispose of any copyrighted work with the consent of the owner of the copyright. Please take notice that unauthorized copying, modification, assignment, transmission and disposition may be subject to claims for damages and penalties.

- Avoid using a telephone (other than a cordless type) during an electrical storm. There may be a remote risk of electric shock from lightning.
- Do not use the telephone to report a gas leak in the vicinity of the leak.
- Use only the power cord indicated in this manual.
- Replace only with the same or equivalent type battery recommended by the manufacturer.
- Dispose of used batteries according to the manufacturer's instructions.



*Use only the battery pack that came with the computer or an optional battery pack. Use of wrong battery could damage your computer.*

TOSHIBA assumes no liability for any damage in such case.

# Preface

Congratulations on your purchase of the Qosmio G50 computer. This powerful notebook computer provides excellent expansion capability, includes multimedia functionality, and is designed to provide years of reliable, high-performance computing.

This computer family includes a model with built-in TV tuner. When you wish to display a TV program or play CD/DVD before Windows® starts, touch the CD/DVD panel on the computer (or the same buttons on the remote controller). When Windows is running, you can display or record a TV program using the My TV feature of Media Center.

This manual tells how to set up and begin using your Qosmio G50 computer. It also provides detailed information on configuring your computer, basic operations and care, using optional devices and troubleshooting.

If you are a new user of computers or if you're new to portable computing, first read over the Chapter 1, *Introduction* and Chapter 2, *The Grand Tour*, to familiarize yourself with the computer's features, components and accessory devices. Then read Chapter 3, *Getting Started*, for step-by-step instructions on setting up your computer.

If you are an experienced computer user, please continue reading the preface to learn how this manual is organized, then become acquainted with this manual by browsing through its pages. Be sure to read the *Special features* section in Chapter 1, *Introduction*, to learn about features that are uncommon or unique to this computer, as well as the section on Chapter 7, *HW Setup*, to understand how to setup and configure these features.

Read Chapter 9, *Optional Devices*, if connecting optional products or external devices.

## Conventions

This manual uses the following formats to describe, identify, and highlight terms and operating procedures.

### Abbreviations

On first appearance, and whenever necessary for clarity, abbreviations are enclosed in parentheses following their definition. For example: Read Only Memory (ROM). Acronyms are also defined in the Glossary.

### Icons

Icons identify ports, dials, and other parts of your computer. The indicator panel also uses icons to identify the components it is providing information on.

### Keys

The keyboard keys are used in the text to describe many computer operations. A distinctive typeface identifies the key top symbols as they appear on the keyboard. For example, **ENTER** identifies the **ENTER** key.

### Key operation

Some operations require you to simultaneously use two or more keys. We identify such operations by the key top symbols separated by a plus sign (+). For example, **CTRL + C** means you must hold down **CTRL** and at the same time press **C**. If three keys are used, hold down the first two and at the same time press the third.

#### ABC

When procedures require an action such as clicking an icon or entering text, the icon's name or the text you are to type in is represented in the typeface you see to the left.

### Display



#### ABC

Names of windows or icons or text generated by the computer that appear on its display screen are presented in the type face you see to the left.

## Messages

Messages are used in this manual to bring important information to your attention. Each type of message is identified as shown below.



*Pay attention! A caution informs you that improper use of equipment or failure to follow instructions may cause data loss or damage your equipment.*



*Please read. A note is a hint or advice that helps you make best use of your equipment.*



*Indicates a potentially hazardous situation, which could result in death or serious injury, if you do not follow instructions.*

## Terminology

This term is defined in this document as follows:

### Start

The word “**Start**” refers to the “” button in Microsoft® Windows Vista®.

## General Precautions

TOSHIBA computers are designed to optimize safety, minimize strain and withstand the rigors of portability. However, certain precautions should be observed to further reduce the risk of personal injury or damage to the computer.

Be certain to read the general precautions below and to note the cautions included in the text of the manual.

### Provide adequate ventilation

- Always make sure your computer and AC adaptor have adequate ventilation and are protected from overheating when the power is turned on or when an AC adaptor is connected to a power outlet (even if your computer is in Sleep Mode). In this condition, observe the following:
  - Never cover your computer or AC adaptor with any object.
  - Never place your computer or AC adaptor near a heat source, such as an electric blanket or heater.
  - Never cover or block the air vents including those located at the base of the computer.
  - Always operate your computer on a hard flat surface. Using your computer on a carpet or other soft material can block the vents.
- Always provide sufficient space around the computer.
- Overheating your computer or AC adaptor could cause system failure, computer or AC adaptor damage or a fire, possibly resulting in serious injury.

### Creating a computer-friendly environment

Place the computer on a flat surface that is large enough for the computer and any other items you are using, such as a printer.

Leave enough space around the computer and other equipment to provide adequate ventilation. Otherwise, they may overheat.



To keep your computer in prime operating condition, protect your work area from:

- Dust, moisture, and direct sunlight.
- Equipment that generates a strong electromagnetic field, such as stereo speakers (other than speakers that are connected to the computer) or speakerphones.
- Rapid changes in temperature or humidity and sources of temperature change such as air conditioner vents or heaters.
- Extreme heat, cold, or humidity.
- Liquids and corrosive chemicals.

## Stress injury

Carefully read the *Instruction Manual for Safety and Comfort*. It contains information on the prevention of stress injuries to your hands and wrists that can be caused by extensive keyboard use. *Instruction Manual for Safety and Comfort* also includes information on work space design, posture and lighting that can help reduce physical stress.

## Heat injury

- Avoid prolonged physical contact with the computer. If the computer is used for long periods, its surface can become very warm. While the temperature will not feel hot to the touch, if you maintain physical contact with the computer for a long time, for example if you rest the computer on your lap or if you keep your hands on the palm rest, your skin might suffer a low-heat injury.
- If the computer has been used for a long time, avoid direct contact with the metal plate supporting the various interface ports as this can become hot.
- The surface of the AC adaptor can become hot when in use but this condition does not indicate a malfunction. If you need to transport the AC adaptor, you should disconnect it and let it cool before moving it.
- Do not lay the AC adaptor on a material that is sensitive to heat as the material could become damaged.

## Pressure or impact damage

Do not apply heavy pressure to the computer or subject it to any form of strong impact as this can damage the computer's components or otherwise cause it to malfunction.

## Mobile phones

Please be aware that the use of mobile phones can interfere with the audio system. The operation of the computer will not be impaired in any way, but it is recommended that a minimum distance of 30cm is maintained between the computer and a mobile phone that is in use.

## Instruction Manual for Safety and Comfort

All important information on the safe and proper use of this computer is described in the enclosed Instruction Manual for Safety and Comfort. Be sure to read it before using the computer.

### The cautions on use of a Qosmio G50 computer

1. Clean any dust accumulated on the computer's cooling vents. The cooling vents are located on the back and underside of the computer.



*When you use your computer in a dusty area, dirt and debris may accumulate on the cooling vents at the under side of your unit. If this occurs, the accumulated dust can cause insufficient heat dissipation which may result in the computer shutting down during use. Carefully clean the dust from the vents using a vacuum cleaner.*

2. Cooling vents on the underside and back of the computer.

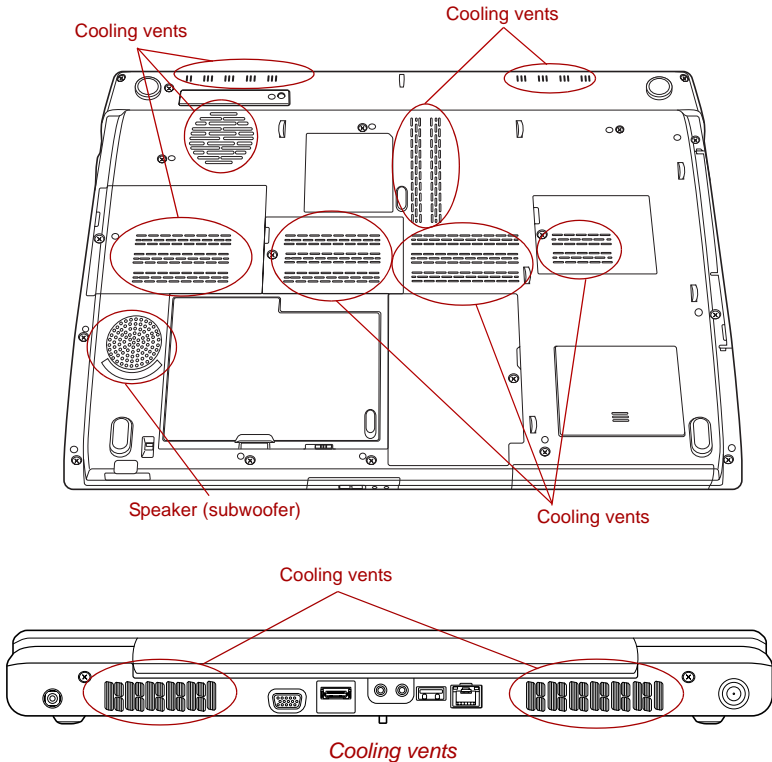



*To prevent possible overheating of the CPU, make sure the cooling fan's air intake is not blocked. The fan draws in air by creating a vacuum. If the fan is blocked, it could cause the CPU to run at a lower performance level or cause the computer to shut down. Loose items such as notebook and tissue paper, plastic wrappers, or other similar materials can block the air intake, preventing air from reaching the CPU. Do not use the computer on surfaces with objects that can be drawn in by the cooling fan.*



# Chapter 1

## Introduction

This chapter provides an equipment checklist, and it identifies the computer's features, options and accessories.



*Some of the features described in this manual may not function properly if you use an operating system that was not pre-installed by TOSHIBA.*

## Equipment checklist

Carefully unpack your computer, taking care to save the box and packaging materials for future use.

### Hardware

Check to make sure you have all the following items:

- Qosmio G50 Portable Personal Computer
- AC adaptor and power cord (2-pin plug or 3-pin plug)
- Remote controller (provided with some models)
- Two AA manganese batteries (for Remote controller)
- DVB-T Antenna (provided with some models)
- VIDEO-IN cable (provided with some models)
- Infrared transmitter cable (provided with some models)
- Cleaning cloth



*Use the cleaning cloth to wipe away dust, fingerprints and similar from the keyboard, palm rest and other parts. For precautions on use refer to the [Using the cleaning cloth](#) section in Chapter 4, [Operating Basics](#).*

## Software

The following Windows operating system and utility software are pre-installed.

- Microsoft® Windows Vista™
- TOSHIBA Value Added Package
- Ulead DVD MovieFactory®
- Fingerprint Utility \*
- TOSHIBA Gesture Controller \*
- TOSHIBA Graphical Video Library \*
- TOSHIBA HD Console \*
- TOSHIBA Face Recognition
- Windows Mobility Center
- TOSHIBA Disc Creator
- TOSHIBA Recovery Disc Creator
- TOSHIBA ConfigFree™
- TOSHIBA Assist
- TOSHIBA SD Memory Utilities
- CD/DVD Drive Acoustic Silencer
- TOSHIBA Password Utility
- TOSHIBA DVD PLAYER
- Online Manual

\* Indicates software that is preinstalled with some models

## Documentation

- Qosmio G50 Portable Personal Computer User's Manual
- Qosmio G50 Quickstart
- Instruction Manual for Safety and Comfort
- Warranty information



If any of the items are missing or damaged, contact your dealer immediately.

## Hardware

This section describes the hardware of your computer. The actual specifications may vary depending on the model you purchased.

### Processor

<b>Built-in</b>	<p>The computer is equipped with one of the following Intel® processor.</p> <ul style="list-style-type: none"> <li>■ Intel® Core™ 2 Duo Processor, which incorporates a 3MB level2 cache memory and also supports Enhanced Intel SpeedStep® Technology.</li> <li>■ Intel® Core™ 2 Duo Processor, which incorporates a 6MB level2 cache memory and also supports Enhanced Intel SpeedStep® Technology.</li> </ul>
-----------------	--



*Some models in this series use Intel® Centrino® 2 processor technology which is based on three separate components, the Intel® Core™ 2 Duo processor, Intel® Wi-Fi® Link 5300AGN -OR- 5100AGN and the Intel® GM/PM45 Express Chipset.*

### Legal Footnote (CPU)\*1

For more information on the CPU, please refer to the [Legal Footnotes](#) section in Chapter 11 or Click the \*1 above.

### Memory

<b>Memory slots</b>	<p>512, 1,024, 2,048 or 4,096MB memory modules can be installed in the computer's two memory slots for a maximum of 8,192MB system memory.</p> <p>This computer can be equipped with memory modules of a maximum size of 8,192MB. The actual amount of useable system memory will be less than the installed memory modules.</p>
---------------------	--



If your computer is configured with two 2 GB memory modules or more, the memory might be displayed as approximately 3 GB only (depending on the computer's hardware specifications).

This is correct because the operating system usually displays the available memory instead of the physical memory (RAM) built into the computer.

Various system components (like the video adapter's GPU and PCI devices like Wireless LAN, etc.) require their own memory space. Since a 32-bit operating system cannot address more than 4 GB of memory these system resources overlap the physical memory. It is a technical limitation that the overlapped memory is not available to the operating system.

Even though some tools might display the actual physical memory built into your computer, the memory available to the operating system will still be approximately 3 GB only.

---

### Video RAM

The memory in a computer's graphics adaptor, used to store the image displayed on a bitmap display.

**Start -> Control Panel -> Appearance and Personalization -> Display Settings.**

The amount of Video RAM can be verified by clicking the **Advanced Settings...** button in the Display Settings window.

The amount of Total Available Graphics memory will vary be between 1 and 2 MB depending upon system configuration.

---

### ***Legal Footnote (Memory (Main System))\*2***

For more information regarding Memory (Main System), please refer to the [Legal Footnotes](#) section in Chapter 11 or click the \*2 above.

---

### **Toshiba Quad Core HD Processor**

A co-processor specialized for media streaming processes (real-time image processing such as image processing and image recognition) is installed.

(Provided with some models)

---



---

## Power

---

<b>Battery pack</b>	The computer is powered by one rechargeable lithium-ion battery pack. Battery type (depending on the model you purchased): There are two types of battery packs (7050mAh or 4700mAh).
---------------------	--

---

### **Legal Footnote (Battery Life)\*3**

For more information regarding Battery Life, please refer to the [Legal Footnotes](#) section in Chapter 11 or click the \*3 above.

---

<b>RTC battery</b>	The internal RTC battery backs up the Real Time Clock (RTC) and calendar.
<b>AC adaptor</b>	The AC adaptor provides power to the system and recharges the batteries when they are low. It comes with a detachable power cord which will either have a 2-pin or 3-pin plug enclosure. As the AC adaptor is universal, it can receive a range of AC voltages from 100 to 240 volts, however you should note that the output current varies among different models. Using the wrong adaptor can damage your computer. Refer to the <a href="#">AC adaptor</a> section in Chapter 2, <a href="#">The Grand Tour</a> .

---

## Disks

### Hard disk drive or Solid state drive

This computer is equipped with the following types of hard disk drive (HDD). The capacity of each hard disk drive model is different.

Some models are equipped with a “Solid State Drive (SSD)” instead of a hard disk drive.

- HDD
  - 200GB
  - 250GB
  - 320GB
  - 400GB
  - 500GB
- SSD
  - 64GB
  - 128GB

Two HDD computer models are available, a model with a single hard disk drive and a model with two hard disk drives.

Please note that part of the hard disk drives overall capacity is reserved as administration space.



- *In this manual, the word “HDD” or “Hard disk drive” also refers to the SSD unless otherwise stated.*
- *SSD is a large-capacity storage media which uses Solid-State Memory in place of a magnetic disk of the hard disk.*



*Under certain unusual conditions of prolonged non-use and/or exposure to high temperatures, the SSD may be vulnerable to data retention errors.*

### **Legal Footnote (Hard Disk Drive (HDD) Capacity)\*4**

For more information regarding Hard Disk Drive (HDD) Capacity, please refer to the [Legal Footnotes](#) section in Chapter 11 or click the \*4 above.

---

## Optical disc drive

### DVD Super Multi (+- R DL) drive

Your computer is equipped with a full-size DVD Super Multi drive module that lets you run CD's or DVD's without using an adaptor. The drive reads DVD-ROM's at a maximum 8x speed and CD-ROM's at a maximum 24x speed, and writes CD-R's and CD-RW's at up to 24x speed, DVD-R's, DVD+R's and DVD+RW's at up to 8x speed, DVD-RW's, DVD-R (Dual Layer) and DVD+R (Double Layer) at up to 6x speed, DVD-RAM at up to 5x speed, and supports the following formats:

- CD-R
- CD-RW
- DVD-ROM
- DVD-Video
- CD-DA
- CD-Text
- Photo CD™ (single/multi-session)
- CD-ROM Mode 1, Mode 2
- CD-ROM XA Mode 2 (Form1, Form2)
- Enhanced CD (CD-EXTRA)
- Addressing Method 2
- DVD-R
- DVD-R (Dual Layer)
- DVD-RW
- DVD+R
- DVD+R (Double Layer)
- DVD+RW
- DVD-RAM

---

## Display

The computer's internal display panel supports high-resolution video graphics and can be set to a wide range of viewing angles for maximum comfort and readability.

### Display panel

18.4" TFT LCD screen (16:9), 32 million colors, with one of the following resolutions:

- HD+, 1680 horizontal x 945 vertical pixels
  - FHD, 1920 horizontal x 1080 vertical pixels
-

**Legal Footnote (LCD)\*5**

For more information regarding the LCD, please refer to the [Legal Footnotes](#) section in Chapter 11 or click the \*5 above.



**Graphics controller**

The graphics controller maximizes display performance. Refer to [Display Controller and Video mode](#) section in Appendix B for more information.

**Legal Footnote (Graphics Processor Unit (“GPU”))\*6**

For more information regarding the Graphics Processor Unit (“GPU”), please refer to the [Legal Footnotes](#) section in Chapter 11 or click the \*6 above.

**Keyboard****Built-in**

The internal keyboard provides the dedicated numeric keys, dedicated cursor control keys,  and  Keys. The keyboard is compatible with the IBM® enhanced keyboard. Refer to Chapter 5, [The Keyboard](#), for details.

**Pointing Device****Built-in Touch Pad**

The integrated Touch Pad and control buttons in the palm rest allow control of the on-screen pointer and support functions such as the scrolling of windows.

**Ports****External monitor**

This port provides 15-pin, analog VGA port. This port allows you to connect an external monitor to the computer.

**Universal Serial Bus (USB 2.0)**

The computer supports multiple Universal Serial Bus ports that comply with the USB 2.0 standard. The ports with the icon (  ) has [USB Sleep and Charge](#).

One of the USB ports has eSATA (External Serial ATA) function.



*Please note that it is not possible to confirm the operation of all functions of all USB devices that are available. In view of this it may be noted that some functions associated with a specific device might not operate properly.*

---

<b>i.LINK (IEEE1394)</b>	This port allows high-speed data transfer to take place between the computer and external devices such as digital video cameras.
--------------------------	--

---

### **Slots**

---

<b>ExpressCard™</b>	The internal ExpressCard slot is a Universal slot. This slot supports ExpressCard/54 and ExpressCard/34 modules.
---------------------	--

---

---

<b>Bridge media</b>	This slot lets you insert an SD™/SDHC™ memory card, miniSD™/microSD™ Card, Memory Stick® (Duo™/PRO™/PRO Duo™), xD-Picture Card™ and MultiMediaCard™. Refer to Chapter 9, <a href="#">Optional Devices</a> .
---------------------	---

---

### **Multimedia**

---

<b>Sound system</b>	The integrated sound system provides support for the computer's internal speakers and microphone, as allowing an external microphone and headphones to be connected via the appropriate jacks.
---------------------	--

---

---

<b>Web Camera</b>	<b>Web Camera</b> is a device that allows you to record video or take photographs with your computer. You can use it for video chatting or video conferences using a communication tool such as <b>Windows Live Messenger</b> . <b>Camera Assistant Software</b> will help you to add various video effects to your video or photograph. Please refer to the <a href="#">Web Camera</a> section in Chapter 4, <a href="#">Operating Basics</a> .
-------------------	--

---

---

<b>TV antenna port</b>	Connect the coaxial cable to this port to watch TV programs on your computer or record them. The dimensions and shape of the TV antenna port vary for different regions. (Provided with some models)
------------------------	---

---

---

<b>HDMI out port</b>	<p>HDMI out port can connect with Type A connector HDMI cable.</p> <p>HDMI cable can send video and audio signals. In addition to this, it can send and receive control signals.</p> <p>By connecting a TV which supports HDMI Control to this port, the remote control for the connected TV can be used to operate some of the computer functions.</p> <p>Refer to the <a href="#">REGZA Link (PC Control)</a> section in Chapter 9, <a href="#">Optional Devices</a>, for more details.</p>
<b>Headphone, S/PDIF and Line out jack</b>	<p>This jack lets you connect digital speakers, a stereo headphone (16 ohm minimum) or a stereo device for audio output. When you connect a digital speaker or headphones, the internal speaker is automatically disabled.</p> <p>This jack can be used also as S/PDIF jack and enables connection of optical digital correspondence apparatus.</p>
<b>Microphone and Line in jack</b>	<p>A 3.5mm mini microphone jack enables connection of a three-conductor mini jack for stereo microphone input, and connection of a stereo device for audio input.</p>
<b>TV Tuner</b>	<p>TV Tuner enables watching and recording TV programs. Some models are equipped with the TV Tuner.</p>
<b>Infrared receiver window</b>	<p>This is a sensor window that receives signals from the remote controller which is provided with your computer.</p> <p>Models which do not include a remote controller are not equipped with an infrared receiver window so the computer cannot be operated with a remote controller.</p>
<b>Full size remote controller</b>	<p>Use this device to navigate when watching TV or playing CDs/DVDs.</p> <p>Some models are equipped with the Full size remote controller</p>

---

## Communications

<b>Modem</b>	Provides capability for data and fax communication. It supports V.90 (V.92). The speed of data transfer and fax communication depends on the analog telephone line conditions. The computer has a modem jack for connection to a telephone line. Both V.90 and V.92 are supported only in the USA, Canada, UK, France and Germany. V.90 is available in other regions. Some models are equipped with the integrated modem.
<b>LAN</b>	The computer has built-in support for Ethernet LAN (10 megabits per second, 10BASE-T), Fast Ethernet LAN (100 megabits per second, 100BASE-TX) and Gigabit Ethernet LAN (1000 megabits per second, 1000BASE-T).
<b>Bluetooth™</b>	Some computers in this series have Bluetooth wireless communication function which eliminates the need for cables between electronic devices such as computers and printers and mobile phones. When it is enabled, Bluetooth provides the wireless personal area network environment which is safe and trustworthy, that is quick and easy.
<b>Wireless LAN</b>	Some computers in this series are equipped with a Wireless LAN module that is compatible with other LAN systems based on Direct Sequence Spread Spectrum/Orthogonal Frequency Division Multiplexing radio technology that complies with the IEEE 802.11 Standard.



*The transmission speed over the wireless LAN, and the distance over which the wireless LAN can reach, may vary depending on surrounding electromagnetic environment, obstacles, access point design and configuration, client design and software/hardware configurations. The transmission rate described is the theoretical maximum speed as specified under the appropriate standard - the actual transmission speed will be lower than the theoretical maximum speed.*

### **Legal Footnote (Wireless LAN)\*7**

For more information regarding Wireless LAN, please refer to the [Legal Footnotes](#) section in Chapter 11 or click the \*7 above.

---

<b>Wireless communication switch</b>	This switch turns the Wireless LAN and Bluetooth functions on and off. Please note that all models are provided with a Wireless communication switch and some models are equipped with both Wireless LAN and Bluetooth functionality.
--------------------------------------	---

---

## **Security**

---

<b>Security lock slot</b>	Connects a security lock to anchor the computer to a desk or other large object.
---------------------------	--

---

## **Special features**

The following features are either unique to TOSHIBA computers or are advanced features which make the computer more convenient to use.

Access each function using the following procedures.

\*1 To access the Power Options, click **Start -> Control Panel -> System and Maintenance -> Power Options**.

---

<b>Hot keys</b>	Hot keys are specific key combinations that let you quickly change the system configuration directly from the keyboard without running a system program.
-----------------	--

---

<b>Display automatic power off</b> *1	This feature automatically cuts off power to the computer's display panel when there is no keyboard input for a specified time, with power being restored the next time a key is pressed. This can be specified in the Power Options.
---------------------------------------	---

---

<b>HDD automatic power off</b> *1	This feature automatically cuts off power to the hard disk drive when it is not accessed for a specified time, with power being restored when the hard disk drive is next accessed. This can be specified in the Power Options.
-----------------------------------	---

---

<b>System automatic Sleep/Hibernation Mode</b> *1	This feature automatically shuts down the system into either Sleep Mode or Hibernation Mode when there is no input or hardware access for a specified time. This can be specified in the Power Options.
---	---

---

<b>Power on password</b>	Two levels of password security, supervisor and user, are available to prevent unauthorized access to your computer.
--------------------------	--

---

<b>Instant security</b>	A specific hot key function automatically locks the system providing data security.
-------------------------	---

---



<b>Intelligent power supply</b> **1	A microprocessor in the computer's intelligent power supply detects the battery's charge, automatically calculates the remaining battery capacity and protects electronic components from abnormal conditions such as a voltage overload from the AC adaptor. This can be specified in the Power Options.
<b>Battery save mode</b> **1	This feature lets you configure the computer in order to save battery power. This can be specified in the Power Options.
<b>Panel power on/off</b> **1	This feature automatically turns power to the computer off when the display panel is closed, and turns it back on when the display panel is opened. This can be specified in the Power Options.
<b>Low battery automatic Hibernation Mode</b> **1	When battery power is exhausted to the point that computer operation cannot be continued, the system automatically enters Hibernation Mode and shuts itself down. This can be specified in the Power Options.
<b>Heat dispersal</b> **1	To protect against overheating, the processor has an internal temperature sensor so that, if the computer's internal temperature rises to a certain level, the cooling fan is turned on or the processing speed is lowered. This can be specified in the Power Options.
	<i>If the processor's temperature reaches an unacceptably high level with either setting, the computer will automatically shut down to prevent any damage - in this instance all unsaved data in memory will be lost.</i>
	<b>Hibernation Mode</b>
<b>Sleep Mode</b>	If you have to interrupt your work, you can use this feature to allow you to turn off power to the computer without exiting from your software. Data is maintained in the computer's main memory so that when you next turn on the power, you can continue working right where you left off.

<b>USB Sleep and Charge function</b>	<p>This feature allows you to charge USB-compatible external devices such as mobile phones or portable digital music players via the USB port when your computer is in Sleep Mode, Hibernation Mode or in the shutdown state.</p> <p>To run the HW Setup program, click <b>Start -&gt; All Programs -&gt; TOSHIBA -&gt;Utilities -&gt; HWSetup.</b></p>
<b>USB Wakeup function</b>	<p>This function restores the computer from Sleep Mode depending on the external devices connected to the USB ports.</p> <p>For example, if a mouse or USB keyboard is connected to a USB port, moving the mouse/ keyboard will wakeup the computer.</p> <p>The “USB Wakeup function” operates under Windows Vista operating system and it works for all USB ports.</p>

## TOSHIBA Value Added Package

This section describes the TOSHIBA Component features pre-installed on the computer.

<b>TOSHIBA Power Saver</b>	<p>TOSHIBA Power Saver provides you with the features of more various power supply managements.</p>
<b>TOSHIBA Button Support</b>	<p>This utility controls the following computer panel functions.</p> <p>The applications associated with each of the following panels can be assigned by the user.</p> <ul style="list-style-type: none"> <li>■ Panels: Assign applications to the Mute, Illumination On/Off, Camera, DOLBY® panels.</li> </ul>
<b>TOSHIBA Zooming Utility</b>	<p>This utility allows you to enlarge or reduce the icon size on the Windows Desktop, or the zoom factor associated with specific supported applications.</p>
<b>TOSHIBA PC Diagnostic Tool</b>	<p>The TOSHIBA PC Diagnostic Tool will display basic system configuration information and allow the functionality of some of the computer’s built-in hardware devices to be tested.</p>
<b>TOSHIBA Password Utility</b>	<p>The TOSHIBA Password utility allows you to set a password in order to restrict access to the computer.</p>

<b>TOSHIBA Flash Cards</b>	<p>The TOSHIBA Flash Cards provide a quick way to modify selected system functions and to launch applications.</p> <ul style="list-style-type: none"> <li>■ Hot key function</li> <li>■ TOSHIBA utility launcher function</li> </ul>
<b>HW Setup</b>	<p>This utility allows you to customize your hardware settings according to the way you work with the computer and the peripherals you use.</p>
<b>TOSHIBA Accessibility</b>	<p>The TOSHIBA Accessibility utility provides support to movement impaired users when they need to use the TOSHIBA Hot-key functions. In use, the utility allows you to make the <b>FN</b> key “sticky”, that is you can press it once, release it, and they press one of the “<b>F</b>” keys in order to access its specific function. When set, the <b>FN</b> key will remain active until another key is pressed.</p>

## Utilities and Applications

This section describes the pre-installed utilities that come with the computer and details how to start them. For further information on their operation, please refer to each utility’s online manual, help files or README.TXT file.

\* Indicates software that is preinstalled with some models

<b>Fingerprint Utility *</b>	<p>Depending on the model purchased, your computer has a fingerprint utility installed for the purpose of enrolling and recognizing fingerprints. It can then be linked to a username and password in order to remove the need to input these details from the keyboard. Just by swiping an enrolled finger against the fingerprint sensor, the following functions will be enabled:</p> <ul style="list-style-type: none"> <li>■ Logon to Windows and access a security enabled homepage through Internet Explorer.</li> <li>■ Files and folders can be encrypted/decrypted and third party access to them is prevented.</li> <li>■ Disable the password-protected screen-saver when returning from a power-saving mode such as Sleep Mode.</li> <li>■ Authentication of the User Password (and, if applicable, the HDD(Hard Disk Drive) Password) when booting up the computer (Pre-OS Authentication).</li> <li>■ Single-Swipe Sign On feature</li> </ul>
------------------------------	--



*Fingerprint security cannot be used in models that do not have a fingerprint module installed.*

---

### **TOSHIBA HD Console \***

The TOSHIBA HD Console displays the usage for each core in the TOSHIBA Quad Core HD Processor and allows applications which use the TOSHIBA Quad Core HD Processor to be started. To display the TOSHIBA HD Console in the Windows Sidebar, follow the steps below:

1. Right-click the Windows Sidebar
2. Click Add Gadget
3. Double-click the Toshiba HD Console to add it

TOSHIBA HD Console is equipped with some models.

---

### **TOSHIBA Gesture Controller \***

TOSHIBA Gesture Controller is software which allows the computer's Web camera to be used with gestures in place of mouse and remote controller operations to control the TOSHIBA DVD PLAYER when watching or listening to video or music.

To start this software, follow the steps and details below:

1. To start the **TOSHIBA Gesture Controller**, click **Gesture Interface Launch button** in the **TOSHIBA HD Console** on the Windows Sidebar.
2. The **Gesture Interface Launch button** display will change to **Gesture Interface Running**, the TOSHIBA Gesture Controller will start and the TOSHIBA Gesture Controller window will be displayed.

TOSHIBA Gesture Controller software is equipped with some models. Please refer to the help file of software for details.

---

**TOSHIBA Graphical Video Library \***

This software allows you to display a list of all the files and subfolders within a specified folder, index videos and play files. The Index Viewer can also be started in order to view the results of video indexing. Please refer to the help file of software for details.

To start this software, click **Start -> All Programs -> Windows Media Center -> TOSHIBA -> Video Library**.

TOSHIBA Graphical Video Library software is equipped with some models.

**TOSHIBA Face Recognition**

TOSHIBA Face Recognition uses a face verification library to verify the face data of users when they log in to Windows. If the verification is successful, the user will be logged into Windows automatically. The user can thus avoid having to enter a password or the like, which makes the login process easier.

**Bluetooth Stack for Windows by Toshiba**

This software enables communication between the computer and external Bluetooth devices such as printers and mobile phones.



*Bluetooth functions cannot be used in models that do not have a Bluetooth module installed.*

**TOSHIBA Assist**

TOSHIBA Assist is a graphical user interface that provides access to specific tools, utilities and applications that make the use and configuration of the computer easier.

**TOSHIBA ConfigFree**

TOSHIBA ConfigFree is a suite of utilities that improve the ease and control of communication devices and network connections, help in the identification of communication problems and allow the creation of profiles if you need to switch between different locations and communication networks. To access this utility, click **Start -> All Programs -> TOSHIBA -> ConfigFree**.

---

**TOSHIBA Disc Creator**

You can create CD's and DVD's in a number of formats including audio CD's that can be played on a standard CD player, and data CD's/DVD's which can store copies of the files and folders on your computer's hard disk drive. This software can be used on models with a DVD Super Multi drive.

To start this utility, click **Start -> All Programs -> TOSHIBA -> CD&DVD Applications -> Disc Creator**.

---

**Ulead DVD MovieFactory for TOSHIBA**

Ulead DVD MovieFactory for TOSHIBA allows users to instantly create DVD video or slideshow discs via a user-friendly wizard interface with specific task oriented features.

---

**TOSHIBA SD Memory Utilities**

This utility allows you to format an SD/SDHC memory card by the SD standard format.

---

**Windows Mobility Center**

This section describes the Windows Mobility Center. Mobility Center is a utility for accessing several mobile PC settings quickly in one window. A default maximum of eight tiles are provided by the operating system, and the additional two tiles are added to your Mobility Center.

■ **Lock Computer:**

This can be used to lock your computer without turning it off. This has the same function as the **Lock** button at the bottom of the right pane in the start menu.

■ **TOSHIBA Assist:**

This can be used to open **TOSHIBA Assist** if it is already installed in your computer.

---

**TOSHIBA DVD PLAYER**

This software is provided for playback of DVD Video.

It has an on-screen interface and functions. Click **Start -> All Programs -> TOSHIBA DVD PLAYER -> TOSHIBA DVD PLAYER**.

---



*Frame dropping, audio skipping or out of synch audio and video may occur during playback of some DVD Video titles.*

*Make sure to connect the computer's AC adaptor when playing a DVD Video. Power-saving features may interfere with smooth playback.*

---

<b>CD/DVD Drive Acoustic Silencer</b>	The CD/DVD Drive Acoustic Silencer utility allows you to configure the read speed at which the optical disc drive will operate. In use you can select either <b>Normal Mode</b> , which will operate the drive at its maximum speed for quick data access, or <b>Quiet Mode</b> , which operates the drive at single speed for audio CD playback and which can lessen the operational noise. This utility does not have any function when using DVD's.
---------------------------------------	--

---

## Optional accessories

You are able to add a number of options and accessories in order to make your computer even more powerful and convenient to use. For reference, the following list details some of the items that are available from your reseller or TOSHIBA dealer:

---

<b>DDR2-800 Memory Kit</b>	A 1,024MB, 2,048MB or 4,096MB memory module (DDR2-800) can easily be installed in the computer.
<b>Battery Pack</b>	An additional battery pack can be purchased for use as either a spare or replacement. Please refer to Chapter 6, <i>Power</i> , for further information.
<b>Universal AC Adaptor</b>	If you frequently use your computer at more than one site, it may be convenient to purchase an additional AC adaptor to be kept at each site in order to remove the need to always carry the adaptor with you.
<b>USB FDD Kit</b>	The USB floppy diskette drive accommodates either a 1.44MB or 720KB floppy diskette through connection to one of the computer's USB ports. In use, please be aware that, while you cannot format 720KB floppy diskettes under Windows Vista, you are able to read and write to diskettes that have already been formatted.
<b>Battery Charger</b>	The optional battery charger allows you to charge extra battery packs outside of having to use the computer.

---





# Chapter 2

## The Grand Tour

This chapter identifies the various components of the computer - it is recommended that you become familiar with each before you operate the computer.

### **Legal Footnote (Non-applicable Icons)\*8**

For more information regarding Non-applicable Icons, please refer to the [Legal Footnotes](#) section in Chapter 11 or click the \*8 above.



Please handle your computer carefully to avoid scratching or damaging the surface.

## Front with the display closed

The following figure shows the computer's front with its display panel in the closed position.

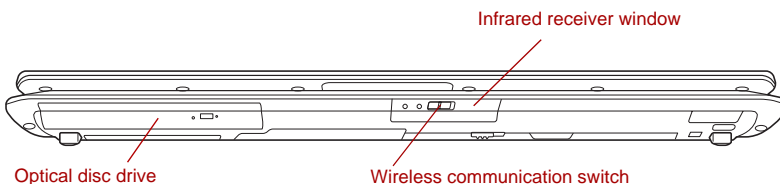

Figure 2-1 Front of the computer with display closed

	<b>Optical disc drive</b>	The computer is configured with a DVD Super Multi (+-R DL) drive.
<b>Off</b>	<b>On</b>	<b>Wireless communication switch</b>
		Slide this switch to the right to turn on Wireless LAN and Bluetooth functions. Slide it to the left to turn off the functions. All models are provided with a Wireless communication switch although only some models are equipped with both Wireless LAN and Bluetooth functions.



- Turn Wi-Fi and Bluetooth functionalities off when near a person who may have a cardiac pacemaker implant or other medical electric device. Radio waves may affect pacemaker or medical device operation, possibly resulting in serious injury. Follow the instruction of your medical device when using any Wi-Fi or Bluetooth functionality.
- Always turn off Wi-Fi or Bluetooth functionality if the computer is near automatic control equipment or appliances such as automatic doors or fire detectors. Radio waves can cause malfunction of such equipment, possibly resulting in serious injury.
- Do not use the Wi-Fi or Bluetooth functionalities near a microwave oven or in areas subject to radio interference or magnetic fields. Interference from a microwave oven or other source can disrupt Wi-Fi or Bluetooth operation.

**Infrared receiver window**

This is a sensor window that receives signals from the remote control which is provided with your computer.



*Models which do not include a remote controller are not equipped with an infrared receiver window so the computer cannot be operated with a remote controller.*

**Left side**

The following figure shows the computer's left side.

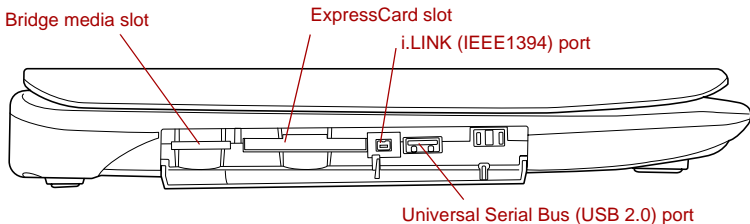

*Figure 2-2 The left side of the computer*



*In order to use the computer's Bridge media slot, ExpressCard slot, i.LINK (IEEE1394) port or USB port (left side), open the left side cover. Open the cover by pressing the top right section of the cover to unlock it.*



**Bridge media slot**

This slot lets you insert an SD/SDHC memory card, miniSD/microSD Card, Memory Stick (Duo/PRO/PRO Duo), xD picture card and MultiMediaCard. Refer to [Bridge media slot](#) section in Chapter 9, [Optional Devices](#).



*Keep foreign metal objects, such as screws, staples and paper clips, out of the Bridge media slot. Foreign metal objects can create a short circuit, which can cause damage and fire, possibly resulting in serious injury.*

**ExpressCard slot**

This slot allows you to install a single ExpressCard device.



*Keep foreign metal objects, such as screws, staples and paper clips, out of the ExpressCard slot. Foreign metal objects can create a short circuit, which can cause damage and fire, possibly resulting in serious injury.*

**i.LINK (IEEE1394) port**

This port allows you to connect an external device, such as a digital video camera for high-speed data transfer.

**Universal Serial Bus (USB 2.0) port**

One Universal Serial Bus port, which complies to the USB 2.0 standard, is provided on the left side of the computer. The port with the icon (  ) has [USB Sleep and Charge](#).



*Keep foreign metal objects, such as screws, staples and paper clips, out of the USB connectors. Foreign metal objects can create a short circuit, which can cause damage and fire, possibly resulting in serious injury.*



*Please note that it is not possible to confirm the operation of all functions of all USB devices that are available. In view of this it may be noted that some functions associated with a specific device might not operate properly.*

## Right side

The following figure shows the computer's right side.

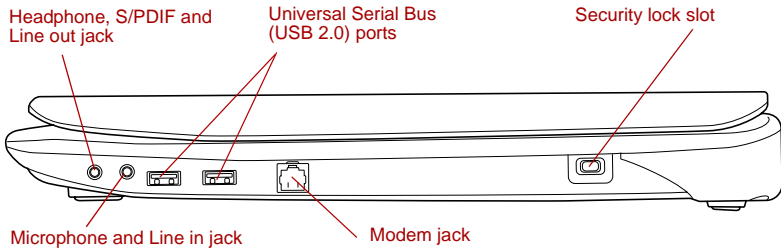

Figure 2-3 The right side of the computer



### Microphone and Line in jack

This jack allows you to connect a microphone or an external audio device.



### Headphone, S/PDIF and Line out jack

This jack allows you to connect a headphone, a MiniDisc audio component or an external audio device.



### Universal Serial Bus (USB 2.0) ports

Two Universal Serial Bus ports, which comply with the USB 2.0 standard, are provided on the right side of the computer. The ports with the icon (⚡) has *USB Sleep and Charge*.



### Modem jack

The modem jack allows you use to attach a modular cable in order to connect the internal modem directly to a telephone line.

Some models are equipped with a built-in modem.



- Connection to any communication line other than an analog phone line could cause a computer system failure.
  - Connect the built-in modem only to ordinary analog phone lines.
  - Never connect the built-in modem to a digital line (ISDN).
  - Never connect the built-in modem to the digital connector on a public telephone or to a digital private branch exchange (PBX).
  - Never connect the built-in modem to a key telephone system for residences or offices.
- Avoid using your computer modem with the telephone cable connected during an electrical storm. There may be a remote risk of electric shock from lightning.



### Security lock slot

A security cable can be attached to this slot and then connected to a desk or other large object in order to deter theft of the computer.

## Back

The following figure shows the computer's back.

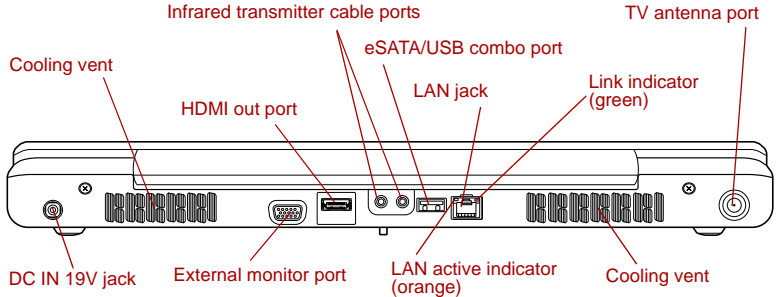

Figure 2-4 The back of the computer



### DC IN 19V jack

The AC adaptor connects to this jack in order to power the computer and charge its internal batteries. Please note that you should only use the model of AC adaptor supplied with the computer at the time of purchase - using the wrong AC adaptor can cause damage to the computer.



### External monitor port

This port allows you to connect an external monitor to the computer.



### HDMI out port

HDMI out port can connect with Type A connector HDMI cable. HDMI cable can send video and audio signals. In addition to this, it can send and receive control signals.



### Infrared transmitter cable ports

Connect the infrared transmitter cable to the infrared transmitter cable port on the computer and to the set-top box. (Provided with some models)



**eSATA/USB combo port**

One eSATA/USB combo port, which complies to the USB 2.0 standard, is provided on the back of the computer. This port has eSATA (External Serial ATA) function. The port with the icon ( ⚡ ) has *USB Sleep and Charge*.



**LAN jack**

This jack lets you connect to a LAN. The adaptor has built-in support for Ethernet LAN (10 megabits per second, 10BASE-T), Fast Ethernet LAN (100 megabits per second, 100BASE-TX) and Gigabit Ethernet LAN (1000 megabits per second, 1000BASE-T). The LAN has two indicators. Refer to Chapter 4, *Operating Basics*, for details.



- Do not connect any cable other than a LAN cable to the LAN jack. It could cause damage or malfunction.
- Do not connect the LAN cable to a power supply. It could cause damage or malfunction.

**Link indicator (green)**

This indicator glows green when the computer is connected to a LAN and the LAN is functioning properly.

**LAN active indicator (orange)**

This indicator glows orange when data is being exchanged between the computer and the LAN.



**TV antenna port**

Connect a coaxial cable to this port to watch TV programs on your computer or record them. The dimensions and shape of the TV antenna port vary for different regions. Some models are equipped with a TV tuner.

**Cooling vents**

The cooling vents help keep the processor from overheating.



*Do not block the cooling vents. Keep foreign metal objects, such as screws, staples and paper clips, out of the cooling vents. Foreign metal objects can create a short circuit, which can cause damage and fire, possibly resulting in serious injury.*

## Underside

The following figure shows the underside of the computer. You should ensure that the display is closed before the computer is turned over to avoid causing any damage.

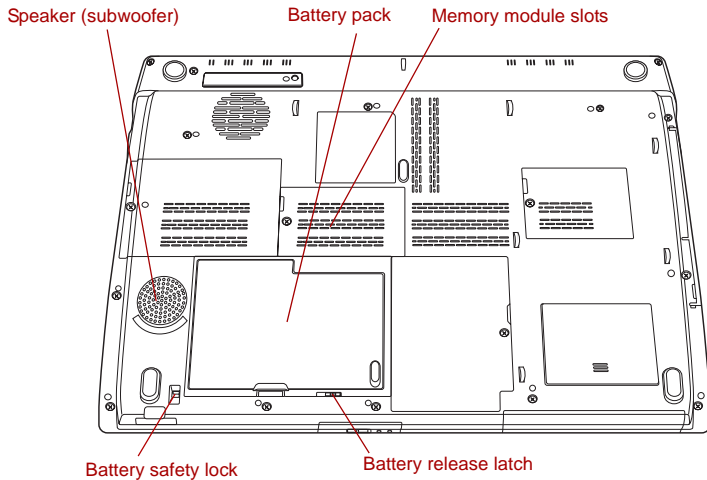

Figure 2-5 The underside of the computer



### Memory module slots

The memory module slots are located here. The memory module slots allow for the installation, replacement and removal of additional memory modules. Please refer to the [Additional memory module](#) section in Chapter 9, [Optional Devices](#), for more information.



### Battery safety lock

Slide this latch into its “Unlock” position in order to release the battery pack ready for removal.



### Battery release latch

Slide and hold this latch into its “Unlock” position in order to release the battery pack ready for removal.

For more detailed information on removing the battery pack please refer to Chapter 6, [Power](#).

### Battery pack

The battery pack provides power to the computer when the AC adaptor is not connected. For more detailed information on the use and operation of the battery pack please refer to Chapter 6, [Power](#).



### Speaker (subwoofer)

The subwoofer will reproduce of the low frequency sounds generated.

## Front with the display open

This section shows the computer with the display panel open. In order to open the display, lift the display panel up and position it at a comfortable viewing angle.

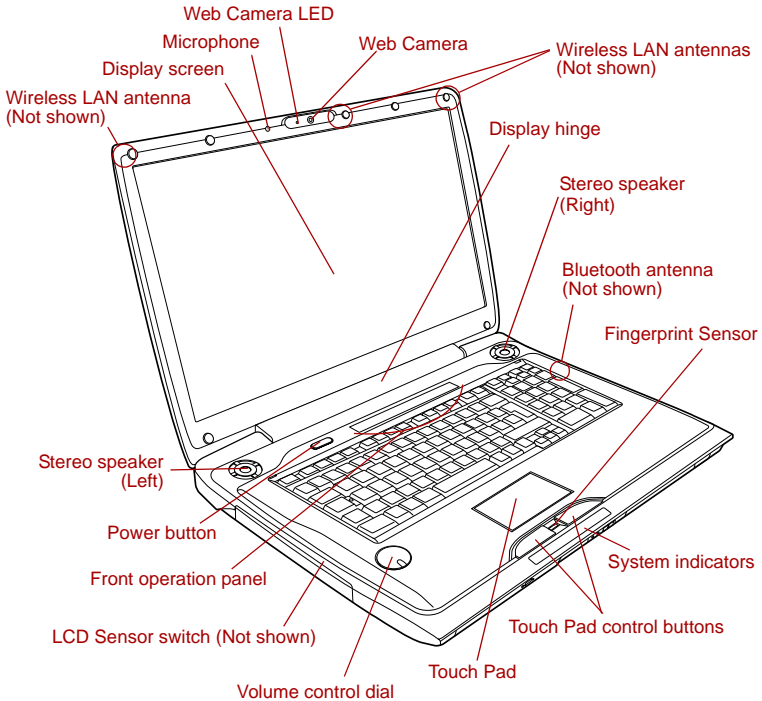

Figure 2-6 The front of the computer with the display open

---

**System indicators** These LED indicators allow you to monitor the status of various computer functions and are described in more detail within the [System indicators](#) section.

---

**Display hinge** The display hinge allows the display panel to be position at a variety of easy-to-view angles.

---

harman / kardon **Stereo speakers** The speakers emit sound generated by your software as well as audio alarms, such as low battery condition, generated by the system.

---



*Keep foreign objects out of the speakers. Never allow metal objects, such as screws, staples and paper clips, to enter the computer or keyboard. Foreign metal objects can create a short circuit, which can cause computer damage and fire, possibly resulting in serious injury.*





---

<b>Display screen</b>	Please be aware that, when the computer is operating on the AC adaptor, the image displayed on the internal screen will be somewhat brighter than when it operates on battery power. This difference in brightness levels is intended to save power when operating on batteries. For more information on the computer's display, please refer to the <a href="#">Display Controller and Video mode</a> section in Appendix B.
<b>Front operation panel (nine buttons)</b>	Nine buttons are available for use: CD/DVD, Play/Pause, Stop, Previous, Next, Mute, Illumination On/Off, Camera, DOLBY. These buttons allow you to manage Audio/Video, run applications and access utilities. Refer to Chapter 8, <a href="#">AV functions</a> , for details.
<b>Power button</b>	Press this button to turn the computer's power on and off.
<b>Touch Pad</b>	The Touch Pad located in the center of the palm rest is used to control the movement of the on-screen pointer. For more information, please refer to the <a href="#">Using the Touch Pad</a> section in Chapter 4, <a href="#">Operating Basics</a> .
<b>Touch Pad control buttons</b>	The control buttons located below the Touch Pad allow you to select menu items or manipulate text and graphics as designated by the on-screen pointer.
<b>Fingerprint Sensor</b>	This sensor enables you to enroll and recognize a fingerprint. Some models are equipped with a Fingerprint Sensor. For detailed information on Fingerprint Sensor, refer to Chapter 4, <a href="#">Using the Fingerprint Sensor (optional)</a> .

---

## Web Camera

**Web Camera**

**Web Camera** is a device that allows you to record video or take photographs with your computer. You can use it for video chatting or video conferences using a communication tool such as **Windows Live Messenger**. **Camera Assistant Software** will help you to add various video effects to your video or photograph.

Enables the transmission of video and use of video chat via the internet using specialized applications.

The effective pixel count for this web camera is 1.31 million (maximum photograph size: 1280x1024 pixels).

Please refer to the [Web Camera](#) section in Chapter 4, [Operating Basics](#).

**Web Camera LED**

The Web Camera LED will glow when the Web Camera is operating.

**LCD Sensor switch**

This switch senses when the display panel is either closed or opened and activates the Panel Power Off/On feature as appropriate. For example, when you close the display the computer enters Hibernation Mode and shuts itself down. When you next open the display, the computer will automatically start up and return you to the application you were previously working on.

You can specify within the Power Options. To access it, click **Start -> Control Panel -> System and Maintenance -> Power Options**.



*Do not put any magnetic objects close to this switch as they may cause the computer to automatically enter Hibernation Mode and shut down even if the Panel Power Off feature is disabled.*

**Volume control dial**

Use this dial to adjust the volume of the internal stereo speakers and optional external stereo headphones (if connected).

Turn the dial clockwise to increase the volume and turn it counter-clockwise to decrease the volume.

**Microphone**

A built-in microphone allows you to import and record sounds for your application - please refer to the [Sound system](#) section in Chapter 4, [Operating Basics](#), for more information.

<b>Bluetooth antenna</b>	Some computers in this series are equipped with a Bluetooth antenna.
<b>Wireless LAN antennas</b>	Some computers in this series are equipped with the Wireless LAN antennas.

## System indicators

The LED system indicators for specific computer operations glow when those operations are in progress.



Figure 2-7 System indicators



### DC IN

The **DC IN** indicator normally glows white when power is being correctly supplied from the AC power adaptor. However, if the output voltage from the adaptor is abnormal, or if the computer's power supply malfunctions, this indicator will flash orange.



### Power

The **Power** indicator normally glows white when the computer is turned on. However, if you turn the computer off into Sleep Mode, this indicator will flash orange - approximately one second on, two seconds off - both while the system is shutting down and while it remains turned off.



### Battery

The **Battery** indicator shows the condition of the battery's charge - white indicates the battery is fully charged, orange indicates the battery is charging, and flashing orange indicates a low battery condition. Please refer to Chapter 6, [Power](#), for more information on this feature.



### Hard Disk Drive

The **Hard Disk Drive** indicator glows white whenever the computer is accessing the built-in hard disk drive, optical disc drive or eSATA device.



### Bridge media slot

The **Bridge media slot** indicator glows white when the computer is accessing the Bridge media slot.

## Keyboard indicators

The following figures show the positions of the **CAPS LOCK** indicator and the **NUMLOCK** indicators which show the following conditions:

- When the **CAPS LOCK** indicator glows, the keyboard will produce capitals when any letter is typed.
- When the **NUMLOCK** indicator glows, the ten key allows you to enter numbers.

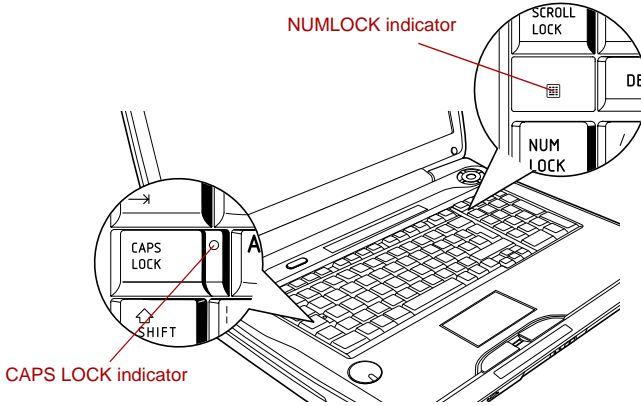

Figure 2-8 Keypad indicators

---

### **CAPS LOCK**

This indicator glows green when letter keys are locked into their uppercase format.

---

### **NUMLOCK**

When the **NUMLOCK** indicator glows, the ten key allows you to enter numbers.

---



## Optical disc drives

The computer is configured with a DVD Super Multi (+-R DL) drive. An ATAPI interface controller is used for CD/DVD-ROM operation. When the computer is accessing a CD/DVD, an indicator on the drive glows.

For further information on loading and unloading discs, please refer to the [Using optical disc drives](#) section in Chapter 4, [Operating Basics](#).

### Region codes for DVD drives and media

DVD Super Multi drives and their associated media are manufactured according to the specifications of six marketing regions. When you purchase DVD-Video, make sure it matches your drive, otherwise it will not play properly.

Code	Region
1	Canada, United States
2	Japan, Europe, South Africa, Middle East
3	South East Asia, East Asia
4	Australia, New Zealand, Pacific Islands, Central America, South America, Caribbean
5	Russia, Indian Subcontinent, Africa, North Korea, Mongolia
6	China

### Writable discs

This section describes the types of writable CD/DVD discs. Check the specifications of your drive to see the types of discs it can write. Use TOSHIBA Disc Creator to write compact discs. Please refer to Chapter 4, [Operating Basics](#), for further information.

#### CDs

- CD-R discs can be written only once. The recorded data cannot be erased or changed.
- CD-RW discs including multi speed CD-RW discs, high-speed CD-RW discs and ultra-speed CD-RW discs can be recorded more than once.

#### DVDs

- DVD-R, DVD+R, DVD-R (Dual Layer) and DVD+R (Double Layer) discs can be written only once. The recorded data cannot be erased or changed.
- DVD-RW, DVD+RW and DVD-RAM discs can be recorded more than once.

## Formats

The DVD Super Multi (+-R DL) drive supports the following formats: CD-ROM, DVD-ROM, DVD-Video, CD-DA, CD-Text, Photo CD (single/multi-session), CD-ROM Mode 1, Mode 2, CD-ROM XA Mode 2 (Form1, Form2), Enhanced CD (CD-EXTRA), Addressing Method 2, CD-R, CD-RW, DVD-R, DVD-R DL, DVD-RW, DVD+R, DVD+R DL, DVD+RW and DVD-RAM.



*Some types and formats of DVD-R (Dual Layer) and DVD+R (Double Layer) discs may be unreadable.*

## DVD Super Multi drive

The full-size DVD Super Multi (+-R DL) drive module lets you record data to rewritable CD/DVDs as well as run either 12 cm (4.72") or 8cm (3.15") CD/DVDs without using an adaptor.



*The read speed is slower at the center of a disc and faster at the outer edge.*

<b>DVD read</b>	8 speed (maximum)
<b>DVD-R write</b>	8 speed (maximum)
<b>DVD-R DL write</b>	6 speed (maximum)
<b>DVD-RW write</b>	6 speed (maximum)
<b>DVD+R write</b>	8 speed (maximum)
<b>DVD+R DL write</b>	6 speed (maximum)
<b>DVD+RW write</b>	8 speed (maximum)
<b>DVD-RAM write</b>	5 speed (maximum)
<b>CD read</b>	24 speed (maximum)
<b>CD-R write</b>	24 speed (maximum)
<b>CD-RW write</b>	24 speed (maximum, Ultra-speed media)

## AC adaptor

The AC adaptor can automatically adjust to any voltage ranging from 100 to 240 volts and to a frequency of either 50 or 60 hertz, enabling you to use this computer in almost all country/region. The adaptor converts AC power to DC power and reduces the voltage supplied to this computer.

To recharge the battery, simply connect the AC adaptor to a power source and to the computer. Please refer to Chapter 6, [Power](#), for further information.

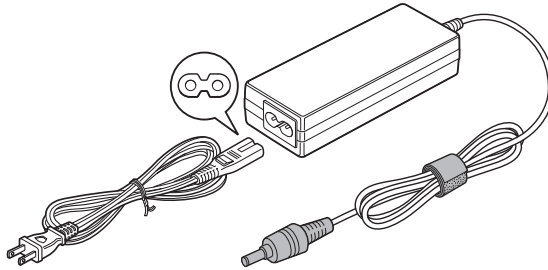

Figure 2-9 The AC adaptor (2-pin plug)

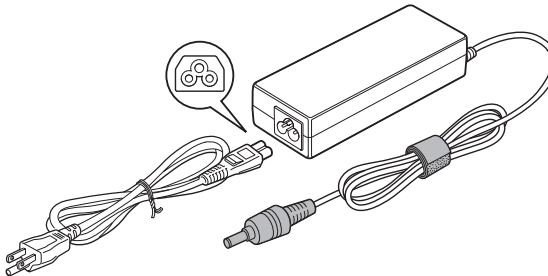

Figure 2-10 The AC adaptor (3-pin plug)



- Depending on the model in question, either a 2-pin or 3-pin adaptor/power lead will be bundled with the computer.
- Do not use a 3-pin to 2-pin conversion plug.
- The supplied power cord conforms to safety rules and regulations in the region the product is bought and should not be used outside of this region. In order to use the adaptor/computer in other regions, you should please buy a power cord that conforms to the safety rules and regulations in that particular region.



Always use the TOSHIBA AC adaptor that was included with your computer, or use AC adaptors specified by TOSHIBA to avoid any risk of fire or other damage to the computer. Use of an incompatible AC adaptor could cause fire or damage to the computer possibly resulting in serious injury. TOSHIBA assumes no liability for any damage caused by use of an incompatible adaptor.





# Chapter 3

## Getting Started

This chapter provides basic information to start using your computer. It covers the following topics:



- All users should be sure to read the section [Starting up for the first time](#).
- Be sure to read the enclosed *Instruction Manual for Safety and Comfort* for information on the safe and proper use of this computer. It is intended to help you be more comfortable and productive while using a notebook computer. By following the recommendations in it you may reduce your chance of developing a painful or disabling injury to your hand, arms, shoulders or neck.

- Connecting the AC adaptor
- Opening the display
- Turning on the power
- Starting up for the first time
- Turning off the power
- Restarting the computer
- System Recovery Options
- Restoring the pre-installed Software



- Use a virus-check program and make sure it is updated regularly.
- Never format storage media without checking its content - formatting destroys all stored data.
- It is a good idea to periodically back up the internal hard disk drive or other main storage device to external media. General storage media is not durable or stable over long periods of time and under certain conditions may result in data loss.
- Before you install a device or application, save any data in memory to the hard disk drive or other storage media. Failure to do so may result in the loss of data.

## Connecting the AC adaptor

Attach the AC adaptor when you need to charge the battery or you want to operate from AC power. It is also the fastest way to get started, because the battery pack will need to be charged before you can operate from battery power.

The AC adaptor can be connected to any power source supplying from 100 to 240 volts and 50 or 60 hertz. For details on using the AC adaptor to charge the battery pack, refer to Chapter 6, [Power](#).



- *Always use the TOSHIBA AC adaptor that was included with your computer or use AC adaptors specified by TOSHIBA to avoid any risk of fire or other damage to the computer. Use of an incompatible AC adaptor could cause fire or damage to the computer possibly resulting in serious injury. TOSHIBA assumes no liability for any damage caused by use of an incompatible adaptor.*
- *Never plug the AC adaptor into a power source that does not correspond to both the voltage and the frequency specified on the regulatory label of the unit. Failure to do so could result in a fire or electric shock, possibly resulting in serious injury.*
- *Always use or purchase power cables that comply with the legal voltage and frequency specifications and requirements in the country of use. Failure to do so could result in a fire or electric shock, possibly resulting in serious injury.*
- *The supplied power cord conforms to safety rules and regulations in the region the product is bought and should not be used outside this region. For use in other regions, please buy power cords that conform to safety rules and regulations in the particular region.*
- *Do not use a 3-pin to 2-pin conversion plug.*
- *When you connect the AC adaptor to the computer, always follow the steps in the exact order as described in the User's Manual. Connecting the power cable to a live electrical outlet should be the last step otherwise the adaptor DC output plug could hold an electrical charge and cause an electrical shock or minor bodily injury when touched. As a general safety precaution, avoid touching any metal parts.*
- *Never place your computer or AC adaptor on a wooden surface, furniture, or any other surface that could be marred by exposure to heat since the computer base and AC adaptor's surface increase in temperature during normal use.*
- *Always place your computer or AC adaptor on a flat and hard surface that is resistant to heat damage.*

*Refer to the enclosed Instruction Manual for Safety and Comfort for detailed precautions and handling instructions.*

1. Connect the power cord to the AC adaptor.

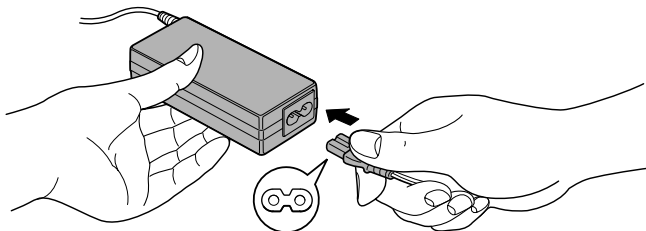

*Figure 3-1 Connecting the power cord to the AC adaptor (2-pin plug)*

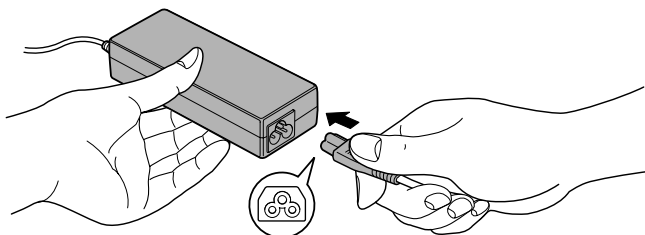
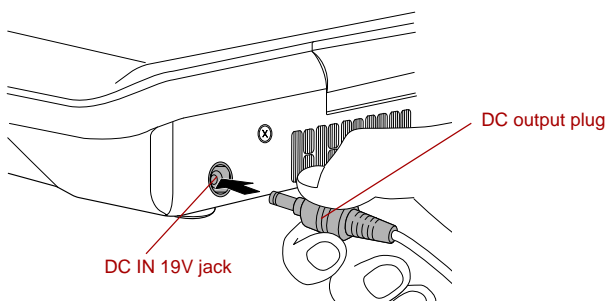

*Figure 3-2 Connecting the power cord to the AC adaptor (3-pin plug)*



*Either a 2-pin or 3-pin adaptor/cord will be included with the computer depending on the model.*

2. Connect the AC adaptor's DC output plug to the DC IN 19V jack on the back of the computer.



*Figure 3-3 Connecting the DC output plug to the computer*

3. Plug the power cord into a live wall outlet - the **Battery** and **DC IN** indicators on the front of the computer should glow.

## Opening the display

The display panel can be opened to a wide range of angles for optimal viewing.

While holding down the palm rest with one hand so that the main body of the computer is not raised, slowly lift the display panel - this will allow the angle of the display panel to be adjusted to provide optimum clarity.

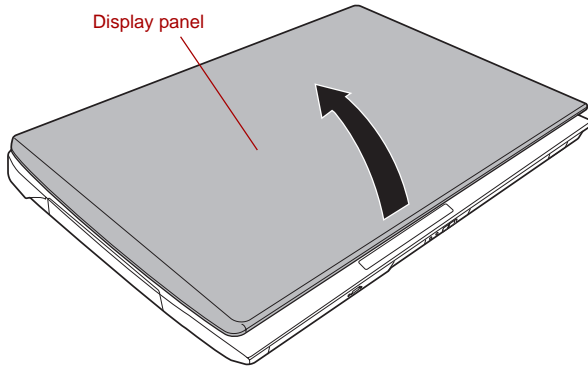

Figure 3-4 Opening the display



*Use reasonable care when opening and closing the display panel. Opening it vigorously or slamming it shut could damage the computer.*



- *As the display panel cannot be opened until 180 degrees, please be careful of the angle when flipping open the display panel.*
- *Be careful not to open the display panel too far as this could put stress on the display panel's hinges and cause damage.*
- *Do not press or push on the display panel.*
- *Do not lift the computer by the display panel.*
- *Do not close the display panel with pens or any other objects left in between the display panel and the keyboard.*
- *When opening or closing the display panel, place one hand on the palm rest to hold the computer in place and use the other hand to slowly open or close the display panel (Do not use excessive force when opening or closing the display panel).*

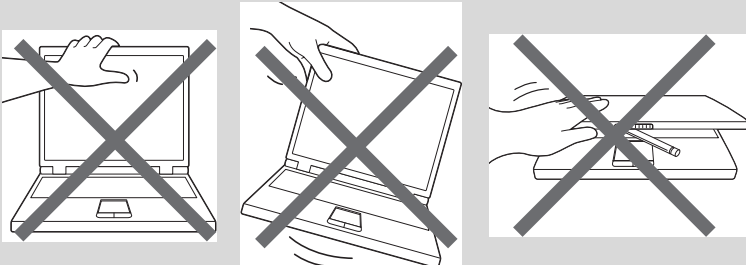

## Turning on the power

This section describes how to turn on the power - the **Power** indicator will then indicate the status. Please refer to the [Monitoring of power condition](#) section in Chapter 6, [Power](#), for more information.



- *After you turn on the power for the first time, do not turn it off until you have set up the operating system. Please refer to the section [Starting up for the first time](#) for more information.*
- *Volume cannot be adjusted during Windows Setup.*

1. Open the display panel.
2. Press and hold the computer's power button for two or three seconds.

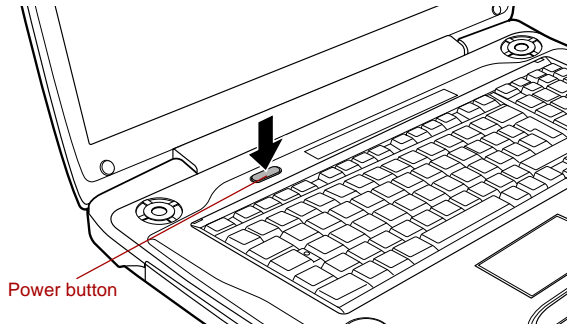

Figure 3-5 Turning on the power

## Starting up for the first time

The Microsoft Windows Vista Startup Screen will be the first screen displayed when you turn on the power. Follow the on-screen instructions on each screen in order to properly install the operating system.



- *When it is displayed, be sure to read the **Software License Terms** carefully.*

## Turning off the power

The power can be turned off in one of three modes, either Shut Down Mode, Sleep Mode or Hibernation Mode.



### Shut Down Mode

When you turn off the power in Shut Down Mode no data will be saved and the computer will boot to the operating system's main screen the next time it is turned on.

1. If you have entered data, either save it to the hard disk drive or to other storage media.
2. Make sure all disk/disc activity has stopped before removing the CD/DVD or floppy diskette.



- *Make sure the **Hard Disk Drive** indicator is off. If you turn off the power while a disk (disc) is being accessed, you may lose data or damage the disk.*
- *Never turn off the power while an application is running. Doing so could cause loss of data.*
- *Never turn off the power, disconnect an external storage device or remove storage media during data read/write. Doing so can cause data loss.*

3. Click **Start**.
4. Click the arrow button (  ) located in the power management buttons (  ) and select **Shut Down** from the menu.
5. Turn off any peripheral devices connected to your computer.



*Do not turn the computer or peripheral devices back on immediately - wait a short period to avoid any potential damage.*

### Sleep Mode

If you have to interrupt your work, you are able to turn off the power without exiting from your software by placing the computer into Sleep Mode. In this mode data is maintained in the computer's main memory so that when you turn on the power again, you can continue working right where you left off.



*When you have to turn off your computer aboard an aircraft or in places where electronic devices are regulated or controlled, always completely shut down the computer. This includes turning off any wireless communication switches or devices, and canceling settings that reactivate the computer automatically, such as a timer recording function. Failure to completely shut down the computer in this way could allow the operating system to reactivate and run pre-programmed tasks or preserve unsaved data, which could interfere with aviation or other systems, possibly causing serious injury.*



- Before entering Sleep Mode, be sure to save your data.
- Do not install or remove a memory module while the computer is in Sleep Mode. The computer or the memory module could be damaged.
- Do not remove the battery pack while the computer is in Sleep Mode (unless the computer is connected to an AC power source). Data in memory could be lost.



- When the AC adaptor is connected, the computer will go into Sleep Mode according to the settings in the Power Options (to access it, **Start** -> **Control Panel** -> **System and Maintenance** -> **Power Options**).
- To restore the operation of the computer from Sleep Mode, press and hold the power button or any key on the keyboard for a short amount of time. Please note that keyboard keys can only be used if the Wake-up on Keyboard option is enabled within the HW Setup utility.
- If the computer enters Sleep Mode while a network application is active, the application might not be restored when the computer is next turned on and the system returns from Sleep Mode.
- To prevent the computer from automatically entering Sleep Mode, disable Sleep Mode within the Power Options (to access it, **Start** -> **Control Panel** -> **System and Maintenance** -> **Power Options**).
- To use the Hybrid Sleep function, configure it in the Power Options.

### **Benefits of Sleep Mode**

The Sleep Mode feature provides the following benefits:



- Restores the previous working environment more rapidly than does the Hibernation Mode feature.
- Saves power by shutting down the system when the computer receives no input or hardware access for the time period set by the System Sleep Mode feature.
- Allows the use of the panel power off feature.

### **Executing Sleep Mode**



You can also enable Sleep Mode by pressing **FN + F3** - please refer to Chapter 5, [The Keyboard](#), for further details.

You can enter Sleep Mode in one of four ways:

- Click **Start** then click the power button (  ) located in the power management buttons (  ).  
Please note that this feature must be enabled within the Power Options (to access it, click **Start** -> **Control Panel** -> **System and Maintenance** -> **Power Options**).
- Click **Start** then click the arrow button (  ) and select **sleep** from the menu.

- Close the display panel. Please note that this feature must be enabled within the Power Options (to access it, click **Start -> Control Panel -> System and Maintenance -> Power Options**).
- Press the power button. Please note that this feature must be enabled within the Power Options (to access it, click **Start -> Control Panel -> System and Maintenance -> Power Options**).

When you turn the power back on, you can continue where you left when you shut down the computer.



- *When the computer is in Sleep Mode, the **Power** indicator will blink orange.*
- *If you are operating the computer on battery power, you can lengthen the overall operating time by turning it off into Hibernation Mode - Sleep Mode will consume more power while the computer is off.*

### **Sleep Mode limitations**

Sleep Mode will not function under the following conditions:

- Power is turned back on immediately after shutting down.
- Memory circuits are exposed to static electricity or electrical noise.

### **Hibernation Mode**

The Hibernation Mode feature saves the contents of memory to the hard disk drive when the computer is turned off so that, the next time it is turned on, the previous state is restored. Please note that the Hibernation Mode feature does not save the status of any peripheral devices connected to the computer.



- *Save your data. While entering Hibernation Mode, the computer saves the contents of memory to the hard disk drive. However, for safety sake, it is best to save your data manually.*
- *Data will be lost if you remove the battery or disconnect the AC adaptor before the save is completed. Wait for the **Hard Disk Drive** indicator to go out.*
- *Do not install or remove a memory module while the computer is in Hibernation Mode. Data will be lost.*

### **Benefits of Hibernation Mode**

The Hibernation Mode feature provides the following benefits:

- Saves data to the hard disk drive when the computer automatically shuts down because of a low battery condition.
- You can return to your previous working environment immediately when you turn on the computer.
- Saves power by shutting down the system when the computer receives no input or hardware access for the time period set by the System Hibernate feature.
- Allows the use of the panel power off feature.





## Starting Hibernation Mode



You can also enable Hibernation Mode by pressing **FN + F4** - please refer to Chapter 5, [The Keyboard](#), for further details.

To enter Hibernation Mode, follow the steps below.

1. Click **Start**.
2. Click the arrow button (  ) in the power management buttons (  ) and select **Hibernate** from the menu.

## Automatic Hibernation Mode

The computer can be configured to enter Hibernation Mode automatically when you press the power button or close the lid. In order to define these settings, you can follow the steps as described below:

1. Click **Start** and click the **Control Panel**.
2. Click **System and Maintenance** and click **Power Options**.
3. Click **Choose what the power buttons do** or **Choose what closing the lid does**.
4. Enable the desired Hibernation Mode settings for **When I press the power button** and **When I close the lid**.
5. Click the **Save changes** button.

## Data save in Hibernation Mode

When you turn off the power in Hibernation Mode, the computer will take a moment to save the current data in memory to the hard disk drive. During this time, the **Hard Disk Drive** indicator will glow.

After you turn off the computer, and the content of memory has been saved to the hard disk drive, turn off the power to any peripheral devices.





*Do not turn the computer or devices back on immediately. Wait a moment to let all capacitors fully discharge.*

## Restarting the computer

Certain conditions require that you reset the computer, for example if:

- You change certain computer settings.
- An error occurs and the computer does not respond to your keyboard commands.

If you need to restart the computer, there are three ways this can be achieved:

- Click **Start** then click the arrow button (  ) in the power management buttons (  ) and select **Restart** from the menu.
- Press **CTRL**, **ALT** and **DEL** simultaneously (once) to display the menu window, then select **Restart** from the **Shut down options**.
- Press the power button and hold it down for five seconds. Once the computer has turned itself off, wait between ten and fifteen seconds before turning the power on again by pressing the power button.

## System Recovery Options

A hidden partition of approximately 1.5 GB is allocated on the hard disk drive for the System Recovery Options. This partition stores files which can be used to repair the system in the event of a problem.



*The System Recovery Options feature will be unusable if this partition is deleted.*

### System Recovery Options

The System Recovery Options feature is installed on the hard disk when shipped from the factory. The System Recovery Options menu includes tools to repair startup problems, run diagnostics or restore the system.

You can see the more information about **Startup Repair** in **Windows Help and Support** content.

The System Recovery Options can also be run manually to repair problems.

1. Turn off the computer.
2. While holding the **F8** key, turn the computer on again.
3. The **Advanced Boot Options** menu will be displayed. Use the arrow keys to select **Repair Your Computer** and press **ENTER**.
4. Follow the on-screen instructions from this point onward.



*The Window Vista Complete PC Backup feature can be used on Windows Vista™ Business Edition and Ultimate Edition.*

## Restoring the pre-installed Software

Depending on the model you purchased, different ways for restoring the pre-installed software are offered:

- Creating optical Recovery Discs
- Restoring the pre-installed software from your created Recovery Discs.
- Restoring the pre-installed software from the Recovery hard disk drive

### Creating Optical Recovery Discs

This section describes how to create Recovery Discs.



- *Be sure to connect the AC adaptor when you create Recovery Discs.*
- *Be sure to close all other software programs except the Recovery Disc Creator.*
- *Do not run software such as screen savers which can put a heavy load on the CPU.*
- *Operate the computer at full power.*
- *Do not use power-saving features.*
- *Do not write to the disc when the virus check software is running. Wait for it to finish, then disable virus detection programs including any software that checks files automatically in the background.*
- *Do not use utilities, including those intended to enhance hard disk drive access speed. They may cause unstable operation and damage data.*
- *Do not shut down/log off or Sleep/Hibernate while writing or rewriting the disc.*
- *Set the computer on a level surface and avoid places subjected to vibrations such as airplanes, trains or cars.*
- *Do not place your computer on unstable tables or any other unstable surfaces.*

A recovery image of the software on your computer is stored on the hard disk drive, and can be copied to DVD media by using the following steps:

1. Have blank DVD media ready.
2. The application will allow you to choose from a variety of different media onto which the recovery image can be copied including DVD-R, DVD-RW, DVD+R, DVD+RW.



*Please note that some of the above media may not be compatible with the optical disc drive installed into your computer. You should therefore verify the optical disc drive supports the blank media you have chosen before proceeding.*

3. Turn on your computer and allow it to load the Windows Vista® operating system from the hard disk drive as normal.
4. Insert the first blank media into the optical disc drive tray.
5. Double click the **Recovery Disc Creator** icon on the Windows Vista® desktop, or select the application from **Start Menu**.

6. After Recovery Disc Creator starts, select the type of media and the title you wish to copy, and then click the **Create** button.
7. Follow the on-screen instructions.  
Your Recovery Discs will be created.

## Restoring the pre-installed software from your created Recovery Discs



*Please set your BIOS to default before you recover your computer to the factory state!*

If the pre-installed files are damaged, you are able to use the Recovery Discs you have created to restore the computer to the state it was in when you originally received it. To perform this restoration, follow the steps below:



*When the sound mute feature has been activated by pressing the **FN + ESC** key, be sure to disable this to allow sounds to be heard before starting the restore process. Please refer to Chapter 5, [The Keyboard](#), for further details.*



*When you reinstall the Windows operating system, the hard disk will be reformatted and all data will be lost.*

1. Load the Recovery Discs into the optical disc drive and turn off the computer's power.
2. While holding down **F12** key on the keyboard, turn on your computer - when the **TOSHIBA** logo screen appears, release the **F12** key.
3. Use the cursors key to select the CD-ROM icon from the menu. Please refer to the [Boot Priority](#) section in Chapter 7, [HW Setup](#), for further information.
4. A menu will be displayed from which you should follow the on-screen instructions.

## Restoring the pre-installed software from the Recovery hard disk drive



*Please set your BIOS to default before you recover your computer to the factory state!*

On your Data drive you may find a folder "HDDRecovery". This folder stores files which can be used to recover your system to the originally installed factory state.

If you subsequently set up your hard disk drive again, do not change, delete or add partitions in a manner other than specified in the manual, otherwise you may find that space for the required software is not available.

In addition, if you use a third-party partitioning program to reconfigure the partitions on your hard disk drive, you may find that it becomes impossible to setup your computer.



*When the sound mute feature has been activated by pressing the **FN + ESC** key, be sure to disable this to allow sounds to be heard before starting the restore process. Please refer to Chapter 5, [The Keyboard](#), for further details.*



*Be sure to connect the AC adaptor, otherwise you may run out of battery during the recovery process.*

*When you reinstall the Windows operating system, the hard disk will be reformatted and all data will be lost.*

1. Turn off the computer.
2. Turn on the computer and when the TOSHIBA screen appears repeatedly press the **F8** key.
3. The **Advanced Boot Options** menu will be displayed. Use the arrow keys to select **Repair Your Computer** and press **ENTER**.
4. Select your preferred keyboard layout and press **Next**.
5. To access the recovery process please log on as an enabled user with sufficient rights.
6. Click TOSHIBA HDD Recovery on the System Recovery Options screen.
7. Follow the on-screen instructions on the TOSHIBA HDD Recovery dialog.

The computer will be restored to its factory state.



# Chapter 4

## Operating Basics

This chapter describes the basic operations of your computer, highlights the precautions that should be taken when using it.

### Using the Touch Pad

To use the Touch Pad, simply touch and move your fingertip across it in the direction you want the on-screen pointer to go.

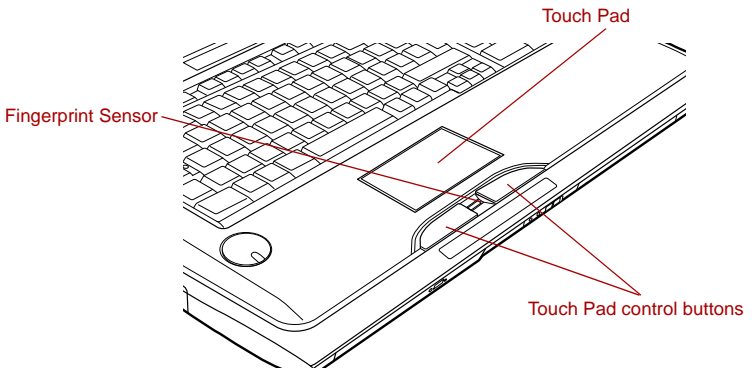

Figure 4-1 Touch Pad and Touch Pad control buttons

The two buttons below the Touch Pad are used like the buttons on a standard mouse - press the left button to select a menu item or to manipulate text or graphics designated by the pointer, and press the right button to display a menu or other function depending on the software you are using.



*You can also tap the Touch Pad to perform functions similar to those of the left button on a standard mouse.*

**Click:** Tap once

**Double-click:** Tap twice

**Drag and drop:** Tap to select the item(s) you want to move, leave your finger on the Touch Pad after the second tap and then move the item(s) to their new destination.

## AV Controller

The following functions are available in this computer for operating the Media Center.

This section describes an overview of each function. Please refer to the Chapter 8, *AV functions*, for more information.

- Front operation panel
- Remote controller

### Front operation panel

The Front operation panel is located above the keyboard.

AV related functions, such as CD/DVD, Play/Pause, Stop, Previous, Next, Mute, Illumination On/Off, Camera and DOLBY are available.

### Remote controller

It can operate AV related functions. Some models are provided with a remote controller.

## Using the Fingerprint Sensor (optional)

Some models have a fingerprint utility installed for the purpose of enrolling and recognizing fingerprints. By enrolling the ID and password onto the fingerprint authentication feature, it is no longer necessary to input the password from the keyboard. Fingerprint feature enables you to:

- Logon to Windows and access a security enabled homepage through Internet Explorer.
- Files and folders can be encrypted/decrypted and third party access to them prevented.
- Disable the password-protected screen-saver when returning from a power-saving mode such as Sleep Mode.
- Authentication of the User Password (and, if applicable, the HDD(Hard Disk Drive) Password) when booting up the computer (Pre-OS Authentication).
- Single-Swipe Sign On feature



*Fingerprint cannot be used in models that do not have a fingerprint module installed.*



## How to Swipe your Finger

Using the following steps when swiping fingers for fingerprint registration or authentication will help to minimize authentication failures:

Align the first joint of the finger to the center of the sensor. Lightly touch the sensor and swipe finger levelly towards you until the sensor surface becomes visible. In performing this process, you should also take care to ensure that the center of your fingerprint is on the sensor.

The following illustrations show the recommended way to swipe your finger over the fingerprint sensor.

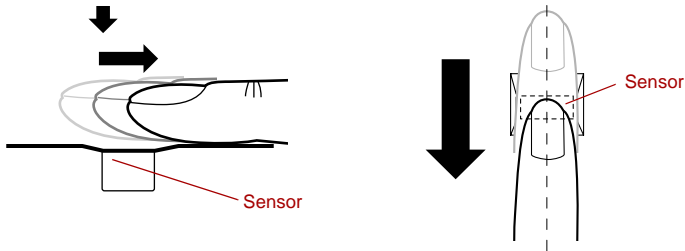

Figure 4-2 Swipe the finger



- *Avoid swiping with your finger stiff or pressed too hard onto the sensor, and take care to ensure that the center of the fingerprint is touching the sensor before swiping. Either of these conditions may cause fingerprint reading to fail.*
- *Check the center of the fingerprint whorl before swiping and then ensure this is swiped along the center line of the sensor.*
- *There is a possibility of authentication failures if the finger is swiped too quickly or too slowly - follow any on-screen instructions to adjust the speed used during the swipe process.*

## Points to note about the Fingerprint Sensor

Please be aware of the following considerations when using the fingerprint sensor. A failure to follow these guidelines might result in damage to the sensor, sensor failure, fingerprint recognition problems or a lower fingerprint recognition success rate.

- Do not scratch or poke the sensor with your nails or any hard or sharp objects.
- Do not press the sensor strongly.
- Do not touch the sensor with a wet finger or any wet objects - keep the sensor surface dry and free from water vapor.
- Do not touch the sensor with a soiled or dirty finger as minute foreign particles of dust and dirt may scratch it.
- Do not paste stickers or write on the sensor.
- Do not touch the sensor with a finger or any other object which may have a build-up of static electricity on it.

Observe the following before you place your finger on the sensor whether for fingerprint enrollment/registration or recognition.

- Wash and dry your hands thoroughly.
- Remove static electricity from your fingers by touching any metal surface. Static electricity is a common cause of sensor failures, especially when the weather is dry.
- Clean the sensor with a lint-free cloth - do not use detergent or any other chemicals to clean the sensor.
- Avoid the following finger conditions for enrollment or recognition as they may result in fingerprint enrollment errors or a drop in the fingerprint recognition success rate
  - Soaked or swollen finger, for example as may occur after taking a bath.
  - Injured finger
  - Wet finger
  - Soiled or oily finger
  - Extremely dry skin condition on finger

Observe the following to improve the fingerprint recognition success rate.

- Enroll two or more fingers.
- Enroll additional fingers if a recognition failure often occurs when using already enrolled fingers.
- Check the condition of your finger - any conditions which have changed since enrollment, such as injury, rough skin, and extremely dry, wet, soiled, dirty, oily, soaked or swollen fingers, may lower the recognition success rate. Also if the fingerprint is worn down or the finger becomes thinner or fatter, the recognition success rate may be lowered.
- As the fingerprint for each finger is different and unique you should ensure that only the registered or enrolled fingerprint or fingerprints are used for identification.
- Check the position and speed at which you swipe your finger across the sensor - please refer to the preceding drawing.
- The fingerprint sensor compares and analyzes the unique characteristics in a fingerprint. However, there may be instances where certain users are unable to register their fingerprints due to insufficient unique characteristics in their fingerprints.
- The recognition success rate may differ from user to user.

## Setup Procedure

Please use the following procedure when first using fingerprint authentication.

### Fingerprint Registration

You should initially enroll the required authentication data using the **Fingerprint Enrollment Wizard**.



- *In use, the fingerprint authentication system will use the same username and password as defined within the Windows operating system. If no Windows password has been configured, you must do this before starting the fingerprint registration process.*
- *This sensor has the memory space for at least twenty-one fingerprint patterns. You might be able to register more fingerprint patterns depending on the sensor memory usage.*

1. To run this program, click **Start -> All Programs -> TrueSuite Access Manager -> TrueSuite Access Manager**.



*You are also able to start the Fingerprint Enrollment Wizard by using the following methods.*

- *Click the Fingerprint Application icon in the Taskbar.*

2. The **Verify** screen will be displayed, enter the Windows logon password and click the **Next** button.
3. On the **User's Fingers** screen click the box above the finger you wish to register.  
If any of the previously enrolled fingerprints is selected again, the latest information will be enrolled and any previous information over-written.
4. The **Fingerprint Enrollment** screen will be displayed and the tutorial will begin. First click "Replay video" and confirm the proper movement for the finger you wish to register. Then confirm the message displayed on this screen and ensure that there is a check mark in the **Run Interactive Tutorial** box. Once this has been done, click **Next**.
5. At the **Scanning Practice** screen, you are able to practice swiping (three times) your finger to ensure you use the correct method. Click "Try again" to if you wish to practice again. You have finished practicing, click **Next** button.
6. Register your fingerprint on the **Fingerprint Image Capture** screen.  
Let the computer read the finger to be registered 3 times. An image of your fingerprint will be shown on the screen each time the fingerprint is successfully read.  
Once the fingerprint is successfully read for the third time, the message **Successfully combined** will be displayed beneath the fingerprint images. Click the **Next** button.
7. When the **Store To Sensor** screen is displayed, check **Store fingerprint to Sensor**. Click **Finish** to complete fingerprint registration.



*It is strongly recommended that you register 2 or more fingerprints. Repeat the procedure from step 3 to register another fingerprint.*

### **How to Delete the Fingerprint Data**

Saved fingerprint data is stored in special non-volatile memory inside the fingerprint sensor. Therefore, if you give the computer to someone else, or dispose of it in any way, the following process is recommended to delete your fingerprint information:

1. To run this program, click **Start -> All Programs -> TrueSuite Access Manager -> TrueSuite Access Manager**.
2. The **Verify** screen will be displayed, so either swipe your registered finger or enter the Windows logon password and click the **Next** button.
3. The **User's Fingers** screen is displayed.
  - To delete all registered fingerprints
    1. Click **Delete All Fingerprints**.
    2. Follow the on-screen instructions to deleted the registered fingerprints.
  - To delete individual fingerprints
    1. Click the fingerprint mark above the registered finger.
    2. Click **Delete All Fingerprints**.
    3. "Are you sure you want to delete this fingerprint?" will be displayed on the screen, click **Yes** button.
  - 4. When **Delete All Fingerprints** is selected, the user selection screen will be displayed, so select which user's fingerprint data to delete.
    - Selecting "Delete current user's fingerprints" will delete the fingerprint data for the currently logged in user.
    - Selecting "Delete all users' fingerprints" will delete the fingerprint data for all users, however this item can only be selected if the currently logged in user has administrator privileges.

5. A message will be displayed asking for confirmation to delete the fingerprint data, click the **Yes** button.  
In use, please be aware of the following limitations of the fingerprint sensor:
  - A warning message will be displayed when recognition is abnormal or recognition is not successful within a fixed duration.
  - The fingerprint sensor compares and analyzes the unique characteristics in a fingerprint. However, there may be instances where certain users are unable to register their fingerprints due to insufficient unique characteristics in their fingerprints.
  - The recognition success rate may differ from user to user.
  - Toshiba does not guarantee that this fingerprint recognition technology will be error-free.
  - Toshiba does not guarantee that the fingerprint sensor will recognize the enrolled user or accurately screen out unauthorized users at all times. Toshiba is not liable for any failure or damage that might arise out of the use of this fingerprint recognition software or utility.

### Points to note about the Fingerprint Utility software



*You are able to backup saved fingerprint data and information within the by using the Import or Export User Data facility under the fingerprint management software. However, please be aware that any encrypted files cannot be backup within File protection using this function - in these instances it is recommended that you backup these files to external media using standard file copy processes.*

The Encrypting File System (EFS) is a Windows Vista feature.

If a file is encrypted using EFS, it cannot be encrypted further using the fingerprint authentication function.

### Windows Logon via Fingerprint Authentication

If required, you are also able to use fingerprint authentication in place of the usual Windows logon process using your username and password.

This method is especially useful where there are many users using the same computer as it removes the need for actual user selection when the system is started.

#### **Fingerprint Authentication Procedure**

1. Start up the computer.
2. At the Windows **Welcome** screen, choose any of the enrolled fingers and swipe the fingerprint on the sensor - if the authentication process is successful, the user will automatically be logged in to Windows.



*If the fingerprint authentication process fails you will need to log into Windows using the appropriate username and password. In addition, you should use this manual login process if fingerprint authentication fails for three consecutive tries - a warning message will be displayed when authentication is not normal or is not successful within a fixed duration.*

## Fingerprint Pre-OS Authentication

### General

The fingerprint authentication system can be used to replace the keyboard based password authentication system that is used when the computer is turned on.

If you do not want to use the fingerprint authentication system for password authentication while booting up the computer, instead you prefer using the keyboard entry method, simply press the **BACK SPACE** key when the Fingerprint Pre-OS Authentication screen is displayed.

Using this process will switch the password input screen across to the keyboard based entry screen.



- *You must ensure that you use the TOSHIBA Password Utility to register a User Password before using the Fingerprint Pre-OS Authentication and its extended function to allow fingerprints to be used to access the computer when it is turned on.*
- *If the fingerprint authentication process fails five times, a preset time limit is exceeded, or you press the **BACK SPACE** key, [Password =] will be displayed on the screen and you will have to enter either the User Password or Supervisor Password manually in order to start the computer.*
- *When swiping your finger, please ensure that you do it slowly and at a constant speed. If you find that this does not improve the authentication rate, you should try to adjust the speed at which the finger is swiped.*
- *If there are any changes in the environment or settings related to authorization, you will be required to provide authorization information such as a User Password (and, if applicable, the HDD(Hard Disk Drive) password).*

### How to Enable Fingerprint Pre-OS Authentication Settings

It is necessary to first enroll your fingerprint with the Fingerprint Application prior to enabling and configuring the Fingerprint Pre-OS Authentication System. You should check that your fingerprint is enrolled before configuring the settings (please refer to the Manual for Fingerprint Registration/Enrollment for further instructions).

1. To run this program, click **Start -> All Programs -> TrueSuite Access Manager -> Fingerprint Application with Admin**.
2. UserAccountControl screen is displayed, click the **Allow** button.

This setting can only be changed if the currently logged in user has administrator privileges.

3. Swipe a registered finger on the fingerprint sensor.
4. Click the **Setting menu** at the TrueSuiteAccessManager screen.
5. Administrator Setting screen is displayed, check the “Enable Pre-OS Fingerprint Authentication” check box and then click **OK**.
6. Click the **Exit** button at the TrueSuiteAccessManager screen.

## Fingerprint Single-Swipe Sign On Feature

### *General*

This is a feature that allows the user to complete the authentication for both the User/BIOS Password (and, if applicable, the HDD(Hard Disk Drive) Password) and logging onto Windows using only one fingerprint authentication when booting up.

It is necessary to register the User/BIOS Password and Windows Logon Password before using the Fingerprint Pre-OS Authentication and this Fingerprint Single-Swipe Sign On Feature. Please use the TOSHIBA Password Utility to register your User/BIOS Password. If Windows Logon is not the default for your system, see Manual to register your Windows Logon Password.

Only one fingerprint authentication is required to replace the User/BIOS Password (and, if applicable, the HDD(Hard Disk Drive) Password) and the Windows Logon Password.

### *How to Enable Fingerprint Single-Swipe Sign On Feature*

It is necessary to first enroll your fingerprint with the Fingerprint application prior to enabling and configuring the Fingerprint Single-Swipe Sign On feature. You should check that your fingerprint is enrolled before configuring the settings (please refer to the Manual for Fingerprint Registration/Enrollment for further instructions).

1. To run this program, click **Start -> All Programs -> TrueSuite Access Manager -> Fingerprint Application with Admin**.
2. UserAccountControl screen is displayed, click the **Allow** button.  
This setting can only be changed if the currently logged in user has administrator privileges.
3. Swipe a registered finger on the fingerprint sensor.
4. Click the **Setting menu** at the TrueSuiteAccessManager screen.
5. Administrator Setting screen is displayed, check the “Enable Single-Sign On Fingerprint Authentication” check box and then click **OK**.
6. Click the **Exit** button at the TrueSuiteAccessManager screen.

### *Fingerprint utility limitations*

TOSHIBA does not guarantee that the fingerprint utility technology will be completely secure or error-free, or that it will accurately screen out unauthorized users at all times. TOSHIBA is not liable for any failure or damage that might arise out of the use of the fingerprint software.



- *The fingerprint sensor compares and analyzes the unique characteristics in a fingerprint. However, there may be instances where certain users are unable to register their fingerprints due to insufficient unique characteristics in their fingerprints.*
- *The recognition success rate may differ from user to user.*

## Web Camera

**Web Camera** is a device that allows you to record video or take photographs with your computer. You can use it for video chatting or video conferences using a communication tool such as **Windows Live Messenger**. **Camera Assistant Software** will help you to add various video effects to your video or photograph.

Enables the transmission of video and use of video chat via the internet using specialized applications.

The effective pixel count for this web camera is 1.31 million (maximum photograph size: 1280x1024 pixels).

Touching the camera button on the Front operation panel will open the Camera Assistant Software and display the Preview window.

Please refer to the Camera Assistant Software Online Help for details.

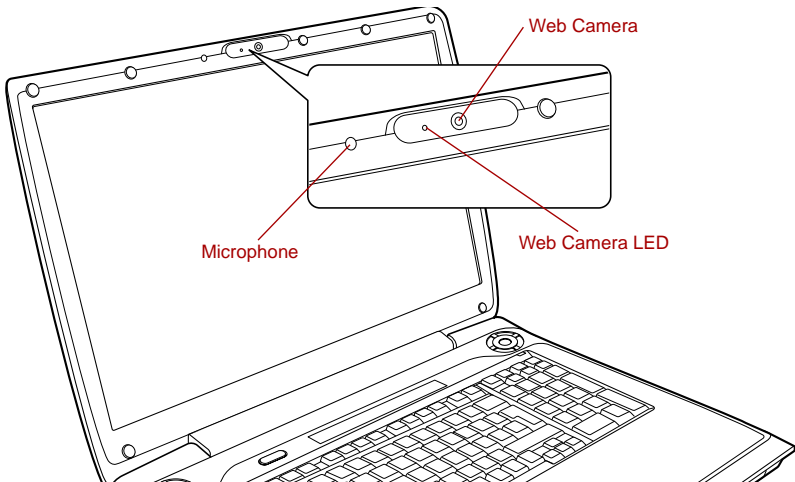

Figure 4-3 Web Camera





- *Do not point the web camera directly at the sun.*
- *Do not touch or press strongly on the web camera lens. Doing so may reduce image quality. Use an eyeglass cleaner (cleaning cloth) or other soft cloth to clean the lens if it becomes dirty.*
- *Setting the [Size] to more than “800x600” will cause a larger amount of data to be written to the hard disk drive and may interfere with smooth recording.*

## Using the TOSHIBA Face Recognition

TOSHIBA Face Recognition uses a face verification library to verify the face data of users when they log in to Windows. The user can thus avoid having to enter a password or the like, which makes the login process easier.



- *TOSHIBA Face Recognition does not guarantee the correct identification of a user. Changes to the likeness of a registrant, such as hair style changes, wearing a cap, or wearing glasses may effect the recognition rates when such changes occur after the registrant had registered.*
- *TOSHIBA Face Recognition may incorrectly recognize faces that are similar to a registrant.*
- *For high security purposes, TOSHIBA Face Recognition is not a suitable substitute for Windows passwords. When security is a high priority, use your established Windows passwords to log in.*
- *Bright background light and/or shadows may prevent a registrant from being recognized correctly. In that case, log in using your Windows password. If recognition of a registrant fails repeatedly, refer to your computer documentation to learn ways to improve recognition performance.*
- *TOSHIBA Face Recognition records face data in a log when face recognition fails. When transferring ownership or disposing of your computer, please uninstall the application or delete all the logs created by the application. For details on how to do this, see help file.*
- *When using the feature “Log Record function” of the Toshiba Face Recognition software please make sure that the usage is in line with applicable legal requirements especially data protection laws in your country of usage as well as with company internal regulations if any.*

### Disclaimer

Toshiba does not guarantee that the face recognition utility technology will be completely secure or error-free. Toshiba does not guarantee that the face recognition utility will accurately screen out unauthorized users at all times. Toshiba is not liable for any failure or damage that might arise out of the use of the face recognition software or utility.

TOSHIBA, ITS AFFILIATES AND SUPPLIERS SHALL HAVE NO RESPONSIBILITY FOR DAMAGE TO OR LOSS OF ANY BUSINESS, PROFITS, PROGRAMS, DATA, NETWORK SYSTEMS OR REMOVABLE STORAGE MEDIA ARISING OUT OF OR RESULTING FROM THE USE OF THE PRODUCT, EVEN IF ADVISED OF THE POSSIBILITY THEREOF.

## How to register the Face Recognition Data

Take a picture for facial verification purposes, and register the data needed when you log in. To register the data needed when you log in, follow the steps as described below:

1. To launch this utility, click **Start -> All Programs -> TOSHIBA -> Utilities -> TOSHIBA Face Recognition**.
  - The **Registration** screen is displayed for a logged-in user whose face has not been registered.
  - The **Management** screen is displayed for a logged-in user whose face has already been registered.
2. If you are a registered user, click the **Register face** button in the **Management** screen, otherwise the **Registration** screen will be displayed.
  - If you wish to practice, click on the **Next** button in the **Registration** screen.
  - If you do not wish to practice, click on the **Skip** button in the **Registration** screen.
3. Click the **Next** button to start the guide.
4. First, take a picture while moving your neck slightly to the left and right.
5. Now take a picture while moving your neck down and up.
  - Click the **Back** button to practice the guide once more.
6. Click the **Next** button to start image-capturing process. Adjust the position of your face so that it fits within the face-shaped frame.
7. Once your face has been positioned properly, the recording will commence. Start moving your neck very slightly to the left and right, and then move your neck down and up.
8. Registration will end after you have repeatedly moved your neck left, right, down and up. When the register succeeds, below message will be displayed on the screen:  
"Registration successful. Now we'll do the verification test. Click the Next button."  
Click the **Next** button to perform the verification test.
9. Perform the verification test. Face the screen as you do when you register.
  - If verification fails, click the **Back** button and re-register. Please refer from step 6 to step 8.

10. If verification is successful, click the **Next** button and register an account.
11. Register the account.  
Fill in the account registration fields.  
Fill in the all fields.
12. The **Management** screen is displayed.  
The registered account name will be displayed. Clicking on it will cause the captured image of your face to be displayed on the left.

## How to Delete the Face Recognition Data

Delete image data, account information, and personal record data created during registration. To delete the Face Recognition Data, follow the steps as described below:

1. To launch this utility, click **Start -> All Programs -> TOSHIBA -> Utilities -> TOSHIBA Face Recognition**.  
The **Management** screen is displayed.
2. Select a user which is deleted in the **Management** screen.
3. Click the **Delete** button. "You are about to delete the user data. Would you like to continue?" will be displayed on the screen.
  - If you do not want the data to be deleted, click the **No** button and you will then be returned to the **Management** screen.
  - Clicking on the **Yes** button will remove the selected user from the **Management** screen.

## How to launch the help file

For further information on this utility, please refer to help file.

1. To launch the help file, click **Start -> All Programs -> TOSHIBA -> Utilities -> TOSHIBA Face Recognition Help**.

## Windows Logon via TOSHIBA Face Recognition

This section explains how to login to Windows with TOSHIBA Face Recognition. Two authentication modes are provided.

- **AUTO Mode Login screen:** If the face authentication tile is selected by default, you can log in without using the keyboard or mouse.
- **1:1 Mode Login screen:** This mode is essentially the same as AUTO mode, but the **Select Account** screen will appear before the **Display Captured Image** screen, and you will need to select the user account to be authenticated in order to start the authentication process.

## AUTO Mode Login screen

1. Turn on the computer.
2. The **Select Tiles** screen will be displayed.

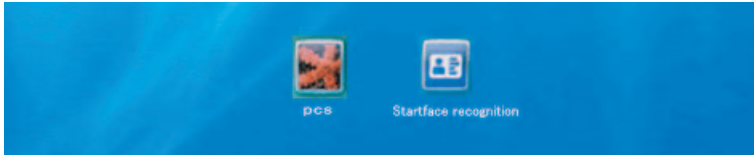



Figure 4-4 Select Tiles screen

3. Select Start face recognition (  ).
4. "Please turn your face to the camera" will be displayed.
5. Verification will be performed. If the authentication is successful, the image data taken in step 4 will be faded in and placed over one another.
  - If an error occurs during authentication, you will be returned to the **Select Tiles** screen.
6. **Windows Welcome** screen will be displayed, and will be logged in automatically to Windows.

## 1:1 Mode Login screen

1. Turn on the computer.
2. The **Select Tiles** screen will be displayed.

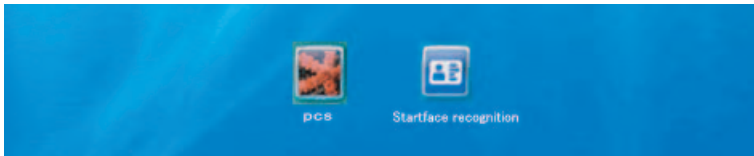



Figure 4-5 Select Tiles screen

3. Select Start face recognition (  ).
4. The **Select Account** screen will be displayed.
5. Select the account, and click the **arrow** button.
6. "Please turn your face to the camera" will be displayed.
7. Verification will be performed. If the authentication is successful, the image data taken in step 6 will be faded in and placed over one another.
  - If an error occurs during authentication, you will be returned to the **Select Tiles** screen.
8. **Windows Welcome** screen will be displayed, and will be logged in automatically to Windows.

## Using optical disc drives

The full-size drive provides high-performance execution of CD/DVD-ROM-based programs. You can run either 12 cm (4.72") or 8 cm (3.15") CD/DVDs without an adaptor. An ATAPI interface controller is used for CD/DVD-ROM operation. When the computer is accessing a CD/DVD-ROM, an indicator on the drive glows.



*Use the DVD playback application to view DVD-Video discs.*

If you have a DVD Super Multi drive, refer also to the [Writing CD/DVDs on DVD Super Multi \(+R DL\) drives](#) section for precautions on writing to CDs/DVDs.

### Loading discs

To load CD/DVDs, follow the steps as detailed below:

1. When the computer's power is on, press the eject button to open the disc tray slightly.

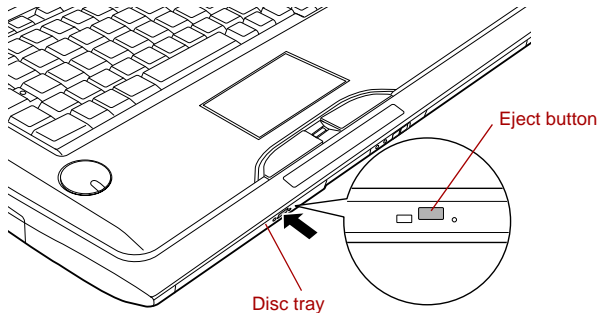

*Figure 4-6 Pressing the eject button*

2. Grasp the disc tray gently and pull until it is fully opened.

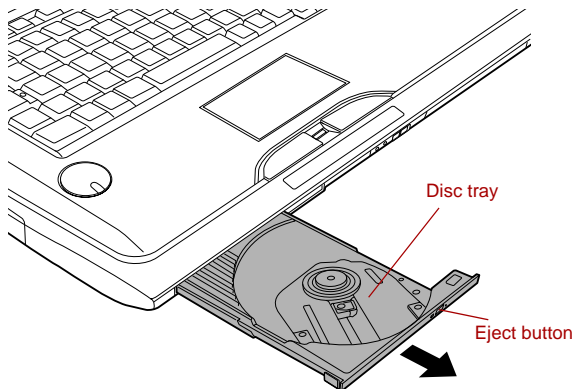

*Figure 4-7 Pulling the disc tray open*

3. Lay the CD/DVD, label side up, in the disc tray.

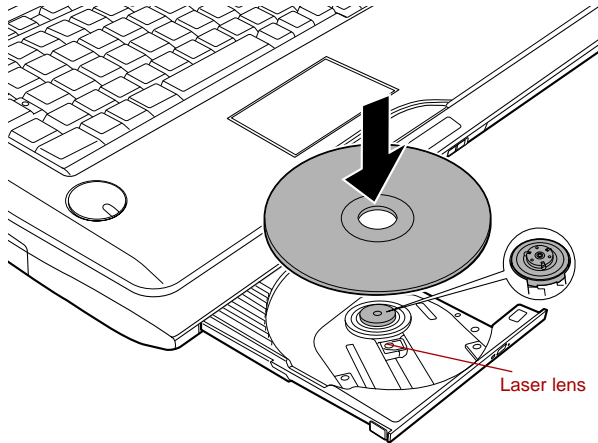

Figure 4-8 Inserting a CD/DVD



*When the disc tray is fully opened, the edge of the computer will extend slightly over the CD/DVD tray. Therefore, you will need to turn the CD/DVD at an angle when you place it in the disc tray. After seating the CD/DVD, however, make sure it lies flat.*



- *Do not touch the laser lens or any portion of its surrounding casing as this could cause misalignment.*
- *Prevent foreign objects from entering the drive. Check the surface of the disc tray, especially the area behind the front edge of the disc tray, to make sure there are no such objects before closing the drive.*

4. Press gently at the center of the CD/DVD until you feel it click into place. The CD/DVD should lie below the top of the spindle, flush with the spindle base.
5. Push the center of the disc tray to close it. Press gently until it locks into place.



*If the CD/DVD is not seated properly when the disc tray is closed, the CD/DVD might be damaged. Also, the disc tray might not open fully when you press the eject button.*

## Removing discs

To remove the CD/DVD, follow the steps as detailed below:



*Do not press the eject button while the computer is accessing the media drive. Wait for the optical disc drive indicator to go out before you open the disc tray. Also, if the CD/DVD is spinning when you open the disc tray, wait for it to stop before you remove it.*

1. To pop the disc tray partially open, press the eject button. Gently pull the disc tray out until it is fully opened.



*When the disc tray pops open slightly, wait a moment to make sure the CD/DVD has stopped spinning before pulling the disc tray fully open.*

2. The CD/DVD extends slightly over the sides of the disc tray so you can grasp it. Gently lift out the CD/DVD.

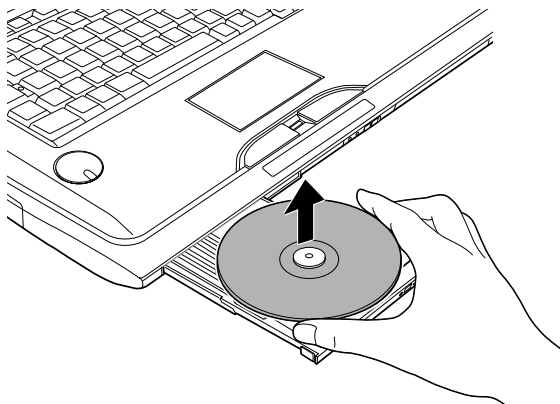

*Figure 4-9 Removing a CD/DVD*

3. Push the center of the disc tray to close it. Press gently until it locks into place.

## How to remove CD/DVD when the disc tray will not open

Pressing the eject button will not open the disc tray when the computer power is off. If the power is off, you can open the disc tray by inserting a slender object (about 15 mm) such as a straightened paper clip into the eject hole near the eject button.

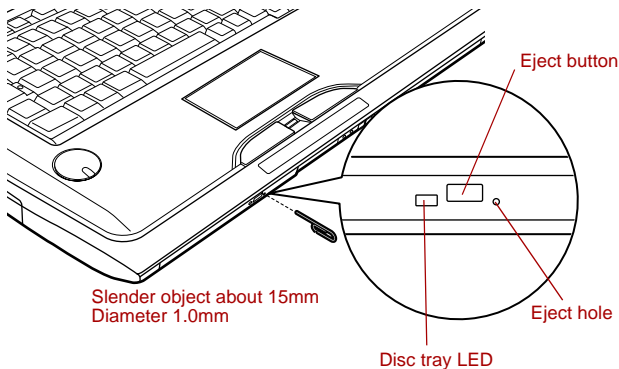

Figure 4-10 Manual release with the eject hole



Turn off the power before you use the eject hole. If the CD/DVD is spinning when you open the disc tray, the CD/DVD could fly off the spindle and cause injury.

## Writing CD/DVDs on DVD Super Multi (+-R DL) drives

You can use the DVD Super Multi (+-R DL) drive to write data to either CD-R, CD-RW, DVD-R, DVD-R (Dual Layer), DVD-RW, DVD+R, DVD+R (Double Layer), DVD+RW or DVD-RAM discs. TOSHIBA Disc Creator and Ulead DVD MovieFactory are provided as writing software with this computer.

Ulead DVD MovieFactory can be used to write files in video format. TOSHIBA Disc Creator can be used to write data.



- Please refer to the [Writable discs](#), Chapter 2 for details about the types of writable CD and DVD discs that can be supported by this computer.
- Do not turn off the power to the optical disc drive while the computer is accessing it as this may cause you to lose data.
- CD-R/RW media cannot be accessed using the **Create CD/DVD** option in Media Center.
- To write data to CD-R/-RW media, use the **TOSHIBA Disc Creator** feature that is installed on your computer.





*When writing information to media using an optical drive, you should always ensure that you connect the AC adaptor to a live power socket. It is possible that, if data is written while powered by the battery pack, the write process may sometimes fail due to low battery power - in these instances data loss may occur.*

## Important message

Before you write or rewrite to any of the media supported by the DVD Super Multi drive, please read and follow all of the setup and operating instructions in this section. If you fail to do so, you may find that the DVD Super Multi drive may not function properly, and you may fail to write or rewrite information successfully - this may cause you to either lose data or incur other damage to the drive or media.

## Disclaimer

TOSHIBA does not bear responsibility for the following:

- Damage to any CD-R, CD-RW, DVD-R, DVD-R (Dual Layer), DVD-RW, DVD+R, DVD+R (Double Layer), DVD+RW or DVD-RAM disc that may be caused by writing or rewriting with this product.
- Any change or loss of the recorded contents of CD-R, CD-RW, DVD-R, DVD-R (Dual Layer), DVD-RW, DVD+R, DVD+R (Double Layer), DVD+RW or DVD-RAM media that may be caused by writing or rewriting with this product, or for any business profit loss or business interruption that may be caused by the change or loss of the recorded contents.
- Damage that may be caused by using third party equipment or software.

Given the technological limitations of current optical disc writing drives, you may experience unexpected writing or rewriting errors due to disc quality or problems with hardware devices. In view of this, it is good practice to make two or more copies of important data, in case of any undesired change or loss of the recorded contents.

## Before writing or rewriting

- Based on TOSHIBA's limited compatibility testing, we suggest the following manufacturers of CD-R, CD-RW, DVD-R, DVD-R (Dual Layer), DVD-RW, DVD+R, DVD+R (Double Layer), DVD+RW or DVD-RAM media, however, it must be noted that disc quality can affect write or rewrite success rates. Please also be aware that in no event does TOSHIBA guarantee the operation, quality or performance of any disc.
- 

### **CD-R:**

TAIYO YUDEN CO., Ltd.  
MITSUBISHI KAGAKU MEDIA CO., LTD.  
Ricoh Co., Ltd.  
Hitachi Maxell, Ltd.

---

### **CD-RW: (Multi-Speed and High-Speed)**

MITSUBISHI KAGAKU MEDIA CO., LTD.  
Ricoh Co., Ltd.

---

### **CD-RW: (Ultra-Speed)**

MITSUBISHI KAGAKU MEDIA CO., LTD.

---

### **DVD-R:**

#### **DVD Specifications for Recordable Disc for General Version 2.0**

TAIYO YUDEN Co., Ltd. (for 8x and 16x speed media)  
MITSUBISHI KAGAKU MEDIA CO., LTD. (for 4x, 8x and 16x speed media)  
Hitachi Maxell, Ltd. (for 8x and 16x speed media)

---

### **DVD-R (Dual Layer):**

MITSUBISHI KAGAKU MEDIA CO., LTD. (for 4x and 8x speed media)

---

### **DVD+R:**

MITSUBISHI KAGAKU MEDIA CO., LTD. (for 8x and 16x speed media)  
Ricoh Co., Ltd. (for 8x and 16x speed media)  
TAIYO YUDEN CO., Ltd. (for 8x and 16x speed media)

---

### **DVD+R (Double Layer):**

MITSUBISHI KAGAKU MEDIA CO., LTD. (for 2.4x and 8x speed media)

---

### **DVD-RW:**

#### **DVD Specifications for Recordable Disc for Version 1.1 or version 1.2**

Victor Company of Japan, Ltd. (JVC) (for 2x, 4x and 6x speed media)  
MITSUBISHI KAGAKU MEDIA CO., LTD. (for 2x, 4x and 6x speed media)

---

**DVD+RW:**

Ricoh Co., Ltd. (for 2.4x, 4x and 8x speed media)  
 MITSUBISHI KAGAKU MEDIA CO., LTD. (for 2.4x, 4x and 8x speed media)

**DVD-RAM:****DVD Specifications for DVD-RAM Disc for Version 2.0, Version 2.1 or Version 2.2**

Matsushita Electric Industrial Co.,Ltd. (for 3x and 5x speed media)  
 Hitachi Maxell, Ltd. (for 3x and 5x speed media)



- *DVD Super Multi drive cannot use discs that allow writing faster than 16x speed (DVD-R and DVD+R media), 8x speed (DVD-R (Dual Layer), DVD+RW and DVD+R (Double Layer) media), 6x speed (DVD-RW media), 5x speed (DVD-RAM media).*
- *Some types and formats of DVD-R (Dual Layer) and DVD+R (Double Layer) discs may be unreadable.*
- *2.6GB and 5.2GB DVD-RAM media cannot be read from or written to.*
- *DISC created in DVD-R (Dual Layer) format4 (Layer Jump Recording) cannot be read.*
- If the disc is poor in quality, or is dirty or damaged, writing or rewriting errors may be noted - ensure that you check all discs for dirt or damage before you use them.
- The actual number of rewrites to CD-RW, DVD-RW, DVD+RW or DVD-RAM media will be affected by the quality of the disc itself and the way in which it is used.
- There are two types of DVD-R media available, authoring discs and general use discs. Do not attempt to use authoring discs as only general use discs can be written to by a computer drive.
- You can use both DVD-RAM discs that can be removed from a cartridge and DVD-RAM discs designed without a cartridge.
- You may find that other computer DVD-ROM drives or other DVD players may not be able to read DVD-R, DVD-R (Dual Layer), DVD-RW, DVD+R, DVD+R (Double Layer) or DVD+RW discs.
- Data written to a CD-R, DVD-R, DVD-R (Dual Layer), DVD+R or DVD+R (Double Layer) discs cannot be deleted either in whole or in part.
- Data deleted/erased from a CD-RW, DVD-RW, DVD+RW or DVD-RAM disc cannot be recovered. You must check the content of the disc carefully before you delete it, taking care that, if multiple drives that can write data to discs are connected, you do not delete data from the wrong one.
- In writing to DVD-R, DVD-R (Dual Layer), DVD-RW, DVD+R, DVD+R (Double Layer), DVD+RW or DVD-RAM media, some space is required for file management, so you may not be able to write to the full capacity of the disc.

- Since the disc is based on the DVD standard, it might be filled with dummy data if the written data is less than about 1GB. Therefore, in these circumstance, even if you write only a small amount of data, it might take additional time to fill in the dummy data.
- When multiple drives that can write data to discs are connected, be sure that you do not write to or delete data from the wrong drive.
- Be sure to connect the AC adaptor to the computer before you write or rewrite any information.
- Before you enter either Sleep Mode or Hibernation Mode, take care to ensure that any DVD-RAM writing has been completed. In this instance, writing is finished if you can eject the DVD-RAM media.
- Be sure to close all other software programs except for the writing software itself.
- Do not run software such as a screen saver which can put a heavy load on the processor.
- Operate the computer at its full power settings - do not use any power-saving features.
- Do not write information while virus checking software is running, instead wait for it to finish, then disable the virus protection applications, including any software that checks files automatically in the background.
- Do not use any hard disk utilities, including those that are intended to enhance hard disk drive access speeds, as they may cause unstable operation and damage data.
- CD-RW (Ultra Speed +) media should not be used as data may be lost or damaged.
- You should always write from the computer's hard disk drive onto the CD/DVD - do not try to write from shared devices such as a server or any other network device.
- Writing with software other than TOSHIBA Disc Creator has not been confirmed, therefore operation with other software applications cannot be guaranteed.

## When writing or rewriting

Please observe the following points while you write or rewrite data to CD-R, CD-RW, DVD-R, DVD-R (Dual Layer), DVD-RW, DVD+R, DVD+R (Double Layer), DVD+RW or DVD-RAM media:

- Always copy data from the hard disk drive to the optical media - do not use the cut-and-paste function as the original data will be lost if there is a write error.
- Do not perform any of the following actions:
  - Change users in the Windows Vista operating system.
  - Operate the computer for any other function, including such tasks as using a mouse or Touch Pad, or closing/opening the display panel.
  - Start a communication application such as a modem.
  - Apply impact or vibration to the computer.
  - Install, remove or connect external devices, including such items as a SD/SDHC memory card, miniSD/microSD Card, ExpressCard, Memory Stick/Memory Stick Duo/Memory Stick PRO/Memory Stick PRO Duo, xD picture card, MultiMediaCard, USB device, external monitor, i.LINK device, or an optical digital device.
  - Use the audio/video control button to reproduce music or voice.
  - Open the optical disc drive.
- Do not use shut down, log off, Sleep Mode or Hibernation Mode functions while writing or rewriting.
- Make sure that the write/rewrite operation is completed before going into either Sleep Mode or Hibernation Mode (writing is completed if you can remove an optical media on the DVD Super Multi drive).
- If the media is of poor quality, or is dirty or damaged, writing or rewriting errors may occur.
- Set the computer on a level surface and avoid places subject to vibration such as airplanes, trains or cars. In addition, do not use the computer on an unstable surface such as a stand.
- Keep mobile phones and other wireless communication devices away from the computer.

## TOSHIBA Disc Creator

Please be aware of the following limitations when you use the TOSHIBA Disc Creator:

- DVD Video cannot be created using TOSHIBA Disc Creator.
- DVD Audio cannot be created using TOSHIBA Disc Creator.
- You cannot use TOSHIBA Disc Creator's "Audio CD for Car or Home CD Player" function to record music to DVD-R, DVD-R (Dual Layer), DVD-RW, DVD+R, DVD+R (Double Layer) or DVD+RW media.
- Do not use the "Disc Backup" function of TOSHIBA Disc Creator in order to copy DVD Video or DVD-ROM material that has copyright protection.

- DVD-RAM discs cannot be backed up using the “Disc Backup” function of TOSHIBA Disc Creator.
- You cannot back up CD-ROM, CD-R or CD-RW media to DVD-R, DVD-R (Dual Layer) or DVD-RW media using the “Disc Backup” function of TOSHIBA Disc Creator.
- You cannot back up CD-ROM, CD-R or CD-RW media to DVD+R, DVD+R (Double Layer) or DVD+RW media using the “Disc Backup” function of TOSHIBA Disc Creator.
- You cannot back up DVD-ROM, DVD Video, DVD-R, DVD-R (Dual Layer), DVD-RW, DVD+R, DVD+R (Double Layer) or DVD+RW to CD-R or CD-RW media using the “Disc Backup” function of TOSHIBA Disc Creator.
- TOSHIBA Disc Creator cannot record in packet format.
- You might not be able to use the “Disc Backup” function of TOSHIBA Disc Creator to back up a DVD-R, DVD-R (Dual Layer), DVD-RW, DVD+R, DVD+R (Double Layer) or DVD+RW disc that was made with other software on a different optical media recorder.
- If you add data to a DVD-R, DVD-R (Dual Layer), DVD+R or DVD+R (Double Layer) disc that you have already recorded to, you might not be able to read the added data under some circumstances. For example, it cannot be read under 16-bit operating systems, such as Windows 98SE and Windows Me, while in Windows NT4 you will need Service Pack 6 or later, and in Windows 2000, you will need Service Pack 2. In addition to this, some DVD-ROM and DVD-ROM / CD-R/RW drives cannot read this added data regardless of the operating system.
- TOSHIBA Disc Creator does not support recording to DVD-RAM discs - to achieve this you should use Windows Explorer or another similar utility.
- When you back up a DVD disc, be sure that the source drive supports recording to DVD-R, DVD-R (Dual Layer), DVD-RW, DVD+R, DVD+R (Double Layer) or DVD+RW media - if this is not the case then the source disc might not be backed up correctly.
- When you back up a DVD-R, DVD-R (Dual Layer), DVD-RW, DVD+R, DVD+R (Double Layer) or DVD+RW disc, be sure to use the same type of disc.
- You cannot partially delete any data written to a CD-RW, DVD-RW or DVD+RW disc.

## Data Verification

To verify that data has been written or rewritten correctly to a data CD/DVD you should follow the steps below before you begin the write/rewrite process:

1. Display the setting dialog box by one of the following two steps:
  - Click the **Recording settings** button (  ) for writing on the main toolbar in the **Data Disc** mode.
  - Select **Settings for Each Mode** -> **Data Disc** in the **Setting** menu.
2. Mark the **Verify written data** check box.
3. Select **File Open** or **Full Compare** mode.
4. Click the **OK** button.

## How to learn more about TOSHIBA Disc Creator

Please refer to the Help files for additional TOSHIBA Disc Creator information.

- Opening the TOSHIBA Disc Creator Manual  
**Start** -> **All Programs** -> **TOSHIBA** -> **CD&DVD Applications** -> **Disc Creator Help**

## When Using Ulead DVD MovieFactory for TOSHIBA

### How to make a DVD-Video

There are two ways to create DVD-Video.

Method 1: Simplified steps for making a DVD-Video from video data captured from a DV-Camcorder:

1. Click **Start** -> **All Programs** -> **DVD MovieFactory for TOSHIBA** -> **Ulead DVD MovieFactory for TOSHIBA Launcher** to launch DVD MovieFactory.
2. Insert a DVD-RW or DVD+RW disc in Burner.
3. Click **Video Disc** -> **Burn Video to Disc** to launch **Direct Recording** dialog box, choose **DVD-Video/+VR** to invoke **Straight Capture to Disc** Page.
4. Choose **DVD-Video** format.
5. Choose the capture source is **DV**.
6. Press **Capture** button.

Method 2: Simplified steps for making a DVD-Video from adding video source:

1. Click **Start** -> **All Programs** -> **DVD MovieFactory for TOSHIBA** -> **Ulead DVD MovieFactory for TOSHIBA Launcher** to launch DVD MovieFactory.
2. Click **Video Disc** -> **New Project** to invoke 2nd Launcher, choose your project type, then invoke DVD MovieFactory.
3. Add source from HD Disk by click **Add Video files** button to invoke browser dialog box.

4. Choose the source video then go to Next page to apply Menu.
5. After choose the menu template, press **Next** button to go to **Burning Page**.
6. Choose the output type then press **Burn** button.

### ***How to learn more about Ulead DVD MovieFactory***

Please refer to the Help and Manual files for additional Ulead DVD MovieFactory information.

- Opening the Ulead DVD MovieFactory Manual

**Start -> All Programs -> DVD MovieFactory for TOSHIBA -> User Manual -> DVD MovieFactory User Manual**

### ***Important information for use***

Note the following limitations when you write Video DVD:

1. Editing digital video
  - Log in with Administrator rights to use DVD MovieFactory.
  - Make sure that your computer is running on AC power when using DVD MovieFactory.
  - Operate the computer at Full Power. Do not use power-saving features.
  - While you are editing DVD, you can display preview. However, if another application is running. The preview might not display properly.
  - DVD MovieFactory cannot edit or play copy protected content.
  - Do not enter Sleep or Hibernation Mode while using DVD MovieFactory.
  - Do not operate DVD MovieFactory immediately after turning on the computer. Please wait until all Disc Drive activity has stopped.
  - When recording to a DV-Camcorder, to ensure you capture all of your data, let the camcorder record for a few seconds before you begin recording your actual data.
  - CD recorder, DVD-Audio, mini DVD and Video CD functions are not supported in this version.
  - While recording video to DVD, please close all other programs.
  - Do not run software like a screen saver because it can put a heavy load on the CPU.
  - Do not support mp3 decode and encode.



2. Before recording the video to DVD
  - When you record DVD disc, please use only discs recommended by the Drive manufacturer.
  - Do not set the working drive to a slow device like a USB1.1 hard disk drive or it will fail to write DVD.
  - Do not perform any of the following actions:
    - Operate the computer for any other function, including using a mouse or Touch Pad, or closing/opening the display panel.
    - Bump or cause vibration to the computer.
    - Use the Mode control button and Audio/Video control button to reproduce music or voice.
    - Open the DVD drive.
    - Install, remove or connect external devices, including the following: SD/SDHC memory card, USB device, external display, i.LINK devices, optical digital devices.
  - Please verify your disc after recording important data.
  - DVD-R/+R/+RW disc cannot be written in VR format.
  - Not support to output VCD and SVCD format.
3. About Straight to Disc
  - Not support to record on DVD-R/+R disc
  - Not support to record DVD+VR format by HDV
  - HDV support to burn DVD-Video only
  - DVD-VR format not support to add Menu
4. About recorded DVDs
  - Some DVD-ROM drives for personal computers or other DVD players may not be able to read DVD-R/+R/-RW/-RAM discs.
  - If you use an over-used rewritable disc, the full formatting might be locked. Please use a brand new disc.

## Media care

This section provides tips on protecting data stored on your CD's, DVD's and floppy diskettes. Handle your media with care. Following the simple precautions listed below will increase the lifetime of your media and protect the data stored on it.

### CD/DVDs

1. Store your CD's and DVD's in the containers they originally came in to protect them and keep them clean.
2. Do not bend the CD's or DVD's.
3. Do not write on, apply a sticker to, or otherwise mar the surface of the CD or DVD that contains the data.

4. Hold the CD or DVD by its outside edge or the edge on the center hole - any fingerprints on the surface of the disc can prevent the drive from properly reading data.
5. Do not expose the CD or DVD to direct sunlight, extreme heat or cold.
6. Do not place heavy objects on your CD's or DVD's.
7. If your CD's or DVD's become dusty or dirty, wipe them with a clean dry cloth from the center hole outwards - do not wipe in a circular direction. If necessary, you can use a cloth that has been lightly dampened in water or a neutral cleaner but you must not use benzine, thinner or any similar cleaning solution.

## Floppy diskettes



*The USB floppy diskette drive is available only as an option.*

1. Store your floppy diskettes in the container they came in to protect them and keep them clean. If a floppy diskette becomes dirty, clean it with a soft, lightly dampened cloth - do not use cleaning fluid.
2. Never open the shutter or touch the magnetic surface of your floppy diskette - doing this could permanently damage it and lose data.
3. Always handle floppy diskettes with care to prevent the loss of stored data.
4. Always apply the floppy diskette label in the correct location and never apply a new label on top of an existing one - in this instance the label could come loose and damage the floppy diskette drive.
5. Never use a pencil for writing on a floppy diskette label as the dust from the pencil lead could cause a system malfunction if it found its way onto the computer's components. In this instance, always use a felt-tipped pen and write the label first before applying it to the floppy diskette.
6. Never put a floppy diskette in a location where water or other liquid may make contact with it, or where it is excessively damp - either of these conditions could cause data loss.
7. Never use a wet or damp floppy diskette - this could damage the floppy diskette drive or other devices within the computer.
8. Data may be lost if the floppy diskette is twisted, bent, or exposed to direct sunlight, extreme heat or cold.
9. Do not place heavy objects on your floppy diskettes.
10. Do not eat, smoke, or use items such as erasers near your floppy diskettes as foreign particles inside the jacket of the floppy diskette can damage the magnetic surface.
11. Magnetic energy can destroy the data on your floppy diskettes. In view of this you should keep your floppy diskettes away from speakers, radios, televisions and other sources of magnetic fields.

## TV Tuner (optional)

Use the My TV feature of Windows Media Center to watch TV programs or record them.

The dimensions and shape of the TV antenna port vary for different regions.

Some models are equipped with a TV tuner.



- *Some computer models are equipped with a tuner capable of receiving digital broadcasts. These tuners can receive DVB-T digital broadcasts. Digital broadcasts cannot be received in regions where DVB-T digital broadcasts are not available.*
- *Simultaneous reception and recording cannot be used when an external video device is connected and the above settings are made.*
- *Simultaneous reception and recording cannot be used when the set-top box is connected and the above settings are made.*
- *According to the government regulations, it is not permitted to bring PAL/SECAM TV tuners into Korea.*

### Using the TV Tuner

#### **Antenna**

- The quality of sounds and pictures greatly depends on the radio propagation conditions.
- When you use your computer in areas where the radio waves are weak, which results in poor radio receiving conditions, contact the dealer you purchased it from, or use a commercially available antenna booster. Please refer to the manual provided with the booster for details.

## Connecting the Cable

This section describes how to connect the coaxial cable to your computer.

### Connecting the coaxial cable



*When lightning occurs, do not touch the antenna line. This may cause an electric shock.*



*If you have to operate your computer during a thunderstorm and are connecting the TV tuner to an outside antenna, you should operate your computer using AC power mode. The AC adaptor offers some protection against (but does not entirely prevent) possible electric shock caused by lightning. For complete protection, do not operate your computer during a thunderstorm.*

1. Save data, shutdown Windows and turn off the power.
2. Connect the coaxial cable to the TV antenna port of your computer.

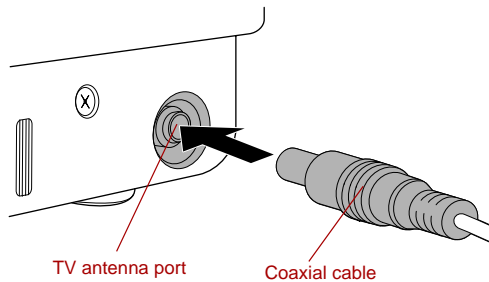

*Figure 4-11 Connecting the coaxial cable*



*When you have been using a descrambler to receive the programs on cable TV or satellite broadcasting, connect the set-top box and splitter to the coaxial cable.*

## Sound system

This section describes some of the audio control functions.

### Adjusting System Volume

You can control the overall level of sound using Windows **Volume Mixer**.

To launch Volume Mixer, follow the steps below.

1. Locate the **Speaker** icon on the task tray.
2. Right-click the **Speaker** icon on the task tray.
3. Select **Open Volume Mixer** from the menu.

Click the **Device** button to display available playback devices. Select **Speakers** to use the internal speakers for listening. Adjust speaker volume by moving the slider up or down to raise or lower the volume. Click the

**Mute** button  to mute the sound.

You may see another control under **Applications** in **Volume Mixer**. It is the control for an application which is currently running. The **Windows Sounds** is always displayed since it controls the system sounds' volume.

### Changing System Sounds

System sounds are assigned to inform you when certain events happen. This section explains how select an existing scheme or save one you have modified.

To launch the configuration dialog window for system sounds, follow the steps below.

1. Right-click the **Speaker** icon on the task tray.
2. Select **Sounds** from the menu.

### Realtek HD Audio Manager

You can confirm and change the audio configuration using the **Realtek Audio Manager**. To launch the **Realtek Audio Manager**, click **Start -> Control Panel -> Hardware and Sound -> Realtek HD Audio Manager**.

When you first launch the Realtek Audio Manager, you will see following device tabs. **Speakers** is the default output device. **Microphone** is the default input device. To change the default device, click the **Set Default Device** button under the chosen device tab.

- **Speakers** is the default output device. Select it when using the internal speakers or headphones.
- **Digital Output** should be selected when connecting the optical cable to the Headphone, S/PDIF and Line out jack for playing digital sound on digital audio equipment.

If external headphones or an audio cable are connected to the Headphone, S/PDIF and Line out jack, the Realtek HD Audio Manager Connector Settings dialog will be displayed allowing selection of either "Headphone" or "Line Out" output.

Digital Output can only be used by connecting an optical audio cable.

- **HDMI Output** should be selected when connecting the HDMI cable to the HDMI jack for playing digital sound on digital audio equipment.
- **Microphone** is the default input device. It should be selected when using the computer's internal microphone or an external microphone connected to the Microphone and Line in jack to record sound.

If an external microphone or audio cable is connected to the Microphone and Line in jack, the Realtek HD Audio Manager Connector Settings dialog will be displayed allowing selection of either "Line In" or "Mic In" input.

### **Information**

Click the **information button**  to view hardware information, software information, and language setting.

### **Power Management**

The audio controller in your computer can be turned off when the audio function is not used. To adjust the configuration of audio power

management, click the **battery button** .

- When audio power management is enabled, the circle button at the upper left of the Power Management is blue and convex.
- When audio power management is disabled, the button is black and concave.

### **Speaker Configuration**

Click the **playback button**  to confirm the internal speakers or the headphone sound is coming from the right direction.

### **Sound Effects**

This section explains how to select various sound effects.

- **Environment** - simulates reverberations of sound for familiar environments around us. You can select an existing preset in the menu.
- **Equalizer** - raises or lowers a frequency of sound to simulate a popular genre of music. You can select an existing preset in the menu.
- **Karaoke** - cancels the specific frequency of sound and results in the **Vocal Cancellation**. Clicking the **Karaoke** icon, lowers the vocal sound within music. Using the arrow buttons will adjust the musical key of the sound.

### **Microphone Effects**

**Microphone Effects** are only found within **Microphone** window.

- **Noise Suppression** reduces background noise and fan noise.
- **Acoustic Echo Cancellation** reduces feedback and feedback echo.

### **Default Format**

You can change the sample rate and bit depth of sound.

## Dolby Sound Room®

Dolby Sound Room provides stunning personal surround sound from any pair of speakers or headphones. Ideal when using surround sound speakers is not practical, Dolby Sound Room enables an enveloping entertainment experience.

Dolby Sound Room technologies:

- **Dolby Headphone** - Personal surround sound using any set of headphones so that listeners feel like the action is happening all around them.
- **Sound Space Expander** - Widens the sound experience to “wrap” around the listener.
- **Natural Bass** - Extends the bass response of any speakers by up to an octave.

To open the user interface of Dolby Sound Room, steps as detailed below:

1. Click the right button of a mouse on the speaker icon on the Windows Taskbar, and select **Playback Devices** in the sub menu.
2. On the **Playback** tab, select **Speakers**, and click **Properties**.
3. Click the **Dolby** tab.

## Modem

This section describes how to connect and disconnect the internal modem to and from a telephone jack.



- *Connection to any communication line other than an analog phone line could cause a computer system failure.*
  - *Connect the built-in modem only to ordinary analog phone lines.*
  - *Never connect the built-in modem to a digital line (ISDN).*
  - *Never connect the built-in modem to the digital connector on a public telephone or to a digital private branch exchange (PBX).*
  - *Never connect the built-in modem to a key telephone system for residences or offices.*
- *Avoid using your computer modem with the telephone cable connected during an electrical storm. There may be a remote risk of electric shock from lightning.*



- *Modem functions cannot be used in models which are not equipped with a modem.*
- *This information is applicable to the models equipped with a built-in modem.*
- *Some models are equipped with a modem jack or FM antenna port.*

## Region selection

Telecommunication regulations vary from one region to another, so you will need to make sure the internal modem's settings are correct for the region in which it will be used.



*The built-in modem can be used only in specified countries and regions. Using the modem in an area not specified for use may cause a system failure. Check the specified areas carefully before using it.*

To select a region, follow the steps as detailed below:

1. Click **Start -> All Programs -> TOSHIBA -> Networking -> Modem Region Select.**



*If it is available, do not use the Country/Region Select function included as part of the modem setup utility within the Control Panel - if you change the country/region setting this way you may find that the change does not take effect.*

2. The Region Selection icon will appear in the Windows Taskbar.
3. Click the icon with the primary (left) mouse button to display a list of regions that the modem supports, together with a sub-menu which details telephony location information - a check mark will appear next to the currently selected region and telephony location.
4. Select either a region from the region menu or a telephony location from the sub-menu.
  - When you click a region it becomes the modem's default selection for any new dialling locations that are created within the Windows Control Panel (Phone and Modem Options).
  - When you select a telephony location, the corresponding region is automatically selected and becomes the modem's default setting.

## Properties menu

Click the icon with the secondary (right) mouse button in order to display a Properties menu on the screen.



## Setting

Within the Properties menu you are able to either enable or disable the following settings:

### ***AutoRun Mode***

Allows you to configure whether the Modem Region Select utility starts automatically whenever you start up the operating system.

### ***Open the Dialing Properties dialog box after selecting region.***

Allows you to configure whether the dialing properties dialog box will be displayed automatically after you have selected a region.

### ***Location list for region selection.***

Displays a sub-menu appears which details location information.

### ***Open dialog box, if the modem and Telephony Current Location region code do not match.***

Displays a warning if the current settings for both region code and telephony location are different.

## Modem Selection

If the computer cannot recognize the internal modem, a dialog box is displayed from which you should select the appropriate communications port for your modem to use.

## Dialing Properties

You should select this item in order to display the dialing properties.



*If you are using the computer in Japan, the Telecommunications Business Law requires that you select Japan region mode. It is illegal to use the modem in Japan with any other selection.*

## Connecting the modular cable

To connect the modem's modular cable, follow the steps as detailed below:



- *Connection to any communication line other than an analog phone line could cause a computer system failure.*
  - *Connect the built-in modem only to ordinary analog phone lines.*
  - *Never connect the built-in modem to a digital line (ISDN).*
  - *Never connect the built-in modem to the digital connector on a public telephone or to a digital private branch exchange (PBX).*
  - *Never connect the built-in modem to a key telephone system for residences or offices.*
- *Avoid using your computer modem with the telephone cable connected during an electrical storm. There may be a remote risk of electric shock from lightning.*

1. Plug the end of the modular cable into the computer's modem jack.
2. Plug the other end of the modular cable into a telephone jack.

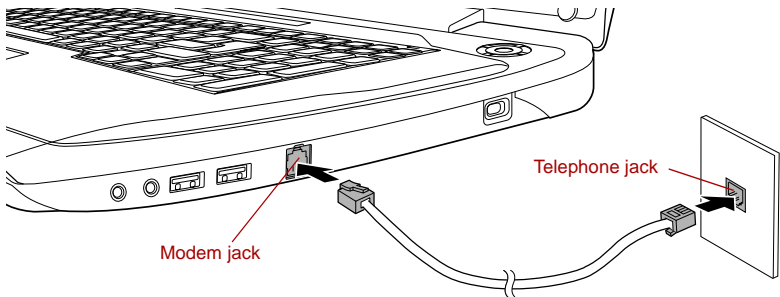

*Figure 4-12 Connecting the internal modem*



*Do not pull on the cable or move the computer while the cable is connected.*

## Disconnecting the modular cable

To disconnect the modular cable, follow the steps as detailed below:

1. Pinch the lever on the plug in the telephone jack and pull it out from within the connector.
2. Pinch the lever on the plug in the computer's modem jack and pull it out from within the computer.

## Wireless communications

The computer's wireless communication function supports both Wireless LAN and Bluetooth devices.

All models are provided with Wireless Communication switch. Some models are equipped with both Wireless LAN and Bluetooth functions.

### Wireless LAN

The Wireless LAN is compatible with other LAN systems based on Direct Sequence Spread Spectrum/Orthogonal Frequency Division Multiplexing radio technology that complies with the IEEE802.11 Wireless LAN standard.

- Frequency Channel Selection of 5GHz for IEEE 802.11a or n draft 2.0
- Frequency Channel Selection of 2.4GHz for 802.11b/g or n draft 2.0
- Roaming over multiple channels
- Card power management
- Wired Equivalent Privacy (WEP) data encryption based on an 128-bit encryption algorithm
- Wi-Fi Protected Access™ (WPA™) support
- Advanced Encryption Standard (AES) data encryption



*The transmission speed over the wireless LAN, and the distance over which the wireless LAN can reach, may vary depending on surrounding electromagnetic environment, obstacles, access point design and configuration, client design and software/hardware configurations. The transmission rate described is the theoretical maximum speed as specified under the appropriate standard - the actual transmission speed will be lower than the theoretical maximum speed.*

### Setting

1. Please make sure that the **Wireless Communication Switch** is turned on.
2. Click **Start** and then click **Connect To** to display **Connect to a network** window.
3. Click **Set up a connection or network**.
4. Follow the wizard. You will need the name of the wireless network together with security settings. Consult the documentation accompanied with your router or ask your wireless network administrator for the settings.

## Security

- TOSHIBA strongly recommend that you enable encryption functionality, otherwise your computer will be open to illegal access by an outsider using a wireless connection. If this occurs, the outsider may illegally access your system, eavesdrop, or cause the loss or destruction of stored data.
- TOSHIBA is not liable for the loss of data due to eavesdropping or illegal access through the wireless LAN and the damage thereof.

## Bluetooth wireless technology

Bluetooth wireless technology eliminates the need for cables, such as desktop computers, between your PC and other electronic devices, example of printers and mobile phones.

You cannot use the computer's built-in Bluetooth functions and an external Bluetooth adaptor simultaneously.

For reference, Bluetooth wireless technology has the following features:

### **Worldwide operation**

The Bluetooth radio transmitter and receiver operate in the 2.4GHz band, which is license-free and compatible with radio systems in most countries in the world.

### **Radio links**

You can easily establish links between two or more devices, with these links being maintained even if the devices are not within a line-of-sight of each other.

### **Security**

Two advanced security mechanisms ensure a high level of security:

- Authentication prevents access to critical data and makes it impossible to falsify the origin of a message.
- Encryption prevents eavesdropping and maintains link privacy.

## Bluetooth Stack for Windows by TOSHIBA

Please note that this software is specifically designed for the following operating systems:

- Microsoft Windows Vista

Information regarding the use of this software with these operating systems is listed below, with further details being contained with the electronic help files supplied with the software.



*This Bluetooth Stack is based on the Bluetooth Version 1.1/1.2/2.0+EDR/2.1+EDR specification. However, TOSHIBA cannot confirm the compatibility between any computing products and/or other electronic devices that use Bluetooth, other than TOSHIBA notebook computers.*

## **Release Notes related to the Bluetooth Stack for Windows by TOSHIBA**

1. Fax application software:  
Please be aware that there is some fax application software that you cannot use on this Bluetooth Stack.
2. Multi-user considerations:  
On Windows Vista, the use of Bluetooth is not supported in a multi-user environment. This means that, when you use Bluetooth, other users that are logged into the same computer will not be able to use this type of functionality.

### **Product Support:**

The latest information regarding operating system support, language support or available upgrades can be found on our web site <http://www.toshiba-europe.com/computers/tnt/bluetooth.htm> in Europe or [www.pcsupport.toshiba.com](http://www.pcsupport.toshiba.com) in the United States.

## **Wireless communication switch**

You can enable or disable Wireless communication function, with the on/off switch. No transmissions are sent or received when the switch is off. Slide the switch to the left to turn it off and to the right to turn it on.



- *Do not use the Wireless LAN (Wi-Fi) or Bluetooth functionalities near a microwave oven or in areas subject to radio interference or magnetic fields. Interference from a microwave oven or other source can disrupt Wi-Fi or Bluetooth operation.*
- *Turn Wi-Fi and Bluetooth functionalities off when near a person who may have a cardiac pacemaker implant or other medical electric device. Radio waves may affect pacemaker or medical device operation, possibly resulting in serious injury. Follow the instruction of your medical device when using any Wi-Fi or Bluetooth functionality.*
- *Always turn off Wi-Fi or Bluetooth functionality if the computer is near automatic control equipment or appliances such as automatic doors or fire detectors. Radio waves can cause malfunction of such equipment, possibly resulting in serious injury.*
- *It may not be possible to make a network connection to a specified network name using the ad hoc network function. If this occurs, the new network(\*) will have to be configured for all computers connected to the same network in order to re-enable network connections.*  
*\* Please be sure to use new network name.*

## Wireless communication indicator

The wireless communication indicator shows the status of the computer's wireless communication functions.

Indicator status	Indication
Indicator off	The wireless communication switch is off - no wireless functionality is available.
Indicator glows	Wireless communication switch is on. Wireless LAN or Bluetooth is turned on by an application.

If you used the Taskbar to disable the wireless LAN, restart the computer or perform the following procedure to re-enable it: **Start -> Control Panel -> System and Maintenance -> System -> Device Manager -> Network adapters** and right click the wireless device then choose **enable**.

## LAN

The computer has built-in support for Ethernet LAN (10 megabits per second, 10BASE-T), Fast Ethernet LAN (100 megabits per second, 100BASE-TX) and Gigabit Ethernet LAN (1000 megabits per second, 1000BASE-T). This section describes how to connect/disconnect to a LAN.



*Do not install or remove a memory module while Wake-up on LAN is enabled.*



- *The Wake-up on LAN function consumes power even when the system is off. Leave the AC adaptor connected while using this feature.*
- *The Link speed (10/100/1000 megabits per second) changes automatically depending on the network conditions (connected device, cable or noise and so on).*

## LAN cable types



*The computer must be configured properly before connecting to a LAN. Logging onto a LAN using the computer's default settings could cause a malfunction in LAN operation. Check with your LAN administrator regarding set-up procedures.*

If you are using Gigabit Ethernet LAN (1000 megabits per second, 1000BASE-T), be sure to connect with a CAT5E cable or higher. You cannot use a CAT3 or CAT5 cable.

If you are using Fast Ethernet LAN (100 megabits per second, 100BASE-TX), be sure to connect with a CAT5 cable or higher. You cannot use a CAT3 cable.

If you are using Ethernet LAN (10 megabits per second, 10BASE-T), you can connect with a CAT3 or higher cable.

## Connecting the LAN cable

To connect the LAN cable, follow the steps as detailed below:



- *Connect the AC adaptor before connecting the LAN cable. The AC adaptor must remain connected during LAN use. If you disconnect the AC Adaptor while the computer is accessing a LAN, the system may hang up.*
- *Do not connect any other cable to the LAN jack except the LAN cable. Otherwise, malfunctions or damage may occur.*
- *Do not connect any power supplying device to the LAN cable that is connected to the LAN jack. Otherwise, malfunctions or damage may occur.*

1. Turn off the power to the computer and to all external devices connected to the computer.
2. Plug one end of the cable into the LAN jack. Press gently until you hear the latch click into place.

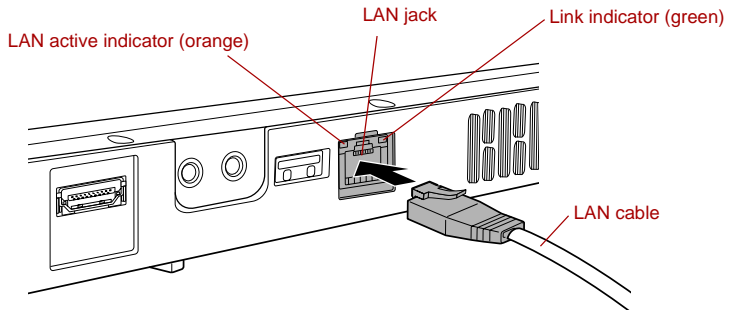

*Figure 4-13 Connecting the LAN cable*

3. Plug the other end of the cable into a LAN hub connector or router. Check with your LAN administrator and hardware or software vendor before using or configuring a network connection.



*When the computer is exchanging data with the LAN, the **LAN Active** indicator glows orange. When the computer is connected to a LAN hub but is not exchanging data, the **Link** indicator glows green.*

## Disconnecting the LAN cable

To disconnect the LAN cable, follow the steps as detailed below:



*Make sure the **LAN Active** indicator (orange LED) is out before you disconnect the computer from the LAN.*

1. Pinch the lever on the connector in the computer's LAN jack and pull out the connector.
2. Disconnect the cable from the LAN hub or router in the same manner. Check with your LAN administrator and hardware or software vendor before disconnecting from the hub.

## Computer Handling

This section explains computer handling and maintenance.

### Cleaning the computer

To help ensure long, trouble-free operation, keep the computer free of dust and dirt, and use care with all liquids around it.

- Be careful not to spill liquids into the computer. If the computer does get wet, turn the power off immediately and let the computer dry completely - in these circumstance you should get the computer inspected by an authorized service provider in order to assess the scope of any damage.
- Clean the plastics of the computer using a slightly water dampened cloth.
- You can clean the display screen by spraying a small amount of glass cleaner onto a soft, clean cloth and then wiping the screen gently with the cloth.



*Never spray cleaner directly onto the computer or let liquid run into any part of it. Never use harsh or caustic chemical products to clean the computer.*



## Using the cleaning cloth

Some models include 1 cleaning cloth.

The cleaning cloth can be used to wipe away dust and fingerprints from the keyboard and palm rest area of your computer.



- *When wiping the keyboard, palm rest and display panel, do so gently without using excessive pressure.*
- *Do not use the cleaning cloth when it is dirty or wet.*
- *Do not use the cleaning cloth soaked with water, detergents or volatile organic solvents.*

*It is recommended that you wash the cloth if it gets soiled using a gentle, mild detergent and rinse it well. Allow it to air dry completely before using it again on your computer.*

## Moving the computer

While the computer is designed for rugged durability you should exercise a few simple precautions when moving it in order to help ensure trouble-free operation.

- Make sure all disk/disc activity has ended before moving the computer - check that the HDD and other indicators on the front of the computer are off.
- If a CD or DVD is in the drive, remove it and make sure that the disc tray is securely closed.
- Turn off (shut down) the computer.
- Disconnect the AC adaptor and all peripherals before moving the computer.
- Close the display panel.
- Do not pick up the computer by its display panel.
- Before carrying your computer, shut it down, disconnect the AC adaptor and allow it to cool down - a failure to follow this instruction may result in minor heat injury.
- Be careful not to subject the computer to impact or shock - a failure to follow this instruction could result in damage to computer, computer failure or loss of data.
- Never transport your computer with any cards installed - this may cause damage to either the computer and/or the card resulting in product failure.
- Always use a suitable carry case when transporting the computer.
- When carrying your computer, be sure to hold it securely so that it does not fall or hit anything.
- Do not carry your computer by holding any of its protruding elements.



# Chapter 5

## The Keyboard

The computer's keyboard layouts are compatible with a 104/105-key enhanced keyboard - by pressing some keys in combination, all of the 104/105-key enhanced keyboard functions can be performed on the computer.

The number of keys available on your keyboard will depend on which country/region your computer is configured for, with keyboards being available for numerous languages.

In use there are five different types of keys, specifically typewriter keys, function keys, soft keys, Hot keys and Windows special keys.

### Typewriter keys

The typewriter keys produce the upper-case and lower-case letters, numbers, punctuation marks, and special symbols that appear on the screen. However, there are some differences between using a typewriter and using a computer keyboard:

- Letters and numbers produced in computer text vary in width. Spaces, which are created by a "space character" may also vary depending on line justification and other factors.
- The lowercase l (el) and the number 1 (one), together with the uppercase O (oh) and the 0 (zero), are not interchangeable on computers as they are on a typewriter.
- The **CAPS LOCK** function key locks only the alphabetic characters into upper-case while the Shift Lock function on a typewriter places all keys in the shifted position.
- The **SHIFT** keys, the **Tab** key, and the **BACK SPACE** key perform the same function as their typewriter counterparts but also have special computer functions.



*Never remove the key caps on your keyboard. Doing so could cause damage to the parts under the key caps.*

## Function keys: F1 ... F9

The function keys (not to be confused with the special **FN** key) are the twelve keys at the top of your keyboard - these keys function differently from other keys.



**F1** through **F9** are called function keys because they execute programmed functions when pressed and, when used in combination with the **FN** key, those keys marked with icons also execute specific functions on the computer. Please refer to the section, [Soft keys: FN key combinations](#), in this chapter for further information, taking care to note that the function executed by individual keys will depend on the software you are using.

## Soft keys: FN key combinations

The **FN** (function) is unique to TOSHIBA computers and is used in combination with other keys to form soft keys. Soft keys are key combinations that enable, disable or configure specific features.



*Please note that some software may disable or interfere with soft-key operations, and that the soft-key settings are not restored when the computer returns from Sleep Mode.*

## Hot keys

Hot keys (pressing **FN** + a function or **ESC** key) let you enable or disable certain features of the computer.



**Mute:** Pressing **FN** + **ESC** turns the volume on and off.



**Lock:** Pressing **FN** + **F1** enters “Lock computer mode”. To restore your desktop, you need to log on again.

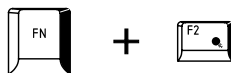

**Power Plan:** Pressing **FN** + **F2** changes the power settings.

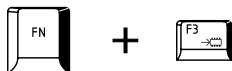

**Sleep:** Pressing **FN + F3** switches the system to Sleep Mode.



**Hibernate:** Pressing **FN + F4** switches the system to Hibernation Mode.



**Output:** Pressing **FN + F5** changes the active display device.



*To use a simultaneous mode, you must set the resolution of the internal display panel to match the resolution of the external display device.*



**Brightness Down:** Pressing **FN + F6** decreases the computer's display panel brightness in individual steps.



**Brightness Up:** Pressing **FN + F7** increases the computer's display panel brightness in individual steps.



**Wireless:** Pressing **FN + F8** switches the active wireless devices if the wireless communication switch is switched on.



*If no wireless communication device is installed, no dialog box will appear.*

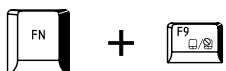

**Touch Pad:** Pressing **FN + F9** enables or disables the Touch Pad function.

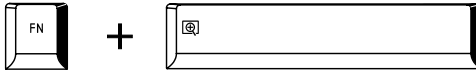

**Zoom:** Pressing **FN + Space** changes the display resolution.



**TOSHIBA Zooming Utility (reduce):** Pressing **FN + 1** reduces the icon size on the desktop or the font sizes within one of the supported application windows.



**TOSHIBA Zooming Utility (enlarge):** Pressing **FN + 2** enlarges the icon size on the desktop or the font sizes within one of the supported application windows.

### FN Sticky key

You can use the TOSHIBA Accessibility Utility to make the **FN** key sticky, that is, you can press it once, release it, and then press an “**F Number**” key. To start the TOSHIBA Accessibility utility, click **Start -> All Programs -> TOSHIBA -> Utilities -> Accessibility**.

### Windows special keys

The keyboard provides two keys that have special functions in Windows, the Windows Start Button key activates the **Start** menu while the application key has the same function as the secondary (right) mouse button.



This key activates the Windows **Start** menu.



This key has the same function as the secondary (right) mouse button.

## Desktop-style Keyboard

The Qosmio G50 comes with a “desktop-style” keyboard built into it. This means it is full-sized and features a full set of numeric function keys (also known as calculator keys) on the right-hand side. Unlike other notebooks computers with smaller keyboards, there is no “Numeric Mode” or any numeric keyboard overlay.

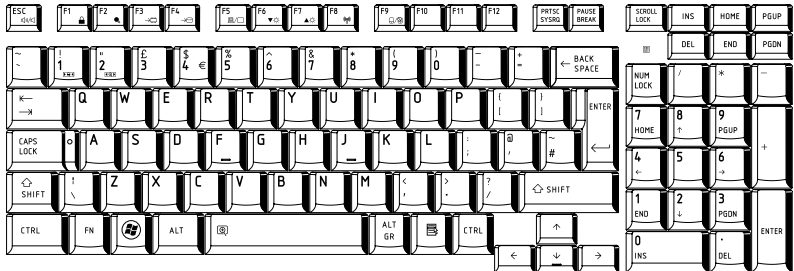

Figure 5-1 Desktop-style Keyboard

## Generating ASCII characters

Not all ASCII characters can be generated using normal keyboard operation, but you are able to generate these characters using their specific ASCII codes.

1. Hold down **ALT** key.
2. Using the numeric function, type the ASCII code of the character you require.
3. Release **ALT** key - the ASCII character will appear on the display screen.





# Chapter 6

## Power

The computer's power resources include the AC adaptor, battery pack and any internal batteries. This chapter provides details on making the most effective use of these resources, and includes information on charging and changing batteries, tips for saving battery power, and information on the different power-up modes.

### Power conditions

The computer's operating capability and battery charge status are affected by different power conditions, including whether an AC adaptor is connected, whether a battery pack is installed and what the charge level is for that battery.

*Table 6-1 Power conditions*

		Power on	Power off (no operation)
AC adaptor connected	Battery fully charged	<ul style="list-style-type: none"> <li>Operates</li> <li>LED: <b>Battery</b> white <b>DC IN</b> white</li> </ul>	<ul style="list-style-type: none"> <li>LED: <b>Battery</b> white <b>DC IN</b> white</li> </ul>
	Battery partially charged or no charge	<ul style="list-style-type: none"> <li>Operates</li> <li>Quick Charge</li> <li>LED: <b>Battery</b> orange <b>DC IN</b> white</li> </ul>	<ul style="list-style-type: none"> <li>Quick charge</li> <li>LED: <b>Battery</b> orange <b>DC IN</b> white</li> </ul>
	No battery installed	<ul style="list-style-type: none"> <li>Operates</li> <li>No charge</li> <li>LED: <b>Battery</b> off <b>DC IN</b> white</li> </ul>	<ul style="list-style-type: none"> <li>No charge</li> <li>LED: <b>Battery</b> off <b>DC IN</b> white</li> </ul>

Table 6-1 Power conditions continued

		Power on	Power off (no operation)
AC adaptor not connected	Battery charge is above low battery trigger point	<ul style="list-style-type: none"> <li>Operates</li> <li>LED: <b>Battery</b> off <b>DC IN</b> off</li> </ul>	
	Battery charge is below low battery trigger point	<ul style="list-style-type: none"> <li>Operates</li> <li>LED: <b>Battery</b> flashes orange <b>DC IN</b> off</li> </ul>	
	Battery charge is exhausted	Computer goes into Sleep Mode and shuts down	
	No battery installed	<ul style="list-style-type: none"> <li>Cannot operate</li> <li>LED: <b>Battery</b> off <b>DC IN</b> off</li> </ul>	

## Monitoring of power condition

As shown in the below table, the **Battery**, **DC IN** and **Power** indicators on the system indicator alert you to the computer's operating capability and battery charge status.

### Battery indicator

Check the **Battery** indicator to determine the status of the battery pack - the following indicator lights indicate the battery status:

<b>Flashing orange</b>	The battery charge is low, the AC adaptor must be connected in order to recharge the battery.
<b>Orange</b>	Indicates the AC adaptor is connected and the battery is charging.
<b>White</b>	Indicates the AC adaptor is connected and the battery is fully charged.
<b>No light</b>	Under any other conditions, the indicator does not light.



*If the battery pack becomes too hot while it is being charged, the charge will stop and the **Battery** indicator will go out. When the battery pack's temperature falls to a normal range, charging will resume - this process will occur regardless of whether the computer's power is on or off.*

## DC IN indicator

Check the **DC IN** indicator to determine the power status with the AC adaptor connected - the following indicator conditions should be noted:

<b>White</b>	Indicates the AC adaptor is connected and is correctly supplying power to the computer.
<b>Flashing orange</b>	Indicates a problem with the power supply. You should initially try plugging the AC adaptor into another power outlet - if it still does not operate properly, you should contact your reseller or dealer.
<b>No light</b>	Under any other conditions, the indicator does not light.

## Power indicator

Check the **Power** indicator to determine the power status of the computer - the following indicator conditions should be noted:

<b>White</b>	Indicates power is being supplied to the computer and the computer is turned on.
<b>Blinking orange</b>	Indicates that the computer is in Sleep Mode and that there is sufficient power available (AC adaptor or battery) to maintain this condition. In Sleep Mode, this indicator will turn on for one second and off for two seconds.
<b>No light</b>	Under any other conditions, the indicator does not light.

## Battery

This section explains battery types, use, recharging methods and handling.

### Battery types

The computer has two different types of batteries.

- Battery pack
- Real Time Clock (RTC) battery

#### **Battery pack**

When the AC adaptor is not connected, the computer's main power source is a removable lithium ion battery pack, also referred to in this manual as the main battery. You can purchase additional battery packs for extended use of the computer away from an AC power source although you should not change the battery pack while the AC adaptor is connected. Battery type (depending on the model you purchased): There are two types of battery packs (7050mAh or 4700mAh).

Before you remove the battery pack, save your data and shut down the computer, or place the computer into Hibernation Mode. Please be aware that, when placing the computer into Hibernation Mode, the contents of memory will be saved to the hard disk drive, although for safety sake, it is best to also save your data manually.

#### **Real Time Clock (RTC) battery**

The Real Time Clock (RTC) battery provides power for the internal real time clock and calendar function and also maintains the system configuration while the computer is turned off. If the RTC battery becomes completely discharged, the system will lose this information and the real time clock and calendar will stop working - in this instance the following message will be displayed when you turn on the power:



```
**** RTC battery is low or CMOS checksum is  
inconsistent ****  
Press [F1] key to set Date/Time.
```

You can change the Real Time Clock settings by turning the computer on while pressing the **ESC** key and then the **F1** key when prompted. Please refer to Chapter 10, [Troubleshooting](#), for further information.



*The RTC battery does not charge while the computer is turned off even if the AC adaptor is attached.*

## Care and use of the battery pack

This section provides the important safety precautions in order to handle your battery pack properly.

Refer to the enclosed **Instruction Manual for Safety and Comfort** for detailed precautions and handling instructions.



- *Make sure the battery is securely installed in the computer before attempting to charge the battery pack. Improper installation could generate smoke or fire, or cause the battery pack to rupture.*
- *Keep the battery pack out of reach of infants and children. It can cause injury.*



- *The battery pack is lithium ion battery, which can explode if not replaced, used, handled or disposed of properly. Dispose of the battery as required by local ordinances or regulations. Use only batteries recommended by TOSHIBA as replacements.*
- *The computer's RTC battery is a Ni-MH battery and should be replaced only by your dealer or by a TOSHIBA service representative. The battery can explode if not properly replaced, used, handled or disposed. Dispose of the battery as required by local ordinances or regulations.*
- *Charge the battery pack only in an ambient temperature between 5 and 35 degrees Celsius. Otherwise, the electrolyte solution might leak, battery pack performance might deteriorate and the battery life might be shortened.*
- *Never install or remove the battery pack without first turning off the power and disconnecting the AC adaptor. Never remove the battery pack while the computer is in Sleep Mode. Data could be lost.*



*Never remove the battery pack while the Wake-up on LAN function is enabled. Data will be lost. Before you remove a battery pack, disable the Wake-up on LAN function.*

## Charging the batteries

When the power in the battery pack becomes low, the **Battery** indicator will flash orange to indicate that only a few minutes of battery power remain. If you continue to use the computer while the **Battery** indicator flashes, the computer will enable Hibernation Mode so that you do not lose any data, and automatically turn itself off.

You must recharge a battery pack when it becomes discharged.

### Procedures

To recharge a battery pack while it is installed in the computer, connect the AC adaptor to the DC IN 19V jack and plug the other end into a working outlet - the **Battery** indicator will glow orange while the battery is being charged.



*Use only the computer connected to an AC power source or optional TOSHIBA Battery charger to charge the battery pack. Never attempt to charge the battery pack with any other charger.*

### Time

Refer to User's Manual about Charging time.

### Battery charging notice

The battery may not begin charging immediately under the following conditions:

- The battery is extremely hot or cold (if the battery is extremely hot, it might not charge at all). To ensure the battery charges to its full capacity, you should charge it at room temperature of between 5° to 35°C (41° to 95°F).
- The battery is nearly completely discharged. In this instance you should leave the AC adaptor connected for a few minutes and the battery should begin charging.

The **Battery** indicator may show a rapid decrease in battery operating time when you try to charge a battery under the following conditions:

- The battery has not been used for a long time.
- The battery has completely discharged and been left in the computer for a long time.
- A cool battery is installed in a warm computer.

In such cases you should follow the steps as detailed below:

1. Fully discharge the battery by leaving it in the computer with the power on until the system automatically turns itself off.
2. Connect the AC adaptor to the DC IN 19V jack of the computer, and to a wall outlet that is supplying power.
3. Charge the battery until the **Battery** indicator glows white.

Repeat these steps two or three times until the battery recovers normal capacity.

## Monitoring battery capacity

Remaining battery power can be monitored using the following methods.

- Clicking the battery icon on the Taskbar
- Via the Battery Status in the Windows Mobility Center window



- *You should wait at least 16 seconds after turning on the computer before trying to monitor the remaining operating time. This is because the computer needs this time to check the battery's remaining capacity and then calculate the remaining operating time, based on this together with the current power consumption.*
- *Please be aware that the actual remaining operating time may differ slightly from the calculated time.*
- *With repeated discharges and recharges, the battery's capacity will gradually decrease. In view of this it will be noted that an often used, older battery will not operate for as long as a new battery even when both are fully charged.*

## Maximizing battery operating time

A battery's usefulness depends on how long it can supply power on a single charge, while how long the charge lasts in a battery depends on:

- Processor speed
- Screen brightness
- System Sleep Mode
- System Hibernation Mode
- Display power off period
- Hard disk drive power off period
- How often and for how long you use the hard disk drive and external disk(c) drives, for example, optical disc and floppy diskette drive.
- How much charge the battery contained to begin with.
- How you use optional devices, such as a ExpressCards, to which the battery supplies power.
- Whether you enable Sleep Mode, which can conserve battery power if you are frequently turning the computer off and on.
- Where you store your programs and data.
- Whether you close the display panel when you are not using the keyboard - closing the display saves power.
- The environmental temperature - operating time decreases at low temperatures.
- The condition of the battery terminals - you should always ensure the terminals stay clean by wiping them with a clean dry cloth before installing the battery pack.

## Retaining data with power off

Refer to User's Manual about Retention time.

## Extending battery life

To maximize the life of your battery packs:

- At least once a month, disconnect the computer from a power source and operate it on battery power until the battery pack fully discharges. Before doing so, follow the steps as detailed below.
  1. Turn off the computer's power.
  2. Disconnect the AC adaptor and turn on the computer's power - if it does not turn on then go to Step 4.
  3. Operate the computer on battery power for five minutes. If you find that the battery pack has at least five minutes of operating time, continue operating until the battery pack is fully discharged, however, if the **Battery** indicator flashes or there is some other warning to indicate a low battery condition, go to Step 4.
  4. Connect the AC adaptor to the DC IN 19V jack of the computer, and to a wall outlet that is supplying power. The **DC IN** indicator should glow white, and the **Battery** indicator should glow orange to indicate that the battery pack is being charged, however, in the event that **DC IN** indicator does not glow this indicates that power is not being supplied - check the connections for the AC adaptor and the power cord.
  5. Charge the battery pack until the **Battery** indicator glows white.
- If you have extra battery packs, rotate their use.
- If you will not be using the system for an extended period, for example for more than one month, remove the battery pack from the computer.
- Store spare battery packs in a cool dry place out of direct sunlight.

## Replacing the battery pack

Please be aware that the battery pack is classified as a consumable item.

The operating life of the battery pack will gradually reduce through repeated charging and discharging, and will need to be replaced when it reaches the end of its operating life. In addition to this, you might also replace a discharged battery pack with a charged spare when you are operating your computer away from an AC power source for an extended period of time.

This section explains how to remove and install the battery pack, and begins with the removal process which is detailed through the following steps.





- Do not remove the battery pack while the computer is in Sleep Mode. Data is stored in RAM, so if the computer loses power it will be lost.
- In Hibernation Mode, data will be lost if you remove the battery pack or disconnect the AC adaptor before the save is completed. Wait for the **Hard Disk Drive** indicator to go out.
- Do not touch the battery release latch while holding the computer or the battery pack might fall out due to the unintentional release of the battery release latch and cause injuries.

## Removing the battery pack

To remove a discharged battery, follow the steps as detailed below:

1. Save your work.
2. Turn the computer's power off - ensure that the **Power** indicator is off.
3. Remove all cables and peripherals that are connected to the computer.
4. Close the display panel and turn the computer upside down.
5. Slide the battery safety lock towards the release (  ) position to make the battery release latch movable.

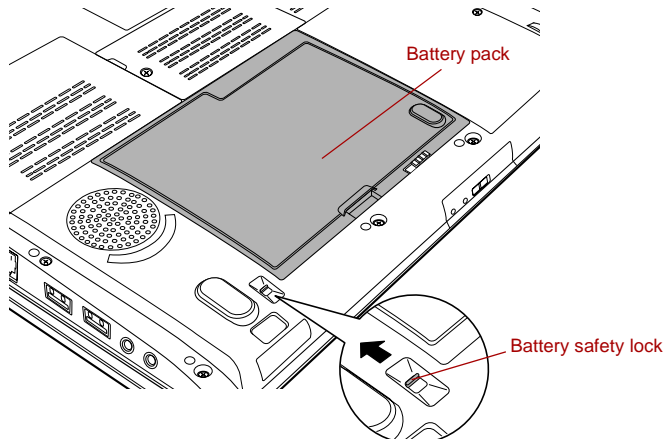

Figure 6-1 Releasing the battery pack (1)

- Slide and hold the battery release latch (1) to disengage the battery pack and then remove it from the computer (2).

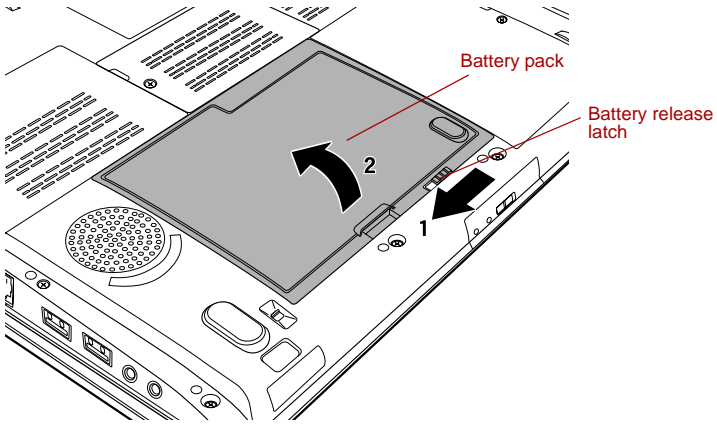



Figure 6-2 Releasing the battery pack (2)

## Installing the battery pack

To install a battery, follow the steps as detailed below:



*Do not touch the battery release latch while holding the computer or the battery pack might fall out due to the unintentional release of the battery release latch and cause injuries.*

- Insert the battery pack as far as it will go into the computer (1).
- Ensure that the battery pack is securely in place and the battery safety lock (2) is in its (  ) position.

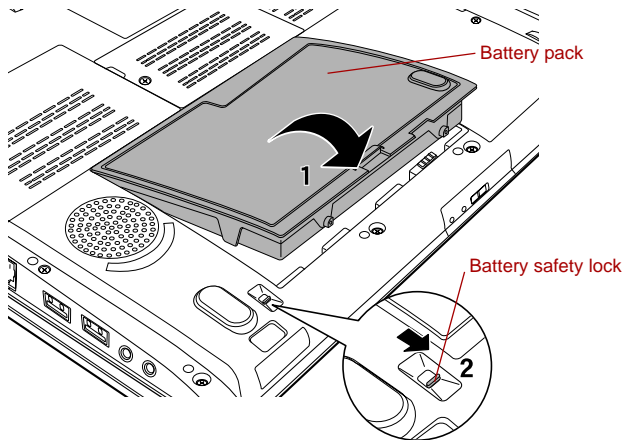

Figure 6-3 Securing the battery pack

- Turn your computer over.

## TOSHIBA Password Utility

The TOSHIBA Password Utility provides two levels of password security: User and Supervisor.



*Passwords set by the TOSHIBA Password Utility function are different from the Windows password.*

### User Password

To start the utility, point to or click the following items:

**Start -> All Programs -> TOSHIBA -> Utilities -> Password Utility**

#### *User Password field*

- **Set** (button)

Click this button to register a password of up to 50 characters. After a password is set, you will be prompted to enter it when you start the computer.



- *After you set the password, a dialog box will be displayed asking whether you want to save it to a floppy diskette or other media. If you forget the password, you can open the password file on another computer. Be sure to keep the media in a safe place.*
- *When entering the character string to register the password, enter from the keyboard character by character and do not enter as ASCII code or copy-and-paste the character string. In addition, ensure that the registered password is correct by outputting the character string to the password file.*
- *When entering a password, do not enter any characters (for example "!" or "#") produced by pressing the **SHIFT** or **ALT** keys and so on.*
- **Delete** (button)  
Click this button to delete a registered password. Before you can delete a password, you must first enter the current password correctly.
- **Change** (button)  
Click this button to change a registered password. Before you can change a password, you must first enter the current password correctly.
- **Owner String** (text box)  
You can use this box to associate text with the password. After you enter text, click **Apply** or **OK**. When the computer is started, this text will be displayed together with the prompt asking you to enter a password.



- *If you forget your HDD User Password, TOSHIBA will NOT be able to assist you, and your HDD will be rendered COMPLETELY and PERMANENTLY INOPERABLE. TOSHIBA will NOT be held responsible for any loss of any data, any loss of use or access to your HDD, or for any other losses to you or any other person or organization that result from the loss of access to your HDD. If you can't accept this risk, don't register the HDD User Password.*
- *When saving the HDD User Password shut down or restart the computer. If the computer is not shut down or restarted, the saved data may not be correctly reflected. For more information on shutting down or restarting the computer, refer to [Turning on the power](#) in Chapter 3.*

## Supervisor Password

If you set a Supervisor Password, some functions might be restricted when a user logs on with the User Password. To set a Supervisor Password, execute the file TOSPU.EXE. The file is located at:

`C:\Program Files\Toshiba>PasswordUtility\TOSPU.exe`

This utility lets you do the following:

- Register, delete or change the Supervisor Password.
- Specify restrictions for general users.

## Starting the computer by password

If you have already registered a password, there are two ways to start the computer:

- Swipe your fingerprint on the sensor if you have already registered the fingerprint with the Fingerprint utility and enabled Fingerprint System Boot Authentication. If you would not like to swipe your finger or cannot authenticate the fingerprint for some reasons, push the **BACK SPACE** key to skip the fingerprint authentication screen. You can try to swipe the fingerprint up to five times. If you failed fingerprint authentication five times, you must enter the password manually to start the computer.
- Enter the password manually.



*The password is necessary only if the computer was turned off in Shut Down Mode or Hibernation Mode.*

*It is not needed in Sleep Mode and Restart.*

To enter a password manually, follow the steps as detailed below:

1. Turn on the power as described in Chapter 3, [Getting Started](#).  
The following message will appear in the screen:



Password=

2. Enter the Password.
3. Press **ENTER**.



*If you enter the password incorrectly three times in a row the computer shuts off. In this case, you must turn the computer back on to retry password entry.*

## Power-up modes

The computer has three different power-up modes as follows:

- **Shut Down Mode:** The computer will shut down without saving data - in view of this you must always save your work before you turn the computer off.
- **Hibernation Mode:** Data in memory will be saved to the hard disk drive.
- **Sleep Mode:** Data will be maintained in the computer's memory.



*Please refer to the sections [Turning on the power](#) and [Turning off the power](#) in Chapter 3, [Getting Started](#) for further information.*

## Windows utilities

You can configure various settings associated with both Sleep Mode and Hibernation Mode within the Power Options (to access it, **Start** -> **Control Panel** -> **System and Maintenance** -> **Power Options**).

## Hot keys

You can use the **FN + F3** hot key to enter Sleep Mode or **FN + F4** to enter Hibernation Mode - please refer to Chapter 5, [The Keyboard](#), for further details.

## Panel power on/off

You can set up your computer so that power is turned off automatically when you close the display panel, and turned on again when you open it. Please note that this function is only available for Sleep Mode or Hibernation Mode, not for Shut Down Mode.



*If the panel power off function is enabled, and you manually shut down Windows, do not close the display panel until the shut down process has been completed.*

## System automatic Sleep/Hibernation

This feature automatically turns off the system in Sleep or Hibernation Mode if the computer is not used for a set duration. Refer to [Special features](#), in Chapter 1 for an explanation of how to set the duration.



# Chapter 7

## HW Setup

This chapter explains how to use the TOSHIBA HW Setup program to configure your computer, and provides information on settings for various functions.

### Accessing HW Setup

To run the HW Setup program, click **Start -> All Programs -> TOSHIBA -> Utilities -> HWSetup**.

### HW Setup window

The HW Setup window contains a number of tabs (General, Display, Boot Priority, Keyboard, CPU, LAN, Device Config, USB and Button Setting) to allow specific functions of the computer to be configured.

In addition there are also three buttons: **OK**, **Cancel** and **Apply**.

<b>OK</b>	Accepts your changes and closes the HW Setup window.
<b>Cancel</b>	Closes the window without accepting your changes.
<b>Apply</b>	Accepts all your changes without closing the HW Setup window.

## General

This window displays the BIOS version and contains two buttons: **Default** and **About**.

<b>Default</b>	Return all HW Setup values to the factory settings.
<b>About</b>	Display the HW Setup version.

## Setup

This field displays the installed **BIOS version** and date.

## Display

This tab lets you customize your computer's display settings for either the internal display or an external monitor.

### Power On Display

This tab allows you to select the display to be used when the computer is started. Please note that this setting is only available on standard VGA mode and is not available as part of the Windows Desktop properties.



*The Power On Display is supported with some models.*

<b>Auto-Selected</b>	Selects an external monitor if one is connected, otherwise, it selects the internal display (default).
<b>LCD + Analog RGB</b>	Selects both the internal display and an external monitor for simultaneous display.



*If the connected external monitor does not support the computer's current video mode, selecting the LCD + Analog RGB mode will not display any image on the external monitor.*



## Boot Priority

### Boot Priority Options

This tab allows you to select the priority for booting the computer - the following settings are available:

“HDD” here refers to the Built-in HDD that is defined in the HDD Priority Option so that it should be recognized first.

<b>FDD -&gt; HDD -&gt; CD-ROM -&gt; LAN</b>	The computer looks for bootable files on devices in the following order: 1. floppy diskette drive <sup>*1</sup> , 2. hard disk drive, 3. CD-ROM <sup>*2</sup> , 4. LAN.
<b>HDD -&gt; FDD -&gt; CD-ROM -&gt; LAN</b>	The computer looks for bootable files on devices in the following order: 1. hard disk drive, 2. floppy diskette drive <sup>*1</sup> , 3. CD-ROM <sup>*2</sup> , 4. LAN.
<b>FDD -&gt; CD-ROM -&gt; LAN -&gt; HDD</b>	The computer looks for bootable files on devices in the following order: 1. floppy diskette drive <sup>*1</sup> , 2. CD-ROM <sup>*2</sup> , 3. LAN, 4. hard disk drive.
<b>HDD -&gt; CD-ROM -&gt; LAN -&gt; FDD</b>	The computer looks for bootable files on devices in the following order: 1. hard disk drive, 2. CD-ROM <sup>*2</sup> , 3. LAN, 4. floppy diskette drive <sup>*1</sup> .
<b>CD-ROM -&gt; LAN -&gt; FDD -&gt; HDD</b>	The computer looks for bootable files on devices in the following order: 1. CD-ROM <sup>*2</sup> , 2. LAN, 3. floppy diskette drive <sup>*1</sup> , 4. hard disk drive.
<b>CD-ROM -&gt; LAN -&gt; HDD -&gt; FDD</b>	The computer looks for bootable files on devices in the following order: 1. CD-ROM <sup>*2</sup> , 2. LAN, 3. hard disk drive, 4. floppy diskette drive <sup>*1</sup> .

You can override the settings and manually select a boot device by pressing one of the following keys while the computer is booting:

<b>U</b>	Selects the USB floppy diskette drive.
<b>N</b>	Selects the network.
<b>1</b>	Selects the primary hard disk drive.
<b>2</b>	Selects the primary hard disk drive 2 <sup>*3</sup> .
<b>C</b>	Selects the CD-ROM <sup>*2</sup> .
<b>M</b>	Selects the USB memory drive.

<sup>\*1</sup> The floppy diskette drive is looked for when the boot disk is contained in external floppy diskette drive.

<sup>\*2</sup> In this computer, CD-ROM refers to the Fixed optical disc drive.

<sup>\*3</sup> Only the model with two HDDs is supported.

To change the boot drive, follow the steps below.

1. Hold down **F12** and turn the computer on.
2. The following menu will be displayed with, from left to right, icons to allow you to start from (a) the built-in hard disk drive 1, (b) the built-in hard disk drive 2, (c) the optical drive, (d) a floppy diskette drive, (e) the network and (f) USB Memory boot.



*Please note that a highlighted bar will only appear under the selected device.*

3. Use the left/right cursor keys to highlight the boot device you want and press **ENTER**.



*If a Supervisor Password has been set, manual boot device selection functions may be restricted.*

*The boot device selection methods described above will not change the boot priority settings that have been configured in HW Setup. In addition, if you press a key other than one of those listed, or if the selected device is not installed, the system will continue to boot according to the current and available settings in HW Setup.*

### **HDD Priority Options**

If more than one hard disk drive is installed in the computer, this option allows you to set the priority associated with hard disk drive detection - the first hard disk drive detected that has a valid boot command on it will be the device from which the computer will start.

---

**Built-in HDD1 ->** The priority is set as built-in HDD1 ->  
**Built-in HDD2 ->** built-in HDD2 -> USB (Default).  
**USB**

---

**Built-in HDD2 ->** The priority is set as built-in HDD2 ->  
**Built-in HDD1 ->** built-in HDD1 -> USB.  
**USB**

---

**Built-in HDD1 ->** The priority is set as built-in HDD1 ->  
**USB -> Built-in** USB -> built-in HDD2.  
**HDD2**

---

**Built-in HDD2 ->** The priority is set as built-in HDD2 ->  
**USB -> Built-in** USB -> built-in HDD1.  
**HDD1**

---

---

USB -> Built-in	The priority is set as USB -> built-in
HDD1 -> Built-in	HDD1 -> built-in
HDD2	HDD2.

---

USB -> Built-in	The priority is set as USB -> built-in
HDD2 -> Built-in	HDD2 -> built-in
HDD1	HDD1.

---



- *If a boot command is not found on the first detected hard disk drive, the system will not boot from next hard disk drive in the list, instead it will search for the next device in the Boot Priority list and startup from this as appropriate.*
- *Although, generally, most models have two hard disk drives installed, some models have only one hard disk drive. In the case of models with one hard disk drive, this setting item will not be displayed.*

### USB Memory BIOS Support Type

This option allows you to set the type of the USB memory to be used as a startup device.

---

<b>HDD</b>	Sets the USB memory to be the equivalent of a hard disk drive (default). With this setting, the USB memory device can be used to start the computer as though it were a hard disk drive based on the hard disk drive settings within both the Boot Priority and HDD Priority options detailed previously.
<b>FDD</b>	Sets the USB memory to be the equivalent of a floppy diskette drive. With this setting, the USB memory device can be used to start the computer as though it were a floppy diskette based on the floppy diskette drive settings within the Boot Priority option detailed previously.

---

## Keyboard

### Wake-up on Keyboard

When this feature is enabled, and the computer is in Sleep Mode, you can turn on the system by pressing any key. However, please be aware that this option will only work with the internal keyboard and only when the computer is in Sleep Mode.

---

<b>Enabled</b>	Enables the Wake-up on Keyboard function.
<b>Disabled</b>	Disables the Wake-up on Keyboard function (Default).

---

## CPU

This function allows you to set the processor's operating mode.

### Dynamic CPU Frequency Mode

This option allows you to configure the power saving modes associated with the processor - the following settings are available:

<b>Dynamically Switchable</b>	The processor's power consumption and automatic clock speed switching functions are enabled - in use the processor's operation is automatically switched when necessary (default).
<b>Always High</b>	The processor's power consumption and automatic clock speed switching functions are disabled - in use the processor will always run at its highest level of power consumption and its highest speed.
<b>Always Low</b>	The processor's power consumption and automatic clock speed switching functions are disabled - in use the processor will always run at a lower level of power consumption and a low speed.

## LAN

### Wake-up on LAN

This feature lets the computer's power be turned on when it receives a wake-up signal from the LAN.



*Do not install or remove a memory module while Wake-up on LAN is enabled.*



*The Wake-up on LAN function consumes power even when the system is off. Leave the AC adaptor connected while using this feature.*

Power will be automatically turned on when a signal is received from an administrator's computer which is connected via a network.

The following settings can be changed when the Built-in LAN is **Enabled**.

Connect the AC adaptor when using the Wake-up on LAN function. The battery retention time will be shorter than the times listed in this manual when this function is enabled. Refer to the section in chapter 6, [Retaining data with power off](#).

<b>Enabled</b>	Enables Wake-up on LAN (Default).
<b>Disabled</b>	Disables Wake-up on LAN.

### *Built-in LAN*

This feature enables or disables the Built-in LAN.

<b>Enabled</b>	Enables Built-in LAN functions (Default).
<b>Disabled</b>	Disables Built-in LAN functions.

### *Device Config*

#### *Device Configuration*

This option allows you to set how the computer's hardware devices will be configured.

<b>All Devices</b>	The computer's BIOS will setup and configure all devices.
<b>Setup by OS</b>	The operating system will setup and configure all of the devices that it can control (default).

### *USB*

#### *USB KB/Mouse Legacy Emulation*

You can use this option to enable or disable USB keyboard/mouse legacy emulation so that, even if your operating system does not support USB devices, you can still use a standard USB mouse and keyboard - to achieve this you should set the appropriate option(s) to Enabled.

<b>Enabled</b>	Enables the USB KB/Mouse Legacy Emulation function (Default).
<b>Disabled</b>	Disables the USB KB/Mouse Legacy Emulation function.

#### *USB-FDD Legacy Emulation*

Use this option to enable or disable USB floppy diskette drive legacy emulation. If your operating system does not support USB, you can still use a USB floppy diskette drive by setting the **USB-FDD Legacy Emulation** item to **Enabled**.

<b>Enabled</b>	Enables the USB floppy diskette drive legacy emulation function (Default).
<b>Disabled</b>	Disables the USB floppy diskette drive legacy emulation function.

## USB Sleep and Charge

Your computer can supply USB bus power (DC5V) to the USB port even when the power of the computer is turned OFF. "Power OFF" includes Sleep Mode, Hibernation Mode or shutdown state.

This function can be used for ports that support the USB Sleep and Charge function (hereinafter called "compatible ports").

Compatible ports are USB ports that have the (⚡) symbol icon.

You can use the "USB Sleep and Charge function" to charge certain USB-compatible external devices such as mobile phones or portable digital music players.

However, the "USB Sleep and Charge function" may not work with certain external devices even if they are compliant with the USB specification. In those cases, turn the power of the computer ON to charge the device.



- *When "USB Sleep and Charge function" is set to [Enabled], USB bus power (DC5V) will be supplied to compatible ports even when the power of the computer is turned OFF. USB bus power (DC5V) is similarly supplied to the external devices which are connected to the compatible ports. However, some external devices cannot be charged solely by supplying USB bus power (DC5V). As for the specifications of the external devices, please contact the device manufacturer or check the specifications of the external devices thoroughly before use.*
- *Using the USB sleep and charge function to charge external devices will take longer than charging the devices with their own chargers.*
- *If external devices are connected to compatible ports when the AC adaptor is not connected to the computer, the battery of the computer will be depleted even when the power of the computer is turned OFF. As such, we recommend that you connect the AC adaptor to the computer when using the USB sleep and charge function.*
- *External devices connected to the USB bus power (DC5V) function that interfaces with the power ON/OFF of the computer may always be in an operational state.*
- *When there is a current overflow of the external devices connected to the compatible ports, USB bus power (DC5V) supply may be stopped for safety reasons.*
- *When "USB Sleep and Charge function" is set to [Enabled], the "USB Wakeup function" does not work for compatible ports. In that case, if there is a USB port that does not have the USB Sleep and Charge function-compatible icon (⚡), attach the mouse or keyboard to it. If all USB ports have the USB Sleep and Charge function-compatible icon (⚡), change the "USB Sleep and Charge function" setting to [Disabled]. The "USB Wakeup function" will now work, but the "USB Sleep and Charge function" will be disabled.*



*Metal paper clips or hair pins/clips will generate heat if they come into contact with USB ports. Do not allow USB ports to come into contact with metal products, for example when carrying the computer in your bag.*

The default setting is [Disabled]. Changing the setting to [Enabled] enables the use of this function.

There are two modes, Mode1 and Mode2 in [Enabled]. For normal use, set the setting to Mode1.



*If the function does not work with Mode1 setting, change it to Mode2. Some external devices may not be able to use this function in either mode. When this happens, change the setting to [Disabled].*

<b>Enabled (Mode1)</b>	Enables USB Sleep and Charge function.
<b>Enabled (Mode2)</b>	Enables USB Sleep and Charge function.
<b>Disabled</b>	Disables USB Sleep and Charge function (Default).

## **Button Setting**

### **Start Up Logo**

This option lets you select from the following two types of logos which is displayed at computer start up.

<b>Animation</b>	The Logo appears as an animated image (Default).
<b>Picture</b>	The Logo appears as a static image.

### **Sound Logo**

Use this option to enable or disable sound to sound, when a personal computer is started.

<b>Enabled</b>	Enables sound to sound (Default).
<b>Disabled</b>	Disables sound to sound.





# Chapter 8

## AV functions

This chapter explains how to use the AV functions.



*The state where Windows Vista is active is referred to as Windows mode.*

## Media Center

This section describes the Media Center.



■ *You can record TV programs and pictures/movies from external input devices using the TV tuner. To do this, please use the recommended software below:*

*To record pictures/movies from external input devices:*

■ *Windows Media Center*

*You cannot use **Windows Movie Maker** or any other software for this purpose.*

Windows Vista has the following function.

- Watch TV or a DVD movie.
- Pause, rewind, and fast forward TV programs using the Media Center time shifting feature.
- Watch an instant replay.
- Play back your digital videos.
- View your digital pictures, or play them as a slide show.
- Browse, select, and play music CDs and DVD movies.
- Update the Television Program Guide from the Internet.
- Listen to FM radio

When the Media Center is going to be used, be sure that the computer is hooked up to an AC adaptor, and please use the AC power. If this is used under battery power, you are in danger of experiencing recording failures, sound fades, or frames being dropped from videos due to battery depletion.

For more information, refer to the manual in the Microsoft Windows Vista.

## Front operation panel

This section describes the panels of the front operation panel in Windows mode.



*Only touch the panels with your fingers. Do not press the panels too strongly, or use a ballpoint pen or any other pointed object to touch the panels. Doing so may damage the panels.*

Nine panels are available for use:

CD/DVD, Play/Pause, Stop, Previous, Next, MuteOn/Off, Illumination On/Off, Camera, DOLBY.

These panels allow you to manage Audio/Video functions, run applications and access utilities.



Figure 8-1 Front operation panel



### CD/DVD panel

Touching this panel will launch an application program that allows you to watch a DVD or listen to a CD.

Touching this panel while the computer is on or in Sleep Mode, will launch Media Center. My Music is started when a music CD is inserted in the optical disc drive and My Video is started when a DVD video is in the drive.

If the application you wish to run is not selected as the active window when these panels are touched, please switch to the application manually. For example, by clicking the taskbar item for the application window you wish to make active.



### Play/Pause panel

This panel allows you to play/pause chapters or tracks.



### STOP panel

Touch this panel to stop playing a track or chapter.



### Previous panel

Touch this panel to move to the previous audio track, DVD chapter or recorded data.



### Next panel

Touch this panel to move to the next audio track, DVD chapter or recorded data.



### Mute On/Off panel

Turns your computer sound on/off.

**Illumination On/Off panel**









Touch this panel to switch the lighting of indicators (e.g. Front operation panel, power button, volume dial, etc).

**Camera panel**

Touching this panel to launch an application program that allows to use a web camera.

**DOLBY**
**DOLBY panel**

Touching this panel, to display the windows of a Sound function.

Icon	Front operation panel	Windows Media Center		
		Media Center - My TV (TV)	Media Center - Play DVD (DVD)	Media Center - My Music (CD)
	CD/DVD	-	Run Media Center and play DVD	Run Media Center and start My Music
	Play/Pause	-	Play/Pause	Play/Pause
	Stop	-	Stop	Stop
	Previous	-	Previous chapter	Previous track
	Next	-	Next chapter	Next track
	Mute	Sound on/off	Sound on/off	Sound on/off
	Illumination On/Off	Switch the lighting of indicators		
	Camera	-	-	-
<b>DOLBY</b>	DOLBY	Display the windows of a Sound function		

## Remote controller

A remote controller, which is provided with some models, enables you to perform some functions of your computer from a distant location.

There are two different types of remote controllers:

Please refer to [Full size remote controller](#) of this chapter about the function of the button of a remote controller.

You can use your remote controller with Media Center to play CDs, DVDs and videos, to view pictures and to watch and record television programs.

The remote controller helps you navigate through Media Center just as a cable TV remote control navigates cable TV options or controls the playback of a movie in a VCR or DVD player.

Using the remote controller, you can:

- Navigate and control all Media Center windows.
- Control the video or live TV display.
- Place the computer in and out of Sleep Mode.

Refer to the [Using the remote controller](#) section in this chapter for information on how to use the remote controller as well as how to install and remove its batteries.

## Full size remote controller

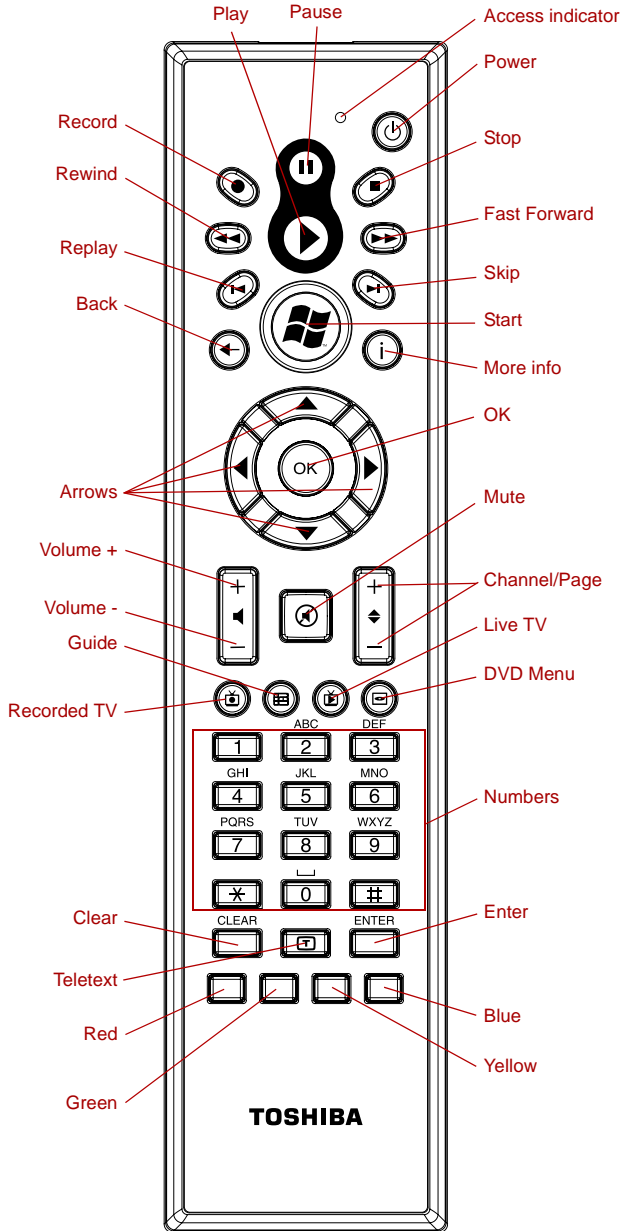

Figure 8-2 Full size remote controller

**Power**

Starts or terminates the operating system.

This button functions like the Power button of your computer. By default, the Sleep Mode is equivalent to the Power Off state of your computer. To change the setting, click **Start**, select **Control panel -> System and Maintenance -> Power Options**. When pressing the Power button, the following three options are available: Do nothing, Sleep and Hibernation.

**Access indicator**

This indicator will glow while the remote controller is sending signals to the computer. Please note that this indicator will not light after the battery has been completely discharged.

**Record**

Records the selected television program and stores it on your hard disk drive.

**Stop**

Stops the media currently playing.

**Pause**

Pauses an audio or video track, and live or recorded TV programs.

**Play**

Plays the selected media.

**REW (Rewind)**

Moves the media (video, DVD, music, and so on) backwards.

**FWD (Fast Forward)**

Moves the media (video, DVD, music, and so on) forwards.

**Replay**

Moves media backward (seven seconds for videos and live TV, one music track or one DVD chapter at a time).

**Skip**

Moves media forward (30 seconds for videos and live TV, one music track or one DVD chapter).

**Back**

Displays the previous window.

**More Info**

The button provides more details on a TV program than is listed in the Guide.

**Arrows**

Moves the cursor to navigate within Media Center windows.

OK

**OK** Selects the desired action or window option. It acts like the **ENTER** Key. If watching TV in full screen mode, pressing **OK** switches back to the previous viewed channel. Press again to toggle back. It acts the same way as a Jump button on some TV remote controls.

**Volume +** Increases the volume while watching TV, viewing DVD's or replaying CD's.

**Volume -** Decreases the volume while watching TV, viewing DVD's or replaying CD's.



**Start** Opens Media Center to the main window.

**Channel/Page up(+) and down(-)** Changes the TV channel or moves a page up and down, depending on the available options.



**Mute** Turns your computer sound on/off.



**Recorded TV** Allows you to start recording of TV programs. The Recorded TV feature of Media Center will be activated.



**Guide** Opens the Television Program Guide to display available TV channels and programs to watch and record.



**Live TV** A shortcut to the full screen view. It also takes you to the current point in a live TV program after pausing live TV.



**DVD Menu** Opens the main menu on a DVD movie, if available.

**Numbers** Allows you to select a channel or chapter number while watching TV, or CD/DVD replay. Numbers, letters or symbols can be entered. To select a channel or chapter number of two or more digits, press the buttons sequentially. For example, press the "1" button and then the "0" button to select the number 10.

**Clear** Deletes entered numbers, letters or symbols.

**Enter** The OK button on the remote controller has the same functions.

<b>Red, Green, Yellow and Blue buttons</b>	It jumps to a registration link. These buttons are not provided with some models.
<b>Teletext</b>	Starts or terminates the Teletext mode. This button is not provided with some models.

## Using the remote controller

Some computers include a remote control unit, which allows you to control some of your computer's functions from a distant location.



- *The remote controller is designed specifically for this computer.*
- *Some application programs may not support remote control functions.*

### Operational range of the remote controller

Point the remote controller at your computer and press a button. The operational angle and distance are described below.

<b>Distance</b>	Within 5 m from the infrared receiver window.
<b>Angle</b>	Within a 30 degree horizontal and 15 degree vertical range of the infrared receiver window.

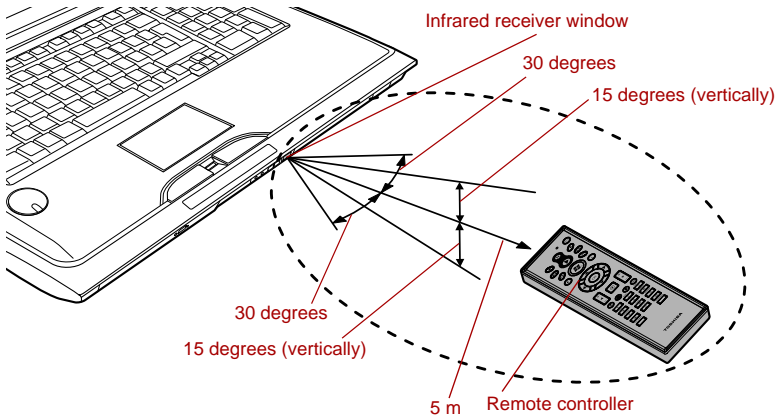

*Figure 8-3 Operational range of the remote control*

\* The appearance of the provided remote controller may vary from model to model.





*Even if within the effective scope as described above, the remote control may malfunction or not work correctly in the following cases.*

- *When an obstacle stands between the infrared receiver window of your computer and the remote controller.*
- *When direct sunlight or strong fluorescent light strikes the infrared receiver window.*
- *When the infrared receiver window or the infrared emission part of the remote controller is dirty.*
- *When other computers which use an infrared remote controller are used near to your computer.*
- *When a low battery condition is present*

## Installing/Removing batteries

Be sure to install the provided AA type batteries before using the remote controller.



*Store the battery for the remote control beyond the reach of children. If a child swallows a battery, this might result in choking. If it happens, contact a doctor immediately.*



*Observe the following precautions when using the battery of the remote controller.*

- *Do not use batteries other than those specified.*
- *Ensure that you insert the batteries with their polarities correctly aligned (+ or -).*
- *Do not recharge, heat, disassemble or short the battery, or put it into a fire or flame.*
- *Do not use a battery whose “recommended expiration date” has been reached, or which is completely discharged.*
- *Do not use different types of batteries or old and new batteries at the same time.*
- *Do not carry the battery together with metal necklaces, hairpins or other metal accessories.*
- *When storing or disposing of used batteries, make sure to put some insulation tape on their terminals (+ and -) to avoid short-circuits.*

*If these precautions are not followed, heating, fluid leakage or explosion may occur. This may cause burns or personal injury. If battery fluid gets on your skin or clothes, wash immediately with clean water. If battery fluid gets in your eyes, rinse your eyes with clean water immediately and see a doctor. Do not touch the battery fluid on instruments or devices with bare hands. Wipe off with a cloth or paper towel.*

## Full size remote controller

### ***Type of battery that can be used for the Full size remote controller***

When the batteries shipped with the remote controller are discharged, replace them with commercially available AA manganese batteries or AA alkaline batteries. Other types or battery should not be used.

### ***Installing the batteries***

1. Open the battery cover on the back of the Full size remote controller. Slide the cover in the direction of the arrow to remove the cover.

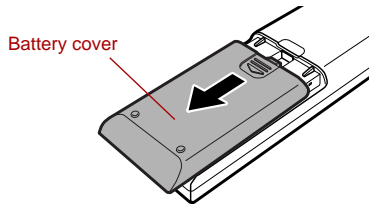

*Figure 8-4 Opening the battery cover*

2. Insert the batteries in place. Be sure to place the batteries with their polarities (+ and -) in the correct position.

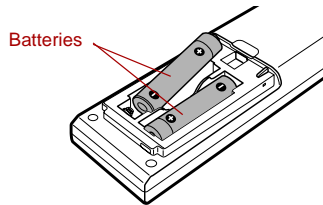

*Figure 8-5 Inserting the batteries*

3. Close the battery cover. Close the cover securely until it clicks.

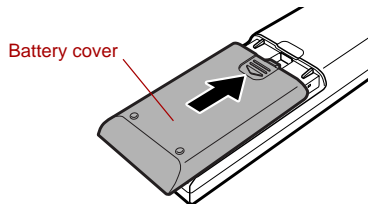

*Figure 8-6 Closing the battery cover*

## Replacing the batteries

When the batteries in the Full size remote controller reach the end of their life, the Full size remote controller may not operate correctly or work only within a short distance from your computer. In this instance, you should purchase new batteries and replace the discharged ones.

1. Open the battery cover on the back of the Full size remote controller.
2. Replace the batteries.  
Be sure to place the batteries with their polarities (+ and -) in the correct position.

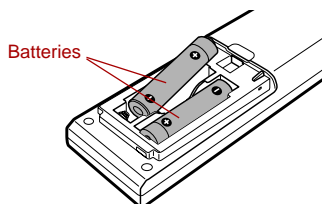

Figure 8-7 Removing the batteries

3. Close the battery cover.  
Close the cover securely until it clicks.

## Set-top box Connection Method and Watching TV on the Media Center

This section explains how to connect the set-top box and configure settings for watching TV.

Some models are equipped with a TV tuner.

### Connecting the set-top box

Connect the computer and set-top box using the following procedure to watch TV using the set-top box.



*The CATV cable and the coaxial cable are the separate sales.*

1. Connect the end of the infrared transmitter cable into the computer's infrared transmitter cable port.



*That the infrared remote control for your set-top box must be compatible in order to function.*

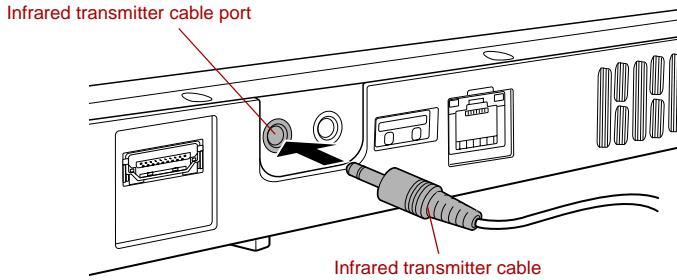

Figure 8-8 Connecting the infrared transmitter cable

2. Connect the other end of the infrared transmitter cable to a set-top box. It is placed in front of the infrared receiver window on the set-top box to allow the Full size remote controller to be used to change channels.
3. Connect the end of coaxial cable (1) to the TV antenna port of your computer. Refer to [Connecting the coaxial cable](#) section in Chapter 4, [Operating Basics](#), for details.
4. Connect the other end of the coaxial cable (1) to the Splitter Out port of a splitter.
5. Connect the end of the coaxial cable (2) to the Splitter In port of a splitter.
6. Connect the other end of the coaxial cable (2) to the Satellite Out port of a set-top box.
7. Connect the end of the CATV cable to the Satellite In port of a set-top box.
8. Connect the other end of the CATV cable to the wall socket.

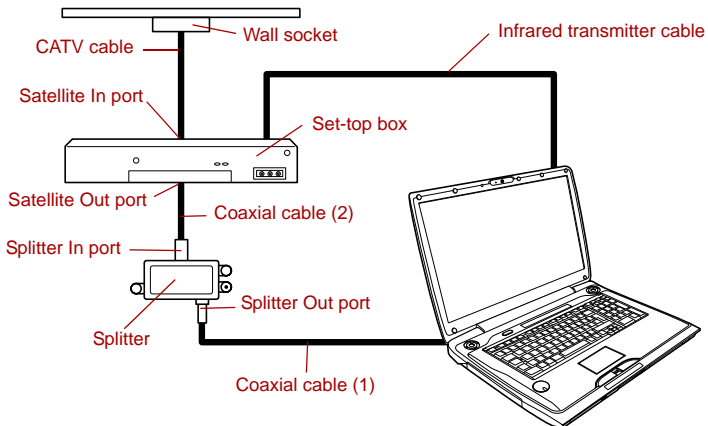

Figure 8-9 Connection method for the computer and set-top box

## Media Center Environment Settings

### Activating Media Center for the first time

1. Activate Media Center.

The setup screen appears. Configure settings according to your environment.

Follow the screen instructions and configure settings according to the environment used.

### Changing settings

Refer to the following procedures to change settings that are already configured.

1. Activate Media Center.
2. Click in the following order: click **Tasks** -> **settings** -> **TV** -> **Set Up TV Signal**.
3. The Set Up Your TV Signal window is displayed, and click **Next**.
4. Follow the screen instructions and configure settings according to the environment used.



*Image data cannot be imported, edited, watched or saved to DVD by connecting the Media Center model to external devices such as TV, video deck or analog video camera.*

## Listen to radio

This section describes how to set up and use of FM software to listen to radio.

### Setting FM software

1. Activate Media Center.
2. Click in the following order: click **Tasks** -> **settings** -> **TV** -> **Set Up TV Signal**.
3. Follow the wizard to select your region.
4. Select **I will manually configure my TV signal** in the **Automatic TV Signal Setup** screen.
5. Select **Antenna** in the **Select Your TV Signal** screen.

## Starting FM software

1. Activate Media Center.
2. To launch the FM software, scroll to **Music** and then click **radio** -> **FM Radio**.
3. The **FM radio** screen is displayed. To find a radio station, click - button or + button below the **Seek** or **Tune**. If you know the frequency of the station, enter the numbers.
4. To save the station which you found, click a **Save as Preset** button.
5. Enter the name of the station, and click a **Save** button.

## Changing of presets

1. Activate Media Center.
2. To launch the FM software, scroll to **Music** and then click **radio** -> **presets**.
3. Click a **preset** which you want to edit.
4. To find a radio station, click - button or + button below the **Tune**.
5. To save the station which you found, click a **Save as Preset** button.
6. To change the preset name, click an **Edit Preset**. Change the name of the station in the **Edit Preset** screen, and click a **Save** button.

## TOSHIBA DVD PLAYER

Please be aware of the following limitations when you use the TOSHIBA DVD PLAYER:

### Notes on use

- Frame dropping, audio skipping or out of synch audio and video may occur during playback of some DVD Video titles.
- Close all other applications when using the "TOSHIBA DVD PLAYER". Do not open any other applications or carry out any other operations during DVD Video playback. Playback may stop or not function properly in some situations.
- Unfinalized DVDs created on home DVD recorders may not be playable on the computer.
- Use DVD-Video discs with a region code which is either "the same as the factory default setting" or "ALL".
- Do not playback DVD discs Video while watching or recording television programs using other applications. Doing so may cause DVD Video playback or television program recording errors. In addition, if pre-scheduled recording starts during DVD Video playback it may cause DVD Video playback or television program recording errors. Please view DVD Video during times when there is no recording pre-scheduled.
- The resume function cannot be used with some discs on the "TOSHIBA DVD PLAYER".

- It is recommended the AC adaptor be connected when playing DVD-Video. Power saving features may interfere with smooth playback. When playing DVD-Video using battery power, set the Power Options to “High performance”.
- Screen savers will not display while playing a movie in the “TOSHIBA DVD PLAYER”. The computer will also not go into Sleep Mode, Hibernation Mode or shutdown while using “TOSHIBA DVD PLAYER”.
- Do not configure the Display automatic power off function to run while the “TOSHIBA DVD PLAYER” is running.
- Do not switch to Hibernation or Sleep Mode when running the “TOSHIBA DVD PLAYER”.
- Do not lock the computer using the **Windows logo** () + L keys or the **Fn + F1** keys when running the “TOSHIBA DVD PLAYER”.

## Display Devices & Audio

- “TOSHIBA DVD PLAYER” will only run when “Colors” is set to “Highest (32 bit)”. The “Colors” setting can be adjusted on the “Monitor” tab in the “Display Settings”. To open the Display Settings, click **Start -> Control Panel -> Appearance and Personalization -> Personalization -> Display Settings**.
- If the DVD Video image is not displayed on an external display or television, stop the “TOSHIBA DVD PLAYER”, and change the screen resolution in “Resolution” on the “Monitor” tab in the “Display Settings”. However, video cannot be output to some external displays and televisions due to output or playback conditions.
- When viewing DVD-Video on an external display or TV, change the display device before playing. DVD-Video cannot be displayed simultaneously (in clone mode) on both the computer’s display panel and an external display.
- Do not change the screen resolution while running the “TOSHIBA DVD PLAYER”.

## TOSHIBA DVD PLAYER

- “TOSHIBA DVD PLAYER” software is supported for playback of DVD-Video and DVD-VR.
- The “TOSHIBA DVD PLAYER” does not have a parental control function.
- In order to protect copyrights, the Windows Print Screen function is disabled when “TOSHIBA DVD PLAYER” is running.
- (Print Screen functions are disabled even when running other applications besides “TOSHIBA DVD PLAYER” and when “TOSHIBA DVD PLAYER” is minimized.) Please close the “TOSHIBA DVD PLAYER” to use the Print Screen function.
- Carry out the installation/uninstallation of the “TOSHIBA DVD PLAYER” under a user account with administrator rights.

- Do not change Windows Users while “TOSHIBA DVD PLAYER” is running.
- For some DVD Video discs, using the control window to change the audio track will also change the subtitle track.

## Starting TOSHIBA DVD PLAYER

Use the following procedure to start “TOSHIBA DVD PLAYER”.

1. Insert an DVD-Video in the DVD Super Multi drive while Windows Vista is running.

When an DVD-Video disc is set in the DVD drive, the following application selection screen may appear.

If this occurs, select **Play DVD movie**, then click **OK** to launch the **TOSHIBA DVD PLAYER**.

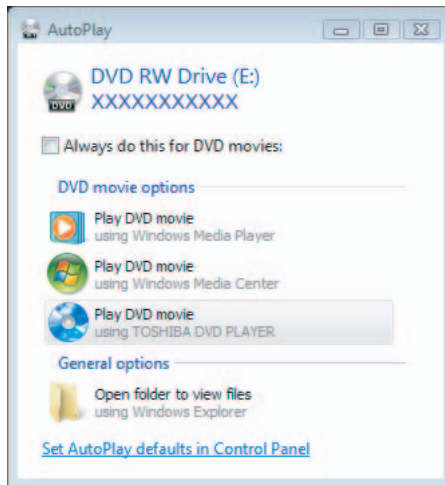

*Figure 8-10 Application selection screen*

2. Touch the **CD/DVD** panel on the Front operation panel.  
Or select **Start -> All Programs -> TOSHIBA DVD PLAYER -> TOSHIBA DVD PLAYER** to start “TOSHIBA DVD PLAYER”.

## Operating TOSHIBA DVD PLAYER

Notes on Using “TOSHIBA DVD PLAYER”.

- Screen display and available features may vary amongst DVD-Videos and scenes.
- Only operation buttons (including remote controller and Front operation panels) which correspond to currently available and active features will be useable during DVD playback.
- If the menu is opened in the Display Area using the Control window's Top Menu or Menu buttons, touch pad and mouse menu operations may not be able to be used.



## Open TOSHIBA DVD PLAYER HELP

TOSHIBA DVD PLAYER features and instructions are also explained in detail in “TOSHIBA DVD PLAYER Help”.

Use the following procedure to open “TOSHIBA DVD PLAYER Help”.

- Click the “Help” button (  ) in the Display Area.

## Restrictions on TOSHIBA DVD PLAYER with upconvert feature

- When upconvert feature is enabled, titles that can be played and/or features that can be used are limited.
- Upconvert feature plays video using “TOSHIBA Quad Core HD Processor”
- Upconvert feature cannot be used when other application is using “TOSHIBA Quad Core HD Processor”
- Please make sure to use AC adapter when playing with up-convert feature enabled
- To view the video using upconvert feature on an external display or TV, display device or TV with HDCP support which has a HDMI input port is needed.
- Upconvert video can be displayed only on LCD display of main body or TV connected to HDMI output port.
- The video cannot be displayed on TV connected to S-Video output connector or external display connected to RGB connector



# Chapter 9

## Optional Devices

Optional devices can expand the computer's capabilities and its versatility. This chapter describes the connection or installation of the following devices which should be available from your reseller or TOSHIBA dealer:



*To connect optional devices (such as USB device or External monitor) to the computer, be sure to check the shape and orientation of the connector before connecting.*

### **Cards/memory**

- ExpressCard
- Bridge media slot
  - Secure Digital™ (SD) Card (SD memory card, SDHC memory card, miniSD Card, microSD Card)
  - Memory Stick (Memory Stick, Memory Stick Duo, Memory Stick PRO, Memory Stick PRO Duo)
  - xD picture card
  - MultiMediaCard
- Memory expansion

### **Power devices**

- Battery packs
- Universal AC Adaptor
- Battery Charger

### **Peripheral devices**

- Hard disk drive pack
- USB
  - USB FDD Kit
- eSATA
- External monitor
- HDMI
- i.LINK (IEEE1394)

### **Other**

- Security lock

## ExpressCard

The computer is equipped with a single ExpressCard slot into which any ExpressCard device that meets industry standards, either manufactured by TOSHIBA or another vendor, can be installed. The slot supports hot plug connection and utilizes the PCI Express interface that supports the reading and writing of data at a theoretical maximum rate of 2.5Gbps.

Slim size remote controller is contained in the ExpressCard slot. Some models are equipped with a Slim size remote controller.

### Inserting an ExpressCard

The Windows hot-install feature allows you to insert ExpressCards while the computer is turned on.



*Do not insert an ExpressCard while the computer is in Sleep Mode or Hibernation Mode as you may find that some cards do not work properly.*

To insert an ExpressCard, follow the steps as detailed below:



*In order to use the computer's ExpressCard slot, open the left side cover. Open the cover by pressing the top right section of the cover to unlock it.*

1. Insert the ExpressCard into the ExpressCard slot on the side of the computer.
2. Press the ExpressCard gently to ensure a firm connection is made.

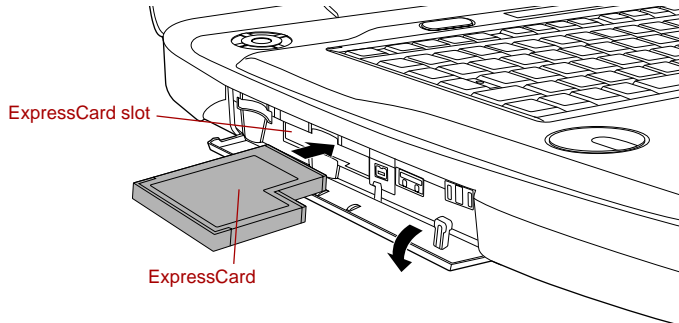

*Figure 9-1 Inserting the ExpressCard*

3. After inserting the ExpressCard you should refer to its documentation and also check the configuration in Windows in order to ensure that it is correct.

## Removing an ExpressCard

To remove an ExpressCard, follow the steps as detailed below.

1. Open the **Safely Remove Hardware** icon on the Windows Taskbar.
2. Point to **ExpressCard** and click the left Touch Pad control button.
3. Grasp the ExpressCard and remove it.

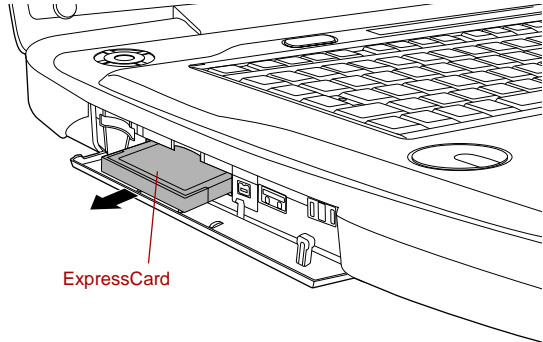

Figure 9-2 Removing the ExpressCard



Press gently until the cover clicks into place.

## Bridge media slot

The computer is equipped with a Bridge media slot that can accommodate some kinds of memory media with various memory capacities so that you can easily transfer data from devices, such as digital cameras and Personal Digital Assistants.



Keep foreign objects out of the Bridge media slot. Never allow metal objects, such as screws, staples and paper clips, to enter the computer or Keyboard. Foreign metal objects can create a short circuit, which can cause computer damage and fire, possibly resulting in serious injury.



- This Bridge media slot supports the following memory media.
  - Secure Digital (SD) Card (SD memory card, SDHC memory card, miniSD Card, microSD Card)
  - Memory Stick (Memory Stick, Memory Stick Duo, Memory Stick PRO, Memory Stick PRO Duo)
  - xD picture card
  - MultiMediaCard (MMC™)
- Please note that an adaptor is required to use miniSD/microSD Card.
- Please note that an adaptor is required to use Memory Stick Duo/ Memory Stick PRO Duo.
- Please note that not all memory media have been tested and verified to work correctly. Therefore, it is not possible to guarantee that all memory media will operate properly.
- The slot does not support Magic Gate functions.

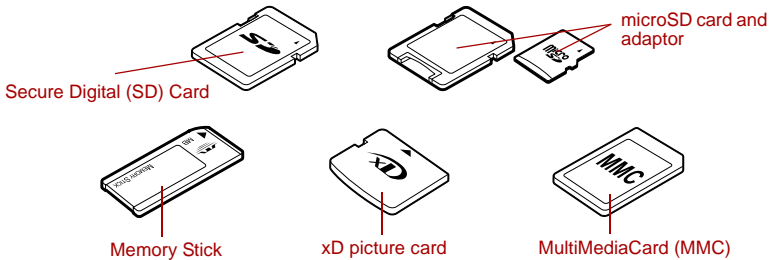

Figure 9-3 Examples of memory media

## Memory media

This section provides the important safety precautions in order to handle your memory media.



### **Points to note about the SD/SDHC memory card**

SD/SDHC memory cards comply with SDMI (Secure Digital Music Initiative), which is a technology adopted to prevent unlawful copy or playback of digital music. For this reason, you cannot copy or playback protected material on another computer or other device, and you may not reproduce any copyrighted material except for your personal enjoyment.

Below is a simple explanation for distinguishing SD memory cards from SDHC memory cards.

- SD and SDHC memory cards appear the same externally.
- The logo on SD and SDHC memory cards is different, so pay careful attention to the logo when purchasing.



- The SD memory card logo is (  ).
- The SDHC memory card logo is (  ).

- The maximum capacity of SD memory cards is 2GB. The maximum capacity of SDHC memory cards is 16GB.

Card Type	Capacities
SD	8MB, 16MB, 32MB, 64MB, 128MB, 256MB, 512MB, 1GB, 2GB
SDHC	4GB, 8GB, 16GB

### **Memory media format**

New media cards are formatted according to specific standards. If you wish to reformat a media card, be sure to do so with a device that uses media cards.

#### **Formatting an SD/SDHC memory card**

SD/SDHC memory cards are sold already formatted in conformity to specific standards. If you format the SD/SDHC memory card again, be sure to format it with the TOSHIBA SD Memory Card Format utility, not with the format command provided within Windows.

In order to run the TOSHIBA SD Memory Card Format utility, click **Start -> All Programs -> TOSHIBA -> Utilities -> SD Memory Card Format**.



*The TOSHIBA SD Memory Card Format utility does not format the protected area of the SD/SDHC memory card - should you need to format all areas of the memory card, including the protected area, you will need to obtain an appropriate application that applies the copy protection system.*

### **Media care**

Observe the following precautions when handling the card.

#### **Card care**

- Do not twist or bend cards.
- Do not expose cards to liquids or store in humid areas or lay media close to containers of liquid.
- Do not touch the metal part of a card or expose it to liquids or let it get dirty.
- After using card, return it to its case.
- The card is designed so that it can be inserted only one way. Do not try to force the card into the slot.
- Do not leave a card partially inserted in the slot. Press the card until you hear it click into place.

## Memory card care

- Set the write-protect switch to the lock position, if you do not want to record data.
- Memory cards have a limited lifespan, so it is important to backup important data.
- Do not write to a card if the battery power is low. Low power could affect writing accuracy.
- Do not remove a card while read/write is in progress.



*For more details on using memory cards, see manuals accompanying the cards.*

## About the write-protect

The following memory media have a function for protect.

- SD Card (SD memory card, SDHC memory card)
- Memory Stick (Memory Stick, Memory Stick Duo, Memory Stick PRO, Memory Stick PRO Duo)
- MultiMediaCard (MMC)



*Set the write-protect switch to the lock position, if you do not want to record data.*

## Inserting a memory media

The following instructions apply to all types of supported media devices. To insert a memory media, follow the steps as detailed below:



*In order to use the computer's Bridge media slot, open the left side cover. Open the cover by pressing the top right section of the cover to unlock it.*

1. Turn the memory media so that the contacts (metal areas) are face down.
2. Insert the memory media into the Bridge media slot on the side of the computer.
3. Press the memory media gently to ensure a firm connection is made.

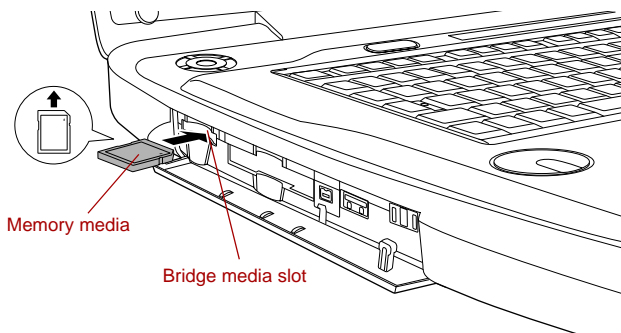

*Figure 9-4 Inserting a memory media*





- *Make sure memory media is oriented properly before you insert it. If you insert the media in wrong direction, you may not be able to remove it.*
- *When inserting memory media, do not touch the metal contacts. You could expose the storage area to static electricity, which can destroy data.*
- *Do not turn the computer off or switch to Sleep Mode or Hibernation Mode while files are being copied - doing so may cause data to be lost.*

## Removing a memory media

The following instructions apply to all types of supported media devices. To remove a memory media, follow the steps as detailed below:

1. Open the **Safely Remove Hardware** icon on the Windows Taskbar.
2. Point to **memory media** and click the left Touch Pad control button.
3. Press the memory media to partially extend it out of the computer.
4. Grasp the media and remove it.

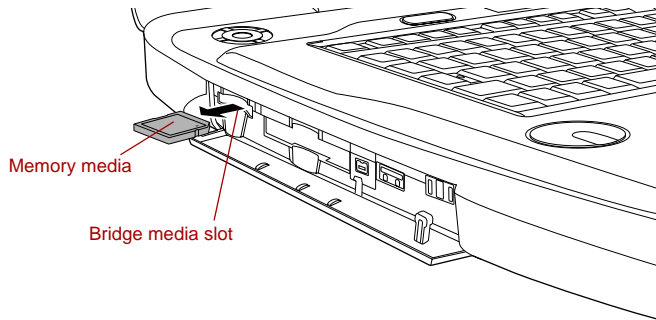

Figure 9-5 Removing memory media



Press gently until the cover clicks into place.



- *Make sure the **Bridge Media slot** indicator is out before you remove the memory media or turn off the computer's power. If you remove the memory media or turn off the power while the computer is accessing the memory media, you may lose data or damage the media.*
- *Do not remove the memory media while the computer is in Sleep or Hibernation Mode. The computer could become unstable or data in the memory media could be lost.*
- *Do not remove only the miniSD/microSD Card while leaving the adaptor in the Bridge Media slot.*

## Additional memory module

You can install additional memory into the computer in order to increase the amount of system memory that is available. This section describes how to install and remove optional memory modules.



- *You should place a mat beneath the computer in order to prevent the computer's lid from becoming scratched or damaged when you are installing/replacing the memory module. In this instance you should avoid mats that are made of materials that hold or generate static electricity.*
- *When installing or removing a memory module, you must ensure that you do not touch any other internal areas of the computer.*
- *Insert the two memory modules into Slot A and Slot B respectively. The computer will operate in dual channel mode. You can access the inserted memory modules efficiently in dual channel.*



- *Use only memory modules approved by TOSHIBA.*
- *Do not try to install or remove a memory module under the following conditions.*
  - a. *The computer is turned on.*
  - b. *The computer was shut down in either Sleep or Hibernation Mode.*
  - c. *Wake-up on LAN is enabled.*
  - d. *The wireless communication switch is turned on.*
- *Be careful not to let screws or other foreign matter fall into the computer. It could cause malfunction or electric shock.*
- *Additional memory module is a precision electronic component that may be fatally damaged by static electricity. Since the human body can carry static electricity, it is important that you discharge yourself before touching or installing any additional memory modules. To discharge your body's static electricity, simply touch any metal close to you with bare hands.*
- *In order to ensure that the computer power is not turned on while working, set the Wireless communication switch to OFF.*

## Point to note about memory module error

If you install a memory module that is not compatible with the computer, the **Power** indicator will flash (on for 0.5 seconds, off for 0.5 seconds) in the following ways;

- If there is an error in only Slot A or no memory module is inserted in Slot A: repeatedly flashes orange twice, then white.
- If there is an error in Slot B: repeatedly flashes orange, then white twice.
- If there are errors in both Slot A and Slot B: repeatedly flashes orange twice, then white twice.

In all instances you should shut down the computer and remove the incompatible module(s).



*Use a point size 0 Phillips screwdriver to remove and fasten the screws - the use of an incorrect screwdriver can damage the screw heads.*

## Installing a memory module

The computer contains slots for two memory modules, one positioned immediately over the other - the procedures are the same for installing either module.

1. Shut down the computer - make sure the **Power** indicator is off (refer to the [Turning off the power](#) section in Chapter 3, [Getting Started](#), if required).
2. Remove the AC adaptor and all cables and peripherals connected to the computer.
3. Close the display panel.
4. Turn the computer upside down and remove the battery pack (refer to [Replacing the battery pack](#) section in Chapter 6, [Power](#), if required).
5. Loosen the screw securing the memory module cover in place - please note that this screw is attached to the cover in order to prevent it from being lost.
6. Slide your fingernail or a thin object under the cover and lift it off.

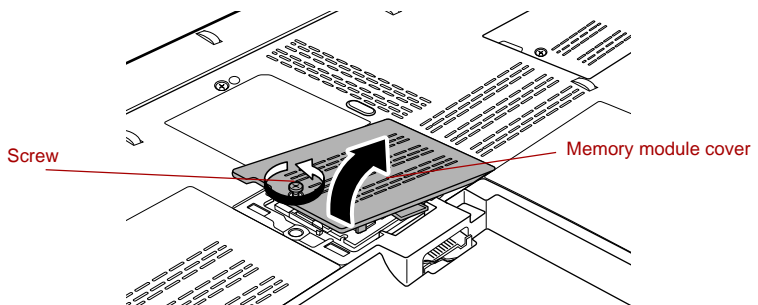

*Figure 9-6 Removing the memory module cover*

- Align the notch of the memory module with that of the memory module slot and gently insert the module into the slot at about a 45 degree angle before holding it down until the latches on either side snap into place.

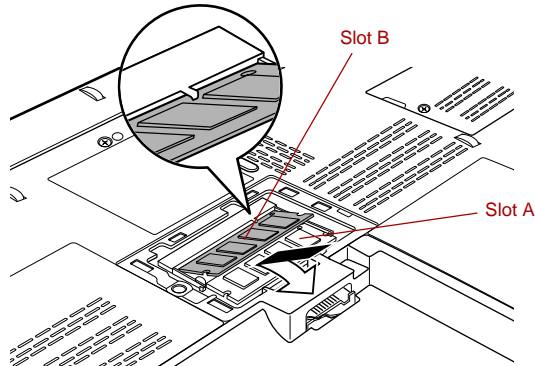

Figure 9-7 Seating the memory module



- Slot A is reserved for the first memory module. Use slot B for expansion memory modules. If only one module is installed, use slot A.
- When inserting or removing memory modules, make sure to use the correct slot (A or B). On this computer the lower slot is slot A.
- Align the grooves along the edges of the memory module with the locking tabs on the connector and insert the memory module into the connector firmly - if you find it difficult to install the memory module, gently prise the locking tabs outwards using the tip of your finger. Please also ensure that you hold the memory module along its left and right hand edges - the edges with the grooves in.



- Never allow metal objects, such as screws, staples and paper clips, to enter the computer or keyboard. Foreign metal objects can create a short circuit, which can cause computer damage and fire, possibly resulting in serious injury.
- Do not touch the connectors on the memory module or on the computer. Debris on the connectors may cause memory access problems.

8. Seat the memory module cover in place and secure it with one screw.



*Take care to ensure that the memory module cover is firmly closed.*

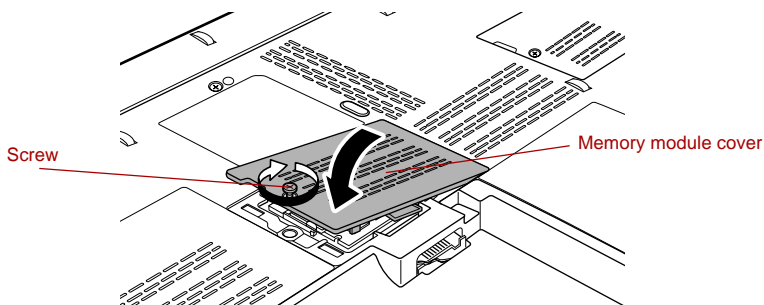

*Figure 9-8 Seating the memory module cover*

9. Install the battery pack - refer to [Replacing the battery pack](#) section in Chapter 6, [Power](#), if required.
10. Turn your computer over.
11. Turn the computer on and make sure the added memory is recognized - to confirmed it, **Start** -> **Control Panel** -> **System and Maintenance** -> **System** icon.

## Removing a memory module



*The slot A is reserved for main memory. Use the slot B for expanded memory. If only one card is installed, use the slot A.*

To remove the memory module, follow the steps as detailed below:

1. Shut down the computer - make sure the **Power** indicator is off (refer to the [Turning off the power](#) section in Chapter 3, [Getting Started](#), if required).
2. Remove the AC adaptor and all cables and peripherals connected to the computer.
3. Close the display panel.
4. Turn the computer upside down and remove the battery pack (refer to [Replacing the battery pack](#) section in Chapter 6, [Power](#), if required).
5. Loosen the screw securing the memory module cover in place - please note that this screw is attached to the cover in order to prevent it from being lost.
6. Slide your fingernail or a thin object under the cover and lift it off.
7. Push the latches away from the module in order to release it - a spring will force one end of the module up at an angle.

8. Grasp the memory module by its edges and remove it from the computer.



- *If you use the computer for a long time, the memory modules and the circuits locating close to the memory modules will become hot. In this case, let them cool to room temperature before you replace them. Or you will get burnt if you touch any of them.*
- *Do not touch the connectors on the memory module or on the computer. Debris on the connectors may cause memory access problems.*

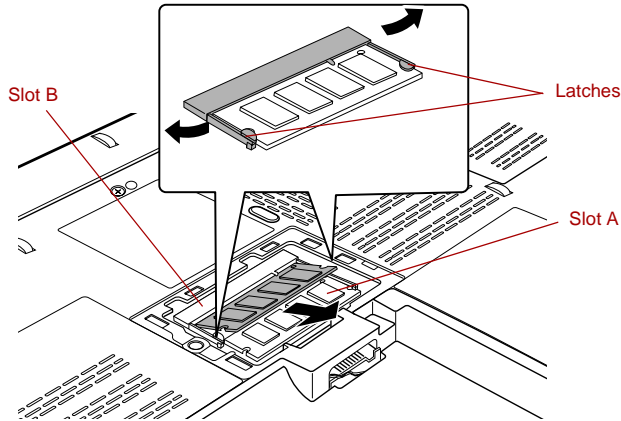

*Figure 9-9 Removing the memory module*

9. Seat the memory module cover in place and secure it with one screw.



*Take care to ensure that the memory module cover is firmly closed.*

10. Install the battery pack - refer to [Replacing the battery pack](#) section in Chapter 6, [Power](#), if required.
11. Turn your computer over.

## Battery Packs

You can increase the portability of the computer with additional battery packs so that, if you're away from an AC power source and your battery runs low, you can replace it with a freshly charged battery. Please refer to Chapter 6, [Power](#), for further information.

## Universal AC Adaptor

If you frequently use your computer at more than one site, it may be convenient to purchase an additional AC adaptor to be kept at each site in order to remove the need to always carry the adaptor with you.

## Battery Charger

The battery charger provides a convenient way to charge up to two Lithium Ion battery packs without requiring the use of your computer.

## USB

The computer is equipped with Universal Serial Bus ports that can accommodate compatible devices.

These ports comply with the USB 2.0 standard.

### USB FDD Kit

The USB floppy diskette drive accommodates either a 1.44MB or 720KB a 3 2/1" floppy diskette and connects to one of the computer's USB ports.



*The USB floppy diskette drive is available only as an option.*

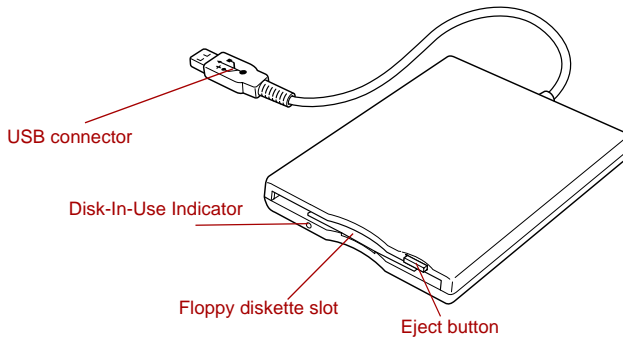

*Figure 9-10 USB floppy diskette drive*

<b>USB connector</b>	Insert this connector into one of the free USB ports of your computer.
<b>Disk-In-Use Indicator</b>	This indicator glows when the floppy diskette is being accessed.
<b>Floppy diskette slot</b>	Insert a floppy diskette into this slot.
<b>Eject button</b>	When a floppy diskette is fully seated in the drive, the eject button will pop out. In order to remove the diskette, push the eject button in order to cause it to partially pop out of the drive and then remove it.



Check the **Disk-In-Use** indicator when you use the floppy diskette drive. Do not press the eject button or turn off the computer while the light is glowing. Doing so could destroy data and damage the floppy diskette or the drive.



In use, the following should be noted regarding the operation of the USB floppy diskette drive:

- The drive should be placed on a flat, horizontal surface.
- Do not set the drive on an incline greater than 20° while it is operating.
- Do not place anything on top of the drive.

### **Connecting the USB floppy diskette drive**

To connect the drive, plug the floppy diskette drive's USB connector into a computer's free USB ports.



Make sure the connector is properly aligned with the socket. Do not try to force the connection, doing so can damage the connecting pins.

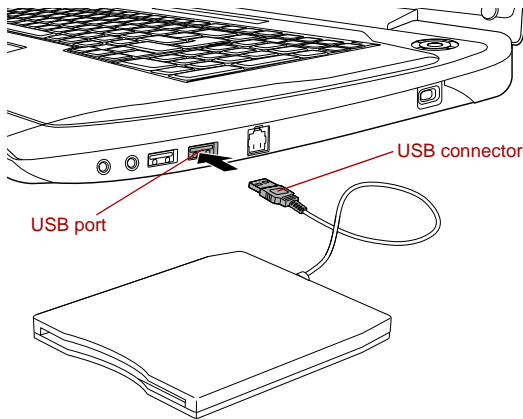

*Figure 9-11 Connecting the USB floppy diskette drive*



If you connect the USB floppy diskette drive after the computer has already been turned on, it will take about ten seconds for it to be recognized by the computer. Do not attempt to disconnect and reconnect the drive before this period has elapsed.



## Disconnecting the USB floppy diskette drive

When you have finished using the USB floppy diskette drive, you can follow the procedures below in order to disconnect it:

1. Wait for the Disk-In-Use Indicator light to go out to make sure all floppy diskette activity has stopped.



*If you disconnect the USB floppy diskette drive or turn off the power while the computer is accessing the drive you may lose data or damage the floppy diskette or the drive.*

2. Click the **Safely Remove Hardware** icon on the Windows taskbar.
3. Click the USB floppy diskette drive device that you want to remove.
4. Carefully pull the floppy diskette drive's USB connector out from within the computer's USB port.

## eSATA (External Serial ATA)

An device corresponding to eSATA function can be connected to the eSATA/USB combo port on the computer.

### Connecting the eSATA device

To connect an eSATA device, follow the steps as detailed below:

1. Connect an eSATA cable to the eSATA/USB combo port.



*Make sure the connector is properly aligned with the socket. Do not try to force the connection, doing so can damage the connecting pins.*

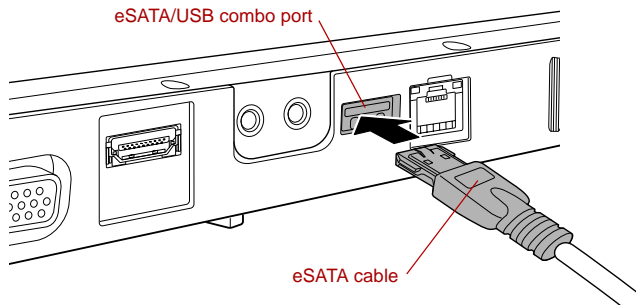

*Figure 9-12 Connecting an eSATA cable to the eSATA/USB combo port*



- A connected eSATA device may not be recognized if it is connected to the computer's eSATA/USB combo port while the computer is in Sleep Mode or Hibernation Mode. If this occurs, disconnect the eSATA device and then reconnect the device while the computer is turned on.
- If you connect an eSATA device after the computer has already been turned on, it will take about ten seconds for it to be recognized by the computer.
- Do not attempt to disconnect and reconnect the drive before this period has elapsed.

## Disconnecting an eSATA device

When you have finished using an eSATA device, you can follow the procedures below in order to disconnect it:

1. Wait for the indicator light of an eSATA device to go out to make sure all activity has stopped.



*If you disconnect an eSATA device or turn off the power while the computer is accessing the drive you may lose data or damage an eSATA device or the drive.*

2. Click the **Safely Remove Hardware** icon on the Windows Taskbar.
3. Click an eSATA device that you want to remove.
4. Carefully pull an eSATA device's eSATA/USB combo connector out from within the computer's eSATA/USB combo port.

## External monitor

An external analog monitor can be connected to the external monitor port on the computer. To connect a monitor, follow the steps as detailed below:

1. Turn the computer's power off.
2. Connect the monitor cable to the external monitor port.

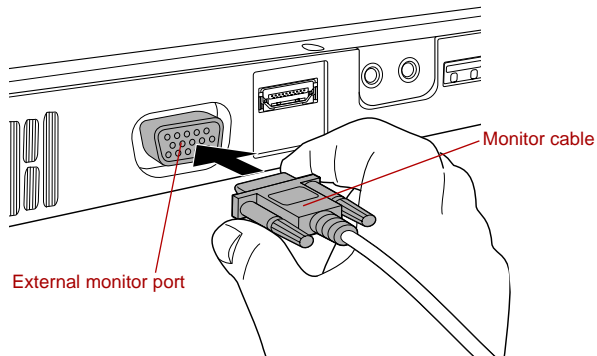

*Figure 9-13 Connecting the monitor cable to the external monitor port*

3. Turn the external monitor's power on.
4. Turn the computer's power on.

When you turn on the power, the computer will automatically recognize the monitor and determine whether it is a color or monochrome device. In the event that you find that there are issues getting an image displayed on the correct monitor, you should consider using the **FN + F5** hot key to change the display settings (if you then disconnect the external monitor before you turn the computer's power off, be sure to press **FN + F5** hot key again to switch to the internal display).

Please refer to Chapter 5, *The Keyboard*, for further details on using hot keys to change the display setting.



*Do not disconnect the external monitor while in Sleep or Hibernation Mode. Turn off the computer before disconnecting the external monitor.*

## HDMI

A HDMI monitor can be connected to the HDMI out port on the computer. To connect monitor, follow the steps as detailed below:



*As the port operation of all HDMI (High-Definition Multimedia Interface) monitors have not been confirmed, some HDMI monitors may not function properly.*

### Connecting the HDMI out port

1. Plug one end of the HDMI cable into the HDMI out port of the HDMI device.

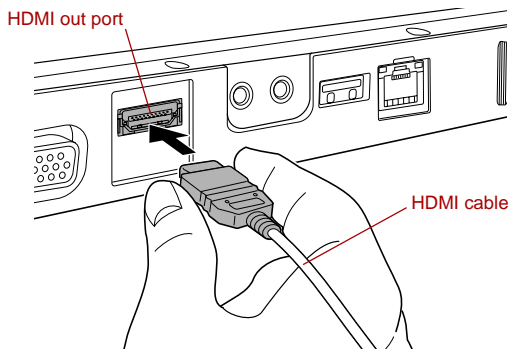

*Figure 9-14 Connecting the HDMI out port*

2. Plug the other end of the HDMI cable into the HDMI out port on your computer.



*When connecting or disconnecting an HDMI device to or from the computer, only do so when the computer is turned on or when the computer is completely turned off. Do not do so when the computer is in Sleep Mode or Hibernation Mode.*

## Settings for display video on HDMI

To view video on the HDMI device, be sure to configure the following settings otherwise you may find that nothing is displayed.



- *Be sure to use the **FN + F5** HotKey to select the display device before starting to play video. Do not change the display device while playing video.*
- *Do not change the display device under the following conditions.*
  - *While data is being read or written.*
  - *While communication is being carried out.*

## Select HD Format

To select the display mode, follow the steps as detailed below:

1. Click **Start** and click **Control Panel**.
2. Click **Appearance and Personalization**.
3. Click **Personalization**.
4. Click **Display Settings**.
5. Click **Advanced Settings**.
6. Click **List All Modes**.
7. Select the one of the below selection at “**List All Modes**”.

Display mode at “List All Modes”	HD Format
1920 by 1080, True Color (32bit), 60Herts	1080p
1920 by 1080, True Color (32bit), 30Herts (Interlaced)	1080i
1280 by 720, True Color (32bit), 60Herts	720p
720 by 576, True Color (32bit), 50Herts	576p
720 by 480, True Color (32bit), 60Herts	480p



*The above display mode is a typical HDMI display mode. The selectable display modes will vary for different HDMI monitors.*

## REGZA Link (PC Control)

HDMI out port can connect with Type A connector HDMI cable.

One HDMI cable can send and receive video, audio and control signals.

HDMI-CEC (Consumer Electronics Control) is a standard in the CE Industry which allows devices to work together over an HDMI cable.

By connecting a TV which supports HDMI Control to this port, the remote control for the connected TV can be used to operate some of the computer functions.



*Some models are supported with the REGZA Link (PC Control).*

### Using REGZA Link (PC Control)

Toshiba notebooks with REGZA Link (PC Control) include a Toshiba utility dedicated to take advantage of its capabilities which can allow you to:

- Use the TV remote control to output the computer screen onto the TV screen.
- Use the TV remote control to launch, operate and close applications on your computer.
- Turn on the TV when the HDMI output is selected using the **Fn + F5** key.
- Switch the video output (HDMI or LCD) when executing certain desktop icons.
- Enable/Disable the REGZA Link (PC Control) function on the computer.

## i.LINK (IEEE1394)

i.LINK (IEEE1394) is used for high-speed data transfer for a range of compatible devices such as:

- Digital video cameras
- Hard disk drives
- Magneto Optical drives
- Writable optical disc drives



*i.LINK uses a four-pin connector, which does not carry any electric current. External devices will need their own power supply to operate.*

### Precautions

- Make a back-up of your data before transferring it to the computer. There is a possibility that the original data will be damaged. There is a particular risk that some frames will be deleted in the case of digital video transfer. TOSHIBA assumes no liability for such loss of data.
- Do not transfer data in areas where static electricity is easily generated or in areas subjected to electronic noise. Data can be destroyed.

- If you are transferring data through an IEEE1394 hub, do not connect or disconnect other devices from the hub during data transfer. There is a likelihood that data will be damaged. Connect all devices to the hub before you turn on the computer's power.
- You may not use any copyrighted video or music data copied from a video camera except for your personal enjoyment.
- If you connect/disconnect an i.LINK device to/from another i.LINK device that is currently exchanging data with the computer, data frames might be dropped.
- Make sure data transfer has ended or turn off the computer, before you:
  - Connect/disconnect an i.LINK device to/from the computer.
  - Connect/disconnect an i.LINK device to/from another i.LINK device that is connected to the computer.

## Connecting the i.LINK (IEEE1394) cable

To connect the i.LINK (IEEE1394) cable, follow the steps as detailed below:



*In order to use the computer's i.LINK (IEEE1394) port, open the left side cover. Open the cover by pressing the top right section of the cover to unlock it.*

1. Make sure the connectors are properly aligned and plug the i.LINK (IEEE1394) cable into the computer.

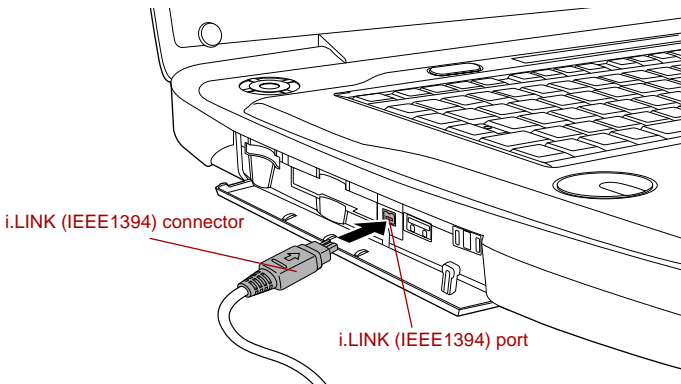

*Figure 9-15 Connecting the i.LINK (IEEE1394) cable into the computer*

2. Plug the other end of the cable into the device.

Note the following when you use i.LINK:

- You may need to install drivers for your i.LINK devices.
- Not all i.LINK devices have been tested. Therefore, compatibility with all i.LINK devices cannot be guaranteed.
- Some devices might not support sleep or automatic off functions.
- Do not connect or disconnect an i.LINK device while it is using an application or when the computer is automatically shutting it down to save power. Data might be destroyed.

## Disconnecting the i.LINK (IEEE1394) cable

To disconnect the i.LINK (IEEE1394) cable, follow the steps as detailed below:

1. Open the **Safely Remove Hardware** icon on the Windows Taskbar.
2. Point to **i.LINK (IEEE1394) device** and click.
3. Disconnect the cable from the computer then from the i.LINK device.



- Press gently until the cover clicks into place.
- Refer also to the documentation that came with your i.LINK device.

## Security lock

A security locks enable you to anchor your computer a desk or other heavy object in order to help prevent unauthorized removal or theft. The computer has a security lock slot on its right side into which you can attach one end of the security cable, while the other end attaches to a desk or similar object. The methods used for attaching security cables differ from product to product. Please refer to the instructions for the product you are using for more information.

### Connecting the security lock

In order to connect a security cable to the computer, follow the steps as detailed below:

1. Turn the computer so its right hand side faces you.
2. Align the security cable with the “lock hole” and secure it in place.

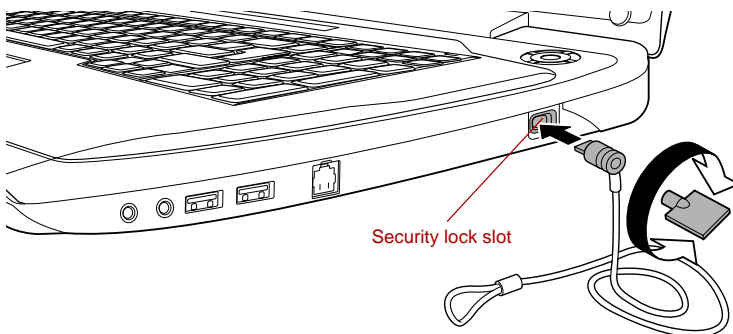

Figure 9-16 Security lock





# Chapter 10

## Troubleshooting

TOSHIBA have designed this computer for durability, however, should problems occur you are able to use the procedures detailed in this chapter to help determine the cause.

All users should become familiar with this chapter as knowing what might go wrong can help prevent problems from occurring in the first place.

### Problem solving process

Resolving problems will be much easier if you observe the following guidelines:

- Stop immediately when you recognize a problem exists as taking further action may result in data loss or damage, or you may destroy valuable problem related information that can help solve the problem.
- Observe what is happening - write down what the system is doing and what actions you performed immediately before the problem occurred. If you have a printer attached, print a copy of the screen using the computer's **PRtSC** key.

Please also be aware that the questions and procedures described in this chapter are meant only as a guide, they are not definitive problem solving techniques. In reality many problems can be solved simply, but a few may require help from your reseller, dealer or service provider - if you find you need to consult others, be prepared to describe the problem in as much detail as possible.

## Preliminary checklist

You should always consider the simplest solution first - the items detailed in this checklist are easy to fix and yet can cause what appears to be a serious problem:

- Make sure you turn on all peripheral devices before you turn on the computer - this includes your printer and any other external device you are using.
- Before you attach an external device you should first turn the computer off, then when you turn the computer back on again it will recognize the new device.
- Make sure all optional accessories are configured properly in the computer's setup program and that all required driver software has been loaded (please refer to the documentation included with the optional accessories for further information on its installation and configuration).
- Check all cables to ensure they are correctly and firmly attached to the computer - loose cables can cause signal errors.
- Inspect all connecting cables for loose wires and all connectors for loose pins.
- Check that your floppy diskette, CD or DVD media is correctly loaded and, in the case of a floppy diskette, that its write protect tab is correctly set.

Always try to make detailed notes of your observations and keep them in a permanent error log - this will help you to describe your problems to your reseller, dealer or service provider. In addition, if a problem recurs, the log you have made will help to identify the problem faster.

## Analyzing the problem

Sometimes the computer will give you clues that can help you identify why it is malfunctioning. In view of this you should keep the following questions in mind:

- Which part of the computer is not operating properly - keyboard, hard disk drive, optical disc drive, display panel, touch pad, touch pad control buttons - as each device will produce different symptoms.
- Check the options within the operating system to ensure that its configuration is set properly.
- What appears on the display? Does it display any messages or random characters? If you have a printer attached, print a copy of the screen using the **PRTSC** key and, if possible, look up the messages in the documentation included with the computer, software or operating system.
- Check that all connecting cables are correctly and firmly attached as loose cables can cause erroneous or intermittent signals.
- Do any indicators light, if so, which ones, what color are they and do they stay on or blink? Write down what you see.
- Do you hear any beeps, if so how many, are they long or short and are they high pitched or low pitched? In addition, is the computer making any unusual noises? Write down what you hear.

Record your observations so you can describe them in detail to your reseller, dealer or service provider.

**Software** The problems may be caused by your software or disk. If you cannot load a software package, the media may be damaged or the program might be corrupted - in these instances try loading another copy of the software if possible.

If an error message appears while you are using a software package you should refer to the documentation supplied with it as this will usually include a problem solving section or a summary of error messages.

Next, you should check any error messages against the operating system documentation.

**Hardware** If you cannot find a software problem, you should then check the setup and configuration of your hardware. First run through the items in the preliminary checklist as described previously then, if you still cannot correct the problem, try to identify the source - the next section provides checklists for individual components and peripherals.



*Before using a peripheral device or application software that is not an authorized Toshiba part or product, make sure the device or software can be used with your computer. Use of incompatible devices may cause injury or may damage your computer.*

## Hardware and system checklist

This section discusses problems caused by your computer's hardware or attached peripherals. Basic problems may occur in the following areas:

- System start-up
- Self test
- Power
- Password
- Keyboard
- Internal display panel
- Hard disk drive
- USB floppy diskette drive
- ExpressCard
- SD/SDHC memory card, miniSD/microSD Card
- Memory Stick/Memory Stick Duo/Memory Stick PRO/Memory Stick PRO Duo
- xD picture card
- MultiMediaCard
- Infrared receiver window
- Pointing device
- Fingerprint Sensor
- USB device
- eSATA device
- Additional memory module
- Sound system
- Volume control dial
- External monitor
- Modem
- LAN
- Wireless LAN
- Bluetooth
- HDMI monitor output function
- i.LINK (IEEE 1394) device
- Video Playback
- Recovery Discs

## System start-up

When the computer does not start properly, check the following items:

- Self Test
- Power Sources
- Power-on Password

## Self test

While booting up the computer, self test is executed automatically and the following will be displayed:



**Qosmio**

This message remains on the screen for a few seconds.

If the self test is successful, the computer tries to load the operating system according to how the **Boot Priority** option is set within the TOSHIBA HW Setup program.

If any of the following conditions are present, the self test has failed:

- The computer stops and does not proceed to display information or messages except for the TOSHIBA logo.
- Random characters appear on the screen and the system does not function normally.
- The screen displays an error message.

In these instances, turn off the computer, check all cable connections and then restart it - if the self test fails again, contact your reseller, dealer or service provider.

## Power

When the computer is not plugged into an AC power outlet, the battery pack is the primary power source. However, your computer also has a number of other power resources, including an intelligent power supply and a Real Time Clock (RTC) battery, all of which are interrelated with any one having the ability to produce apparent power problems.

This section provides checklists for AC power and the battery. If you cannot resolve a problem after following them, the cause may lie with another power related resource - in such an instance you should contact your reseller, dealer or service provider.

## Overheating power down

If the processor's temperature reaches an unacceptably high level with either setting, the computer will automatically shut down to prevent any damage - in this instance all unsaved data in memory will be lost.

Problem	Procedure
Computer shuts down and <b>DC IN</b> indicator blinks orange	Leave the computer off until the <b>DC IN</b> indicator stops blinking.



*It is recommended to leave the computer off until the interior reaches room temperature even though the **DC IN** indicator stops blinking.*

If the computer has reached room temperature and it still does not start, or if it starts but shuts down quickly, contact your reseller, dealer or service provider.

Computer shuts down and its <b>DC IN</b> indicator is flashing orange	This indicates a problem with the heat dispersal system - you should contact your reseller, dealer or service provider.
---	---

## AC power

If you have trouble turning on the computer with the AC adaptor connected you should check the status of the **DC IN** indicator. Please refer to Chapter 6, [Power](#), for further information.

Problem	Procedure
AC adaptor doesn't power the computer ( <b>DC IN</b> indicator does not glow white)	<p>Check the connections to make sure that the power cord/adaptor is firmly connected to the computer and a working power outlet.</p> <hr/> <p>Check the condition of the cord and terminals. If the cord is frayed or damaged it should be replaced, while if the terminals are soiled, they should be cleaned with a clean cotton cloth.</p> <hr/> <p>If the AC adaptor still does not power the computer, you should contact your reseller, dealer or service provider.</p>

## Battery

If you suspect a problem with the battery, you should check the status of the **DC IN** indicator as well as the **Battery** indicator. Please refer to Chapter 6, *Power*, for more information on these indicators, together with general battery operation.

Problem	Procedure
Battery doesn't power the computer	The battery may be discharged - connect the AC adaptor to recharge the battery.
Battery doesn't charge when the AC adaptor is attached ( <b>Battery</b> indicator does not glow orange).	<p>If the battery is completely discharged, it will not begin charging immediately, in these instances you should wait a few minutes before trying again. If the battery still does not charge, you should check that the power outlet the AC adaptor is connected to is supplying power - this can be tested by plugging another appliance into it.</p> <p>Check whether the battery is hot or cold to the touch - if so, it will not charge properly and should be allowed to reach room temperature before you try again.</p> <p>Unplug the AC adaptor and remove the battery to make sure its connecting terminals are clean - if necessary wipe them with a soft dry cloth lightly dipped in alcohol.</p> <p>Connect the AC adaptor and replace the battery, taking care to ensure that it is securely seated in the computer.</p> <p>Check the <b>Battery</b> indicator - if it does not glow, allow the computer to charge the battery for at least twenty minutes. If the <b>Battery</b> indicator starts to glow after this period, allow the battery to continue to charge for at least another twenty minutes before turning on the computer. However, if the indicator still does not glow, the battery may be at the end of its operating life and should be replaced. However, if you do not believe the battery is at the end of its operating life, you should speak to your reseller, dealer or service provider.</p>
Battery doesn't power the computer as long as expected	<p>If you frequently recharge a partially charged battery, the battery might not charge to its full potential - in these instances you should fully discharge the battery and then attempt to charge it again.</p> <p>Check the <b>Power saver</b> option under <b>Select a power plan</b> in the <b>Power Options</b>.</p>

## Real Time Clock

Problem	Procedure
The following message is Displayed on the screen: <b>RTC battery is low or CMOS checksum is inconsistent. Press [F1] key to set Date/Time.</b>	The charge in the Real Time Clock (RTC) battery has run out - you will need to set the date and time in the BIOS setup application by using the following steps: <ol style="list-style-type: none"><li>1. Press the <b>F1</b> key - the BIOS setup application will load.</li><li>2. Set the date in the <b>System Date</b> field.</li><li>3. Set the time in the <b>System Time</b> field.</li><li>4. Press the <b>END</b> key - a confirmation message will be displayed.</li><li>5. Press the <b>Y</b> key - the BIOS setup application will end and the computer will restart.</li></ol>

## Password

Problem	Procedure
Cannot enter password	Please refer to the <a href="#">TOSHIBA Password Utility</a> section in Chapter 6, <a href="#">Power</a> , for further information.

## Keyboard

Keyboard problems can be caused by the setup and configuration of the computer - please refer to Chapter 5, [The Keyboard](#), for further information.

Problem	Procedure
Output to screen is garbled	Please refer to your software's documentation to ensure that its is not remapping the keyboard in any way (remapping involves changing or reassigning the function of each key).  If you are still unable to use the keyboard, you should contact your reseller, dealer or service provider.

## Internal display panel

Apparent computer's display panel problems may be related to the computer's setup and configuration.

Problem	Procedure
No display	Press the <b>FN + F5</b> hot keys to adjust the display priority, and to make sure it is not set for output to an external monitor.
Markings appear on the computer's display panel.	These marks may have come from contact with the keyboard and Touch Pad while the display panel has been closed. You should try to remove the marks by gently wiping the display panel with a clean dry cloth or, if this fails, with a good quality LCD screen cleaner. In this latter instance you should always follow the instructions with the screen cleaner and always ensure you let the display panel dry properly before closing it.
Problems above remain unresolved or other problems occur	You should initially refer to the documentation supplied with you software to determine if it is this that is causing the problems. Alternatively you may wish to run the TOSHIBA PC Diagnostic Tool to check the general operation of the computer.  If you are still unable to resolve the problem, contact your reseller, dealer or service provider.

## Hard disk drive

Problem	Procedure
Computer does not boot from hard disk drive	Check to see whether that is a floppy diskette in the floppy diskette drive or a CD-ROM/DVD-ROM in the optical disc drive - if so remove it and try to start the computer again.  If this has no effect, check the <b>Boot Priority</b> setting within the TOSHIBA HW Setup utility - please refer to the <a href="#">Boot Priority</a> section in Chapter 7, <i>HW Setup</i> , for further information.  Please refer to your operating system documentation in order to determine whether there is a problem with any of the operating system files or settings.



Problem	Procedure
Slow performance	<p>The files on the hard disk drive may be fragmented - in this instance you should run the disk Defragmentation utility to check the condition of your files and the hard disk drive. Please refer to the operating system's documentation or online Help File for further information on operating and using the Defragmentation utility.</p> <hr/> <p>As a last resort you should reformat the hard disk drive and then reload the operating system and all other files and data. If you are still unable to resolve the problem, contact your reseller, dealer or service provider.</p>

## DVD Super Multi drive

For more information, refer to Chapter 4, [Operating Basics](#).

Problem	Procedure
You cannot access a CD/DVD in the drive	<p>Make sure the drive's disc tray is securely closed. Press gently until it clicks into place.</p> <hr/> <p>Check whether the drive power is on. If the power is off, press the <b>FN + Tab</b> hot key and turn on the power.</p> <hr/> <p>Open the disc tray and make sure the CD/DVD is properly seated. It should lie flat with the label facing up.</p> <hr/> <p>A foreign object in the disc tray could block laser light from reading the CD/DVD. Make sure there is no obstruction. Remove any foreign object.</p> <hr/> <p>Check whether the CD/DVD is dirty. If it is, wipe it with a clean cloth dipped in water or a neutral cleaner. Refer to the <a href="#">Media care</a> section in Chapter 4 for details on cleaning.</p>

Problem	Procedure
<p>Some CD/DVDs run correctly, but others do not</p>	<p>The software or hardware configuration may be causing a problem. Make sure the hardware configuration matches your software's needs. Check the CD/DVD's documentation.</p> <p>Check the type of CD/DVD you are using. The drive supports:</p> <p>DVD-ROM: DVD-ROM, DVD-Video</p> <p>CD-ROM: CD-DA, CD-Text, Photo CD (single/multi-session), CD-ROM Mode 1, Mode 2, CD-ROM XA Mode 2 (Form1, Form2), Enhanced CD (CD-EXTRA), Addressing Method 2</p> <p>Recordable DVD: DVD-R/R DL, DVD+R/+R DL, DVD-RW, DVD+RW, DVD-RAM</p> <hr/> <p>Check the region code on the DVD. It must match that on the DVD Super Multi drive. Region codes are listed in the <i>Optical disc drives</i> section in Chapter 2, <i>The Grand Tour</i>.</p>

### USB floppy diskette drive

The USB floppy diskette drive is available only as an option. For further information, please refer to Chapter 4, *Operating Basics*.

Problem	Procedure
<p>Drive does not operate</p>	<p>Check the connection between the computer and the drive to ensure that it is properly attached.</p>
<p>Some programs run correctly but others do not</p>	<p>The computer's software or hardware configuration may be causing a problem - ensure that these configurations match your requirements (refer to any relevant documentation, for example that supplied with any software in use, for further information).</p>
<p>You cannot access the external floppy diskette drive</p>	<p>Try another floppy diskette in the drive - if you are able to access this disk then it indicates the original disk and not the drive is probably causing the problem.</p> <p>If you are still unable to resolve the problem, contact your reseller, dealer or service provider.</p>

## ExpressCard

For further information, please refer to Chapter 9, *Optional Devices*.

Problem	Procedure
ExpressCard error occurs	<p>Remove the ExpressCard from the computer and then reinsert it in order to ensure it is firmly connected.</p> <hr/> <p>In the event that the ExpressCard is attached to an external peripheral device, ensure that this connection is properly made.</p> <hr/> <p>If the problem persists, then you should refer to the documentation supplied with your ExpressCard for further information.</p> <p>If you are still unable to resolve the problem, contact your reseller, dealer or service provider.</p>

## SD/SDHC memory card, miniSD/microSD Card

For further information, please refer to Chapter 9, *Optional Devices*.

Problem	Procedure
SD/SDHC memory card, miniSD/microSD Card error occurs	<p>Remove the SD/SDHC memory card, miniSD/microSD Card from the computer and then reinsert it in order to ensure it is firmly connected.</p> <p>If the problem persists, then you should refer to the documentation supplied with your SD/SDHC memory card, miniSD/microSD Card for further information.</p>
You cannot write to an SD/SDHC memory card	<p>Remove the SD/SDHC memory card from the computer and check to ensure that it is not write protected.</p>
You cannot read a file	<p>Check to ensure the required file is actually on the SD/SDHC memory card, miniSD/microSD Card that is inserted into the computer.</p> <p>If you are still unable to resolve the problem, contact your reseller, dealer or service provider.</p>

## Memory Stick/Memory Stick Duo/Memory Stick PRO/Memory Stick PRO Duo

For further information, please refer to Chapter 9, [Optional Devices](#).

Problem	Procedure
Memory Stick/Memory Stick Duo/Memory Stick PRO/Memory Stick PRO Duo error occurs	Remove the Memory Stick/Memory Stick Duo/Memory Stick PRO/Memory Stick PRO Duo from the computer and then reinsert it in order to ensure it is firmly connected.  If the problem persists, then you should refer to the documentation supplied with your Memory Stick/Memory Stick Duo/Memory Stick PRO/Memory Stick PRO Duo for further information.
You cannot write to an Memory Stick/Memory Stick Duo/Memory Stick PRO/Memory Stick PRO Duo	Remove the Memory Stick/Memory Stick Duo/Memory Stick PRO/Memory Stick PRO Duo from the computer and check to ensure that it is not write protected.
You cannot read a file	Check to ensure the required file is actually on the Memory Stick/Memory Stick Duo/Memory Stick PRO/Memory Stick PRO Duo that is inserted into the computer.  If you are still unable to resolve the problem, contact your reseller, dealer or service provider.

## xD picture card

For further information, please refer to Chapter 9, [Optional Devices](#).

Problem	Procedure
xD picture card error occurs	Remove the xD picture card from the computer and then reinsert it in order to ensure it is firmly connected.  If the problem persists, then you should refer to the documentation supplied with your xD picture card for further information.
You cannot read a file	Check to ensure the required file is actually on the xD picture card that is inserted into the computer.  If you are still unable to resolve the problem, contact your reseller, dealer or service provider.

## MultiMediaCard

For further information, please refer to Chapter 9, [Optional Devices](#).

Problem	Procedure
MultiMediaCard error occurs	Remove the MultiMediaCard from the computer and then reinsert it in order to ensure it is firmly connected.  If the problem persists, then you should refer to the documentation supplied with your MultiMediaCard for further information.
You cannot write to a MultiMediaCard	Remove the MultiMediaCard from the computer and check to ensure that it is not write protected.
You cannot read a file	Check to ensure the required file is actually on the MultiMediaCard that is inserted into the computer.  If you are still unable to resolve the problem, contact your reseller, dealer or service provider.

## Infrared receiver window

If you are using a USB mouse, you should also refer to both the USB device section in this chapter, and the documentation supplied with your mouse.

Problem	Procedure
Infrared devices do not work as expected	Make sure there is no obstruction blocking communication between the computer and the target device.  If you are still unable to resolve the problem, contact your reseller, dealer or service provider.

## Pointing device

If you are using a USB mouse, you should also refer to both the [USB device](#) section in this chapter, and the documentation supplied with your mouse.

### *Touch Pad*

Problem	Procedure
On-screen pointer does not respond to pointing device operation	In this instance the system might be busy - Try moving the mouse again after waiting a short while.

Problem	Procedure
Double-tapping does not work	<p>In this instance, you should initially try changing the double-click speed setting within the Mouse Control utility.</p> <ol style="list-style-type: none"><li>1. To access this utility, click <b>Start -&gt; Control Panel -&gt; Hardware and Sound -&gt; Mouse</b> icon.</li><li>2. Within the Mouse Properties window, click the <b>Buttons</b> tab.</li><li>3. Set the double-click speed as required and click <b>OK</b>.</li></ol>
The on-screen pointer moves too fast or too slow	<p>In this instance, you should initially try changing the speed setting within the Mouse Control utility.</p> <ol style="list-style-type: none"><li>1. To access this utility, click <b>Start -&gt; Control Panel -&gt; Hardware and Sound -&gt; Mouse</b> icon.</li><li>2. Within the Mouse Properties window, click the <b>Pointer Options</b> tab.</li><li>3. Set the pointer speed as required and click <b>OK</b>.</li></ol>
The reaction of Touch pad is either too sensitive or not sensitive enough.	<p>Adjust the touch sensitivity.</p> <ol style="list-style-type: none"><li>1. Click <b>Start -&gt; Control Panel -&gt; Hardware and Sound -&gt; Mouse</b> icon.</li><li>2. Within the Mouse Properties window, click the <b>Device Settings</b> tab.</li><li>3. Click the <b>Settings...</b> button.</li><li>4. The <b>Properties for Synaptics TouchPad™ on PS/2 Port</b> screen appears. Double-click <b>Sensitivity</b> in the <b>Select an item</b> section on the left side of the screen.</li><li>5. PalmCheck™ and Touch Sensitivity are displayed. Click <b>Touch Sensitivity</b>.</li><li>6. Move the slide bar for Touch Sensitivity to make an adjustment. Click the <b>OK</b> button.</li><li>7. Click the <b>OK</b> button on the <b>Device Settings</b> tab.</li></ol> <p>If you are still unable to resolve the problem, contact your reseller, dealer or service provider.</p>

## USB mouse

Problem	Procedure
On-screen pointer does not respond to mouse operation	<p>In this instance the system might be busy - Try moving the mouse again after waiting a short while.</p> <hr/> <p>Remove the mouse from the computer and then reconnect it to a free USB port it in order to ensure it is firmly attached.</p> <hr/>
Double-clicking does not work	<p>In this instance, you should initially try changing the double-click speed setting within the Mouse Control utility.</p> <ol style="list-style-type: none"><li>1. To access this utility, click <b>Start -&gt; Control Panel -&gt; Hardware and Sound -&gt; Mouse</b> icon.</li><li>2. Within the Mouse Properties window, click the <b>Buttons</b> tab.</li><li>3. Set the double-click speed as required and click <b>OK</b>.</li></ol> <hr/>
The on-screen pointer moves too fast or too slow	<p>In this instance, you should initially try changing the speed setting within the Mouse Control utility.</p> <ol style="list-style-type: none"><li>1. To access this utility, click <b>Start -&gt; Control Panel -&gt; Hardware and Sound -&gt; Mouse</b> icon.</li><li>2. Within the Mouse Properties window, click the <b>Pointer Options</b> tab.</li><li>3. Set the pointer speed as required and click <b>OK</b>.</li></ol> <hr/>
The on-screen pointer moves erratically	<p>The elements of the mouse responsible for detecting movement might be dirty - please refer to the documentation supplied with the mouse for instructions on how to clean it.</p> <p>If you are still unable to resolve the problem, contact your reseller, dealer or service provider.</p> <hr/>

## Fingerprint Sensor

Problem	Procedure
Reading of the fingerprint was not successful.	<p>In this instance you should try the fingerprint reading operation again using the correct finger position - please refer to <a href="#">Using the Fingerprint Sensor (optional)</a> in Chapter 4, <a href="#">Operating Basics</a>, for further information.</p> <p>Alternatively, you should try the recognition process again using another enrolled finger. The fingerprint sensor compares and analyzes the unique characteristics in a fingerprint.</p> <p>However, there may be instances where certain users are unable to register their fingerprints due to insufficient unique characteristics in their fingerprints.</p> <p>The recognition success rate may differ from user to user.</p>
The fingerprint cannot be read due to injuries to the finger.	<p>In this instance you should try the recognition process again using another enrolled finger. However, if fingerprints from all the enrolled fingers cannot be read, you should instead log into the computer by using the keyboard to input the password.</p> <p>If you are still unable to resolve the problem, contact your reseller, dealer or service provider.</p>

## USB device

In addition to the information in this section, please also refer to the documentation supplied with your USB device.

Problem	Procedure
USB device does not work	<p>Remove the USB device from the computer and then reconnect it to a free port it in order to ensure it is firmly attached.</p> <p>Ensure that any required USB device drivers are properly installed - to achieve this you should refer to both the device documentation and the operating system documentation.</p> <p>If you are using an operating system that does not support USB, you are still able to use a USB mouse and/or USB keyboard by setting the <b>USB KB/Mouse Emulation</b> option within the TOSHIBA HW Setup utility to <b>Enabled</b>.</p> <p>If you are still unable to resolve the problem, contact your reseller, dealer or service provider.</p>



## USB Sleep and Charge function

For more information and settings, please refer to the [USB Sleep and Charge](#) section in Chapter 7, [HW Setup](#).

Problem	Procedure
I cannot use the “USB Sleep and Charge function”.	<p>The setting of “USB Sleep and Charge function” may be [Disabled]. Change the setting to [Enabled].</p> <hr/> <p>When there is a current overflow of the external device connected to the compatible port, USB bus power (DC5V) supply may be stopped for safety reasons. When this happens, disconnect an external device if some external devices are connected. After that, turn the power of the computer ON/OFF to restore the function. If this function can not be still used even if only one external device is connected, stop using the external device because its current is over the acceptable value of this computer.</p> <hr/> <p>Some external devices may not be able to use the “USB Sleep and Charge function”. In this case, please try one or more of the following methods.</p> <ul style="list-style-type: none"> <li>■ Change a mode setting of [Enabled].</li> <li>■ Turn OFF the computer while external devices are connected.</li> <li>■ Connect external devices after turning OFF of the computer.</li> </ul> <p>If this function can not be still used, change the setting to [Disabled] and stop using this function.</p>
The battery depletes quickly even when I turned OFF the power of the computer.	<p>When “USB Sleep and Charge function” is set to [Enabled], USB bus power (DC5V) will be supplied to the external device connected to the compatible port. If external device is connected to the compatible port when the AC adaptor is not connected to the computer, the battery of the computer will be depleted even when the power of the computer is turned OFF.</p> <p>Connect the AC adaptor to the computer or change the “USB Sleep and Charge function” setting to [Disabled] or if there is a USB port that does not have the USB Sleep and Charge function-compatible icon ( ⚡ ), use that port.</p>

Problem	Procedure
<p>External devices connected to the compatible ports do not work when connected to a compatible port.</p>	<p>Some external devices may not work when connected to a compatible port when the “USB Sleep and Charge function” is [Enabled].                      Reconnect the external device after turning ON the computer.                      If the external device still does not work, connect device to a USB port, if there is one, that does not have the USB Sleep and Charge function-compatible icon ( ⚡ ) or change the “USB Sleep and Charge function” setting to [Disabled].</p>
<p>The “USB Wakeup function” does not work.</p>	<p>When “USB Sleep and Charge function” is set to [Enabled], the “USB Wakeup function” does not work for ports that support the USB Sleep and Charge function.                      In that case, use a USB port, if there is one, that does not have the USB Sleep and Charge function-compatible icon ( ⚡ ) or change the “USB Sleep and Charge function” setting to [Disabled].</p>

### eSATA device

In addition to the information in this section, please also refer to the documentation supplied with your eSATA device.

Problem	Procedure
<p>eSATA device does not work</p>	<p>Remove the eSATA device from the computer and then reconnect it to a free port it in order to ensure it is firmly attached.                      A connected eSATA device may not be recognized if it is connected to the computer's eSATA/USB combo port while the computer is in Sleep Mode or Hibernation Mode. If this occurs, disconnect the eSATA device and then reconnect the device while the computer is turned on.                      Ensure that any required eSATA device drivers are properly installed - to achieve this you should refer to both the device documentation and the operating system documentation.                      If you are still unable to resolve the problem, contact your reseller, dealer or service provider.</p>

## Additional memory module

Please also refer to Chapter 9, *Optional Devices*, for further information on installing and removing memory modules.

Problem	Procedure
<p>If there is a memory malfunction, the <b>Power</b> indicator will repeatedly flash (on for 0.5 seconds, off for 0.5 seconds) in the following patterns;</p> <p>If there is an error in only slot A or no memory module is inserted in Slot A: orange twice, then white once.</p> <p>If there is an error in Slot B: orange once, then white twice.</p> <p>If there are errors in both Slot A and Slot B: orange twice, then white twice.</p>	<p>In the event the <b>Power</b> indicator flashes when the computer is turned on, you should first check that the installed memory module(s) are compatible with the computer. If there is an error with a compatible memory module, there is a possibility the memory module is damaged.</p> <p>If you determine that an incompatible module has been installed, you should follow the steps as detailed below:</p> <ol style="list-style-type: none"> <li>1. Turn off the computer.</li> <li>2. Disconnect the AC adaptor and all peripheral devices.</li> <li>3. Remove the battery pack.</li> <li>4. Remove the incompatible memory module.</li> <li>5. Install the battery and/or connect the AC adaptor.</li> <li>6. Turn on the computer.</li> </ol> <p>If you are still unable to resolve the problem, contact your reseller, dealer or service provider.</p>
<p>An error will occur if a memory module is inserted into Slot B while no memory module is inserted in Slot A.</p>	<p>Remove the memory module from Slot B and insert it into Slot A.</p>

## Sound system

In addition to the information in this section, please also refer to the documentation supplied with your audio device.

Problem	Procedure
No sound is heard	<p>Adjust the volume control dial.</p> <p>Turn the dial clockwise to increase the volume and turn it counter-clockwise to decrease the volume.</p> <hr/> <p>Check the software volume settings.</p> <hr/> <p>Please check to see if Mute is turned to Off.</p> <hr/> <p>Check to make sure the headphone connection is secure.</p> <hr/> <p>Check within the Windows Device Manager application to ensure the sound device is enabled and that the device is properly working.</p> <p>For further information, please refer to “Troubleshooting in Windows” section of Windows Help and Support.</p>
Annoying sound is heard	<p>In this instance you may be experiencing feedback from either the internal microphone or an external microphone connected to the computer - please refer to <a href="#">Sound system</a> in Chapter 4, <a href="#">Operating Basics</a>, for further information.</p> <p>Volume cannot be adjusted when Windows is turned on or turned off.</p> <p>If you are still unable to resolve the problem, contact your reseller, dealer or service provider.</p>

## Volume control dial

Problem	Procedure
No sound is heard	<p>Adjust the volume control dial.</p> <p>Turn the dial clockwise to increase the volume and turn it counter-clockwise to decrease the volume.</p> <p>Turn the volume control dial while verifying the volume in order to adjust.</p>

Problem	Procedure
Annoying sound is heard	Volume cannot be adjusted when Windows is turned on or turned off. If you are still unable to resolve the problem, contact your reseller, dealer or service provider.

## External monitor

Please also refer to Chapter 9, [Optional Devices](#), and to the documentation supplied with your monitor for further information.

Problem	Procedure
Monitor does not turn on	After confirming that the monitor's power switch is on, you should check the connections to make sure that the power cord/adaptor is firmly connected to the monitor and to a working power outlet.
No display	<p>Try adjusting the contrast and brightness controls on the external monitor.</p> <p>Press the <b>FN + F5</b> hot key in order to change the display priority and ensure that it is not set for the internal display panel only.</p> <p>Check to see if the external monitor is connected. When the external monitor is set as the primary display device in extended desktop mode, it will not display when the computer wakes up from Sleep Mode if the external monitor has been disconnected while in Sleep Mode. To keep this from happening, do not disconnect the external monitor while the computer is in Sleep or Hibernation Mode. Remember to turn off the computer before disconnecting the external monitor.</p> <p>When the display panel and an external monitor are set to clone mode and they are turned off by the timer, the display panel or the external monitor may not display when turned on again. If this occurs, press <b>FN + F5</b> to re-set the display panel and external monitor to clone mode.</p>
Display error occurs	Check that the cable connecting the external monitor to the computer is firmly attached. If you are still unable to resolve the problem, contact your reseller, dealer or service provider.

## Modem



- *This information is applicable to the models equipped with a built-in modem.*
- *Some models are equipped with a modem jack or FM antenna port.*

Problem	Procedure
Communication software can't initialize modem	Make sure the computer's internal modem settings are correct - please refer to the Phone and Modem Options link within the Windows Control Panel.
You can hear a dial tone but can't make a call	If the call is going through a Private Branch Exchange (PBX), take care to ensure that the communication application's tone dial detection feature is disabled.
You place a call, but a connection can't be made	Make sure that the settings are correct within your communication application.
After making a call you can't hear a ring	Ensure that the communication application's tone or pulse dialling selection feature is set correctly.
Communication is cut off unexpectedly	The computer will automatically cut off communication when connection with the carrier is not successful for a set time interval - try lengthening this time interval within your communication application.
A <b>CONNECT</b> display is quickly replaced by <b>NO CARRIER</b>	Ensure that the communication application's error control feature is set correctly.
Character display becomes garbled during a communication	When transmitting data you should ensure that the parity bit and stop bit settings correspond with those of the remote computer - you should check the flow control and communication protocol settings within your communication application.
You cannot receive an incoming call	Ensure that the communication application's rings before auto answer feature is set correctly.  If you are still unable to resolve the problem, contact your reseller, dealer or service provider.

## LAN

Problem	Procedure
Cannot access LAN	Check for a firm cable connection between the LAN jack and the LAN hub.
Wake-up on LAN does not work	Make sure the AC adaptor is connected. The Wake-up on LAN function consumes power even when the system is off. If problems persist, consult your LAN administrator.

## Wireless LAN

If the following procedures do not restore LAN access, consult your LAN administrator. For more information on wireless communication, refer to Chapter 4, [Operating Basics](#).

Problem	Procedure
Cannot access Wireless LAN	Make sure the computer's Wireless communication switch is set to on. If problems persist, consult your LAN administrator.

## Bluetooth

For further information on Bluetooth wireless communication, please refer to Chapter 4, [Operating Basics](#).

Problem	Procedure
Cannot access Bluetooth device	Check to ensure the computer's Wireless communication switch is set to on.
	Check to ensure the Bluetooth Manager application is running on the computer and that power to the external Bluetooth device is turned on.
	Check to ensure that no optional Bluetooth Adaptor is installed in the computer - the built-in Bluetooth hardware cannot operate simultaneously with another Bluetooth controller. If you are still unable to resolve the problem, contact your reseller, dealer or service provider.

## HDMI monitor output function

Problem	Procedure
No display	<p>Try adjusting the contrast and brightness controls on the television.</p> <hr/> <p>Press the <b>FN + F5</b> hot key in order to change the display priority and ensure that it is not set for the internal display panel only.</p> <p>If you are still unable to resolve the problem, contact your reseller, dealer or service provider.</p>



*If you turn the computer off into Sleep Mode while the display is on HDMI monitor, the computer will select either the internal LCD or an external computer CRT as the display device the next time is turned on.*

## i.LINK (IEEE1394) device

Problem	Procedure
i.LINK device does not function	<p>Make sure the cable is securely connected to the computer and to the device.</p> <hr/> <p>Make sure the device's power is turned on.</p> <hr/> <p>Reinstall the drivers. Open the Windows Control Panel and double-click the <b>Add Hardware</b> icon. Follow the on-screen directions.</p> <hr/> <p>Restart Windows.</p> <p>If you are still unable to resolve the problem, contact your reseller, dealer or service provider.</p>



## Video Playback

Problem	Procedure
DVD does not play smoothly when using the Windows Media Center of the DVD playing software	<p>Try setting the configuration in the BIOS setup. However, note that when the BIOS setup configuration is modified, the power saving function of PCI Express becomes disabled. Refer to Chapter 7, <i>HW Setup</i>, for more information.</p> <p>Set the PCI Express Link ASPM in the BIOS setup using the following steps:</p> <ol style="list-style-type: none"> <li>1. Press the <b>F1</b> key. The BIOS setup screen will appear.</li> <li>2. Set the PCI Express Link ASPM to <b>Disabled</b> in BATTERY.</li> <li>3. Press the <b>END</b> key. A confirmation message will appear.</li> <li>4. Press the <b>Y</b> key. The BIOS setup will terminate and the computer will reboot.</li> </ol> <p>If you are still unable to resolve the problem, contact your reseller, dealer or service provider.</p>

## Recovery Discs

Problem	Procedure
<p>The following message appears when executing Recovery Disc Creator.</p> <p><b>"The Recovery Disc Creator can not be launched because there is no recovery partition."</b></p>	<p>You will see this message if you have previously chosen to remove the partition and are trying to create "Recovery Media".</p> <p>When there is no recovery partition, the Recovery Disc Creator cannot make Recovery Media.</p> <p>However, if you have already created a "Recovery Media", you can use it to restore the recovery partition.</p> <p>Simply follow the instructions in <i>Restoring the pre-installed software from your created Recovery Discs</i> section in Chapter 3, <i>Getting Started</i>.</p> <p>You will be directed to select "Restore Original Factory Image" from the drop-down menu.</p> <p>If you have not created "Recovery Media", please contact TOSHIBA support for assistance.</p>

## TOSHIBA support

If you require any additional help using your computer or if you are having problems operating the computer, you may need to contact TOSHIBA for additional technical assistance.

### Before you call

Some problems you experience may be related to software or the operating system so it is important that you investigate other sources of assistance first. Before contacting TOSHIBA, try the following:

- Review troubleshooting sections in the documentation supplied with your software and/or peripheral devices.
- If a problem occurs when you are running software applications, consult the software documentation for troubleshooting suggestions and consider calling the software company's technical support department for assistance.
- Consult the reseller or dealer from where you purchased your computer and/or software - they are your best resource for current information and support.

### Where to write

If you are still unable to solve the problem and suspect that it is hardware related, write to TOSHIBA at the location listed in the accompanying warranty booklet or visit [www.toshiba-europe.com](http://www.toshiba-europe.com) on the internet.

# Chapter 11

## Legal Footnotes

This chapter states the Legal Footnotes information applicable to TOSHIBA computers. In the text in this manual, \*XX is used to show which Legal Footnotes description is related to TOSHIBA computers.

Description(s) related to this computer are marked with a blue \*XX in this manual. Clicking on \*XX will display the related description.

### CPU\*1

Central Processing Unit ("CPU") Performance Legal Footnotes.

CPU performance in your computer product may vary from specifications under the following conditions:

- use of certain external peripheral products
- use if battery power instead of AC power
- use of certain multimedia, computer generated graphics or video applications
- use of standard telephone lines or low speed network connections
- use of complex modeling software, such as high end computer aided design applications
- use of several applications or functionalities simultaneously
- use of computer in areas with low air pressure (high altitude >1,000 meters or >3,280 feet above sea level)
- use of computer at temperatures outside the range of 5°C to 30°C (41°F to 86°F) or >25°C (77°F) at high altitude (all temperature references are approximate and may vary depending on the specific computer model - please refer to your computer documentation or visit the Toshiba website at [www.pcsupport.toshiba.com](http://www.pcsupport.toshiba.com) for details).

CPU performance may also vary from specifications due to design configuration.

Under some conditions, your computer product may automatically shut-down. This is a normal protective feature designed to reduce the risk of lost data or damage to the product when used outside recommended conditions. To avoid risk of lost data, always make back-up copies of data by periodically storing it on an external storage medium. For optimum performance, use your computer product only under recommended conditions. Read additional restrictions under “Environmental Conditions” in your computer documentation.

Contact Toshiba Technical Service and Support for more information.

## 64-Bit Computing

64-bit processors are designed to take advantage of 32 and 64 bit computing.

64-bit computing requires that the following hardware and software requirements are met:

- 64-bit Operating System
- 64-bit CPU, Chipset and BIOS (Basic Input/Output System)
- 64-bit Device drivers
- 64-bit applications

Certain device drivers and/or applications may not be compatible with a 64-bit CPU and therefore may not function properly. A 32-bit version of the operating system is preinstalled on your computer unless explicitly stated that the operating system is 64-bit.

## Memory (Main System)\*2

Part of the main system memory may be used by the graphics system for graphics performance and therefore reduce the amount of main system memory available for other computing activities. The amount of main system memory allocated to support graphics may vary depending on the graphics system, applications utilized, system memory size and other factors. For computer's configured with 4 GB of system memory, the full system memory space for computing activities will be considerably less and will vary by model and system configuration.

## Battery Life\*3

Battery life may vary considerably depending on product model, configuration, applications, power management settings and features utilized, as well as the natural performance variations produced by the design of individual components. Published battery life numbers are achieved on select models and configurations tested by Toshiba at the time of publication. Recharge time varies depending on usage. Battery may not charge while computer is consuming full power.

After going through many charge and discharge cycles, the battery will lose its ability to perform at maximum capacity and will need to be replaced. This is a normal phenomenon for all batteries. To purchase a new battery pack, see the accessories information that is shipped with your computer.

## Hard Disk Drive (HDD) Capacity\*4

1 Gigabyte (GB) means  $10^9 = 1,000,000,000$  bytes using powers of 10. The computer operating system, however, reports storage capacity using powers of 2 for the definition of 1 GB =  $2^{30} = 1,073,741,824$  bytes, and therefore shows less storage capacity. Available storage capacity will also be less if the product includes one or more pre-installed operating systems, such as Microsoft Operating System and/or pre-installed software applications, or media content. Actual formatted capacity may vary.

## LCD\*5

Over a period of time, and depending on the usage of the computer, the brightness of the LCD screen will deteriorate. This is an intrinsic characteristic of LCD technology.

Maximum brightness is only available when operating in AC power mode. Screen will dim when the computer is operated on battery power and you may not be able to increase the brightness of the screen.

## Graphics Processor Unit (“GPU”)\*6

Graphics processor unit (“GPU”) performance may vary depending on product model, design configuration, applications, power management settings and features utilized. GPU performance is only optimized when operating in AC power mode and may decrease considerably when operating in battery power mode.

Total Available Graphics Memory is the total of, as applicable, Dedicated Video Memory, System Video Memory and Shared System Memory. Shared System Memory will vary depending on system memory size and other factors.

## Wireless LAN\*7

The transmission speed over the wireless LAN and the distance over which wireless LAN can reach may vary depending on surrounding electromagnetic environment, obstacles, access point design and configuration, and client design and software/hardware configurations.

The actual transmission speed will be lower than the theoretical maximum speed.

The wireless adapter is based on a draft 2.0 release version of the IEEE 802.11n specification and; may not be full compatible with, or support some feature (e.g., security) of, certain Wi-Fi equipment.

## Non-applicable Icons\*8

Certain computer chassis are designed to accommodate all possible configurations for an entire product series. Therefore, please be aware that your selected model may not have all the features and specifications corresponding to all of the icons or switches shown on the computer chassis.

## Copy Protection\*9

Applicable copy protection standards included in certain media may prevent or limit recording or viewing of the media.

## TV Tuner\*10

TV Tuner will function only in the country where the computer was purchased.

## Images\*11

All images are simulated for purposes of illustration.

## LCD Brightness and Eye Stain\*12

Your display panel has a brightness approaching that of a TV device. We recommend that you adjust the brightness of your LCD to a comfortable level to prevent possible strain on your eyes.

## Safety Use for TV Tuner\*13

If you have to operate your computer during a thunderstorm and are connecting the TV tuner to an outside antenna, you should operate your computer using AC power mode. The AC adaptor offers some protection against (but does not entirely prevent) possible electric shock caused by lightning. For complete protection, do not operate your computer during a thunderstorm.

# Appendix A

## Specifications

This appendix summarizes the computer's technical specifications.

### Environmental Requirements

Conditions	Ambient temperature	Relative humidity
Operating	5°C (41°F) to 35°C (95°F)	20% to 80% (noncondensing)
Non-operating	-20°C (-4°F) to 65°C (149°F)	10% to 90% (noncondensing)
<b>Wet-bulb temperature</b>	26°C maximum	
Conditions	Altitude (from sea level)	
Operating	-60 to 3,000 meters	
Non-operating	-60 to 10,000 meters maximum	

### Power Requirements

<b>AC adaptor</b>	100-240 volts AC 50 or 60 hertz (cycles per second)
<b>Computer</b>	19 VDC 6.32 amperes

## Built-in Modem



*This information is applicable to the models equipped with a built-in modem.*

### Network control unit (NCU)

**Type of NCU** AA

**Type of line** Telephone line (analog only)

**Type of dialing** Pulse  
Tone

**Control command** AT commands  
EIA-578 commands

**Monitor function** Computer's speaker

### Communication specifications

**Communication system** Data: Full duplex  
Fax: Half duplex

**Communication protocol** Data  
ITU-T-Rec V.21/V.22/V.22bis/V.32/  
(Former CCITT) V.32bis/V.34/V.90  
Bell 103/212A  
Fax  
ITU-T-Rec V.17/V.29/V.27ter/V.21 ch2  
(Former CCITT)

**Communication speed** Data transmission and reception  
300/1200/2400/4800/7200/9600/12000/14400/16800/  
19200/21600/24000/26400/28800/31200/33600 bps  
Data reception only with V.90  
28000/29333/30666/32000/33333/34666/36000/  
37333/38666/40000/41333/42666/44000/45333/  
46666/48000/49333/50666/52000/53333/54666/56000  
bps  
Fax  
2400/4800/7200/9600/12000/14400 bps

**Transmitting level** -10 dBm

**Receiving level** -10 to -40 dBm

**Input/output impedance** 600 ohms  $\pm$ 30%

**Error correcting** MNP class 4 and ITU-T V.42

**Data compression** MNP class 5 and ITU-T V.42bis

**Power supply** +3.3V (supplied by computer)



# Appendix B

## Display Controller and Video mode

### Display controller

The display controller interprets software commands into hardware commands that turn particular parts on the screen on or off.



*Due to the display panel's increased resolution, lines may appear broken in when displaying images in full-screen text mode.*

The display controller also controls the video mode and uses industry standard rules to govern the screen resolution and the maximum number of colors that can be displayed at any one time. Therefore, software written for a given video mode will run on any computer that supports that mode.

### Video mode

Video mode settings are configured via the **Display Properties** dialog.

To open the **Display Properties** dialog, click **Start -> Control Panel -> Appearance and Personalization -> Personalization -> Display Settings**.



*If you are running some applications (for example a 3D application or video playback and so on), you may see some disturbance, flickering or frame dropping on your screen.*

*If that occurs, adjust the resolution of display, lowering it until the screen is displayed properly.*

*Disabling Windows Aero™ may also help correct this issue.*



# Appendix C

## Wireless LAN

This appendix is intended to help you get your Wireless LAN network up and running, with a minimum of parameters.

### Card Specifications

<b>Form Factor</b>	PCI Express Mini Card
<b>Compatibility</b>	<ul style="list-style-type: none"><li>■ IEEE 802.11 Standard for Wireless LANs</li><li>■ Wi-Fi (Wireless Fidelity) certified by the Wi-Fi Alliance. The “Wi-Fi CERTIFIED” logo is a certification mark of the Wi-Fi Alliance.</li></ul>
<b>Network Operating System</b>	<ul style="list-style-type: none"><li>■ Microsoft Windows Networking</li></ul>
<b>Media Access Protocol</b>	<ul style="list-style-type: none"><li>■ CSMA/CA (Collision Avoidance) with Acknowledgment (ACK)</li></ul>

## Radio Characteristics

Radio Characteristics of Wireless LAN modules may vary according to:

- Country/region where the product was purchased
- Type of product

Wireless communication is often subject to local radio regulations. Although Wireless LAN wireless networking products have been designed for operation in the license-free 2.4GHz and 5GHz band, local radio regulations may impose a number of limitations to the use of wireless communication equipment.

---

<b>Radio Frequency</b>	■ Band 5GHz (5150-5850 MHz) (Revision a and n draft 2.0)
	■ Band 2.4GHz (2400-2483.5 MHz) (Revision b/g and n draft 2.0)

---

The range of the wireless signal is related to the transmit rate of the wireless communication. Communications at lower transmit range may travel larger distances.

- The range of your wireless devices can be affected when the antennas are placed near metal surfaces and solid high-density materials.
- Range is also impacted due to “obstacles” in the signal path of the radio that may either absorb or reflect the radio signal.

## Supported Frequency Sub-bands

Subject to the radio regulations that apply in the countries/regions, your Wireless LAN module may support a different set of 5 GHz/2.4 GHz channels. Consult your Authorized Wireless LAN or TOSHIBA Sales office for information about the radio regulations that apply in the countries/regions.

## 2.4GHz Band Channels Sets (Wireless IEEE 802.11 Revision b, g and n draft 2.0)

Frequency Range Channel ID	2400-2483.5 MHz
1	2412
2	2417
3	2422
4	2427
5	2432
6	2437
7	2442
8	2447
9	2452
10	<b>2457</b> *1
11	2462
12	<b>2467</b> *2
13	<b>2472</b> *2

\*1 Factory-set default channels

\*2 The approved channels on using are different at each country or region. The channel configuration is managed as follows:

- For wireless clients that operate in a Wireless LAN Infrastructure, the Wireless LAN module will automatically start operation at the channel identified by the Wireless LAN Access Point. When roaming between different access points the station can dynamically switch to another channel if required.
- For Wireless LAN modules installed in wireless clients that operating in a peer-to-peer mode, the module will use the default channel 10.
- In a Wireless LAN Access Point, the Wireless LAN module will use the factory-set default channel (printed in bold), unless the LAN Administrator selected a different channel when configuring the Wireless LAN Access Point device.

## 5GHz Band Channels Sets (Wireless IEEE 802.11 Revision a and n draft 2.0)

Frequency Range <b>Channel ID</b>	5150-5850 MHz
34	<b>5170*</b>
36	<b>5180*</b>
38	<b>5190*</b>
40	<b>5200*</b>
42	<b>5210*</b>
44	<b>5220*</b>
46	<b>5230*</b>
48	<b>5240*</b>
52	<b>5260*</b>
56	<b>5280*</b>
60	<b>5300*</b>
64	<b>5320*</b>
100	<b>5500*</b>
104	<b>5520*</b>
108	<b>5540*</b>
112	<b>5560*</b>
116	<b>5580*</b>
120	<b>5600*</b>
124	<b>5620*</b>
128	<b>5640*</b>
132	<b>5660*</b>
136	<b>5680*</b>
140	<b>5700*</b>
149	<b>5745*</b>
153	<b>5765*</b>
157	<b>5785*</b>
161	<b>5805*</b>
165	<b>5825*</b>

\* The approved channels on using are different at each country or region. The channel configuration is managed as follows:

- For wireless clients that operate in a Wireless LAN Infrastructure, the Wireless LAN module will automatically start operation at the channel identified by the Wireless LAN Access Point. When roaming between different access points the station can dynamically switch to another channel if required.
- For Wireless LAN modules installed in wireless clients that operating in a peer-to-peer mode, the module will use the default channel 10.
- In a Wireless LAN Access Point, the Wireless LAN module will use the factory-set default channel (printed in bold), unless the LAN Administrator selected a different channel when configuring the Wireless LAN Access Point device.





# Appendix D

## Bluetooth wireless technology Interoperability

Bluetooth Adaptor from TOSHIBA are designed to be interoperable with any product with Bluetooth wireless technology that is based on Frequency Hopping Spread Spectrum (FHSS) radio technology, and is compliant to:

- Bluetooth Specification Ver. 2.1+EDR, as defined and approved by The Bluetooth Special Interest Group.
- Logo certification with Bluetooth wireless technology as defined by The Bluetooth Special interest Group.



- *When you use Bluetooth Adaptor from TOSHIBA close to 2.4 GHz Wireless LAN devices, Bluetooth transmissions might slow down or cause errors. If you detect certain interference while you use Bluetooth Adaptor from TOSHIBA, always change the frequency, move your computer to the area outside of the interference range of 2.4 GHz Wireless LAN devices (40 meters/43.74 yards or more) or stop transmitting from your computer.  
Please visit the following TOSHIBA PC product support website.*
- *Bluetooth and Wireless LAN devices operate within the same radio frequency range and may interfere with one another. If you use Bluetooth and Wireless LAN devices simultaneously, you may occasionally experience a less than optimal network performance or even lose your network connection.  
If you should experience any such problem, immediately turn off either one of your Bluetooth or Wireless LAN.  
Please visit the following TOSHIBA PC product support website.*

*TOSHIBA PC product support website.*

*In Europe visit <http://www.toshiba-europe.com/computers/tnt/bluetooth.htm>*

*In the United States visit <http://www.pc.support.global.toshiba.com>*

## Bluetooth wireless technology and your Health

The products with Bluetooth wireless technology, like other radio devices, emit radio frequency electromagnetic energy. The level of energy emitted by devices with Bluetooth wireless technology however is far much less than the electromagnetic energy emitted by wireless devices like for example mobile phones.

Because products with Bluetooth wireless technology operate within the guidelines found in radio frequency safety standards and recommendations, TOSHIBA believes Bluetooth wireless technology is safe for use by consumers. These standards and recommendations reflect the consensus of the scientific community and result from deliberations of panels and committees of scientists who continually review and interpret the extensive research literature.

In some situations or environments, the use of Bluetooth wireless technology may be restricted by the proprietor of the building or responsible representatives of the organization. These situations may for example include:

- Using the equipment with Bluetooth wireless technology on board of airplanes, or
- In any other environment where the risk of interference to other devices or services is perceived or identified as harmful.

If you are uncertain of the policy that applies on the use of wireless devices in a specific organization or environment (e.g. airports), you are encouraged to ask for authorization to use the device with Bluetooth wireless technology prior to turning on the equipment.

## Regulatory statements

### General

This product complies with any mandatory product specification in any country/region where the product is sold. In addition, the product complies with the following.

### European Union (EU) and EFTA

This equipment complies with the R&TTE directive 1999/5/EC and has been provided with the CE mark accordingly.

# Appendix E

## AC Power Cord and Connectors

The power cord's AC input plug must be compatible with the various international AC power outlets and the cord must meet the standards for the country/region in which it is used. All cords must meet the following specifications:

<b>Length:</b>	Minimum 1.7 meters
<b>Wire size:</b>	Minimum 0.75 mm <sup>2</sup>
<b>Current rating:</b>	Minimum 2.5 amperes
<b>Voltage rating:</b>	125 or 250 VAC (depending on country/region's power standards)

## Certification agencies

<b>U.S. and Canada:</b>	UL listed and CSA certified No. 18 AWG, Type SVT or SPT-2		
<b>Australia:</b>	AS		
<b>Japan:</b>	DENANHO		
<b><i>Europe:</i></b>			
<b>Austria:</b>	OVE	<b>Italy:</b>	IMQ
<b>Belgium:</b>	CEBEC	<b>The Netherlands:</b>	KEMA
<b>Denmark:</b>	DEMKO	<b>Norway:</b>	NEMKO
<b>Finland:</b>	FIMKO	<b>Sweden:</b>	SEMKO
<b>France:</b>	LCIE	<b>Switzerland:</b>	SEV
<b>Germany:</b>	VDE	<b>United Kingdom:</b>	BSI

In Europe, two conductors power cord must be VDE type, H05VVH2-F or H03VVH2-F and for three conductors power cord must be VDE type, H05VV-F.

For the United States and Canada, two pin plug configuration must be a 2-15P (250V) or 1-15P (125V) and three pin plug configuration must be 6-15P (250V) or 5-15P (125V) as designated in the U.S. National Electrical code handbook and the Canadian Electrical Code Part II.

The following illustrations show the plug shapes for the U.S.A. and Canada, the United Kingdom, Australia and Europe.

**USA**

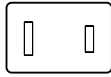

UL approved

**United Kingdom**

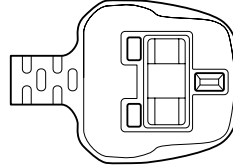

BS approved

**Australia**

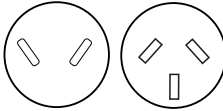

AS approved

**Europe**

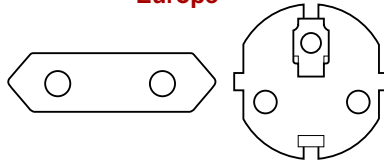

Approved by the appropriate agency

**Canada**

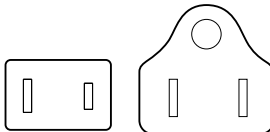

CSA approved

# Appendix F

## Usage Restrictions

This appendix describes the Usage Restrictions.

- This configuration is designed to work with a signal from a conventional (standard or analog) TV antenna.
- TOSHIBA does not guarantee that signals received by satellite or cable TV receivers will work properly and does not provide technical support for them.
- The TOSHIBA Qosmio's AC power adaptor must be connected to get the best possible audio and video performance.
- For copyright protection reasons, TOSHIBA has incorporated CGMS (Copy Generation Management System) restrictions into this product. This allows a broadcasting channel to send a signal to prevent a motion picture from being copied.
- The Microsoft Windows Vista's radio features cannot be used because the TV feature does not include a radio receiver (FM tuner).
- If your computer is equipped with a single tuner, it is not possible to record a TV program on one channel and simultaneously view a TV program on another channel because the computer only has one TV feature. However, it is possible to view one recorded TV program and simultaneously record another.
- The TV feature lets you capture and record a video stream (S-Video/ Composite Video) from a camcorder, DVD player, etc. Because of the large number of peripherals currently on the market, TOSHIBA does not guarantee that this type of configuration will work properly and does not provide support for this functionality.



# Appendix G

## If your computer is stolen



*Always take care of your computer and try to prevent it from being stolen. You are the owner of a valuable technical device, which may be highly attractive to thieves, so please do not leave it unattended in a public place. To further help protect against theft, security cables can be bought for use with your notebook when it is being used at home or in the office.*

*Make a note of your computer's machine type, model number, and serial number, and put it in a safe place. You will find this information on the underside of your notebook. Please also keep the receipt of the computer you purchased.*

**Should your computer be stolen**, however, we'll help you try to find it. Before contacting TOSHIBA, please prepare the following information which is necessary to uniquely identify your computer:

- In which country was your computer stolen?
- What type of machine do you have?
- What was the model number (PA number)?
- What was the serial number (8 digits)?
- When was it stolen, i.e. date?
- What is your address, phone, and fax number?

***To register the theft on paper, please follow these procedures:***

- Fill in the TOSHIBA Theft Registration form (or a copy of it) below.
- Attach a copy of your receipt showing where your computer was purchased.
- Either fax or send the receipt and registration form to the address below.

***To register the theft online, please follow these procedures:***

- Visit [www.toshiba-europe.com](http://www.toshiba-europe.com) on the Internet. In the product area, choose **Computer Systems**.
- In the Computer Systems page, open the **Support & Downloads** menu and choose the **Stolen Units Database** option.

Your entries are used to track your computer at our service points.





# Glossary

The terms in this glossary cover topics related to this manual. Alternate naming is included for reference.

## Abbreviations

- AACS:** advanced access content system
- AC:** Alternating current
- ACPI:** Advanced Configuration and Power Interface
- ASCII:** American Standard Code for Information Interchange
- BIOS:** basic input/output system
- bps:** bits per second
- CD:** compact disc
- CD-ROM:** Compact Disc Read-Only Memory
- CD-RW:** Compact Disc-ReWritable
- CMOS:** complementary metal-oxide semiconductor
- CPU:** central processing unit
- CRT:** cathode ray tube
- DC:** direct current
- DDC:** display data channel
- DDR:** double data rate
- DIMM:** dual inline memory module
- DVD:** digital versatile disc
- DVD-R:** Digital Versatile Disc Recordable
- DVD-RAM:** Digital Versatile Disc Random Access Memory
- DVD-R (Dual Layer):** Digital Versatile Disc Recordable Dual Layer
- DVD-ROM:** Digital Versatile Disc Read Only Memory
- DVD-RW:** Digital Versatile Disc ReWritable
- DVD+R (Double Layer):** Digital Versatile Disc Recordable Double Layer
- FDD:** floppy diskette drive
- FHD:** Full High Definition
- FIR:** fast infrared
- GB:** gigabyte
- HDD:** hard disk drive
- HD+:** High Definition Plus
- IDE:** integrated drive electronics
- IEEE:** Institute of Electrical and Electronics Engineers
- I/O:** input/output

**IrDA:** Infrared Data Association  
**IRQ:** interrupt request  
**KB:** kilobyte  
**LAN:** local area network  
**LCD:** liquid crystal display  
**LED:** light emitting diode  
**MB:** megabyte  
**MMC:** multi media card  
**OCR:** optical character recognition (reader)  
**PCB:** printed circuit board  
**PCI:** peripheral component interconnect  
**RAM:** random access memory  
**RGB:** red, green, and blue  
**ROM:** read only memory  
**RTC:** real time clock  
**S/P DIF:** Sony/Philips Digital Interface Format  
**SDRAM:** synchronous dynamic random access memory  
**SLI:** Scalable Link Interface  
**SO-DIMM:** small-outline dual in line memory module  
**TFT:** thin-film transistor  
**USB:** Universal Serial Bus  
**VESA:** Video Electronic Standards Association  
**VGA:** video graphics array  
**XGA:** extended graphics array

## A

**adaptor:** A device that provides a compatible connection between two units. For example, the computer's internal display adapter receives information from the software and translates it into images on the screen. An adapter can take a number of forms, from a microprocessor to a simple connector: An intelligent adapter (one that is capable of doing some processing) may also be called a controller.

**alphanumeric:** Keyboard characters including letters, numbers and other symbols, such as punctuation marks or mathematical symbols.

**alternating current (AC):** Electric current that reverses its direction of flow at regular intervals.

**analog signal:** A signal whose characteristics such as amplitude and frequency vary in proportion to (are an analog of) the value to be transmitted. Voice communications are analog signals.

**application:** A group of programs that together are used for a specific task such as accounting, financial planning, spreadsheets, word processing and games.

**ASCII:** American Standard Code for Information Interchange. ASCII code is a set of 256 binary codes that represent the most commonly used letters, numbers, and symbols.

**asynchronous:** Lacking regular time relationship. As applied to computer communications, asynchronous refers to the method of transmitting data that does not require a steady stream of bits to be transmitted at regular time intervals.

## B

**backup:** A copy of a file, usually on a removable disk, kept in case the original file is lost or damaged.

**binary:** The base two number system composed of zeros and ones (off or on), used by most digital computers. The right-most digit of a binary number has a value of 1, the next a value of 2, then 4, 8, 16, and so on. For example, the binary number 101 has a value of 5. *See also* ASCII.

**BIOS:** Basic Input/Output System. The firmware that controls data flow within the computer. *See also* firmware.

**bit:** Derived from “binary digit,” the basic unit of information used by the computer. It is either zero or one. Eight bits is one byte. *See also* byte.

**Bluetooth:** A short-range radio technology designed to simplify wireless communication among computers, communication devices and the Internet.

**board:** A circuit board. An internal card containing electronic components, called chips, which perform a specific function or increase the capabilities of the system.

**boot:** Short for bootstrap. A program that starts or restarts the computer. The program reads instructions from a storage device into the computer’s memory.

**boot disk:** *See* system disk.

**bootable disk:** *See* system disk.

**bps:** Bits per second. Typically used to describe the data transmission speed of a modem.

**buffer:** The portion of the computer’s memory where data is temporarily stored. Buffers often compensate for differences in the rate of flow from one device to another.

**bus:** An interface for transmission of signals, data or electric power.

**byte:** The representation of a single character. A sequence of eight bits treated as a single unit; also the smallest addressable unit within the system.

## C

**cache memory:** A section of very fast memory in which frequently used information is duplicated for quick access. Accessing data from cache is faster than accessing it from the computer's main memory. See also L1 cache, L2 cache.

**capacity:** The amount of data that can be stored on a magnetic storage device such as a floppy diskette or hard disk drive. It is usually described in terms of kilobytes (KB), where one KB = 1024 bytes, megabytes (MB), where one MB = 1024 KB and gigabytes (GB), where one GB = 1024 MB.

**CD:** An individual compact disc. See also CD-ROM.

**CD-R:** A Compact Disc-Recordable disc can be written once and read many times. See also CD-ROM.

**CD-ROM:** A Compact Disc Read-Only Memory is a high capacity disc that can be read from but not written to. The CD-ROM drive uses a laser, rather than magnetic heads, to read data from the disc.

**CD-RW:** A Compact Disc-ReWritable disc can be rewritten many times. See also CD-ROM.

**character:** Any letter, number, punctuation mark, or symbol used by the computer. Also synonymous with byte.

**chassis:** The frame containing the computer.

**chip:** A small semiconductor containing computer logic and circuitry for processing, memory, input/output functions and controlling other chips.

**click:** To press and release the pointing device's primary button without moving the pointing device. In the Windows operating system, this refers to the pointing device's left button, unless otherwise stated. See also double-click.

**CMOS:** Complementary Metal-Oxide Semiconductor. An electronic circuit fabricated on a silicon wafer that requires very little power. Integrated circuits implemented in CMOS technology can be tightly packaged and are highly reliable.

**cold start:** Starting a computer that is currently off (turning on the power).

**COM1, COM2, COM3 and COM4:** The names assigned to the serial and communication ports.

**commands:** Instructions you enter at the terminal keyboard that direct the actions of the computer or its peripheral devices.

**compatibility:** 1) The ability of one computer to accept and process data in the same manner as another computer without modifying the data or the media upon which it is being transferred.  
2) the ability of one device to connect to or communicate with another system or component.

- components:** Elements or parts (of a system) which make up the whole (system).
- Composite Video (YUV):** A standard video signal used to transmit images, e.g. from a VCR to a TV.
- computer program:** A set of instructions written for a computer that enable it to achieve a desired result.
- computer system:** A combination of hardware, software, firmware, and peripheral components assembled to process data into useful information.
- configuration:** The specific components in your system (such as the terminal, printer, and disk drives) and the settings that define how your system works. You use the HW Setup program to control your system configuration.
- controller:** Built-in hardware and software that controls the functions of a specific internal or peripheral device (e.g. keyboard controller).
- co-processor:** A circuit built into the processor that is dedicated to intensive math calculations.
- CPU:** Central Processing Unit. The portion of the computer that interprets and executes instructions.
- CRT:** Cathode Ray Tube. A vacuum tube in which beams projected on a fluorescent screen-producing luminous spots. An example is the television set.
- cursor:** A small, blinking rectangle or line that indicates the current position on the display screen.

## D

- data:** Information that is factual, measurable or statistical that a computer can process, store, or retrieve.
- data bits:** A data communications parameter controlling the number of bits (binary digits) used to make up a byte. If data bits = 7 the computer can generate 128 unique characters. If data bits = 8 the computer can generate 256 unique characters.
- DC:** Direct Current. Electric current that flows in one direction. This type of power is usually supplied by batteries.
- default:** The parameter value automatically selected by the system when you or the program do not provide instructions. Also called a preset value.
- delete:** To remove data from a disk or other data storage device. Synonymous with erase.
- device driver:** A program (called a “driver”) that permits a computer to communicate with a device.
- dialog box:** A window that accepts user input to make system settings or record other information.

- disable:** To turn a computer option off. See also enable.
- Digital Audio:** An audio compression standard that enables high-quality transmission and real-time playback of sound files.
- disk drive:** The device that randomly accesses information on a disk and copies it to the computer's memory. It also writes data from memory to the disk. To accomplish these tasks, the unit physically rotates the disk at high speed past a read-write head.
- disk storage:** Storing data on magnetic disk. Data is arranged on concentric tracks much like a phonograph record.
- display:** A CRT, LCD, or other image producing device used to view computer output.
- documentation:** The set of manuals and/or other instructions written for the users of a computer system or application. Computer system documentation typically includes procedural and tutorial information as well as system functions.
- double click:** To press and release the pointing device's primary button rapidly twice without moving the pointing device. In the Windows operating system, this refers to the pointing device's left button, unless otherwise stated.
- driver:** A software program, generally part of the operating system, that controls a specific piece of hardware (frequently a peripheral device such as a printer or mouse).
- DVD:** An individual digital versatile (or video) disc. See also DVD-ROM.
- DVB-T (Digital Video Broadcasting - Terrestrial):** Also known as terrestrial digital TV. Digital TV broadcasting standard.
- DVD-R (+R, -R):** A Digital Versatile Disc Recordable disc can be written once and read many times. The DVD-R drive uses a laser to read data from the disc.
- DVD-RAM:** A Digital Versatile Disc-Random Access Memory is a high-capacity, high performance disc that lets you store large volumes of data. The DVD-RAM drive uses a laser to read data from the disc.
- DVD-ROM:** A Digital Versatile Disc-Read Only Memory is a high capacity, high performance disc suitable for play back of video and other high-density files. The DVD-ROM drive uses a laser to read data from the disc.
- DVD-RW (+RW, -RW):** A Digital Versatile Disc-ReWritable disc can be rewritten many times.

## E

**echo:** To send back a reflection of the transmitted data to the sending device. You can display the information on the screen, or output it to the printer, or both. When a computer receives back data it transmitted to a CRT (or other peripheral device) and then transmits the data to printer, the printer is said to echo the CRT.

**enable:** To turn on a computer option. See also disable.

**erase:** See delete.

**escape:** 1) A code (ASCII code 27), signaling the computer that what follows are commands; used with peripheral devices such as printers and modems.  
2) A means of aborting the task currently in progress.

**escape guard time:** A time before and after an escape code is sent to the modem which distinguishes between escapes that are part of the transmitted data, and escapes that are intended as a command to the modem.

**execute:** To interpret and execute an instruction.

## F

**fast infrared:** An industry standard that enables cableless infrared serial data transfer at speeds of up to 4 Mbps.

**file:** A collection of related information; a file can contain data, programs, or both.

**fingerprint sensor:** The fingerprint sensor compares and analyzes the unique characteristics in a fingerprint.

**firmware:** A set of instructions built into the hardware which controls and directs a microprocessor's activities.

**flash memory:** Non-volatile memory that can be written to as well as read. Information in flash memory remains whether or not the computer is receiving power. This type of memory is used to retain your fingerprint data. See also memory. Compare RAM and ROM.

**floppy diskette:** A removable disk that stores magnetically encoded data.

**floppy diskette drive (FDD):** An electromechanical device that reads and writes to floppy diskettes.

**Fn-esse:** A TOSHIBA utility that lets you assign functions to hot keys.

**folder:** An icon in Windows used to store documents or other folders.

**format:** The process of readying a blank disk for its first use. Formatting establishes the structure of the disk that the operating system expects before it writes files or programs onto the disk.

**function keys:** The keys labeled **F1** through **F9** that tell the computer to perform certain functions.

## G

**gigabyte (GB):** A unit of data storage equal to 1024 megabytes. *See also* megabyte.

**graphics:** Drawings, pictures, or other images, such as charts or graphs, to present information.

## H

**hard disk:** A storage device composed of a rigid platter or platters that can be magnetically coded with data. Hard disks hold much more information than diskettes and are used for long-term storage of programs and data. The primary (or only) hard disk in a computer is usually fixed, but some computers have secondary hard disks that are removable. By default, the hard disk is referred to as drive C.

**hard disk drive (HDD):** An electromechanical device that reads and writes a hard disk. *See also* hard disk.

**hardware:** The physical electronic and mechanical components of a computer system: typically, the computer itself, external disk drives, etc. *See also* software and firmware.

**hertz:** A unit of wave frequency that equals one cycle per second.

**host computer:** The computer that controls, regulates, and transmits information to a device or another computer.

**hot key:** The computer's feature in which certain keys in combination with the extended function key, **FN**, can be used to set system parameters, such as speaker volume.

**HW Setup:** A TOSHIBA utility that lets you set the parameters for various hardware components.

## I

**icon:** A small graphic image displayed on the screen or in the indicator panel. In Windows, an icon represents an object that the user can manipulate.

**i.LINK (IEEE1394):** This port enables high-speed data transfer directly from external devices such as digital video cameras.

**input:** The data or instructions you provide to a computer, communication device or other peripheral device from the keyboard or external or internal storage devices. The data sent (or output) by the sending computer is input for the receiving computer.

**instruction:** Statements or commands that specify how to perform a particular task.



**interface:** 1) Hardware and/or software components of a system used specifically to connect one system or device to another.  
2) To physically connect one system or device to another to exchange information.  
3) The point of contact between user, the computer, and the program, for example, the keyboard or a menu.

**interrupt request:** A signal that gives a component access to the processor.

**I/O:** Input/output. Refers to acceptance and transfer of data to and from a computer.

**I/O devices:** Equipment used to communicate with the computer and transfer data to and from it.

**IrDA 1.1:** An industry standard that enables cableless infrared serial data transfer at speeds of up to 4 Mbps.

## K

**K:** Taken from the Greek word kilo, meaning 1000; often used as equivalent to 1024, or 2 raised to the 10th power. See also byte and kilobyte.

**keyboard:** An input device containing switches that are activated by manually pressing marked keys. Each keystroke activates a switch that transmits a specific code to the computer. For each key, the transmitted code is, in turn, representative of the (ASCII) character marked on the key.

**kilobyte (KB):** A unit of data storage equal to 1024 bytes. See also byte and megabyte.

## L

**L1 cache:** Level one cache. Memory cache built into the processor to help improve processing speed. See also cache memory, L2 cache.

**L2 cache:** Memory cache installed on the motherboard to help improve processing speed. It is slower than L1 cache and faster than main memory. See also cache memory, L1 cache.

**LAN:** A group of computers or other devices dispersed over a relatively limited area and connected by a communications link that enables any device to interact with any other on the network.

**Light Emitting Diode (LED):** A semiconductor device that emits light when a current is applied.

**Liquid Crystal Display (LCD):** Liquid crystal sealed between two sheets of glass coated with transparent conducting material. The viewing-side coating is etched into character forming segments with leads that extend to the edge of the glass. Applying a voltage between the glass sheets alters the brightness of the liquid crystal.

## M

**main board:** See motherboard.

**megabyte (MB):** A unit of data storage equal to 1024 kilobytes. See also kilobyte.

**megahertz:** A unit of wave frequency that equals 1 million cycles per second. See also hertz.

**memory:** Typically refers to the computer's main memory, where programs are run and data is temporarily stored and processed. Memory can be volatile and hold data temporarily, such as RAM, or it can be nonvolatile and hold data permanently, such as ROM. A computer's main memory is RAM. See RAM, ROM.

**menu:** A software interface that displays a list of options on the screen. Also called a screen.

**microprocessor:** A hardware component contained in a single integrated circuit that carries out instructions. Also called the central processing unit (CPU), one of the main parts of the computer.

**mode:** A method of operation, for example, the Shut Down Mode, Sleep Mode or the Hibernation Mode.

**modem:** Derived from modulator/demodulator, a device that converts (modulates) digital data for transmission over telephone lines and then converts modulated data (demodulates) to digital format where received.

**monitor:** A device that uses rows and columns of pixels to display alphanumeric characters or graphic images. See also CRT.

**motherboard:** A name sometimes used to refer to the main printed circuit board in processing equipment. It usually contains integrated circuits that perform the processor's basic functions and provides connectors for adding other boards that perform special functions.

**MP3:** An audio compression standard that enables high-quality transmission and real-time playback of sound files.

## N

**network:** A collection of computers and associated devices that are connected by communications facilities. A network allows you to share data and peripheral devices, such as printers, with other users and to exchange electronic mail.

**non-system disk:** A disk for storing programs and data that cannot be used to start the computer. Compare system disk.

**nonvolatile memory:** Memory, usually read-only (ROM), that is capable of permanently storing information. Turning the computer's power off does not alter data stored in nonvolatile memory.

## O

**OCR:** Optical Character Recognition (reader). A technique or device that uses laser or visible light to identify characters and input them into a storage device.

**online state:** A functional state of a peripheral device when it is ready to receive or transmit data.

**operating system:** A group of programs that controls the basic operation of a computer. Operating system functions include interpreting programs, creating data files, and controlling the transmission and receipt (input/output) of data to and from memory and peripheral device.

**output:** The results of a computer operation. Output commonly indicates data.

1) printed on paper, 2) displayed at a terminal, 3) sent through the serial port of internal modem, or 4) stored on some magnetic media.

## P

**PAL:** PAL (Phase Alternating Line) is the dominant video and broadcasting standard in Europe.

**parity:** 1) The symmetrical relationship between two parameter values (integers) both of which are either on or off; odd or even; 0 or 1.  
2) In serial communications, an error detection bit that is added to a group of data bits making the sum of the bits even or odd. Parity can be set to none, odd, or even.

**password:** A unique string of characters used to identify a specific user. The computer provides various levels of password protection such as user and supervisor.

**PCI:** Peripheral Component Interconnect. An industry standard 32-bit bus.

**peripheral:** Any device, such as a printer or joystick, that is attached to the computer and controlled by the computer's CPU.

**Péritel:** Péritel is a 21-pin connecting cable/port system that allows images and high-quality stereo sound (including Dolby Pro-Logic sound formats) to be sent from one audio-visual device to another. It is also known as a "SCART connector" or "Euro connector".

**pixel:** A picture element. The smallest dot that can be made on a display or printer. Also called a pel.

**plug and play:** A capability with Windows that enables the system to automatically recognize connections of external devices and make the necessary configurations in the computer.

**pointing device:** Any device, such as the TouchPad or a mouse, that enables you to move the cursor on the screen.

**port:** The electrical connection through which the computer sends and receives data to and from devices or other computers.

**Power Saver:** A TOSHIBA utility that lets you set the parameters for various power-saving functions.

**program:** A set of instructions a computer can execute that enables it to achieve a desired result. *See also* application.

**prompt:** A message the computer provides indicating it is ready for or requires information or an action from you.

## R

**Radio frequency interference (RFI) shield:** A metal shield enclosing the printed circuit boards of the printer or computer to prevent radio and TV interference. All computer equipment generates radio frequency signals. The FCC regulates the amount of signals a computing device can allow past its shielding. A Class A device is sufficient for office use. Class B provides a more stringent classification for home equipment use. TOSHIBA portable computers comply with Class B computing device regulations.

**Random Access Memory (RAM):** Volatile memory that can be written to as well as read. Volatile here means that information in RAM is lost when you turn off your computer. This type of memory is used for your computer's main memory. *See also* memory. Compare ROM.

**resolution:** A measure of the sharpness of the images that can be produced by a printer or displayed on a screen. For a printer, resolution is expressed in dots per inch (dpi). For a screen, it is expressed as the number of pixels available horizontally and vertically

**restart:** Resetting a computer without turning it off (also called "warm boot", "soft reset" or "reboot"). *See also* boot.

**RGB:** Red, green and blue. A device that uses three input signals, each activating an electron gun for a primary additive color (red, green and blue) or port for using such a device. *See also* CRT.

**RJ11:** A modular telephone jack.

**RJ45:** A modular LAN jack.

**Read Only Memory (ROM):** Non-volatile memory that can be read but not written to. Non-volatile here means that information in ROM remains whether or not the computer is receiving power. This type of memory is used to store your computer's BIOS, which is essential instructions the computer reads when you start it up. *See also* BIOS, memory. Compare RAM.

## S

**S/P DIF: A standard of digital interface for audio.**

**SCSI:** Small Computer System Interface is an industry standard interface for connection of a variety of peripheral devices.

**SD/SDHC memory card:** Secure Digital cards are flash memory widely used in a variety of digital devices such as digital cameras and Personal Digital Assistants.

**SECAM L:** SECAM (Sequential Couleur A Memorie) is a broadcasting standard used in France.

**SIO:** Serial Input/Output. The electronic methodology used in serial data transmission.

**soft key:** Key combinations that emulate keys on the IBM keyboard, change some configuration options, stop program execution, and access the numeric keypad overlay.

**software:** The set of programs, procedures and related documentation associated with a computer system. Specifically refers to computer programs that direct and control the computer system's activities. See *also* hardware.

**stop bit:** One or more bits of a byte that follow the transmitted character or group codes in asynchronous serial communications.

**synchronous:** Having a constant time interval between successive bits, characters or events.

**system disk:** A diskette that contains the operating system files needed to start the computer. Any diskette can be formatted as a system disk. A system disk is also called a "bootable disk", "boot disk" or a "startup disk." Compare non-system disk.

## T

**terminal:** A typewriter-like keyboard and CRT display screen connected to the computer for data input/output.

**TFT display:** A liquid crystal display (LCD) made from an array of liquid crystal cells using active-matrix technology with thin film transistor (TFT) to drive each cell.

**Touch Pad:** A pointing device integrated into the TOSHIBA computer palm rest.

## U

**USB: Universal Serial Bus.** This serial interface lets you communicate with several devices connected in a chain to a single port on the computer.

## V

**VGA:** Video Graphics Array is an industry standard video adaptor that lets you run any popular software.

**volatile memory:** Random access memory (RAM) that stores information as long as power is supplied to the computer.

## W

**warm start:** Restarting or resetting a computer without turning it off.

**Wi-Fi:** A registered trademark term of the Wi-Fi Alliance that stands for Wireless Fidelity, and is another term for the communication protocol to permit an Ethernet connection using wireless communication components.

**window:** A portion of the screen that can display its own application, document or dialog box. Often used to mean a Microsoft Windows window.

**Wireless LAN:** Local Area Network (LAN) through wireless communication.

**write protection:** A method for protecting a floppy diskette from accidental erasure.

# Index

## A

- AC adaptor, 1-5
  - additional, 1-18
  - connecting, 3-2
  - DC IN 19V jack, 2-5
- ASCII characters, 5-5

## B

- Battery
  - charging, 6-6
  - extending battery life, 6-8
  - indicator, 2-11, 6-2
  - Monitoring capacity, 6-7
  - real time clock, 1-5, 6-4
  - save mode, 1-12
  - types, 6-4
- Battery Charger, 1-18, 9-13
- Battery pack, 1-5, 2-7
  - additional, 9-12
  - replacing, -xii, 6-8
- Bluetooth, 1-10, 4-38
  - Bluetooth Stack for Windows by Toshiba, 1-16
  - problems, 10-23
- Boot Priority, 7-3
- Bridge media slot, 1-8, 2-2, 9-3
  - indicator, 2-11
  - using, 9-3

## C

- Cache memory, 1-3
- Cleaning the computer, 4-42
- Cooling vents, 2-6

## D

- DC IN indicator, 2-11, 6-3
- Display, 1-6, 2-8
  - automatic power off, 1-11
  - brightness down, 5-3
  - brightness up, 5-3
  - controller, B-1
  - hinge, 2-8
  - opening, 3-4
  - screen, 2-8
- DVD Super Multi drive, 1-6
  - problems, 10-9
  - using, 4-15
  - writing, 4-18

## E

- Equipment checklist, 1-1
- eSATA device, 9-15
  - problems, 10-18
- eSATA/USB combo port, 2-6
- ExpressCard, 1-8, 9-2
  - inserting, 9-2
  - problems, 10-11
  - removing, 9-3
- External monitor, 1-7, 2-5, 9-16
  - problems, 10-21

## F

- Fingerprint Sensor
  - location, 2-8
  - problems, 10-16
  - using, 4-2
- FN + 1 (TOSHIBA Zooming Utility reduce), 5-4
- FN + 2 (TOSHIBA Zooming Utility enlarge), 5-4
- FN + ESC (Mute), 5-2
- FN + F1 (Lock), 5-2
- FN + F2 (Power Plan), 5-2
- FN + F3 (Sleep), 5-3
- FN + F4 (Hibernate), 5-3
- FN + F5 (Output), 5-3
- FN + F6 (Brightness Down), 5-3
- FN + F7 (Brightness Up), 5-3
- FN + F8 (Wireless), 5-3
- FN + F9 (Touch Pad), 5-3
- FN + space (Zoom), 5-4
- Front operation panel, 8-2
- Function keys, 5-2

**G**

Graphics controller, 1-7

**H**

Hard disk drive, 1-5

automatic power off, 1-11

Heat dispersal, 1-12

Hibernation Mode, 1-12

Hot keys, 1-11

Brightness (Down), 5-3

Brightness (Up), 5-3

Hibernate, 5-3

Lock, 5-2

Mute, 5-2

Output, 5-3

Power Plan, 5-2

Sleep, 5-3

TOSHIBA Zooming Utility (enlarge),  
5-4

TOSHIBA Zooming Utility (reduce),  
5-4

Touch Pad, 5-3

Wireless, 5-3

Zoom, 5-4

HW Setup

accessing, 7-1

Boot Priority, 7-3

CPU, 7-6

device config, 7-7

display, 7-2

general, 7-2

keyboard, 7-5

LAN, 7-6

USB, 7-7

window, 7-1

**I**

i.LINK, 1-8, 2-3, 9-19

connecting, 9-20

disconnecting, 9-21

precautions, 9-19

problems, 10-24

Indicators

Battery, 2-11, 6-2

Bridge media slot, 2-11

DC IN, 2-11

Hard Disk Drive, 2-11

Power, 2-11

Infrared receiver window, 1-9, 2-2

problems, 10-13

**K**

Keyboard, 1-7, 5-1

FN Sticky key, 5-4

Function keys F1 ... F12, 5-2

Hot keys, 5-2

problems, 10-7

Typewriter keys, 5-1

Windows special keys, 5-4

**L**

LAN, 1-10, 4-40

active indicator, 2-6

cable types, 4-40

connecting, 4-41

disconnecting, 4-42

jack, 2-6

Link indicator, 2-6

problems, 10-23

**M**

Media care, 4-27

Card care, 9-5

CD/DVDs, 4-27

floppy diskettes, 4-28

Memory card care, 9-6

Memory, 1-3

additional, 1-18, 9-8

installing, 9-9

removing, 9-11

Memory Stick/Memory Stick Duo/Memory

Stick PRO/Memory Stick PRO Duo

care, 9-5

inserting, 9-6

problems, 10-12

removing, 9-7



- Modem, 1-10, 4-33
  - connecting, 4-36
  - disconnecting, 4-36
  - jack, 2-4
  - problems, 10-22
  - properties menu, 4-34
  - region selection, 4-34
- Moving the computer, 4-43
- MultiMediaCard
  - inserting, 9-6
  - problems, 10-13
  - removing, 9-7
- P**
- Password
  - power on, 1-11
  - problems, 10-7
  - starting the computer by, 6-12
  - supervisor, 6-12
  - user, 6-11
- Pointing device
  - Touch Pad, 2-9, 4-1
  - Touch Pad control buttons, 2-9, 4-1
- Ports, 1-7
  - External monitor, 1-7
  - i.LINK, 1-8
  - USB, 1-7
- Power
  - button location, 2-8
  - conditions, 6-1
  - Hibernation Mode, 3-8
  - indicator, 6-3
  - panel on/off, 1-12
  - panel power on/off, 6-13
  - Shut Down Mode, 3-6
  - Sleep Mode, 3-6
  - turning off, 3-6
  - turning on, 3-5
- Power-up modes, 6-13
- Problems
  - AC power, 10-5
  - Additional memory module, 10-19
  - Analyzing the problem, 10-2
  - Battery, 10-6
  - Bluetooth, 10-23
  - DVD Super Multi drive, 10-9
  - eSATA device, 10-18
  - ExpressCard, 10-11
  - External monitor, 10-21
  - Fingerprint Sensor, 10-16
  - Hard disk drive, 10-8
  - Hardware and system checklist, 10-3
  - HDMI monitor output function, 10-24
  - i.LINK (IEEE1394) device, 10-24
  - Infrared receiver window, 10-13
  - Internal display panel, 10-8
  - Keyboard, 10-7
  - LAN, 10-23
  - Memory Stick/Memory Stick Duo/  
Memory Stick PRO/Memory Stick  
PRO Duo, 10-12
  - Modem, 10-22
  - MultiMediaCard, 10-13
  - Overheating power down, 10-5
  - Password, 10-7
  - Pointing device, 10-13
  - Power, 10-4
  - Real Time Clock, 10-7
  - Recovery Discs, 10-25
  - SD/SDHC memory card, miniSD/  
microSD Card, 10-11
  - Self test, 10-4
  - Sound system, 10-20
  - System start-up, 10-4
  - TOSHIBA support, 10-26
  - Touch Pad, 10-13
  - USB device, 10-16
  - USB floppy diskette drive, 10-10
  - USB mouse, 10-15
  - USB Sleep and Charge, 10-7
  - Video Playback, 10-25
  - Volume control dial, 10-20
  - Wireless LAN, 10-23
  - xD picture card, 10-12
- Processor, 1-3
- R**
- Recovery Discs, 3-12
  - problems, 10-25
- Recovery hard disk drive, 3-11, 3-12
- Remote Controller, 8-4
  - Full size remote controller, 8-5
- Restarting the computer, 3-10

**S**

- SD/SDHC memory card, miniSD/microSD Card
  - care, 9-5
  - formatting, 9-5
  - inserting, 9-6
  - note, 9-4
  - problems, 10-11
  - removing, 9-7
- Security lock, 9-21
  - location, 2-4
- Sleep Mode, 1-12
  - setting, 3-6
  - System automatic, 1-11
- Sound system, 1-8, 4-31
  - Headphone, S/PDIF and Line out jack, 1-9, 2-4
  - microphone, 2-10
  - Microphone and Line in jack, 1-9, 2-4
  - Stereo speakers, 2-8
  - Volume control dial, 2-10

**T**

- TOSHIBA Assist, 1-16
- TOSHIBA ConfigFree, 1-16
- TOSHIBA Disc Creator, 1-16, 4-23
- TOSHIBA PC Diagnostic Tool, 1-13
- TOSHIBA SD Memory Card Format, 1-16
- TOSHIBA support, 10-25
- TOSHIBA Theft Registration, G-2
- TOSHIBA Zooming Utility, 1-13
- Touch Pad, 1-7
  - location, 2-8
  - using, 4-1
- TV Tuner, 1-9, 4-29

**U**

- USB device, 1-7
  - location, 2-4
  - problems, 10-16
- USB floppy diskette drive, 9-13
  - problems, 10-10

**V**

- Video modes, B-1
- Video RAM, 1-4
- Volume control dial, 2-10
  - problems, 10-20

**W**

- Web Camera, 1-8, 2-10, 4-10
- Windows Mobility Center, 1-17
- Wireless communication, 4-37
  - indicator, 4-40
- Wireless communication switch, 1-11, 2-1, 4-39
- Wireless LAN, 1-10, 4-37
  - problems, 10-23

**X**

- xD picture card
  - inserting, 9-6
  - problems, 10-12
  - removing, 9-7

## Free Manuals Download Website

<http://myh66.com>

<http://usermanuals.us>

<http://www.somanuals.com>

<http://www.4manuals.cc>

<http://www.manual-lib.com>

<http://www.404manual.com>

<http://www.luxmanual.com>

<http://aubethermostatmanual.com>

Golf course search by state

<http://golfingnear.com>

Email search by domain

<http://emailbydomain.com>

Auto manuals search

<http://auto.somanuals.com>

TV manuals search

<http://tv.somanuals.com>