

TOSHIBA

Leading Innovation >>>

Satellite[®]/Satellite Pro[®] C800/L800/S800 Series User's Guide

If you need assistance:

Technical support is available online at Toshiba's Web site at support.toshiba.com. At this Web site, you will find answers for many commonly asked technical questions plus many downloadable software drivers, BIOS updates, and other downloads.

For more information, see "If Something Goes Wrong" on [page 128](#) in this guide.

▲ WARNING

Handling the cord on this product will expose you to lead, a chemical known to the State of California to cause birth defects or other reproductive harm. ***Wash hands after handling.***



For the state of California only.

Model: Satellite®/Satellite Pro® C800/L800/S800 Series

Recordable and/or ReWritable Drive(s) and Associated Software Warranty

The computer system you purchased may include Recordable and/or ReWritable optical disc drive(s) and associated software, among the most advanced data storage technologies available. As with any new technology, you must read and follow all set-up and usage instructions in the applicable user guides and/or manuals enclosed or provided electronically. If you fail to do so, this product may not function properly and you may lose data or suffer other damage. TOSHIBA AMERICA INFORMATION SYSTEMS, INC. ("TOSHIBA"), ITS AFFILIATES AND SUPPLIERS DO NOT WARRANT THAT OPERATION OF THE PRODUCT WILL BE UNINTERRUPTED OR ERROR FREE. YOU AGREE THAT TOSHIBA, ITS AFFILIATES AND SUPPLIERS SHALL HAVE NO RESPONSIBILITY FOR DAMAGE TO OR LOSS OF ANY BUSINESS, PROFITS, PROGRAMS, DATA, NETWORK SYSTEMS OR REMOVABLE STORAGE MEDIA ARISING OUT OF OR RESULTING FROM THE USE OF THE PRODUCT, EVEN IF ADVISED OF THE POSSIBILITY THEREOF.

Protection of Stored Data

For your important data, please make periodic back-up copies of all the data stored on the hard disk or other storage devices as a precaution against possible failures, alteration, or loss of the data. **IF YOUR DATA IS ALTERED OR LOST DUE TO ANY TROUBLE, FAILURE OR MALFUNCTION OF THE HARD DISK DRIVE OR OTHER STORAGE DEVICES AND THE DATA CANNOT BE RECOVERED, TOSHIBA SHALL NOT BE LIABLE FOR ANY DAMAGE OR LOSS OF DATA, OR ANY OTHER DAMAGE RESULTING THEREFROM. WHEN COPYING OR TRANSFERRING YOUR DATA, PLEASE BE SURE TO CONFIRM WHETHER THE DATA HAS BEEN SUCCESSFULLY COPIED OR TRANSFERRED. TOSHIBA DISCLAIMS ANY LIABILITY FOR THE FAILURE TO COPY OR TRANSFER THE DATA CORRECTLY.**

Critical Applications

The computer you have purchased is not designed for any “critical applications.” “Critical applications” means life support systems, medical applications, connections to implanted medical devices, commercial transportation, nuclear facilities or systems or any other applications where product failure could lead to injury to persons or loss of life or catastrophic property damage.

ACCORDINGLY, TOSHIBA, ITS AFFILIATES AND SUPPLIERS DISCLAIM ANY AND ALL LIABILITY ARISING OUT OF THE USE OF THE COMPUTER PRODUCTS IN ANY CRITICAL APPLICATIONS. IF YOU USE THE COMPUTER PRODUCTS IN A CRITICAL APPLICATION, YOU, AND NOT TOSHIBA, ASSUME FULL RESPONSIBILITY FOR SUCH USE.

FCC Notice “Declaration of Conformity Information”

This equipment has been tested and found to comply with the limits for a Class B digital device, pursuant to Part 15 of the FCC rules. These limits are designed to provide reasonable protection against harmful interference in a residential installation.

This equipment generates, uses and can radiate radio frequency energy and, if not installed and used in accordance with the instructions, it may cause harmful interference to radio communications. However, there is no guarantee that interference will not occur in a particular installation. If this equipment does cause harmful interference to radio or television reception, which can be determined by turning the equipment off and on, the user is encouraged to try to correct the interference by one or more of the following measures:

- ❖ Reorient or relocate the receiving antenna.
- ❖ Increase the separation between the equipment and receiver.
- ❖ Connect the equipment to an outlet on a circuit different from that to which the receiver is connected.
- ❖ Consult the dealer or an experienced radio/TV technician for help.

NOTE

Only Peripherals complying with the FCC Class B limits may be attached to this equipment. Operation with noncompliant peripherals or peripherals not recommended by Toshiba is likely to result in interference to radio and TV reception. Shielded cables must be used between the external devices and the computer's ports. Changes or modifications made to this equipment not expressly approved by Toshiba or parties authorized by Toshiba could void the user's authority to operate the equipment.

This device complies with Part 15 of the FCC Rules. Operation is subject to the following two conditions:

- ❖ This device may not cause harmful interference.
- ❖ This device must accept any interference received, including interference that may cause undesired operation.

Contact Toshiba's Support Web site at support.toshiba.com.

Industry Canada Requirement

This Class B digital apparatus complies with Canadian ICES-003.

Cet appareil numérique de la classe B est conforme à la norme NMB-003 du Canada.

Wireless Interoperability

The TOSHIBA Wireless LAN Mini PCI Card products are designed to be interoperable with any wireless LAN product that is based on Direct Sequence Spread Spectrum (DSSS) radio technology, and is compliant to:

- ❖ The IEEE 802.11 Standard on Wireless LANs (Revision A/B/G), as defined and approved by the Institute of Electrical and Electronics Engineers.
- ❖ The Wireless Fidelity (Wi-Fi®) certification as defined by the Wi-Fi Alliance. The "Wi-Fi CERTIFIED" logo is a certification mark of the Wi-Fi Alliance.

CAUTION

Bluetooth® and Wireless LAN devices operate within the same radio frequency range and may interfere with one another. If you use *Bluetooth* and Wireless LAN devices simultaneously, you may occasionally experience a less than optimal network performance or even lose your network connection.

If you should experience any such problem, immediately turn off your *Bluetooth* or Wireless LAN device.

Please contact Toshiba computer product support on Web site <http://www.toshiba-europe.com/computers/tnt/bluetooth.htm> in Europe or support.toshiba.com in the United States for more information.

CAUTION

Radio Frequency Interference Requirements

This device is restricted to indoor use due to its operation in the 5.15 GHz to 5.25 GHz frequency range. FCC requires this product to be used indoors for frequency range 5.15 GHz to 5.25 GHz to reduce the potential for harmful interference to co-channel Mobile Satellite systems.

High power radars are allocated as primary users of the 5.25 GHz to 5.35 GHz and 5.65 GHz to 5.85 GHz bands. These radar stations can cause interference with and/or damage this device.

NOTE

The above caution applies to products that operate with an 802.11a radio device.

Wireless LAN and Your Health

Wireless LAN products, like other radio devices, emit radio frequency electromagnetic energy. The level of energy emitted by Wireless LAN devices however is far much less than the electromagnetic energy emitted by wireless devices like for example mobile phones.

Because Wireless LAN products operate within the guidelines found in radio frequency safety standards and recommendations, TOSHIBA believes Wireless LAN is safe for use by consumers. These standards and recommendations reflect the consensus of the scientific community and result from deliberations of panels and committees of scientists who continually review and interpret the extensive research literature.

In some situations or environments, the use of Wireless LAN may be restricted by the proprietor of the building or responsible representatives of the organization. These situations may for example include:

- ❖ Using the Wireless LAN equipment on board airplanes, or
- ❖ In any other environment where the risk of interference to other devices or services is perceived or identified as harmful.

If you are uncertain of the policy that applies on the use of wireless devices in a specific organization or environment (e.g. airports), you are encouraged to ask for authorization to use the Wireless LAN device prior to turning on the equipment.

CAUTION Exposure to Radio Frequency Radiation

The radiated output power of the TOSHIBA Wireless LAN Mini PCI Card is far below the FCC radio frequency exposure limits. Nevertheless, the TOSHIBA Wireless LAN Mini PCI Card shall be used in such a manner that the potential for human contact during normal operation is minimized. The antenna(s) used for this transmitter must not be co-located or operating in conjunction with any other antenna or transmitter.

Regulatory Information

The TOSHIBA Wireless LAN Mini PCI Card must be installed and used in strict accordance with the manufacturer's instructions as described in the user documentation that comes with the product. This device complies with the following radio frequency and safety standards.

Canada – Industry Canada (IC)

This device complies with RSS 210 of Industry Canada.

CAUTION The installer of this radio equipment must ensure that the antenna is located or pointed such that it does not emit RF field in excess of Health Canada limits for the general population; consult Safety Code 6, obtainable from Health Canada's Web site www.hc-sc.gc.ca/rpb. The RF device shall not be co-located with any other transmitter that has not been tested with this device.

Operation is subject to the following two conditions: (1) this device may not cause interference, and (2) this device must accept any interference, including interference that may cause undesired operation of this device.

L' utilisation de ce dispositif est soumise aux deux conditions suivantes: (1) il ne doit pas produire de brouillage et (2) l'utilisateur du dispositif doit être prêt à accepter tout brouillage radioélectrique reçu, même s'il est susceptible de compromettre son fonctionnement.

The term "IC" before the equipment certification number only signifies that the Industry Canada technical specifications were met.

To prevent radio interference to the licensed service, this device is intended to be operated indoors and away from windows to provide maximum shielding. Equipment (or its transmit antenna) that is installed outdoors is subject to licensing.

Pour empêcher que cet appareil cause du brouillage au service faisant l'objet d'une licence, il doit être utilisé à l'intérieur et devrait être placé loin des fenêtres afin de fournir un écran de blindage maximal. Si le matériel (ou son antenne d'émission) est installé à l'extérieur, il doit faire l'objet d'une licence.

CAUTION

This device is restricted to indoor use due to its operation in the 5.15 GHz to 5.25 GHz frequency range. Industry Canada requires this product to be used indoors for frequency range 5.15 GHz to 5.25 GHz to reduce the potential for harmful interference to co-channel Mobile Satellite systems.

High power radars are allocated as primary users of the 5.25 GHz to 5.35 GHz and 5.65 GHz to 5.85 GHz bands. These radar stations can cause interference with and/or damage this device.

NOTE

The above caution applies to products that operate with an 802.11a radio device.

EU Declaration of Conformity

TOSHIBA declares that this product conforms to the following Standards:



Supplementary
Information:

*The product complies with the requirements of the Low Voltage Directive 73/23/EEC, the EMC Directive 89/336/EEC and/or the R&TTE Directive 1999/5/EC.

This product is carrying the CE-Mark in accordance with the related European Directives. The party responsible for CE-Marking is TOSHIBA Europe GmbH, Hammfelddamm 8, 41460 Neuss, Germany.

The European Union WEEE (Waste from Electrical and Electronic Equipment) Directive Information

The European Union WEEE (Waste from Electrical and Electronic Equipment) Directive is intended to protect the quality of the environment and human health through the responsible use of natural resources and the adoption of waste management strategies that focus on recycling and reuse. This Directive requires producers of electrical and electronic products put on the market in European Union (EU) member countries after August 2005 to mark such products with a crossed-out wheeled bin with a black bar symbol. If the product's battery or accumulator contains more than the specified values of lead (Pb), mercury (Hg), and/or cadmium (Cd) defined in the Battery Directive (2006/66/EC), then the

chemical symbols for lead (Pb), mercury (Hg) and/or cadmium (Cd) will appear below the crossed out wheeled bin symbol on the battery.



Pb, Hg, Cd

In the European Union, these symbols indicate that when the last end user wishes to discard this product, it must be sent to appropriate facilities for recovery and recycling. This Directive applies to EU member countries only and does not apply to end users in other countries such as the United States.

Although the initial emphasis is in Europe, Toshiba is already working with design engineers, suppliers, and other partners to determine appropriate worldwide product life cycle planning and end-of-life strategies for our products. Please contact your local government for applicable laws and regulations governing the disposal of this product. For information on how to trade-in or recycle your product, visit www.reuse.toshiba.com.

VCCI Class B Information

この装置は、情報処理装置等電波障害自主規制協議会（VCCI）の基準に基づくクラスB情報技術装置です。この装置は、家庭環境で使用することを目的としていますが、この装置がラジオやテレビジョン受信機に近接して使用されると、受信障害を引き起こすことがあります。
取扱説明書に従って正しい取り扱いをして下さい。

Taiwan

Article 14	Unless approved, for any model accredited low power radio frequency electric machinery, any company, trader or user shall not change the frequency, increase the power or change the features and functions of the original design.
Article 17	Any use of low power radio frequency electric machinery shall not affect aviation safety and interfere with legal communications. In the event interference is caused, the use of such electric machinery shall be immediately discontinued. Operation of such products can be resumed only when they are modified and can no longer cause interference.

The legal communications mentioned in the above item refer to radio communications operated in accordance with telecommunication laws and regulations.

Low power radio frequency electric machinery shall resist against interference from legal communications or from industrial, scientific and medical radio emission electric machinery.

Using this Equipment in Japan

In Japan, the frequency bandwidth of 2,400 MHz to 2,483.5 MHz for second generation low-power data communication systems such as this equipment overlaps that of mobile object identification systems (premises radio station and specified low-power radio station).

1. Sticker

Please put the following sticker on devices incorporating this product.

The frequency bandwidth of this equipment may operate within the same range as industrial devices, scientific devices, medical devices, microwave ovens, licensed radio stations and non-licensed specified low-power radio stations for mobile object identification systems (RFID) used in factory product lines (Other Radio Stations).

1. Before using this equipment, ensure that it does not interfere with any of the equipment listed above.
2. If this equipment causes RF interference to other radio stations, promptly change the frequency being used, change the location of use, or turn off the source of emissions.
3. Contact TOSHIBA Direct PC if you have problems with interference caused by this product to Other Radio Stations.

2. Indication

The indication shown below appears on this equipment.

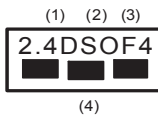

- 1** 2.4: This equipment uses a frequency of 2.4 GHz.
- 2** DS: This equipment uses DS-SS modulation.
OF: This equipment uses OFDM modulation.
- 3** The interference range of this equipment is less than 40m.
- 4** ■ ■ ■ This equipment uses a frequency bandwidth from 2,400 MHz to 2,483.5 MHz.

It is possible to avoid the band of mobile object identification systems.

The indication shown below appears on this equipment.

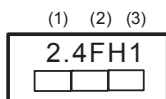

(4)

- 1 2.4: This equipment uses a frequency of 2.4 GHz.
- 2 FH: This equipment uses FH-SS modulation.
- 3 The interference range of this equipment is less than 10m.
- 4 This equipment uses a frequency bandwidth from 2,400 MHz to 2,483.5 MHz.

3. TOSHIBA Direct PC

Monday – Friday: 10:00 – 17:00

Toll Free Tel: 0120-15-1048

Direct Dial: 03-3457-4850

Fax: 03-3457-4868

Device Authorization

This device obtains the Technical Regulation Conformity Certification and the Technical Conditions Compliance Approval, and it belongs to the device class of radio equipment of low-power data communication system radio station stipulated in the Radio Law and the Telecommunications Business Law of Japan.

The name of the radio equipment: refer to the equipment label provided on the computer

Approved by both the JAPAN APPROVALS INSTITUTE FOR TELECOMMUNICATIONS EQUIPMENT and the TELECOM ENGINEERING CENTER

The following restrictions apply:

- ❖ Do not disassemble or modify the device.
- ❖ Do not install the embedded wireless module into other device.
- ❖ 5.17 GHz to 5.23 GHz for indoor use only.

Europe - Restrictions for use of 2.4 GHz Frequencies in European Community Countries

België/ Belgique:	For private usage outside buildings across public grounds over less than 300m no special registration with IBPT/BIPT is required. Registration to IBPT/BIPT is required for private usage outside buildings across public grounds over more than 300m. For registration and license please contact IBPT/BIPT.
----------------------	---

	Voor privé-gebruik buiten gebouw over publieke grond over afstand kleiner dan 300m geen registratie bij BIPT/IBPT nodig; voor gebruik over afstand groter dan 300m is wel registratie bij BIPT/IBPT nodig. Voor registratie of licentie kunt u contact opnemen met BIPT.
	Dans le cas d'une utilisation privée, à l'extérieur d'un bâtiment, au-dessus d'un espace public, aucun enregistrement n'est nécessaire pour une distance de moins de 300m. Pour une distance supérieure à 300m un enregistrement auprès de l'IBPT est requise. Pour les enregistrements et licences, veuillez contacter l'IBPT.
Deutschland:	License required for outdoor installations. Check with reseller for procedure to follow.
	Anmeldung im Outdoor-Bereich notwendig, aber nicht genehmigungspflichtig. Bitte mit Händler die Vorgehensweise abstimmen.
France:	Restricted frequency band: only channels 1 to 7 (2400 MHz and 2454 MHz respectively) may be used outdoors in France. Please contact A.R.T. (http://www.art-telecom.fr) for applicable procedures to follow.
	Bande de fréquence restreinte: seuls les canaux 1- 7 (2400 et 2454 MHz respectivement) doivent être utilisés endroits extérieur en France. Vous pouvez contacter l'Autorité de Régulation des Télécommunications (http://www.art-telecom.fr) pour la procédure à suivre.
Italia:	License required for indoor use. Use with outdoor installations not allowed.
	È necessaria la concessione ministeriale anche per l'uso interno. Verificare con i rivenditori la procedura da seguire.
Nederland:	License required for outdoor installations. Check with reseller for procedure to follow.
	Licentie verplicht voor gebruik met buitenantennes. Neem contact op met verkoper voor juiste procedure.

Europe - Restrictions for Use of 5 GHz Frequencies in European Community Countries

European Community Countries	5150-5250 MHz Channels: 36, 40, 44, 48 Indoor Only	5250-5350 MHz Channels: 52, 56, 60, 64 Indoor Only	5470-5725 MHz Channels: 100, 104, 108, 112, 116, 120, 124, 128, 132, 136, 140 Indoor/Outdoor
Austria	O	x	x
Belgium, France, Switzerland/Liechtenstein	O	O	x

European Community Countries	5150-5250 MHz Channels: 36, 40, 44, 48 Indoor Only	5250-5350 MHz Channels: 52, 56, 60, 64 Indoor Only	5470-5725 MHz Channels: 100, 104, 108, 112, 116, 120, 124, 128, 132, 136, 140 Indoor/Outdoor
Denmark, Finland, Germany, Greece, Ireland, Italy, Luxembourg, Netherlands, Norway, Portugal, Sweden, UK	O	O	O
Iceland, Spain	O	O	O

O: allowed x: forbidden

- ❖ To remain in conformance with European spectrum usage laws for Wireless LAN operation, the above 2.4 GHz and 5 GHz channel limitations apply. The user should use the wireless LAN utility to check the current channel of operation. If operation is occurring outside of the allowable frequencies as listed above, the user must cease operating the Wireless LAN at that location and consult the local technical support staff responsible for the wireless network.
- ❖ The 5 GHz Turbo mode feature is not allowed for operation in any European Community country.
- ❖ This device must not be operated in ad-hoc mode using channels in the 5 GHz bands in the European Community. Ad-hoc mode provides a direct communication between two client devices without a Wireless LAN Access Point.
- ❖ This device must be used with Access Points that have employed and activated a radar detection feature required for European Community operation in the 5 GHz bands. This device will operate under the control of the Access Point in order to avoid operating on a channel occupied by any radar system in the area. The presence of nearby radar operation may result in temporary interruption of operation of this device. The Access Point's radar detection feature will automatically restart operation on a channel free of radar. You may consult with the local technical support staff responsible for the wireless network to ensure the Access Point device(s) are properly configured for European Community operation.

Bluetooth® Wireless Technology Interoperability

Bluetooth® Cards from TOSHIBA are designed to be interoperable with any product with *Bluetooth* wireless technology that is based on Frequency Hopping Spread Spectrum (FHSS) radio technology, and is compliant to:

- ❖ *Bluetooth* Specification as defined and approved by The *Bluetooth* Special Interest Group.
- ❖ Logo certification with *Bluetooth* wireless technology as defined by The *Bluetooth* Special Interest Group.

CAUTION

Always use *Bluetooth* cards from TOSHIBA in order to enable wireless networks over two or more (up to a total of seven) TOSHIBA portable computers using these cards. Please contact TOSHIBA computer product support on Web site <http://www.toshiba-europe.com/computers/tnt/bluetooth.htm> in Europe or support.toshiba.com in the United States for more information.

When you use *Bluetooth* cards from TOSHIBA close to 2.4 GHz Wireless LAN devices, *Bluetooth* transmissions might slow down or cause errors. If you detect certain interference while you use *Bluetooth* cards from TOSHIBA, always change the frequency, move your computer to the area outside of the interference range of 2.4 GHz Wireless LAN devices (40 meters/43.74 yards or more) or stop transmitting from your computer. Please contact TOSHIBA computer product support on Web site <http://www.toshiba-europe.com/computers/tnt/bluetooth.htm> in Europe or support.toshiba.com in the United States for more information.

Bluetooth and Wireless LAN devices operate within the same radio frequency range and may interfere with one another. If you use *Bluetooth* and Wireless LAN devices simultaneously, you may occasionally experience a less than optimal network performance or even lose your network connection. If you should experience any such problem, immediately turn off either one of your *Bluetooth* or Wireless LAN. Please contact Toshiba computer product support on Web site <http://www.toshiba-europe.com/computers/tnt/bluetooth.htm> in Europe or support.toshiba.com in the United States for more information.

Bluetooth® Wireless Technology and Your Health

The products with *Bluetooth*® wireless technology, like other radio devices, emit radio frequency electromagnetic energy. The level of energy emitted by devices with *Bluetooth* wireless technology however is much less than the electromagnetic energy emitted by wireless devices such as mobile phones.

Because products with *Bluetooth* wireless technology operate within the guidelines found in radio frequency safety standards and recommendations, TOSHIBA believes *Bluetooth* wireless technology is safe for use by consumers. These standards and recommendations reflect the consensus of the scientific community and result from deliberations of panels and committees of scientists who continually review and interpret the extensive research literature.

In some situations or environments, the use of *Bluetooth* wireless technology may be restricted by the proprietor of the building or responsible representatives of the organization. These situations may for example include:

- ❖ Using the equipment with *Bluetooth* wireless technology on board airplanes, or
- ❖ In any other environment where the risk of interference to other devices or services is perceived or identified as harmful.

If you are uncertain of the policy that applies on the use of wireless devices in a specific organization or environment (e.g. airports), you are encouraged to ask for authorization to use the device with *Bluetooth* wireless technology prior to turning on the equipment.

CAUTION Exposure to Radio Frequency Radiation

The radiated output power of the *Bluetooth* Card from TOSHIBA is far below the FCC radio frequency exposure limits. Nevertheless, the *Bluetooth* Card from TOSHIBA shall be used in such a manner that the potential for human contact during normal operation is minimized.

Regulatory statements

This product complies with any mandatory product specification in any country/region where the product is sold. In addition, the product complies with the following:

Taiwan

Article 14	Unless approved, for any model accredited low power radio frequency electric machinery, any company, trader or user shall not change the frequency, increase the power or change the features and functions of the original design.
Article 17	Any use of low power radio frequency electric machinery shall not affect aviation safety and interfere with legal communications. In the event interference is caused, the use of such electric machinery shall be immediately discontinued. Operation of such products can be resumed only when they are modified and can no longer cause interference.

The legal communications mentioned in the above item refer to radio communications operated in accordance with telecommunication laws and regulations.

Low power radio frequency electric machinery shall resist against interference from legal communications or from industrial, scientific and medical radio emission electric machinery.

Optical Disc Drive Safety Instructions

⚠ DANGER

This appliance contains a laser system and is classified as a CLASS 1 LASER PRODUCT. To use this model properly, read the User's Guide carefully and keep it for your future reference.

Never attempt to disassemble, adjust or repair an optical disc drive. You could damage the drive. You would also be exposed to laser light or other safety hazards, resulting in serious injury. Always contact an authorized Toshiba service provider, if any repair or adjustment is required.

CLASS 1 LASER PRODUCT
LASERKLASSE 1

Location of the Required Label

(Sample shown below. Location of the label and manufacturing information may vary.)

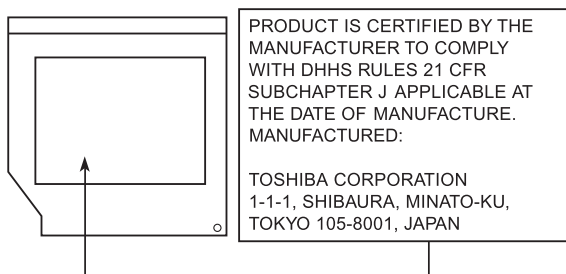

Copyright

This guide is copyrighted by Toshiba America Information Systems, Inc. with all rights reserved. Under the copyright laws, this guide cannot be reproduced in any form without the prior written permission of Toshiba. No patent liability is assumed, however, with respect to the use of the information contained herein.

©2012 by Toshiba America Information Systems, Inc. All rights reserved.

Export Administration Regulation

This document contains technical data that may be controlled under the U.S. Export Administration Regulations, and may be subject to the approval of the U.S. Department of Commerce prior to export. Any export, directly or indirectly, in contravention of the U.S. Export Administration Regulations is prohibited.

Notice

The information contained in this manual, including but not limited to any product specifications, is subject to change without notice.

TOSHIBA CORPORATION AND TOSHIBA AMERICA INFORMATION SYSTEMS, INC. (TOSHIBA) PROVIDES NO WARRANTY WITH REGARD TO THIS MANUAL OR ANY OTHER INFORMATION CONTAINED HEREIN AND HEREBY EXPRESSLY DISCLAIMS ANY IMPLIED WARRANTIES OF MERCHANTABILITY OR FITNESS FOR ANY PARTICULAR PURPOSE WITH REGARD TO ANY OF THE FOREGOING. TOSHIBA ASSUMES NO LIABILITY FOR ANY DAMAGES INCURRED DIRECTLY OR INDIRECTLY FROM ANY TECHNICAL OR TYPOGRAPHICAL ERRORS OR OMISSIONS CONTAINED HEREIN OR FOR DISCREPANCIES BETWEEN THE PRODUCT AND THE MANUAL. IN NO EVENT SHALL TOSHIBA BE LIABLE FOR ANY INCIDENTAL, CONSEQUENTIAL, SPECIAL, OR EXEMPLARY DAMAGES, WHETHER BASED ON TORT, CONTRACT OR OTHERWISE, ARISING OUT OF OR IN CONNECTION WITH THIS MANUAL OR ANY OTHER INFORMATION CONTAINED HEREIN OR THE USE THEREOF.

Trademarks

Satellite, Satellite Pro, and eco Utility are either registered trademarks or trademarks of Toshiba America Information Systems, Inc. and/or Toshiba Corporation.

Adobe and Photoshop are either registered trademarks or trademarks of Adobe Systems Incorporated in the United States and/or other countries.

Bluetooth word mark and logos are owned by the Bluetooth SIG, Inc. and any use of such marks by Toshiba is under license. Other trademarks and trade names are those of their respective owners.

HDMI, the HDMI Logo and High-Definition Multimedia Interface are trademarks or registered trademarks of HDMI Licensing, LLC.

Intel, Intel Core, Celeron, Centrino and Pentium are trademarks or registered trademarks of Intel Corporation or its subsidiaries in the United States and other countries.

Microsoft, Outlook, Windows, and Windows Media are either registered trademarks or trademarks of Microsoft Corporation in the United States and/or other countries.

MultiMediaCard and MMC are registered trademarks of MultiMediaCard Association.

Secure Digital and SD are trademarks of SD Card Association.

All other brand and product names are trademarks or registered trademarks of their respective companies.

Licenses

This Product is licensed under the AVC, the VC-1 and the MPEG-4 Part 2 Visual patent portfolio licenses for the personal and non-commercial use of a consumer to (i) encode video in compliance with the above standards (“Video Standards”) and/or (ii) decode AVC, VC-1 and MPEG-4 Part 2 Visual that was encoded by a consumer engaged in personal and non-commercial activity or was obtained from a video provider licensed to provide such video. None of the licenses extend to any other product regardless of whether such product is included with this product in a single article. No license is granted or shall be implied for any other use. Additional information may be obtained from MPEG LA, LLC. See www.mpegla.com.

Computer Recycling Information

As part of a commitment to people and the future, Toshiba promotes the efficient use of resources by working to achieve our zero-waste-to-landfill goal at all our production sites. In addition to our existing waste reduction and recycling policies, Toshiba is strongly committed to reducing electronic waste. In order to ensure efficient use of resources and appropriate treatment of hazardous substances, in accordance with recycling regulations in each state, country, and territory, Toshiba wants to make it easy for customers to recycle products at the end of the life cycle. To learn more about Toshiba's sustainability commitment, visit us.toshiba.com/green.

Reuse, Donation, Recycling

Functional computers can be donated to a local charity or resold easily through a Toshiba-branded program.

Non working Toshiba computers can be mailed-back for free recycling.

For additional details, please visit us.toshiba.com/recycle.

Contents

Introduction.....	25
This guide	27
Safety icons	28
Other icons used	28
Your computer's features and specifications	29
Other documentation	29
Service options	29
Chapter 1: Getting Started.....	30
Selecting a place to work	30
Setting up a work environment	30
Keeping yourself comfortable	31
Computer user comfort recommendations	31
Good Working Posture	31
Using the notebook with an external keyboard, mouse or monitor.....	32
Typing style	33
Taking breaks and varying tasks	33
Mobile computing tips	34
Transporting the notebook.....	34
Seeking additional help	34

Check list	35
Precautions	35
Important information on your computer's cooling fan	37
Setting up your computer	38
Connecting to a power source	38
Charging the main battery	41
Using the computer for the first time	41
Initial setup	42
Setting up your software	42
Registering your computer with Toshiba	42
To Shut down your computer	43
To Restart your computer	43
To place your computer in Sleep mode	44
Adding optional external devices	45
Adding memory (optional)	45
Installing a memory module	45
Removing a memory module	51
Checking total memory	53
Recovering the Internal Storage Drive	54
Creating recovery media	55
Restoring from recovery media	57
Refresh your PC (with user's data)	58
Reset your PC	60
Installing drivers and applications	63
Using the touch pad	64
Adjusting touch pad settings	66
Disabling or enabling the touch pad	67
Connecting an external device	67
Using external display devices	67
Selecting video cables	68
Connecting an HDMI™-compatible television or display device	68
Connecting an external monitor or projector	68
Directing the display output when you turn on the computer	69
Adjusting the quality of the external display	70
Customizing your computer's settings	70

Caring for your computer.....	70
Cleaning the computer.....	71
Moving the computer.....	71
Using a computer lock.....	71
Chapter 2: Learning the Basics.....	73
Computing tips.....	73
Using the keyboard.....	74
Function keys.....	75
Special Windows® keys.....	76
Mouse properties.....	76
Starting an app.....	77
Starting an app from the Start screen.....	77
Saving your work.....	78
Backing up your work.....	78
Using the optical disc drive.....	78
Optical disc drive components.....	79
Media control buttons.....	80
Inserting an optical disc.....	80
Removing a disc with the computer on.....	81
Playing optical media.....	81
Recording optical media.....	82
Removing a disc with the computer off.....	82
Toshiba's online resources.....	83
Chapter 3: Mobile Computing.....	84
Toshiba's energy-saver design.....	84
Running the computer on battery power.....	84
Battery Notice.....	85
Power management.....	86
Charging the main battery.....	86
Charging the RTC battery.....	87
Monitoring main battery power.....	88
Determining remaining battery power.....	89
What to do when the main battery runs low.....	90
Setting battery notifications.....	90
Conserving battery power.....	91

Power Plans	92
Using the eco power plan	93
Changing the main battery	94
Removing the battery from the computer	94
Inserting a charged battery	95
Taking care of your battery	97
Safety precautions	97
Maintaining your battery	98
Disposing of used batteries	98
Traveling tips	99
Chapter 4: Exploring Your Computer's Features	100
Exploring the Start screen	100
Charms	101
Tiles	102
Exploring the desktop	102
Finding your way around the desktop	102
Windows® Store	104
Setting up for communications	104
Connecting your computer to a network	105
Exploring audio features	106
Recording sounds	106
Using external speakers or headphones	107
Using the Web Camera	107
Using the Memory card reader	108
Inserting memory media	108
Removing memory media	109
Chapter 5: Utilities	110
Desktop Assist	111
Media & Entertainment	112
Tools & Utilities	113
Support & Recovery	114
eco Utility®	115
Setting passwords	116
Using a supervisor password	116

Using a user password	118
Deleting a user password.....	118
System Settings.....	119
Sleep and Charge	120
USB Sleep and Charge	120
Enabling/Disabling USB Sleep and Charge.....	122
Power supply mode settings.....	122
Function Key	123
PC Diagnostic Tool Utility	124
PC Health Monitor.....	125
Recovery Media Creator.....	126
Service Station.....	126
TOSHIBA Application Installer.....	127
Chapter 6: If Something Goes Wrong	128
Problems that are easy to fix	128
Problems when you turn on the computer.....	129
The Windows® operating system is not working.....	131
Using Startup options to fix problems	132
Internet problems	134
The Windows® operating system can help you	135
Fixing a problem with Device Manager	135
Checking device properties	135
Memory problems	136
Power and the batteries	137
Keyboard problems.....	138
Display problems	139
Disk or storage drive problems.....	141
Error-checking	141
Optical disc drive problems.....	143
Sound system problems	144
Printer problems.....	144
Wireless networking problems.....	145
DVD operating problems.....	147

Develop good computing habits	148
Data and system configuration backup in the Windows® operating system.....	149
If you need further assistance.....	154
Contacting Toshiba	154
Other Toshiba Internet Web sites.....	154
Toshiba's worldwide offices.....	155
Appendix A: TOSHIBA Function Keys.....	156
Functions	156
Help file.....	157
Display brightness	157
Output (Display switch)	158
Disabling or enabling the touch pad.....	159
Media buttons	159
Volume Mute	160
Disabling or enabling wireless devices.....	160
Keyboard Function keys	161
Zoom (Display resolution)	161
Appendix B: Power Cord/Cable Connectors.....	162
Glossary.....	163
Index.....	177

Introduction

Welcome to the world of powerful, portable, multimedia computing. With your Toshiba computer, your work and entertainment can accompany you wherever you go.



Your computer is ENERGY STAR® qualified.

Toshiba is a partner in the Environmental Protection Agency's (EPA) ENERGY STAR® Program and has designed this computer to meet the latest ENERGY STAR® guidelines for energy efficiency. Your computer ships with the power management options preset to a configuration that will provide the most stable operating environment and optimum system performance for both AC power and battery modes.

To conserve energy, your computer is set to dim the display after 10 minutes of inactivity, and enter the low-power Sleep mode which shuts down the system after 15 minutes of inactivity in AC power mode. We recommend that you leave this and other energy saving features active, so that your computer will operate at its maximum energy efficiency. You can wake the computer from Sleep mode by pressing the power button. See the "Mobile Computing" section of the Toshiba User's Guide for more information on using power management settings to conserve computer energy.

When considering additions to your home office, purchase products that have earned the ENERGY STAR® for all your equipment needs, which can save you money, save energy, and help protect the climate.

Visit <http://www.energystar.gov> or <http://www.energystar.gov/powermanagement> for more information regarding the ENERGY STAR® Program.

NOTE

This computer is compatible with European Union Directive 2002/95/EC, Restriction of the use of certain Hazardous Substances in electrical and electronic equipment (RoHS), which restricts use of lead, cadmium, mercury, hexavalent chromium, PBB, and PBDE. Toshiba requires its computer component suppliers to meet RoHS requirements and verifies its suppliers' commitment to meeting RoHS requirements by conducting component sampling inspections during the product design approval process.

NOTE

Certain Microsoft® software product(s) included with this computer may use technological measures for copy protection. IN SUCH EVENT, YOU WILL NOT BE ABLE TO USE THE PRODUCT IF YOU DO NOT FULLY COMPLY WITH THE PRODUCT ACTIVATION PROCEDURES. Product activation procedures and Microsoft's privacy policy will be detailed during initial launch of the product, or upon certain reinstallations of the software product(s) or reconfigurations of the computer, and may be completed by Internet or telephone (toll charges may apply).

Some software may differ from its retail version (if available), and may not include user manuals or all program functionality.

NOTE

The product specifications and configuration information are designed for a product Series. Your particular model may not have all the features and specifications listed or illustrated. For more detailed information about the features and specifications on your particular model, please visit Toshiba's Web site at support.toshiba.com.

While Toshiba has made every effort at the time of publication to ensure the accuracy of the information provided herein, product specifications, configurations, prices, system/component/options availability are all subject to change without notice. For the most up-to-date product information about your computer, or to stay current with the various computer software or hardware options, visit Toshiba's Web site at support.toshiba.com.

This guide

This guide introduces the computer's features as well as some basic procedures needed to perform tasks in Windows 8. You can:

- ❖ Read the entire guide from beginning to end.
- ❖ Skim through and stop when a topic interests you.
- ❖ Use the table of contents and the index to find specific information.

Safety icons

This manual contains safety instructions that must be observed to avoid potential hazards that could result in personal injuries, damage to your equipment, or loss of data. These safety cautions have been classified according to the seriousness of the risk, and icons highlight these instructions as follows:



Indicates an imminently hazardous situation which, if not avoided, will result in death or serious injury.



Indicates a potentially hazardous situation which, if not avoided, could result in death or serious injury.



Indicates a potentially hazardous situation which, if not avoided, may result in minor or moderate injury.



Indicates a potentially hazardous situation which, if not avoided, may result in property damage.

NOTE

Provides important information.

Other icons used

Additional icons highlight other helpful or educational information:



TECHNICAL NOTE: This icon indicates technical information about the computer.



HINT: This icon indicates helpful hints and tips.



DEFINITION: This icon indicates the definition of a term used in the text.

Your computer's features and specifications

Certain computer chassis are designed to accommodate all possible configurations for an entire product Series. Your select model may not have all the features and specifications corresponding to all of the icons or switches shown on the computer chassis, unless you have selected all those features.

This information applies to all the features and icons described in this guide.

Below are examples of some of the many possible icons used on your computer:



(Sample Illustration) System icons

Other documentation

Your computer comes with the following documentation:

- ❖ An electronic version of the User's Guide (this document)
- ❖ A Quick Start document
- ❖ It may also contain guides for other applications that may come with your system.

For accessory information, visit Toshiba's Web site at accessories.toshiba.com.

Service options

Toshiba offers a full line of optional service programs to complement its standard limited warranty. Toshiba's standard limited warranty, extended warranty, and service upgrade terms and conditions are available at warranty.toshiba.com.

To stay current on the most recent software and hardware options for your computer, and for other product information, be sure to regularly check the Toshiba Web site at support.toshiba.com.

If you have a problem or need to contact Toshiba, see "If Something Goes Wrong" on page 128.

Chapter 1

Getting Started

This chapter provides tips for using your computer effectively, summarizes how to connect components, and explains what to do the first time you use your computer.

Please read the safety instruction information on the Quick Start document (that shipped with your computer) carefully and make sure you fully understand the instructions before you attempt to use your computer in order to avoid potential hazards that could cause bodily injury, property damage, or damage the computer.

Selecting a place to work

Your computer is portable and designed to be used in a variety of circumstances and locations.

Setting up a work environment

Place the computer on a hard flat surface that is large enough for the computer and any other items you are using, such as a printer. Leave enough space around the computer and other equipment to provide adequate ventilation. Otherwise, they may overheat.

To keep your computer in prime operating condition, protect your work area from:

- ❖ Dust, moisture, and direct sunlight.

- ❖ Equipment that generates a strong electromagnetic field, such as stereo speakers (other than speakers that are connected to the computer) or speakerphones.
- ❖ Rapid changes in temperature or humidity and sources of temperature change such as air conditioner vents or heaters.
- ❖ Extreme heat, cold, or humidity.
- ❖ Liquids and corrosive chemicals.

Keeping yourself comfortable

This section provides information for setting up your work environment and tips for working comfortably throughout the day.

Computer user comfort recommendations

Good Working Posture

- ❖ Adjust your chair height: your feet should be flat on the floor and the bottom of your thighs should be evenly supported by the seat. If your feet cannot reach the floor, use a foot rest. Avoid pressure points behind the knee or under the thigh.
- ❖ The space under your desk should be free of clutter so that your legs and feet are not restricted, and you can get close enough to your notebook and other items that you use frequently.
- ❖ Adjust the chair back rest: it should match the curve of your back and provide comfortable back support.
- ❖ Adjust the chair arm rests: they should be about the same height as the keyboard and comfortably support your arms, allowing your shoulders to relax.
- ❖ When using the keyboard, it should be centered in front of you.
- ❖ The keyboard and pointing device should be close to your elbow level. The keyboard should be flat so that your wrists are straight when typing. However, if the notebook is on a work surface that is above your elbow height you may need to slope the notebook to keep your wrists straight.
- ❖ Work with relaxed shoulders.
- ❖ When typing, keep your wrists straight and try not to rest your wrists on the notebook. Support your arms on your forearm area. The forearms can be supported by the chair arm supports or the desk surface.
- ❖ The notebook display should be tilted so that the image on the screen is clear.

- ❖ Avoid glare: position the notebook so that light sources (lamps or windows) do not shine or reflect directly into your eyes. Place the notebook display away from bright light sources or reduce the light intensity from windows by using blinds. Glare on the notebook display may cause eye strain, eye fatigue or headaches.
- ❖ Certain notebook displays have a brightness approaching that of a TV device. We recommend that you adjust the brightness of your notebook display to a comfortable level to prevent possible eye strain.
- ❖ Keep your head level, facing forward and balanced over your torso.
- ❖ Adjust the font size of text on your screen to make viewing comfortable.
- ❖ Rest your eyes periodically by focusing on objects that are farther away.

Using the notebook with an external keyboard, mouse or monitor

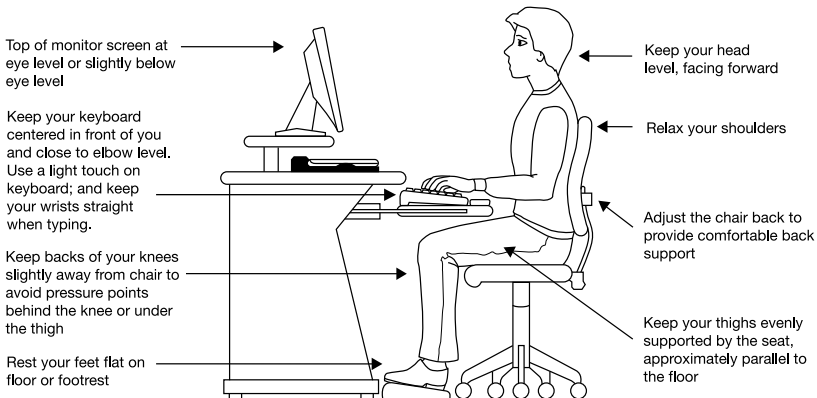

(Sample Illustration) Correct posture

- ❖ When using a notebook for long hours, it may be more comfortable to dock the notebook and use an external keyboard, mouse and monitor.
- ❖ The keyboard and mouse (or trackball) should be close to your elbow level.
- ❖ The mouse should be next to the keyboard to avoid a reach. If you have to reach, the arm should be supported in the forearm area by the desk surface or the chair arm supports.

- ❖ Alternative keyboards, such as the split curved keyboard, may improve shoulder and arm comfort.
- ❖ Select a mouse that is comfortable for you to use.
- ❖ Don't rest your wrists on the edge of the keyboard or on the work surface when typing.
- ❖ The monitor should be about an arm length away while sitting back in the chair.
- ❖ The monitor should be centered in front of your body.
- ❖ The top of the monitor should be at or slightly below eye level. A monitor that is too high or too low can cause awkward head and neck postures and may lead to discomfort in the neck muscles.
- ❖ If you use bifocals you may need to lower the monitor. Alternatively, you might consider customized prescription computer glasses.

Typing style

- ❖ Learn to touch type so that you don't have to look down at the keyboard.
- ❖ Type with straight wrists.
- ❖ Type lightly.
- ❖ Learn the keyboard shortcuts for your applications. You will be more productive.
- ❖ Use the pointing device (e.g., touch pad, Accupoint®, or tablet pen whichever is available with your notebook computer, or other optional pointing devices like mouse or trackball) with a comfortable hand posture. Avoid awkward hand postures or high gripping force.
- ❖ It is helpful to change the type of pointing device that you use on a regular basis to avoid working in just one hand posture.

Taking breaks and varying tasks

- ❖ Change the way you work so that you are not stuck in the same posture for long periods of time. Some people find it comfortable to occasionally stand while using the notebook. To do this properly, the notebook needs to be on an elevated surface. Make sure you follow the Good Working Posture points mentioned above while working.

- ❖ Take short, strategically spaced rest breaks to avoid eye strain and body fatigue. For example, stand up and walk around or stretch for a few minutes every hour.
- ❖ Taking regular breaks is especially important if you are working long hours on your computer or working on a deadline.
- ❖ If stress at work is affecting your health, try to identify the sources of the stress and evaluate ways to reduce the stress.

Mobile computing tips

- ❖ When using the notebook at airports, on airplanes or trains, or at meetings, make sure that you take the time to consider the points just mentioned.
- ❖ When working on the road it may be difficult to set up the notebook in an optimal position. In these situations it is important that you take frequent breaks and change your posture frequently to relieve the excess loads on your body.
- ❖ Be creative, when in a hotel room, use a rolled up blanket or pillows to provide back support, or to provide arm support. To position the computer at a good height, remember to operate the computer on a hard flat stable surface. Using your computer on a carpet, blanket or other soft materials can block the air vents including those located at the base of the computer and possibly cause overheating of your computer.

Transporting the notebook

Although your notebook is light, carrying it for a long time may lead to shoulder and arm fatigue. If you carry your notebook with other items, consider using an ergonomically-designed computer case.

Seeking additional help

Follow the advice from your employer's company health and safety staff. Contact them if you need assistance making adjustment to your workstation or adjusting the lighting.

Again, if you experience persistent or recurrent pain, ache, numbness, burning, or stiffness you should promptly see a qualified health care provider. These sensations may be caused by serious medical conditions that can be treated.

For more specific recommendations on the safety and comfort of your computer environment, customers in the United States may visit the United States Department of Labor, Occupational Safety & Health Administration Web site at:

<http://www.osha.gov/SLTC/etools/computerworkstations/>

Check list

- Is your chair comfortable - does it support your back and arms well?
- Are your feet flat on the ground?
- Is there adequate space under your desk for your legs?
- Are the keyboard and mouse at elbow level?
- Are your shoulders relaxed when using the keyboard?
- Are your shoulders relaxed when using a mouse or other optional pointing device?
- Are your hands and wrists aligned in a comfortable, straight posture?
- Are your arms supported in the forearm area (not at the wrist)?
- Do you hold the mouse or trackball with a loose, relaxed hand?
- Do you use a light touch when typing or using the mouse?
- Do you clean your mouse or trackball regularly?
- Is the top of your monitor close to eye level?
- Is the monitor about an arm length away?
- Have you eliminated the glare on the monitor?
- Is the monitor tilted so that it is easy to read?
- Do you change postures regularly?
- Do you take breaks, at least once an hour?

Precautions

Your computer is designed to provide optimum safety and ease of use, and to withstand the rigors of travel. You should observe certain precautions to further reduce the risk of personal injury or damage to the computer.

- ❖ Avoid prolonged physical contact with the underside or surface of the computer.

⚠ WARNING

Never allow any liquids to spill into any part of your computer, and never expose the computer to rain, water, seawater or moisture. Exposure to liquid or moisture can cause electric shock or fire, resulting in damage or serious injury. If any of these eventualities should accidentally occur, immediately:

1. Turn off the computer.
2. Disconnect the AC adaptor from the power plug socket and computer.
3. Remove the battery pack.

Failure to follow these instructions could result in serious injury or permanent damage to the computer.

Do not turn on the power again until you have taken the computer to an authorized service center.

⚠ CAUTION

- ❖ Avoid prolonged physical contact with the underside or surface of the computer.
 - ❖ Computer base and palm rest can become hot! Avoid prolonged contact to prevent heat injury to skin.
-
-

Today's performance computers generate heat under normal operating conditions, as a function of system activity. Avoid extended contact between the computer base or palm rest and your skin. Under certain operating conditions such prolonged contact between the computer base or palm rest and your skin may result in skin irritation and/or heat injury.

Consider using a hard computer insulating pad or similarly suitable hard insulating material when using a computer on your lap.

⚠ CAUTION

Never place a heavy object on the computer and be careful not to drop a heavy object onto the computer. It could damage the computer or cause system failure.

- ❖ Never turn off the computer if a drive light indicates a drive is active. Turning off the computer while it is reading from or writing to a disk/disc or flash media may damage the disk/disc or flash media, the drive, or both.

- ❖ Keep the computer and disks away from objects that generate strong magnetic fields, such as large stereo speakers.

Information on some disks is stored magnetically. Placing a magnet too close to a disk can erase important files.

CAUTION

Handle discs carefully. Avoid touching the surface of the disc. Grasp it by its center hole and edge. If you handle the disc incorrectly, you could damage the disc and possibly lose data.

- ❖ Scan all new files for viruses.

This precaution is especially important for files you receive via email or download from the Internet. Occasionally, even new applications you buy from a supplier may contain a computer virus. You need a special application to check for viruses.

Important information on your computer's cooling fan

Your computer may have a CPU cooling fan that cools the CPU by drawing outside air into the computer.

WARNING

Always make sure your computer and AC adaptor have adequate ventilation and are protected from overheating when the power is turned on or when an AC adaptor is connected to a power outlet (even if your computer is in Sleep mode). In this condition, observe the following:

- ❖ Never cover your computer or AC adaptor with any object.
- ❖ Never place your computer or AC adaptor near a heat source, such as an electric blanket or heater.
- ❖ Never cover or block the air vents including those located at the underside of the computer.
- ❖ Always operate your computer on a hard flat surface. Using your computer on a carpet or other soft material can block the vents located at the underside of the computer.

Overheating your computer or AC adaptor could cause system failure, computer or AC adaptor damage or a fire, possibly resulting in serious injury.

NOTE

The cooling fan location will vary depending on the computer.

Setting up your computer



TECHNICAL NOTE: You must complete all setup steps up to and including “[Setting up your software](#)” on page 42 before adding external or internal components to your computer. These components include, but are not limited to, a mouse, keyboard, printer, and memory.

Your computer contains a rechargeable main battery that needs to be charged before you can use it.

To use external power or to charge the battery you must attach the AC adaptor. See “[Connecting to a power source](#)” on page 38.

NOTE

Please handle your computer carefully to avoid scratching or damaging the surface.

Connecting to a power source

Your computer requires power to operate. Use the power cord/cable and AC adaptor to connect the computer to a live electrical outlet, or to charge the computer’s battery.

▲ WARNING

Never pull on a power cord/cable to remove a plug from a socket. Always grasp the plug directly. Failure to follow this instruction may damage the cord/cable, and/or result in a fire or electric shock, possibly resulting in serious injury.

▲ WARNING

Always confirm that the power plug (and extension cable plug if used) has been fully inserted into the socket, to ensure a secure electrical connection. Failure to do so may result in a fire or electric shock, possibly resulting in serious injury.

Be careful if you use a multiple connector. An overload on one socket could cause a fire or electric shock, possibly resulting in serious injury.

⚠ WARNING

Always use the TOSHIBA AC adaptor that was provided with your computer, or use AC adaptors specified by TOSHIBA to avoid any risk of fire or other damage to the computer. Use of an incompatible AC adaptor could cause fire or damage to the computer possibly resulting in serious injury. TOSHIBA assumes no liability for any damage caused by use of an incompatible adaptor.

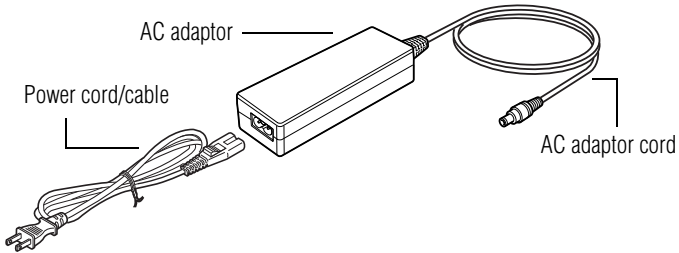

(Sample Illustration) Power cord/cable and AC adaptor

To connect AC power to the computer:

- 1 Connect the power cord/cable to the AC adaptor.

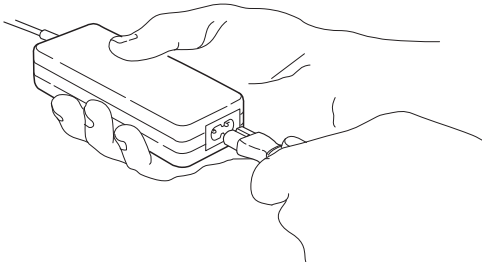

(Sample Illustration) Connecting the power cord/cable to the AC adaptor

⚠ WARNING

Handling the cord on this product will expose you to lead, a chemical known to the State of California to cause birth defects or other reproductive harm. **Wash hands after handling.**



- 2 Plug the AC adaptor cord into the DC-IN on the side of the computer.

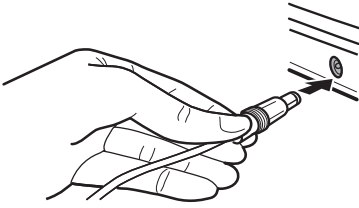

(Sample Illustration) Connecting the AC adaptor cord to the computer

- 3 Connect the power cord/cable to a live electrical outlet.



The AC power light on the indicator panel glows white.

WARNING

Never attempt to connect or disconnect a power plug with wet hands. Failure to follow this instruction could result in an electric shock, possibly resulting in serious injury.

The computer's main battery light gives you an indication of the main battery's current charge:

- ❖ Glows amber while the main battery is being charged (AC adaptor connected)
- ❖ Glows white when the main battery is fully charged
- ❖ Flashes amber when the main battery charge is low and it is time to recharge the main battery or plug in the AC adaptor

NOTE

If the AC power light flashes amber during charging, either the main battery is malfunctioning, or it is not receiving correct input from the AC power supply.

Disconnect the AC power cord/cable and remove the main battery pack. See ["Changing the main battery" on page 94](#) for information on replacing the main battery.

Charging the main battery

Before using the battery to power the computer, you must charge the battery.

To charge the battery, leave the computer plugged into an AC power source with the computer turned off until the battery light glows white. After that, the battery will be completely charged and ready to power the computer.

CAUTION

Once the battery is charged for the first time, avoid leaving the computer plugged in and turned off for more than a few hours at a time. Continuing to charge a fully charged battery can damage the battery.

Using the computer for the first time

The computer is now ready for you to turn it on and begin using it, see “Exploring Your Computer’s Features” on page 100.

NOTE

When opening or closing the display panel, place one hand on the palm rest to hold the computer in place and use the other hand to slowly open or close the display panel.

CAUTION

To avoid damaging the display panel, do not force it beyond the point where it moves easily and never lift the computer by the display panel.

Do not press or push on the display panel and be careful to remove any pens or other objects from the keyboard area before closing the display panel.

Small bright dots may appear on your screen display when you turn on your computer. Your display contains an extremely large number of thin-film transistors (TFT) and is manufactured using high-precision technology. Any small bright dots that may appear on your display are an intrinsic characteristic of the TFT manufacturing technology. Over a period of time, and depending on the usage of the computer, the brightness of the screen will deteriorate. This is also an intrinsic characteristic of the screen technology. When the computer is operated on battery power, the screen will dim and you may not be able to increase the brightness of the screen while on battery power.

Initial setup

The Windows 8 Startup screen is the first screen displayed when you turn on your computer for the first time. Follow the on-screen instructions on each screen in order to properly install the operating system and begin using your computer.

Setting up your software

CAUTION

When you turn on the computer for the first time, do not turn off the power again until the operating system has loaded completely.

NOTE

The names of windows displayed, and the order in which windows appear, may vary according to your software setup choices.

The first time you turn on your computer, the setup guides you through steps to set up your software. Follow the on-screen instructions.

Registering your computer with Toshiba

Product registration is strongly recommended, and allows Toshiba to send you periodic updates, announcements, and special offers applicable to your Product. Product registration can be completed by one of three methods:

- 1 From the Toshiba Web site at register.toshiba.com: Type in the requested information and complete the registration process.
- 2 From the Start screen: Type **Registration** while in the Start screen, locate and complete the registration process.
- 3 From the Desktop: On the Desktop, move the pointer over the upper or lower right corner of the screen. When the Windows® Charms appear, click the Search (🔍) Charm and, in the Search field, type **Registration**. In the list that appears, click **Registration** and complete the registration process.

Failure to complete Product Registration will not diminish your rights under the Toshiba Standard Limited Warranty.

NOTE

To register online, an Internet connection is required.

To Shut down your computer

- 1 From the Start or Desktop screen, move your pointer over the upper or lower right corner of the screen.
- 2 When the Windows® Charms appear, click the **Settings** (⚙️) Charm.

CAUTION

Pressing the power button before shutting down the Windows® operating system could cause you to lose your work. Make sure the system indicator panel's storage drive light and the drive in-use light are off. If you turn off the power while a disk/disc is being accessed, you may lose data or damage the disk/disc and/or drive.

- 3 In the lower right of the screen click the **Power** (⏻) icon.

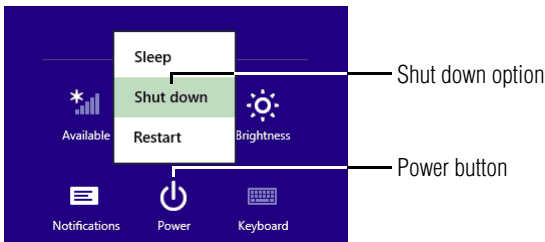

(Sample Image) Shut down

- 4 Highlight **Shut down** while holding the Shift key, and then click the **Shut down** option.

The computer closes all open applications, shuts down the operating system, and then turns off.

To Restart your computer

- 1 From the Start or Desktop screen, move your pointer over the upper or lower right corner of the screen.
- 2 When the Windows® Charms appear, click the **Settings** (⚙️) Charm.

- 3 In the lower right of the screen click the **Power** (⏻) icon.

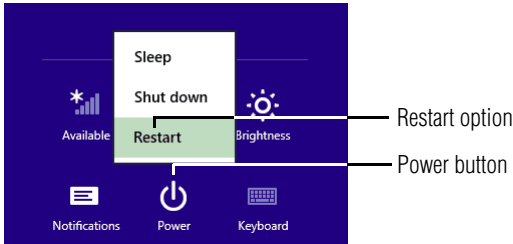

(Sample Image) Restart

- 4 Highlight **Restart**, and then click the **Restart** option.
The computer closes all open applications, and restarts the operating system.

To place your computer in Sleep mode

- 1 From the Start or Desktop screen, move your pointer over the upper or lower right corner of the screen.
- 2 When the Windows® Charms appear, click the **Settings** (⚙️) Charm.

CAUTION

If you power down using the Sleep command and the battery discharges fully, your unsaved information will be lost. Be sure to save your work first.

- 3 In the lower right of the screen click the **Power** (⏻) icon.

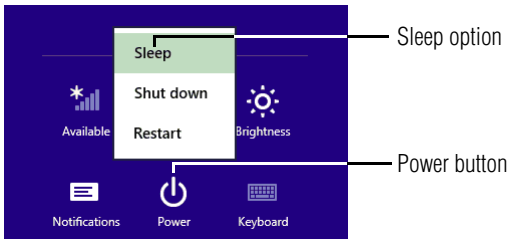

(Sample Image) Sleep

- 4 Highlight **Sleep**, and then click the **Sleep** option.
Sleep mode saves the current state of the computer to memory so that, when you restart the computer, you can continue working from where you left off.

Adding optional external devices

NOTE Before adding external devices or memory, Toshiba recommends setting up your software. See [“Setting up your software” on page 42](#).

After starting your computer for the first time you may want to:

- ❖ Add more memory (see [“Adding memory \(optional\)” on page 45](#))
- ❖ Connecting external devices (see [“Connecting an external device” on page 67](#))
- ❖ Connect an external monitor (see [“Using external display devices” on page 67](#))

Adding memory (optional)



HINT: To purchase additional memory modules, see the accessories information packaged with your system or visit accessories.toshiba.com.

Your computer comes with enough memory to run most of today's popular applications. You may want to increase the computer's memory if you use complex software or process large amounts of data.

NOTE Before adding external devices or memory, Toshiba recommends setting up your software. See [“Setting up your software” on page 42](#).

Installing a memory module

Memory modules can be installed in the memory module slots on the underside of the computer. You will need a small Phillips screwdriver for this procedure.

CAUTION

If the computer has been running recently, the memory module(s) may be hot. The surrounding area may also be hot. Allow the module(s) to cool to room temperature before replacing it. Avoid touching the cover, the module(s), and the surrounding area before they have cooled. Failure to follow these directions could result in minor bodily injury.

CAUTION

To avoid damaging the computer's screws, use a Phillips screwdriver of the correct size that is in good condition.

CAUTION

Installing a memory module with the computer's power on may damage the computer, the module, or both.

The computer has two memory slots—Slot A and Slot B. You can install one or two memory modules.

CAUTION

Before you install or remove a memory module, turn off the computer. If you install or remove a memory module while the computer is in Sleep or Hibernation mode, data will be lost.

NOTE

For this model, Slot A is the bottom slot. Slot B is the top slot. If only one memory module is to be installed, it must be installed in Slot A.

If the computer is on, begin at step 1; otherwise, skip to step 5.

- 1 From the Start or Desktop screen, move your pointer over the upper or lower right corner of the screen.
- 2 When the Windows® Charms appear, click the **Settings** (⚙️) Charm.

CAUTION

Pressing the power button before shutting down the Windows® operating system could cause you to lose your work. Make sure the system indicator panel's storage drive light and the drive in-use light are off. If you turn off the power while a disk/disc is being accessed, you may lose data or damage the disk/disc and/or drive.

- 3 In the lower right of the screen click the **Power** (🔌) icon.

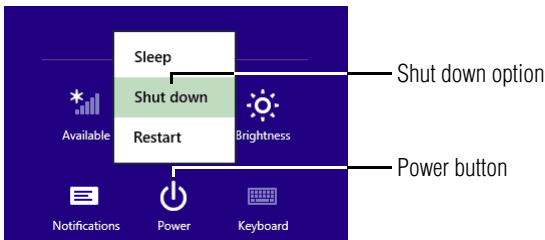

(Sample Image) Shut down

- 4 Highlight **Shut down** while holding the Shift key, and then click the **Shut down** option.

The computer closes all open applications, shuts down the operating system, and then turns off.

- 5 Unplug and remove any cables connected to the computer, including the AC adaptor.

CAUTION

Do not try to remove a memory module with the computer turned on. You can damage the computer and the memory module.

Do not remove the memory module while the computer is in Sleep or Hibernation mode. The computer could hang up the next time you turn it on and data in memory will be lost. In either of the above cases, the Sleep configuration will not be saved.

- 6 Place a soft cloth on the work surface to prevent scratching the top cover of the computer, and then place the computer upside down on the cloth.
- 7 Remove the main battery. For information on removing the main battery, see [“Removing the battery from the computer”](#) on page 94.

NOTE

To locate your memory module slot please refer to your Quick Start document.

- 8 Using a small Phillips screwdriver, loosen the screw(s) that secure the memory module slot cover.

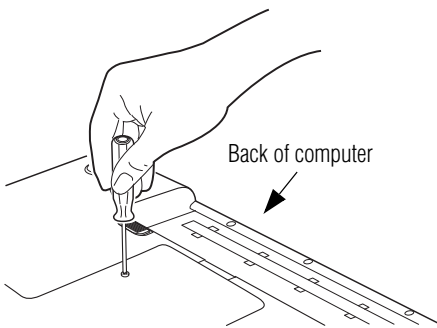

(Sample Illustration) Removing the memory module slot cover

- 9 Remove the memory module slot cover.
 - 10 Place the screw(s) and the cover in a safe place so that you can retrieve them later.
-

CAUTION

Static electricity can damage the memory module. Before you handle the module, touch a grounded metal surface to discharge any static electricity you may have built up.

CAUTION

Avoid touching the connector on the memory module or on the computer. Grease or dust on the connector may cause memory access problems.

- 11 Carefully remove the new memory module from its antistatic packaging, without touching its connector.
 - 12 Locate an empty memory module slot on the underside of the computer.
-

NOTE

If no memory slot is available, you must remove a module by performing steps 2-3 of [“Removing a memory module”](#) on page 51.

NOTE

If your system has the memory modules stacked on top of one another, you must remove the top module first before removing/installing the bottom module.

NOTE

For this model, Slot A is the bottom slot. Slot B is the top slot. If only one memory module is to be installed, it must be installed in Slot A.

- 13** Pick up the memory module by its sides, avoiding any contact with its connector. Position the module toward the socket, aligning the connector's notch with the matching key in the socket.

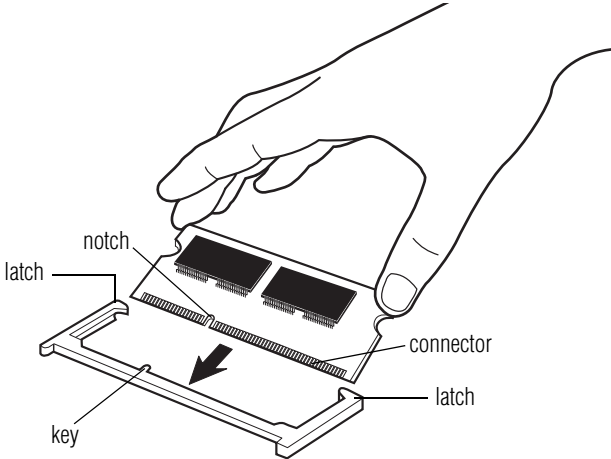

(Sample Illustration) Aligning the memory module with the socket

- 14** Firmly press the memory module into the memory slot's socket at approximately a 30-degree angle (to the horizontal surface of the computer).

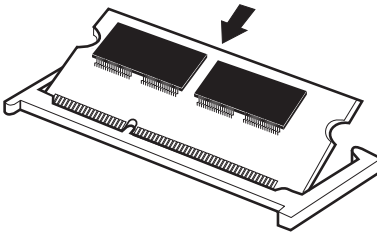

(Sample Illustration) Inserting the memory module into the socket

- 15** Once the module's connector is fully inserted into the socket, press downward on the top edge of the module to seat the module into the latches at the sides of the socket. These latches should "snap" into place securely with the corresponding cutouts in the side of the module. If the latches and cutouts do not line up correctly, repeat steps 14-15.

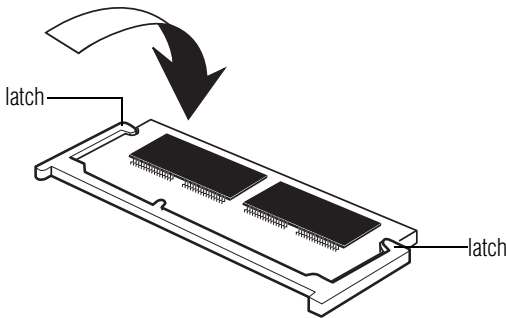

(Sample Illustration) Pressing down on the memory module

Do not force the memory module into position. The memory module should be completely inserted into the socket and level when secured in place.

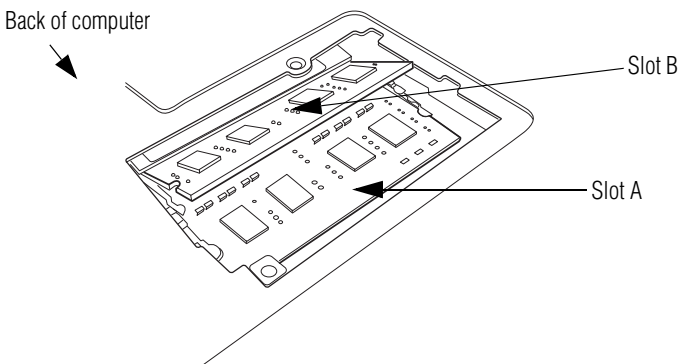

(Sample Illustration) Inserting the memory module into the slot

NOTE

For this model, Slot A is the bottom slot. Slot B is the top slot. If only one memory module is to be installed, it must be installed in Slot A.

- 16** Replace the memory module slot cover and secure it using the screw(s).
- 17** Re-insert the main battery. For more information on inserting the main battery, see [“Inserting a charged battery”](#) on page 95.
- 18** Turn the computer right side up. Make sure to remove the soft cloth from the work surface before restarting the computer.

▲ WARNING

Always make sure your computer and AC adaptor have adequate ventilation and are protected from overheating when the power is turned on or when an AC adaptor is connected to a power outlet (even if your computer is in Sleep mode). In this condition, observe the following:

- ❖ Never cover your computer or AC adaptor with any object.
- ❖ Never place your computer or AC adaptor near a heat source, such as an electric blanket or heater.
- ❖ Never cover or block the air vents including those located at the underside of the computer.
- ❖ Always operate your computer on a hard flat surface. Using your computer on a carpet or other soft material can block the vents located at the underside of the computer.

Overheating your computer or AC adaptor could cause system failure, computer or AC adaptor damage or a fire, possibly resulting in serious injury.

19 Reconnect the cables.

20 Restart the computer.



TECHNICAL NOTE: You must have at least one memory module installed for the computer to work.

You can now continue setting up the computer. When the operating system has loaded, you can verify that the computer has recognized the additional memory module.

If you are adding extra memory after setting up the computer, verify that the computer has recognized it correctly as described in [“Checking total memory” on page 53](#).

Removing a memory module

If you need to remove a memory module:

- 1** Complete steps 1–10 in [“Installing a memory module” on page 45](#) to shut down the computer and open the memory module slot cover.

CAUTION

Do not try to remove a memory module with the computer turned on. You can damage the computer and the memory module.

Do not remove the memory module while the computer is in Sleep or Hibernation mode. The computer could hang up the next time you turn it on and data in memory will be lost. In either of the above cases, the Sleep configuration will not be saved.

- 2 Pull the latches away from the memory module.

The memory module pops up slightly.

NOTE

If your system has the memory modules stacked on top of one another, you must remove the top module first before removing/installing the bottom module.

- 3 Gently lift the memory module to a 30-degree angle and slide it out of the slot.

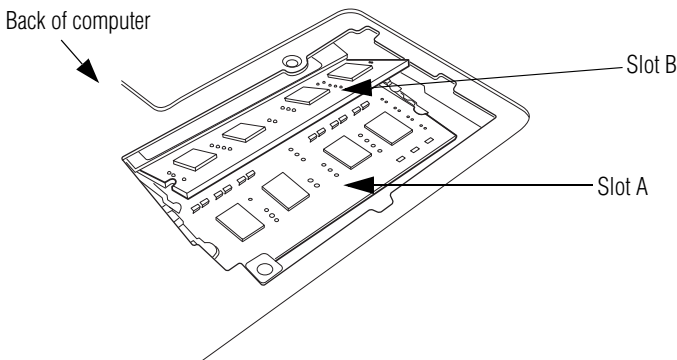

(Sample Illustration) Removing the memory module

- 4 Replace the memory module slot cover and secure it using the screw(s).
- 5 Re-insert the main battery. For more information on inserting the main battery, see [“Inserting a charged battery”](#) on page 95.
- 6 Turn the computer right side up. Make sure to remove the soft cloth from the work surface before restarting the computer.

⚠ WARNING

Always make sure your computer and AC adaptor have adequate ventilation and are protected from overheating when the power is turned on or when an AC adaptor is connected to a power outlet (even if your computer is in Sleep mode). In this condition, observe the following:

- ❖ Never cover your computer or AC adaptor with any object.
- ❖ Never place your computer or AC adaptor near a heat source, such as an electric blanket or heater.
- ❖ Never cover or block the air vents including those located at the underside of the computer.
- ❖ Always operate your computer on a hard flat surface. Using your computer on a carpet or other soft material can block the vents located at the underside of the computer.

Overheating your computer or AC adaptor could cause system failure, computer or AC adaptor damage or a fire, possibly resulting in serious injury.

7 Reconnect the cables.

8 Restart the computer.



TECHNICAL NOTE: You must have at least one memory module installed for the computer to work.

Upon restarting your computer, touch any key to return to the login in screen.

Checking total memory

When you add or remove a memory module, you can check that the computer has recognized the change. To do this:

Press the (⌘) + X keys, and then click **System**.

The **System** window appears. **Installed memory (RAM)** is displayed below the System heading.

If the computer does not recognize the memory configuration, turn off the computer and remove the memory module slot cover (complete steps 1-10 in “[Installing a memory module](#)” on page 45), and then check that the module is inserted completely into the socket and lined up squarely with the socket latches.

NOTE

From time to time, Windows® will display a pop-up that says, “Do you want to allow the following program to make changes to this computer?” This is a security feature to prevent programs or people from doing things on your computer without your permission. If you were trying to perform the action, click Continue; otherwise, click Cancel. If unsure, cancel and try again.

Recovering the Internal Storage Drive

Your computer includes recovery utilities to allow you to recover your internal storage drive if necessary.

The following internal storage drive recovery options are available:

Recovery option	Description
Creating recovery media	This option allows you to create the recovery media you will use to restore your computer. See “Creating recovery media” on page 55.
Restoring from recovery media	This option allows you to restore your system from the recovery media you created. See “Restoring from recovery media” on page 57.
Refresh your PC (with user’s data)	This option allows you to refresh your system without losing your data. See “Refresh your PC (with user’s data)” on page 58.
Reset your PC	This option allows you to remove all data from your system and reinstall Windows®. See “Reset your PC” on page 60.

A recovery image of your computer is stored on the internal storage drive, and the image can be restored by running the recovery utilities directly from your internal storage drive as described in the sections below. However, it is strongly recommended that you create recovery media. If the recovery files on your internal storage drive become corrupted or are deleted, you can restore your system from your recovery media. Also, if your original internal storage drive fails, you can restore your system to a new internal storage drive from your recovery media. It is strongly recommended that you create recovery media before using your system for the first time. See [“Creating recovery media” on page 55](#) and [“Restoring from recovery media” on page 57.](#)

- NOTE**
- ❖ During the recovery process your computer must be connected to an external power source via the AC adaptor.
 - ❖ When you restore your system, only the operating system files, applications, and drivers originally shipped with the computer are restored. Any files that you created are not restored during this process. Be sure to separately save the files you have created to external media using Windows® or another backup program. For more information, see [“Backing up your work” on page 78](#).
-

Creating recovery media

It is strongly recommended that you create recovery media. If the recovery files on your internal storage drive become corrupted or are deleted, you can restore your system from your recovery media. Also, if your original internal storage drive fails, you can restore your system to a new internal storage drive from your recovery media.

- NOTE** During the recovery process your computer must be connected to an external power source via the AC adaptor.
-

- NOTE** When you create recovery media, only the operating system files, applications, and drivers originally shipped with the computer are backed up to the external media and can be restored from this media. Any files that you created are not backed up on the recovery media. You will need to separately back up the files you created; for more information, see [“Backing up your work” on page 78](#).
-

When you create recovery media, the system will prompt you to insert several blank DVDs or connect one or more USB flash drives of a certain minimum capacity to your computer. The amount of space required for storing the recovery files varies by computer model. Follow the procedure below to determine how much space you will need for storing your system’s recovery files.

To create recovery media:

- 1** From the Start screen begin typing **Recovery Media Creator** and click your selection, or if you are in the Desktop, move your pointer over the upper or lower right corner of the screen. When the Windows® Charms appear click the **Search** 

Charm and, in the Search field, type **Recovery Media Creator**. In the list that above, click your selection.

The TOSHIBA Recovery Media Creator dialog box displays.

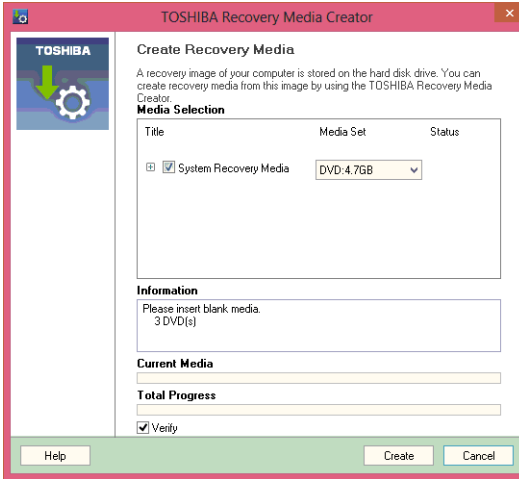

(Sample Image) TOSHIBA Recovery Media Creator dialog box

- 2 Select **DVD** or **USB Flash** from the drop-down list, depending on the type of external media you want to use.
- 3 Check the “Information” area of the dialog box to determine the number of DVDs you will need and/or the minimum amount of storage space required for copying your system’s recovery files to USB flash drive(s).
- 4 Do one of the following:
 - ❖ If you are copying files to DVD, insert a blank DVD into the optical disc drive.
 - ❖ If you are copying files to a USB flash drive, connect a USB flash drive of the required minimum capacity (as specified in the TOSHIBA Recovery Media Creator utility) to your computer.

CAUTION

All information stored on your DVDs or USB flash drive(s) will be erased during the process of creating the recovery media. Be sure to save the information stored on your external media to another storage device before executing this procedure, or use blank media.

- 5 Click the **Create** button in the TOSHIBA Recovery Media Creator utility dialog box.

- 6 Follow the on-screen prompts to complete the copy process.
-

NOTE If you are copying the recovery files to DVDs, be sure to label each DVD in the set sequentially (for example, “1 of 3,” “2 of 3,” etc.), so that you will know in which order to insert the discs during recovery.

For information on using the Recovery media you have created with the preceding steps, see [“Restoring from recovery media” on page 57](#).

Restoring from recovery media

CAUTION The recovery process deletes information stored on the internal storage drive. Be sure to save your work to external media before executing the recovery (see [“Backing up your work” on page 78](#)).

NOTE During the recovery process your computer must be connected to an external power source via the AC adaptor.

If you have created recovery media for your system, you can restore your system from such media, if necessary. For example, if your original internal storage drive fails, you can restore your system to a new internal storage drive from your recovery media. For instructions on creating recovery media, see [“Creating recovery media” on page 55](#).

NOTE When you restore your system, only the operating system files, applications, and drivers originally shipped with the computer are restored. Any files that you created are not restored during this process. Be sure to separately save the files you have created to external media using Windows® or another backup program. For more information, see [“Backing up your work” on page 78](#).

To recover your internal storage drive from recovery media:

- 1 Make sure your computer is turned off.
- 2 Do one of the following:
 - ❖ If your recovery files are on DVDs, insert the first recovery DVD into your optical disc drive.
 - ❖ If your recovery files are on a USB flash drive, connect the USB flash drive to your computer.

- 3 Press and hold the F12 key immediately after pressing the power button.
The Boot menu displays.
- 4 Using the arrow keys, select the **DVD** option or the **USB Flash** option, depending on which type of media you are using, and then press the ENTER key.
- 5 A warning screen appears, stating that when the recovery is executed all data on your internal storage drive will be deleted and rewritten. Click **Yes** to continue.
- 6 Follow the on-screen instructions to complete the recovery process.
When the process is complete, a message displays indicating that the drive has been recovered.
- 7 Click **Finish** to restart the computer.

Refresh your PC (with user's data)

CAUTION

Using “Refresh your PC” recovers your internal storage drive to factory default state and attempts to save your data. Toshiba does not guarantee successful data back-up. Please make a complete back up of your data to external media before executing the recovery. For more information, see [“Backing up your work” on page 78](#).

NOTE

During the recovery process your computer must be connected to an external power source via the AC adaptor.

You can recover the factory default software (refresh your PC), while the computer will attempt to back up your data using the utilities stored on your computer's internal storage drive:



TECHNICAL NOTE: Your data will be copied into the backup folder. All of the data will be moved to this folder during the recovery process, however the current directory structure will be retained.

- 1 From the Start or Desktop screen, move your pointer over the upper or lower right corner of the screen.
- 2 When the Windows® Charms appear click the **Settings** (⚙️) Charm.

3 Click **Change PC Settings**.

The PC settings window appears.

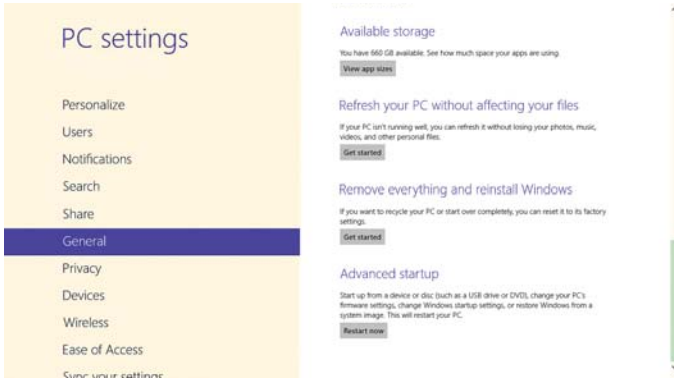

(Sample Image) PC settings screen

4 Click **General**.

5 Scroll down to “Refresh your PC without affecting your files,” and click **Get Started**.

The “Refresh your PC” screen appears.

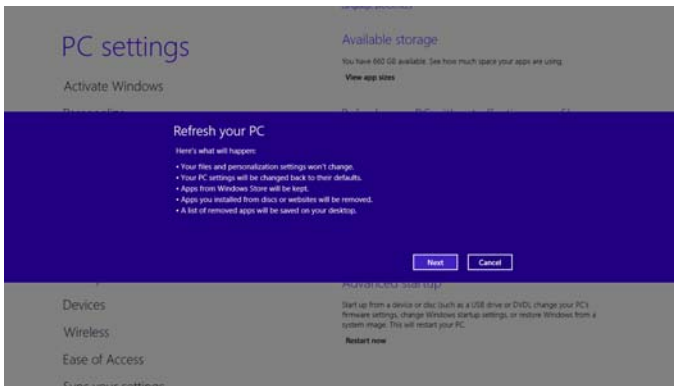

(Sample Image) Refresh your PC screen

CAUTION

Toshiba does not guarantee successful data back up. Be sure to save your work to external media before executing the recovery (see “Backing up your work” on page 78).

- 6 Click the **Next** button to begin.

The “Ready to refresh your PC” screen appears.

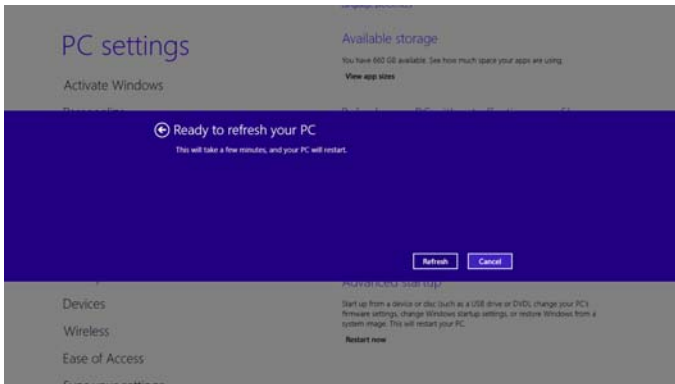

(Sample Image) Ready to refresh your PC screen

You will be prompted to refresh your system.

- 7 Click the **Refresh** button.
- 8 Your system will restart.

The “Refreshing your PC” window appears. When the process is complete your system will reboot your Windows® operating system.

Reset your PC

CAUTION

The recovery process deletes information stored on the internal storage drive. Be sure to save your work to external media before executing the recovery (see “Backing up your work” on page 78).

NOTE

During the recovery process your computer must be connected to an external power source via the AC adaptor.

- 1 From the Start or Desktop screen, move your pointer over the upper or lower right corner of the screen.
- 2 When the Windows® Charms appear click the **Settings** (⚙️) Charm.

3 Click **Change PC Settings**.

The PC settings window appears.

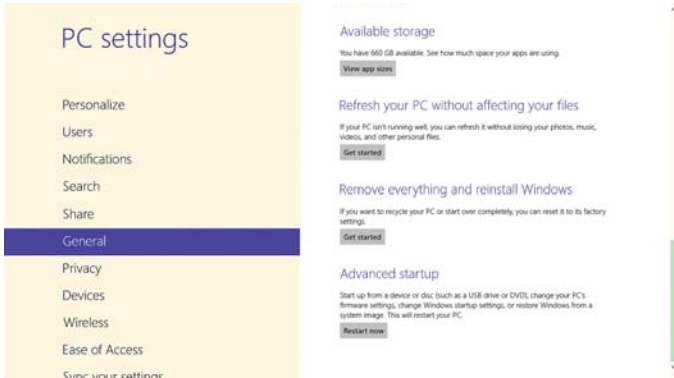

(Sample Image) PC settings screen

4 Click **General**.

5 Scroll down to “Remove everything and reinstall Windows,” and click **Get Started**.

The “Reset your PC” screen appears.

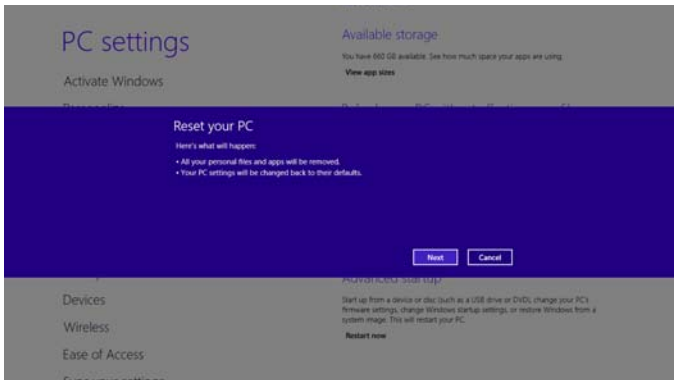

(Sample Image) Reset your PC screen

6 Click the **Next** button.

The “Do you want to fully clean your drive” screen appears.

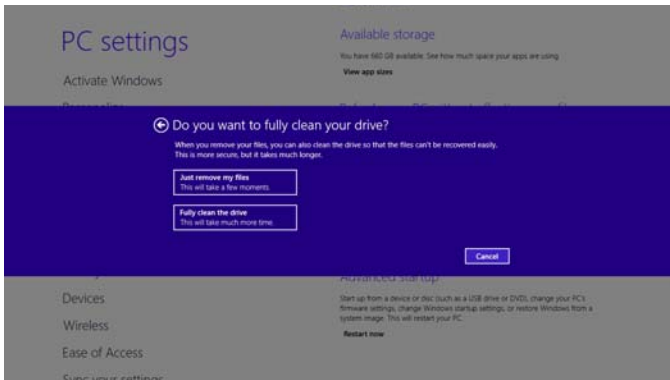

(Sample Image) Do you want to fully clean your drive screen

7 Select one of the following options:

❖ **Just remove my files**

❖ **Fully clean the drive**

The “Ready to reset your PC” screen appears.

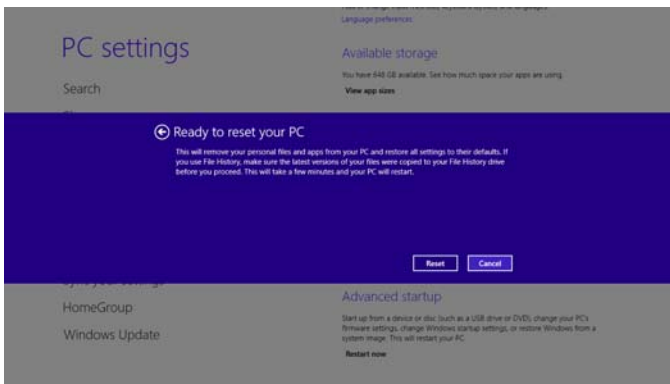

(Sample Image) Ready to reset your PC screen

8 Click the **Reset** button.

The “Resetting your PC” window appears. When the process is complete your system will reboot your Windows® operating system.

NOTE Selecting the “Fully clean the drive” option may take several hours.

Installing drivers and applications

The TOSHIBA Application Installer allows you to reinstall the drivers and applications that were originally bundled with your computer.

To reinstall drivers and applications:

- 1 From the Start screen begin typing **TOSHIBA Application Installer** and click your selection, or if you are in the Desktop, move your pointer over the upper or lower right corner of the screen. When the Windows® Charms appear click the **Search** (🔍) Charm and, in the Search field, type **TOSHIBA Application Installer**. In the list that above, click your selection.

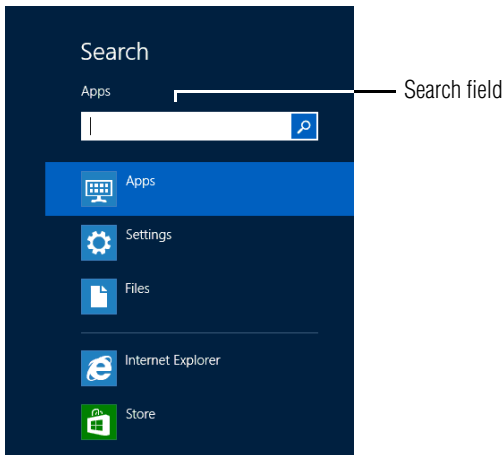

(Sample Image) Installing drivers and applications

- 2 Click **Next**.
- 3 Click the item you want to install.
- 4 Click **Install**.
- 5 Follow the on-screen prompts to complete the installation process.

Using the touch pad

NOTE Some of the touch pad operations described in this section are only supported in certain applications, and only on certain models.

You can use the touch pad (the small, touch-sensitive area in front of the keyboard) and the adjacent control buttons to to:

- ❖ Move the pointer on the screen
- ❖ Select an item on the screen
- ❖ Open or activate an item on the screen
- ❖ Scroll through a document or information
- ❖ Zoom in for a close-up view
- ❖ Zoom out to see more information at once

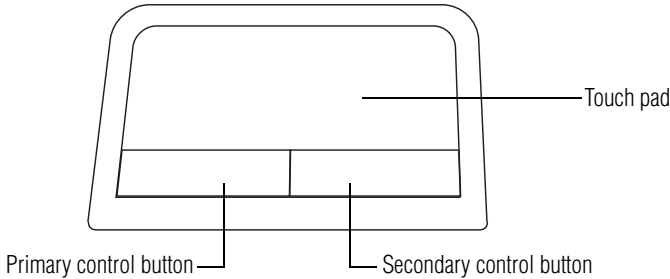



(Sample Illustration) The touch pad and associated control buttons

Refer to the table below for specific instructions on performing each operation.

NOTE The *pointer* is the icon (usually an arrow) that moves on the screen when you slide your finger across the touch pad or move a mouse connected to your computer.

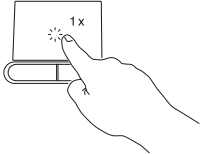
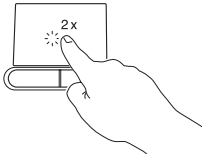
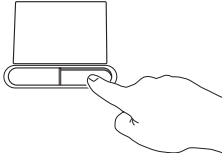
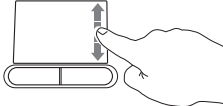
<i>To:</i>	<i>Do the following:</i>	<i>Example:</i>
Move the on-screen pointer	Slide your finger across the touch pad in the direction you want to move the pointer. To move the pointer a longer distance, slide your finger several times across the touch pad in the preferred direction.	<p>A hand is shown sliding its index finger across the touch pad of a laptop. On the laptop screen, a pointer icon (a small arrow) is moving to the right. The touch pad and control buttons are visible below the screen.</p> <p><i>(Sample Illustration) Pointer moves to the right</i></p>

To:	Do the following:	Example:
Select an item	<ol style="list-style-type: none">1 Move the pointer to the item you want to select.2 Do one of the following:<ul style="list-style-type: none">❖ Tap the touch pad onceOR❖ Press and release the primary (left-hand) control button	 <p><i>(Sample Illustration) Tap once to select</i></p>
Open or activate an item	<ol style="list-style-type: none">1 Move the pointer to the item you want to open/activate.2 Do one of the following:<ul style="list-style-type: none">❖ Tap the touch pad twice in rapid successionOR❖ Press and release the primary control button twice in rapid succession	 <p><i>(Sample Illustration) Tap twice to open</i></p>
Right-click an item	<ol style="list-style-type: none">1 Move the pointer to the item you want to right-click.2 Press and release the secondary control button. <p>This feature varies by application. Check your application documentation for specific instructions on right-clicking.</p>	 <p><i>(Sample Illustration) Click the secondary (right-hand) control button</i></p>
Scroll vertically	Slide your finger along the right edge of the touch pad in the direction you want to scroll. Repeat to scroll a longer distance.	 <p><i>(Sample Illustration) Vertical scrolling active area</i></p>
Scroll horizontally	Slide your finger along the bottom edge of the touch pad in the direction you want to scroll. Repeat to scroll a longer distance.	 <p><i>(Sample Illustration) Horizontal scrolling active area</i></p>

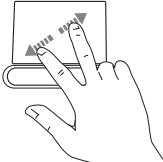
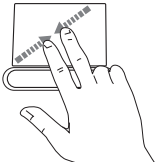
<i>To:</i>	<i>Do the following:</i>	<i>Example:</i>
Zoom in/out	<p>To zoom in:</p> <ul style="list-style-type: none"> ❖ Place two fingers close together on the touch pad and then slide them apart. <p>To zoom out:</p> <ul style="list-style-type: none"> ❖ Place two fingers slightly apart on the touch pad and then slide them together. 	 <p><i>(Sample Illustration)</i> <i>Zooming in</i></p>  <p><i>(Sample Illustration)</i> <i>Zooming out</i></p>

Adjusting touch pad settings

While you are typing, the on-screen pointer may seem to move or jump around “by itself” to random locations on the screen. The on-screen pointer may also seem to automatically select text, click buttons, and activate other user interface elements. For help with these problems, try one or more of the following:

- ❖ Try adjusting your typing technique to avoid accidental contact with the touch pad. You may be inadvertently brushing the touch pad with the heel of your hand as you type. Also, accidental light touches or taps on the touch pad may select an item or text on the screen, and potentially the item or text may be replaced by the next character you type.
- ❖ Temporarily disable the touch pad, so that it does not respond to touch or button presses while you type. See “[Disabling or enabling the touch pad](#)” on page 67.
- ❖ Adjust the sensitivity of the touch pad, so that it is less responsive to accidental light taps and lighter finger pressure.

NOTE

Touch pad setting options vary by computer model. The touch pad settings are accessible through the Mouse Properties option of the Windows Control Panel. For more information, please visit support.toshiba.com.

Disabling or enabling the touch pad

The touch pad is enabled by default. To enable/disable the touch pad, press F5. For more information, see “Disabling or enabling the touch pad” on page 159.

Connecting an external device

NOTE Depending on your system, some models may include USB 3.0 port(s). To distinguish these ports, please look for the blue inset within the USB 3.0 port (if available).

You can easily attach an external device your computer.

To do this:

- 1 Read the directions that came with the device to see if you first need to install new software.
- 2 Connect the device’s video or USB cable to the port on the computer and to the device.
- 3 Connect the device’s power cable to a live electrical outlet (if applicable).
- 4 Turn on the external device (if applicable).

Your computer may automatically detect the external device.



Using external display devices

Your computer comes with a built-in display, but you can also connect the following types of external display devices to the video ports described below:

NOTE To locate your HDMI™ or RGB port please refer to your Quick Start document.

- ❖ An HDMI™-compatible television or external display device via the HDMI™ Out port*

- ❖ An external monitor or projector via the RGB (monitor) port

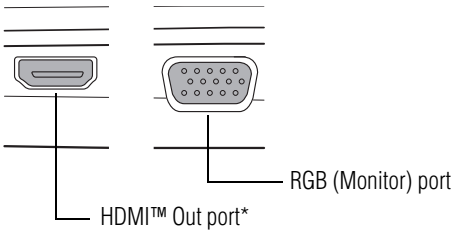

*Available on certain models

(Sample Illustration) Video ports

Selecting video cables

To connect a device to the HDMI™ Out port, you must purchase an HDMI™ cable.

Connecting an HDMI™-compatible television or display device

To connect an HDMI™-compatible television or display device to the computer:

- ❖ Connect one end of an HDMI™ cable (not included with your computer) to the HDMI™ Out port on the side of your computer, and then connect the other end of the cable to your television or display device. Refer to the manual that came with the television or display device for more information.

Your computer should automatically detect the external display device.

Connecting an external monitor or projector

You can easily attach an external monitor or projector to your computer if you need a larger screen. To do this:

- 1 Read the directions that came with the monitor to see if you first need to install new software.
- 2 Connect the monitor's video cable to the RGB (monitor) port on the side of the computer.
- 3 Connect the device's power cable to a live electrical outlet.
- 4 Turn on the external device.

Your computer will automatically detect the external display device.

NOTE

You can change the display settings by pressing the (⌘) + P keys, or by configuring the display properties settings.

Directing the display output when you turn on the computer

Once you have connected an external display device, you can choose to use the internal display only, the external device only, or both simultaneously.

NOTE Some modes are only available with the appropriate device attached and turned on.

The quickest way to change the display output settings is to use the (⊞) + P keys:

Press the (⊞) + P keys repeatedly until the setting you want takes effect. Briefly pause each time you press the (⊞) + P keys to allow time for the display to change.

This cycles through the settings in the following order (the last two options are available if an external monitor is connected):

- ❖ PC screen only
- ❖ Duplicate
- ❖ Extend
- ❖ Second screen only

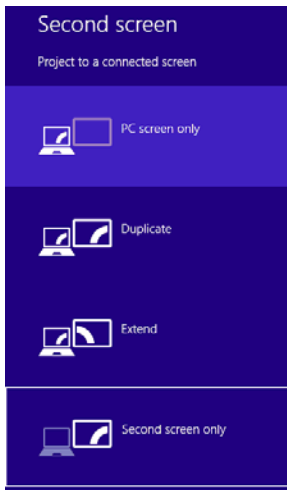

(Sample Image) Display options window

NOTE The (⊞) + P keys navigate through the options without activating a selection. Press ENTER to activate a selection.

NOTE

You may also use the F4 key, and then press ENTER to activate a selection.

Adjusting the quality of the external display

To obtain the best picture quality from your television (or other video display device), you may need to adjust the video settings. See the video device documentation for additional configuration steps.

Customizing your computer's settings

There are several ways in which you can customize your computer to suit your particular requirements. You can go into your computer settings to make adjustments to your computer to suit your needs.

From the Start or Desktop screen, move your pointer over the upper or lower right corner of the screen. When the Windows® Charms appear, click the **Settings** (⚙️) Charm and then click **Change PC Settings**. Then choose a category you wish to change. Refer to your operating system documentation or Help and Support for details.

You may also wish to customize your power usage settings. For more information, see [“Power Plans” on page 92](#). There are additional custom settings you can choose. See [“Utilities” on page 110](#).

Caring for your computer

This section gives tips on cleaning and moving your computer. For information about taking care of your computer's battery, see [“Taking care of your battery” on page 97](#).

NOTE

Please handle your computer carefully to avoid scratching or damaging the surface.

Cleaning the computer

CAUTION

Keep liquids, including cleaning fluid, out of the computer's keyboard, speaker, and other openings. Never spray cleaner directly onto the computer and/or display. Never use harsh or caustic chemical products to clean the computer.

To keep your computer clean, gently wipe the display panel and exterior case with a lightly dampened cloth.

Moving the computer

Before moving your computer, even across the room, make sure all drive activity has ended (the internal storage drive and optical disc drive indicator lights stop glowing) and all external peripheral cables are disconnected.

CAUTION

Do not pick up the computer by its display panel or by the back. Doing so could damage the system.

Using a computer lock

You may want to secure your computer to a heavy object such as your desk. The easiest way to do this is to purchase an optional computer lock cable. For more information on purchasing a cable lock, visit accessories.toshiba.com.

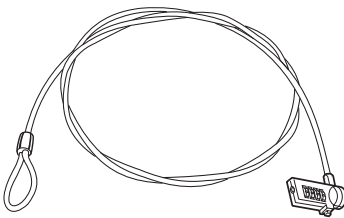

(Sample Illustration) Computer lock cable

To secure the computer:

- 1 Wrap the cable through or around some part of a heavy object. Make sure there is no way for a potential thief to slip the cable off the object.
- 2 Pass the locking end through the loop.

-  **3** Insert the cable's locking end into the security lock slot on your computer, then engage the locking device.

The computer is now securely locked.

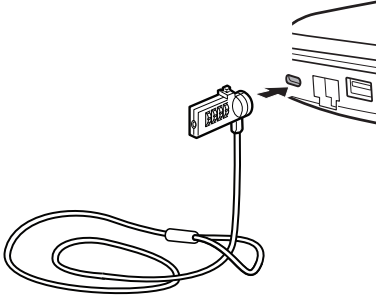

(Sample Illustration) Attaching security lock cable

Chapter 2

Learning the Basics

This chapter gives some computing tips and provides important information about basic features.

Computing tips

- ❖ Save your work frequently.

Your work stays in the computer's temporary memory until you save it to the internal storage drive. If the network you are using goes down and you must restart your computer to reconnect, or your battery runs out of charge while you are working, you will lose all work since you last saved.

See [“Saving your work” on page 78](#) for further information.



HINT: Some applications have an automatic save feature that can be activated. This feature saves your file to the internal storage drive at preset intervals. See your software documentation for details.

- ❖ Back up your files to external media on a regular basis. Label the backup copies clearly and store them in a safe place.

It is easy to put off backing up because it takes time. However, if your internal storage drive suddenly fails, you will lose all the data on it unless you have a separate backup copy. For more information, see “[Data and system configuration backup in the Windows® operating system](#)” on page 149.

- ❖ Use Error-checking and Disk Defragmenter regularly to check and optimize disk space and improve performance.
- ❖ Scan all new files for viruses.

This precaution is especially important for files you receive via external media, email, or download from the Internet.

- ❖ Take frequent breaks to avoid repetitive-motion injuries and eyestrain.
- ❖ Do not turn off the computer if a drive indicator light indicates a drive is active.

Turning off the computer while it is reading from or writing to a disk may damage the disk, the drive, or both.

NOTE

The Windows® operating system records information, such as your desktop setup, during its shutdown procedure. If you do not let the Windows® operating system shut down normally, details such as new icon positions may be lost.

Using the keyboard

Your computer’s keyboard contains character keys, control keys, function keys, and special Windows® keys, providing all the functionality of a full-size keyboard.

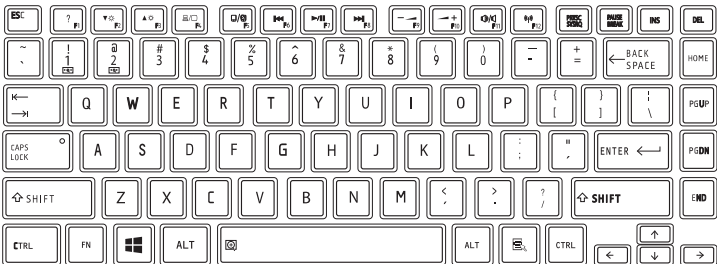

(Sample Illustration) Keyboard

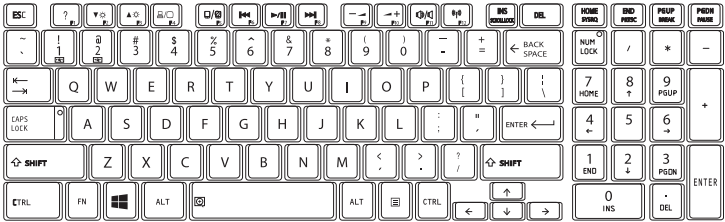

(Sample Illustration) Keyboard

NOTE

To capture a print screen of the entire screen, press the Fn + PRtSc key. (This only applies to models with a 10-key keypad).

To capture only the active window displayed, press Fn + ALT while simultaneously pressing the PRtSc key.

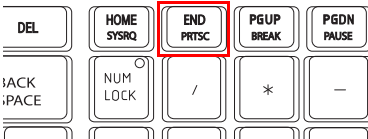

(Sample Illustration) PRtSc key on the keyboard

NOTE

Depending on your model, your system may not have a 10-key keypad.

Function keys

The function keys (not to be confused with the Fn key) are the 12 keys at the top of the keyboard.



(Sample Illustration) Function keys

F1 through F12 are called function keys because they execute programmed functions when pressed. Function keys marked with icons execute specific functions on the computer. For example, F5 turns the touch pad ON/OFF. For more information, see “Functions” on page 156.

Special Windows® keys

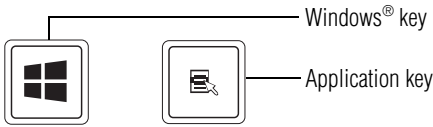

(Sample Illustration) Special Windows® keys

Your computer's keyboard has one key and one button that have special functions in Windows®:

- ❖ **Windows® key**—Toggles between the Desktop screen and the last app opened on the Start screen. For more information refer to Help & Support, or see [“Exploring the Start screen” on page 100](#).
- ❖ **Application key**—Has a similar function as the secondary mouse button

Mouse properties

Mouse properties allow you to change your pointing device or mouse settings.

To access Mouse properties:

- 1 Move your pointer over the upper or lower right corner of the screen. When the Windows® Charms appear click the **Search** (🔍) Charm, click **Settings** and, in the Search field, type **Mouse**. In the list that above, click your selection.

The Mouse Properties screen appears.

You may change some of the settings in the following categories:

- ❖ Buttons
- ❖ Pointers
- ❖ Pointer Options

You may see additional categories depending on your particular pointing device.

- 2 Adjust the settings as desired, and then click **OK**.

Starting an app

To Start an app on the Start screen, move your pointer over the appropriate tile and click to open.

To Start an app from the Desktop, move your pointer over the upper or lower right corner of the screen. When the Windows[®] Charms slide out from the right, click the **Start** (■) Charm.

Starting an app from the Start screen

To Start an app on the Start screen, move your pointer over the appropriate tile and click to open.

To Start an app using the Search function, move your pointer over the upper or lower right corner of the screen. When the Windows[®] Charms slide out from the right, click the **Search** (🔍) Charm. The apps screen appears with the available system apps to choose from or you can enter your search in the search field.

Below is an example using the Search field to start an app:

- 1 Move your pointer over the upper or lower right corner of the screen. When the Windows[®] Charms appear click the **Search** (🔍) Charm.

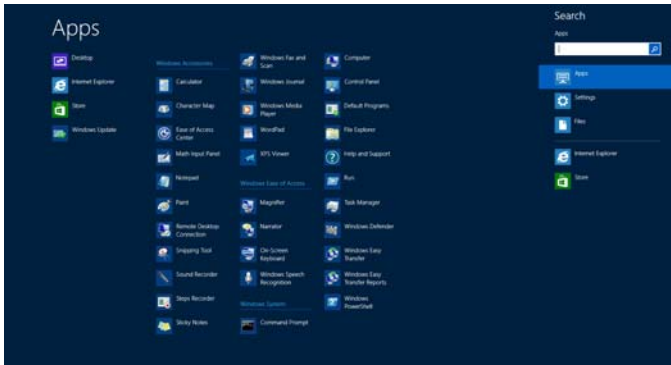

(Sample Image) Searching for apps

- 2 Start typing the app's name in the Search field.
As you type, all matching files and apps are displayed.
- 3 Click the app you wish to open.

Saving your work

Before you turn off the computer using the Shut down command, save your work on the internal storage drive, external media, flash media, or optical disc. This is one of the most important rules of computing.

Many applications offer a feature that saves documents at regular intervals. Check your application's documentation to see if it has an automatic save feature.

Backing up your work

Back up all the files you create in case something happens to your computer. You can back up your files to different types of media such as CDs, DVDs, external storage media, or to a network, if available.

To back up several files at one time, use the Microsoft® Windows® file recovery program preinstalled on the computer's internal storage drive. Also see [“Backing up your data or your entire computer with the Windows® operating system” on page 151.](#)



HINT: Backing up all the files on your internal storage drive may take a considerable amount of time and multiple CDs/DVDs. You may prefer to use a high-capacity file recovery system, such as an external hard drive.

Using the optical disc drive

Optical storage is a popular medium for software, music, and video. Digital versatile discs (DVDs) provide a significant increase in data storage and support features that were not available on previous video platforms. These features include wide-screen movies, multiple language tracks, digital surround sound, multiple camera angles, and interactive menus.



TECHNICAL NOTE: Your optical disc drive is set to play region 1 (North America) DVD-ROMs. If you play a DVD disc from another region, the drive will automatically change to play in the format of the other region. The drive will allow you to change regions four times. On the fourth change, the region will be “locked in.” That is, the drive will only play DVDs from that last region. Note that changing from region 1 to region 2 and back to region 1 is counted as two changes.

NOTE For optimum DVD performance, it is recommended that you play DVDs while running the computer on AC power.

NOTE When viewing DVD movies use the DVD Player software that came with your computer.

Optical disc drive components

The optical disc drive is located on the side of the computer.

Your optical disc drive may look like this:

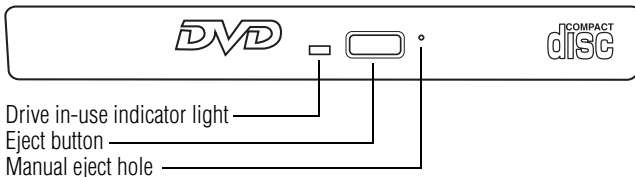

(Sample Illustration) Optical disc drive

Drive in-use indicator light—Indicates when the drive is in use.

Eject button—Press to release the disc tray.

CAUTION Do not press the eject button or turn off the computer while the drive in-use indicator light is glowing. Doing so could damage the disc or the drive.

When the disc tray is open, be careful not to touch the lens or the area around it. Doing so could cause the drive to malfunction.

Manual eject hole—Use if you need to release the disc tray when the power is off. Use a straightened paper clip or other narrow object to press the manual eject button located inside the hole.

CAUTION Never use a pencil to press the manual eject button. Pencil lead can break off inside the computer and damage it.

Media control buttons

The media control buttons located above the keyboard allow you to mute the sound and play audio CDs or DVD movies when the computer is on.

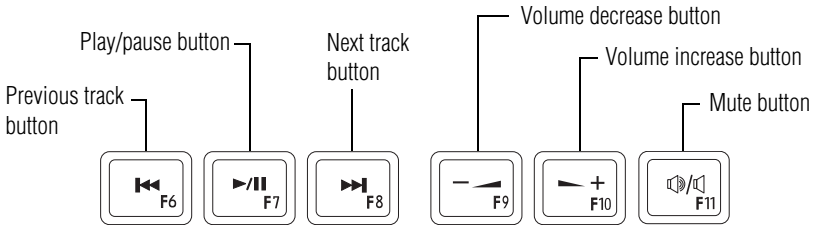

(Sample Illustration) Media control buttons

The **Previous track** button allows you to return to the preceding track on the disc.

The **Play/pause** button allows you to start playing the disc, or pause it if currently playing.

The **Next track** button allows you to skip to the following track on the disc.

The **Volume decrease** button allows you to decrease the volume of the sound coming from the computer.

The **Volume increase** button allows you to increase the volume of the sound coming from the computer.

The **Mute** button allows you to mute the sound.

Inserting an optical disc

To insert an optical disc into the drive:

- 1 Make sure the computer is turned on.
- 2 Make sure the drive's in-use indicator light is off.
- 3 Press the drive's eject button.
- 4 Hold the disc by its edges and check that it is free of dust.
If the disc is dusty, clean it.
- 5 Place the disc carefully in the disc tray, label side up, and gently press the disc onto the center spindle until it clicks into place.

CAUTION

Handle DVDs and CDs carefully, making contact only with the center hole and edge. Do not touch the surface of the disc. Do not stack discs. If you incorrectly handle the discs, you could lose data.

-
- 6 Make sure the disc is completely on the spindle and is lying flat on the tray.

CAUTION

If you insert the disc incorrectly, it may jam the drive. If this happens, contact Toshiba support for assistance.

- 7 Push the disc tray in by pressing gently on the center of the tray until it clicks into place.

Removing a disc with the computer on

To remove an optical disc with the computer turned on:

- 1 Press the eject button on the drive.

CAUTION

Do not press the eject button while the drive in-use indicator light is glowing. Doing so could damage the disc or the drive.

Also, if the disc is still spinning when you open the disc tray, wait for it to stop spinning before you remove it.

- 2 Remove the disc, and place it in its protective cover.
- 3 Gently press the tray in to close it.

Playing optical media

If you insert an optical disc into the optical disc drive and the Auto-Run feature does not automatically start your disc, try launching the optical disc manually. To do this, follow these steps:

- 1 Press the (⏏) + E keys.
- 2 Double-click the optical disc drive icon.

The drive will run the optical disc.

If your disc does not run using this method, try using an application that is associated with the media on the disc. For example, if it is a music CD, open Windows Media® Player and use it to select and then play the CD. For other types of media, use the associated software to open the files on the disc.

Recording optical media

Depending on the configuration, your computer may come with an optical disc drive that allows you to:

- ❖ Play pre-recorded and recorded optical media.
- ❖ Read/write data and multi-media files to recordable optical media.

For more information regarding supported optical media formats please refer to your computer's detailed specifications at support.toshiba.com.

NOTE

Due to manufacturing and quality variations in third party optical media (e.g., CD or DVD) or optical media players/recorders, in certain cases, your Toshiba optical disc drive may not record on certain optical media that bear the applicable logo, or play back optical media recorded by other computers or optical media recorders. Additionally, certain optical media recorded on your optical disc drive may not play back or operate properly on other computers or optical media players. These problems are not due to any defect in your Toshiba computer or optical disc drive. Please refer to your computer's product specification for listing of specific format compatibilities.

Copy protection technology may also prevent or limit recording or viewing of certain optical media.

For details on how to use the software, please refer to the respective Online Help menus.

Removing a disc with the computer off

To remove a disc with the computer turned off:

- 1 Insert a slender object, such as a straightened paper clip, into the manual eject hole.

The disc tray slides partially out of the drive.

CAUTION

Never use a pencil to press the manual eject button. Pencil lead can break off inside the computer and damage it.

- 2 Pull the tray out until it is fully open, remove the disc, and place it in its protective cover.
- 3 Gently press the tray in to close it.

Toshiba's online resources

Toshiba maintains a number of online sites to which you can connect. These sites provide information about Toshiba products, give help with technical questions and keep you up to date with future upgrades. For more information, see [“Contacting Toshiba”](#) on page 154.

Chapter 3

Mobile Computing

This chapter covers all aspects of using your computer while traveling.

Toshiba's energy-saver design

Your computer enters a low-power suspension mode when it is not being used, thereby conserving energy and saving money in the process. It has a number of other features that enhance its energy efficiency.

Many of these energy-saving features have been preset by Toshiba. We recommend you leave these features active, allowing your computer to operate at its maximum energy efficiency, so that you can use it for longer periods while traveling.

Running the computer on battery power

The computer contains a removable Lithium-Ion (Li-Ion) battery that provides power when you are away from an AC outlet. You can recharge it many times.

Battery Notice

Battery life rating is for comparison purposes only, and does not indicate the battery life that will be obtained by any individual user. Actual battery life may vary considerably from specifications depending on product model, configuration, applications, power management settings and features utilized, as well as the natural performance variations produced by the design of individual components. The battery life rating is only achieved on the select models and configurations tested by Toshiba under the specific test settings at the time of publication and is not an estimate of a system's battery life under any conditions other than the specific test settings.

Recharge time varies depending on usage. Battery may not charge while the computer is consuming full power. After a period of time, the battery will lose its ability to perform at maximum capacity and will need to be replaced. This is normal for all batteries. To purchase a new battery pack, see the accessories information included with your computer or visit the Toshiba Web site at accessories.toshiba.com. Use only batteries designed to work with your Toshiba computer.

To ensure that the battery maintains its maximum capacity, operate the computer on battery power at least once a month. The Lithium-Ion battery has no memory effect so it is not necessary to let the battery fully discharge each time. However, for better accuracy of the battery meter, it is helpful to fully discharge the battery periodically. Please see “[Maintaining your battery](#)” on [page 98](#) for procedures. If the computer is continuously operated on AC power, either through an AC adaptor or a port replicator (if applicable to your system), for an extended period (more than a month), the battery may fail to retain a charge. This may shorten the life of the battery, and may cause the battery meter to be inaccurate.

NOTE

For optimum optical media performance, it is recommended that you play DVDs while running the computer on AC power. For more information about Windows® power plans, see “[Power Plans](#)” on [page 92](#).

The computer also has an internal real-time-clock (RTC) battery.

The RTC battery powers the RTC memory that stores your system configuration settings and the current time and date information. It maintains this information for up to a month while the computer is turned off.



TECHNICAL NOTE: Depending on your system, the RTC battery may only charge while the computer is turned on.

Power management

Your computer ships with the power management options preset to a configuration that will provide the most stable operating environment and optimum system performance for both AC power and battery modes.

CAUTION

Changes to these settings may result in system performance or stability issues. Users who are not completely familiar with the power management component of the system should use the preset configuration. For assistance with setup changes, contact Toshiba's Customer Support Center.

Charging the main battery

The battery needs to be charged before you can use it to power the computer.

To charge the main battery while it is in your computer, plug the computer into a live electrical outlet. The battery charges whether the computer is on or off.



TECHNICAL NOTE: The recharging of the battery may not occur when your computer is using all of the power provided by the AC adaptor to run applications, features, and devices. Your computer's Power Options utility can be used to select a power level setting that reduces the power required for system operation and will allow the battery to recharge.

The battery may not start charging immediately under the following conditions:

- ❖ The battery is extremely hot or cold.

To ensure that the battery charges to its full capacity, wait until it reaches room temperature (50 to 80 degrees Fahrenheit, 10 to 26 degrees Celsius).

- ❖ The battery is almost completely discharged.

Leave the power connected and the battery should begin charging after a few minutes.



HINT: Once the battery is fully charged, we recommend that you periodically operate your computer on battery power until the battery discharges completely.

CAUTION

Please make a complete back up of your data to external media before discharging the battery. For more information, see [“Backing up your work” on page 78](#)

Charging the RTC battery

Your computer has an internal real-time clock (RTC) battery. The RTC battery powers the System Time Clock and BIOS memory used to store your computer’s configuration settings. When fully charged, it maintains this information for up to a month when the computer is powered off.

The RTC battery may have become completely discharged while your computer was shipped, resulting in a CMOS error message during startup. The error message may vary by computer model.

NOTE

Depending on your system, the RTC battery may only charge while the computer is turned on.

To recharge the RTC battery, plug the computer into a live electrical outlet and leave the computer powered on for 24 hours.

NOTE

It is seldom necessary to charge the RTC battery because it charges while the computer is on. If the RTC battery is low, the real-time clock and calendar may display the incorrect time and date or stop working.

When Hibernation mode is enabled and the RTC battery is completely discharged, a warning prompts you to reset the real-time clock.

The computer can be used while the RTC battery is being charged, although the charging status of the RTC battery cannot be monitored.

Monitoring main battery power



The computer's main battery light gives you an indication of the main battery's current charge.

- ❖ Glows amber while the main battery is being charged (AC adaptor connected)
 - ❖ Glows white when the main battery is fully charged
-

NOTE

Battery life and charge time may vary, depending upon power management settings, applications and features used.

- ❖ Flashes amber when the main battery charge is low and it is time to recharge the main battery or plug in the AC adaptor
-

NOTE

If the AC power light flashes amber during charging, either a battery pack is malfunctioning, or it is not receiving correct input from the AC power supply.

Disconnect the AC power cord/cable and remove the battery pack. See "[Changing the main battery](#)" on [page 94](#) for information on replacing the main battery.



HINT: Be careful not to confuse the battery light (☐), the ON/OFF light (⏻), and the power button light near the upper-right corner of the keyboard.

When the ON/OFF light or power button light flashes amber, it indicates that the system is suspended (using the Windows® operating system Sleep command).

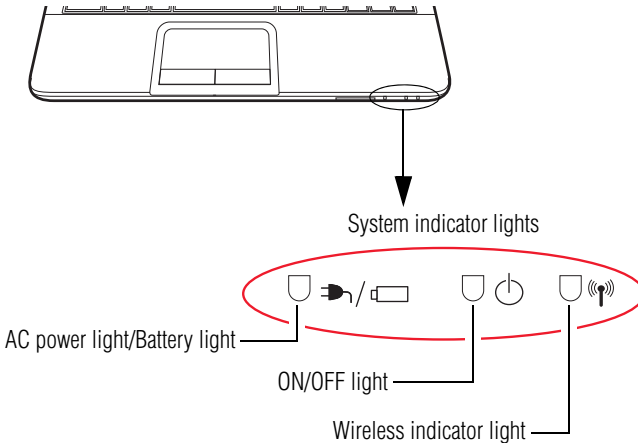

(Sample Illustration) Power and battery light locations

Determining remaining battery power

NOTE

Wait a few moments after turning on the computer before trying to monitor the remaining battery power. The computer needs this time to check the battery's remaining capacity and perform its calculations.



Move the pointer over the power icon in the notification area, see [“Finding your way around the desktop” on page 102](#) for more information on the notification area. A pop-up message displays the remaining battery power as a percentage.

With repeated discharges and recharges, the battery's capacity gradually decreases. A frequently used older battery does not power the computer for as long as a new battery, even when both are fully charged.



TECHNICAL NOTE: The computer drains the battery faster at low temperatures. Check your remaining charge frequently if you are working in temperatures below 50 degrees Fahrenheit.

The computer calculates the remaining battery charge based on your current rate of power use and other factors such as the age of the battery.

What to do when the main battery runs low

When the main battery runs low you can:

- ❖ Plug the computer into an external power source and recharge the main battery
- ❖ Place the computer into Hibernation mode and replace the main battery with a charged spare (not included with your computer)
- ❖ Save your work and turn off the computer

If you do not manage to do any of these things before the main battery completely runs out of power, the computer automatically enters Hibernation mode and turns itself off. Hibernation mode keeps track of where you were, so that when you turn on the power again, you can continue where you left off.

Setting battery notifications

You can set two notifications. Each notification can be set to alert you when a specified percentage of remaining battery power has been reached. You can also set the computer to enter Sleep mode or Hibernation mode or to completely shut down when the notification goes off.

To change the default notification settings:

- 1 While on the desktop, click the battery () icon in the notification area.
- 2 Click **More power options**.
The Power Options window appears.
- 3 Click **Change plan settings** under the power plan to be customized.
The Edit Plan Settings window appears.

4 Click **Change advanced power settings**.

The Advanced settings tab of the Power Options window appears.

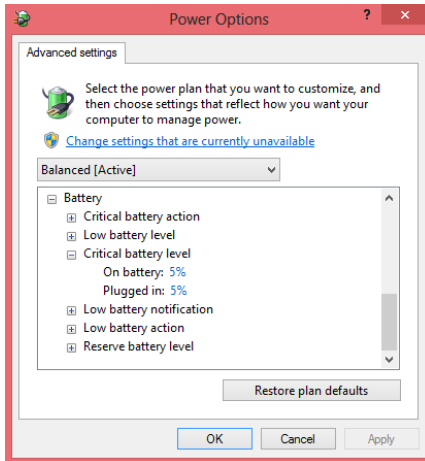
5 Double-click **Battery** to display the battery options.

(Sample Image) Advanced settings tab of Power Options screen

6 Configure the alarm settings to suit your needs.

Conserving battery power

How long a fully charged battery pack lasts when you are using the computer depends on a number of factors, such as:

- ❖ How the computer is configured
- ❖ How much you use the internal storage drive or other optional devices
- ❖ Where you are working, since operating time decreases at low temperatures

There are various ways in which you can conserve power and extend the operating time of your battery:

- ❖ Enable Sleep or Hibernation, which saves power when you turn off the computer and turn it back on again
- ❖ Use the Windows® power-saving option plans

These power-saving options control the way in which the computer is configured. By using them, you can increase the length of time you can use the computer before you need to recharge the battery.

Microsoft® has combined these options into preset Power Plans. Using one of these power plans lets you choose between maximum power savings and peak system performance. You may also set individual power-saving options to suit your own needs.

The following sections describe how to choose a Power Plan and discuss each power-saving option.

Power Plans

You can choose a predefined Power Plan or select your own combination of power options. To do this:

- 1 While on the desktop, click the battery (🔋) icon in the notification area.
- 2 Click **More power options**.

The Windows® Power Options window appears.

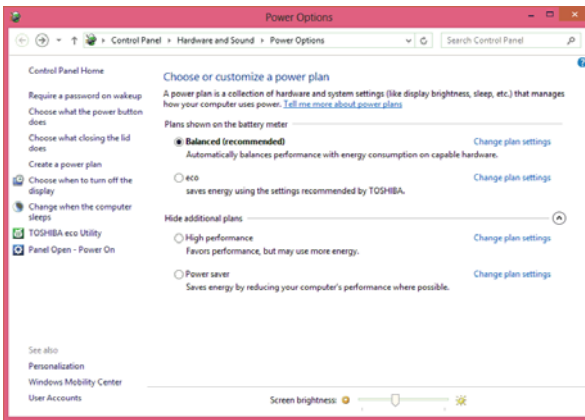

(Sample Image) Windows® Power Options window

- 3 Select an appropriate plan for your work environment or create your own custom plan.
- 4 Click **Create a power plan** in the left pane to set up a new plan.

NOTE To edit a plan or to edit advanced settings, continue to the following steps.

- 5 Click **Change plan settings** to choose the plan you want to edit.
This screen allows you to change basic settings.
- 6 Click **Change advanced power settings** to access settings for battery notification levels, internal storage drive power save time, etc.
You can click the plus signs to expand each item and to see what settings are available for each item.
- 7 Click **OK** to save the plan changes you have performed.

Depending on your model, the power plans available are eco and Balanced or Balanced and Power Saver, and are satisfactory for most people and do not need to be edited. The eco plan is the best used for maximum battery time. The Balanced plan is a compromise between battery time and performance.

Using the eco power plan

This computer may be equipped with the eco power plan. Operating the computer with this power plan enabled reduces electrical power consumption by slightly lowering system performance. For example, when this power plan is enabled, the brightness of the display is reduced and the interval before Sleep mode takes effect is shortened. To enable or disable the eco power plan, see [“Power Plans” on page 92](#).

The eco Utility[®] monitors your power savings from using the eco power plan by tracking real-time power consumption and accumulated savings over time. To learn how to access the utility, see [“eco Utility[®]” on page 115](#).

For more information on the eco power plan, see the Help file in the eco Utility[®] window.

Changing the main battery

When your main battery has run out of power, you have two options: plug in the AC adaptor or install a charged main battery.

⚠ WARNING

Never short circuit the battery pack by either accidentally or intentionally bringing the battery terminals in contact with another conductive object. This could cause serious injury or fire, and could also damage the battery pack and computer.

- ❖ Never expose a battery pack to abnormal shock, vibration or pressure. The battery pack's internal protective device could fail, causing it to overheat or ignite, resulting in caustic liquid leakage, or explosion or fire, possibly resulting in death or serious injury.



TECHNICAL NOTE: To avoid losing any data, save your files and then either completely shut down your computer or put it into Hibernation mode before changing the main battery.

Removing the battery from the computer

To remove the battery:

- 1 Save your work.
- 2 Turn off the computer, see [“To Shut down your computer” on page 43](#).
- 3 Unplug and remove any cables connected to the computer, including the AC adaptor.
- 4 Close the display panel and turn the computer upside down.
- 5 Slide the battery release lock to the unlocked position.

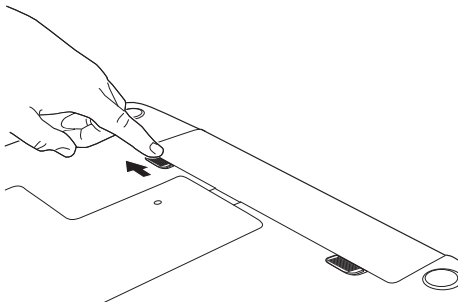

(Sample Illustration) Unlocking the battery release lock

- 6 Slide the battery release latch to release the battery.
- 7 Pull the discharged battery out of the computer.

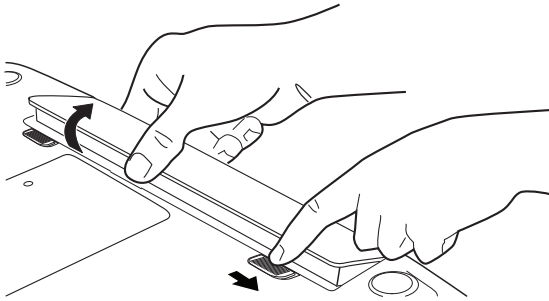

(Sample Illustration) Removing the battery

⚠ WARNING

If the battery is leaking or its case is cracked, put on protective gloves to handle it, and discard it immediately. Always dispose of used battery packs in compliance with all applicable laws and regulations. Put insulating tape, such as cellophane tape, on the electrode during transportation to avoid a possible short circuit, fire or electric shock. Failure to do so could possibly result in serious injury.

Inserting a charged battery

To insert a battery:

- 1 Wipe the terminals of the charged battery with a clean cloth to ensure a good connection.
- 2 Insert the charged battery into the slot until the latch clicks.

The battery pack has been designed so that you cannot install it with reverse polarity.

CAUTION

If the battery does not slide into the slot easily, move the battery release lock to the unlocked position and try again. Do not force the battery into position.

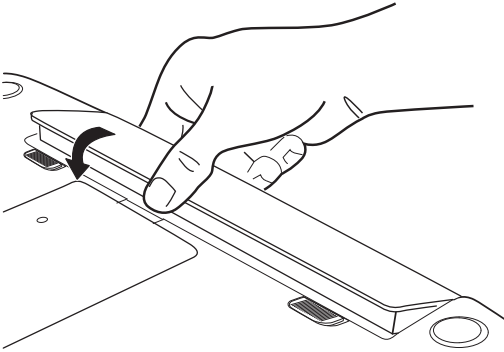

(Sample Illustration) Inserting the battery

- 3 Slide the battery release lock to the locked position.

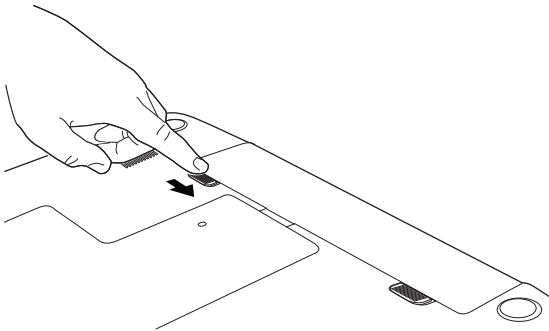

(Sample Illustration) Locking the battery release lock

- 4 Turn the computer right side up.
- 5 Reconnect any cables that were removed in step 3 of [“Removing the battery from the computer”](#) on page 94.
- 6 Restart the computer.

Taking care of your battery

The following sections offer tips on how to take care of your battery and prolong its life.

Safety precautions

- ❖ If the battery pack produces an odor, overheats or changes color or shape while it is being used or charged, turn off the computer's power immediately and disconnect the power cord/cable from the power socket. Carefully remove the battery pack from the computer.
- ❖ Do not try to disassemble a battery pack.
- ❖ Do not overcharge or reverse charge a battery. Overcharging will shorten its life, and reverse charging could damage it.
- ❖ Avoid touching the metal terminals of the battery with another metal object. Short-circuiting the battery can cause it to overheat and may cause damage to the battery or the computer.
- ❖ Do not incinerate a spent battery, as this could cause it to explode and release caustic liquid.
- ❖ If a battery is leaking or damaged, replace it immediately. Use protective gloves when handling a damaged battery.
- ❖ To replace the main battery, use an identical battery that you can purchase through the Toshiba Web site at accessories.toshiba.com.
- ❖ A reverse polarity condition should be avoided with all batteries. The main battery is designed so that it cannot be installed in reverse polarity.
- ❖ Charge the battery only in the computer or in a battery charger designated as an approved option.
- ❖ When you install the battery pack, you should hear a click when it is seated properly.
- ❖ Do not expose the battery pack to fire. The battery pack could explode.

Maintaining your battery

Fully discharging your battery pack will allow better accuracy of the battery meter.

To fully discharge your battery pack:

- ❖ Periodically, disconnect the computer from a power source and operate it on battery power until the battery pack fully discharges.
- ❖ If you have extra battery packs, rotate their use.
- ❖ If you will not be using the system for an extended period, more than one month, remove the battery pack.
- ❖ Store spare battery packs in a cool dry place out of direct sunlight.

Disposing of used batteries

The life of a battery pack depends on usage. When the battery pack needs replacing, the main battery light flashes amber shortly after you have fully recharged the battery.

You must discard a battery if it becomes damaged.

▲ WARNING

Never attempt to dispose of a battery pack by burning or by throwing it into a fire, and never allow exposure to a heating apparatus (e.g., microwave oven). Heat can cause a battery pack to explode and/or release caustic liquid, both which may possibly cause serious injury.

Always dispose of used battery packs in compliance with all applicable laws and regulations. Put insulating tape, such as cellophane tape, on the electrode during transportation to avoid a possible short circuit, fire or electric shock. Failure to do so could possibly result in serious injury.

▲ WARNING

Always use the battery pack supplied as an accessory or an equivalent battery pack specified in the User's Manual. Other battery packs have different voltage and terminal polarities. Use of non-conforming battery packs could generate smoke or cause fire or rupture, possibly resulting in serious injury.

After repeated use, the batteries will finally lose their ability to hold a charge and you will need to replace them. Under certain applicable laws and regulations, it may be illegal to dispose of old batteries by placing them in the trash.

Please be kind to our shared environment. Check with your local government authority for details regarding where to recycle old batteries or how to dispose of them properly.

In addition, Toshiba's recycling initiatives include recycling programs, events and consumer promotions. For details, please visit us.toshiba.com/green.

Toshiba is dedicated to preserving the environment by sponsoring **Call2Recycle**[™], a program of the Rechargeable Battery Recycling Corporation. For more information and for drop-off locations, visit www.rbrc.org or call 1-800-822-8837.

Notice regarding CR coin cell batteries, applicable to California, U.S.A. only:

Perchlorate Material - special handling may apply.
See <http://www.dtsc.ca.gov/hazardouswaste/perchlorate/>

Traveling tips

The environmental precautions listed in “[Selecting a place to work](#)” on page 30, also apply while traveling.

- ❖ Never leave your computer on a sunny ledge or in a place where it could get wet or covered in dust.
- ❖ Always travel with the computer in a carrying case. Toshiba offers a choice of carrying cases for the computer. They all provide plenty of extra space for manuals, power cords, and compact discs. Contact your authorized Toshiba representative for more information or visit Toshiba's Web site at accessories.toshiba.com.



TECHNICAL NOTE: When traveling by air, you may be required to pass your computer through airport security equipment. The X-ray equipment will not harm your computer.

NOTE

Before using your computer aboard an aircraft, make sure the Wireless antenna is OFF (Airplane mode is ON) if your computer has wireless LAN capability.

NOTE

To enable or disable wireless communication, use the F12 key. For more information see “[TOSHIBA Function Keys](#)” on page 156.

Chapter 4

Exploring Your Computer's Features

In this chapter, you will explore some of the special features of your computer.

Exploring the Start screen

The Start screen is the launching pad for everything you can do in the Windows® operating system, providing new and easy ways to access everything from your favorite apps and Web sites to your contacts and other important information.

When you move your pointer over the upper or lower right corner of your screen, a list of Charms will slide out from the right. These Charms perform various commands, including basics tasks like turning off the power and advanced PC settings.

You can go to the Start screen by clicking the **Start** charm, see [“Charms” on page 101](#). You can also use the Windows® key (⊞) on your keyboard or on the LCD screen to go to Start screen. For detailed information, please refer to the Windows Help and Support.

By clicking on the **Desktop** tile from the Start screen, you will find the Windows® settings and features you are most familiar with.

For detailed information on the new Windows 8 functionality, refer to the Windows® Help and Support.



App tiles

(Sample Image) Windows® Start screen

Charms

Use the Windows® Charms to start apps, find documents, set up system components, and perform most other computing tasks.

By swiping in from the right edge (only for touch screen models) or pointing the mouse pointer to the upper or lower right corner of your screen, you will find a list of charms: **Search**, **Share**, **Start**, **Devices**, and **Settings**.



Search Charm—This Charm allows you to search for most anything you need to locate on your computer. It can help you find apps, documents, photos, and your favorite music.



Share Charm—This Charm allows you to share music and photos with your favorite social Web sites.



Start Charm—This Charm allows you to view all of the available apps downloaded to your system.



Devices Charm—This Charm allows you to manage your hardware devices.



Settings Charm—This Charm allows you to manage your system settings.

Tiles

Tiles can be accessed and launched from the Start screen.

Typical Start screen tiles are the Desktop tile and Mail tile, as well as tiles representing all other applications downloaded to your system.

Exploring the desktop

You can use its features to start applications, find documents, set up system components, and perform most other computing tasks.



HINT: The illustrated examples in this guide may appear slightly different from the screens displayed by your system. The differences are not significant and do not indicate any change in the functionality of your system.

Finding your way around the desktop

Your computer's desktop includes several standard features: icons, taskbar, notification area, notifications, and background pattern.



(Sample Image) Windows® Desktop screen

Icons

An icon represents a folder, file, or application that can be quickly activated by double-clicking the icon.

You can create a new desktop icon for any folder, file, or application by dragging the element's icon from its location in a window to the desktop area.

You may see various icons displayed on your system desktop, for example:



Recycle Bin—Holds files you have deleted. You may be able to retrieve these files until you empty the Recycle Bin.



- ❖ **TECHNICAL NOTE:** If you delete a large number of files or very large files from the internal storage drive, there may be insufficient space available in the Recycle Bin to hold these files. In this case, Windows® will prompt you to either permanently delete the file(s) or cancel the deletion.
- ❖ If you delete a file (of any size) from an external media or flash media, it does not go into the Recycle Bin. The file is permanently deleted.
- ❖ Permanently deleted files cannot be recovered from the Recycle Bin.
For more information on the Recycle Bin, see Windows® online Help.

NOTE

If you place the pointer over an icon, a popup description of the file contents appears.

Your desktop may contain other icons depending on your configuration. Refer to the Windows® online Help for more specific information on each icon and how to use it, or see [“Help file” on page 157](#).

Taskbar

Each time you open an application, a button associated with that application appears on the taskbar. With some applications, a button appears on the taskbar for each document or window you open. You can use these buttons to quickly switch between the applications or windows.

To make an application or window the currently active one, click the associated taskbar button.

Notification area

The notification area displays icons of tasks or applications that run continuously in the background and displays notifications. To learn more about each task, position the pointer over the icon for a few moments and a short description of the task appears.

Typical tasks in the notification area are Current time, Power usage mode, network connectivity status, and speaker volume.

To activate a specific task, click the appropriate notification area icon.

Notifications

There are many types of notifications you can employ to help you with the many tasks you perform every day.

User experience notifications can be set for toast, tile, badge, and raw notifications.

Toast notifications—Designed for time-sensitive delivery of personalized content, such as an instant message from a friend.

Tile notifications—Used by applications that are not currently running with an at-a-glance characteristic, giving you a quick preview of the subject line of your latest email or the current weather conditions.

Badge notifications—A specialized type of tile notification (shown on the Start screen tile) using glyphs to indicate the number of applications that have updates available or the status of a running application.

Raw notifications—These run a background task on behalf of an application while that application is not running in order to make available the latest content, such as an online newspaper.

Windows® Store

Although many applications will be pre-installed or built-in to your computer, you will also have the ability to download many other applications with the click of your mouse.

In the Windows® Store you can search for and browse thousands of apps, all grouped into easy to find categories.

Setting up for communications

To connect to the Internet you need:

- ❖ A browser or communications application
- ❖ An Internet Service Provider (ISP) or online service if you plan to use the Internet
- ❖ A way to connect to the ISP (for example Wi-Fi®/ LAN/broadband connection, etc.)

Using Wireless LAN connectivity

NOTE Wireless connectivity and some features may require you to purchase additional software, external hardware or services. Availability of public wireless LAN access points may be limited.

Your system comes with a wireless LAN module. This is a technology that expands wireless communication beyond networking equipment, and can connect many different kinds of electronic devices without the need for cables.

For information on how to set up a wireless connection, refer to your wireless networking device documentation or your network administrator.

NOTE To enable or disable wireless communication, use the F12 key. For more information see [“TOSHIBA Function Keys” on page 156](#).

NOTE When Airplane mode is OFF, the wireless indicator light  will be lit.

For help with common Wi-Fi® networking problems, see [“Wireless networking problems” on page 145](#).

Connecting your computer to a network

You can connect your computer to a network to increase its capabilities and functionality using one of its communication ports.

Accessing a network

To access a network, connect an Ethernet cable to the Network port (RJ45) on your computer. For specific information about connecting to the network, consult your network administrator. Many hotels, airports, and offices offer Wi-Fi® access.

Exploring audio features

You can use your computer to record sounds using the computer's internal microphone (available on certain models) or an optional external microphone. You can listen to sound files or audio CDs using the built-in speakers, headphones, or external speakers.

Recording sounds

You may record sounds using the computer's internal microphone (available on certain models) or by connecting an optional external microphone.

Using a microphone



- 1 If you want to use an external microphone, connect it to the computer.
- 2 From the Start screen begin typing **Sound Recorder** and click your selection, or if you are in the Desktop, move your pointer over the upper or lower right corner of the screen. When the Windows® Charms appear click the **Search** (🔍) Charm and, in the Search field, type **Sound Recorder**.

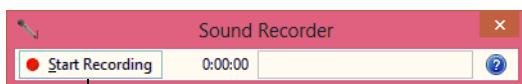

Start Recording/Stop Recording button

(Sample Image) Sound Recorder screen

- 3 Click the **Start Recording** button.
- 4 Speak normally into the microphone.
- 5 When you have finished recording, click the **Stop Recording** button.

The **Save As** dialog box appears.

- 6 To save the file, type a file name, and then click **Save**.

Using external speakers or headphones

Your computer is equipped with a full stereo sound system with internal speakers. Instead of using the internal speakers, you can connect headphones or a pair of external stereo speakers.

CAUTION

Before putting on headphones to listen, turn the volume down. Do not set the volume too high when using headphones. Continuous exposure to loud sound can harm your hearing.



TECHNICAL NOTE: When using amplified speakers, use speakers that require an external power source. Other types of speakers will be inadequate to produce sound from the computer.



To play back sound files through external speakers or headphones:

- 1** Locate the headphone jack on the computer.
- 2** Using any necessary adapters, plug the cable from the headphones or external speakers into the headphone jack.

The headphone jack requires a 16-ohm stereo mini connector.

To adjust the volume:

- ❖ For external speakers, use the volume controls on each speaker.
- ❖ For headphones, use the computer's volume control.



Using the Web Camera

(Available on certain models.)

Your computer may come with a built-in Web Camera. With this Web Camera you can do the following:

- ❖ Take pictures and record videos with your computer
- ❖ Chat with others and have them see you while using instant messaging (IM) applications
- ❖ Have video conference calls

NOTE

To email, instant message or video conference, you must be connected to the Internet.

Depending on your computer model, the process of sending email, taking pictures or recording video messages may vary.

To access the Web Camera, on the Start screen click the **Camera** tile. The Web Camera indicator light glows when the Web Camera is active.

Using the Memory card reader

(Available on certain models.)

The Memory card reader supports the use of Secure Digital™ (SD™), Mini SD™, Micro SD™, SDHC, SDXC, or MultiMediaCard® (MMC®) media. These media can be used with a variety of digital products: digital music players, cellular phones, PDAs, digital cameras, digital video camcorders, etc.

CAUTION To use a micro or mini SD™ Card, an SD™ adapter is required.

The Memory card reader may also support other types of media.

NOTE Do not use the Copy Disk function for this type of media. To copy data from one media to another, use the drag-and-drop feature of the Windows® operating system.

Inserting memory media

NOTE To locate your Memory card reader please refer to your Quick Start document.

The following instructions apply to all types of supported media devices.

- 1 Turn the media so that the contacts (metal areas) are face down.
- 2 Push the media into the adapter until it locks in place.

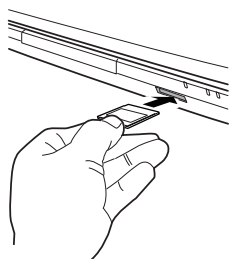

(Sample Illustration) Inserting memory media

CAUTION

When inserting memory media, do not touch the metal contacts. You could expose the storage area to static electricity, which can destroy data.

Removing memory media



- 1 If you are not currently on the Desktop, choose the Desktop tile on the Start screen, otherwise skip to step 2.
- 2 Prepare the card for removal by clicking on the **Show hidden icons** button (▲), if necessary, in the notification area and then selecting the **Safely Remove Hardware and Eject Media** icon.
- 3 Highlight, and then click the item you would like to eject.
If the system is unable to prepare the media for safe removal, a message will tell you to try again later. If the media can be removed now, the system displays **Safe to Remove Hardware**. If the computer has a spring-loaded adapter slot, see step 4; otherwise, skip to step 5.
- 4 Gently press the card inward to release it.
The card pops out slightly.
- 5 Grasp the card and pull it straight out.

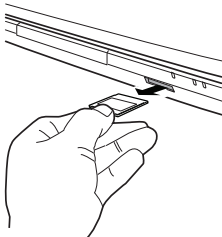

(Sample Illustration) Removing memory media

CAUTION

Do not remove memory media while data is being written or read. Even when the Windows® message “copying...” disappears, writing to the media might still be in progress and your data could be destroyed.

Chapter 5

Utilities

Your computer includes several utilities designed to help you to reconfigure your system to best meet your individual needs. Together, these allow you to ascertain certain system details, set additional options, or change default options. These utilities are described in this chapter.

NOTE The utilities described in this chapter, and the icons shown in the sample images are applicable only if the related utility is available on your system.

- ❖ Desktop Assist
- ❖ eco Utility®
- ❖ Supervisor password
- ❖ User password
- ❖ System Settings
- ❖ Sleep and Charge
- ❖ Function Key
- ❖ PC Diagnostic Tool Utility
- ❖ PC Health Monitor
- ❖ Recovery Media Creator

- ❖ Service Station
- ❖ TOSHIBA Application Installer

Desktop Assist

The Desktop Assist provides quick access to computer functions and allows you to customize a range of computer settings.

To access Desktop Assist from the Start screen begin typing **Desktop Assist**, or while in the Desktop screen double-click the **Desktop Assist** icon.



The Desktop Assist window appears.

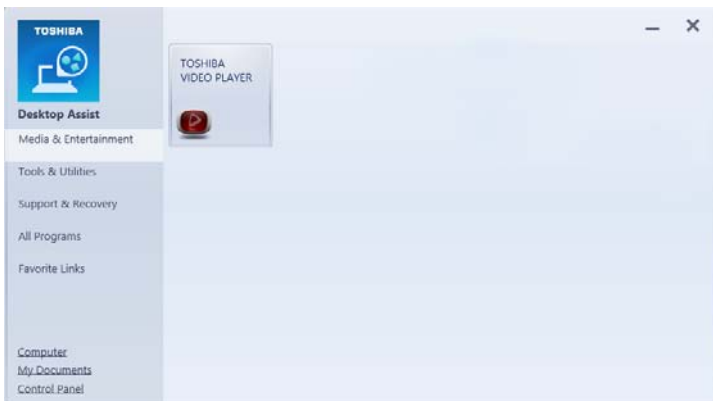

(Sample Image) Desktop Assist window

The Desktop Assist offers several options:

- ❖ Media & Entertainment
- ❖ Tools & Utilities
- ❖ Support & Recovery

Media & Entertainment

The feature available in this category is TOSHIBA Video Player.

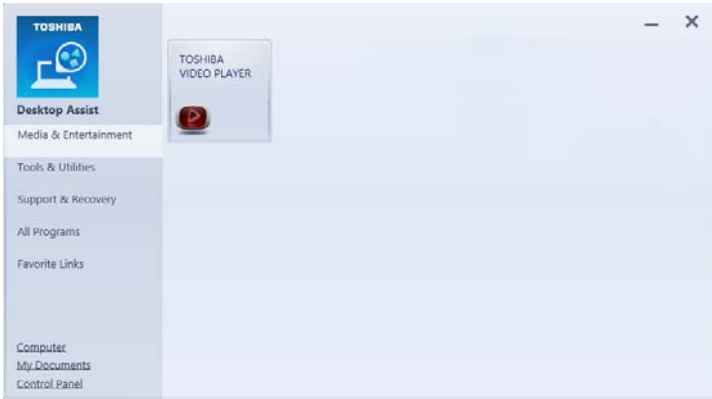

(Sample Image) Desktop Assist window – Media & Entertainment tab

Tools & Utilities

The features that may be available in this category are:

- ❖ eco Utility®
- ❖ Supervisor password
- ❖ System Settings
- ❖ Function Key
- ❖ User password



(Sample Image) Desktop Assist window – Tools & Utilities tab

Support & Recovery

The features that may be available in this category are:

- ❖ PC Diagnostic Tool Utility
- ❖ PC Health Monitor
- ❖ Recovery Media Creator
- ❖ Service Station
- ❖ TOSHIBA Application Installer
- ❖ User's Guide



(Sample Image) Desktop Assist window – Support & Recovery tab

eco Utility®

The eco Utility® monitors your power savings from using the eco power plan by tracking real-time power consumption and accumulated savings over time.

To access the eco Utility®, do one of the following:

- 1 To access eco Utility® from the Start screen begin typing **eco Utility**, or while in the Desktop screen double-click the **Desktop Assist** icon.
- 2 Click **Tools & Utilities**.
- 3 Click **eco Utility**.



The eco Utility® window appears.

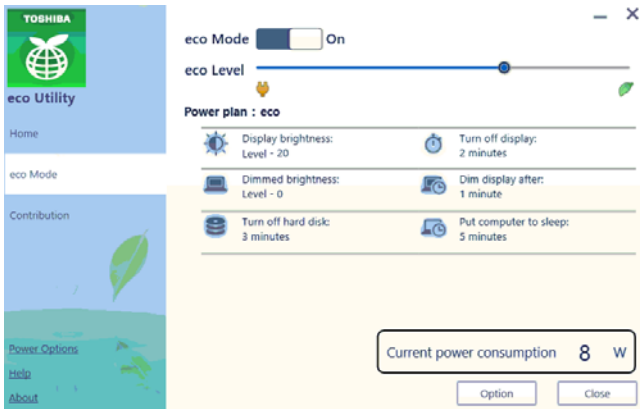

(Sample Image) eco Utility® window

- 4 To activate the eco power plan, select **eco Mode** on the left side.
- 5 Click the **eco Mode** button.
- 6 Click **Close**.

For more information on the eco power plan and utility, click the **Help** button at the bottom of the window.

Setting passwords

Setting a password lets you walk away from your computer while providing additional protection for your files. When you set a password, you must enter the password before you can work on your computer again.

TOSHIBA supports different types of passwords on your computer:

- ❖ A supervisor password—Prohibits unauthorized users from accessing certain functions such as System Settings. This is useful if more than one person uses the computer.
- ❖ A user password—Prevents unauthorized users from starting the computer.

When setting up passwords, keep the following in mind:

- ❖ The supervisor password must be set before the user password, or the user password must be deleted and then re-entered after the supervisor password is set.
- ❖ The user password can be set up under the supervisor password.

Using a supervisor password

A supervisor password prevents other users from changing hardware configuration options.

Setting a supervisor password

CAUTION

If you choose to set a supervisor or user password, TOSHIBA strongly recommends that you save your password in a location where you can later access it should you not remember it.

TOSHIBA is not responsible for any losses that may occur to you, your organization or others as a result of the inability to access your computer.

To set a supervisor password:

- 1 To access Supervisor Password from the Start screen begin typing **Supervisor Password**, or while in the Desktop screen double-click the **Desktop Assist** icon.
- 2 Click **Tools & Utilities**.
- 3 Click **Supervisor Password**.



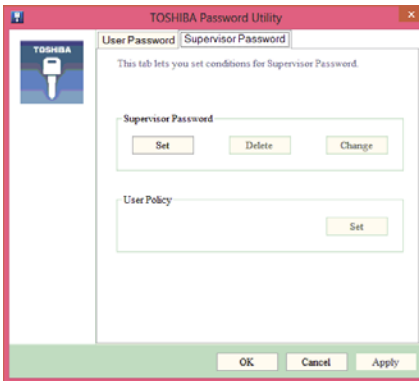

(Sample Image) Supervisor Password tab

- 4 Click **Set**.
- 5 Enter your password, and then enter it again to verify.
- 6 Click **Set**.

NOTE Under User Policy, this option may or may not ask for password verification.

- 7 Click **OK** to save your password as a text file.
- 8 Click **Save**.
- 9 Click **OK**

Deleting a supervisor password

To delete a supervisor password:

- 1 To access Supervisor Password from the Start screen begin typing **Supervisor Password**, or while in the Desktop screen double-click the **Desktop Assist** icon.
- 2 Click **Tools & Utilities**.
- 3 Click the **Supervisor Password** icon.
A pop-up screen appears asking for a password.
- 4 Enter your password.
- 5 Click **Delete**.
An authority verification pop-up screen appears.
- 6 Click **Delete**.
- 7 Enter the password, and then click **Verify**.
- 8 Click **OK** to exit.



Using a user password

A user password provides power-on password protection.

Setting a user password

CAUTION

If you choose to set a supervisor or user password, TOSHIBA strongly recommends that you save your password in a location where you can later access it should you not remember it.

TOSHIBA is not responsible for any losses that may occur to you, your organization or others as a result of the inability to access your computer.

To register a password for the power-on password functions:

- 1 To access User Password from the Start screen begin typing **User Password**, or while in the Desktop screen double-click the **Desktop Assist** icon.
- 2 Click **Tools & Utilities**.
- 3 Click the **User Password** icon.
- 4 Click **Set**.
- 5 Enter your password, and then enter it again to verify.
- 6 Click **Set**.
- 7 Click **OK** to save your password as a text file.
- 8 Click **Save**.
- 9 Click **OK**.



Deleting a user password

To cancel the power-on password function:

- 1 To access User Password from the Start screen begin typing **User Password**, or while in the Desktop screen double-click the **Desktop Assist** icon.
- 2 Click **Tools & Utilities**.
- 3 Click the **User Password** icon.
A pop-up screen appears asking for a password.
- 4 Enter your password
- 5 Click **Delete**.
An authority verification pop-up screen appears.
- 6 Click **Delete**.
- 7 Enter the password, and then click **Verify**.
- 8 Click **OK** to exit.



System Settings

System Settings is the TOSHIBA configuration management tool available through the Windows® operating system. To access it:

- 1 To access System Settings from the Start screen begin typing **System Settings**, or while in the Desktop screen double-click the **Desktop Assist** icon.
- 2 Click **Tools & Utilities**.
- 3 Click **System Settings**.

The System Settings screen appears.

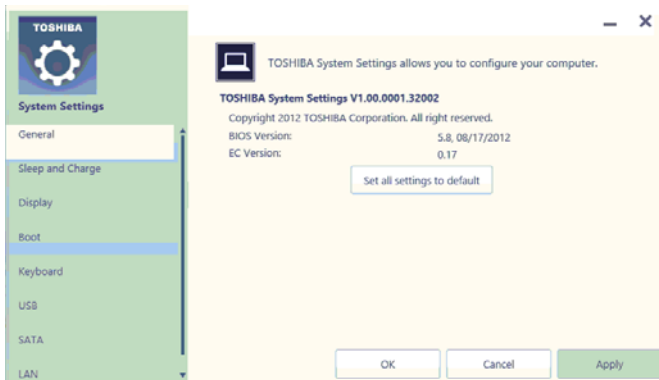

(Sample Image) System Settings screen – General tab options

The System Settings screen may have the following tabs:

- ❖ **Boot**—Allows you to change the sequence in which your computer searches the drives for the operating system
 - ❖ **Boot Speed**—Reduces the time needed for the BIOS to initialize, using either the **Fast** or **Normal** settings.
 - ❖ **Panel open/Power on**—Allows you to turn on the computer when opening the display panel while the computer is turned off.
- ❖ **Display**—Allows you to select the internal LCD and /or external monitor when the computer boots up

NOTE

When the computer restarts, it remembers the last configuration. If data does not appear on the display you are using after starting in Sleep mode, press the (Fn) + P keys to toggle the display. For more information, see [“Directing the display output when you turn on the computer”](#) on page 69.

- ❖ **General**—Allows you to view the current BIOS version or change certain settings back to their default values
- ❖ **Keyboard**—Allows you to access the wake-on keyboard function, or to configure the function keys
- ❖ **LAN**—Allows you to set networking functions
- ❖ **SATA**—Allows you to set conditions for SATA
- ❖ **Sleep and Charge**—See **“Sleep and Charge” on page 120**
- ❖ **USB**—Allows you to enable or disable USB Legacy Emulation/USB 3.0

Sleep and Charge

This utility displays whether the “USB Sleep and Charge function” is enabled or disabled and shows the position of the USB port that supports the “USB Sleep and Charge function.”



- 1 While in the Desktop screen double-click the **Desktop Assist** icon.
- 2 Click **Tools & Utilities**.
- 3 Click **System Settings**.
- 4 Click **Sleep and Charge**.

USB Sleep and Charge

Your computer can supply USB bus power (DC 5V) to the USB port even when the computer is in Sleep mode, Hibernation mode or shutdown state (powered off).

This function can only be used for the port that supports the USB Sleep and Charge function (hereinafter called “compatible port”).

Compatible ports are USB ports that have the (⚡) symbol icon.

You can use the “USB Sleep and Charge function” to charge certain USB compatible external devices such as mobile phones or portable digital music players. However, the “USB Sleep and Charge function” may not work with certain external devices even if they are compliant with the USB specification. In those cases, power on the computer to charge the device.

NOTE

- ❖ When “USB Sleep and Charge function” is set to Enabled, USB bus power (DC 5V) will be supplied to the compatible port even when the power of the computer is turned OFF. USB bus power (DC 5V) is similarly supplied to the external devices which are connected to the compatible ports. However, some external devices cannot be charged solely by supplying USB bus power (DC 5V).
As for the specifications of the external devices, please contact the device manufacturer or check the specifications of the external devices thoroughly before use.
- ❖ If USB Sleep and Charge is enabled, the computer’s battery will discharge during hibernation or when the computer is turned off. It is recommended that you connect the AC adaptor to the computer when enabling the USB Sleep and Charge function.
- ❖ Using the “USB Sleep and Charge function” to charge external devices will take longer than charging the devices with their own chargers.
- ❖ If an external device is connected to the compatible port when the AC adaptor is not connected to the computer, the battery of the computer will be depleted even when the power of the computer is turned OFF. As such, we recommend that you connect the AC adaptor to the computer when using the “USB Sleep and Charge function.”
- ❖ External devices connected to the USB bus power (DC 5V) function that interfaces with the power ON/OFF of the computer may always be in an operational state.
- ❖ When there is a current overflow of the external device connected to the compatible port, USB bus power (DC 5V) supply may be stopped for safety reasons.
- ❖ When “USB Sleep and Charge function” is set to Enabled, the “USB Wakeup function” does not work for compatible port. In that case, if there is a USB port that does not have the USB Sleep and Charge function-compatible icon (⚡), attach the mouse or keyboard to it.
The “USB Wakeup function” will now work, but the “USB Sleep and Charge function” will be disabled.

▲ WARNING

Metal paper clips or hair pins/clips will generate heat if they come into contact with USB ports. Do not allow USB ports to come into contact with metal products, for example when carrying the computer in your bag.

Enabling/Disabling USB Sleep and Charge

This utility can be used to enable or disable the USB Sleep and Charge function. To enable this function, select **Enable**. To disable this function, toggle the Enable button to the **Disabled** position.

You can also control whether charging takes place when the computer is running on battery power. To do so, select or de-select the **Enable under Battery Mode** check box in the utility.

If you enable charging when the computer is running on battery power, you can specify that charging stops when battery power drops below a certain level. Use the slider at the bottom of the utility window (beneath the “Lower limit of remaining battery life” heading) to specify when charging should stop. For example, if you set the slider to 10%, charging will stop when 10% or less of the battery power remains.

Power supply mode settings

Your computer may provide two different charging modes, to support various types of USB devices. If your computer provides more than one charging mode, the charging mode you should select depends on the USB device you want to charge. For example, **Auto Mode**, which is the default mode, will charge a wide variety of digital audio players. If your device does not charge in Auto Mode, try using **Alternate Mode**. To select a different charging mode, use the **Power supply mode** drop-down list in the utility.

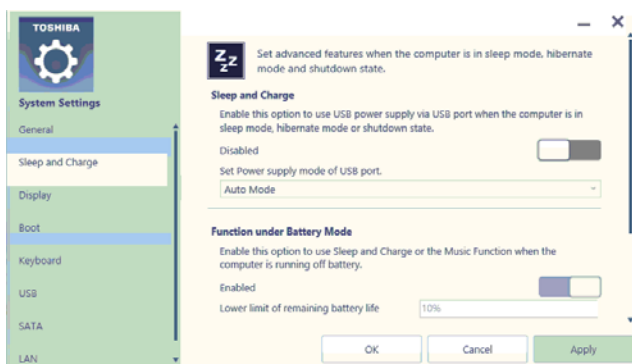

(Sample Image) Sleep and Charge screen

NOTE

With certain external devices, the USB Sleep and Charge function may not work no matter which charging mode you select. In those cases, disable USB Sleep and Charge in the utility and turn the computer on to charge the device, or use a different charging device.

Function Key

Turns notifications for touch pad status ON/OFF.



(Sample Image) Function Key

NOTE The Function option is disabled by default.

PC Diagnostic Tool Utility

This utility can help diagnose problems with devices in your computer. Refer to the online Help documentation within the application for additional help.

NOTE The PC Diagnostic Tool utility may show tests for features you do not have. This is normal and does not indicate a problem.

To use the PC Diagnostic Tool utility:

- 1 To access PC Diagnostic Tool utility from the Start screen begin typing **PC Diagnostic Tool**, or while in the Desktop screen double-click the **Desktop Assist** icon.
- 2 Click **Support & Recovery**.
- 3 Click **PC Diagnostic Tool**.
The PC Diagnostic Tool window appears.
- 4 Click the **Diagnostic Tool** tab.

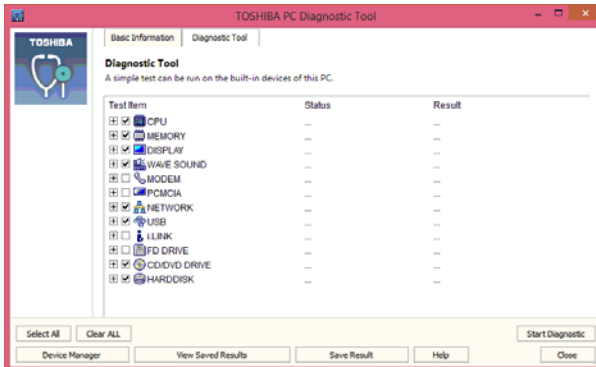

(Sample Image) PC Diagnostic Tool window

- 5 Select the device(s) that you would like to test by clicking the check box that appears to the left of the device.

NOTE Click the + (plus) and - (minus) symbols to expand and collapse the categories.

- 6 Click **Start Diagnostics** when you are ready to begin the tests.



PC Health Monitor

(Available on certain models.)

The PC Health Monitor software program monitors computer system functions such as power consumption, the cooling system and the 3D Accelerometer (available on certain models). It alerts users to specific system conditions via pop-up messages. It also tracks the usage of the computer and related devices and logs service-relevant information on the computer's internal storage drive.

The collected information includes device operation time and number of actuations or status changes (e.g.: number of power button and Fn key combination uses, and AC adaptor, battery, LCD, fan, HDD, sound volume, wireless communication switch, docking and USB information), date of initial system use, and also computer and device usage (e.g.: power settings, battery temperature and recharging, CPU, memory, and temperatures for various devices). The collected information is not limited to the examples specified here. The stored data uses a very small portion of the total hard disk capacity (approximately 3 MB or less per year).

This information is used to identify and provide a notification of system conditions that may affect the performance of your TOSHIBA computer. It may also be used to help diagnose problems should the computer require service by TOSHIBA or TOSHIBA's authorized service providers. Additionally, TOSHIBA may use this information for quality assurance analysis.

Subject to the use restrictions above, the data logged on the internal storage drive may be transferred to entities located outside of your country or region of residence (e.g., European Union). Those countries may or may not have the same data protection laws or data protection levels as required by your home country or region.

You may disable the PC Health Monitor at any time by uninstalling the software via the Windows® Control Panel. Doing so will automatically delete all collected information from the internal storage drive.

The PC Health Monitor software does not extend or modify TOSHIBA's obligations under its standard limited warranty in any way. TOSHIBA's standard limited warranty terms and limitations apply.

Recovery Media Creator

The Recovery Media Creator utility enables you to create recovery media that can be used to return your system to its out-of-box state, if necessary. For detailed information on using the utility to create recovery media, see [“Creating recovery media” on page 55](#).

Service Station

The Service Station helps you keep your new computer running at its best by notifying you when updated software, firmware, documentation or other information is available for your computer. The Service Station will alert you when updates are available, and you can then choose to install the updates if you wish.

TOSHIBA Application Installer

The TOSHIBA Application Installer allows you to reinstall the drivers and applications that were originally bundled with your computer.

To reinstall drivers and applications:

- 1 To access TOSHIBA Application Installer from the Start screen begin typing **Application Installer**, or while in the Desktop screen double-click the **Desktop Assist** icon.
- 2 Click **Support & Recovery**.
- 3 Click **TOSHIBA Application Installer**.

The TOSHIBA Application Installer window appears.

- 4 Click **Next**.



(Sample Image) TOSHIBA Application Installer screen

- 5 Click the item you want to install.

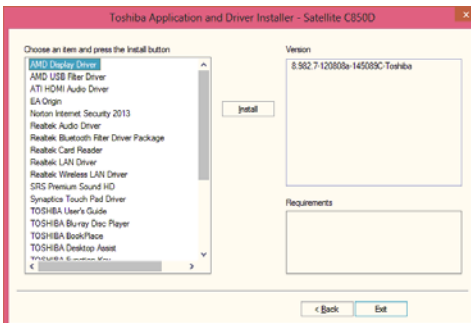

(Sample Image) TOSHIBA Application Installer selection screen

- 6 Click **Install**, then follow the on-screen prompts to complete the installation process.

Chapter 6

If Something Goes Wrong

Some problems you may encounter when using your computer are relatively easy to identify and solve. Others may require help from your network administrator or the manufacturer of the software application.

This chapter aims to help you solve many problems by yourself. It covers the problems you are most likely to encounter.

If all else fails, contact Toshiba. You will find information on Toshiba's support services at the end of this chapter.

Problems that are easy to fix

Your application stops responding.

If you are working with an application that suddenly freezes all operations, chances are the application has stopped responding. You can exit the failed application without shutting down the operating system or closing other applications.

To close an application that has stopped responding:

- 1** Press Ctrl, Alt, and Del simultaneously (once).
The Windows® Security Menu appears.
- 2** Click the **Task Manager** tab.

If an application has stopped responding, the words “not responding” appear beside its name in the list.

- 3 Select the application you want to close, then click **End Task**.
Closing the failed application should allow you to continue working. If it does not, continue with the next step.
- 4 Close the remaining applications one by one by selecting the application name, then **End Task**.
Closing all applications should allow you to continue working. If it does not, power off your computer and then restart it.

Problems when you turn on the computer

These problems may occur when you turn on the power.

The computer will not start.

Make sure you attached the AC adaptor and power cord/cable properly or install a charged battery.

Press and hold the power button for at least 10 seconds.

If you are using the AC adaptor, check that the wall outlet is working by plugging in another device, such as a lamp.

Verify that the computer is on by looking at the ON/OFF indicator. If the indicator is glowing, the computer is on. Also, try turning the computer off and then on.

If you are using an AC adaptor, verify that the computer is receiving power from the external power source by looking at the AC power light. If the indicator is glowing, the computer is connected to a live external power source.

The computer starts but when you press a key nothing happens.

Verify that the active application accepts text input. Try clicking your mouse on an area where you can type text and try typing again.

Your computer may be in Sleep mode and have a software or resource conflict. When this happens turning the power on returns you to the problem instead of restarting the system. To clear the condition, press Ctrl, Alt, and Del simultaneously. Then shut down the computer via software, or follow the steps if your application stops responding (see [“Problems that are easy to fix”](#) on page 128).

The computer displays the WARNING RESUME FAILURE/Windows Error Recovery – Windows did not shut down successfully message.

To continue, select **Start Windows normally**. This can happen if the computer was put into Sleep mode and the battery has discharged. If you performed a shutdown before this message was displayed, an application or driver may have prevented Windows® from shutting down.

Data stored in the computer's memory has been lost. Data stored in the computer's internal storage drive may not be affected.

Always save your data even when you are using Sleep mode. If your battery fully discharges, information that has not been saved will be lost. Your computer can be configured to warn you when the battery is running low see [“What to do when the main battery runs low” on page 90](#).

If you are running on battery power, it is recommended that you do not leave the computer in Sleep mode for long periods of time.

To charge the battery, leave the computer plugged into a live wall outlet for several hours. For more information see [“Changing the main battery” on page 94](#).

The AC power light is blinking.

If the AC power light is blinking, try the following steps:

- 1** Cut off power to the computer by disconnecting the AC adaptor and removing the battery. The error condition will be interrupted, and the AC power light will stop flashing.
- 2** Put the battery back into the computer. Do not connect the AC adaptor. Try turning the computer on again.

If the computer starts normally, the AC adaptor may be defective and will need to be replaced.

If the AC power light starts flashing, remove the battery, and continue with the steps below.

- 3** Connect the AC adaptor to the computer. Leave the battery out of the computer. Try turning the computer on again.

If the computer starts normally, the battery may need charging, may be depleted, or may be defective. Turn the computer off, insert the battery, turn the computer on, and then leave the computer running for several hours, which will deliver a slow, steady “trickle-charge” to the battery. Once the battery has been trickle-charged, it may begin working correctly again.

If the trickle-charging does not prove effective, visit the Toshiba Web site at support.toshiba.com and see the Support Bulletin **Step-Charging the computer's battery** (click the **Ask Iris®** link and search for the support bulletin by name).

- 4 Connect the AC adaptor to a different power outlet, preferably in a different room. If the computer starts normally, there may be a problem with the AC outlet itself, or the voltage level available from it.
- 5 Verify that the AC adaptor is the correct unit for your computer model. The computer may not be able to start from an AC adaptor that is rated for less current (amperage) than the computer requires, even if the rated voltage is correct, and the plug fits correctly in the DC-IN socket. The labels on the bottom of the computer and the AC adaptor show the specifications for voltage ("V") and current ("A") for each device. The voltage level must match exactly. The amperage rating of the AC adaptor must be equal to or greater than that required by the computer.

The battery light is blinking when the computer is on.

If the battery light is blinking when the computer is on, this indicates a power mismatch. Do the following:

- 1 Check the OUTPUT specifications on the AC adaptor (for example, DC 19V – 3.95A)
- 2 Check the INPUT specifications on the bottom of the computer.

The output specifications of the AC adaptor must match the input specifications of the computer.

- 3 If the specifications do **not** match, locate and use the AC adaptor that shipped with your computer. If the specifications **do** match, contact Toshiba. See "[Contacting Toshiba](#)" on page 154.

The Windows® operating system is not working

Once you are familiar with your computer and used to the way the operating system responds to your work routine, you can easily detect if the operating system is not working correctly. For example:

- ❖ The operating system fails to start after the initial startup appears.
- ❖ The operating system takes a long time to start.

- ❖ The operating system responds differently from the normal routine.
- ❖ The screen does not look right.

Unless a hardware device has failed, problems usually occur when you change the system in some way such as installing a new application or adding a device.

If you experience any of these problems, use the options in the Startup menu to fix the problem.

Using Startup options to fix problems

If the operating system fails to start properly, you may need to troubleshoot the Operating System and/or its settings. There are several options to choose from depending on the severity of the problem and your level of expertise with computers.

If Windows® fails to start properly twice, the Windows® Boot menu will launch. To enter the Boot menu manually:

- 1 Press Ctrl, Alt, and Del simultaneously (once).
- 2 Press the **Power** button in the lower right corner of your screen.
- 3 Click the **Restart** option from the menu.
- 4 Click **Troubleshoot** from the menu.

You now have several options:

Refresh your computer

- ❖ Your files and personalization settings won't change
- ❖ Your computer settings will be changed back to their defaults
- ❖ Your Apps from the Windows® Store are retained
- ❖ Apps you installed from discs or Web sites are removed
- ❖ A list of removed apps is saved to your desktop

For more information, see [“Refresh your PC \(with user’s data\)” on page 58](#).

Reset your computer

- ❖ All of your personal files and apps are removed
- ❖ Your computer settings are changed back to their defaults

For more information, see [“Reset your PC” on page 60](#).

Advanced options

Clicking this option presents you with another set of options:

System Restore

- ❖ System Restore allows you to use a Restore point to return the computer to a state at which it was performing properly. Restore points are created:
 - ❖ When new hardware or software is installed
 - ❖ Manually by the user

System Image Recovery

Windows® will “Recover” the Operating system using a specific image provided by the user.

Automatic Repair

This feature automates the repair process. The Operating System will automatically look for problems and repair them if possible.

Command Prompt

The command prompt is a very powerful tool for advanced users.

Startup Settings

In previous Operating Systems the majority of the options found on this menu were available by pressing the F8 key during the Windows® boot process:

- ❖ Enable low resolution video mode
 - Restarts Windows® using your current video driver at low resolution. This allows you to reset your display settings in the event they have been improperly set.
- ❖ Enable debugging mode
 - Starts Windows® in an advanced troubleshooting mode
- ❖ Enable boot logging
 - Creates a file that lists all the drivers that are installed during startup

- ❖ **Enable Safe Mode**

Starts Windows® with a minimal set of drivers and services. If the computer starts and runs in Safe Mode, you will know the Operating System is most likely working properly and that you should look to third-party applications or drivers for the source of your problem.
- ❖ **Disable driver signature enforcement**

Allows drivers containing improper signatures to be installed
- ❖ **Disable early-launch anti-malware protection**

Allows drivers to initialize without being measured by the Anti-malware driver
- ❖ **Disable automatic restart on system failure**

Prevents Windows® from automatically restarting if an error causes it to fail. Choose this option only if Windows® is stuck in a loop where it fails, attempts to restart, and fails again repeatedly.

Internet problems

My Internet connection is very slow.

Many factors contribute to the speed with which you can surf the Internet. They include: network speed, network conditions, time of day (when everyone else is surfing, your access can be slow) and popularity of the sites you are trying to access. If accessing a particular site is very slow, try later.

My browser cannot find the URL address I typed in.

Make sure you separated the domain names of the address with the forward slash (/). Check the spelling of each name and the syntax of the address carefully. A single incorrect letter or missed character will make it impossible for your browser to locate the site.

My browser cannot find a site I bookmarked.

The World Wide Web is constantly changing. A site you bookmarked yesterday may not be available today or its server may be down for temporary repair. Try again later.

The Windows® operating system can help you

If the operating system has started properly but you still have a problem using your computer, the online Help can assist you in troubleshooting the problem. Getting to the online Help will differ depending on which interface you are in:

❖ **Start screen**—Type **Help and Support**

NOTE As soon as you begin typing, the search feature automatically begins.

❖ **Desktop**—Press the F1 key

When the “Windows Help and Support” screen appears, do one or both of the following:

- ❖ In the open search field type the topic you need help with and follow the on-screen instructions
- ❖ Click one of the options listed in the window and follow the instructions

You can connect to Support Online by going to Toshiba support at support.toshiba.com.

Fixing a problem with Device Manager

Device Manager provides a way to check and change the configuration of a device.

CAUTION Changing the default settings using Device Manager can cause other conflicts that make one or more devices unusable. Device Manager is a configuration tool for advanced users who understand configuration parameters and the ramifications of changing them.

Checking device properties

Device Manager provides a way to view the properties of a device. Properties include the name of the manufacturer, the type of device, the drivers installed, and the system resources assigned to the device.

To check a device’s properties:

- 1 From the Start screen, type **Device**.
The search feature appears.
- 2 Click **Settings**.

- 3 From the list of device(s), click **Device Manger**.
- 4 To view the device(s) installed, double-click the device type.
The operating system displays the device Properties dialog box, which provides an array of tabs. They may include:
 - ❖ The **General** tab, which provides basic information about the device.
 - ❖ The **Resources** tab, which lists resources assigned to the device. This tab does not appear if the device is not using resources.
 - ❖ The **Driver** tab, which displays the drivers being used by the device. This tab also provides options for updating the driver or rolling back the driver in case the new version is causing a problem.

The tabs that appear in the dialog box vary from one device to another.

For more information about Device Manager, refer to Windows® online Help.

Memory problems

Incorrectly connected or faulty memory modules may cause errors that seem to be hardware or even software related. It is worthwhile checking for these first:

- 1 From the Start or Desktop screen, move your pointer over the upper or lower right corner of the screen.
- 2 When the Windows® Charms appear, click the **Settings** (⚙️) Charm.
- 3 In the lower right of the screen click the **Power** (🔌) icon.

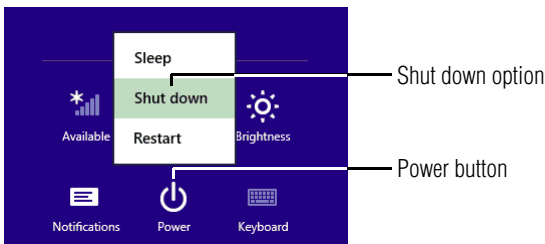

(Sample Image) Shut down

- 4 While holding the Shift key, click the Shut down option.
The computer closes all open applications, shuts down the operating system, and then turns off.

- 5 Check for the error again.
- 6 If the error recurs, remove the memory module entirely and check for the error again.

If removing the memory module eliminates the error, the memory module may be faulty. If the error recurs without the memory module installed, the error is not caused by the memory module.

NOTE

For this model, Slot A is the bottom slot. Slot B is the top slot. If only one memory module is to be installed, it must be installed in Slot A.



TECHNICAL NOTE: You must have at least one memory module installed for the computer to work.

Power and the batteries

Your computer receives its power through the AC adaptor and power cord/cable or from the system batteries (battery and real-time clock (RTC) battery). Power problems are interrelated. For example, a faulty AC adaptor or power cord/cable will neither power the computer nor recharge the batteries.

Here are some typical problems and how to solve them:

The AC power light does not come on when you plug in the AC adaptor and power cord/cable.

Make sure the AC adaptor and power cord/cable are firmly plugged into both the wall outlet and the computer.

If the AC power light still does not come on, check that the wall outlet is working properly by plugging in a lamp or other appliance.

The AC adaptor and power cord/cable work correctly, but the battery will not charge.

The battery does not charge while the computer is consuming full power. Try turning off the computer.

The battery may not be inserted correctly in the computer. Turn off the computer, remove the battery, clean the contacts with a soft dry cloth (if necessary) and replace the battery. See [“Removing the battery from the computer” on page 94.](#)

The battery may be too hot or too cold to charge properly. If you think this is the probable cause, let the battery reach room temperature and try again.

If the battery has completely discharged, it will not begin charging immediately. Leave the AC adaptor and power cord/cable connected, wait 20 minutes and see if the battery is charging.

If the battery light is glowing after 20 minutes, let the computer continue charging the battery for at least another 20 minutes before you turn on the computer.

If the battery light does not glow after 20 minutes, the battery may have reached the end of its useful life. Try replacing it.

The battery appears not to power the computer for as long as it usually does.

If you frequently repeat shallow charge and discharge, the battery meter may become inaccurate. Let the battery discharge completely, then try charging it again.

Check the power options via your Power Plans (see “[Power Plans](#)” on page 92). Have you added a device, such as a memory module, that takes its power from the battery? Is your software using the internal storage drive more? Is the display power set to turn off automatically? Was the battery fully charged to begin with? All these conditions affect how long the charge lasts.

After a period of time, the battery will lose its ability to perform at maximum capacity and will need to be replaced. This is normal for all batteries. To purchase a new battery pack, see your accessories information included with your computer, or visit the Toshiba Web site at accessories.toshiba.com. Refer to this site often to stay current on the most recent software and hardware options for your computer, and for other product information.

For more information on maintaining battery power, see “[Changing the main battery](#)” on page 94.

Keyboard problems

NOTE To capture a print screen of the entire screen, press the Fn + PRTSC key.

To capture only the active window displayed, press Fn + ALT while simultaneously pressing the PRTSC key.

You have connected an external keyboard and the operating system displays one or more keyboard error messages.

You may need to update your keyboard driver. Refer to the documentation that came with the keyboard or to the keyboard manufacturer's Web site.

The keyboard you connected may be defective or incompatible with the computer. Try using a different make of keyboard.

Display problems

Here are some typical display problems and their solutions:

The screen is blank.

Display Auto Off may have gone into effect. Press any key to activate the screen.

If you are using the built-in screen, make sure the display priority is not set for an external monitor. To do this, press F4. If this does not correct the problem, press F4 again to return the display priority to its previous setting.



HINT: Pressing the F4 key several times will advance you through the display options.

If you are using an external monitor:

- ❖ Check that the monitor is turned on.
- ❖ Check that the monitor's power cord/cable is firmly plugged into a working power outlet.
- ❖ Check that the cable connecting the external monitor to the computer is firmly attached.
- ❖ Try adjusting the contrast and brightness controls on the external monitor.
- ❖ Press F4 to make sure the display priority is not set for the built-in screen.

The screen does not look correct.

You can change the display settings by clicking a blank area of the desktop with the secondary control button, then clicking **Personalize**. This opens the Personalization window. Choose a theme for your desktop background, under **Colors**, **Sounds**, and **Screen Saver**, or change the settings for each of these components individually. Click **Display** and then **Change display settings** to choose the screen resolution.

For more information, see the Windows® online Help.

A message displays saying that there is a problem with your display settings and that the adapter type is incorrect or the current settings do not work with your hardware.

Reduce the size of the color palette to one that is supported by the computer's internal display.

To change the display properties:

- 1 Right-click in a blank area of the Windows® desktop.
- 2 Click **Personalize**, and then **Display**.
- 3 Use the menu on the right hand side of the page to:
 - ❖ Adjust resolution
 - ❖ Adjust brightness
 - ❖ Calibrate color
 - ❖ Change display settings
 - ❖ Project to a second screen
 - ❖ Adjust Clear Type text
- 4 Click **OK**.

The display mode is set to Simultaneous and the external display device does not work.

Make sure the external monitor is capable of displaying at resolutions of 800 x 600 or higher. Devices that do not support this resolution will only work in Internal/External mode, and not simultaneous mode.

Small bright dots appear on your TFT display when you turn on your computer.

Small bright dots may appear on your screen display when you turn on your computer. Your display contains an extremely large number of thin-film transistors (TFT) and is manufactured using high-precision technology. Any small bright dots that may appear on your display are an intrinsic characteristic of the TFT manufacturing technology. Over a period of time, and depending on the usage of the computer, the brightness of the screen will deteriorate. This is also an intrinsic characteristic of the screen technology. When the computer is operated on battery power, the screen will dim and you may not be able to increase the brightness of the screen while on battery power.

Disk or storage drive problems

Problems with the storage drive or with external media usually show up as an inability to access the drive or as sector errors. Sometimes a drive problem may cause one or more files to appear to have garbage in them. Typical problems are:

You are having trouble accessing a drive, or one or more files appear to be missing.

Make sure you are identifying the drive by its correct name (A: or C:).

Error-checking

NOTE This feature is not available for optical disc drives.

Run Error-checking, which analyzes the directories and files on the storage drive and repairs any damage it finds.

To run Error-checking:

- 1 From the Start screen, type **computer**.
- 2 Click **Computer** from the list that appears.

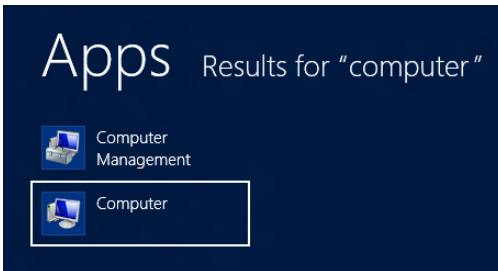

(Sample Image) Search results for "computer"

- 3 Right-click the drive you wish to check.

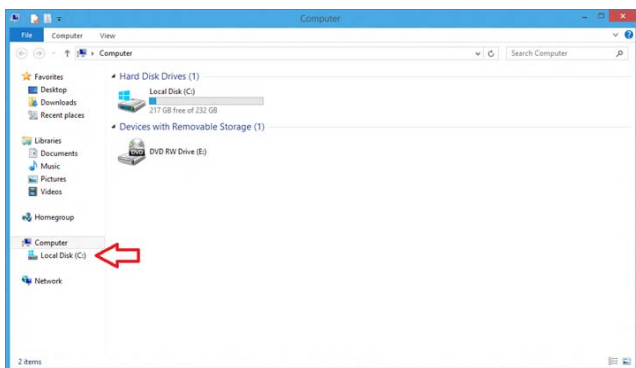

(Sample Image) Clicking on the drive

- 4 In the pop-up menu, click **Properties**.
The drive's Properties box appears.
- 5 Click the **Tools** tab.
- 6 Click the **Check** button.
The Error Checking box appears.
The system will alert you if you need to scan the drive.
- 7 Even if you do not need to scan the drive for errors you can scan by clicking **Scan drive**.
Error-checking tests and repairs the storage drive.

Your hard disk seems very slow.

If you have been using your computer for a long time, your files may have become fragmented. Run Disk Defragmenter.

To do this:

- 1 Move your pointer over the upper or lower right corner of the screen. When the Windows® Charms appear click the **Search** (🔍) Charm, click **Settings** and, in the Search field, type **Defragment**.
- 2 Click **Defragment and Optimize Drives**.
- 3 From the Optimize Drives menu click the drive you wish to defragment.
- 4 Click the **Optimize** button.
The system will display the status as it optimizes and defragments the drive.

Your data files are damaged or corrupted.

Refer to your software documentation for file recovery procedures. Many software packages automatically create backup files.

You may also be able to recover lost data using utility software. Consult your network administrator.

Some applications run correctly but others do not.

This is probably a configuration problem. If an application does not run properly, refer to its documentation and check that the hardware configuration meets its needs.

Optical disc drive problems

You cannot access a disc in the drive.

If the optical disc drive is an external drive, make sure the two USB cables or the AC adaptor cable are properly connected to the computer and refer to the documentation that came with your drive.

Make sure the tray that holds the optical disc is closed properly. Press gently until it clicks into place.

Open the tray and remove the disc. Make sure the tray is clean. Any dirt or foreign object can interfere with the laser beam.

Examine the disc to see if it is dirty. If necessary, wipe it with a clean cloth dipped in water or a neutral cleaner.

Replace the disc in the tray. Make sure that the disc is lying flat against the tray, label side up. Close the tray carefully, making sure it has shut completely.

You press the disc eject button, but the drive tray does not slide out.

Make sure the computer is connected to a power source and turned on. The optical disc drive eject mechanism requires power to operate.

Make sure an application is not accessing the drive and preventing it from ejecting.

If you need to remove a disc and cannot turn on the computer (for example, if the battery is completely discharged), use a narrow object, such as a straightened paper clip, to press the manual eject button. This button is in the small hole next to the optical disc drive eject button on the face of the optical disc drive tray.

CAUTION

Never use a pencil to press the manual eject button. Pencil lead can break off inside the computer and damage it.

Some discs run correctly but others do not.

Check that the type of disc you are using is compatible with your optical disc drive. For more information regarding supported optical media formats, refer to the complete detail specifications for your computer at support.toshiba.com.

If the problem is with an optical data disc, refer to the software's documentation and check that the hardware configuration meets the application's needs.

The disc will not come out of the drive when you click the eject button on the screen.

Press the button on the optical disc drive itself. For additional information see "You press the disc eject button, but the drive tray does not slide out." on page 143.

Sound system problems

No sound is coming from the computer's speakers.

Adjust the volume control.

Try pressing the F11 key to see if volume mute is disabled.

Check that the volume control on the computer is turned up.

If you are using external headphones or speakers, check that they are securely connected to your computer.

The computer emits a loud, high-pitched noise.

This is feedback between the microphone and the speakers. It occurs in any sound system when input from a microphone is fed to the speakers and the speaker volume is too loud. Adjust the volume control.

Printer problems

This section lists some of the most common printer problems.

The printer will not print.

Check that the printer is connected to a working power outlet, turned on and ready (on line).

Check that the printer has plenty of paper. Some printers will not start printing when there are just two or three sheets of paper left in the tray.

Make sure the printer cable is firmly attached to the computer and the printer, or the wireless connection is good.

Run the printer's self-test to check for any problem with the printer itself.

Make sure you installed the proper printer drivers as shown in the instructions that came with the printer.

You may have connected the printer while the computer is on. Disable Sleep mode, turn off the computer, and turn off the printer. Turn the printer back on, make sure it is online, and then turn the computer back on.

Try printing another file. For example, you could create and attempt to print a short test file using Notepad. If a Notepad file prints correctly, the problem may be in your original file.

If you cannot resolve the problem, contact the printer's manufacturer.

The printer will not print what you see on the screen.

Many applications display information on the screen differently from the way they print it. See if your application has a print preview mode. This mode lets you see your work exactly as it will print. Contact the software manufacturer for more information.

Wireless networking problems

NOTE

This section provides general troubleshooting tips for networking problems, specifically wireless (Wi-Fi®) networking.

The terms and concepts used assume a basic understanding of networks, and may be for more advanced users. If you need assistance or if you are not familiar with the terminology, please see Windows® Help and Support or contact your computer technician.

- ❖ If your computer is equipped with an internal Wi-Fi® adapter, verify that Airplane mode is OFF (the wireless indicator light  will be lit).
- ❖ Verify that your computer can detect access points or routers. If it can detect a Wi-Fi® access point or router then it may be a configuration issue.
- ❖ Verify that signal strength is good using the utility provided with the Wi-Fi® adapter.

- ❖ If another computer is on the same network, verify that it has network access, and can connect to the Internet. If, for example, the other computer cannot browse to a public Web site, the ISP's (Internet Service Provider) service may be disrupted.
 - ❖ Verify that the Service Set Identifier (SSID), or network name, is correct - i.e., that it matches the SSID assigned to the access point you are attempting to connect through. SSIDs are case-sensitive.
 - ❖ Check the Windows® Control Panel's Device Manager to verify that the Wi-Fi® adapter is recognized by the Windows® operating system, and that the driver is loaded. To access the Device Manager, from the Start screen begin typing **Computer**, or if you are in the Desktop screen, move your pointer over the upper or lower right corner of the screen. When the Windows® Charms appear click the **Search** (🔍) Charm, and then type **Computer**. Click **Control Panel**, **System and Security**, and then **System**. Carefully note any error messages - these will be very helpful if you should confer with a support technician at a later time.
-

NOTE

To enable or disable wireless communication, use the F12 key. For more information see "[TOSHIBA Function Keys](#)" on page 156.

- ❖ Use IPCONFIG to verify that the computer has a useful IP address - one other than the private address of 169.254.xxx.xxx assigned by Windows®.
 - 1 From the Start screen, type **Cmd**.
 - 2 Click **Command Prompt**.
 - 3 Enter **IPCONFIG/ALL**, and then press **ENTER**.The IP address for each active network adapter will be displayed.
- ❖ Connect your computer directly to your router or broadband modem, by plugging a standard CAT5 Ethernet patch cable (sold separately) into your computer's RJ45 Ethernet port. If your connection problem disappears, the problem lies in the Wi-Fi® part of your network.
- ❖ If you have enabled any security provisions (closed system, MAC address filtering, Wired Equivalent Privacy [WEP], etc.), check the access point vendor's Web site for recent firmware upgrades. Problems with WEP keys, in particular, are frequently addressed in new firmware releases.

The Windows® operating system wireless management utility does not work.

If you are using an external Wi-Fi® adapter (a USB adapter, or other variety), check if the adapter comes with its own management utility. If it does, the utility may be disabling the Windows® operating system wireless management utility, in which case you must use the adapter's management utility. If the documentation that accompanies the adapter does not provide enough information to determine if this is the case, contact that vendor's support group for further advice.

DVD operating problems

If you experience a problem playing DVDs, you may be able to fix the problem yourself.

For general problems playing a DVD title, try the following steps:

- 1 Verify that the disc is in a format that the drive supports.
- 2 Ensure that the disc is properly inserted in the drive tray.
- 3 Use the DVD Player software that came with your computer to view DVD movies.
- 4 Clean the disc and try again.

A dirty drive can also cause audio problems. If you have tried several discs and all fail, consider sending your drive to an authorized service provider to get it cleaned.

- 5 From the Start screen, type **Computer**. Click **Computer** from the list that appears.

The optical disc drive should appear in the list.

- 6 See “[Checking device properties](#)” on page 135 for instructions on using Device Manager to view the optical disc drive properties.
- 7 Check the Toshiba Web site for new information on optical disc drives and their operation.

A blank screen appears while watching a DVD-ROM movie or title.

Change the setting for when to turn off the display using the following steps:

- 1 Move your pointer over the upper or lower right corner of the screen. When the Windows® Charms appear click the **Search** (🔍) Charm, click **Settings** and, in the Search field, type **Power**.

- 2 From the search list, click **Choose when to turn off display**.
- 3 To keep the display from turning off, click **Never** in both drop down lists.
- 4 Click **Save changes**.

The screen saver runs while you are watching a movie or title.

If the screen saver is enabled, it runs on top of any movie or title you are watching. To disable the screen saver:

- 1 Right-click the desktop and click **Personalize** in the menu.
- 2 Click **Screen Saver** in the lower-right corner of the window.
- 3 Select **None** from the **Screen saver** drop-down list.
- 4 Click **OK**.

Develop good computing habits

Save your work frequently.

You can never predict when your computer will lock, forcing you to close an application and lose unsaved changes. Many software applications build in an automatic backup, but you should not rely solely on this feature. Save your work! See “[Computing tips](#)” on [page 73](#) for instructions.

On a regular basis, back up the information stored on your internal storage drive.

Use Windows® to back up files, or the entire computer, to an optical disc, or external hard disk. Here are some ways you can do this:

- ❖ Use the Windows® operating system to back up files or your entire computer to an optical disc, or external hard disk.
- ❖ Copy files to a rewritable external storage device.
- ❖ Connect your computer to the office network and copy files to your network partition.

Some people use a combination of these methods, backing up all files weekly and copying critical files to external media on a daily basis.

If you have installed your own applications, you should back up these applications as well as your data files. If something goes wrong that requires you to reformat your internal storage drive and start again, reloading all your applications and data files from a backup source will save time.

Read the user's guides.

It is very difficult to provide a fail-safe set of steps you can follow every time you experience a problem with the computer. Your ability to solve problems will improve as you learn about how the computer and its software work together.

Get familiar with all the user's guides provided with your computer, as well as the manuals that come with the applications and devices you purchase.

Your local computer store or book store sells a variety of self-help books you can use to supplement the information in the manuals.

Data and system configuration backup in the Windows® operating system

The Windows® operating system offers some easy-to-use features for backing up your Windows® settings and your data - documents and other important files. Take advantage of these features to protect yourself from much more difficult and time-consuming restoration procedures, and to safeguard your valuable data from loss.

Saving system configuration with restore points

The System Restore feature of the Windows® operating system quickly creates restore points - 'snapshots' of your Windows® operating system configuration - and saves them for later recall. If you experience problems after installing some new hardware or software, you can easily select a previously established Control Point to 'turn back the clock,' restoring the Windows® operating system to the state it was in just prior to the installation. This is much easier and more effective than uninstalling the hardware or software, which often leaves behind unwanted files and settings. It is also easy to undo a restore point selection, if you change your mind.

Follow these steps to create a restore point using the System Restore utility:

- 1** From the Start screen, type **Control**. Click **Control Panel** from the list that appears.
- 2** Click **System and Security**, and then **System**.
- 3** In the left pane, click **System Protection**.

The System Protection tab of the System Properties window appears.

- 4** Click **Configure**.

- 5 Under **Restore settings** select **Turn on System Protection**.
- 6 Click **OK**.
- 7 Click **Create**.
- 8 In the input field, enter a name that is descriptive enough to be easily understood in the future, such as “Before installing Brand X Accounting app.” Then click **Create**.

The Windows® operating system creates the restore point, automatically stamps it with the current date and time, and displays a message that the restore point was successfully created.

- 9 Click **Close**.

Then, at a later time, you can re-establish your Windows® configuration using the saved restore point. To do this:

- 1 From the Start screen, type **Control**. Click **Control Panel** from the list that appears.
 - 2 Click **System and Security**, and then **System**.
 - 3 In the left pane, click **System Protection**.
- The System Protection tab of the System Properties window appears.
- 4 Click **System Restore...**
 - 5 Click **Next**.
 - 6 Click the Restore point you want to use then click **Next**.

The time stamp and description of each Restore point is displayed.

NOTE

At this point you can click “Scan for affected programs” to determine what the impact of using the clicked Restore Point will be.

- 7 Verify that the Restore point you clicked is the correct one. If it is not, click **Back** to return to the previous step.
- 8 Close all programs and save all open files.
- 9 Click **Finish**, and then **Yes** to begin the system restore.

Your Windows® operating system configuration will now be restored to the state it was in when the chosen restore point was created, and then the computer will be automatically restarted.

Backing up your data or your entire computer with the Windows® operating system

The most valuable component of your computer system is the data you create and store on its internal storage drive. Since problems with either hardware or software can make the data inaccessible or even destroy it, the next most valuable component of your computer system may be a recent backup of your data.

Fortunately, the Windows® operating system offers a convenient way to back up your computer or just your important files to optical disc drives, or hard drives. An external hard drive is recommended in case the internal storage drive fails. No additional software is required. Most of the optical disc drives built into recent Toshiba portable computer models can write to (or ‘burn’) as well as read from optical discs. External optical disc writers are also widely available.

Follow these steps to back up your computer or files to optical discs, or a storage drive:

NOTE You cannot back up the computer while running on battery power. Connect the AC adaptor before continuing.

- 1 From the Start screen, type **Control**. Click **Control Panel** from the list that appears.
- 2 Click **Save backup copies of your files with File History** under the **System and Security** heading. Follow the on-screen instructions to back up your files.

For additional Help, while in the Windows® Desktop screen, press the F1 key to launch the Windows® Help and Support screen. Search for “back up files”.

General tips for installing hardware and software

Here are a few tips to help ensure safe and easy installation of new hardware (printers, pointing devices, external hard drives, optical disc drive writers, scanners, etc.) and software (applications like Microsoft® Office and Adobe® Photoshop®, or utility software such as special toolbars for your web browser).

- ❖ Create a restore point (refer to “[Saving system configuration with restore points](#)” on page 149). Before installing anything, use the System Restore utility to set a restore point (see the section titled restore points). If anything goes wrong, you will then be able to easily restore the Windows® operating system to

the state it was in prior to the installation, undoing any changes that the installation process introduced.

- ❖ Back up your critical data (see [“Backing up your data or your entire computer with the Windows® operating system” on page 151](#)).
- ❖ Have your back up DVD(s) on hand in case you need any files from them.
- ❖ Do not guess – follow directions carefully! It is often necessary to run an installation utility first – before connecting a new hardware item to the computer. If the device is connected first, it may be very difficult to complete the installation successfully. Always carefully follow the installation instructions that accompany the hardware or software.
- ❖ Restart the Windows® operating system. Always restart the Windows® operating system after each installation, even if the installation utility does not prompt you to do so. This will ensure that the installation is completed, and will clean up anything that the installation utility left behind.
- ❖ Do one installation at a time. If you have several new items to add to your computer system, install just one at a time, creating restore points immediately before each successive installation. This will make it much easier to determine the origin of any new problems. For best results, follow this sequence:
 - 1 Back up critical data.
 - 2 Create a restore point.
 - 3 Install one item of hardware or software.
 - 4 Restart the Windows® operating system.
 - 5 Use the new hardware or software for a while, noting any new problems. Make sure that your critical applications (email, business applications, etc.) are working correctly, and verify that important devices are still functioning.
 - 6 For each additional hardware or software item, repeat these steps, starting at step 1 if any of your critical data has changed, or starting at step 2 if no critical data has changed.

USB Sleep and Charge is not working.

USB Sleep and Charge may be disabled. Open the TOSHIBA Sleep and Charge utility to check if the feature is disabled and to enable it if necessary.

- ❖ Make sure that the device you want to charge is connected to a port that supports the USB Sleep and Charge function. Ports that support this feature are identified with the (⚡) icon.
- ❖ USB Sleep and Charge may be disabled. Open the TOSHIBA Sleep and Charge utility to check if the feature is disabled and to enable it if necessary. For more information, see [“Enabling/Disabling USB Sleep and Charge” on page 122.](#)
- ❖ Try selecting a different charging mode in the TOSHIBA Sleep and Charge utility, if your computer provides more than one charging mode. For more information, see [“Power supply mode settings” on page 122.](#)
- ❖ If you are attempting to charge a device without an AC adaptor connected to the computer, the computer's battery power may be below the limit specified in the TOSHIBA Sleep utility or the battery may be depleted. Lower the limit in the TOSHIBA Sleep utility to enable charging at the current battery power level, or, if battery power is running low or is depleted, connect the AC adaptor to your computer.
- ❖ The USB Sleep and Charge function may not work with certain external devices even if they are compliant with the USB specification. In those cases, power on the computer to charge the device or use a different charging device.

The “USB Wakeup function” does not work.

- ❖ When the “USB Sleep and Charge function” is set to Enabled the “USB Wakeup function” does not work for ports that support the “USB Sleep and Charge function.” In that case, use a USB port that does not have the “USB Sleep and Charge function”-compatible icon (⚡), if you have a non-Sleep and Charge USB port available or disable the “USB Sleep and Charge function.” For more information, see [“Sleep and Charge” on page 120.](#)

If you need further assistance

If you have followed the recommendations in this chapter and are still having problems, you may need additional technical assistance.

Since some problems may be related to the operating system or the application you are using, it is important to investigate all sources.

- ❖ Review the troubleshooting information in your operating system documentation.
- ❖ If the problem occurs while you are running an application, consult the application's documentation for troubleshooting suggestions. Contact the software company's technical support group for their assistance.
- ❖ Consult the dealer from whom you purchased your computer and/or application. Your dealer is your best source for current information.

For the detailed specifications for your computer, visit support.toshiba.com.

Contacting Toshiba

Toshiba's Technical Support Web site

For technical support, or to stay current on the most recent software and hardware options for your computer, and for other product information, be sure to regularly check the Toshiba Web site at support.toshiba.com.

Other Toshiba Internet Web sites

toshiba.com	Worldwide Toshiba corporate site
us.toshiba.com	Marketing and product information in the USA
accessories.toshiba.com	Accessories information in the USA
www.toshiba.ca	Canada
www.toshiba-Europe.com	Europe
www.toshiba.co.jp/index.htm	Japan
latin.toshiba.com	Mexico and all of Latin America
acclaim.toshiba.com	Toshiba USA Self-Service support web site

Toshiba's worldwide offices

Australia

Toshiba (Australia) Pty. Limited
84-92 Talavera Road
North Ryde NSW 2113
Sydney
Australia

France

Toshiba Systèmes (France) S.A.
7, Rue Ampère; B. P. 131
92800 Puteaux Cédex
France

Italy

Centro Direzionale Colleoni
Palazzo Perseo
Via Paracelso 10
20041, Agrate Brianza
Milano, Italy

Latin America and Caribbean

Toshiba America Information
Systems, Inc.
9740 Irvine Boulevard.
Irvine, California 92618
United States

Spain

Toshiba Information Systems
(España) S.A.
Parque Empresarial San Fernando
Edificio Europa, 1a Planta
Escalera A
28831 (Madrid) San Fernando de
Henares
Spain

United States

Toshiba America Information
Systems, Inc.
9740 Irvine Boulevard
Irvine, California 92618
United States

Canada

Toshiba Canada Ltd.
191 McNabb Street
Markham, Ontario
L3R - 8H2
Canada

Germany

Toshiba Europe GmbH
Leibnizstraße 2
D-93055 Regensburg
Germany

Japan

Toshiba Corporation, PCO-IO
1-1, Shibaura 1-Chome
Minato-Ku, Tokyo, 105-8001
Japan

Mexico

Toshiba de México S.A. de C.V.
Sierra Candela No.111, 6to. Piso
Col. Lomas de Chapultepec.
CP 11000 Mexico, DF.

United Kingdom

Toshiba Information Systems
(U.K) Ltd.
Toshiba Court
Weybridge Business Park
Addlestone Road
Weybridge, Surrey KT15 2UL
United Kingdom

The Rest of Europe

Toshiba Europe (I.E.) GmbH
Hammfelddamm 8
D-4-1460 Neuss
Germany

For more information on additional Toshiba worldwide locations,
please visit: www.toshiba.co.jp/index.htm.

Appendix A

TOSHIBA Function Keys

TOSHIBA Function keys provide a quick way to modify selected system functions and to launch applications.

Functions

TOSHIBA Function keys are used to set or modify the following system functions:

- ❖ Help file
- ❖ Brightness control
- ❖ Output (Display switch)
- ❖ Touch pad
- ❖ Media buttons
- ❖ Mute
- ❖ Wireless

Help file



This TOSHIBA Function key displays the help file.

Display brightness



This TOSHIBA Function key decreases the screen brightness.



This TOSHIBA Function key increases the screen brightness.

Output (Display switch)



This TOSHIBA Function key cycles through the display options and highlights the available options. (Only the first option is available when you do not have an external monitor attached.)

NOTE

All modes are always displayed on the screen, however only the available modes for your system are functional.

- ❖ PC screen only
- ❖ Duplicate
- ❖ Extend
- ❖ Second screen only

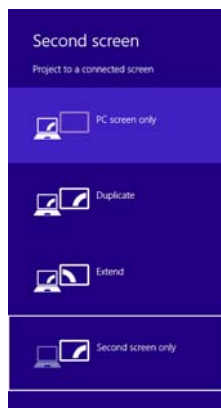

(Sample Image) Display mode options window

Disabling or enabling the touch pad



This TOSHIBA Function key enables/disables the touch pad.

To enable/disable the touch pad press F5.

For more information on using the touch pad, see [“Using the touch pad”](#) on page 64.

Media buttons



This TOSHIBA Function key allows you to return to the preceding track on the disc.



This TOSHIBA Function key allows you to start playing the disc, or pause it if currently playing.



This TOSHIBA Function key allows you to skip to the following track on the disc.



This TOSHIBA Function key decreases the volume of the sound coming from the computer.



This TOSHIBA Function key increases the volume of the sound coming from the computer.

Volume Mute



This TOSHIBA Function key enables/disables volume mute on your computer.

When volume mute is enabled, no sound will come from the speakers or headphones.

Disabling or enabling wireless devices



This TOSHIBA Function key enables/disables the Wi-Fi® antenna in your computer.

The wireless modes are:

- ❖ Disables the wireless antenna (**Airplane mode is ON**).
- ❖ Enables the wireless antenna (**Airplane mode is OFF**).

Keyboard Function keys

Fn+



This TOSHIBA Function key allows you to zoom out.

Fn+



This TOSHIBA Function key allows you to zoom in.

Zoom (Display resolution)



Fn+ [Space bar]

This TOSHIBA Function key switches screen resolution.

Cycle through the screen resolutions, and then select the desired resolution.

Appendix B

Power Cord/Cable Connectors

Your computer ships with the correct power supply for the country of purchase. This appendix shows the shapes of the typical AC power cord/cable connectors for various parts of the world.

USA



UL approved

Canada

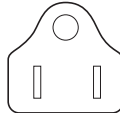

CSA approved

United Kingdom

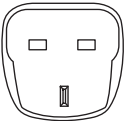

BS approved

Europe

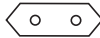

VDA approved
NEMKO approved

Australia



AS approved

Glossary



TECHNICAL NOTE: Some features defined in this glossary may not be available on your computer.

Acronyms

The following acronyms may appear in this User's Guide.

AC	Alternating Current
BIOS	Basic Input/Output System
BD-ROM	Blu-ray Disc Read-Only Memory
bps	bits per second
CD	Compact Disc
CD-ROM	Compact Disc Read-Only Memory
CD-RW	Compact Disc Rewrite Memory
CMOS	Complementary Metal-Oxide Semiconductor
CPU	Central Processing Unit
DC	Direct Current
DMA	Direct Memory Access
DIMM	Dual Inline Memory Module
DOS	Disk Operating System

DPI	Dots Per Inch
DVD	Digital Versatile (or Video) Disc
DVD-ROM	Digital Versatile (or Video) Disc Read-Only Memory
eSATA	external Serial Advanced Technology Attachment
FAT	File Allocation Table
FCC	Federal Communications Commission
GB	gigabyte
Gbps	gigabytes per second
HDD	Hard Disk Drive
HDMI	High-Definition Multimedia Interface
HDMI-CEC	High-Definition Multimedia Interface Consumer Electronics Control
HTML	Hypertext Markup Language
IEEE	Institute of Electrical and Electronics Engineers
I/O	Input/Output
IRQ	interrupt request
ISP	Internet Service Provider
KB	kilobyte
LAN	Local Area Network
LCD	Liquid Crystal Display
LED	Light Emitting Diode
MB	megabyte
Mbps	megabytes per second
MIDI	Musical Instrument Digital Interface
PC	Personal Computer
PCI	Peripheral Component Interconnect
PCMCIA	Personal Computer Memory Card International Association
RAM	Random Access Memory
RGB	Red, Green Blue light (monitor)
RFI	Radio Frequency Interference
ROM	Read-Only Memory

RTC	Real-Time Clock
SD	Secure Digital
SDRAM	Synchronous Dynamic Random Access Memory
SSD	Solid State Drive
TFT	Thin Film Transistor
USB	Universal Serial Bus
URL	Uniform Resource Locator
WAN	Wide Area Network
www	World Wide Web

Terms

The following terms may appear in this User's Guide.

A

active-matrix display—A liquid crystal display (LCD) made from an array of liquid crystal cells using active-matrix technology. Also known as a “TFT display,” in its simplest form there is one thin film transistor (TFT) for each cell. This type of display works well with computers because of its shallow depth and high-quality color. Active-matrix displays are viewable from wider angles than most passive-matrix displays.

adapter—A device that provides a compatible connection between two units. For example, the computer's internal display adapter receives information from the software and translates it into images on the screen. An adapter can take a number of forms, from a microprocessor to a simple connector. An intelligent adapter (one that is capable of doing some processing) may also be called a controller.

Alternating Current (AC)—The type of power usually supplied to residential and commercial wall outlets. AC reverses its direction at regular intervals. Compare *Direct Current (DC)*.

application—A computer program that you use to perform tasks of a specific type. Applications include word processors, spreadsheets, and database management systems. See also *program*.

- B** **backup**—A copy of a file, usually on a removable disk, kept in case the original file is lost or damaged.
- Basic Input/Output System (BIOS)**—See *BIOS*.
- baud rate**—The speed at which a communication device, such as a printer or modem, transmits information. Baud rate is the number of signal changes per second (not necessarily the same as bits per second). See also *bits per second*.
- Blu-ray Disc (BD)**—Offering more storage capacity than DVDs, the format was developed to allow for more data storage and to enable recording and playback of high-definition video (HD).
- BIOS (Basic Input/Output System)**—Basic instructions, stored in read-only memory (ROM), containing the information the computer needs to check hardware and load the operating system when you start up the computer.
- bits per second (bps)**—A way of measuring the speed at which information is passed between two devices. This is the basic unit of measure used in modem communications, and is similar, but not identical, to the baud rate. See also *baud rate*.
- boot**—To start the computer. The term “boot” originates from bootstrap program (as in “pulling itself up by its bootstraps”), a program that loads and initializes the operating system. See also *reboot*.
- boot disk**—See *system disk*.
- boot priority (startup sequence)**—The order in which the computer accesses its internal storage drives to locate the startup files. Under the default startup sequence, the computer looks for the startup files in the external media before checking the internal storage drive.
- bus**—An electrical circuit that connects the central processing unit (CPU) with other parts of the computer, such as the video adapter, disk drives, and ports. It is the pathway through which data flows from one device to another. See also *bus speed*, *frontside bus*.
- bus speed**—The speed at which the central processing unit (CPU) communicates with the other parts of the computer.

C

- cache**—A section of very fast memory in which frequently used information is duplicated for quick access. Accessing data from cache is faster than accessing it from the computer's main memory. See also *CPU cache*, *L1 cache*, *L2 cache*.
- CD**—An individual compact disc. See also *CD-ROM*.
- CD-ROM (Compact Disc Read-Only Memory)**—A form of high-capacity storage that uses laser optics instead of magnetic means for reading data. See also *CD*. Compare *DVD-ROM*.
- Central Processing Unit (CPU)**—The chip that functions as the “brain” of the computer. It takes information from outside sources, such as memory or keyboard input, processes the information, and sends the results to another device that uses the information.
- character**—Any letter, number, or symbol you can use on the computer. Some characters are non-printing characters, such as a paragraph break in a word-processing program. A character occupies one byte of computer storage.
- Charm/Charms**—Start screen icons that slide out from the right side of the screen and direct you to various Windows® functions.
- chip**—A small piece of silicon containing computer logic and circuits for processing, memory, input/output, and/or control functions. Chips are mounted on printed circuit boards.
- click**—To press and release the pointing device's primary button without moving the pointing device. In the Windows® operating system, this refers to the pointing device's left button, unless otherwise stated. See also *double-click*.
- color palette**—A set of specified colors that establishes the colors that can be displayed on the screen at a particular time.
- compatibility**—The extent to which computers, programs, or devices can work together harmoniously, using the same commands, formats, or language as another.
- configuration**—(1) The collection of components that make up a single computer system. (2) How parts of the system are set up (that is, configured).
- controller**—A device that controls the transfer of data from a computer to a peripheral device and vice versa. For example, disk drives, monitors, keyboards, and printers all require controllers.

CPU—See *Central Processing Unit (CPU)*.

CPU cache—A section of very fast memory residing between the CPU and the computer's main memory that temporarily stores data and instructions the CPU will need to execute commands and programs. See also *cache*, *L1 cache*, *L2 cache*.

cursor—An on-screen symbol (usually a flashing vertical line) that indicates the position where characters will appear when you enter data.

D

Desktop—Displays the standard Windows® operating system look and feel.

default—The setting selected by a program when the user does not specify an alternative setting.

device—A component attached to the computer. Devices may be external (outside the computer's case) or internal (inside the computer's case). Printers, disk drives, and modems are examples of devices.

device driver—A program (called a "driver") that permits a computer to communicate with a device.

dialog box—An on-screen window displayed by the operating system or a program giving a direction or requesting input from the user.

Direct Current (DC)—The type of power usually supplied by batteries. DC flows in one direction. Compare *Alternating Current (AC)*.

Direct Memory Access (DMA)—A dedicated channel, bypassing the CPU, that enables direct data transfer between memory and a device.

directory—See *folder*.

disable—To turn a computer option off. See also *enable*.

disc—A round, flat piece of material, designed to be read from and written to by optical (laser) technology, and used in the production of optical discs, such as CDs and DVDs. Compare *disk*.

disk—A round, flat piece of material that can be magnetically influenced to hold information in digital form, and used in the production of magnetic disks, such as hard disks. Compare *disc*. See also *hard disk*.

disk drive—The device that reads and writes information and programs on external media or hard disk. It rotates the disk at high speed past one or more read/write heads.

document—Any file created with an application and, if saved to disk, given a name by which it can be retrieved. See also *file*.

double-click—To press and release the pointing device's primary button rapidly twice without moving the pointing device. In the Windows® operating system, this refers to the pointing device's left button, unless otherwise stated.

download—(1) In communications, to receive a file from another computer through a modem or network. (2) To send font data from the computer to a printer. See also *upload*.

drag—To hold down the mouse button while moving the pointer to drag a selected object. In the Windows® operating system, this refers to the left mouse button, unless otherwise stated.

driver—See *device driver*.

DVD—An individual digital versatile (or video) disc. See also *DVD-ROM*.

DVD-ROM (Digital Versatile [or Video] Disc Read-Only

Memory)—A very high-capacity storage medium that uses laser optics for reading data. Each DVD-ROM can hold as much data as several CD-ROMs. Compare *CD-ROM*.

E

emulation—A technique in which a device or program imitates another device or program.

enable—To turn on a computer option. See also *disable*.

eSATA—An external device that supports hot swapping and fast data transfer. Very useful in storing and transferring large files.

executable file—A computer program that is ready to run. Application programs and batch files are examples of executable files. Names of executable files usually end with a *.bat* or *.exe* extension.

expansion device—A device that connects to a computer to expand its capabilities. Other names for an expansion device are port expander, port replicator, docking station, or network adapter.

extension—See *file extension*.

external device—See *device*.

- F** **file**—A collection of related information, saved on disk with a unique name. A file may be a program, information used by a program, or a document. See also *document*.
- File Allocation Table (FAT)**—The section of a storage drive that keeps track of the location of stored files.
- file name**—A set of characters that uniquely identifies a file within a particular folder. It consists of two parts: the actual name and the file name extension. See also *file extension*.
- file extension**—The three characters following the period (pronounced “dot”) at the end of a file name. The extension indicates the type of file. Examples are .exe for program files and .hlp for help files. See also *file name*.
- folder**—Also called directory. A container for organizing files saved to a disk. A folder is symbolized on screen by a graphical image (icon) of a file folder. A folder can contain files and other folders.
- format**—(verb) To prepare a blank disk for use with the computer’s operating system. Formatting creates a structure on the disk so the operating system can write information to the disk or read information from it.
- frontside bus**—The primary pathway (bus) between the CPU and the computer’s main memory. Also called “system bus.” See also *bus*.
- Function key**—(1) A feature in which certain keys in combination with the Fn key can set system options or control system parameters, such as the battery save mode. (2) A key or combination of keys that activates a memory resident program.
- function keys**—The keys labeled F1 through F12, typically located on the keyboard. Their function is determined by the operating system and/or individual programs.
- G** **ground**—A conductor to which all components of an electric circuit are connected. It has a potential of zero (0) volts, is connected to the earth, and is the point of reference for voltages in the circuit.
- H** **hard disk**—A storage device composed of a rigid platter or platters that can be magnetically coded with data. Hard disks hold much more information than some external media and are used for long-term storage of programs and data. The primary (or only) hard disk in a computer is usually fixed, but some computers have secondary hard disks that are removable.

hardware—The physical components of a computer system. Compare *software*.

HDMI (High-Definition Multimedia Interface)—An interface used to transmit high quality audio and video signal via a single cable in digital format, providing better picture quality than analog signal.

HDMI-CEC (HDMI Consumer Electronics Control)—One A/V component can control another while using this function, if connected with HDMI cables. See also *HDMI*.

Hibernation—A feature of many Toshiba computers that saves to the internal storage drive the current state of your work, including all open files and programs, when you turn the computer off. When you turn on the computer again, your work is returned to the same state it was when the computer was turned off. See also *Sleep*, *Suspend*.

hot swapping—The ability to add or remove devices from a computer while the computer is running and have the operating system automatically recognize the change.

I icon—A small image displayed on the screen that represents a function, file, or program.

interlaced—A method of refreshing a computer screen, in which only every other line of pixels is refreshed. Interlaced monitors take two passes to create a complete screen image. Compare *non-interlaced*.

internal device—See *device*.

Internet—The decentralized, world-wide network of computers that provides electronic mail, the World Wide Web, and other services. See also *World Wide Web*.

K keyboard shortcut—A key or combination of keys that you use to perform a task instead of using a pointing device such as a mouse.

L L1 (level one) cache—Memory cache built into the processor to help improve processing speed. See also *cache*, *CPU cache*, *L2 cache*.

L2 (level two) cache—Memory cache installed on the motherboard to help improve processing speed. It is slower than L1 cache and faster than main memory. See also *cache*, *CPU cache*, *L1 cache*.

LAN (Local Area Network)—A group of computers or other devices dispersed over a relatively limited area and connected by a communications link that enables any device to interact with any other on the network.

LED (Light Emitting Diode)—A solid state lamp (SSL) that uses light-emitting diodes (LEDs) as the source of light, which offers long life and high efficiency output. Multiple diodes are used together, since the light created by individual light-emitting diodes is small compared to incandescent and compact fluorescent lamps.

LCD (Liquid Crystal Display)—A type of display that uses a liquid substance between two transparent electrode panels. When an electric current passes through the electrodes, the molecules in the liquid form a crystalline pattern that polarizes the light passing through it. A filter over the electrodes permits only non-polarized light to pass to the surface of the display, creating light and dark pixels.

load—To move information from a storage device (such as a hard disk) into memory for processing.

local area network—See *LAN*.

logical drive—A section of a disk that is recognized by the operating system as a separate disk drive. A system's logical drives may differ from its physical drives. For example, a single hard disk drive may be partitioned into two or more logical drives.

M

memory—Typically refers to the computer's main memory, where programs are run and data is temporarily stored and processed. Memory can be volatile and hold data temporarily, such as RAM, or it can be nonvolatile and hold data permanently, such as ROM. A computer's main memory is RAM. See also *RAM*, *ROM*.

microprocessor—See *Central Processing Unit (CPU)*.

MIDI (Musical Instrument Digital Interface)—A standard for connecting musical instruments, synthesizers, and computers. The MIDI standard provides a way of translating music into a form computers can use, and vice versa.

motherboard—The computer's main circuit board that contains the processor, memory, and other primary components.

MS-DOS prompt—See *system prompt*.

multi-function drive—A DVD drive that can read and write to CD and DVD media.

multimedia—A combination of two or more media, such as sound, animation, and video in a computer program or presentation.

Musical Instrument Digital Interface—See *MIDI*.

N

network—A collection of computers and associated devices that are connected by communications facilities. A network allows you to share data and peripheral devices, such as printers, with other users and to exchange electronic mail.

non-interlaced—A method of refreshing a computer screen, in which each pixel of every line is refreshed as the electron beam scans across and down the screen. Compare *interlaced*.

non-system disk—A disk for storing programs and data that cannot be used to start the computer. Compare *system disk*.

O

online—Available through the computer. Online may refer to information being read from your own computer's internal storage drive, such as online documentation or online Help, or to information coming from another company on a company network or the Internet.

operating system—A set of programs that controls how the computer works. Examples of operating systems are the Windows Vista[®], Windows[®] 7, and Windows 8 operating systems.

optical disc drive—A drive which reads plastic coated discs on which information is recorded digitally, and uses a laser to read data, music, or videos.

P

palette—See *color palette*.

password—A unique string of characters entered by a user to verify his or her identity to the computer or the network.

PC Card—A credit-card-sized expansion card designed to increase the capabilities of computers. PC Cards provide functions such as modem, fax/modem, hard disk drive, network adapter, sound card, or SCSI adapter.

peripheral—Any device, such as a printer or joystick, that is attached to the computer and controlled by the computer's CPU.

pixel—Short for “picture element.” The smallest dot that can be produced on a screen or printer.

Plug and Play—Generally, refers to the computer’s ability to automatically configure itself to work with peripheral devices. When capitalized, refers to a standard that, when followed by a device manufacturer, allows a computer to configure itself automatically to work with the device.

pointer—An icon (usually an arrow) that moves on the screen when you slide your finger across the touch pad or move a mouse. Used to point to and select/activate on-screen items, such as icons, menu items, and buttons. The shape and purpose of the pointer varies depending on the program you are using and what you are doing.

pointing device—Any device, such as the touch pad or a mouse, that enables you to move the pointer on the screen.

port—A socket on the computer where you plug in a cable for connection to a network or a peripheral device.

processor—See *Central Processing Unit (CPU)*.

program—A set of instructions that can be executed by a computer. The general classes of programs (also called software) are operating system, application, and utility. See also *operating system, application, utility*.

properties—The attributes of an object or device. For example, the properties of a file include the file’s type, size, and creation date.

R

RAM (Random Access Memory)—*Volatile* memory that can be written to as well as read. *Volatile* here means that information in RAM is lost when you turn off your computer. This type of memory is used for your computer’s main memory. See also *memory*. Compare *ROM*.

Random Access Memory—See *RAM*.

Read-Only Memory—See *ROM*.

reboot—See *boot, restart*.

removable disk—A disk that can be removed from a disk drive. A Flash drive is one example of a removable disk.

resolution—A measure of the sharpness of the images that can be produced by a printer or displayed on a screen. For a printer, resolution is expressed in dots per inch (dpi). For a screen, it is expressed as the number of pixels available horizontally and vertically.

restart—Synonymous with reboot. To reset the computer by reloading the operating system without turning the computer off. See also *boot*.

RGB (Red, Green, Blue) monitor—A monitor that reproduces all colors by mixing red, green, and blue light in various combinations.

RJ45 connector—An eight-wire connector used to connect a computer to a network.

ROM (Read-Only Memory)—Non-volatile memory that can be read but not written to. *Non-volatile* here means that information in ROM remains whether or not the computer is receiving power. This type of memory is used to store your computer's BIOS, which is essential instructions the computer reads when you start it up. See also *BIOS, memory*. Compare *RAM*.

S

Secure Digital (SD)—A small, portable, non-volatile memory card used to store and transfer data between digital products, providing encryption capability for content security.

select—To highlight or otherwise specify text, data, or graphics with the intent to perform some operation on it.

shortcut—See *keyboard shortcut*.

Sleep—A feature of some Windows® operating systems that allows you to turn off the computer without exiting your open applications and to continue from where you left off when you turn the computer on again.

software—See *program*. Compare *hardware*.

solid state drive—A data storage device that utilizes solid-state memory as opposed to a hard disk (see also *hard disk*). Solid state drives hold a large amount of information and are used for storage of programs and data.

Start screen—Displays the new Windows® operating system look and feel.

Suspend—A feature of some Windows® operating systems that allows you to turn off the computer without exiting your open applications and to continue from where you left off when you turn the computer on again.

Swipe—Swipe an open window to the left or right of the screen to display the next or previous window.

system prompt—The symbol (in the MS-DOS® operating system, generally a drive letter followed by a “greater than” sign) indicating where users are to enter commands.

T **TFT display**—See *active-matrix display*.

Tile/Tiles—A list of square or rectangular icons on the Start screen representing applications that can be accessed by selecting them.

U **Universal Serial Bus (USB)**—USB is a serial bus that supports data transfer. USB allows hot swapping of peripherals. See also *bus*, *hot swapping*, *serial*.

upload—To send a file to another computer through a modem or network. See also *download*.

USB—See *Universal Serial Bus (USB)*.

USB Flash drive—A small, portable flash memory card that plugs into a computer’s USB port and functions as a portable hard drive. They are smaller and more durable than an external hard drive because they do not contain any internal moving parts, but have less storage capacity. See also *Universal Serial Bus (USB)*.

utility—A computer program designed to perform a narrowly focused operation or solve a specific problem. Utilities are often related to computer system management.

W **Web**—See *World Wide Web*.

Wi-Fi®—A registered trademark term of the Wi-Fi Alliance that stands for Wireless Fidelity, and is another term for the communication protocol to permit an Ethernet connection using wireless communication components.

World Wide Web (www)—The worldwide network of Web sites linked together over the Internet. A user of the Web can jump from site to site regardless of the location of the computer hosting the site. See also *Internet*.

Index

A

- AC adaptor 38
- AC power 86
- AC power light 38
- accessing
 - network 105
- adding
 - memory
 - check total memory 53
 - memory (optional) 45
 - optional external devices 45
- adequate ventilation
 - cooling fan 37
- adjusting
 - touch pad settings 66
- app, starting 77
- App, starting from Start screen 77
- apps
 - starting from Start screen 77
- audio features 106

B

- backing up files 74, 78
- battery
 - battery life 85

- Call2Recycle™ 99
- care 97, 98
- changing 94
- charge indicator light 40
- charge time 86
- charger 86
- charging 41, 86
- charging the real-time clock (RTC) 87
- conserving power 91
- determine remaining power 89
- disposal 98
- indicator light 89
- installation 94, 95
- low charge 90
- maintaining 98
- maximum capacity 85
- monitoring power 40, 88
- power management 86
- power options 90
- real-time clock (RTC) 85
- recharge time 85
- removing 94
- RTC memory 85

- running computer on battery
 - power 84
 - safety precautions 97
 - setting notifications 90
 - taking care of 97
- battery indicator light 89
- BIOS Setup
 - see System Settings
- button
 - eject, optical disc drive 79
 - mute button 80
 - next track button 80
 - play/pause button 80
 - previous track button 80
 - volume increase/decrease buttons 80
- buttons
 - media control buttons 80
- C**
- Call2Recycle™
 - battery 99
- caring for your computer 70
- changing
 - battery 94
- charging the battery 41
- cleaning the computer 71
- communications
 - set up 104
- computer
 - caring for 70
 - cleaning 71
 - environmental precautions 30, 99
 - moving 71
 - restart 43
 - running on battery power 84
 - setting up 38
 - Sleep mode 44
- computer lock 71
- computer will not start
 - troubleshooting 129
- computing habits
 - troubleshooting 148
- computing tips 73
- connecting
 - AC adaptor 38
 - AC adaptor cord to (DC-IN) 40
 - computer to a network 105
 - external device 67
 - HDMI™-compatible TV or display device 68
 - monitor 68
 - power cord/cable 40
 - power source 39
- cooling fan
 - adequate ventilation 37
- customize
 - computer settings 70
- D**
- data/entire system backup
 - troubleshooting 151
- desktop
 - creating new icon 102
 - exploring the 102
 - icons 102
 - recycle bin 103
 - standard features 101, 102
- Desktop Assist 111
 - Media & Entertainment tab 112
 - Support & Recovery tab 114
 - Tools & Utilities tab 113
- Device Manager
 - fixing a problem 135
- directing
 - display output 69
- disabling
 - touch pad 67
- display
 - troubleshooting 140
- display devices
 - external 67
- display output settings 69
- display, external

- adjusting 70
- disposal information 18
- disposing of used batteries 98
- DVD
 - removing with computer off 82
 - removing with computer on 81
- DVD player
 - troubleshooting 147
- DVDs
 - using 78

E

- eco power plan 93
- eco Utility® 115
- eject button
 - optical disc drive 79
- eject, optical disc drive 79
- enabling
 - touch pad 67
- enabling/disabling touch pad 159
- ENERGY STAR® 25
- exploring
 - desktop 102
 - Start screen 100
- external display device
 - HDMI™ Out port 67
 - RGB (monitor) port 68
- external display, adjusting 70

F

- files
 - backing up 74, 78
 - saving 78
- Function Key 123
- Function keys 159
 - disabling or enabling wireless devices 160
 - display brightness 157
 - Help file 157
 - keyboard Function keys 161
 - media buttons 159
 - Output (Display switch) 158
 - volume mute 160

- Zoom (Display resolution) 161
- zooming in 161
- zooming out 161

function keys 75

H

- headphones
 - using 107

I

icon

- desktop 102
- moving to desktop 102
- recycle bin 103
- safety 28
- Shut down 43, 44, 46, 136

Initial setup

- using your computer for the first time 42

installation

- memory module 45

installing

- a charged battery 95
- battery 94
- memory modules 45

internal storage drive

- recovery 54

K

keyboard

- function keys 75
- special Windows® keys 76
- troubleshooting 138
- using 74

keys

- function keys 75

L

LEDs

- system indicator lights 89
 - AC adaptor light 88
 - AC power light 38, 40
 - battery light 40, 41
 - Web Camera light 107

Licenses 17

lock

computer, using 71

M

maintaining your battery 98

manual eject hole

optical disc drive 79

media control buttons

mute button 80

next track button 80

play/pause button 80

previous track button 80

using 80

volume increase/decrease buttons
80

memory

adding (optional) 45

check total memory 53

removing memory module slot
cover 47

Memory card reader

inserting memory media 108

removing memory media 109

using 108

memory module

installation 45

inserting into socket 49

removing 51, 52

microphone

using 106

monitor

connecting 68

monitor problems

troubleshooting 139

monitoring battery power 88

mouse properties 76

moving the computer 71

N

network

accessing 105

connecting your computer 105

networking

wireless 105

notification area 103

notifications 104

O

ON/OFF indicator light 89

online resources

Toshiba 83

optical disc

Auto-Run feature 81

handling 80

inserting 80

playing optical media 81

positioning 80

recording optical media 82

removing with computer off 82

removing with computer on 81

optical disc drive

components 79

drive in-use indicator light 79

eject button 79

handling an optical disc 80

inserting an optical disc 80

manual eject hole 79

playing optical media 81

recording optical media 82

removing a disc 81, 82

troubleshooting 143

using 78, 79

optical discs

troubleshooting 144

optical media

recording 82

optional external devices

adding 45

other documentation 29

P

password

deleting a supervisor 117

deleting a user 118

instant password 116

- power-on password 116
 - setting 116
 - setting a supervisor 116
 - setting a user 118
 - supervisor password 116
 - user password 116
- PC Diagnostic Tool Utility 124
- PC Health Monitor 125
- port
 - HDMI™ 67
 - RGB 68
- power
 - connecting cable to AC adaptor 39
 - cord/cable 40
 - cord/cable connectors 162
 - energy-saving features 84
- power management 86
 - optimum performance 86
- power plans
 - selecting power plan options 92
- power saving options 91
- precautions
 - safety 35
- printer
 - troubleshooting 144
- problem solving
 - contacting Toshiba 154
 - Startup options 132
- projector
 - connecting 68
- R**
- real-time clock (RTC)
 - battery 85
- recording sounds 106
- recovery
 - creating recovery media 55
 - installing drivers and applications 63
 - internal storage drive 54
 - refresh your PC 58
 - reset your PC 60
 - restoring from recovery media 57
- Recovery Media Creator 126
- recycle bin icon 103
- refresh your PC
 - with user's data 58
- registering computer 42
- removing
 - an optical disc with computer on 81
 - and optical disc with computer off 82
 - battery from the computer 94
 - memory module 51
 - memory module slot cover 47
- restart
 - computer 43
- restore points
 - troubleshooting 149
- running computer on battery power 84
- S**
- safety
 - computer 99
 - disposing of batteries 98
 - icons 28
 - precautions 35
- safety precautions
 - battery 97
- saving files 78
- selecting
 - a place to work 30
 - power plan options 92
 - video cables 68
- Service Station 126
- setting
 - low battery notifications 90
- setting up
 - AC adaptor 38
 - adding memory (optional) 45
 - communications 104
 - computer 38

- software 42
- work environment 30
- settings
 - customize computer settings 70
 - display output 69
- Shut down
 - computer 43, 44, 46, 136
 - icon 43, 44, 46, 136
- shut down
 - computer 43
- Sleep and Charge 120
- Sleep mode
 - computer 44
- sounds
 - recording 106
- speakers
 - using external 107
- Start screen
 - exploring the 100
- starting an app 77
- starting an app from Start screen 77
- Startup menu
 - problem solving 132
- supervisor password, deleting 117
- supervisor password, set up 116
- system indicator lights
 - AC power 38
 - drive in-use indicator 79
 - LEDs 40, 41, 88, 89, 107
- System Settings 119
- T**
- taking care of battery 97
- taskbar 103
- television
 - adjusting display 70
- Tiles
 - Start screen 102
- tips
 - for computing 73
- Toshiba
 - online resources 83
 - registering computer
 - Toshiba Web site 42
 - worldwide offices 155
- Toshiba accessories
 - memory 45
- TOSHIBA Application Installer 127
- TOSHIBA Function Keys
 - functions 156
- touch pad
 - using 64
- traveling tips 99
- troubleshooting 139
 - AC power light is blinking 130
 - battery light is blinking 131
 - bookmarked site not found 134
 - checking device properties 135
 - computer will not start 129
 - contacting Toshiba 154
 - corrupted/damaged data files 143
 - data/entire system backup 151
 - Device Manager 135
 - display error message 140
 - display problems
 - screen is blank 139
 - DVD player 147
 - eject button 143
 - error message, warning resume failure 130
 - Error-checking 141
 - external display problems 140
 - external keyboard 138
 - external monitor 139
 - good computing habits 148
 - hard disk drive is slow 142
 - high-pitched noise 144
 - installing hardware/software 151
 - keyboard 138
 - keyboard will not respond 129
 - memory problems 136
 - missing files/trouble accessing a drive 141
 - on-screen eject button 144

- optical disc drive 143
 - power and batteries 137
 - printer 144
 - restore points 149
 - screen does not look correct/
flickers 139
 - slow Internet connection 134
 - sound system 144
 - trouble running discs 144
 - trouble running programs 143
 - URL address not found 134
 - USB Sleep and Charge
 - cannot use 153
 - USB Wakeup function
 - does not work 153
 - Windows® operating system not
working 131
 - wireless networking 145
- U**
- USB Sleep and Charge
 - cannot use 153
 - USB Wakeup function
 - does not work 153
 - user password, deleting 118
 - user password, setting 118
 - using
 - a microphone 106
 - computer lock 71
 - DVDs 78
 - eco power plan 93
 - Memory card reader 108
 - optical disc drive 78
 - touch pad 64
 - Web Camera 107
 - using the keyboard 74
 - Utilities 110
- V**
- video projector
 - adjusting display 70
- W**
- warranty
 - standard limited warranty 29
 - Web Camera
 - using 107
 - Web sites 154
 - Wi-Fi®
 - wireless networking 105
 - Windows® Charms 101
 - Devices 101
 - Search 101
 - Settings 101
 - Share 101
 - Start 101
 - Windows® key 76
 - Windows® operating system
 - desktop 102, 109
 - troubleshooting 131
 - Windows® Store 104
 - wireless networking 105
 - troubleshooting 145

Free Manuals Download Website

<http://myh66.com>

<http://usermanuals.us>

<http://www.somanuals.com>

<http://www.4manuals.cc>

<http://www.manual-lib.com>

<http://www.404manual.com>

<http://www.luxmanual.com>

<http://aubethermostatmanual.com>

Golf course search by state

<http://golfingnear.com>

Email search by domain

<http://emailbydomain.com>

Auto manuals search

<http://auto.somanuals.com>

TV manuals search

<http://tv.somanuals.com>