

TOSHIBA

Leading Innovation >>>

Tecra[®] A10 Series User's Guide

If you need assistance:

- ❖ Toshiba's Support Web site
pcsupport.toshiba.com
- ❖ Toshiba Customer Support Center
Calling within the United States (800) 457-7777
Calling from outside the United States (949) 859-4273

For more information, see “If Something Goes Wrong” on [page 178](#) in this guide.

▲ WARNING

Handling the cord on this product will expose you to lead, a chemical known to the State of California to cause birth defects or other reproductive harm. ***Wash hands after handling.***

Model: Tecra® A10 Series

Recordable and/or ReWritable Drive(s) and Associated Software Warranty

The computer system you purchased may include Recordable and/or ReWritable optical media drive(s) and associated software, among the most advanced data storage technologies available. As with any new technology, you must read and follow all set-up and usage instructions in the applicable user guides and/or manuals enclosed or provided electronically. If you fail to do so, this product may not function properly and you may lose data or suffer other damage. TOSHIBA AMERICA INFORMATION SYSTEMS, INC. ("TOSHIBA"), ITS AFFILIATES AND SUPPLIERS DO NOT WARRANT THAT OPERATION OF THE PRODUCT WILL BE UNINTERRUPTED OR ERROR FREE. YOU AGREE THAT TOSHIBA, ITS AFFILIATES AND SUPPLIERS SHALL HAVE NO RESPONSIBILITY FOR DAMAGE TO OR LOSS OF ANY BUSINESS, PROFITS, PROGRAMS, DATA, NETWORK SYSTEMS OR REMOVABLE STORAGE MEDIA ARISING OUT OF OR RESULTING FROM THE USE OF THE PRODUCT, EVEN IF ADVISED OF THE POSSIBILITY THEREOF.

Protection of Stored Data

For your important data, please make periodic back-up copies of all the data stored on the hard disk or other storage devices as a precaution against possible failures, alteration, or loss of the data. **IF YOUR DATA IS ALTERED OR LOST DUE TO ANY TROUBLE, FAILURE OR MALFUNCTION OF THE HARD DISK DRIVE OR OTHER STORAGE DEVICES AND THE DATA CANNOT BE RECOVERED, TOSHIBA SHALL NOT BE LIABLE FOR ANY DAMAGE OR LOSS OF DATA, OR ANY OTHER DAMAGE RESULTING THEREFROM. WHEN COPYING OR TRANSFERRING YOUR DATA, PLEASE BE SURE TO CONFIRM WHETHER THE DATA HAS BEEN SUCCESSFULLY COPIED OR TRANSFERRED. TOSHIBA DISCLAIMS ANY LIABILITY FOR THE FAILURE TO COPY OR TRANSFER THE DATA CORRECTLY.**

Critical Applications

The computer you have purchased is not designed for any “critical applications.” “Critical applications” means life support systems, medical applications, connections to implanted medical devices, commercial transportation, nuclear facilities or systems or any other applications where product failure could lead to injury to persons or loss of life or catastrophic property damage.

ACCORDINGLY, TOSHIBA, ITS AFFILIATES AND SUPPLIERS DISCLAIM ANY AND ALL LIABILITY ARISING OUT OF THE USE OF THE COMPUTER PRODUCTS IN ANY CRITICAL APPLICATIONS. IF YOU USE THE COMPUTER PRODUCTS IN A CRITICAL APPLICATION, YOU, AND NOT TOSHIBA, ASSUME FULL RESPONSIBILITY FOR SUCH USE.

FCC Notice “Declaration of Conformity Information”

This equipment has been tested and found to comply with the limits for a Class B digital device, pursuant to Part 15 of the FCC rules. These limits are designed to provide reasonable protection against harmful interference in a residential installation.

This equipment generates, uses and can radiate radio frequency energy and, if not installed and used in accordance with the instructions, it may cause harmful interference to radio communications. However, there is no guarantee that interference will not occur in a particular installation. If this equipment does cause harmful interference to radio or television reception, which can be determined by turning the equipment off and on, the user is encouraged to try to correct the interference by one or more of the following measures:

- ❖ Reorient or relocate the receiving antenna.
- ❖ Increase the separation between the equipment and receiver.
- ❖ Connect the equipment to an outlet on a circuit different from that to which the receiver is connected.
- ❖ Consult the dealer or an experienced radio/TV technician for help.

NOTE

Only Peripherals complying with the FCC Class B limits may be attached to this equipment. Operation with noncompliant peripherals or peripherals not recommended by Toshiba is likely to result in interference to radio and TV reception. Shielded cables must be used between the external devices and the computer's ports. Changes or modifications made to this equipment not expressly approved by Toshiba or parties authorized by Toshiba could void the user's authority to operate the equipment.

This device complies with Part 15 of the FCC Rules. Operation is subject to the following two conditions:

- ❖ This device may not cause harmful interference.
- ❖ This device must accept any interference received, including interference that may cause undesired operation.

Contact either:

- ❖ Toshiba's Support Web site at pcsupport.toshiba.com.
- ❖ Or call the Toshiba Customer Support Center:
Within the United States at (800) 457-7777
Outside the United States at (949) 859-4273

Industry Canada Requirement

This Class B digital apparatus complies with Canadian ICES-003.

Cet appareil numérique de la classe B est conforme à la norme NMB-003 du Canada.

FCC requirements

The following information is pursuant to FCC CFR 47, Part 68 and refers to internal modems.

This equipment complies with Part 68 of the FCC rules. On the bottom of this equipment is a label that contains, among other information, the FCC registration number and ringer equivalence number (REN) for this equipment. If requested, the information must be provided to the telephone company.

The modem connects to the telephone line by means of a standard jack called the USOC RJ11C.

A plug and jack used to connect this equipment to the premises wiring and telephone network must comply with the applicable FCC part 68 rules and requirements adopted by the ACTA. It is designed to be connected to a compatible modular jack that is also compliant.

The REN is used to determine the number of devices that may be connected to a telephone line. Excessive RENs on a telephone line may result in the devices not ringing in response to an incoming call. In most but not all areas, the sum of RENs should not exceed five (5.0). To be certain of the number of devices that may be connected to a line, as determined by the total RENs, contact the local telephone company. For products approved after July 23, 2001, the REN for this product is part of the product identifier that has the format US:AAAEQ##TXXXX. The digits represented by the ## are the REN without a decimal point (e.g., 03 is a REN of 0.3). For earlier products, the REN is separately shown on the label.

Connection to party line service is subject to state tariffs. Contact the state public utility commission, public service commission or corporation commission for information.

Telephone Company Procedures

The goal of the telephone company is to provide you with the best service it can. In order to do this, it may occasionally be necessary for them to make changes in their equipment, operations or procedures. If these changes might affect your service or the operation of your equipment, the telephone company will give you notice, in writing, to allow you to make any changes necessary to maintain uninterrupted service.

If Problems Arise

If this equipment causes harm to the telephone network, the telephone company will notify you in advance that temporary discontinuance of service may be required. But if advanced notice is not practical, the telephone company will notify the customer as soon as possible. Also, you will be advised of your right to file a complaint with the FCC if you believe it is necessary.

If trouble is experienced with this equipment, for repair or standard limited warranty information, please contact Toshiba Corporation, Toshiba America Information Systems, Inc. or an authorized representative of Toshiba, or the Toshiba Customer Support Center within the United States at (800) 457-7777 or Outside the United States at (949) 859-4273. If the equipment is causing harm to the telephone network, the telephone company may request that you disconnect the equipment until the problem is resolved.

Disconnection

If you should ever decide to permanently disconnect your modem from its present line, please call the telephone company and let them know of this change.

Fax Branding

The Telephone Consumer Protection Act of 1991 makes it unlawful for any person to use a computer or other electronic device, including Fax machines, to send any message unless such message clearly contains in a margin at the top or bottom of each transmitted page or on the first page of the transmission, the date and time it is sent and an identification of the business or other entity, or other individual sending the message and the telephone number of the sending machine or such business, other entity, or individual. (The telephone number provided may not be a 900 number or any other number for which charges exceed local or long-distance transmission charges.)

In order to program this information into your fax transmission, refer to the fax software instructions installed on this computer.

Alarm Equipment

If your home has specially wired alarm equipment connected to the telephone line, ensure the installation of this equipment does not disable your alarm equipment. If you have questions about what will disable alarm equipment, consult your telephone company or a qualified installer.

Instructions for IC CS-03 Certified Equipment

- 1** **NOTICE:** The Industry Canada label identifies certified equipment. This certification means that the equipment meets certain telecommunications network protective, operational and safety requirements as prescribed in the appropriate Terminal Equipment Technical Requirements document(s). The Department does not guarantee the equipment will operate to the user's satisfaction.

Before installing this equipment, users should ensure that it is permissible to be connected to the facilities of the local telecommunications company. The equipment must also be installed using an acceptable method of connection. The customer should be aware that compliance with the above conditions may not prevent degradation of service in some situations.

Repairs to certified equipment should be coordinated by a representative designated by the supplier. Any repairs or alterations made by the user to this equipment, or equipment malfunctions, may give the telecommunications company cause to request the user to disconnect the equipment.

Users should ensure for their own protection that the electrical ground connections of the power utility, telephone lines and internal metallic water pipe system, if present, are connected together. This precaution may be particularly important in rural areas.

Caution: Users should not attempt to make such connections themselves, but should contact the appropriate electric inspection authority, or electrician, as appropriate.

- 2** The user manual of analog equipment must contain the equipment's Ringer Equivalence Number (REN) and an explanation notice similar to the following:

The Ringer Equivalence Number (REN) of this device can be found on the label affixed to your computer.

NOTICE: The Ringer Equivalence Number (REN) assigned to each terminal device provides an indication of the maximum number of terminals allowed to be connected to a telephone interface. The termination on an interface may consist of any combination of devices subject only to the requirement that the sum of the Ringer Equivalence Numbers of all the devices does not exceed 5.

- 3** The standard connecting arrangement (telephone jack type) for this equipment is jack type(s): USOC RJ11C.

Wireless Interoperability

The TOSHIBA Wireless LAN Mini PCI Card products are designed to be interoperable with any wireless LAN product that is based on Direct Sequence Spread Spectrum (DSSS) radio technology, and is compliant to:

- ❖ The IEEE 802.11 Standard on Wireless LANs (Revision A/B/G), as defined and approved by the Institute of Electrical and Electronics Engineers.
- ❖ The Wireless Fidelity (Wi-Fi®) certification as defined by the Wi-Fi Alliance. The “Wi-Fi CERTIFIED” logo is a certification mark of the Wi-Fi Alliance.

CAUTION

Bluetooth® and Wireless LAN devices operate within the same radio frequency range and may interfere with one another. If you use *Bluetooth* and Wireless LAN devices simultaneously, you may occasionally experience a less than optimal network performance or even lose your network connection.

If you should experience any such problem, immediately turn off your *Bluetooth* or Wireless LAN device.

Please contact Toshiba computer product support on Web site <http://www.toshiba-europe.com/computers/tnt/bluetooth.htm> in Europe or pcsupport.toshiba.com in the United States for more information.

CAUTION

Radio Frequency Interference Requirements

This device is restricted to indoor use due to its operation in the 5.15 GHz to 5.25 GHz frequency range. FCC requires this product to be used indoors for frequency range 5.15 GHz to 5.25 GHz to reduce the potential for harmful interference to co-channel Mobile Satellite systems.

High power radars are allocated as primary users of the 5.25 GHz to 5.35 GHz and 5.65 GHz to 5.85 GHz bands. These radar stations can cause interference with and/or damage this device.

Wireless LAN and Your Health

Wireless LAN products, like other radio devices, emit radio frequency electromagnetic energy. The level of energy emitted by Wireless LAN devices however is far much less than the electromagnetic energy emitted by wireless devices like for example mobile phones.

Because Wireless LAN products operate within the guidelines found in radio frequency safety standards and recommendations, TOSHIBA believes Wireless LAN is safe for use by consumers. These standards and recommendations reflect the consensus of the scientific community and result from deliberations of panels and committees of scientists who continually review and interpret the extensive research literature.

In some situations or environments, the use of Wireless LAN may be restricted by the proprietor of the building or responsible representatives of the organization. These situations may for example include:

- ❖ Using the Wireless LAN equipment on board airplanes, or
- ❖ In any other environment where the risk of interference to other devices or services is perceived or identified as harmful.

If you are uncertain of the policy that applies on the use of wireless devices in a specific organization or environment (e.g. airports), you are encouraged to ask for authorization to use the Wireless LAN device prior to turning on the equipment.

CAUTION Exposure to Radio Frequency Radiation

The radiated output power of the TOSHIBA Wireless LAN Mini PCI Card is far below the FCC radio frequency exposure limits. Nevertheless, the TOSHIBA Wireless LAN Mini PCI Card shall be used in such a manner that the potential for human contact during normal operation is minimized. The antenna(s) used for this transmitter must not be co-located or operating in conjunction with any other antenna or transmitter.

Regulatory Information

The TOSHIBA Wireless LAN Mini PCI Card must be installed and used in strict accordance with the manufacturer's instructions as described in the user documentation that comes with the product. This device complies with the following radio frequency and safety standards.

Canada – Industry Canada (IC)

This device complies with RSS 210 of Industry Canada.

CAUTION The installer of this radio equipment must ensure that the antenna is located or pointed such that it does not emit RF field in excess of Health Canada limits for the general population; consult Safety Code 6, obtainable from Health Canada's Web site www.hc-sc.gc.ca/rpb. The RF device shall not be co-located with any other transmitter that has not been tested with this device.

Operation is subject to the following two conditions: (1) this device may not cause interference, and (2) this device must accept any interference, including interference that may cause undesired operation of this device.

L' utilisation de ce dispositif est soumise aux deux conditions suivantes: (1) il ne doit pas produire de brouillage et (2) l'utilisateur du dispositif doit être prêt à accepter tout brouillage radioélectrique reçu, même s'il est susceptible de compromettre son fonctionnement.

The term “IC” before the equipment certification number only signifies that the Industry Canada technical specifications were met.

To prevent radio interference to the licensed service, this device is intended to be operated indoors and away from windows to provide maximum shielding. Equipment (or its transmit antenna) that is installed outdoors is subject to licensing.

Pour empêcher que cet appareil cause du brouillage au service faisant l'objet d'une licence, il doit être utilisé à l'intérieur et devrait être placé loin des fenêtres afin de fournir un écran de blindage maximal. Si le matériel (ou son antenne d'émission) est installé à l'extérieur, il doit faire l'objet d'une licence.

CAUTION

This device is restricted to indoor use due to its operation in the 5.15 GHz to 5.25 GHz frequency range. Industry Canada requires this product to be used indoors for frequency range 5.15 GHz to 5.25 GHz to reduce the potential for harmful interference to co-channel Mobile Satellite systems.

High power radars are allocated as primary users of the 5.25 GHz to 5.35 GHz and 5.65 GHz to 5.85 GHz bands. These radar stations can cause interference with and/or damage this device.

NOTE

The above Caution information applies to products that operate with an 802.11a device.

EU Declaration of Conformity

TOSHIBA declares that this product conforms to the following Standards:



Supplementary *The product complies with the
Information: requirements of the Low Voltage
Directive 73/23/EEC, the EMC Directive
89/336/EEC and/or the R&TTE Directive
1999/5/EC.

This product is carrying the CE-Mark in accordance with the related European Directives. The party responsible for CE-Marking is TOSHIBA Europe GmbH, Hammfelddamm 8, 41460 Neuss, Germany.

The European Union WEEE (Waste from Electrical and Electronic Equipment) Directive Information

The European Union WEEE (Waste from Electrical and Electronic Equipment) Directive is intended to protect the quality of the environment and human health through the responsible use of natural resources and the adoption of waste management strategies that focus on recycling and reuse. This Directive requires producers of electrical and electronic products put on the market in European Union (EU) member countries after August 2005 to mark such products with a crossed-out wheeled bin symbol.



In the European Union, this symbol indicates that when the last end user wishes to discard this product, it must be sent to appropriate facilities for recovery and recycling. This Directive applies to EU member countries only and does not apply to end users in other countries such as the United States.

Although the initial emphasis is in Europe, Toshiba is already working with design engineers, suppliers, and other partners to determine appropriate worldwide product life cycle planning and end-of-life strategies for our products. Please contact your local government for applicable laws and regulations governing the disposal of this product. For information on how to trade-in or recycle your product, visit www.reuse.toshiba.com.

VCCI Class B Information

この装置は、情報処理装置等電波障害自主規制協議会（VCCI）の基準に基づくクラスB情報技術装置です。この装置は、家庭環境で使用することを目的としていますが、この装置がラジオやテレビジョン受信機に近接して使用されると、受信障害を引き起こすことがあります。

取扱説明書に従って正しい取り扱いをして下さい。

Modem Warning Notice

Conformity Statement

The equipment has been approved to [Commission Decision “CTR21”] for pan-European single terminal connection to the Public Switched Telephone Network (PSTN).

However, due to differences between the individual PSTNs provided in different countries/regions the approval does not, of itself, give an unconditional assurance of successful operation on every PSTN network termination point.

In the event of problems, you should contact your equipment supplier in the first instance.

Taiwan

Article 14	Unless approved, for any model accredited low power radio frequency electric machinery, any company, trader or user shall not change the frequency, increase the power or change the features and functions of the original design.
Article 17	Any use of low power radio frequency electric machinery shall not affect aviation safety and interfere with legal communications. In the event interference is caused, the use of such electric machinery shall be immediately discontinued. Operation of such products can be resumed only when they are modified and can no longer cause interference.

The legal communications mentioned in the above item refer to radio communications operated in accordance with telecommunication laws and regulations.

Low power radio frequency electric machinery shall resist against interference from legal communications or from industrial, scientific and medical radio emission electric machinery.

Using this Equipment in Japan

In Japan, the frequency bandwidth of 2,400 MHz to 2,483.5 MHz for second generation low-power data communication systems such as this equipment overlaps that of mobile object identification systems (premises radio station and specified low-power radio station).

1. Sticker

Please put the following sticker on devices incorporating this product.

The frequency bandwidth of this equipment may operate within the same range as industrial devices, scientific devices, medical devices, microwave ovens, licensed radio stations and non-licensed specified low-power radio stations for mobile object identification systems (RFID) used in factory product lines (Other Radio Stations).

1. Before using this equipment, ensure that it does not interfere with any of the equipment listed above.
2. If this equipment causes RF interference to other radio stations, promptly change the frequency being used, change the location of use, or turn off the source of emissions.
3. Contact TOSHIBA Direct PC if you have problems with interference caused by this product to Other Radio Stations.

2. Indication

The indication shown below appears on this equipment.



- 1** 2.4: This equipment uses a frequency of 2.4 GHz.
- 2** DS: This equipment uses DS-SS modulation.
OF: This equipment uses OFDM modulation.
- 3** The interference range of this equipment is less than 40m.
- 4** ■ ■ ■ This equipment uses a frequency bandwidth from 2,400 MHz to 2,483.5 MHz.

It is possible to avoid the band of mobile object identification systems.

3. TOSHIBA Direct PC

Monday – Friday: 10:00 – 17:00

Toll Free Tel: 0120-15-1048

Direct Dial: 03-3457-4850

Fax: 03-3457-4868

Device Authorization

This device obtains the Technical Regulation Conformity Certification and the Technical Conditions Compliance Approval, and it belongs to the device class of radio equipment of low-power data communication system radio station stipulated in the Radio Law and the Telecommunications Business Law of Japan.

The Name of the radio equipment: refer to the equipment label provided on the computer

JAPAN APPROVALS INSTITUTE FOR TELECOMMUNICATIONS
EQUIPMENT

Approval Number: D01-1128JP

TELECOM ENGINEERING CENTER Approval Number: 03NY.A0018,
03GZDA0017

The following restrictions apply:

- ❖ Do not disassemble or modify the device.
- ❖ Do not install the embedded wireless module into other device.
- ❖ 5.17 GHz to 5.23 GHz for indoor use only.

Radio Approvals for Wireless Devices

NOTE The following information is dependent on what type of wireless device is in your computer. Not all devices are available on all models.

Approved Countries/Regions for the Intel® Wireless Wi-Fi® Link 5000 Series

This equipment is approved to the radio standard by the countries/regions in the following table.

CAUTION Do not use this equipment except in the countries/regions in the following table.

Andorra	Argentina CNC: 533AN_HMW: "CNC C-6367" 533AN_MMW: "CNC C-6366" 512AN_HMW: "CNC C-6373" 512AN_MMW: "CNC C-6374"	Australia
Austria	Azerbaijan	Belgium
Bermuda	Brazil	Bulgaria
Caicos Islands	Cambodia	Canada
Cayman Islands	China	Costa Rica
Croatia	Curacao, Netherlands Antilles	Cyprus
Czech Republic	Denmark	Egypt
Estonia	Falkland Islands	Finland
France	French Guinea	French Polynesia
Germany	Gibraltar	Greece
Guadeloupe	Hungary	Iceland
India	Indonesia	Ireland
Italy	Japan	Kenya
Kuwait	Latvia	Liechtenstein
Lithuania	Luxemburg	Malaysia
Malta	Martinique	Mayotte
Mexico	Monaco	Montserrat
Morocco	Netherlands	New Caledonia
New Zealand	Norway	Oman
Paraguay	Philippines	Poland
Portugal	Qatar	Réunion

Romania	Russia	Saint Martin
San Marino	Saudi Arabia	Serbia
Singapore	Slovakia	Slovenia
South Africa	South Korea	Spain
Sweden	Switzerland	Tahiti
Taiwan	Turk Islands	Ukraine
UAE (United Arab Emirates)	United Kingdom	Uruguay
USA	Vatican	Vietnam
Virgin Islands	Zimbabwe	

Approved Countries/Regions for use for the Atheros AR5XB72 2.4 + 5GHz 11n minicard

This equipment is approved to the radio standard by the countries/regions in the following table.

CAUTION

Do not use this equipment except in the countries/regions in the following table.

NOTE

This device works on passive scan only.

A peer-to-peer mode is not available in 802.11a and Turbo Mode.

Argentina	Australia	Austria
Azerbaijan	Bahrain	Belgium
Brazil	Bulgaria	Canada
Chile	China (PRC)	Cyprus
Czech Republic	Denmark	Ecuador
Egypt	Finland	France
Germany	Greece	Hong Kong
Hungary	Iceland	India
Indonesia	Ireland	Italy
Japan	Latvia	Lithuania
Luxembourg	Malta	Mexico
Netherlands	New Zealand	Norway
Pakistan	Peru	Philippines
Poland	Portugal	Romania
Russia	Saudi Arabia	Slovakia

Slovenia	South Korea	Spain
Sweden	Switzerland/ Liechtenstein	Taiwan (ROC)
UAE (United Arab Emirates)	Ukraine	United Kingdom
Uruguay	USA	Venezuela

Europe - Restrictions for use of 2.4 GHz Frequencies in European Community Countries

België/ Belgique:	For private usage outside buildings across public grounds over less than 300m no special registration with IBPT/BIPT is required. Registration to IBPT/BIPT is required for private usage outside buildings across public grounds over more than 300m. For registration and license please contact IBPT/BIPT.
	Voor privé-gebruik buiten gebouw over publieke grond over afstand kleiner dan 300m geen registratie bij BIPT/IBPT nodig; voor gebruik over afstand groter dan 300m is wel registratie bij BIPT/IBPT nodig. Voor registratie of licentie kunt u contact opnemen met BIPT.
	Dans le cas d'une utilisation privée, à l'extérieur d'un bâtiment, au-dessus d'un espace public, aucun enregistrement n'est nécessaire pour une distance de moins de 300m. Pour une distance supérieure à 300m un enregistrement auprès de l'IBPT est requise. Pour les enregistrements et licences, veuillez contacter l'IBPT.
Deutschland:	License required for outdoor installations. Check with reseller for procedure to follow.
	Anmeldung im Outdoor-Bereich notwendig, aber nicht genehmigungspflichtig. Bitte mit Händler die Vorgehensweise abstimmen.
France:	Restricted frequency band: only channels 1 to 7 (2400 MHz and 2454 MHz respectively) may be used outdoors in France. Please contact A.R.T. (http://www.art-telecom.fr) for applicable procedures to follow.
	Bande de fréquence restreinte: seuls les canaux 1- 7 (2400 et 2454 MHz respectivement) doivent être utilisés endroits extérieur en France. Vous pouvez contacter l'Autorité de Régulation des Télécommunications (http://www.art-telecom.fr) pour la procédure à suivre.
Italia:	License required for indoor use. Use with outdoor installations not allowed.
	È necessaria la concessione ministeriale anche per l'uso interno. Verificare con i rivenditori la procedura da seguire.
Nederland:	License required for outdoor installations. Check with reseller for procedure to follow.

	Licentie verplicht voor gebruik met buitenantennes. Neem contact op met verkoper voor juiste procedure.
--	---

Europe - Restrictions for Use of 5 GHz Frequencies in European Community Countries

European Community Countries	5150-5250 MHz Channels: 36, 40, 44, 48 Indoor Only	5250-5350 MHz Channels: 52, 56, 60, 64 Indoor Only	5470-5725 MHz Channels: 100, 104, 108, 112, 116, 120, 124, 128, 132, 136, 140 Indoor/Outdoor
Austria	O	x	x
Belgium, France, Switzerland/Liechtenstein	O	O	x
Denmark, Finland, Germany, Greece, Ireland, Italy, Luxembourg, Netherlands, Norway, Portugal, Sweden, UK	O	O	O
Iceland, Spain	O	O	O

O: allowed x: forbidden

- ❖ To remain in conformance with European spectrum usage laws for Wireless LAN operation, the above 2.4 GHz and 5 GHz channel limitations apply. The user should use the wireless LAN utility to check the current channel of operation. If operation is occurring outside of the allowable frequencies as listed above, the user must cease operating the Wireless LAN at that location and consult the local technical support staff responsible for the wireless network.
- ❖ The 5 GHz Turbo mode feature is not allowed for operation in any European Community country.
- ❖ This device must not be operated in ad-hoc mode using channels in the 5 GHz bands in the European Community. Ad-hoc mode provides a direct communication between two client devices without a Wireless LAN Access Point.
- ❖ This device must be used with Access Points that have employed and activated a radar detection feature required for European Community operation in the 5 GHz bands. This device will operate under the control of the Access Point in order to avoid operating on a channel occupied by any radar system in the area. The presence of nearby radar operation may result in temporary interruption of operation of this device. The Access Point's radar detection feature will automatically restart operation on a channel free of radar. You may consult with the local technical support staff responsible

for the wireless network to ensure the Access Point device(s) are properly configured for European Community operation.

Approved Countries/Regions for use for the Atheros AR5XB63 11g minicard

This equipment is approved to the radio standard by the countries/regions in the following table.

CAUTION Do not use this equipment except in the countries/regions in the following table.

NOTE This device works on passive scan only.
A peer-to-peer mode is not available in 802.11a and Turbo Mode.

Argentina	Australia	Austria
Azerbaijan	Bahrain	Belgium
Brazil	Brunei	Canada
Chile	China (PRC)	Colombia
Costa Rica	Cyprus	Czech Republic
Denmark	Ecuador	Egypt
Finland	France	Germany
Greece	Honduras	Hong Kong
Hungary	Iceland	India
Indonesia	Ireland	Italy
Jamaica	Japan	Jordan
Latvia	Lithuania	Luxembourg
Malta	Mexico	Montenegro
Netherlands	New Zealand	Norway
Pakistan	Panama	Peru
Philippines	Poland	Portugal
Russia	Saudi Arabia	Serbia
Slovakia	Slovenia	South Korea
Spain	Sri Lanka	Sweden
Switzerland/ Liechtenstein	Taiwan (ROC)	Thailand
UAE (United Arab Emirates)	Ukraine	United Kingdom
Uruguay	USA	Venezuela
Vietnam		

Approved Countries/Regions for the Realtek® RTL8187B

This equipment is approved to the radio standard by the countries/regions in the following table.

CAUTION

Do not use this equipment except in the countries/regions in the following table.

Albania	Argentina	Australia
Austria	Azerbaijan	Bahrain
Bangladesh	Belgium	Bolivia
Bosnia and Herzegovina	Bulgaria	Cambodia
Canada	Chile	China
Colombia	Costa Rica	Croatia
Cyprus	Czech Republic	Denmark
Ecuador	Egypt	El Salvador
Estonia	Finland	France
Germany	Ghana	Greece
Guatemala	Honduras	Hong Kong
Hungary	Iceland	India
Indonesia	Ireland	Israel
Italy	Japan - Jate	Japan - Teleco
Jordan	Kazakhstan	Kenya
Kuwait	Latvia	Lebanon
Lesotho	Liechtenstein	Lithuania
Luxembourg	Macedonia	Malaysia
Malta	Mexico	Monaco
Morocco	Netherlands	New Zealand
Nicaragua	Nigeria	Norway
Oman	Pakistan	Panama
Papua New Guinea	Paraguay	Peru
Philippines	Poland	Portugal
Puerto Rico	Qatar	Rep. Dominicana
Romania	Russia	Saudi Arabia
Senegal	Serbia and Montenegro	Singapore
Slovak Republic	Slovenia	South Africa
South Korea	Spain	Sri Lanka
Sweden	Switzerland	Taiwan
Thailand	Turkey	Ukraine
UAE (United Arab Emirates)	United Kingdom	Uruguay
USA	Venezuela	Vietnam
Yemen	Zimbabwe	

Approved Countries/Regions for use for the Intel® PRO/Wireless 3945ABG Network Connection

This equipment is approved to the radio standard by the countries/regions in the following table.

CAUTION Do not use this equipment except in the countries/regions in the following table.

NOTE An adhoc mode is available in Ch1-Ch11(802.11b/g), An Infrastructure mode is available in Ch1-Ch11 (802.11b/g)
Ch36,40,44,48,52,56,60,64,149,153,157,161,165 (802.11a) Wake-up on wireless lan function is not available in battery mode.

802.11b/g (2.4 GHz)

Australia	Brunei	Canada
Chile	Hong Kong	India
Indonesia	Malaysia	Mexico
New Zealand	Saudi Arabia	Taiwan
USA	Venezuela	Vietnam

802.11a (5 GHz)

Australia	Brunei	Canada
Chile	Hong Kong	India
Indonesia	Malaysia	Mexico
New Zealand	Saudi Arabia	Taiwan
USA	Venezuela	Vietnam

Approved Countries/Regions for the Intel® Wireless Wi-Fi® Link 4965AGN

This equipment is approved to the radio standard by the countries/regions in the following table.

CAUTION Do not use this equipment except in the countries/regions in the following table.

NOTE An adhoc mode is available in Ch1-Ch11(802.11b/g), An Infrastructure mode is available in Ch1-Ch11 (802.11b/g) Ch36,40,44,48,52,56,60,64,149,153,157,161,165 (802.11a).

Antigua	Argentina	Aruba
Bahamas	Barbados	Belize
Bermuda	Bolivia	Canada
Chile	Cayman Islands	Colombia
Costa Rica	Curacao	Dominican Republic
Ecuador	El Salvador	Grenada
Guadeloupe	Guyana	Haiti
Honduras	Jamaica	Martinique
Netherlands Antilles	Nicaragua	Panama
Paraguay	Peru	Puerto Rico
St. Kitts	St. Maarten	Suriname
Trinidad and Tobago	Uruguay	USA
US Virgin Islands	Venezuela	

11a, 11b, 11g and 11n wireless are based on IEEE 802.11a, 802.11b, 802.11g and 802.11n respectively. The IEEE 802.11n specification has not been finalized and is currently in draft release. The TOSHIBA 11a/b/g/n Wireless LAN Adapters are based on the Draft Release, Version 1.0, of the IEEE 802.11n specification. An adapter with 11a/b, 11a/b/g, or 11a/b/g/n can communicate on any of its supported formats; the actual connection will be based on the access point to which it connects.

Connection compatibility with the wireless equipment in Draft 11n mode is not guaranteed.

The Draft 11n function cannot be used with WEP/TKIP. Draft 11n mode can be used only with WPA-PSK(AES) mode or no security mode.

Bluetooth® Wireless Technology Interoperability

Bluetooth® Cards from TOSHIBA are designed to be interoperable with any product with *Bluetooth* wireless technology that is based on Frequency Hopping Spread Spectrum (FHSS) radio technology, and is compliant to:

- ❖ *Bluetooth* Specification as defined and approved by The *Bluetooth* Special Interest Group.
- ❖ Logo certification with *Bluetooth* wireless technology as defined by The *Bluetooth* Special Interest Group.

CAUTION

Bluetooth wireless technology is a new innovative technology, and TOSHIBA has not confirmed compatibility of its *Bluetooth* products with all computers and/or equipment using *Bluetooth* wireless technology other than TOSHIBA portable computers.

Always use *Bluetooth* cards from TOSHIBA in order to enable wireless networks over two or more (up to a total of seven) TOSHIBA portable computers using these cards. Please contact TOSHIBA computer product support on Web site <http://www.toshiba-europe.com/computers/tnt/bluetooth.htm> in Europe or pcsupport.toshiba.com in the United States for more information.

When you use *Bluetooth* cards from TOSHIBA close to 2.4 GHz Wireless LAN devices, *Bluetooth* transmissions might slow down or cause errors. If you detect certain interference while you use *Bluetooth* cards from TOSHIBA, always change the frequency, move your computer to the area outside of the interference range of 2.4 GHz Wireless LAN devices (40 meters/43.74 yards or more) or stop transmitting from your computer. Please contact TOSHIBA computer product support on Web site <http://www.toshiba-europe.com/computers/tnt/bluetooth.htm> in Europe or pcsupport.toshiba.com in the United States for more information.

Bluetooth and Wireless LAN devices operate within the same radio frequency range and may interfere with one another. If you use *Bluetooth* and Wireless LAN devices simultaneously, you may occasionally experience a less than optimal network performance or even lose your network connection. If you should experience any such problem, immediately turn off either one of your *Bluetooth* or Wireless LAN. Please contact Toshiba computer product support on Web site <http://www.toshiba-europe.com/computers/tnt/bluetooth.htm> in Europe or pcsupport.toshiba.com in the United States for more information.

Approved Countries/Regions for use (*Bluetooth*[®] wireless technology)

Bluetooth[®] Card from Toshiba equipment is approved to the radio standard by the countries/regions in the following table.

CAUTION

Do not use this equipment except in the countries/regions in the following table.

Argentina	Australia	Austria
Belgium	Bulgaria	Canada
Chile	China	Cyprus
Czech Republic	Denmark	Egypt
Estonia	Finland	France

Germany	Greece	Hong Kong
Hungary	Iceland	Ireland
Italy	Japan	Jordan
Korea	Kuwait	Latvia
Lebanon	Liechtenstein	Lithuania
Luxembourg	Malta	Netherlands
New Zealand	Norway	Oman
Peru	Philippines	Poland
Portugal	Singapore	Slovakia
Slovenia	Spain	Sweden
Switzerland	Thailand	UK
Uruguay	USA	Venezuela

Bluetooth® Wireless Technology and Your Health

The products with *Bluetooth*® wireless technology, like other radio devices, emit radio frequency electromagnetic energy. The level of energy emitted by devices with *Bluetooth* wireless technology however is much less than the electromagnetic energy emitted by wireless devices such as mobile phones.

Because products with *Bluetooth* wireless technology operate within the guidelines found in radio frequency safety standards and recommendations, TOSHIBA believes *Bluetooth* wireless technology is safe for use by consumers. These standards and recommendations reflect the consensus of the scientific community and result from deliberations of panels and committees of scientists who continually review and interpret the extensive research literature.

In some situations or environments, the use of *Bluetooth* wireless technology may be restricted by the proprietor of the building or responsible representatives of the organization. These situations may for example include:

- ❖ Using the equipment with *Bluetooth* wireless technology on board airplanes, or
- ❖ In any other environment where the risk of interference to other devices or services is perceived or identified as harmful.

If you are uncertain of the policy that applies on the use of wireless devices in a specific organization or environment (e.g. airports), you are encouraged to ask for authorization to use the device with *Bluetooth* wireless technology prior to turning on the equipment.

CAUTION

Exposure to Radio Frequency Radiation

The radiated output power of the *Bluetooth* Card from TOSHIBA is far below the FCC radio frequency exposure limits. Nevertheless, the *Bluetooth* Card from TOSHIBA shall be used in such a manner that the potential for human contact during normal operation is minimized.

Regulatory statements

This product complies with any mandatory product specification in any country/region where the product is sold. In addition, the product complies with the following:

European Union (EU) and EFTA

This equipment complies with the R&TTE directive 1999/5/EC and has been provided with the CE mark accordingly.

Canada — Industry Canada (IC)

This device complies with RSS 210 of Industry Canada.

Taiwan

Article 14	Unless approved, for any model accredited low power radio frequency electric machinery, any company, trader or user shall not change the frequency, increase the power or change the features and functions of the original design.
Article 17	Any use of low power radio frequency electric machinery shall not affect aviation safety and interfere with legal communications. In the event interference is caused, the use of such electric machinery shall be immediately discontinued. Operation of such products can be resumed only when they are modified and can no longer cause interference.

The legal communications mentioned in the above item refer to radio communications operated in accordance with telecommunication laws and regulations.

Low power radio frequency electric machinery shall resist against interference from legal communications or from industrial, scientific and medical radio emission electric machinery.

Using this Equipment in Japan

In Japan, the frequency bandwidth of 2,400 MHz to 2,483.5 MHz for second generation low-power data communication systems such as this equipment overlaps that of mobile object identification systems (premises radio station and specified low-power radio station).

1. Sticker

Please put the following sticker on devices incorporating this product.

The frequency bandwidth of this equipment may operate within the same range as industrial devices, scientific devices, medical devices, microwave ovens, licensed radio stations and non-licensed specified low-power radio stations for mobile object identification systems (RFID) used in factory product lines (Other Radio Stations).

1. Before using this equipment, ensure that it does not interfere with any of the equipment listed above.
2. If this equipment causes RF interference to other radio stations, promptly change the frequency being used, change the location of use, or turn off the source of emissions.
3. Contact TOSHIBA Direct PC if you have problems with interference caused by this product to Other Radio Stations.

2. Indication

The indication shown below appears on this equipment.

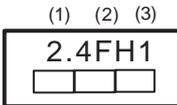

(4)

- 1** 2.4: This equipment uses a frequency of 2.4 GHz.
- 2** FH: This equipment uses FH-SS modulation.
- 3** The interference range of this equipment is less than 10m.
- 4** This equipment uses a frequency bandwidth from 2,400 MHz to 2,483.5 MHz. It is impossible to avoid the band of mobile object identification systems.

3. TOSHIBA Direct PC

Monday – Friday: 10:00 – 17:00

Toll Free Tel: 0120-15-1048

Direct Dial: 03-3457-4850

Fax: 03-3457-4868

Device Authorization

This device obtains the Technical Regulation Conformity Certification, and it belongs to the device class of radio equipment of low-power data communication system radio station stipulated in the Radio Law of Japan.

The Name of the radio equipment: EYXF2CS

TELECOM ENGINEERING CENTER

Approval Number: 01NYDA1305

The following restrictions apply:

- ❖ Do not disassemble or modify the device.
- ❖ Do not install the embedded wireless module into other device.

Optical Drive Safety Instructions

⚠ DANGER

This appliance contains a laser system and is classified as a CLASS 1 LASER PRODUCT. To use this model properly, read the user's guide carefully and keep it for your future reference.

Never attempt to disassemble, adjust or repair an optical drive. You could damage the drive. You would also be exposed to laser light or other safety hazards, resulting in serious injury. Always contact an authorized Toshiba service provider, if any repair or adjustment is required.

CLASS 1 LASER PRODUCT
LASERKLASSE 1

Location of the Required Label

(Sample shown below. Location of the label and manufacturing information may vary.)

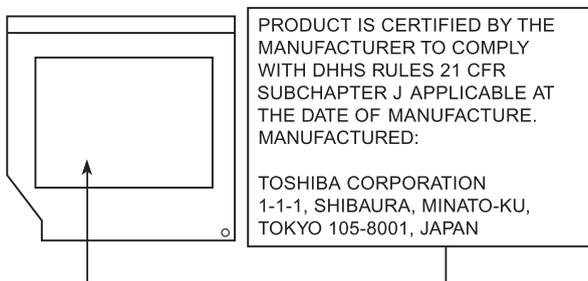

Copyright

This guide is copyrighted by Toshiba America Information Systems, Inc. with all rights reserved. Under the copyright laws, this guide cannot be reproduced in any form without the prior written permission of Toshiba. No patent liability is assumed, however, with respect to the use of the information contained herein.

©2008 by Toshiba America Information Systems, Inc. All rights reserved.

Export Administration Regulation

This document contains technical data that may be controlled under the U.S. Export Administration Regulations, and may be subject to the approval of the U.S. Department of Commerce prior to export. Any export, directly or indirectly, in contravention of the U.S. Export Administration Regulations is prohibited.

Notice

The information contained in this manual, including but not limited to any product specifications, is subject to change without notice.

TOSHIBA CORPORATION AND TOSHIBA AMERICA INFORMATION SYSTEMS, INC. (TOSHIBA) PROVIDES NO WARRANTY WITH REGARD TO THIS MANUAL OR ANY OTHER INFORMATION CONTAINED HEREIN AND HEREBY EXPRESSLY DISCLAIMS ANY IMPLIED WARRANTIES OF MERCHANTABILITY OR FITNESS FOR ANY PARTICULAR PURPOSE WITH REGARD TO ANY OF THE FOREGOING. TOSHIBA ASSUMES NO LIABILITY FOR ANY DAMAGES INCURRED DIRECTLY OR INDIRECTLY FROM ANY TECHNICAL OR TYPOGRAPHICAL ERRORS OR OMISSIONS CONTAINED HEREIN OR FOR DISCREPANCIES BETWEEN THE PRODUCT AND THE MANUAL. IN NO EVENT SHALL TOSHIBA BE LIABLE FOR ANY INCIDENTAL, CONSEQUENTIAL, SPECIAL, OR EXEMPLARY DAMAGES, WHETHER BASED ON TORT, CONTRACT OR OTHERWISE, ARISING OUT OF OR IN CONNECTION WITH THIS MANUAL OR ANY OTHER INFORMATION CONTAINED HEREIN OR THE USE THEREOF.

Trademarks

Tecra, Accupoint, and ConfigFree are registered trademarks of Toshiba America Information Systems, Inc. and/or Toshiba Corporation.

Microsoft, Outlook, Windows, and Windows Vista are either registered trademarks or trademarks of Microsoft Corporation in the United States and/or other countries.

DirectX, Active Desktop, DirectShow, and Windows Media are registered trademarks of Microsoft Corporation.

ConfigFree is a trademark of Toshiba Corporation.

Wi-Fi is a registered trademark of the Wi-Fi Alliance.

Intel, Intel Core, Celeron, Centrino and Pentium are trademarks or registered trademarks of Intel Corporation or its subsidiaries in the United States and other countries.

TouchPad is a trademark of Synaptics, Inc.

Adobe and Photoshop are either registered trademarks or trademarks of Adobe Systems Incorporated in the United States and/or other countries.

Memory Stick, Memory Stick PRO, and i.LINK are trademarks or registered trademarks of Sony Corporation.

Secure Digital and SD are trademarks of SD Card Association.

MultiMediaCard and MMC are trademarks of MultiMediaCard Association.

xD-Picture Card is a trademark of Fuji Photo Film, Co., Ltd.

Bluetooth word mark and logos are owned by the Bluetooth SIG, Inc. and any use of such marks by Toshiba is under license. Other trademarks and trade names are those of their respective owners.

All other brand and product names are trademarks or registered trademarks of their respective companies.

Computer Disposal Information

Lamp contains mercury. Disposal of this product may be regulated due to environmental considerations. For disposal, reuse or recycling information, please contact your local government or the Electronic Industries Alliance at www.eiae.org.

As part of Toshiba's commitment to preserving the environment, Toshiba supports various trade-in and recycling programs. Visit www.ToshibaDirect.com and select Recycling & Trade-in Programs, or enter **Recycle** in the search bar.

Contents

Introduction.....	36
This guide	38
Safety icons	39
Other icons used	39
Other documentation	40
Service options	40
Chapter 1: Getting Started.....	41
Selecting a place to work	41
Setting up a work environment	41
Keeping yourself comfortable	42
Precautions	42
Important information on your computer's cooling fan	44
Setting up your computer	44
Setting up your software.....	45
Registering your computer with Toshiba	46
Adding optional external devices.....	46
Connecting to a power source	47
Charging the main battery.....	49

Using the computer for the first time	50
Opening the display panel	50
Your computer's features and specifications	51
Turning on the power	51
Adding memory (optional)	52
Installing a memory module	53
Removing a memory module	58
Checking total memory	60
Hard Drive Recovery Utilities	61
Creating Recovery DVDs	62
Hard Disk Drive Recovery options	63
Hard Disk Drive Recovery using the Recovery media	68
Checking the HDD operating status	71
Installing drivers and applications.....	71
Using the Toshiba Dual Pointing Device	71
Using the TouchPad™	72
Scrolling with the TouchPad™	73
Control buttons	73
Disabling or enabling the TouchPad™	73
Using external display devices	73
Directing the display output when you turn on the computer	74
Adjusting the quality of the external display	75
Using an external keyboard	75
Using a mouse	75
Connecting a printer	76
Setting up a printer	76
Connecting an optional external diskette drive	77
Turning off the computer	78
Options for turning off the computer	78
Using the Shut Down command	81
Using and configuring Hibernation mode	83
Using and configuring Sleep mode	85
Closing the display panel	88
Customizing your computer's settings.....	88

Caring for your computer.....	88
Cleaning the computer	89
Moving the computer.....	89
Using a computer lock	89
Chapter 2: Learning the Basics.....	91
Computing tips	91
Using the keyboard	93
Character keys	93
Making your keyboard emulate a full-size keyboard	93
Ctrl, Fn, and Alt keys	94
Function keys.....	94
Special Windows® keys	94
Overlay keys	95
Using the overlay to type numeric data.....	95
Starting a program.....	96
Starting a program from the Start menu.....	96
Starting a program from Windows® Explorer ...	97
Starting a program using the Start Search field.....	98
Saving your work.....	98
Printing your work	100
Backing up your work	101
Restoring your work	101
Using the optical drive	101
Optical drive components	102
Inserting an optical disc	103
Playing an audio CD.....	104
Playing optical media.....	105
Recording optical media	105
Removing a disc with the computer on.....	106
Removing a disc with the computer off	106
Caring for optical discs	107
Toshiba's online resources	107

Chapter 3: Mobile Computing.....	108
Toshiba's energy-saver design.....	108
Running the computer on battery power	109
Battery Notice	109
Power management	110
Using additional batteries	111
Charging batteries.....	111
Charging the main battery.....	111
Charging the RTC battery.....	112
Monitoring main battery power.....	113
Determining remaining battery power.....	114
What to do when the main battery runs low ...	115
Setting battery notifications	115
Conserving battery power	116
Power Plans.....	117
Using a hot key to set the Power Plan.....	118
Changing the main battery	119
Removing the battery from the computer	119
Inserting a charged battery	121
Taking care of your battery	122
Safety precautions	122
Maintaining your battery	123
Disposing of used batteries	124
Traveling tips	125
Chapter 4: Exploring Your Computer's Features.....	126
Exploring the desktop	126
Finding your way around the desktop	127
Setting up for communications.....	129
Connecting your computer to a network.....	129
Connecting a modem to a telephone line	130
An overview of using the Internet	132
The Internet	132
The World Wide Web	132
Internet Service Providers	132
Connecting to the Internet	133

Surfing the Internet.....	133
Internet features.....	133
Uploading to, and downloading files from, the Internet	134
Exploring audio features	134
Recording sounds.....	134
Using external speakers or headphones.....	135
Web Camera	136
Using PC Cards.....	136
Inserting a PC Card	136
Removing a PC Card	137
Setting up a PC Card for your computer	138
Smart Card Reader	138
Using the Bridge Media Adapter Slot	139
Inserting memory media.....	139
Removing memory media.....	140
Using the i.LINK® port	140
Using an expansion device.....	141
Using an Optional Toshiba Express Port Replicator with your computer.....	141
Chapter 5: Utilities	142
TOSHIBA Assist	143
Connect.....	144
Secure.....	145
Protect & Fix	146
Optimize.....	147
TOSHIBA Application Installer.....	148
Setting passwords	149
Using an instant password.....	149
Using a supervisor password.....	150
Using a user password	151
Deleting a user password.....	152
TOSHIBA Security Assist	153
TOSHIBA PC Diagnostic Tool Utility.....	155
TOSHIBA HDD Protection Utility	156

TOSHIBA SD™ Memory Card Format Utility.....	157
TOSHIBA SD™ Memory Boot Utility.....	158
Booting from a bootable SD card.....	159
Mouse Utility	160
TOSHIBA Hardware Setup.....	161
USB Sleep and Charge Utility	163
Starting the USB Sleep and Charge Utility.....	163
USB Sleep and Charge	163
Enabling USB Sleep and Charge	165
Power supply mode settings.....	165
Battery settings	165
TOSHIBA Zooming Utility.....	166
TOSHIBA Button Support.....	167
CD/DVD Drive Acoustic Silencer	168
TOSHIBA Accessibility	169
Trusted Platform Module (TPM)	170
Fingerprint Authentication Utility.....	171
Fingerprint utility limitations	171
Using the Fingerprint Authentication Utility.....	171
Fingerprint Logon	172
Care and maintenance of your fingerprint reader	172
Fingerprint reader limitations	173
ConfigFree®.....	174
Getting Started	174
ConfigFree® Utilities.....	175
Chapter 6: If Something Goes Wrong	178
Problems that are easy to fix	178
Problems when you turn on the computer.....	179
The Windows® operating system is not working ..	182
Using Startup options to fix problems	182
Internet problems	183
The Windows® operating system can help you	184
Resolving a hardware conflict.....	184

A plan of action	184
Fixing a problem with Device Manager	185
Memory problems	186
Power and the batteries	187
Keyboard problems.....	188
Display problems	189
Disk or internal storage drive problems	191
Optical drive problems	193
Sound system problems	194
PC Card problems.....	194
Printer problems	196
Modem problems.....	197
Wireless networking problems.....	198
DVD operating problems.....	200
Develop good computing habits	201
Data and system configuration backup in the Windows® operating system.....	202
If you need further assistance	206
Before you contact Toshiba	206
Contacting Toshiba	207
Other Toshiba Internet Web sites.....	208
Toshiba's worldwide offices.....	208
Appendix A: Hot Keys/TOSHIBA Cards.....	210
Hot Key Cards	210
Using the Hot Key Cards	211
Application Cards	212
Using the Application Cards	213
Card Case.....	213
Hot key functions	214
Volume Mute	215
Lock (Instant security)	216
Power plan	217
Sleep mode	218
Hibernation mode	219
Output (Display switch)	220

Display brightness	221
Disabling or enabling wireless devices.....	222
Disabling or enabling the Toshiba Dual Pointing Device	223
Zoom (Display resolution)	224
Keyboard hot key functions	225
Appendix B: Power Cord/Cable Connectors.....	226
Appendix C: TOSHIBA PC	
Health Monitor	227
Enabling the TOSHIBA PC Health Monitor	228
If a TOSHIBA PC Health Monitor message is displayed.....	229
Cleaning the cooling module.....	230
Glossary.....	232
Index.....	246

Introduction

Welcome to the world of powerful, portable, multimedia computing. With your Toshiba computer, your work and entertainment can accompany you wherever you go.



Your Computer model may be ENERGY STAR® compliant. If the model you purchased is compliant, it is labeled with the ENERGY STAR® logo on the computer and the following information applies.

Toshiba is a partner in the Environmental Protection Agency's (EPA) ENERGY STAR® Program and has designed this computer to meet the latest ENERGY STAR® guidelines for energy efficiency. Your computer ships with the power management options preset to a configuration that will provide the most stable operating environment and optimum system performance for both AC power and battery modes.

To conserve energy, your computer is set to enter the low-power Sleep mode which shuts down the system and display within 15 minutes of inactivity in AC power mode. We recommend that you leave this and other energy saving features active, so that your computer will operate at its maximum energy efficiency. You can wake the computer from Sleep mode by pressing the power button. See the "Mobile Computing" section of the Toshiba User's Guide for more information on using power management settings to conserve computer energy.

According to the EPA, a computer meeting the new ENERGY STAR® specifications will use between 20% and 50% less energy depending on how it is used. If all U.S. household and businesses replaced old computers with new ENERGY STAR® qualified models, we would save more than \$1.8 billion in energy costs over the next five years and avoid greenhouse gas emissions equivalent to more than 2.7 million cars.

If every computer purchased by businesses next year met the new ENERGY STAR® requirements, businesses would save more than \$210 million over the lifetime of those models. That is equivalent to lighting 120 million square feet of U.S. commercial building space each year.

During 2006 Americans, with the help of ENERGY STAR®, saved about \$14 billion dollars on their utility bills and avoided greenhouse gas emissions equivalent to those from 25 million vehicles.

Visit <http://www.energystar.gov> or <http://www.energystar.gov/powermanagement> for more information regarding the ENERGY STAR® Program.

NOTE

This computer is compatible with European Union Directive 2002/95/EC, Restriction of the use of certain Hazardous Substances in electrical and electronic equipment (RoHS), which restricts use of lead, cadmium, mercury, hexavalent chromium, PBB, and PBDE. Toshiba requires its computer component suppliers to meet RoHS requirements and verifies its suppliers' commitment to meeting RoHS requirements by conducting component sampling inspections during the product design approval process.

NOTE

Certain Microsoft® software product(s) included with this computer may use technological measures for copy protection. IN SUCH EVENT, YOU WILL NOT BE ABLE TO USE THE PRODUCT IF YOU DO NOT FULLY COMPLY WITH THE PRODUCT ACTIVATION PROCEDURES. Product activation procedures and Microsoft's privacy policy will be detailed during initial launch of the product, or upon certain reinstallations of the software product(s) or reconfigurations of the computer, and may be completed by Internet or telephone (toll charges may apply).

Some software may differ from its retail version (if available), and may not include user manuals or all program functionality.

NOTE

The product specifications and configuration information are designed for a product Series. Your particular model may not have all the features and specifications listed or illustrated. For more detailed information about the features and specifications on your particular model, please visit Toshiba's Web site at pcsupport.toshiba.com.

While Toshiba has made every effort at the time of publication to ensure the accuracy of the information provided herein, product specifications, configurations, prices, system/component/options availability are all subject to change without notice. For the most up-to-date product information about your computer, or to stay current with the various computer software or hardware options, visit Toshiba's Web site at pcsupport.toshiba.com.

This guide

This guide introduces the computer's features. You can:

- ❖ Read the entire guide from beginning to end.
- ❖ Skim through and stop when a topic interests you.
- ❖ Use the table of contents and the index to find specific information.

Safety icons

This manual contains safety instructions that must be observed to avoid potential hazards that could result in personal injuries, damage to your equipment, or loss of data. These safety cautions have been classified according to the seriousness of the risk, and icons highlight these instructions as follows:

▲ DANGER

Indicates an imminently hazardous situation which, if not avoided, will result in death or serious injury.

▲ WARNING

Indicates a potentially hazardous situation which, if not avoided, could result in death or serious injury.

▲ CAUTION

Indicates a potentially hazardous situation which, if not avoided, may result in minor or moderate injury.

CAUTION

Indicates a potentially hazardous situation which, if not avoided, may result in property damage.

NOTE

Provides important information.

Other icons used

Additional icons highlight other helpful or educational information:



TECHNICAL NOTE: This icon indicates technical information about the computer.



HINT: This icon indicates helpful hints and tips.



DEFINITION: This icon indicates the definition of a term used in the text.

Other documentation

Your computer comes with the following documentation:

- ❖ An electronic version of the user's guide (this document)
- ❖ It may also contain guides for other programs that may come with your system.

For accessory information, visit Toshiba's Web site at accessories.toshiba.com.

Service options

Toshiba offers a full line of optional service programs to complement its standard limited warranty. Toshiba's standard limited warranty, extended warranty, and service upgrade terms and conditions are available at warranty.toshiba.com.

To stay current on the most recent software and hardware options for your computer, and for other product information, be sure to regularly check the Toshiba Web site at pcsupport.toshiba.com.

If you have a problem or need to contact Toshiba, see "If Something Goes Wrong" on page 178.

Chapter 1

Getting Started

This chapter provides tips for using your computer effectively, summarizes how to connect components, and explains what to do the first time you use your computer.

The “Instruction Manual for Safety and Comfort,” that is shipped with your computer, contains important safety information. Please read the safety instructions carefully and make sure you fully understand the instructions before you attempt to use your computer in order to avoid potential hazards that could cause bodily injury, property damage, or damage the computer.

Selecting a place to work

Your computer is portable and designed to be used in a variety of circumstances and locations.

Setting up a work environment

Place the computer on a hard flat surface that is large enough for the computer and any other items you are using, such as a printer. Leave enough space around the computer and other equipment to provide adequate ventilation. Otherwise, they may overheat. Read the “Provide adequate ventilation” section in the “Instruction Manual for Safety and Comfort” that is shipped with your computer.

To keep your computer in prime operating condition, protect your work area from:

- ❖ Dust, moisture, and direct sunlight.
- ❖ Equipment that generates a strong electromagnetic field, such as stereo speakers (other than speakers that are connected to the computer) or speakerphones.
- ❖ Rapid changes in temperature or humidity and sources of temperature change such as air conditioner vents or heaters.
- ❖ Extreme heat, cold, or humidity.
- ❖ Liquids and corrosive chemicals.

Keeping yourself comfortable

The Toshiba Instruction Manual for Safety and Comfort, included with your computer, contains helpful information for setting up your work environment and tips for working comfortably throughout the day.

Precautions

Your computer is designed to provide optimum safety and ease of use, and to withstand the rigors of travel. You should observe certain precautions to further reduce the risk of personal injury or damage to the computer.

- ❖ Avoid prolonged physical contact with the underside or surface of the computer.

▲ WARNING

Never allow any liquids to spill into any part of your computer, and never expose the computer to rain, water, seawater or moisture. Exposure to liquid or moisture can cause electric shock or fire, resulting in damage or serious injury. If any of these eventualities should accidentally occur, immediately:

1. Turn off the computer.
2. Disconnect the AC adaptor from the power plug socket and computer.
3. Remove the battery pack.

Failure to follow these instructions could result in serious injury or permanent damage to the computer.

Do not turn on the power again until you have taken the computer to an authorized service center.

CAUTION

- ❖ Avoid prolonged physical contact with the underside or surface of the computer.
 - ❖ Computer base and palm rest can become hot! Avoid prolonged contact to prevent heat injury to skin.
-

Read the “Avoid extended contact between computer base/palm rest and skin” section in the “Instruction Manual for Safety and Comfort” that is shipped with your computer.

CAUTION

Never place a heavy object on the computer and be careful not to drop a heavy object onto the computer. It could damage the computer or cause system failure.

- ❖ Never turn off the computer if a drive light indicates a drive is active. Turning off the computer while it is reading from or writing to a disk/disc or flash media may damage the disk/disc or flash media, the drive, or both.
 - ❖ Keep the computer and disks away from objects that generate strong magnetic fields, such as large stereo speakers. Information on some disks is stored magnetically. Placing a magnet too close to a disk can erase important files.
-

CAUTION

Handle discs carefully. Avoid touching the surface of the disc. Grasp it by its center hole and edge. If you handle the disc incorrectly, you could damage the disc and possibly lose data.

- ❖ Scan all new files for viruses. This precaution is especially important for files you receive via email or download from the Internet. Occasionally, even new programs you buy from a supplier may contain a computer virus. You need a special program to check for viruses. Ask your dealer to help you.

Important information on your computer's cooling fan

Your computer may have a CPU cooling fan that cools the CPU by drawing outside air into the computer.

⚠ WARNING

Always make sure your computer and AC adaptor have adequate ventilation and are protected from overheating when the power is turned on or when an AC adaptor is connected to a power outlet (even if your computer is in Sleep mode). In this condition, observe the following:

- ❖ Never cover your computer or AC adaptor with any object.
- ❖ Never place your computer or AC adaptor near a heat source, such as an electric blanket or heater.
- ❖ Never cover or block the air vents including those located at the base of the computer.
- ❖ Always operate your computer on a hard flat surface. Using your computer on a carpet or other soft material can block the vents located at the base of the computer.

Overheating your computer or AC adaptor could cause system failure, computer or AC adaptor damage or a fire, possibly resulting in serious injury.

Read the “Provide adequate ventilation” section in the “Instruction Manual for Safety and Comfort” that is shipped with your computer.

NOTE

The cooling fan location will vary depending on the computer.

Setting up your computer



TECHNICAL NOTE: You must complete all setup steps up to and including “[Setting up your software](#)” on page 45 before adding external or internal components to your computer. These components include, but are not limited to, a mouse, keyboard, printer, memory, and PC Cards.

Your computer contains a rechargeable main battery that needs to be charged before you can use it.

To use external power or to charge the battery you must attach the AC adaptor. See “[Connecting to a power source](#)” on page 47.

NOTE

Please handle your computer carefully to avoid scratching or damaging the surface.

Setting up your software

CAUTION

When you turn on the computer for the first time, do not turn off the power again until the operating system has loaded completely.

NOTE

The names of windows displayed, and the order in which windows appear, may vary according to your software setup choices.

The first time you turn on your computer, the Setup Wizard guides you through steps to set up your software.

- 1 From the Welcome screen click **Next** to enter the Setup Wizard.
- 2 Confirm acceptance of Microsoft's End User License Agreement and click **Next**.
- 3 Enter your desired user name and password, choose a picture to be associated with your user account, and then click **Next**.
- 4 Enter the computer name and choose your background and then click **Next**.
- 5 Click the appropriate option from the Help Protect Windows Automatically screen.
- 6 Follow the remaining screen prompts to complete the setup process.
- 7 Click **Start** when the Thank You message appears.

The Windows® operating system checks the system's performance, and then may restart your computer.

Registering your computer with Toshiba

Product registration is strongly recommended, and allows Toshiba to send you periodic updates, announcements, and special offers applicable to your product. Product registration can be completed by either visiting the Toshiba Web site at <http://www.register.toshiba.com>, or by double-clicking the **Toshiba Resources** icon on your desktop and then double-clicking **Toshiba Registration**. Failure to complete Product Registration will not diminish Customer rights under the Toshiba standard limited Warranty.

NOTE

To register online, you must be connected to the Internet.

Adding optional external devices

NOTE

Before adding external devices or memory, Toshiba recommends setting up your software. See “[Setting up your software](#)” on page 45.

After starting your computer for the first time you may want to:

- ❖ Add more memory (see “[Adding memory \(optional\)](#)” on page 52)
- ❖ Connect a mouse (see “[Using a mouse](#)” on page 75)
- ❖ Connect a full-size keyboard (see “[Using an external keyboard](#)” on page 75)
- ❖ Connect an external monitor (see “[Using external display devices](#)” on page 73)
- ❖ Connect a local printer (see “[Connecting a printer](#)” on page 76)
- ❖ Connect an optional external disk drive (see “[Connecting an optional external diskette drive](#)” on page 77)
- ❖ Install PC Cards (see “[Using PC Cards](#)” on page 136)

Connecting to a power source

Your computer requires power to operate. Use the power cord/cable and AC adaptor to connect the computer to a live electrical outlet, or to charge the computer's battery.

▲ WARNING

Never pull on a power cord/cable to remove a plug from a socket. Always grasp the plug directly. Failure to follow this instruction may damage the cord/cable, and/or result in a fire or electric shock, possibly resulting in serious injury.

▲ WARNING

Always confirm that the power plug (and extension cable plug if used) has been fully inserted into the socket, to ensure a secure electrical connection. Failure to do so may result in a fire or electric shock, possibly resulting in serious injury.

Be careful if you use a multiple connector. An overload on one socket could cause a fire or electric shock, possibly resulting in serious injury.

▲ WARNING

Always use the TOSHIBA AC adaptor that was provided with your computer and the TOSHIBA Battery Charger (that may have been provided with your computer), or use AC adaptors and battery chargers specified by TOSHIBA to avoid any risk of fire or other damage to the computer. Use of an incompatible AC adaptor or Battery Charger could cause fire or damage to the computer possibly resulting in serious injury. TOSHIBA assumes no liability for any damage caused by use of an incompatible adaptor or charger.

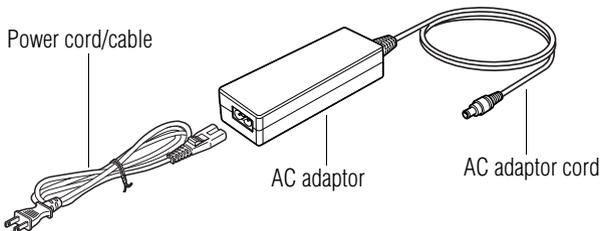

(Sample Illustration) Power cord/cable and AC adaptor

To connect AC power to the computer:

- 1 Connect the power cord/cable to the AC adaptor.

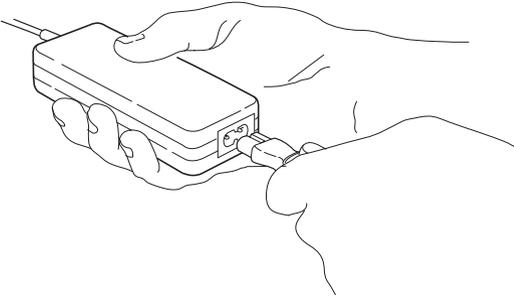

(Sample Illustration) Connecting the power cord/cable to the AC adaptor

⚠ WARNING

Handling the cord on this product will expose you to lead, a chemical known to the State of California to cause birth defects or other reproductive harm. **Wash hands after handling.**



- 2 Plug the AC adaptor cord into the DC-IN on the back of the computer.

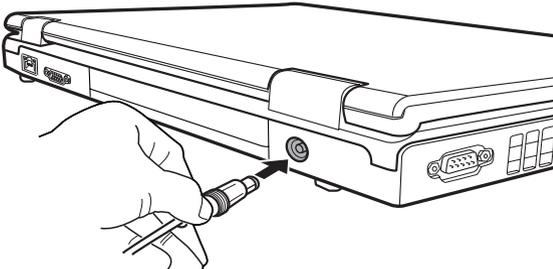

(Sample Illustration) Connecting the AC adaptor cord to the computer

- 3 Connect the power cord/cable to a live electrical outlet.



The AC power light on the indicator panel glows green.

⚠ WARNING

Never attempt to connect or disconnect a power plug with wet hands. Failure to follow this instruction could result in an electric shock, possibly resulting in serious injury.

The computer's main battery light gives you an indication of the main battery's current charge:

- ❖ Glows amber while the main battery is being charged (AC adaptor connected)
- ❖ Glows green when the main battery is fully charged
- ❖ Is unlit when the main battery has discharged, the battery is not charging, or the AC adaptor is not plugged into the computer or AC outlet
- ❖ Flashes amber when the main battery charge is low and it is time to recharge the main battery or plug in the AC adaptor

NOTE

If the AC power light flashes amber during charging, either the main battery is malfunctioning, or it is not receiving correct input from the AC power supply.

Disconnect the AC power cord/cable and remove the main battery pack. See [“Changing the main battery” on page 119](#) for information on replacing the main battery.

Charging the main battery

Before using the battery to power the computer, you must charge the battery.

To charge the battery, leave the computer plugged into an AC power source with the computer turned off until the battery light glows green. After that, the battery will be completely charged and ready to power the computer.

CAUTION

Once the battery is charged for the first time, avoid leaving the computer plugged in and turned off for more than a few hours at a time. Continuing to charge a fully charged battery can damage the battery.



TECHNICAL NOTE: The recharging of the battery cannot occur when your computer is using all of the power provided by the AC adaptor to run applications, features, and devices. Your computer's Power Options utility can be used to select a power level setting that reduces the power required for system operation and will allow the battery to recharge.

NOTE

Battery life and charge time may vary depending on the applications, power management settings, and features used.

Using the computer for the first time

The computer is now ready for you to turn it on and begin using it.

Opening the display panel

- 1 Facing the front of the computer, locate the center of the display panel.
- 2 Gently raise the panel.
- 3 Adjust the display to a comfortable viewing angle.

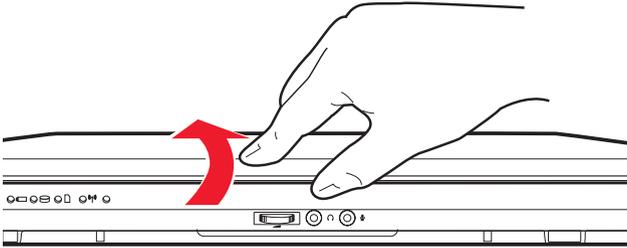

(Sample Illustration) Opening the display panel

NOTE

When opening or closing the display panel, place one hand on the palm rest to hold the computer in place and use the other hand to slowly open or close the display panel.

CAUTION

To avoid damaging the display panel, do not force it beyond the point where it moves easily and never lift the computer by the display panel.

Do not press or push on the display panel and be careful to remove any pens or other objects from the keyboard area before closing the panel.

Small bright dots may appear on your screen display when you turn on your computer. Your display contains an extremely large number of thin-film transistors (TFT) and is manufactured using high-precision technology. Any small bright dots that may appear on your display are an intrinsic characteristic of the TFT manufacturing technology. Over a period of time, and depending on the usage of the computer, the brightness of the screen will deteriorate. This is also an intrinsic characteristic of the screen technology. When the computer is operated on battery power, the screen will dim and you may not be able to increase the brightness of the screen while on battery power.

Your computer's features and specifications

Certain computer chassis are designed to accommodate all possible configurations for an entire product Series. Your select model may not have all the features and specifications corresponding to all of the icons or switches shown on the computer chassis, unless you have selected all those features.

This information applies to all the features and icons described in this guide.

Below are examples of some of the many possible icons used on your computer:



(Sample Illustration) System icons

Turning on the power

To turn on the computer:

- 1 Make sure any external devices (such as the AC adaptor, if you plan to use AC power rather than battery power) are properly connected and ready.
- 2 Check to ensure that all optical drives are empty.



- 3 Press and release the power button. The on/off light glows green.

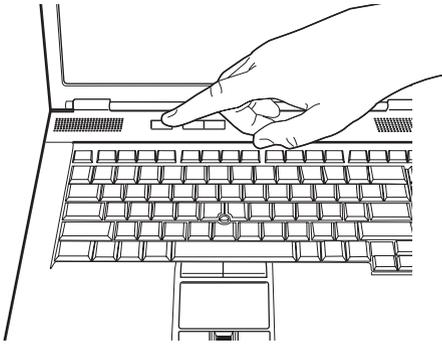

(Sample Illustration) Turning on the power

The preinstalled operating system will load automatically.

CAUTION

When you turn on the computer for the first time, do not turn off the power again until the operating system has loaded completely.

Adding memory (optional)



HINT: To purchase additional memory modules, see the accessories information packaged with your system or visit accessories.toshiba.com.

Your computer comes with enough memory to run most of today's popular applications. You may want to increase the computer's memory if you use complex software or process large amounts of data.

NOTE

Before adding external devices or memory, Toshiba recommends setting up your software. See "Setting up your software" on page 45.

Installing a memory module

Memory modules can be installed in the memory module slots on the base of the computer. You will need a small Phillips screwdriver for this procedure.

CAUTION If the computer has been running recently, the memory module may be hot. The surrounding area may also be hot. Allow the module to cool to room temperature before replacing it. Avoid touching the cover, the module, and the surrounding area before they have cooled. Failure to follow these directions could result in minor bodily injury.

CAUTION To avoid damaging the computer's screws, use a small Phillips screwdriver that is in good condition.

CAUTION Installing a memory module with the computer's power on may damage the computer, the module, or both.

The computer has two memory slots—Slot A and Slot B. You can install one or two memory modules.

CAUTION Before you install or remove a memory module, turn off the computer using the Start menu. If you install or remove a memory module while the computer is in Sleep or Hibernation mode, data will be lost.

NOTE For this model Slot A is the bottom slot. Slot B is the top slot. If only one memory module is to be installed, it must be installed in Slot A.

If the computer is on, begin at step 1; otherwise, skip to step 3.

- 1 Click **Start**, and then click the arrow next to the lock button in the lower-right corner of the Start menu.

The Shut Down menu appears.

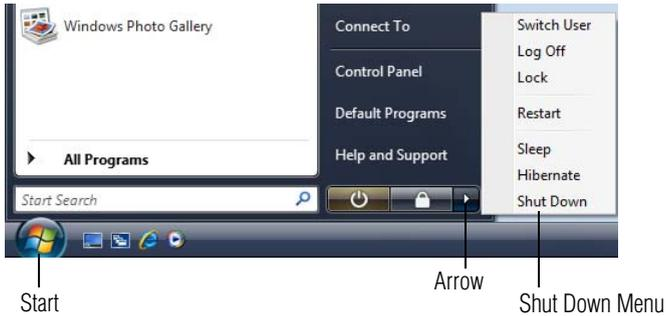

(Sample Image) Shut Down menu

- 2 Click **Shut Down**.
The operating system turns off the computer.
- 3 Unplug and remove any cables connected to the computer, including the AC adaptor.
- 4 Remove the main battery. For information on removing the main battery, see “[Removing the battery from the computer](#)” on page 119.
- 5 Close the display panel and turn the computer upside down to locate the memory module slot cover.

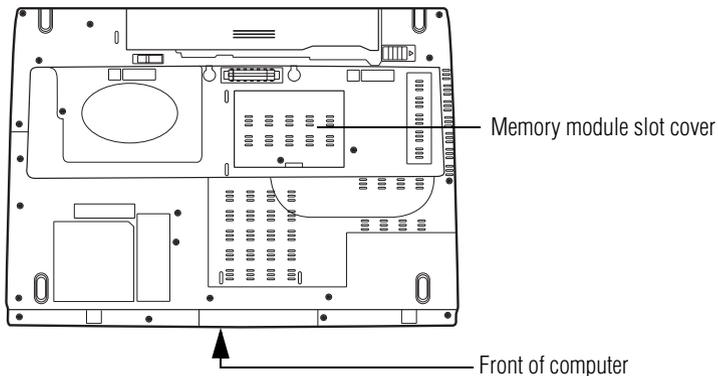

(Sample Illustration) Locating the memory module slot cover

- Using a small Phillips screwdriver, loosen the captive screw that secures the memory module slot cover.

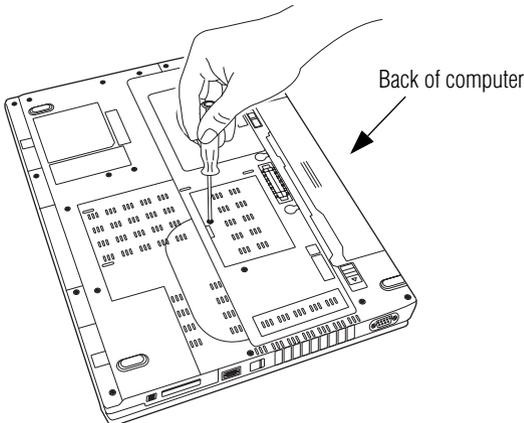

(Sample Illustration) Removing the memory module slot cover

- Remove the memory module slot cover.
- Place the screw and the cover in a safe place so that you can retrieve them later.

CAUTION

Static electricity can damage the memory module. Before you handle the module, touch a grounded metal surface to discharge any static electricity you may have built up.

CAUTION

Avoid touching the connector on the memory module or on the computer. Grease or dust on the connector may cause memory access problems.

- Carefully remove the new memory module from its antistatic packaging, without touching its connector.
- Locate an empty memory module slot on the underside of the computer.

NOTE

If no memory slot is available, you must remove a module by performing steps 2-3 of [“Removing a memory module”](#) on page 58.

NOTE

If your system has the memory modules stacked on top of one another, you must remove the top module first before removing/installing the bottom module.

NOTE

For this model Slot A is the bottom slot. Slot B is the top slot. If only one memory module is to be installed, it must be installed in Slot A.

- 11** Pick up the memory module by its sides, avoiding any contact with its connector. Position the module toward the socket, aligning the connector's notch with the matching key in the socket.

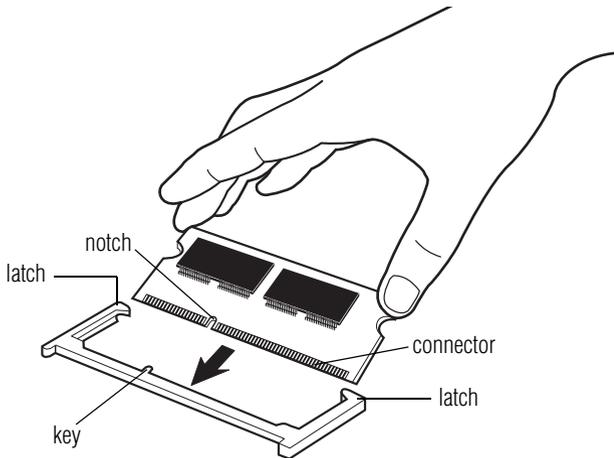

(Sample Illustration) Aligning the memory module with the socket

- 12** Firmly press the memory module into the memory slot's socket at approximately a 30-degree angle (to the horizontal surface of the computer).

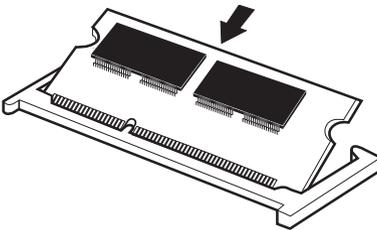

(Sample Illustration) Inserting the memory module into the socket

- 13** Once the module's connector is fully inserted into the socket, press downward on the top edge of the module to seat the module into the latches at the sides of the socket. These latches should “snap” into place securely with the corresponding cutouts in the side of the module. If the latches and cutouts do not line up correctly, repeat steps 12-13.

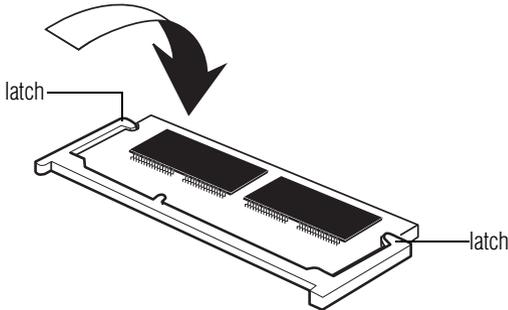

(Sample Illustration) Pressing down on the memory module

Do not force the memory module into position. The memory module should be completely inserted into the socket and level when secured in place.

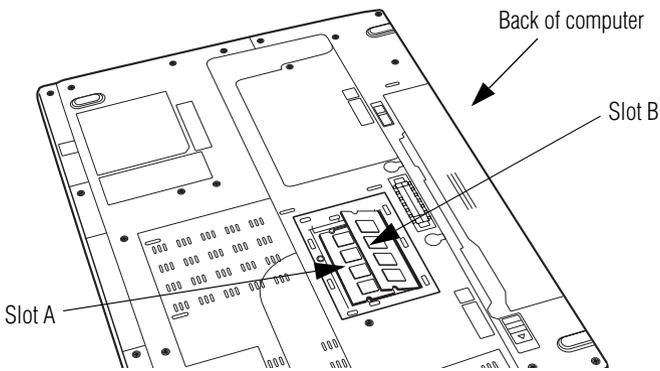

(Sample Illustration) Inserting the memory module into the slot

NOTE

For this model Slot A is the bottom slot. Slot B is the top slot. If only one memory module is to be installed, it must be installed in Slot A.

- 14 Replace the memory module slot cover and secure it using the screw.
 - 15 Re-insert the main battery. For more information on inserting the main battery, see [“Inserting a charged battery” on page 121](#).
 - 16 Turn the computer right side up.
 - 17 Reconnect the cables.
 - 18 Restart the computer.
-



TECHNICAL NOTE: You must have at least one memory module installed for the computer to work.

You can now continue setting up the computer. When the operating system has loaded, you can verify that the computer has recognized the additional memory module.

If you are adding extra memory after setting up the computer, verify that the computer has recognized it correctly as described in [“Checking total memory” on page 60](#).

Removing a memory module

If you need to remove a memory module:

- 1 Complete steps 1–8 in [“Installing a memory module” on page 53](#) to shut down the computer and open the memory module slot cover.

CAUTION

Do not try to remove a memory module with the computer turned on. You can damage the computer and the memory module.

Do not remove the memory module while the computer is in Sleep or Hibernation mode. The computer could hang up the next time you turn it on and data in memory will be lost. In either of the above cases, the Sleep configuration will not be saved.

NOTE

The following screen may appear when you turn on the power:

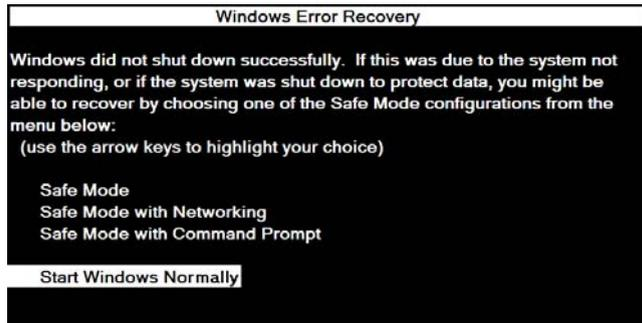

If "Start Windows® Normally" is highlighted, then press Enter.

If one of the Safe Mode options is highlighted, it is best to press Enter to go into Safe Mode, then shut down and restart the system, at which time Windows® should boot back up normally.

When Safe Mode is suggested, this could be a sign that you may need to scan your internal storage drive for errors or defragment the drive. If so, consult Windows® Help and Support.

- 2 Pull the latches away from the memory module.

The memory module pops up slightly.

NOTE

If your system has the memory modules stacked on top of one another, you must remove the top module first before removing/installing the bottom module.

- 3 Gently lift the memory module to a 30-degree angle and slide it out of the slot.

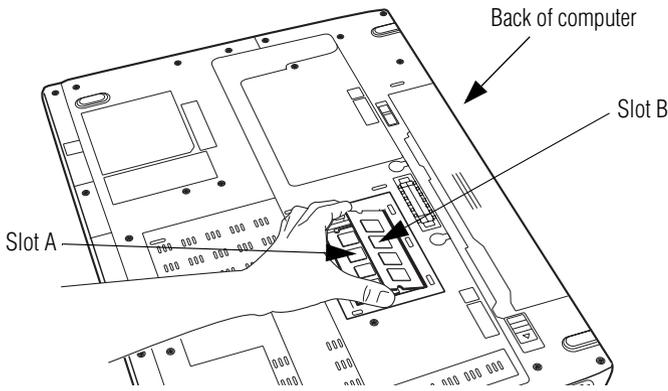

(Sample Illustration) Removing the memory module

- 4 Replace the memory module slot cover and secure it using the screw.
- 5 Re-insert the main battery. For more information on inserting the main battery, see [“Inserting a charged battery” on page 121](#).
- 6 Turn the computer right side up.
- 7 Reconnect the cables.
- 8 Restart the computer.



TECHNICAL NOTE: You must have at least one memory module installed for the computer to work.

Checking total memory

When you add or remove a memory module, you can check that the computer has recognized the change. To do this:

- 1 Click **Start, Control Panel, System and Maintenance**, and then **System**.
The **System** window appears.
- 2 The total memory is displayed below the System heading under **Memory (RAM)**.

If the computer does not recognize the memory configuration, turn off the computer and remove the memory module slot cover (complete steps 1-8 in [“Installing a memory module” on page 53](#)), and then check that the module is inserted completely into the socket and lined up squarely with the socket latches.

NOTE

From time to time, Windows® will display a pop-up that says, “Windows® needs your permission to continue.” This is a security feature to prevent programs or people from doing things on your computer without your permission. If you were trying to perform the action, click Continue; otherwise, click Cancel. If unsure, cancel and try again.

Hard Drive Recovery Utilities

Your computer has been configured with a hard disk partition to allow you to recover your hard disk drive or reinstall selected applications and software features or utilities.

NOTE

- ❖ During the HDD Recovery Process it is strongly recommended that your computer be connected to an external power source via the AC Adaptor.
 - ❖ It is also strongly recommended that you create recovery DVDs before using your system. For more information on creating Recovery media see [“Creating Recovery DVDs” on page 62](#).
-

Using the HDD Recovery, you can:

- ❖ Create Hard Drive Recovery DVDs using a writable drive.
- ❖ Recover your hard disk drive to the factory-set default.
- ❖ Recover just your C: drive, leaving any other partitions you may have created intact, for example, a D: drive.
- ❖ Recover your hard disk drive to the factory-set default without the HDD Recovery partition.
- ❖ Reinstall drivers and applications which were bundled with your computer.

Creating Recovery DVDs

Depending on your system configuration, you may be able to copy the hard drive recovery to DVD which gives you the ability to recover your hard disk drive and recover your system if the hard drive recovery partition has been deleted or the hard disk has been replaced on your computer.

NOTE

The system will prompt you to insert the appropriate number of blank DVDs to copy the hard drive recovery. If your optical disc drive is not writable, contact Toshiba Customer Support to obtain the Recovery media for your system.

The Toshiba Customer Support Center in the United States is (800) 457-7777, outside the United States it is (949) 859-4273.

To create recovery DVDs:

- 1 Click **Start, All Programs, Toshiba, Recovery**, and then **Recovery Disc Creator**.
- 2 Select **DVD** (to create Recovery media on DVDs).
- 3 Select the items you want to copy by clicking the check box next to the item's Name—recovery files, applications (original bundled drivers and applications), or both the recovery files and applications.
- 4 Click **Create**.
- 5 Insert the first blank DVD into your writable optical drive when prompted.
- 6 Follow the on-screen prompts for completing the copy process.

For more information on using the Recovery media you have created with the preceding steps see [“Hard Disk Drive Recovery using the Recovery media”](#) on page 68.

Hard Disk Drive Recovery options

The following are the available hard disk drive recovery options:

- ❖ Recovering the original factory image (recommended recovery method)
- ❖ Hard Disk Drive Recovery using the recovery partition
- ❖ Erasing the hard disk
- ❖ Recovering the C: partition of the HDD without changing the current partition size
- ❖ Recovering the C: partition with a user specified size
- ❖ Hard Disk Drive Recovery using the Recovery media
- ❖ Checking the HDD operating status

Hard Disk Drive Recovery using the recovery partition

NOTE

During the HDD Recovery Process it is strongly recommended that your computer be connected to an external power source via the AC Adaptor.

You have the options of recovering your system using the Hard Drive Recovery partition to the factory-set default, or recovering just your C: drive and leaving other partitions (for example, a D: drive) intact, or changing the size of your C: drive and then recovering it.

To recover your hard disk drive using the utilities stored on your computer's HDD:

- 1** Make sure the computer is turned off.
- 2** Press and hold the 0 (zero) key on your keyboard while powering on the computer.

- 3 If your system offers a choice of Windows Vista® 32-bit or 64-bit operating system, select one at this time. If not skip to step 4.

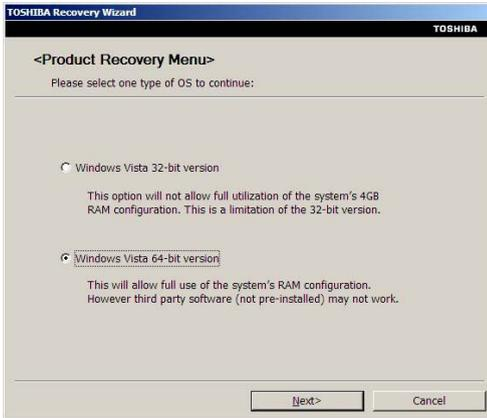

(Sample Image) Product Recovery Menu screen

- 4 When the Toshiba Recovery Wizard screen displays, select one of the options and then click **Next**. The options are:
 - ❖ Recovery of Factory Default Software
 - ❖ Erase the hard disk

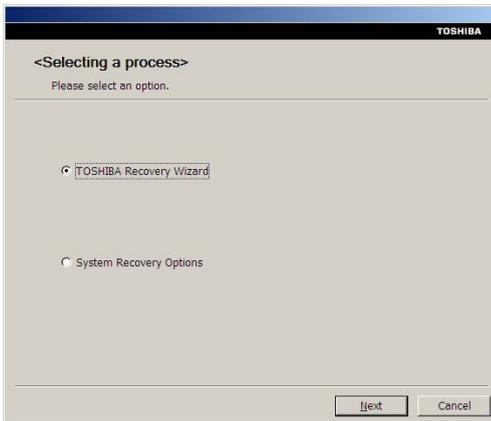

(Sample Image) Toshiba Recovery Wizard screen

Recovering the original factory image (recommended recovery method)

CAUTION

Recovering a hard disk drive to its out of box state deletes all partitions on the hard disk drive and your information will be lost. Be sure to save your work to external media first.

- 1 On the Toshiba Recovery Wizard screen, select **Recovery of Factory Default Software**, and then click **Next**.

The Recovery of Factory Default Software screen appears.

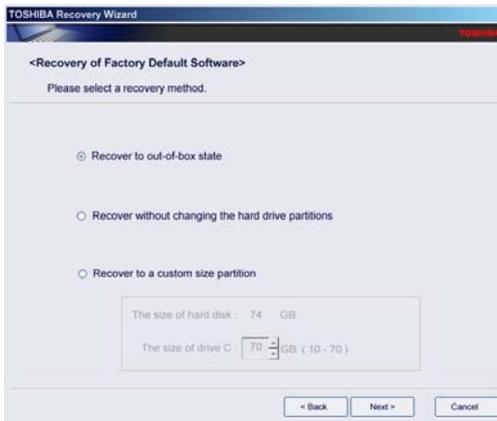

(Sample Image) Recovery of Factory Default Software screen

- 2 Select **Recover to out-of-box-state**, and then click **Next**.

A confirmation message displays reminding you that all data will be lost during the recovery process. Be sure to save your work to external media before proceeding.

- 3 Click **Next** to begin the recovery.

Once complete, a message displays that the HDD has been recovered.

- 4 Press any key on the keyboard to restart the computer.

Erasing the hard disk

CAUTION

Erasing the hard disk will delete all data including the partitions. Be sure to create recovery DVDs and back up your data to external media before erasing the hard disk.

The Recovery Wizard allows you to delete all data and partitions from the hard disk.

To delete the data and partitions from your hard disk:

- 1 On the Toshiba Recovery Wizard screen, select **Erase the hard disk**, and then click **Next**.
- 2 The next screen lists the two methods you can choose:
 - ❖ **Delete all data and partitions from the hard disk**—This option deletes all of the data on the hard disk without overwriting the HDD.
 - ❖ **Delete all partitions and overwrite all sectors on the hard disk**—This option deletes all data, then overwrites the entire HDD for security purposes. This may take several hours, depending on the size of your HDD.

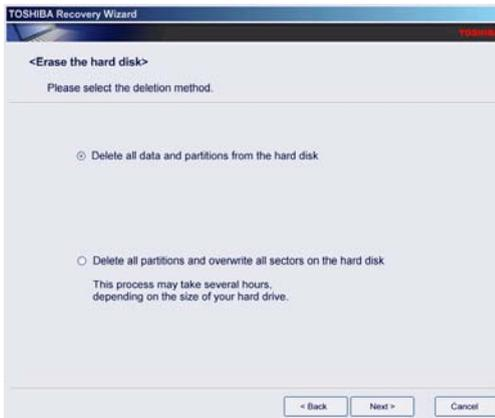

(Sample Image) Erase the hard disk screen

-
- 3 Select the desired method, and then click **Next**.

A confirmation message displays reminding you that all data will be lost. Be sure you have saved your work to external media before proceeding.

- 4 Click **Next** to begin deleting the HDD.

When the process is completed, a message displays informing you that the HDD has been deleted.

- 5 Press any key on the keyboard to restart the computer.

Recovering the C: partition of the HDD without changing the current partition size

CAUTION

Recovering the C: drive to its factory default setting reformats your drive and your information on the recovered drive will be lost. Be sure to save your work to external media first. If you have created other partitions (for example, a D: drive) those partitions and any information on them will not be affected and will remain intact.

To recover only your C: drive:

- 1 On the Toshiba Recovery Wizard Screen, select **Recovery of Factory Default Software**, and then click **Next**.
- 2 Select **Recover without changing the hard drive partitions**.

A confirmation message appears, reminding you that all information on the C: drive will be lost during the recovery process. Be sure you have saved your work to external media before proceeding.

- 3 Click **Next** to begin the restoration.

Once complete, a message displays that the HDD has been recovered.

- 4 Press any key on your keyboard to restart the computer.

Recovering the C: partition with a user specified size

CAUTION

Resizing and recovering your C: drive to its factory default setting reformats all partitions on the HDD (for example, if you created a D: drive, it will be deleted during the recovery process) and your information will be lost. Be sure to save your work to external media first.

To resize and recover your C: drive:

- 1 On the Toshiba Recovery Wizard screen, select **Recovery of Factory Default Software**, and then click **Next**.
 - 2 Select **Recover to a custom size partition**.
 - 3 Specify the size of the C: drive. Click the up/down arrows to increase/decrease the C: drive size in 1 GB increments.
-

NOTE

The size of the C: drive will display on the progress bar as you make your selections.

- 4 Click **Next** to begin the restoration. Once complete, a message displays that the HDD has been recovered.
- 5 Press any key on your keyboard to restart the computer.

Hard Disk Drive Recovery using the Recovery media

If you need to recover your computer to its default factory state, you can rebuild the system using your Hard Drive Recovery Utilities.

To recover your hard disk drive using the utilities burned to DVDs (refer to “[Creating Recovery DVDs](#)” on page 62):

- 1 Insert the first recovery DVD into your optical drive and power on the computer.
- 2 When the initial screen displays, press F12.
The boot menu appears.
- 3 Using the arrow keys, select the **DVD** option and press Enter.

- 4 The Selecting a Process Screen will appear. Select one of the options and then click **Next**. The options are:
- ❖ Toshiba Recovery wizard
 - ❖ System Recovery Options

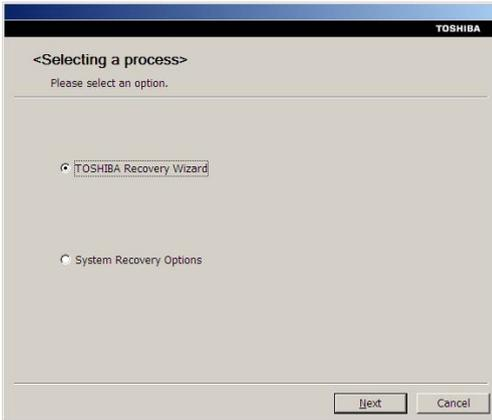

(Sample Image) Selecting a Process screen

- 5 If your system offers a choice of Windows Vista[®] 32-bit or 64-bit operating system, select one at this time. If not skip to step 6.

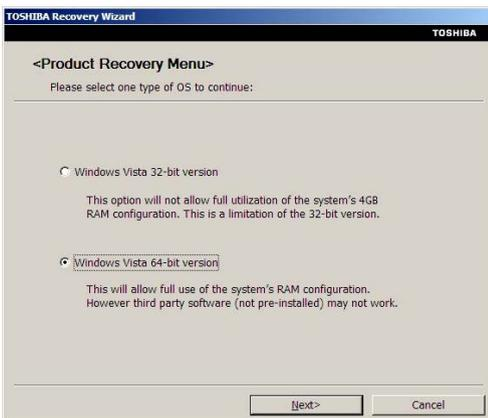

(Sample Image) Product Recovery Menu screen

- 6 A warning screen will appear stating that when the recovery is executed all data will be deleted and rewritten. Click **Yes** to continue.



(Sample Image) Warning screen

- 7 The Toshiba Recovery Wizard screen will appear. Please refer to [“Hard Disk Drive Recovery options”](#) on page 63 to explain the available recovery options.

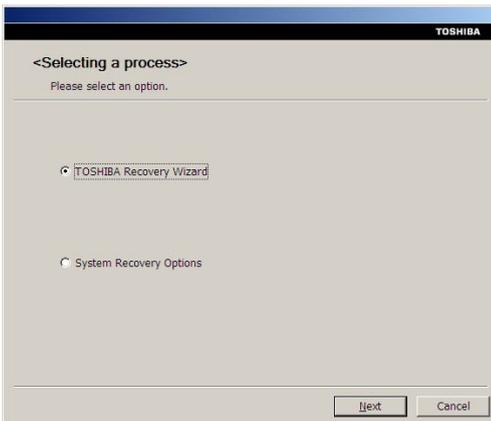

(Sample Image) Toshiba Recovery Wizard screen

Checking the HDD operating status

After restoring your hard disk drive, you can check its status as follows:

- 1 Click **Start**.
- 2 Right-click **My Computer**.
- 3 Select **Manage**.
- 4 Click **Disk Management**.
- 5 Highlight the hard disk drive in the Volume list to display its status in the lower portion of the screen.

Installing drivers and applications

The Toshiba Application Installer allows you to reinstall the drivers and applications that were originally bundled with your computer.

To reinstall drivers and applications:

- 1 Click **Start, All Programs, Toshiba, Recovery**, and then **TOSHIBA Application Installer**.
- 2 Click **Next**.
- 3 Click the item you want to install.
- 4 Click **Install**.
- 5 Follow the on-screen prompts to complete the installation process.

Using the Toshiba Dual Pointing Device

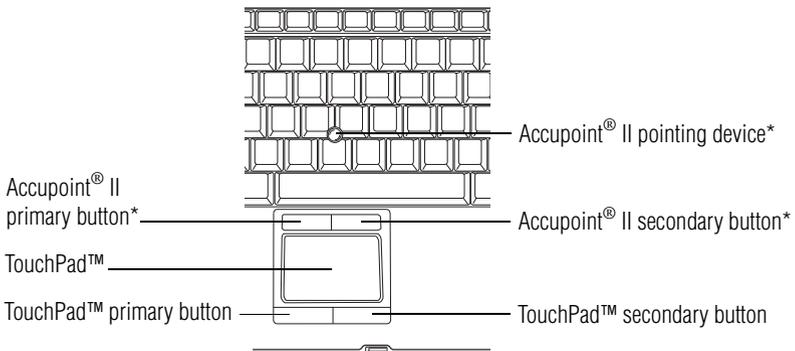

*Available on certain models

(Sample Illustration) Toshiba Dual Pointing Device buttons

Accupoint® II pointing device—Moves the cursor and selects items on the screen. **(Available on certain models).**

To move the cursor, gently push the pointing device in the direction you want the cursor to move. Pushing harder on the pointing device moves the cursor faster.

Primary button—Performs the same function as the left button on a mouse.

When a step instructs you to click or choose an item, move the cursor to the item, then press and release the primary button. To double-click, press the primary button twice in rapid succession.

Secondary button—Performs the same function as the right button on a mouse.

For more information, see “[Disabling or enabling the Toshiba Dual Pointing Device](#)” on page 223.

Using the TouchPad™

The TouchPad™, the small, rectangular area located in front of the keyboard, is sensitive to touch and enables you to move the cursor with the stroke of a finger. Simply move your finger on the TouchPad in the direction you would like to move the cursor:

- ❖ To move the cursor to the top of the page, push your finger forward on the TouchPad.
- ❖ To move the cursor to the bottom of the page, drag your finger toward yourself.
- ❖ To move the cursor to the right side of the page, slide your finger across the TouchPad from left to right.
- ❖ To move it to the left side, slide your finger from right to left.

NOTE

Because the TouchPad is much smaller than the display screen, moving your cursor across the screen often means having to move your finger several times across the TouchPad in the preferred direction.

Once you have positioned your cursor, you can click it into place by either double-tapping the TouchPad or clicking the control buttons.

Scrolling with the TouchPad™

There are two active regions on the TouchPad™ that allow you to scroll as you would with any wheel device on a mouse or trackball.

To scroll vertically, run your finger up or down along the right edge of the TouchPad. To scroll horizontally, run your finger along the bottom edge of the TouchPad. This feature can be disabled or changed in the Mouse Properties dialog box.

Control buttons

When a step instructs you to click or choose an item, move the cursor to the item, then press and release the primary (left-hand) button. To double-click, press the primary button twice in rapid succession. The primary button usually corresponds to the left mouse button.

The function of the secondary (right-hand) button depends on the program you are using. It usually corresponds to the right mouse button (“right-clicking”). Check your program’s documentation to determine whether it uses the right mouse button.

Disabling or enabling the TouchPad™

The TouchPad™ is enabled by default. To change the enable/disable TouchPad setting, press Fn + F9. This hot key enables/disables the TouchPad. For more information, see [“Disabling or enabling the Toshiba Dual Pointing Device”](#) on page 223.

Using external display devices

Your computer comes with a built-in display, but you can also connect an external monitor or projector via the RGB (monitor) port.

Connecting an external monitor or projector

You can easily attach an external monitor or projector to your computer if you need a larger screen. To do this:

- 1 Read the directions that came with the monitor to see if you first need to install new software.
- 2 Connect the monitor’s video cable to the RGB (monitor) port on the back of the computer.
- 3 Connect the device’s power cable to a live electrical outlet.



- 4 Turn on the external device.
Your computer will automatically detect the external display device and activate a screen with display options.
 - 5 Select the settings you desire and click **Apply**.
 - 6 Click **OK**.
-

NOTE

In the future you can change the display settings by pressing Fn+F5, or by configuring the display properties settings.

Directing the display output when you turn on the computer

Once you have connected an external display device, you can choose to use the internal display only, the external device only, or both simultaneously.

NOTE

Some modes are only available with the appropriate device attached and turned on.

The quickest way to change the display output settings is to use the display hot key (Fn + F5):

- 1 Press Fn and F5 simultaneously.
- 2 While holding down Fn, press F5 repeatedly until the setting you want takes effect. Briefly pause each time you press the F5 key to allow time for the display to change.

This hot key cycles through the settings in the following order (the last two options are available if an external monitor is connected):

- ❖ LCD—Internal display only
- ❖ LCD + CRT—Internal display and external monitor simultaneously
- ❖ CRT—External monitor only
- ❖ LCD + CRT Multi Monitor—Internal display and external monitor, with one acting as the primary display and the other as an extended desktop

- ❖ Swap—Switch primary display between internal display and external monitor when using extended desktop



(Sample Image) Display options window

- 3 Release the Fn key.

Adjusting the quality of the external display

To obtain the best picture quality from your television (or other video display device), you may need to adjust the video settings. See the video device documentation for additional configuration steps.

Using an external keyboard

If you prefer to use a full-size keyboard, you can attach one to your computer. The computer's USB ports support most USB-compatible keyboards.

Using a mouse

You may want to use a mouse instead of the computer's built-in TouchPad. You can use a USB-compatible mouse.

Connecting a printer

NOTE

Your printer documentation may require you to install the printer software before physically connecting the printer to your computer. If you do not install the software as instructed by the printer manufacturer, the printer may not function correctly.

Read the documentation that came with your printer. Follow the manufacturer's instructions when connecting a printer.

You can connect a USB-compatible printer to your computer through the USB ports. To determine if the printer is USB-compatible, check its documentation.

To make the connection, you need a suitable USB cable which may come with your printer. If a USB cable was not included with your printer, you can purchase one from a computer or electronics store.

If your printer supports Plug and Play, your computer may automatically recognize the printer; the printer is then ready for use. Refer to your printer documentation for further instructions.



TECHNICAL NOTE: To determine if your printer supports Plug and Play, check its documentation.

If your printer does not support Plug and Play, you can set up the printer as described in [“Setting up a printer” on page 76](#).

To connect a printer to your computer:



- 1** Connect the printer cable to the printer and then connect the other end to one of the computer's USB ports.
- 2** Plug the printer's power cable into a live AC outlet.

Setting up a printer

NOTE

Some printers require a specific installation process. Refer to your printer installation guide for instructions before completing the following procedure.

If your printer does not support Plug and Play, follow these steps to set it up for the first time. You only need to set up the printer once.

- 1 Click **Start, Control Panel, Hardware and Sound**, and then under **Printers**, click **Add a printer**.

The Add Printer Wizard appears.

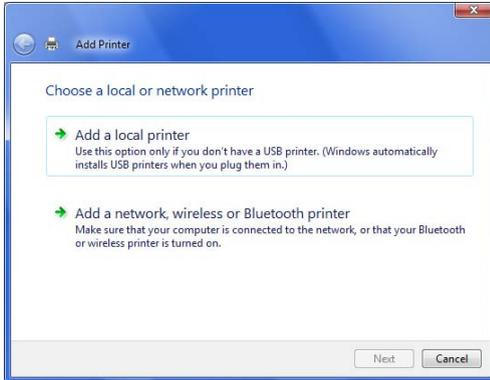

(Sample Image) Add Printer Wizard

- 2 Follow the on-screen instructions to set up your printer.

Connecting an optional external diskette drive

Some operations, such as creating a password service diskette, require a diskette drive designed for use with 3.5-inch diskettes.

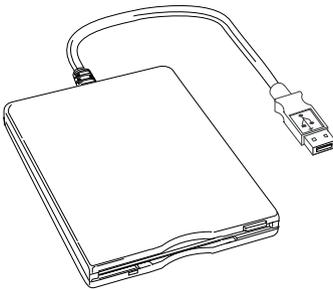

(Sample Illustration) Optional external USB diskette drive

To connect an optional external USB diskette drive, connect the cable to one of the computer's USB ports.

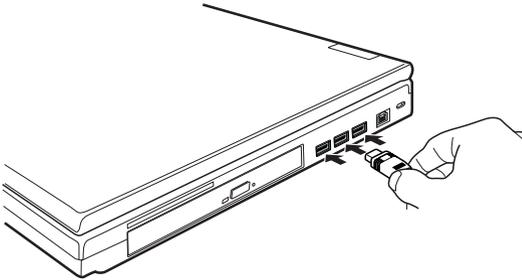

(Sample Illustration) Connecting an optional external USB diskette drive

Turning off the computer

CAUTION

Pressing the power button before shutting down the Windows® operating system could cause you to lose your work. Make sure the system indicator panel's storage drive light and the drive-in-use light are off. If you turn off the power while a disk/disc is being accessed, you may lose data or damage the disk/disc and/or drive.

It is a good idea to turn off your computer when you are not using it for a while.

If you are using the computer for the first time, leave the computer plugged into a power source (even though the computer is off) to fully charge the main battery.

Options for turning off the computer

Depending on the operating system installed, you have more than one option available for turning off the computer: Shut Down, Hibernate, and Sleep. Each option has its advantages.

- ❖ Use the Shut Down or Hibernate command if you will not be using the computer for several days or if you must turn off your computer.

You must turn off your computer in order to upgrade your computer's internal hardware (such as memory).



TECHNICAL NOTE: Before using the Shut Down option to turn off your computer, save your files and make sure all disk/disc activity lights are off.

If you change your mind and decide to continue working after all, wait a few seconds before turning the computer on again.

- ❖ Use the Sleep command to save your work, system settings, and current state of the desktop to memory, so that when you turn on the computer again, you will quickly and automatically return to where you left off.

Hibernation mode

Hibernation mode shuts the computer down completely, but it first saves the current state of the computer to the internal storage drive. Since Hibernation mode does not require power to maintain the saved information, system settings are retained indefinitely.

Factors to consider when choosing Hibernation:

- ❖ While in Hibernation mode, the computer uses no main battery power.
- ❖ Because the state of the system is stored to the internal storage drive, no data is lost if the main battery discharges.
- ❖ Restarting from Hibernation takes less time and consumes less main battery power than restarting after turning off the computer using the Shut down command.
- ❖ Restarting from Hibernation takes a little more time and consumes more main battery power than restarting from Sleep.
- ❖ When starting up again, the computer returns to the state in which you left it, including all open programs and files you were using.

For information on how to use and configure Hibernation mode see [“Using and configuring Hibernation mode”](#) on page 83.

Sleep mode

The Sleep command places the computer into a power-saving mode. Sleep saves the current state of the computer to memory so that, when you restart the computer, you can continue working from where you left off.

NOTE

After your computer sleeps for an extended period of time, the Windows® operating system may save any open documents and programs to your internal storage drive, and then shuts down the computer.

Factors to consider when choosing Sleep:

- ❖ While in Sleep mode, the computer uses some main battery power.
 - ❖ Because the state of the system is stored in memory, you will lose data if the main battery discharges while the computer is in Sleep mode.
 - ❖ Restarting from Sleep takes less time and consumes less main battery power than restarting after turning off the computer using the Hibernation or Shut down commands.
 - ❖ When starting up again, the computer returns to the mode in which you left it, including all open programs and files you were using.
 - ❖ If the battery charge becomes critically low, the computer will try to enter Hibernation mode.
-

CAUTION

If you power down using the Sleep command and the main battery discharges fully, your unsaved information will be lost. Be sure to save your work first.

For information on using Sleep, see [“Using and configuring Sleep mode” on page 85](#).

Using the Shut Down command

The Shut down command completely shuts down the computer without saving your work or the current state of the computer. This command closes all open programs, shuts down the operating system, and then turns off your computer.

Use the following steps to turn off your computer using the Shut Down command:

- 1 Click **Start**, and then click the arrow next to the Lock button in the lower-right part of the Start menu.

The Shut Down menu appears.

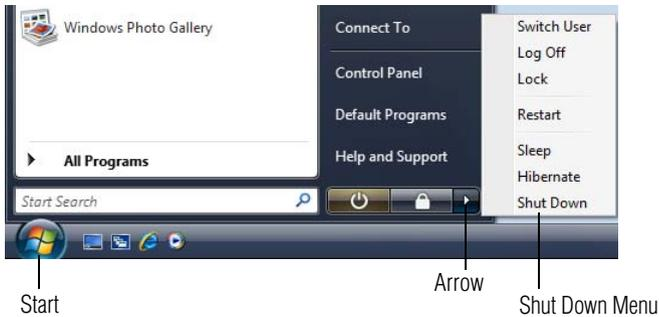

(Sample Image) Shut Down menu

- 2 Click **Shut Down**.

The computer closes all open programs, shuts down the operating system, and then turns off.

Turning off the computer more quickly

You can also turn off the computer by pressing the power button.

To use this method, you first need to activate it using the Power Options feature. By default, pressing your computer's power button puts the computer into Sleep mode.



- 1 Click **Start**, **Control Panel**, **System and Maintenance**, and then **Power Options**.

The Power Options window appears.

- 2 Click **Change plan settings** under the power plan to be customized.

The Edit Plan Settings window appears.

3 Click **Change advanced power settings**.

The Advanced settings tab of the Power Options window appears.

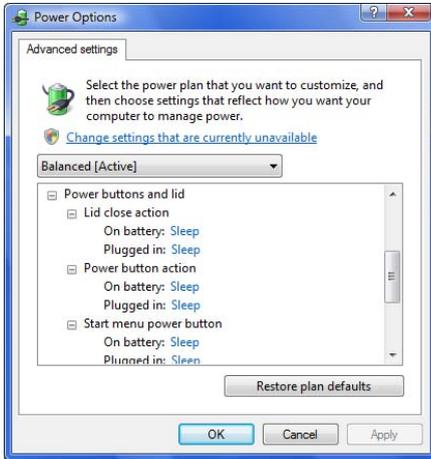

(Sample Image) Advanced settings tab of Power Options screen

- 4** Click **Power buttons and lid** to display the actions that you can configure.
- 5** Select the options you want from the drop-down lists.

NOTE

These options can be set separately for how they operate while the computer is running on battery power or while connected to AC power.

- ❖ **Lid close action**
Set this option to **Shut down** if you want the computer to shut down when you close the display panel.
- ❖ **Power button action**
Set this option to **Shut down** if you want the computer to shut down when you press the power button.
- ❖ **Start menu power button**
Set this option to **Shut down** if you want the computer to shut down when you click the power button in the Start menu.

6 Click **Apply**.

7 Click **OK**.

Once the computer is configured, you can turn it off by either pressing the power button or closing the display panel, depending on the options set.

Restarting your computer

To start the computer up again, press the power button until the on/off light glows green.

If you turn off the computer by closing the display panel, you can start it again by opening the display panel.

Using and configuring Hibernation mode

To turn off the computer using the Hibernation command:

1 Click **Start**, and then click the arrow next to the Lock button in the lower-right part of the Start menu.

The Shut Down menu appears.

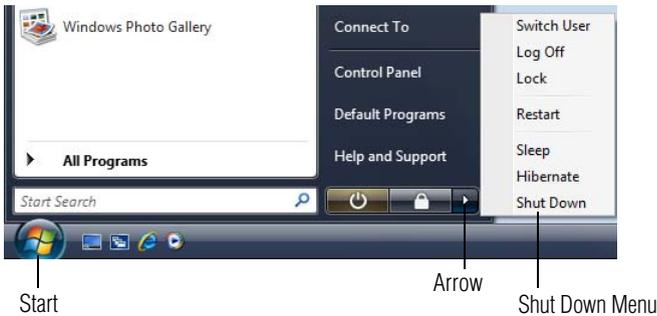

(Sample Image) Shut Down menu

2 Click **Hibernate**.

The computer saves the state of all open programs and files, turns off the display, and then turns off.

Configuring Hibernation mode options

You can place the computer into Hibernation mode by either pressing the power button or closing the display panel. You can also specify an amount of time after which the computer automatically goes into Hibernation mode.

To use any of these methods, you first need to enable them using the Power Options feature.



- 1 Click **Start, Control Panel, System and Maintenance**, and then **Power Options**.

The Power Options window appears.

- 2 Click **Change plan settings** under the power plan to be customized.

The Edit Plan Settings window appears.

- 3 Click **Change advanced power settings**.

The Advanced settings tab of the Power Options window appears.

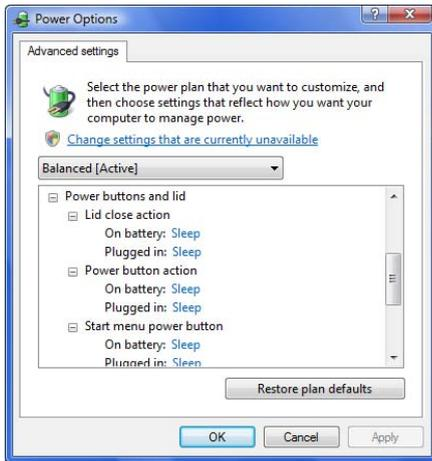

(Sample Image) Advanced settings tab of Power Options screen

- 4 Click **Power buttons and lid** to display the actions that you can configure.
- 5 Select **Hibernate** for the options you want.

NOTE

These options can be set separately for how they operate while the computer is running on battery power or while connected to AC power.

- ❖ **Lid close action**
Set this option to **Hibernate** if you want the computer to go into Hibernation mode when you close the display panel.

❖ Power button action

Set this option to **Hibernate** if you want the computer to go into Hibernation mode when you press the power button.

❖ Start menu power button

Set this option to **Hibernate** if you want the computer to go into Hibernation mode when you click the power button in the Start menu.

6 Click **Apply**.

7 Click **OK**.

Once the computer is configured, you can place it into Hibernation mode by either pressing the power button or closing the display panel, depending on the Hibernation options set.

Starting again from Hibernation mode

To start up the computer from Hibernation mode, press the power button until the on/off light glows green. The computer returns to the screen(s) you were using.

If you put the computer in Hibernation mode by closing the display panel, you can start it again by opening the display panel.

Using and configuring Sleep mode

To turn off the computer using the Sleep command:

1 Click **Start**, and then click the arrow next to the Lock button in the lower-right part of the Start menu.

The Shut Down menu appears.

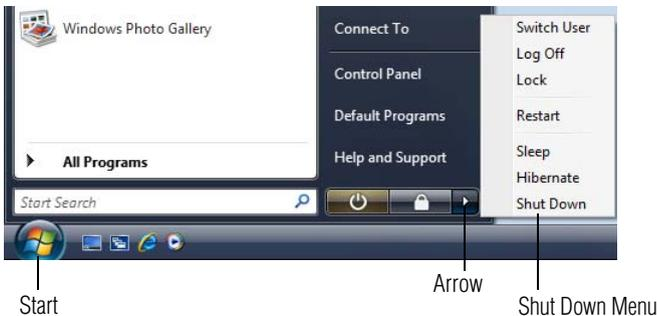

(Sample Image) Shut Down menu

2 Click **Sleep**.

The computer saves the status of all open programs and files to the memory, turns off the display, and enters into a low-power mode. The on/off light blinks amber indicating the computer is in Sleep mode.

Configuring Sleep mode options

You can place the computer into Sleep mode by either pressing the power button or closing the display panel. You can also specify an amount of time after which the computer automatically goes into Sleep mode.

To use any of these methods, you first need to enable them using the Power Options feature.

**1** Click **Start, Control Panel, System and Maintenance**, and then **Power Options**.

The Power Options window appears.

2 Click **Change plan settings** under the power plan to be customized.

The Edit Plan Settings window appears.

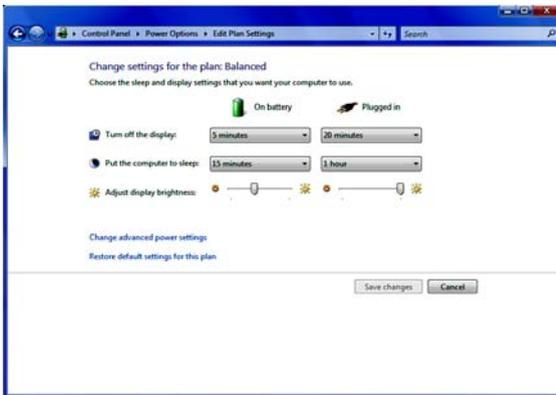

(Sample Image) Edit Plan Settings screen

3 To change the amount of time after which the computer enters Sleep mode:

- ❖ Under **Put the computer to sleep**, select the desired amount of time in both the **On battery** and **Plugged in** categories.

- ❖ To disable the computer from automatically entering Sleep mode, select **Never**.

4 Click **Change advanced power settings**.

The Advanced settings tab of the Power Options window appears.

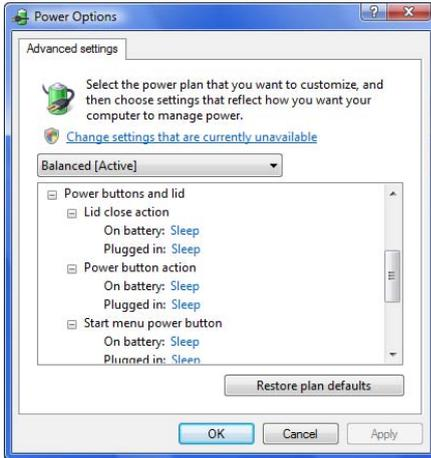

(Sample Image) Advanced settings tab of Power Options screen

- 5 Click **Power buttons and lid** to display the actions that you can configure.
- 6 Select **Sleep** for the options you want.

NOTE

These options can be set separately for how they operate while the computer is running on battery power or while connected to AC power.

- ❖ **Lid close action**
Set this option to **Sleep** if you want the computer to go into Sleep mode when you close the display panel.
- ❖ **Power button action**
Set this option to **Sleep** if you want the computer to go into Sleep mode when you press the power button.
- ❖ **Start menu power button**
Set this option to **Sleep** if you want the computer to go into Sleep mode when you click the power button in the Start menu.

7 Click **Apply**.

8 Click **OK**.

Once the computer is configured, you can place it into Sleep mode by either pressing the power button or closing the display panel, depending on the Sleep options set.

Starting again from Sleep mode

To start up the computer from Sleep mode, press the power button until the on/off light glows green. The computer returns to the screen(s) you were using.

If you place the computer in Sleep mode by closing the display panel, you can start it again by opening the display panel.

Closing the display panel

After you have turned off the computer, close the display panel to keep dust and dirt out of the computer.

Customizing your computer's settings

There are several ways in which you can customize your computer to suit your particular requirements. Refer to your operating system documentation or Help and Support for details.

You may also wish to customize your power usage settings. For more information, see [“Power Plans” on page 117](#). There are additional custom settings you can choose. See [“Utilities” on page 142](#).

Caring for your computer

This section gives tips on cleaning and moving your computer. For information about taking care of your computer's battery, see [“Taking care of your battery” on page 122](#).

NOTE

Please handle your computer carefully to avoid scratching or damaging the surface.

Cleaning the computer

CAUTION

Keep liquids, including cleaning fluid, out of the computer's keyboard, speaker, and other openings. Never spray cleaner directly onto the computer and/or display. Never use harsh or caustic chemical products to clean the computer.

To keep your computer clean, gently wipe the display panel and exterior case with a lightly dampened cloth.

Moving the computer

Before moving your computer, even across the room, make sure all drive activity has ended (the drive indicator light stops glowing) and all external peripheral cables are disconnected.

CAUTION

Do not pick up the computer by its display panel or by the back (where the ports are located). Doing so could damage the system.

Using a computer lock

You may want to secure your computer to a heavy object such as your desk. The easiest way to do this is to purchase an optional computer lock cable. For more information on purchasing a cable lock, visit accessories.toshiba.com.

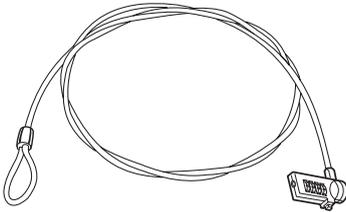

(Sample Illustration) Computer lock cable

To secure the computer:

- 1 Wrap the cable through or around some part of a heavy object. Make sure there is no way for a potential thief to slip the cable off the object.

- 2 Pass the locking end through the loop.
- 3  Insert the cable's locking end into the security lock slot on your computer, then engage the locking device.

The computer is now securely locked.

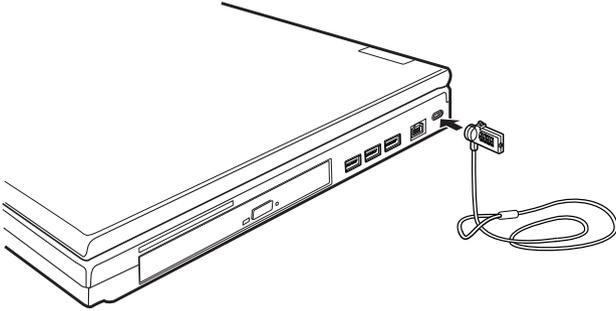

(Sample Illustration) Attaching security lock cable

Chapter 2

Learning the Basics

This chapter gives some computing tips and provides important information about basic features.

Computing tips

- ❖ Save your work frequently.

Your work stays in the computer's temporary memory until you save it to the internal storage drive. If the network you are using goes down and you must restart your computer to reconnect, or your battery runs out of charge while you are working, you will lose all work since you last saved.

See [“Saving your work” on page 98](#) for further information.



HINT: Some programs have an automatic save feature that can be activated. This feature saves your file to the internal storage drive at preset intervals. See your software documentation for details.

- ❖ Back up your files to disks (or other removable media) on a regular basis. Label the backup copies clearly and store them in a safe place.

It is easy to put off backing up because it takes time. However, if your internal storage drive suddenly fails, you will lose all the data on it unless you have a separate backup copy. For more information, see [“Data and system configuration backup in the Windows® operating system”](#) on page 202.

- ❖ Use Error-checking and Disk Defragmenter regularly to check and optimize disk space and improve performance.
- ❖ Scan all new files for viruses.

This precaution is especially important for files you receive via diskette, email, or download from the Internet.

- ❖ Take frequent breaks to avoid repetitive-motion injuries and eyestrain.
- ❖ Do not turn off the computer if a drive indicator light indicates a drive is active.

Turning off the computer while it is reading from or writing to a disk may damage the disk, the drive, or both.

- ❖ Before turning off the computer, use the Shut Down command or Sleep command. See [“Using and configuring Sleep mode”](#) on page 85 to learn more about Sleep.

NOTE

The Windows® operating system records information, such as your desktop setup, during its shutdown procedure. If you do not let the Windows® operating system shut down normally, details such as new icon positions may be lost.

Using the keyboard

Your computer's keyboard contains character keys, control keys, function keys, and special Windows® keys, providing all the functionality of a full-size keyboard.

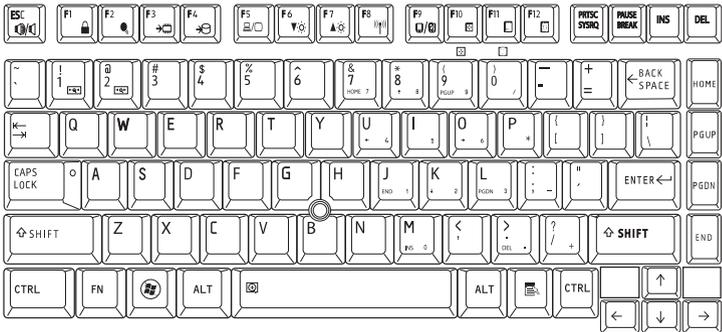

(Sample Illustration) Keyboard

Character keys

Typing with the character keys is very much like typing on a typewriter, except that:

- ❖ The space bar creates a space character instead of just passing over an area of the page.
- ❖ The lowercase letter l (el) and the number 1 are not interchangeable.
- ❖ The uppercase letter O and the number 0 are not interchangeable.

Making your keyboard emulate a full-size keyboard

Although your computer's keyboard layout is compatible with a standard full-size keyboard, it includes fewer keys.

A standard full-size keyboard includes two Enter, Ctrl, and Alt keys; editing keys; cursor positioning keys; and a numeric keypad.

Your computer's keyboard includes only one Enter key. Most of the time, this does not matter. However, some programs assign separate functions to the regular and numeric pad Enter keys on the full-sized keyboard. Using the Fn key, you can simulate the separate key, as follows: Press Fn and Enter simultaneously to simulate the Enter key on the numeric pad of the enhanced keyboard. Pressing the Fn key simultaneously in combination with one of the specially marked keys allows you to emulate a full-size keyboard.

Ctrl, Fn, and Alt keys



(Sample Illustration) Ctrl, Fn, and Alt keys

The Ctrl, Fn, and Alt keys do different things depending on the program you are using. For more information, see your program documentation.

Function keys

The function keys (not to be confused with the Fn key) are the 12 keys at the top of the keyboard.



(Sample Illustration) Function keys

F1 through F12 are called function keys because they execute programmed functions when pressed. Used in combination with the Fn key, function keys marked with icons execute specific functions on the computer. For example, Fn+F9 turns off the TouchPad. For more information, see [“Hot key functions” on page 214](#).

Special Windows® keys

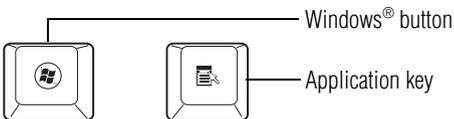

(Sample Illustration) Special Windows® keys

Your computer’s keyboard has one key and one button that have special functions in Windows®:

- ❖ **Windows® button**—Opens the Start menu
- ❖ **Application key**—Has a similar function as the secondary mouse button

Overlay keys

The keys with gray numbers and symbols on the front of them form the numeric and cursor overlay. This overlay lets you enter numeric data or control the cursor as you would using the 10-key keypad on a desktop computer's keyboard.

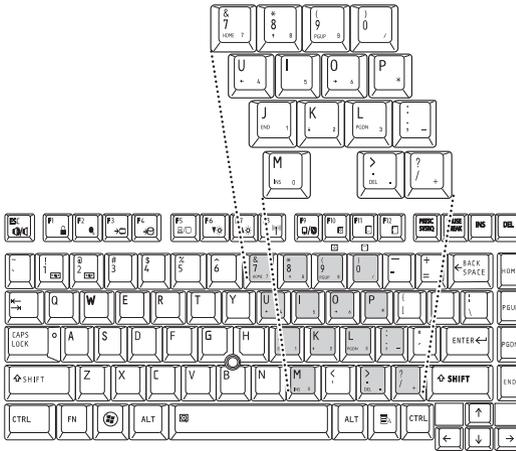

(Sample Illustration) Numeric and cursor control overlay

Using the overlay to type numeric data

The keys with the numbers on their right front are the numeric overlay keys.



To turn the numeric overlay on, press Fn and F11 simultaneously. The numeric mode light on the keyboard indicator panel glows when the numeric overlay is on.

To disable the numeric overlay, hold down the Fn key and press F11 again. The numeric mode light on the keyboard indicator panel goes out.

Using the overlay for cursor control

The keys with the gray arrows and symbols on their left front are the cursor control overlay keys.



To turn the cursor control overlay on, press Fn and F10 simultaneously. The cursor control mode light on the keyboard indicator panel glows when the cursor control overlay is on.

To disable the cursor control overlay, hold down the Fn key and press F10 again. The cursor control mode light on the keyboard indicator panel goes out.

Starting a program

The easiest way to start a program is to double-click the name of the file that contains the information you want to work on. To find the file, use the Start menu or Windows® Explorer.

If you prefer to open the program first, you have four options. You can:

- ❖ Double-click the icon for the program on your desktop
- ❖ Use the Start menu
- ❖ Use Windows® Explorer or the Start menu to locate the program file
- ❖ Use the Search or Start Search field in the Start menu

The next three sections explain how to start a program from the Start menu, Windows® Explorer and the Start Search field.

Starting a program from the Start menu

When you install a program, the operating system usually puts an icon in the All Programs menu. To start a program that has an icon in the All Programs menu, follow these steps, which use the Windows® WordPad program as an example:

- 1** Click **Start**, and then **All Programs**.

The Windows® operating system displays the All Programs menu, which lists programs and program groups. If your program is listed, go to step 3, otherwise, continue with step 2.

NOTE If you pause with your mouse on All Programs, it will open it up. You may need to scroll up or down to see the complete list.

- 2** Click the program group, in this example, **Accessories**.

The Accessories menu is displayed.

- 3** Click the program, in this example, **WordPad**.

WordPad opens.



To close the program, click the **Close** button in the upper-right corner of the program's window.

Starting a program from Windows® Explorer

If a program is not listed in the All Programs menu, you can start it from Windows® Explorer. Windows® Explorer gives you a view of your computer's contents as a hierarchy or "tree." You can easily see the contents of each drive and folder on your computer. To use this method, you should know the file name and location of the program's executable file (this file ends with .exe).

This example opens WordPad using Windows® Explorer.

- 1 Click **Start**, and then **All Programs**.

NOTE

If you pause with your mouse on All Programs, it will open it up. You may need to scroll up or down to see the complete list.

- 2 Click **Accessories**.
- 3 Click **Windows Explorer**.
- 4 In the left part of the window, double-click **Computer** to expand the window.
- 5 In the left part of the window, click the line that ends in "Local Disk (C:)."
- 6 In the left part of the window, under the Local Disk C: icon, double-click the folder containing the program, in this case **Program Files**.

Windows® Explorer shows the contents of the Program Files folder on the right side of the window. The left side of the window shows all the folders contained within the Program Files folder.

- 7 In the left part of the window, double-click **Windows NT**.
- 8 In the left part of the window, double-click **Accessories**.

Windows® Explorer shows the contents of the **Accessories** folder on the right side of the window.

- 9 In the right part of the window, double-click **wordpad**.

The operating system opens WordPad.



To close the program, click the **Close** button in the upper-right corner of the program's window.

Starting a program using the Start Search field

This example uses the Start menu's Start Search field to start WordPad:

- 1 Click **Start** to display the Start menu.

The Start Search field appears at the bottom of the Start menu.

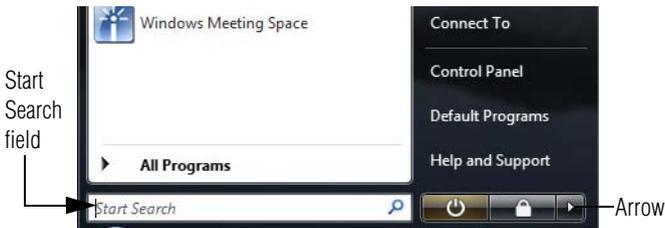

(Sample Image) Start Search field in Start menu

- 2 Start typing the program's name (wordpad) in the Start Search field.

As you type, all matching files and programs are displayed in the Start menu.

- 3 Click **WordPad** under Programs at the top left of the Start menu.

Saving your work

Before you turn off the computer using the Shut Down command, save your work on the internal storage drive, diskette, flash media, or optical disc. This is one of the most important rules of computing.

When you turn off the computer using the Sleep or Hibernate commands, your work should be there when you resume.

Many programs offer a feature that saves documents at regular intervals. Check your program's documentation to see if it has an automatic save feature.

Saving files

- 1 In your Windows®-based application, click **File**, and then **Save**.
- 2 Click **Browse folders**.

If you are working with a document that already has a file name, this is all you need to do. If you created a new document, your program displays a Save As dialog box.

Use this dialog box to specify where to store the document and to give it a file name.

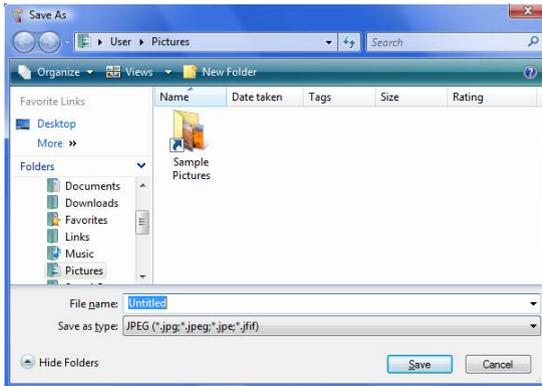

(Sample Image) Save As dialog box

- 3 Choose the drive and folder where you want your file to be stored.
- 4 Type a file name, then click **Save**.



HINT: To make another copy of the file you are currently working with, click **File**, and then **Save As**, and give the new file a different name.

File names

The Windows® operating system supports long file names that can contain up to 260 characters and can include spaces. Some applications do not support long file names and require file names limited to no more than eight characters.

You may use all the letters, numbers, and other characters on the keyboard, except for these characters: \ / ? : * " > < |. File names are not case-sensitive.

Using a file extension

Most programs assign an extension to the file name that identifies the file as being created in the program with a particular format. For example, Microsoft® Word saves files with a .doc extension. Any file name with an extension of “.doc” is assumed to be a Microsoft® Word file. Creating your own extension is usually unwise, since the program is unlikely to recognize a strange extension and may refuse to handle your file correctly.



TECHNICAL NOTE: By default, the Windows® operating system does not show file extensions. For information on showing or hiding file extensions, see your Windows® online Help.

Printing your work

Ensure the operating system is set up for your printer as described in “Setting up a printer” on page 76.



HINT: You only need to set up the printer the first time you connect it. If you use more than one printer or are changing printers, you will need to set up the Windows® operating system to run with the additional printer(s).

To print a file:

- 1 If your printer is not on, turn it on now.
- 2 In your Windows®-based application, click **File**, and then **Print**.

The program displays a Print dialog box.

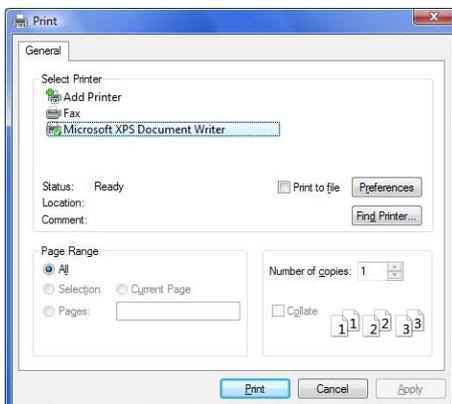

(Sample Image) Print dialog box

- 3 Specify the print parameters. For example, the range of pages and number of copies to print.
- 4 Click **Print**.

Backing up your work

Back up all the files you create in case something happens to your computer. You can back up your files to different types of media such as CDs, DVDs, diskettes, or to a network, if available.

To back up several files at one time, use the Microsoft® Windows® backup program preinstalled on the computer's internal storage drive. Also see [“Backing up your data or your entire computer with the Windows® operating system”](#) on page 204.



HINT: Backing up all the files on your internal storage drive may take a considerable amount of time and multiple CDs/DVDs. You may prefer to use a high-capacity backup system, such as an external hard drive.

Small files can be backed up on diskettes if an optional external diskette drive is available.

Restoring your work

To restore information from your backup media to your internal storage drive, use the Restore page in the backup program. Look in the online Help or your operating system documentation for information on restoring files.



TECHNICAL NOTE: When restoring files, the backup program prompts you if you try to overwrite a file that already exists on the internal storage drive. Make sure the backup version is the one you want before overwriting the existing file.

Using the optical drive

Optical storage has become the preferred medium for software, music, and video. Digital versatile discs (DVDs) provide a significant increase in data storage and support features that were not available on previous video platforms. These features include wide-screen movies, multiple language tracks, digital surround sound, multiple camera angles, and interactive menus.

For these reasons, your computer may come with an optical drive.



TECHNICAL NOTE: Your optical drive is set to play region 1 (North America) DVD-ROMs. If you play a DVD disc from another region, the drive will automatically change to play in the format of the other region. The drive will allow you to change regions four times. On the fourth change, the region will be “locked in.” That is, the drive will only play DVDs from that last region. Note that changing from region 1 to region 2 and back to region 1 is counted as two changes.

NOTE

For optimum DVD performance, it is recommended that you play DVDs while running the computer on AC power.

NOTE

When viewing DVD movies use the DVD Player software that came with your computer.

Optical drive components

The optical drive is located on the side of the computer.

Your optical drive may look like this:

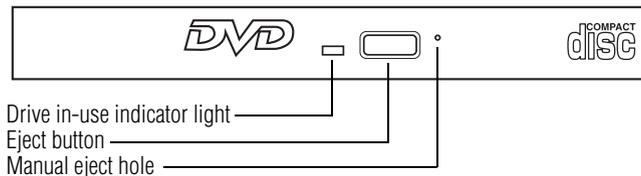

(Sample Illustration) Optical drive

Drive in-use indicator light—Indicates when the drive is in use.

Eject button—Press to release the disc tray.

CAUTION

Do not press the eject button or turn off the computer while the drive in-use indicator light is glowing. Doing so could damage the disc or the drive.

When the disc tray is open, be careful not to touch the lens or the area around it. Doing so could cause the drive to malfunction.

Manual eject hole—Use if you need to release the disc tray when the power is off. Use a straightened paper clip or other narrow object to press the manual eject button located inside the hole.

CAUTION

Never use a pencil to press the manual eject button. Pencil lead can break off inside the computer and damage it.

Inserting an optical disc

To insert an optical disc into the drive:

- 1 Make sure the computer is turned on.
The drive will not open if the computer's power is off.
- 2 Make sure the drive's in-use indicator light is off.
- 3 Press the drive's eject button.
The disc tray slides partially out of the drive (about 1 inch).
- 4 Grasp the tray and pull it fully open.

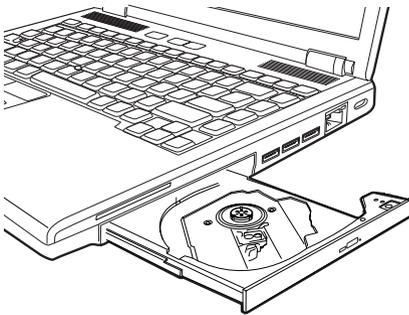

(Sample Illustration) Drive tray fully extended

- 5 Hold the disc by its edges and check that it is free of dust.
If the disc is dusty, clean it as described in “Caring for optical discs” on page 107.

- 6 Place the disc carefully in the disc tray, label side up.

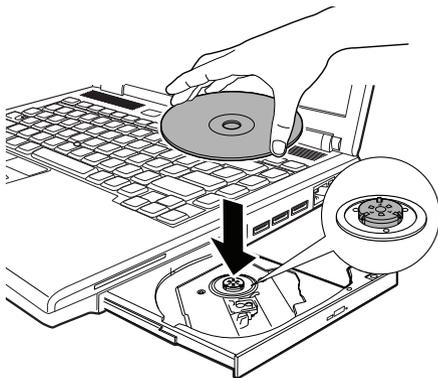

(Sample Illustration) Positioning the disc in the drive

- 7 Gently press the disc onto the center spindle until it clicks into place.

CAUTION

Handle DVDs and CDs carefully, making contact only with the center hole and edge. Do not touch the surface of the disc. Do not stack discs. If you incorrectly handle the discs, you could lose data.

- 8 Make sure the disc is completely on the spindle and is lying flat on the tray.

CAUTION

If you insert the disc incorrectly, it may jam the drive. If this happens, contact Toshiba support for assistance.

- 9 Push the disc tray in by pressing gently on the center of the tray until it clicks into place.

You are ready to use the disc.

Playing an audio CD

Insert an audio CD and close the disc tray.

If the computer is turned on, the default player opens.

- ❖ To play the CD or to pause, click the **Play/Pause** button.
- ❖ To stop the CD, click the **Stop** button.

CAUTION

Before putting on headphones to listen, turn the volume down. Do not set the volume too high when using headphones. Continuous exposure to loud sound can harm your hearing.

Playing optical media

If you insert an optical disc into the optical drive and the Auto-Run feature does not automatically start your disc, try launching the optical disc manually. To do this, follow these steps:

- 1 Click **Start**, and then **Computer**.
- 2 Click the optical drive icon.

The disc drive will run the optical disc.

If your disc does not run using this method, try using an application that is associated with the media on the disc. For example, if it is a music CD, open Windows Media® Player and use it to select and then play the CD. For other types of media, use the associated software to open the files on the disc.

Recording optical media

Depending on the configuration, your computer may come with an optical drive that allows you to:

- ❖ Play pre-recorded and recorded optical media.
- ❖ Read/write data and multi-media files to recordable optical media.

For more information regarding supported optical media formats please refer to your computer's detailed specifications at pcsupport.toshiba.com.

NOTE

Due to manufacturing and quality variations in third party optical media (e.g., CD or DVD) or optical media players/recorders, in certain cases, your Toshiba optical drive may not record on certain optical media that bear the applicable logo, or play back optical media recorded by other computers or optical media recorders. Additionally, certain optical media recorded on your optical drive may not play back or operate properly on other computers or optical media players. These problems are not due to any defect in your Toshiba computer or optical drive. Please refer to your computer's product specification for listing of specific format compatibilities.

Copy protection technology may also prevent or limit recording or viewing of certain optical media.

For details on how to use the software, please refer to the respective Online Help menus.

Removing a disc with the computer on

To remove an optical disc with the computer turned on:

- 1 Press the eject button on the drive.

CAUTION

Do not press the eject button while the in-use indicator light is glowing. Doing so could damage the disc or the drive.

Also, if the disc is still spinning when you open the disc tray, wait for it to stop spinning before you remove it.

- 2 Pull the tray out until it is fully open, remove the disc, and place it in its protective cover.
- 3 Gently press the tray in to close it.

Removing a disc with the computer off

To remove a disc with the computer turned off:

- 1 Insert a slender object, such as a straightened paper clip, into the manual eject hole.

The disc tray slides partially out of the drive (about 1 inch).

CAUTION

Never use a pencil to press the manual eject button. Pencil lead can break off inside the computer and damage it.

- 2 Pull the tray out until it is fully open, remove the disc, and place it in its protective cover.
- 3 Gently press the tray in to close it.

Caring for optical discs

- ❖ Store your discs in their original containers to protect them from scratches and keep them clean.
- ❖ Do not bend a disc or place heavy objects on top of it.
- ❖ Do not apply a label to, or otherwise mar the surface of, a disc.
- ❖ Hold a disc by its outside edge. Fingerprints on the surface can prevent the optical drive from reading the data properly.
- ❖ Do not expose discs to direct sunlight or extreme heat or cold.
- ❖ To clean a disc that is dirty, wipe it with a clean, dry cloth. The most efficient method to clean it is to start from the center of the disc and wipe toward the outward edge (not in a circle). If necessary, moisten the cloth with water or a neutral cleaner (not benzine or rubbing alcohol). Let the disc dry completely before inserting it in the drive.

Toshiba's online resources

Toshiba maintains a number of online sites to which you can connect. These sites provide information about Toshiba products, give help with technical questions and keep you up to date with future upgrades. For more information, see [“Contacting Toshiba”](#) on page 207.

Chapter 3

Mobile Computing

This chapter covers all aspects of using your computer while traveling.

Toshiba's energy-saver design

Your computer enters a low-power suspension mode when it is not being used, thereby conserving energy and saving money in the process. It has a number of other features that enhance its energy efficiency.

Many of these energy-saving features have been preset by Toshiba. We recommend you leave these features active, allowing your computer to operate at its maximum energy efficiency, so that you can use it for longer periods while traveling.

Your computer contains Toshiba EasyGuard®. The Toshiba EasyGuard* technology is made up of four foundational elements that incorporate hardware and software innovations into various Toshiba computers that address the most common security, reliability and connectivity issues faced by computer users:

- ❖ **EasyGuard Protect and Fix**—to fortify vital information and vulnerable components against the stress and hazards mobile computers face every day.
- ❖ **EasyGuard Secure**—to defend your data and your computer against loss, theft or viral attack.
- ❖ **EasyGuard Connect**—to help users establish a reliable wired or wireless connection effortlessly and quickly.
- ❖ **EasyGuard Optimize**—to enable users to customize system settings to be more productive.

*Toshiba EasyGuard® technology comprises a number of features some of which may or may not be available on a particular Toshiba computer depending on the model selected. See easyguard.toshiba.com for detailed information.

Running the computer on battery power

The computer contains a removable Lithium-Ion (Li-Ion) battery that provides power when you are away from an AC outlet. You can recharge it many times.

Battery Notice

Battery life may vary considerably from specifications depending on product model, configuration, applications, power management settings and features utilized, as well as the natural performance variations produced by the design of individual components. Published battery life numbers are achieved on select models and configurations tested by Toshiba at the time of publication. Recharge time varies depending on usage. Battery may not charge while the computer is consuming full power.

After a period of time, the battery will lose its ability to perform at maximum capacity and will need to be replaced. This is normal for all batteries. To purchase a new battery pack, see the accessories information included with your computer or visit the Toshiba Web site at accessories.toshiba.com. Use only batteries designed to work with your Toshiba computer.

To ensure that the battery maintains its maximum capacity, operate the computer on battery power at least once a month. The Lithium-Ion battery has no memory effect so it is not necessary to let the battery fully discharge each time. However, for better accuracy of the battery meter, it is helpful to fully discharge the battery periodically. Please see [“Maintaining your battery” on page 123](#) for procedures. If the computer is continuously operated on AC power, either through an AC adaptor or a port replicator (if applicable to your system), for an extended period (more than a month), the battery may fail to retain a charge. This may shorten the life of the battery, and may cause the battery meter to be inaccurate.

NOTE For optimum DVD performance, it is recommended that you play DVDs while running the computer on AC power. For more information about Windows® power plans, see [“Power Plans” on page 117](#).

The computer also has an internal real-time-clock (RTC) battery.

The RTC battery powers the RTC memory that stores your system configuration settings and the current time and date information. It maintains this information for up to a month while the computer is turned off.



TECHNICAL NOTE: Depending on your system, the RTC battery may only charge while the computer is turned on.

Power management

Your computer ships with the power management options preset to a configuration that will provide the most stable operating environment and optimum system performance for both AC power and battery modes.

CAUTION

Changes to these settings may result in system performance or stability issues. Users who are not completely familiar with the power management component of the system should use the preset configuration. For assistance with setup changes, contact Toshiba's Customer Support Center.

Using additional batteries

In addition to the main battery, you may also have an optional secondary battery (not included with your computer). If you travel and need to work for many hours without an AC power source, you may purchase a battery module for use in the computer, or carry additional charged battery packs with you. You can then replace a discharged battery and continue working.

For more information on batteries and accessories, see accessories.toshiba.com.

Charging batteries

The battery needs to be charged before you can use it to power the computer.

CAUTION

Never leave batteries in the battery charger for more than a week at a time. Doing so may reduce the potential charge of the battery.

Always use the battery charger specified by Toshiba. You can order a Toshiba battery charger from Toshiba's Web site at accessories.toshiba.com.

NOTE

Battery charge time may vary depending on the applications, power management settings, and features used.

Charging the main battery

To charge the main battery while it is in your computer, plug the computer into a live electrical outlet. The battery charges whether the computer is on or off.



TECHNICAL NOTE: The recharging of the battery cannot occur when your computer is using all of the power provided by the AC adaptor to run applications, features, and devices. Your computer's Power Options utility can be used to select a power level setting that reduces the power required for system operation and will allow the battery to recharge.

The battery may not start charging immediately under the following conditions:

- ❖ The battery is extremely hot or cold.

To ensure that the battery charges to its full capacity, wait until it reaches room temperature (50 to 80 degrees Fahrenheit, 10 to 26 degrees Celsius).

- ❖ The battery is almost completely discharged.

Leave the power connected and the battery should begin charging after a few minutes.



HINT: Once the battery is fully charged, we recommend that you operate your computer on battery power until the battery discharges completely. Doing this extends battery life and helps ensure accurate monitoring of battery capacity.

Charging the RTC battery

Your computer has an internal real-time clock (RTC) battery. The RTC battery powers the System Time Clock and BIOS memory used to store your computer's configuration settings. When fully charged, it maintains this information for up to a month when the computer is powered off.

The RTC battery may have become completely discharged while your computer was shipped, resulting in a CMOS error message during startup. The error message may vary by computer model.

NOTE

Depending on your system, the RTC battery may only charge while the computer is turned on.

If the RTC battery is low, the real-time clock and calendar may display the incorrect time and date, or stop working.

To recharge the RTC battery, plug the computer into a live electrical outlet and leave the computer powered on for 24 hours.

NOTE

It is seldom necessary to charge the RTC battery because it charges while the computer is on. If the RTC battery is low, the real-time clock and calendar may display the incorrect time and date or stop working.

When Hibernation mode is enabled and the RTC battery is completely discharged, a warning prompts you to reset the real-time clock.

The computer can be used while the RTC battery is being charged, although the charging status of the RTC battery cannot be monitored.

Monitoring main battery power



The computer's main battery light gives you an indication of the main battery's current charge.

- ❖ Glows amber while the main battery is being charged (AC adaptor connected).
 - ❖ Glows green when the main battery is fully charged.
 - ❖ Is unlit when the battery has discharged, the battery is not charging, or the AC adaptor is not plugged into the computer or AC outlet.
-

NOTE

Battery life and charge time may vary, depending upon power management settings, applications and features used.

- ❖ Flashes amber when the main battery charge is low and it is time to recharge the main battery or plug in the AC adaptor.
-

NOTE

If the AC power light flashes amber during charging, either a battery pack is malfunctioning, or it is not receiving correct input from the AC power supply.

Disconnect the AC power cord/cable and remove the battery pack. See [“Changing the main battery” on page 119](#) for information on replacing the main battery.



HINT: Be careful not to confuse the battery light (⎓) with the on/off light (⏻).

When the on/off light flashes amber, it indicates that the system is suspended (using the Windows® operating system Sleep command).

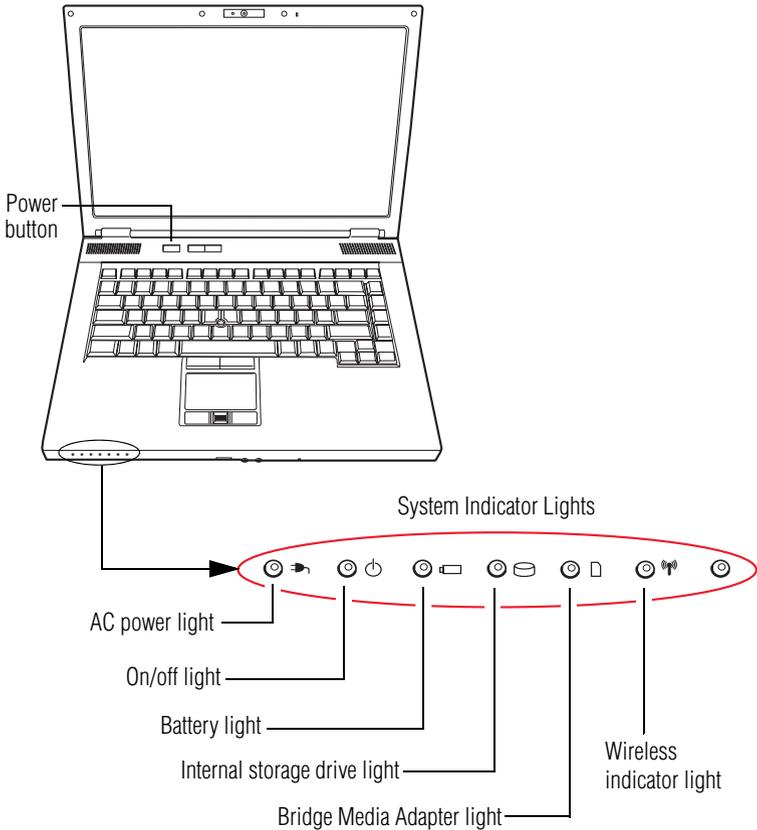

(Sample Illustration) Power and battery light locations

Determining remaining battery power

NOTE

Wait at least 16 seconds after turning on the computer before trying to monitor the remaining battery power. The computer needs this time to check the battery's remaining capacity and perform its calculations.



Highlight the power icon in the Notification Area. A pop-up message displays the remaining battery power as a percentage.

With repeated discharges and recharges, the battery's capacity gradually decreases. A frequently used older battery does not power the computer for as long as a new battery, even when both are fully charged.



TECHNICAL NOTE: The computer drains the battery faster at low temperatures. Check your remaining charge frequently if you are working in temperatures below 50 degrees Fahrenheit.

The computer calculates the remaining battery charge based on your current rate of power use and other factors such as the age of the battery.

What to do when the main battery runs low

When the main battery runs low you can:

- ❖ Plug the computer into an external power source and recharge the main battery
- ❖ Place the computer into Hibernation mode and replace the main battery with a charged spare (not included with your computer)
- ❖ Save your work and turn off the computer

If you do not manage to do any of these things before the main battery completely runs out of power, the computer automatically enters Hibernation mode and turns itself off. Hibernation mode keeps track of where you were, so that when you turn on the power again, you can continue where you left off.

If you have Hibernation mode enabled (the default), the computer copies the details of your open programs and files to the internal storage drive before shutting down. For more information on using Hibernation, see [“Hibernation mode” on page 79](#).

Setting battery notifications

You can set two notifications. Each notification can be set to alert you when a specified percentage of remaining battery power has been reached. You can also set the computer to enter Sleep mode or Hibernation mode or to completely power down when the notification goes off.

To change the default notification settings:

- 1 Click **Start, Control Panel, Mobile PC**, and then **Power Options**.

The Power Options window appears.

- 2 Click **Change plan settings** under the power plan to be customized.

The Edit Plan Settings window appears.

- 3 Click **Change advanced power settings**.

The Advanced settings tab of the Power Options window appears.

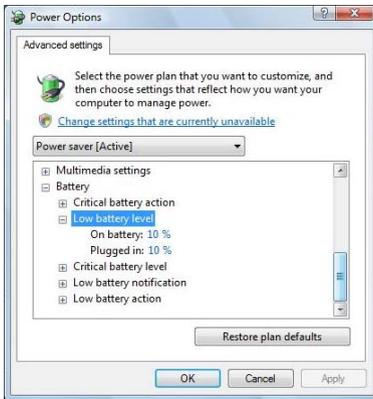

(Sample Image) Advanced settings tab of Power Options screen

- 4 Click **Battery** to display the battery options.
- 5 Configure the alarm settings to suit your needs.

Conserving battery power

How long a fully charged battery pack lasts when you are using the computer depends on a number of factors, such as:

- ❖ How the computer is configured
- ❖ How much you use the internal storage drive, optical drive, diskette drives, or other optional devices
- ❖ Where you are working, since operating time decreases at low temperatures

There are various ways in which you can conserve power and extend the operating time of your battery:

- ❖ Enable Sleep or Hibernation, which saves power when you turn off the computer and turn it back on again
- ❖ Use the Windows® power-saving option plans

These power-saving options control the way in which the computer is configured. By using them, you can increase the length of time you can use the computer before you need to recharge the battery.

Microsoft® has combined these options into preset Power Plans. Using one of these power plans lets you choose between maximum power savings and peak system performance. You may also set individual power-saving options to suit your own needs.

The following sections describe how to choose a Power Plan and discuss each power-saving option.

Power Plans

You can choose a predefined Power Plan or select your own combination of power options. To do this:

- 1 Click **Start, Control Panel, Mobile PC**, and then **Power Options**.

The Windows® Power Options window appears.

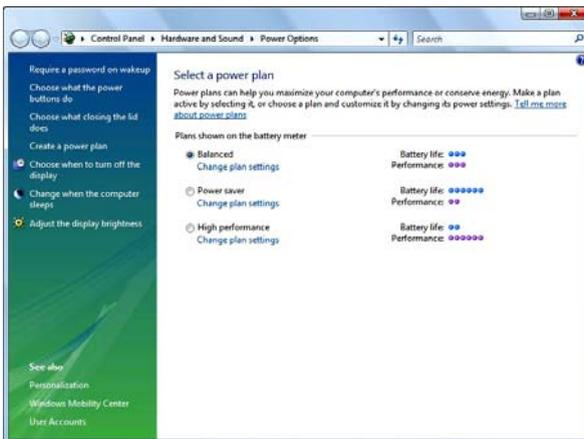

(Sample Image) Windows® Power Options window

- 2 Select an appropriate plan for your work environment or create your own custom plan.
- 3 Click **Create a Power Plan** to set up a new plan.

NOTE

To edit a plan or to edit advanced settings, continue to the following steps.

- 4 Click **Change Plan Settings** to choose the plan you want to edit.

This screen allows you to change basic settings.

- 5 Click **Change Advanced Settings** to access settings for battery notification levels, internal storage drive power save time, etc.

You can click on the plus signs to expand each item and to see what settings are available for each item.

- 6 Click **Save Changes** to save the plan changes you have performed.

By default the three power plans Balanced, Power Saver, and High Performance are satisfactory for most people and do not need to be edited. The Power Saver plan is the best used for maximum battery time. The High Performance plan will give you the shortest battery time, but the highest performance from your computer. The Balanced plan is a compromise between battery time and performance.

Using a hot key to set the Power Plan

You may use a hot key to set the Power Plan.

To set the Power Plan:

- 1 Press Fn and F2 simultaneously to display the Power Plan hot key card.



(Sample Image) Power Plan hot key card

- 2 While continuing to press Fn, press F2 until you select the desired Power Plan.

The Power Plan options are: Balanced, Power Saver, and High Performance.

- 3 Release the Fn key.

The hot key card disappears. You are now in the selected mode.

Changing the main battery

When your main battery has run out of power, you have two options: plug in the AC adaptor or install a charged main battery.

⚠ WARNING

Never short circuit the battery pack by either accidentally or intentionally bringing the battery terminals in contact with another conductive object. This could cause serious injury or fire, and could also damage the battery pack and computer.

- ❖ Never expose a battery pack to abnormal shock, vibration or pressure. The battery pack's internal protective device could fail, causing it to overheat or ignite, resulting in caustic liquid leakage, or explosion or fire, possibly resulting in death or serious injury.
-



TECHNICAL NOTE: To avoid losing any data, save your files and then either completely shut down your computer or put it into Hibernation mode before changing the main battery.

Removing the battery from the computer

To remove the battery:

- 1 Save your work.
- 2 Turn off the computer or place it in Hibernation mode according to the instructions in [“Using and configuring Hibernation mode”](#) on page 83.
- 3 Unplug and remove any cables connected to the computer, including the AC adaptor.
- 4 Close the display panel and turn the computer upside down.

- 5 Slide the primary battery release latch up, or away from the center of the computer, while at the same time applying light pressure to the battery to slightly pull it away from the computer.

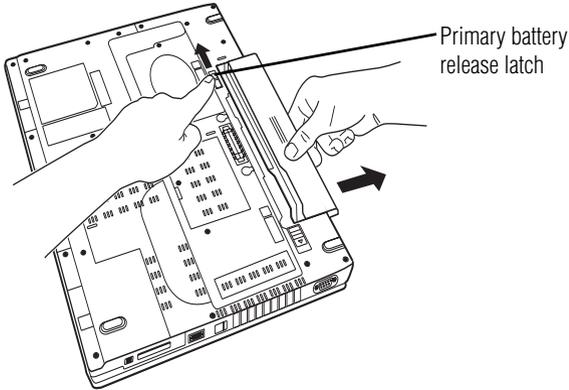

(Sample Illustration) Unlocking the primary battery release

- 6 While continuing to lightly pull on the battery, slide the secondary battery release latch down, or away from the center of the computer and then pull the battery out of the computer.

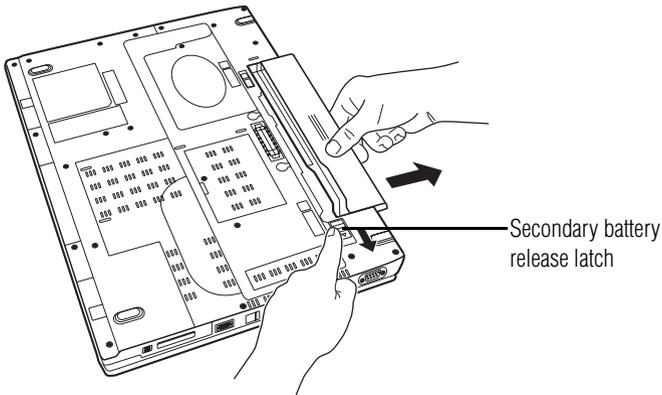

(Sample Illustration) Removing the battery

⚠ WARNING

If the battery is leaking or its case is cracked, put on protective gloves to handle it, and discard it immediately. Always dispose of used battery packs in compliance with all applicable laws and regulations. Put insulating tape, such as cellophane tape, on the electrode during transportation to avoid a possible short circuit, fire or electric shock. Failure to do so could possibly result in serious injury.

Inserting a charged battery

To insert a battery:

- 1 Wipe the terminals of the charged battery with a clean cloth to ensure a good connection.
- 2 Insert the charged battery into the slot until the latch clicks.

The battery pack has been designed so that you cannot install it with reverse polarity. Do not force the battery into position.

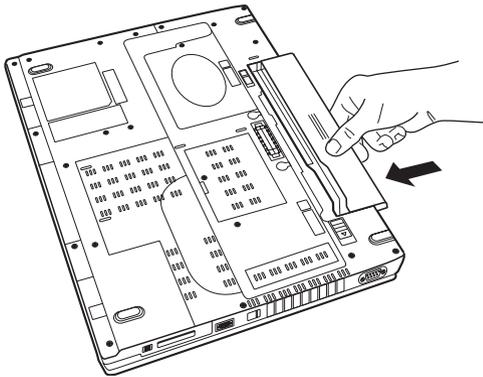

(Sample Illustration) Inserting the battery

- 3 Turn the computer right side up.
- 4 Reconnect any cables that were removed in step 3 of “Removing the battery from the computer” on page 119.
- 5 Restart the computer.

Taking care of your battery

The following sections offer tips on how to take care of your battery and prolong its life.

Safety precautions

- ❖ If the battery pack produces an odor, overheats or changes color or shape while it is being used or charged, turn off the computer's power immediately and disconnect the power cord/cable from the power socket. Carefully remove the battery pack from the computer.
- ❖ Do not try to disassemble a battery pack.
- ❖ Do not overcharge or reverse charge a battery. Overcharging will shorten its life, and reverse charging could damage it.
- ❖ Avoid touching the metal terminals of the battery with another metal object. Short-circuiting the battery can cause it to overheat and may cause damage to the battery or the computer.
- ❖ Do not incinerate a spent battery, as this could cause it to explode and release caustic liquid.
- ❖ If a battery is leaking or damaged, replace it immediately. Use protective gloves when handling a damaged battery.
- ❖ To replace the main battery, use an identical battery that you can purchase through the Toshiba Web site at accessories.toshiba.com.
- ❖ A reverse polarity condition should be avoided with all batteries. The main battery is designed so that it cannot be installed in reverse polarity.
- ❖ Charge the battery only in the computer or in a battery charger designated as an approved option.
- ❖ When you install the battery pack, you should hear a click when it is seated properly.
- ❖ Do not expose the battery pack to fire. The battery pack could explode.

Maintaining your battery

Fully discharging your battery pack will allow better accuracy of the battery meter.

To fully discharge your battery pack:

- ❖ Periodically, disconnect the computer from a power source and operate it on battery power until the battery pack fully discharges. Before doing so, follow the steps below:
 - 1 Turn off the computer's power.
 - 2 Disconnect the AC adaptor and turn on the computer's power. If it does not turn on, go to step 4.
 - 3 Operate the computer on battery power for five minutes. If the battery pack has at least five minutes of operating time, continue operating until the battery pack is fully discharged. If the battery light flashes or there is some other warning to indicate a low battery, go to step 4.
 - 4 Connect the AC adaptor to the computer and the power cord/cable to a power outlet. The DC-IN or AC power-light should glow green, and the battery light should glow amber to indicate that the battery pack is being charged. If the DC-IN or AC power-light indicator does not glow, power is not being supplied. Check the connections for the AC adaptor and power cord/cable.
 - 5 Charge the battery pack until the battery light glows green.
- ❖ If you have extra battery packs, rotate their use.
- ❖ If you will not be using the system for an extended period, more than one month, remove the battery pack.
- ❖ If you are not going to use the computer for more than eight hours, disconnect the AC adaptor.
- ❖ Store spare battery packs in a cool dry place out of direct sunlight.

Disposing of used batteries

The life of a battery pack depends on usage. When the battery pack needs replacing, the main battery light flashes amber shortly after you have fully recharged the battery.

You must discard a battery if it becomes damaged.

⚠ WARNING

Never attempt to dispose of a battery pack by burning or by throwing it into a fire, and never allow exposure to a heating apparatus (e.g., microwave oven). Heat can cause a battery pack to explode and/or release caustic liquid, both which may possibly cause serious injury.

Always dispose of used battery packs in compliance with all applicable laws and regulations. Put insulating tape, such as cellophane tape, on the electrode during transportation to avoid a possible short circuit, fire or electric shock. Failure to do so could possibly result in serious injury.

⚠ WARNING

Always use the battery pack supplied as an accessory or an equivalent battery pack specified in the User's Manual. Other battery packs have different voltage and terminal polarities. Use of non-conforming battery packs could generate smoke or cause fire or rupture, possibly resulting in serious injury.

After repeated use, the batteries will finally lose their ability to hold a charge and you will need to replace them. Under certain applicable laws and regulations, it may be illegal to dispose of old batteries by placing them in the trash.

Please be kind to our shared environment. Check with your local government authority for details regarding where to recycle old batteries or how to dispose of them properly. If you cannot find the information you need elsewhere, call Toshiba at: (800) 457-7777.

In addition, Toshiba's recycling initiatives include recycling programs, events and consumer promotions. For details, visit www.ToshibaDirect.com, select Recycling & Trade-in programs, or enter **Recycle** in the search bar.

Toshiba is dedicated to preserving the environment by sponsoring **Call2Recycle**[™], a program of the Rechargeable Battery Recycling Corporation. For more information and for drop-off locations, visit www.rbrc.org or call 1-800-822-8837.

Notice regarding CR coin cell batteries, applicable to California, U.S.A. only:

Perchlorate Material - special handling may apply.
See <http://www.dtsc.ca.gov/hazardouswaste/perchlorate/>

Traveling tips

The environmental precautions listed in “[Selecting a place to work](#)” on [page 41](#), also apply while traveling.

- ❖ Never leave your computer on a sunny ledge or in a place where it could get wet or covered in dust.
- ❖ Always travel with the computer in a carrying case. Toshiba offers a choice of carrying cases for the computer. They all provide plenty of extra space for manuals, power cords, and compact discs. Contact your authorized Toshiba representative for more information or visit Toshiba’s Web site at accessories.toshiba.com.



TECHNICAL NOTE: When traveling by air, you may be required to pass your computer through airport security equipment. The X-ray equipment will not harm your computer.

NOTE

Before using your computer aboard an aircraft, make sure the Wireless antenna ON/OFF switch is set to the OFF position if your computer has wireless LAN capability.

Chapter 4

Exploring Your Computer's Features

In this chapter, you will explore some of the special features of your computer.

Exploring the desktop

The desktop is the launching pad for everything you can do in the Windows® operating system. You use its features to start programs, find documents, set up system components, and perform most other computing tasks.



HINT: The illustrated examples in this guide may appear slightly different from the screens displayed by your system. The differences are not significant and do not indicate any change in the functionality of your system.

Finding your way around the desktop

Your computer's desktop includes several standard features: icons, Start button, Taskbar, Notification Area, and background pattern.

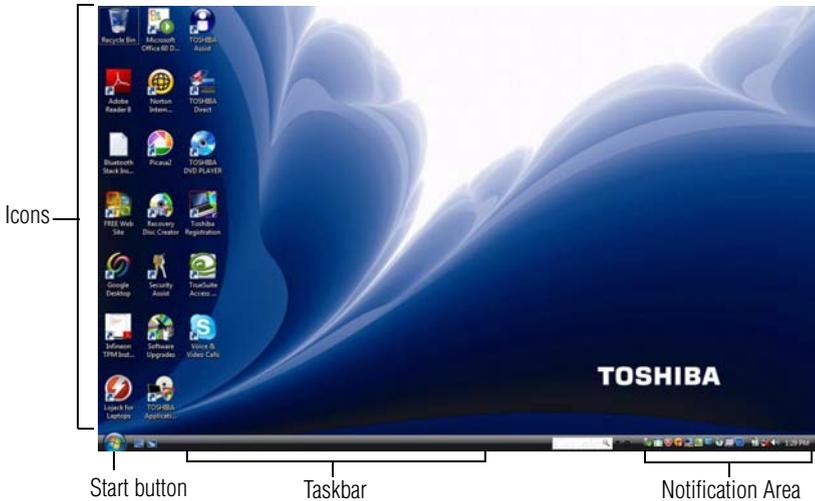

(Sample Image) Windows® operating system desktop

Icons

An icon represents a folder, file, or program that can be quickly activated by double-clicking the icon.

You can create a new desktop icon for any folder, file, or program by dragging the element's icon from its location in a window to the desktop area.

Various icons are initially displayed on your system desktop, for example:



Recycle Bin—Holds files you have deleted. You may be able to retrieve these files until you empty the Recycle Bin.



TECHNICAL NOTE: If you delete a file from a diskette or flash media, it does not go into the Recycle Bin. For more information on the Recycle Bin, see Windows® online Help.

NOTE

If you place the cursor over an icon, a popup description of the file contents appears.

Your desktop may contain other icons depending on your configuration. See Windows® online Help for more specific information on each icon and how to use it.

Start button



You use the Start button to:

- ❖ Start programs
 - ❖ Open documents
 - ❖ Adjust system settings
 - ❖ Find files
 - ❖ Access Windows® Help and Support
 - ❖ Suspend system activity and shut down the computer
-

NOTE

Whenever a procedure in this User's Guide instructs you to click Start, it means that you should click the Start button.

Taskbar

Each time you open a program, a button associated with that program appears on the Taskbar. With some programs, a button appears on the Taskbar for each document or window you open. You can use these buttons to quickly switch between the programs or windows.

To make a program or window the currently active one, click the associated Taskbar button.

Notification Area

The Notification Area displays icons of tasks or programs that run continuously in the background and displays notifications. To learn more about each task, position the cursor over the icon for a few moments and a short description of the task appears.

Typical tasks in the Notification Area are Current time, Power usage mode, Mouse properties, and speaker volume.

To activate a specific task, double-click the appropriate Notification Area icon.

Setting up for communications

To connect to the Internet, use an online service, or communicate across the telephone lines with another computer, you need:

- ❖ A browser or communications program
- ❖ An Internet Service Provider (ISP) or online service if you plan to use the Internet
- ❖ A way to connect to the ISP (for example modem/Wi-Fi®/LAN, etc.)

Using Wireless LAN connectivity

NOTE Wireless connectivity and some features may require you to purchase additional software, external hardware or services. Availability of public wireless LAN access points may be limited.

Your system may come with an optional wireless LAN module. This is a technology that expands wireless communication beyond networking equipment, and can connect many different kinds of electronic devices without the need for cables.

For information on how to set up a wireless connection, refer to your wireless networking device documentation or your network administrator.

To use your wireless communication, slide the Wireless antenna ON/OFF switch to the ON position.

NOTE When the Wireless antenna ON/OFF switch is ON, the wireless indicator light  will be lit.

For help with common Wi-Fi® networking problems, see [“Wireless networking problems” on page 198](#).

Connecting your computer to a network

You can connect your computer to a network to increase its capabilities and functionality using one of its communication ports.

Accessing a network

To access a network:

- ❖ At the office, connect an Ethernet cable to the RJ45 jack on your computer. For specific information about connecting to the network, consult your network administrator. Many hotels, airports, and offices offer Wi-Fi® access. If your computer has Wi-Fi®, ask them for help when connecting to their Wi-Fi® network.
- ❖ While you are at home or traveling, you need a dial-up connection. Ask your network administrator for the telephone number of the network.

Setting up the connection

To set up an office connection, consult your network administrator for network settings and additional considerations.

To set up a dial-up connection, use the Connect to the Internet Wizard:

- 1 Click **Start, Control Panel, Network and Internet**, and then **Connect to the Internet**.
- 2 Click **Dial Up**.
- 3 Enter the phone number and account information of your Internet connection.
- 4 Click **Connect** and let the program dial the number.

The computer connects to the Internet.

Connecting a modem to a telephone line

Your computer may come with a built-in modem that can be connected to a standard voice-grade telephone line.

The modem allows you to:

- ❖ Access the Internet
- ❖ Communicate with your office's local area network (LAN) or larger corporate wide area network (WAN)

For specific information about connecting to a LAN or WAN, consult your network administrator.

- ❖ Send a fax directly from your computer

For more detailed information regarding your computer's modem, visit Toshiba's Web site at accessories.toshiba.com.

Before you can communicate using the modem, you need to connect it to a telephone line. Your computer's built-in modem port provides an RJ-11 jack, allowing you to connect the modem to a standard voice-grade telephone line.

- 1 Plug one end of a telephone cable (purchased separately) into the modem port on the side of the computer.

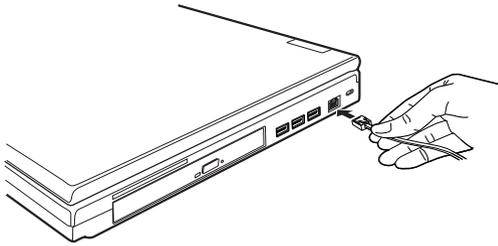

(Sample Illustration) Connecting the telephone cable to the modem port

- 2 Connect the other end to the RJ-11 wall jack.

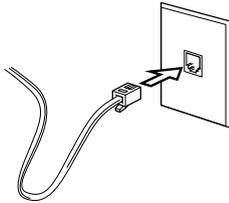

(Sample Illustration) Connecting to a wall jack

NOTE

Connect the built-in modem only to ordinary analog phone lines.

Never connect the built-in modem to a digital line (ISDN).

Never connect the built-in modem to the digital connector on a public telephone or to a digital private branch exchange (PBX).

Never connect the built-in modem to a key telephone system for residences or offices.

Connection to any communication line other than an analog phone line could cause a computer system failure.

Now you are ready to send a fax or use the modem to connect to an online service or the Internet.

An overview of using the Internet

The following sections give a quick introduction to the Internet and some of its exciting features, under these headings:

- ❖ [The Internet](#)
- ❖ [The World Wide Web](#)
- ❖ [Internet Service Providers](#)
- ❖ [Connecting to the Internet](#)
- ❖ [Surfing the Internet](#)
- ❖ [Internet features](#)
- ❖ [Uploading to, and downloading files from, the Internet](#)

The Internet

The Internet is an association of thousands of networks and millions of computers around the world connected by communications lines. They all work together to share information.

The World Wide Web

The World Wide Web (or “Web”) is a subset of the Internet—a collection of interlinked documents (located on computers connected to the Internet) that work together using a specific Internet protocol called Hypertext Transfer Protocol (HTTP).

The World Wide Web offers information as text, images, audio, or video to be referenced from anywhere in the world. Special programs called Web browsers are specifically designed to work with HTTP. They make it easier to connect to a particular network address and send and receive information.

Internet Service Providers

To connect a computer directly to the Internet, many people and businesses use an Internet Service Provider (ISP). An ISP is a company that has the equipment and the telecommunication lines necessary to maintain an Internet connection.

You can connect to the Internet by using a telephone and modem or through other higher-speed communication methods such as Digital Subscriber Lines (DSL), cable, and satellite links.

Connecting to the Internet

To connect to the Internet, you need:

- ❖ A modem and telephone line, or a LAN connection
- ❖ A Web browser
- ❖ An Internet Service Provider (ISP) account

Once you have established an ISP account, you can connect to the Internet.

- 1 Connect your computer's modem (available on certain models) to a telephone line. For more information on connecting a modem, see [“Connecting a modem to a telephone line”](#) on page 130.
- 2 Start your Web browser. Have your modem dial the ISP's telephone number, and establish a connection with the ISP's computer.

If you are using your computer at the office, then you probably connect to the Internet through your company's network. See your network administrator about connecting to the Internet.

Surfing the Internet

Once connected to the Internet, the Web browser displays a home page, for example, your ISP's home page on the Internet or your company's Web site home page.

To visit a desired Web site, type in the Web address. The Web address, or Uniform Resource Locator (URL), is a unique identifier for that computer system linked to the Internet. Web addresses can also appear within a Web page's text, and are known as links. Clicking a link automatically transfers your Web browser to that site.

You can also use a Search Engine, a Web site specifically designed to help you look for information.

Internet features

The Internet offers many types of communication tools to help you perform many tasks.

- ❖ Internet email

To send and receive email of your own, you need a mailbox on the Web or an email address.

If you have an account with an ISP, you can probably set up an email address at the same time you sign up for the service.

❖ Internet chat rooms

A chat room is a Web site that offers a place where people with similar interests and ideas communicate in real-time, one-on-one or in groups, by typing messages which are instantly viewed by others on their computer screens.

❖ Internet news groups

A news group is similar to a chat room, but instead of using a dedicated site to converse about a specialized subject with others in real-time, it uses a Web site as a clearinghouse where all the messages are placed, like a gigantic bulletin board.

❖ Online shopping

Many Web sites offer products and services for sale.

Uploading to, and downloading files from, the Internet

Transferring files from one computer to another is termed uploading (transferring data from your computer to a site on the Web), or downloading (transferring data from a site on the Web to your computer).

There are several ways to upload or download data. It can be as simple as attaching a file or document to an email, or you can use the File Transfer Protocol (FTP) features of your Web browser to transfer large amounts of data.

Exploring audio features

You can use your computer to record sounds using the computer's internal microphone or an optional external microphone. You can listen to sound files or audio CDs using the built-in speakers, headphones, or external speakers.

Recording sounds

You may record sounds using the computer's internal microphone or by connecting an optional external microphone.

Using a microphone



- 1 If you want to use an external microphone, connect it to the computer.

- 2 Click **Start**, **All Programs**, **Accessories**, and then **Sound Recorder**.



(Sample Image) Sound Recorder screen

- 3 Click the **Start Recording** button.
- 4 Speak normally into the microphone.
- 5 When you have finished recording, click the **Stop Recording** button.

The **Save As** dialog box appears.

- 6 To save the file, type a file name, and then click **Save**.

Using external speakers or headphones

Your computer is equipped with a full stereo sound system with internal speakers. Instead of using the internal speakers, you can connect headphones or a pair of external stereo speakers.

CAUTION

Before putting on headphones to listen, turn the volume down. Do not set the volume too high when using headphones. Continuous exposure to loud sound can harm your hearing.



TECHNICAL NOTE: When using amplified speakers, use speakers that require an external power source. Other types of speakers will be inadequate to produce sound from the computer.

To play back sound files through external speakers or headphones:



- 1 Locate the headphone jack on the computer.
- 2 Using any necessary adapters, plug the cable from the headphones or external speakers into the headphone jack.
The headphone jack requires a 16-ohm stereo mini-jack.

To adjust the volume:

- ❖ For external speakers, use the volume controls on each speaker.
- ❖ For headphones, use the computer's volume control.

Web Camera

(Available on certain models)

Your computer may come with a built-in Web Camera. With this Web Camera you can do the following:

- ❖ Take pictures and record videos with your computer
 - ❖ Chat with others and have them see you while using instant messaging (IM) programs
 - ❖ Have video conference calls
-

NOTE

To E-mail, instant message or video conference, you must be connected to the Internet.

Depending on your computer model, the process of sending E-mail, taking pictures or recording video messages may vary.

The Web Camera software, by default, should already be running in the Notification Area.

Using PC Cards



TECHNICAL NOTE: For PCMCIA-compatible PC Cards, check the package to make sure they conform to the PCMCIA 2.1 standard (or later). Other cards may work with your computer, but are likely to be much more difficult to set up and use.

Your computer comes with a PC Card slot and supports two types of PC Cards that you can install:

- ❖ Type I cards
- ❖ Type II cards

The PC Card slot supports hot swapping, which allows you to replace one PC Card with another while the computer is on.

Inserting a PC Card

Before you insert a PC Card, refer to the documentation that comes with the card to see if you need to do anything before you insert it.

To insert a PC Card:

- 1 Locate the PC Card slot on the side of the computer.

NOTE You may first need to remove the card slot protector before you can insert a card.

- 2 Insert the PC Card.

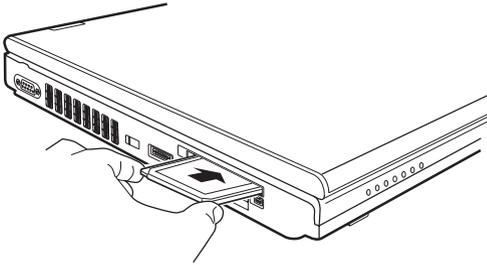

(Sample Illustration) Inserting a PC Card

- 3 When the card is almost all the way into the slot, push firmly but gently to ensure a firm connection with the computer. Do not force the card into position.

Removing a PC Card

CAUTION Be sure to disable the PC Card prior to removing it. Otherwise, the system may be damaged.

NOTE Before removing a PC Card, make sure that no applications or system services are using the card.



- 1 Prepare the card for removal by clicking the **Safely Remove Hardware** icon in the Notification Area and then selecting the card or device you want to remove.

If the system is unable to prepare the card for safe removal, a message will tell you to try again later. If the card can be removed now, the system displays **Safe to Remove Hardware**.

- 2 Locate the PC Card eject button.
- 3 Press the PC Card eject button once to pop it out slightly, and push it in to remove the PC Card.

The PC Card ejects slightly from the slot.

- 4 Grasp the edges of the PC Card and slide it out of the slot.

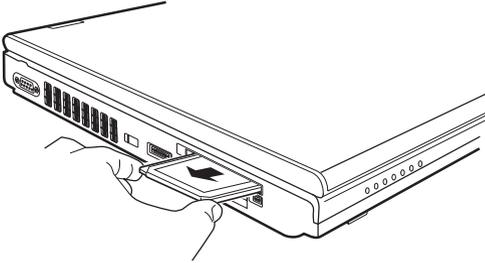

(Sample Illustration) Removing a PC Card

Setting up a PC Card for your computer

Some PC Cards are ready to use as soon as you install them. Others, such as hard disk cards, network cards, and SCSI adapters, may need to be set up to work with your computer. To set up your PC Card, refer to the documentation that came with the card or refer to your operating system manual or online Help.

Smart Card Reader

(Available on certain models)

Your computer includes a Smart Card Reader. This allows you to use a Smart Card for added security purposes. There are several different Smart Cards available for purchase as well as the software application needed. Visit your local electronics store or check the Web for other sources.

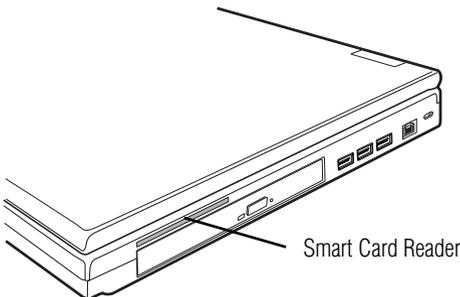

(Sample Illustration) Smart Card Reader

Using the Bridge Media Adapter Slot

The Bridge Media Adapter slot supports the use of Memory Stick™, Memory Stick™ PRO, Secure Digital™ (SD™), MMC™ (MultiMediaCard™), or xD-Picture Card™ media. These media can be used with a variety of digital products: digital music players, cellular phones, PDAs, digital cameras, digital video camcorders, etc.

The Bridge Media Adapter slot may also support other types of media. For a complete list of supported media, visit Toshiba's Web site at accessories.toshiba.com.

NOTE

Do not use the Copy Disk function for this type of media. To copy data from one media to another, use the drag-and-drop feature of the Windows® operating system.

Inserting memory media

The following instructions apply to all types of supported media devices.

- 1 Turn the media so that the contacts (metal areas) are face down.
- 2 Push the media into the adapter until it locks in place.

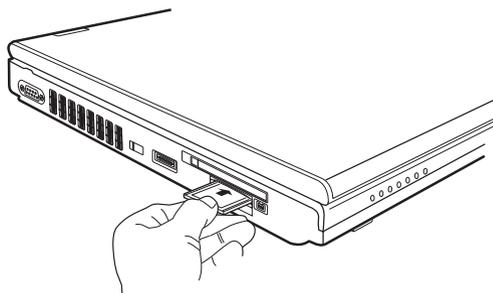

(Sample Illustration) Inserting memory media

CAUTION

When inserting memory media, do not touch the metal contacts. You could expose the storage area to static electricity, which can destroy data.

Removing memory media



- 1 Prepare the media for removal by clicking the **Safely Remove Hardware** icon in the Notification Area and then selecting the card or device you want to remove.

If the system is unable to prepare the media for safe removal, a message will tell you to try again later. If the media can be removed now, the system displays **Safe to Remove Hardware**.

- 2 Gently press the card inward to release it.

The card pops out slightly.

- 3 Grasp the card and pull it straight out.

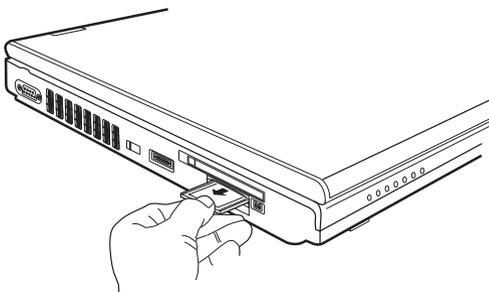

(Sample Illustration) Removing memory media

CAUTION

Do not remove memory media while data is being written or read. Even when the Windows® message "copying..." disappears, writing to the media might still be in progress and your data could be destroyed. Wait for the indicator light to go out.

Using the i.LINK® port

The i.LINK® port on the side of the computer provides an extremely fast data transfer rate.

In addition to high speed, the i.LINK® port also supports isochronous data transfer (the delivery of data at a guaranteed rate). This makes it ideal for devices that transfer high levels of data in real-time, such as video devices.

As with USB ports, the i.LINK® port supports both Plug-and-Play (automatic configuration) and hot swapping (the ability to connect and disconnect devices while the computer is on).

Using an expansion device



The expansion port is used to connect your computer to an expansion device. This is an excellent investment if you are using your computer both in and out of the office.

When you return to your desk, you can then connect to your network, print reports from your computer, or use a mouse instead of your computer's pointing device. Connecting cables for each of these devices every time you return to the office can be time-consuming.

With an expansion device, you can leave external devices connected while you are using your computer away from your desk. When you return, you can quickly connect your computer and have immediate access to all the devices.

For more information, see the accessories information package that comes with the device or visit accessories.toshiba.com.

Using an Optional Toshiba Express Port Replicator with your computer

If you purchase an optional Toshiba Express Port Replicator (not shipped with your system), you can connect this device to your computer's expansion port. In order to achieve a proper connection, the Toshiba Express Port Replicator must be properly aligned with your computer. To properly connect the Toshiba Express Port Replicator to your computer, see the Toshiba Express Port Replicator User's Guide or visit pcsupport.toshiba.com.

Chapter 5

Utilities

Your computer includes several utilities designed to help you to reconfigure your system to best meet your individual needs. Together, these allow you to ascertain certain system details, set additional options, or change default options. These utilities are described in this chapter.

NOTE

The utilities described in this chapter, and the icons shown in the sample images are applicable only if the related utility is available on your system.

- ❖ TOSHIBA Assist
- ❖ TOSHIBA Application Installer
- ❖ Supervisor password
- ❖ User password
- ❖ TOSHIBA Security Assist
- ❖ TOSHIBA PC Diagnostic Tool Utility
- ❖ TOSHIBA HDD Protection Utility
- ❖ TOSHIBA SD™ Memory Card Format Utility
- ❖ TOSHIBA SD™ Memory Boot Utility
- ❖ Mouse Utility
- ❖ TOSHIBA Hardware Setup

- ❖ USB Sleep and Charge Utility
- ❖ TOSHIBA Zooming Utility
- ❖ TOSHIBA Button Support
- ❖ CD/DVD Drive Acoustic Silencer
- ❖ TOSHIBA Accessibility
- ❖ Trusted Platform Module (TPM)
- ❖ Fingerprint Authentication Utility
- ❖ ConfigFree®

TOSHIBA Assist

The TOSHIBA Assist provides quick access to computer functions and allows you to customize a range of computer settings.

To access TOSHIBA Assist, click **Start**, **All Programs**, **Toshiba**, **Utilities**, and then **TOSHIBA Assist**.

The TOSHIBA Assist window appears.



(Sample Image) TOSHIBA Assist window

The TOSHIBA Assist offers four categories of options:

- ❖ Connect
- ❖ Secure
- ❖ Protect & Fix
- ❖ Optimize

Connect

The features available in this category are:

- ❖ ConfigFree® **Connectivity Doctor**
- ❖ *Bluetooth*® Settings
- ❖ *Bluetooth*® Local COM Settings

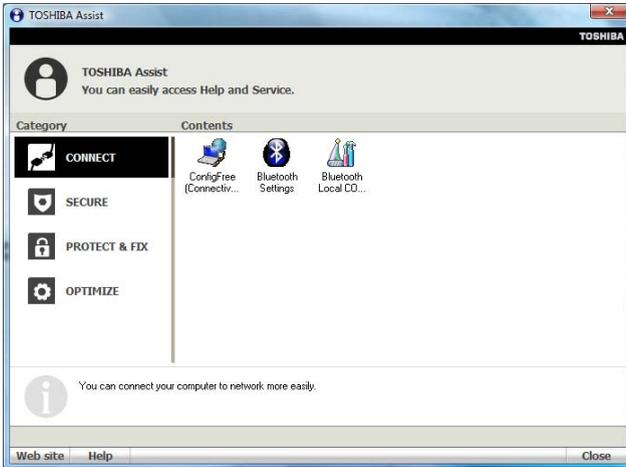

(Sample Image) TOSHIBA Assist window – Connect tab

Secure

The features available in this category are:

- ❖ Supervisor password
- ❖ User password
- ❖ TOSHIBA Security Assist

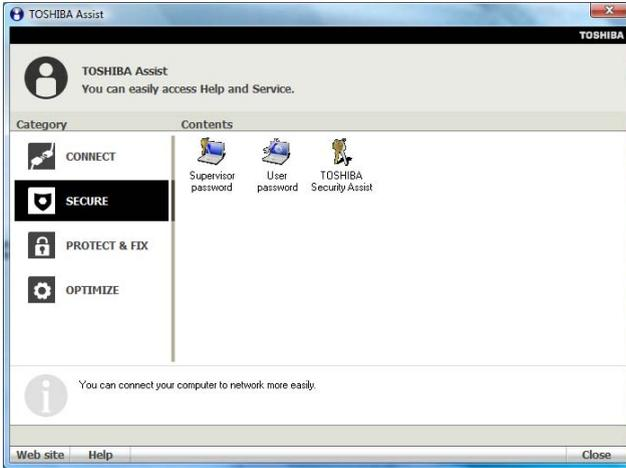

(Sample Image) TOSHIBA Assist window – Secure tab

Protect & Fix

The features available in this category are:

- ❖ TOSHIBA PC Diagnostic Tool Utility
- ❖ TOSHIBA HDD Protection Utility

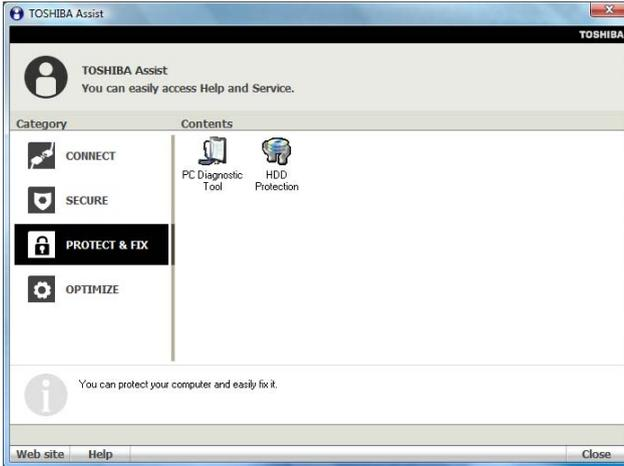

(Sample Image) TOSHIBA Assist window – Protect & Fix tab

Optimize

The features available in this category are:

- ❖ TOSHIBA SD™ Memory Card Format Utility
- ❖ Mouse Utility
- ❖ TOSHIBA Hardware Setup
- ❖ TOSHIBA Zooming Utility
- ❖ TOSHIBA Button Support
- ❖ CD/DVD Drive Acoustic Silencer
- ❖ TOSHIBA Accessibility

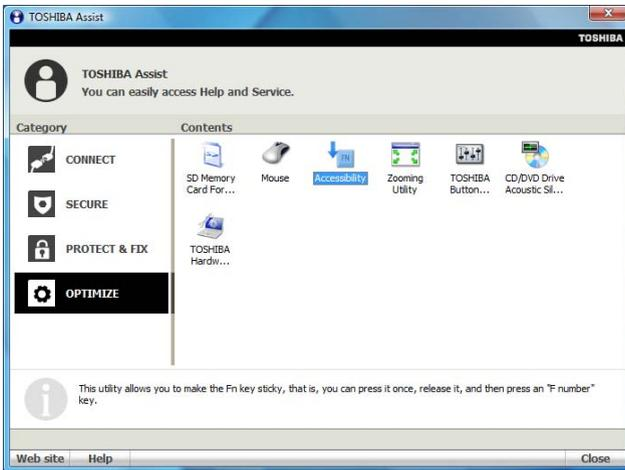

(Sample Image) TOSHIBA Assist window – Optimize tab

TOSHIBA Application Installer

The TOSHIBA Application Installer allows you to reinstall the drivers and applications that were originally bundled with your computer.

To reinstall drivers and applications:

- 1 Click **Start, All Programs, Toshiba, Recovery**, and then **TOSHIBA Application Installer**.
- 2 Click **Next**.



(Sample Image) TOSHIBA Application Installer screen

- 3 Click the item you want to install.

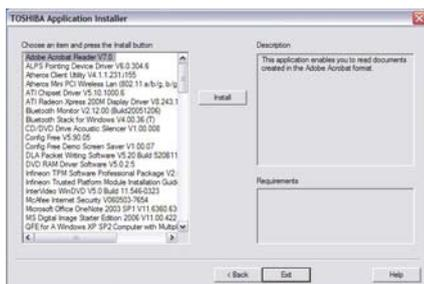

(Sample Image) TOSHIBA Application Installer selection screen

- 4 Click **Install**, then follow the on-screen prompts to complete the installation process.

Setting passwords

Setting a password lets you walk away from your computer while providing additional protection for your files. When you set a password, you must enter the password before you can work on your computer again.

Toshiba supports several types of passwords on your computer:

- ❖ An instant password—Secures your open programs and files when leaving the computer temporarily.

NOTE

You need to have created a password for your Windows® account to use an instant password.

- ❖ A power-on password—Prevents unauthorized users from starting or restarting the computer.
- ❖ A supervisor password—Prohibits unauthorized users from accessing certain functions such as TOSHIBA Hardware Setup. This is useful if more than one person uses the computer.

When setting up passwords, keep the following in mind:

- ❖ The user password can be set up under the supervisor password.
- ❖ The supervisor password must be set before the user password, or the user password must be deleted and then re-entered after the supervisor password is set.

Using an instant password

An instant password secures your system with a single keystroke. Use this feature when you leave your desk for a few minutes and do not want to turn off the computer.

To use an instant password, press Fn + F1.

To unlock your system, press any key or touch the pointing device and the Windows® Logon screen will appear. Select your user name and enter your password, if any.

Using a supervisor password

A supervisor password prevents other users from changing hardware configuration options.

Setting a supervisor password

CAUTION

If you choose to set a supervisor or user password, Toshiba strongly recommends that you save your password in a location where you can later access it should you not remember it.

Toshiba is not responsible for any losses that may occur to you, your organization or others as a result of the inability to access your computer.

To set a supervisor password:

- 1 Click **Start, All Programs, Toshiba, Utilities**, and then **TOSHIBA Assist**.

The TOSHIBA Assist window appears.

- 2 On the left side, click the **Secure** tab.
- 3 Click the **Supervisor Password** icon.

The Supervisor Password tab of the TOSHIBA Password Utility window appears.

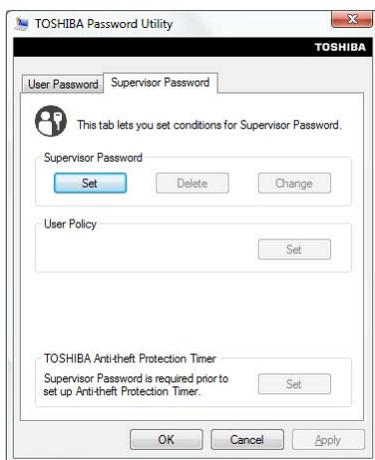

(Sample Image) Supervisor Password tab

- 4 Click **Set**.
- 5 Enter your password, and then enter it again to verify.

- 6 Click **Set**.
- 7 Click **OK** if you want to save the password to a text file on a diskette or media of your choice, or click **Cancel** to continue without saving the password to a text file.
- 8 Shut down the system to complete the process.

Deleting a supervisor password

To delete a supervisor password:

- 1 Click **Start, All Programs, Toshiba, Utilities**, and then **TOSHIBA Assist**.

The TOSHIBA Assist window appears.

- 2 On the left side, click the **Secure** tab.

- 3 Click the **Supervisor Password** icon.



The Supervisor Password tab of the TOSHIBA Password Utility window appears.

- 4 Click **Delete**.

A pop-up screen appears asking for a password.

- 5 Enter the password, then click **OK**.

A message displays confirming that the password has been deleted.

- 6 Click **OK** to exit.

Using a user password

A user password provides power-on password protection.

Setting a user password

CAUTION

If you choose to set a supervisor or user password, Toshiba strongly recommends that you save your password in a location where you can later access it should you not remember it.

Toshiba is not responsible for any losses that may occur to you, your organization or others as a result of the inability to access your computer.

To register a password for the power-on password functions:

- 1 Click **Start, All Programs, Toshiba, Utilities**, and then **TOSHIBA Password Utility**.

The TOSHIBA Password Utility window appears.



(Sample Image) TOSHIBA Password Utility window

- 2 Click **Set**.
- 3 Enter your password, and then enter it again to verify.
- 4 Click **Set**.
- 5 Click **OK** if you want to save the password to a text file on a diskette or media of your choice, or click **Cancel** to continue without saving the password to a text file.
- 6 Click **OK** to exit.

Deleting a user password

To cancel the power-on password function:

- 1 Click **Start, All Programs, Toshiba, Utilities**, and then **TOSHIBA Password Utility**.

The TOSHIBA Password Utility window appears.

- 2 Click **Delete**.
- 3 Follow the on-screen instructions to remove the user password.

TOSHIBA Security Assist

The TOSHIBA Security Assist Utility acts as a “command center” where you can set up various passwords or other security features, and see how these features can be used with each other to increase security even further, or to simplify the ways that you protect your system.

To open TOSHIBA Security Assist:

- ❖ Click **Start, All Programs, Toshiba, Utilities**, and then **Security Assist**, or click the **Security Assist** icon in the **Secure** tab of **TOSHIBA Assist**.



The TOSHIBA Security Assist main window appears.

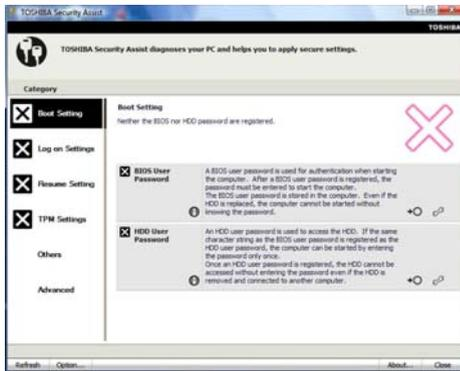

(Sample Image) TOSHIBA Security Assist window

From the main window, you can select a category that shows the type of passwords or other security features that can be used in that scenario.

The available categories are:

- ❖ **Boot Setting**—Select this category to set up security features that will prevent an unauthorized user from even starting up your machine.
 - ❖ **BIOS User Password**: Set up a power-on password in the system BIOS.
 - ❖ **HDD User Password**: Set up a BIOS password and use the same password for a hard disk password.
 - ❖ **Fingerprint Authentication**: Register your fingerprints, to be used in place of a BIOS and/or HDD password, when requested.

- ❖ **Log on Settings**—Select this category to set up security options that protect individual user accounts.
 - ❖ **Password of current user:** Check the status of the Windows® password for the account to which you are currently logged on.
 - ❖ **Password of all users:** Check the status of the Windows® password for any additional Windows® accounts on this computer.
 - ❖ **Fingerprint Authentication:** Register your fingerprints, to be used in place of your Windows® account password, to log onto your personal account.
- ❖ **Resume Setting**—Select this category to configure which security options you want to use when your system resumes from Sleep or Hibernation.
 - ❖ **Screen Saver:** Set up what you want your system to do when it comes back from the Windows® screen saver.
 - ❖ **Setting for resuming from sleep or hibernation:** Set up what you want your system to do when it resumes from Sleep or Hibernation
 - ❖ **Setting for closing the lid:** Set up what you want your system to do when the display panel is closed or re-opened.
- ❖ **TPM Settings**—Select this category to set up the Trusted Platform Module (available on certain models).
 - ❖ **TPM State:** Verify whether the TPM is enabled or disabled.
 - ❖ **EFS Setting:** Verify the Encrypted File System settings.
 - ❖ **PSD Setting:** Configure or check a “Personal Secure Drive”.
 - ❖ **BitLocker State:** Verify whether Windows® BitLocker drive encryption is enabled or disabled
- ❖ **Others**—Select this category to check the status of other security features.
 - ❖ **Windows Security Center:** Check the status of Windows® Security Center options
- ❖ **Advanced**—Select this category to check advanced security options (available on certain models).
 - ❖ **Wireless Key Logon:** Configure your computer to allow a Bluetooth®-compatible cell phone to send an unlock code.

TOSHIBA PC Diagnostic Tool Utility

This utility can help diagnose problems with devices in your computer. Refer to the online Help documentation within the application for additional help.

NOTE

The TOSHIBA PC Diagnostic Tool utility may show tests for features you do not have. This is normal and does not indicate a problem.

To use the TOSHIBA PC Diagnostic Tool utility:



- 1 Click **Start, All Programs, Toshiba, Utilities**, and then **PC Diagnostic Tool**, or click the **PC Diagnostic Tool** icon in the **Protect & Fix** tab of **TOSHIBA Assist**.

The TOSHIBA PC Diagnostic Tool window appears.

- 2 Click the **Diagnostic Tool** tab.

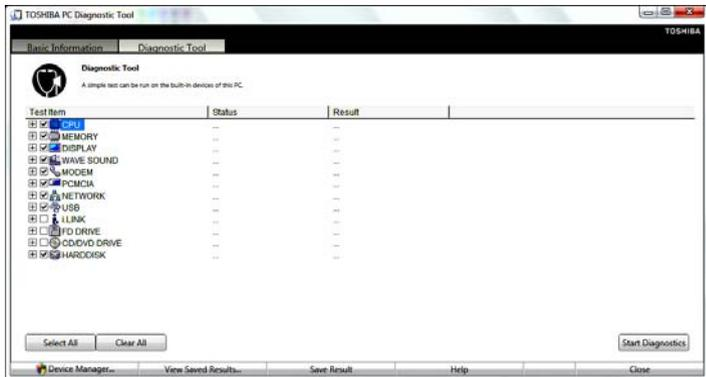

(Sample Image) TOSHIBA PC Diagnostic Tool window

- 3 Select the devices that you would like to test by clicking the check box that appears to the left of the device.

NOTE

Click the + (plus) and - (minus) symbols to expand and collapse the categories.

- 4 Click **Start Diagnostics** when you are ready to begin the tests.

TOSHIBA HDD Protection Utility

The TOSHIBA HDD Protection utility controls your computer's hard disk drive (HDD) protection feature, which parks the HDD whenever motion is detected on the computer. Using this utility, you can enable or disable hard disk drive (HDD) protection, and set the motion detector's sensitivity level for AC power and battery power operation.

To use the TOSHIBA HDD Protection utility:

- 1 Click **Start, All Programs, Toshiba, Utilities**, and then **HDD Protection**, or click the **HDD Protection** icon in the **Protect & Fix** tab of **TOSHIBA Assist**.

The TOSHIBA HDD Protection Properties window appears.

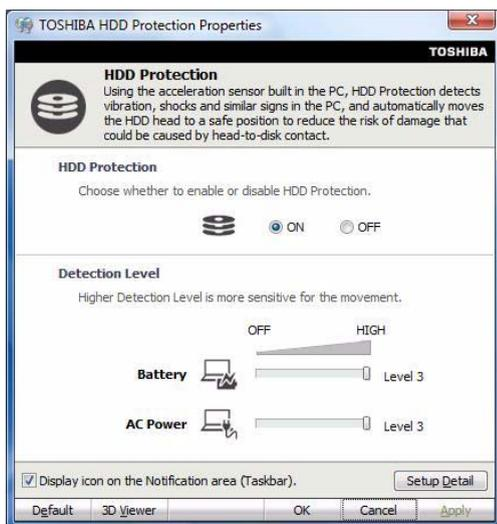

(Sample Image) TOSHIBA HDD Protection Properties window

- 2 Select **ON** to enable HDD protection, or select **OFF** to disable HDD protection.
- 3 Set the battery and AC power detection levels as desired.
- 4 Click **OK**.

TOSHIBA SD™ Memory Card Format Utility

This utility is used to format SD™ cards used with the Bridge Media Adapter slot.

To format an SD memory card using this utility:

- 1 Click **Start**, **All Programs**, **Toshiba**, **Utilities**, and then **SD Memory Card Format**.

The TOSHIBA SD Memory Card Format screen appears.

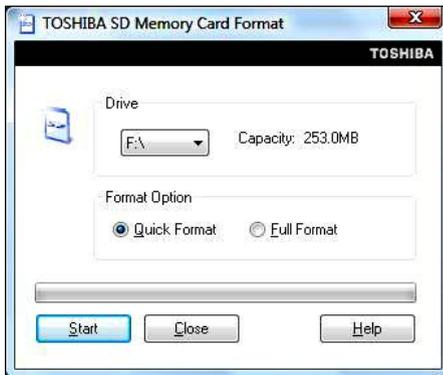

(Sample Image) TOSHIBA SD Memory Card Format screen

- 2 Select the drive corresponding to the SD memory card.
- 3 Select the formatting option:
 - ❖ **Quick Format**
 - ❖ **Full Format**
- 4 Click **Start** to begin formatting. The formatting progress is displayed in the horizontal bar in the window.
- 5 When formatting is completed, click **Close** to exit the utility.

TOSHIBA SD™ Memory Boot Utility

The TOSHIBA SD™ Memory Boot Utility allows you to create an SD card you can use to boot up your computer.

This utility also allows you to easily format SD Memory Cards. Refer to the online Help documentation within the application for any additional help.

To make a bootable SD card:

- 1 Attach a USB floppy drive to your computer and insert a bootable floppy disk.
- 2 Insert the SD card.

NOTE

Be sure to back up your data to external media before performing this procedure as data on the drive may be lost.

- 3 Click **Start, All Programs, Toshiba, Utilities**, and then **SD Memory Card**.

The TOSHIBA SD Memory Boot Utility screen appears.

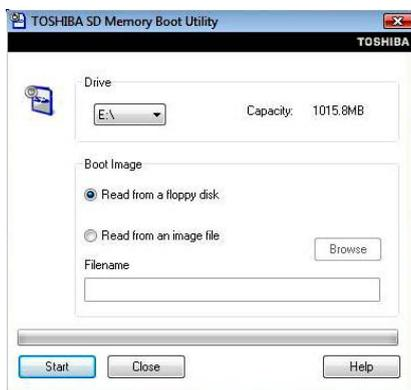

(Sample Image) TOSHIBA SD Memory Boot Utility screen

- 4 Select the drive where the SD card is located.
 - 5 Select **Read from a floppy disk**.
 - 6 Click **Start**.
-

NOTE

To create a bootable SD card with the Read from an image file option, you need a third-party application.

Booting from a bootable SD card

To boot from a bootable SD card:

- 1 Create a bootable SD card (see [“TOSHIBA SD™ Memory Boot Utility” on page 158](#) for instructions).
- 2 Verify that no floppy disk is installed in the optional external floppy disk drive.
- 3 Insert a bootable SD card into the SD card slot.
- 4 Power on the computer.
- 5 During the boot process, press the F12 key.
The system displays the Boot menu.
- 6 Use the arrow keys to select the SD/Floppy icon.
- 7 Press the Enter key.

Mouse Utility

The Mouse utility allows you to change your pointing device or mouse settings.

To access the Mouse utility:



- 1 Click **Start, Control Panel**, and then **Mouse** under **Hardware and Sound**, or click the **Mouse** icon in the **Optimize** tab of **TOSHIBA Assist**.

The Mouse Properties screen appears.

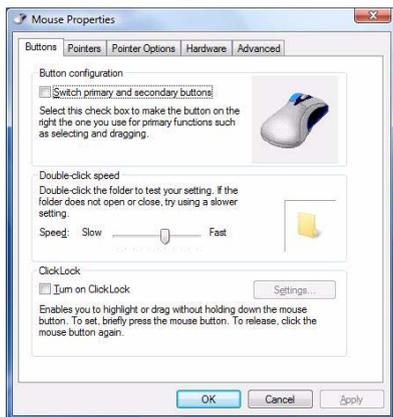

(Sample Image) Mouse Properties screen

The settings you can change are divided into these categories:

- ❖ Buttons
- ❖ Pointers
- ❖ Pointer Options
- ❖ Hardware
- ❖ Advanced

You may see additional categories depending on your particular pointing device.

- 2 Adjust the settings as desired, then click **OK**.

TOSHIBA Hardware Setup

TOSHIBA Hardware Setup is the Toshiba configuration management tool available through the Windows® operating system. To access it:



- ❖ Click **Start, All Programs, Toshiba, Utilities**, and then **HWSetup**, or click the **TOSHIBA Hardware Setup** icon in the **Optimize** tab of **TOSHIBA Assist**.

The TOSHIBA Hardware Setup screen appears.



(Sample Image) TOSHIBA Hardware Setup screen – General tab options

The TOSHIBA Hardware Setup screen may have the following tabs:

- ❖ **Boot Priority**—Allows you to change the sequence in which your computer searches the drives for the operating system
You can also manually choose the Boot Priority by pressing the power button to power on the computer, then quickly pressing the F12 key.
Select the boot device by pressing the arrow keys, then pressing the Enter key.

NOTE

Since the system is a quick-booting system, you must press the keys immediately after pressing the power button.

❖ **Button Setting**—Lets you set the resume speed for Sleep mode. If you want to use the fast resume option, be sure to connect the AC adaptor to the computer.

❖ **CPU**—Allows you to enable or disable CPU frequency switching modes

Dynamically Switchable—This mode is the default setting for your computer, and automatically changes the processing frequency and decreases voltage depending on the power source:

❖ **AC Power**—If your computer is connected to the AC adaptor, the CPU frequency mode is set to high for faster processing.

❖ **Battery Power**—If your computer is running on battery power, the CPU frequency mode is set to low for slower processing. Switching the CPU to low allows you to conserve power and extend the operating time of your battery.

Always Low—Sets the CPU speed to low when using either the battery or the AC adaptor

❖ **Device Config**—Shows the Device configuration options

❖ **Display**—Allows you to change various default settings for the built-in display

NOTE

When the computer restarts, it remembers the last configuration. If data does not appear on the display you are using after starting in Sleep Mode, press Fn + F5. For more information, see [“Directing the display output when you turn on the computer” on page 74](#).

❖ **General**—Allows you to view the current BIOS version or change certain settings back to their default values

❖ **Keyboard**—Allows you to configure an external keyboard to emulate the Fn function key and access the wake-on keyboard function

❖ **LAN**—Allows you to set networking functions

❖ **Password**—Allows you to set a user password

❖ **USB**—Allows you to enable or disable USB Legacy Emulation

USB Sleep and Charge Utility

This utility displays whether the “USB Sleep and Charge function” is enabled or disabled and shows the position of the USB port that supports the “USB Sleep and Charge function.” It also displays the remaining battery capacity.

Starting the USB Sleep and Charge Utility

To start this utility click Start, **All Programs, Toshiba, Utilities,** and then **USB Sleep and Charge.**

USB Sleep and Charge

Your computer can supply USB bus power (DC 5V) to the USB port even when the computer is in Sleep Mode, Hibernation Mode or shutdown state (powered off).

This function can only be used for the port that supports the USB Sleep and Charge function (hereinafter called “compatible port”).

The compatible port is the USB port that has the (⚡) symbol icon.

You can use the "USB Sleep and Charge function" to charge certain USB compatible external devices such as mobile phones or portable digital music players. However, the "USB Sleep and Charge function" may not work with certain external devices even if they are compliant with the USB specification. In those cases, power on the computer to charge the device.

NOTE

- ❖ When “USB Sleep and Charge function” is set to Enabled, USB bus power (DC 5V) will be supplied to the compatible port even when the power of the computer is turned OFF. USB bus power (DC 5V) is similarly supplied to the external devices which are connected to the compatible ports. However, some external devices cannot be charged solely by supplying USB bus power (DC 5V).
As for the specifications of the external devices, please contact the device manufacturer or check the specifications of the external devices thoroughly before use.
 - ❖ Using the “USB Sleep and Charge function” to charge external devices will take longer than charging the devices with their own chargers.
 - ❖ If an external device is connected to the compatible port when the AC adaptor is not connected to the computer, the battery of the computer will be depleted even when the power of the computer is turned OFF. As such, we recommend that you connect the AC adaptor to the computer when using the “USB Sleep and Charge function.”
 - ❖ External devices connected to the USB bus power (DC 5V) function that interfaces with the power ON/OFF of the computer may always be in an operational state.
 - ❖ When there is a current overflow of the external device connected to the compatible port, USB bus power (DC 5V) supply may be stopped for safety reasons.
 - ❖ When “USB Sleep and Charge function” is set to Enabled, the “USB Wakeup function” does not work for compatible port. In that case, if there is a USB port that does not have the USB Sleep and Charge function-compatible icon (⚡), attach the mouse or keyboard to it. The “USB Wakeup function” will now work, but the “USB Sleep and Charge function” will be disabled.
-

▲ WARNING

Metal paper clips or hair pins/clips will generate heat if they come into contact with USB ports. Do not allow USB ports to come into contact with metal products, for example when carrying the computer in your bag.

Enabling USB Sleep and Charge

This utility can be used to enable or disable the “USB Sleep and Charge function” group.

Check the check box for the group to enable the “USB Sleep and Charge function” for the USB port assigned to that group. In the default state, the group is disabled.

Power supply mode settings

There are several "USB Sleep and Charge function" modes.

The default setting is Mode-1. Select one of the other modes in the drop-down menu of the **USB Sleep and Charge** window if the charge function cannot be used in Mode 1.

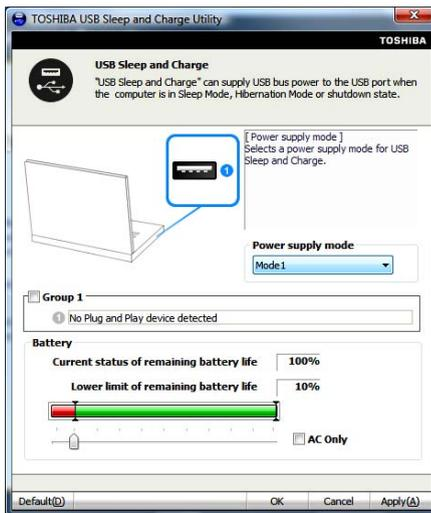

In this situation, select a different mode. “USB Sleep and Charge function” may not be functional with some connected external devices even if the appropriate group is selected. In this situation, uncheck the check box for the group and discontinue using this function.

Battery settings

This utility can be used to specify the lower limit of remaining battery life for USB Sleep and Charge. Move the slider bar to specify the lower limit. If the remaining battery life falls below the setting, the "USB Sleep and Charge function" will be stopped.

TOSHIBA Zooming Utility

This utility allows you to select which applications will work with the zoom in/out hot keys (see “[Zoom \(Display resolution\)](#)” on [page 224](#)). You may select all applications or any subset of the following:

- ❖ Microsoft® Internet Explorer®
- ❖ Microsoft® Office
- ❖ Windows Media® Player
- ❖ Adobe® Acrobat® Reader®
- ❖ Icons on the desktop

To access the TOSHIBA Zooming Utility:

- 1** Click **Start, All Programs, Toshiba, Utilities**, and then **TOSHIBA Zooming Utility**.

The TOSHIBA Zooming Utility Properties screen appears.

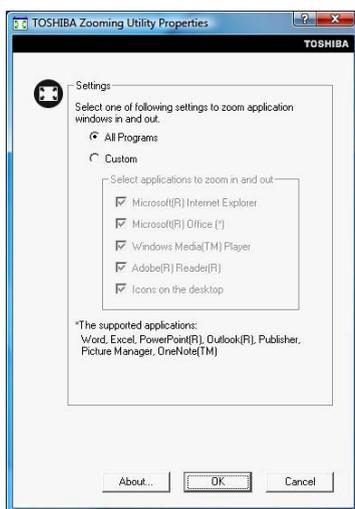

(Sample Image) TOSHIBA Zooming Utility Properties screen

- 2** Select the desired option(s).
- 3** Click **OK**.

The zoom in and zoom out hot keys will now work with the applications you selected.

To zoom in, hold down the Fn key and press 2; to zoom out, hold down the Fn key and press 1.

For more information about how to use the TOSHIBA Zooming Utility, right-click the  icon in the Notification Area and then click **Help**.

TOSHIBA Button Support

TOSHIBA Button Support allows you to customize the TOSHIBA Assist and Windows® Mobility Center buttons. These buttons are located above the keyboard.

To access TOSHIBA Button Support:



- 1 Click the **TOSHIBA Button Support** icon in the **Optimize** tab of **TOSHIBA Assist**.

The TOSHIBA Button Support window appears.

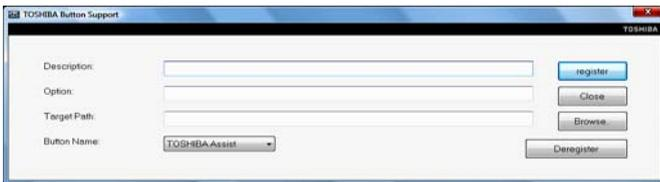

(Sample Image) TOSHIBA Button Support screen

- 2 Under **Button Name**, select the button whose function is to be customized.
- 3 Make the desired selections.
- 4 Click **Close**.

CD/DVD Drive Acoustic Silencer

This utility can slow the speed of your optical drive to make it run more quietly. You can use this utility to make listening to music CDs more enjoyable.

NOTE

When you change the optical drive to “Silence” mode, the setting is only valid for the current Windows® session. If you shut down, restart, log off, or resume from Hibernation, the setting will revert back to Normal speed. The setting can also be changed by CD burning software or other applications that can set the drive speed.



(Sample Image) CD/DVD Drive Acoustic Silencer screen

To access the utility:



- 1 Click the **CD/DVD Drive Acoustic Silencer** icon in the **Optimize** tab of **TOSHIBA Assist**.

The CD/DVD Drive Acoustic Silencer screen appears.

- 2 Click **Silence Mode** to make the drive run more slowly and quietly for listening to music or audio files on a CD.
- 3 Click **Normal Mode** to run the drive at normal speed for transferring data.

TOSHIBA Accessibility

The TOSHIBA Accessibility utility allows you to use the Fn key to create a hot key combination with one of the function keys without pressing the two keys simultaneously as is usually required. Using Accessibility lets you make the Fn key a *sticky key*, meaning you can press it once, release it, and then press a function key to activate the hot key function.



(Sample Image) TOSHIBA Accessibility window

To use TOSHIBA Accessibility:



- 1 Click **Start, All Programs, Toshiba, Utilities**, and then **Accessibility**, or click the **Accessibility** icon in the **Optimize** tab of **TOSHIBA Assist**.

The TOSHIBA Accessibility window appears.

- 2 Check the **Use Fn-StickyKey** box.
- 3 Put a check mark next to the desired option.
- 4 Click **OK**.

Trusted Platform Module (TPM)

NOTE

This section only applies to systems with TPM.

Your Toshiba computer includes the TPM (Trusted Platform Module), which is a security encryption device for your system's internal storage drive. TPM is already included on your system, but needs to be installed and enabled using the following procedures.

To install TPM:

- 1 Launch the TOSHIBA Application Installer from the desktop and install the following packages:
 - ❖ Infineon Trusted Platform Module Utility
 - ❖ Infineon TPM (Trusted Platform Module) Installation Guide
- 2 Follow the directions on your screen.

Once the TPM files have been installed, you will need to enable the TPM feature through your system's BIOS.

To enable TPM:

- 1 Power on your system while holding down the Esc key.
- 2 Press F1 when directed.
- 3 Press the PgDn key.
- 4 Press the down arrow key until TPM is highlighted, then press the space bar to change the TPM status to **Enabled**.
- 5 Press Y to save the changes.
- 6 Press End and then press Y to accept the changes.

Your system will restart.

For further information on how to set up and use this utility, refer to the Infineon TPM (Trusted Platform Module) Installation Guide.

Fingerprint Authentication Utility

The fingerprint authentication utility can be used to replace the keyboard-based user password authentication system when booting up.

The fingerprint authentication utility can also be used for user logon. The user's fingerprint is read; if the system recognizes the fingerprint, the user is automatically logged on.

Fingerprint utility limitations

Toshiba does not guarantee that the fingerprint utility technology will be completely secure or error-free. Toshiba does not guarantee that the fingerprint utility will accurately screen out unauthorized users at all times. Toshiba is not liable for any failure or damage that might arise out of the use of the fingerprint software or utility.

Using the Fingerprint Authentication Utility

To access the Fingerprint Authentication Utility, click **Start, All Programs, TrueSuite™ Access Manager**, and then select the **TrueSuite™ Access Manager** icon. For information on enrolling fingerprints and using the utility please refer to your online help file.

NOTE

It is recommended that you complete the Fingerprint practice tutorial before starting fingerprint enrollment. The Fingerprint practice tutorial shows how to achieve the highest quality fingerprint samples.

If you choose to use this utility it is strongly recommended that you delete your fingerprint template data before transferring ownership or disposing of your computer. Otherwise, personal information and/or proprietary information on the internal storage drive may be viewed by a third party. For details on how to delete the fingerprint data, see your Online help file.

Fingerprint Logon

The fingerprint utility enables logon to your computer using fingerprints. During user enrollment, fingerprint samples are saved and associated with the user's Windows® user account. When the user attempts to log on again, the user's fingerprint is read and compared with the user's enrolled fingerprints; if the fingerprint is recognized, user logon is completed.

The Fast User Switching feature of the Windows® operating system is also supported. If user A is logged on and the fingerprint utility verifies the fingerprint of user B (who is already enrolled), the utility recognizes the fingerprint and switches the users.

If your system supports power-on security, existing fingerprint samples can be used also for power-on authentication.

Care and maintenance of your fingerprint reader

Failure to follow these guidelines and/or procedures might result in damage to the reader or cause reader failure, finger recognition problems, or lower finger recognition success rate.

- ❖ Do not scratch or poke the reader with your nails or any hard or sharp objects.
- ❖ Do not press the reader with too much pressure.
- ❖ Do not touch the reader with a wet finger or any wet objects. Keep reader surface dry and free of water vapor.
- ❖ Do not touch the reader with a soiled finger. Minute foreign particles on a soiled or dirty finger may scratch the reader.
- ❖ Do not paste stickers or write on the reader.
- ❖ Do not touch the reader with a finger or any object with built-up static electricity.

Observe the following before you swipe your finger on the reader, whether for fingerprint enrollment/registration or recognition.

- ❖ Wash and dry your hands thoroughly.
- ❖ Remove static electricity from your fingers by touching any metal surface. Static electricity is a common cause of reader failures, especially during dry seasons such as winter.
- ❖ Clean the reader with a lint-free cloth. Do not use detergent to clean the reader.

- ❖ Avoid the following finger conditions for enrollment or recognition as they may result in fingerprint enrollment errors or a drop in the fingerprint recognition success rate.
 - ❖ Soaked or swollen finger (e.g., after taking bath)
 - ❖ Injured finger
 - ❖ Wet finger
 - ❖ Soiled or oily finger
 - ❖ Extremely dry skin condition on finger

Observe the following to improve the fingerprint recognition success rate.

- ❖ Enroll two or more fingers.
- ❖ Enroll additional fingers if recognition failure occurs often using enrolled fingers.
- ❖ Check your finger condition. Changed conditions, such as injured, rough, extremely dry, wet, soiled, dirty, oily, soaked or swollen fingers, may lower the recognition success rate. Also if the fingerprint is worn down or the finger becomes thinner or fatter, the recognition success rate may be lowered.
- ❖ The fingerprint for each finger is different and unique. Please ensure that only the registered or enrolled fingerprint or fingerprints are used for identification.
- ❖ Check sliding position (see illustration below).

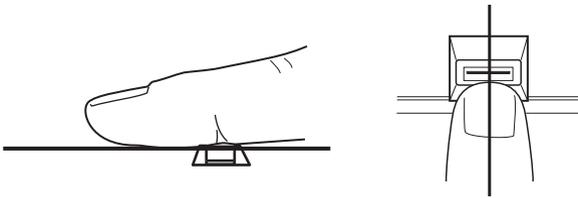

(Sample Illustration) Aligning the finger on the reader

Fingerprint reader limitations

- ❖ The fingerprint reader compares and analyzes the unique characteristics in a fingerprint. However, there may be instances where certain users are unable to register their fingerprints due to insufficient unique characteristics in their fingerprints.
- ❖ A warning message will be displayed when recognition is abnormal or recognition is not successful within a fixed duration.

- ❖ The recognition success rate may differ from user to user.
- ❖ Toshiba does not guarantee that this fingerprint recognition technology will be error-free.

Toshiba does not guarantee that the fingerprint reader will recognize the enrolled user or accurately screen out unauthorized users at all times. Toshiba is not liable for any failure or damage that might arise out of the use of this fingerprint recognition software or utility.

ConfigFree®

NOTE All references to *Bluetooth®* in this section are applicable only if *Bluetooth®* is available on your system.

ConfigFree® is a set of utilities that makes it easy to control communication devices and network connections. ConfigFree also lets you identify communication problems and create profiles for easy switching between locations and communication networks.

NOTE For more information on using ConfigFree, see the ConfigFree online Help.

The ConfigFree utilities include the following:

- ❖ **Connectivity Doctor**—The Connectivity Doctor utility is used to analyze network connections and fix networking problems with your computer. For more information, see [“Connectivity Doctor” on page 175](#).
- ❖ **Profile Settings**—The Profiles utility lets you switch between network configurations. For more information, see [“Profile Settings” on page 176](#).

Getting Started

This section contains information about the ConfigFree® main screen, and how to start and set up ConfigFree.

For more detailed information on setting up and using ConfigFree, see the Help File included in the application.

Starting ConfigFree®

To start ConfigFree®, be sure the computer has a wired or wireless connection. Then perform any of the following steps:

- ❖ Click **Start, All Programs, Toshiba, Networking**, and then **ConfigFree**.
- ❖ Double-click the **ConfigFree** icon  in the Notification Area.
- ❖ Press the **TOSHIBA Assist** button (if applicable to your system) to open the TOSHIBA Assist, and then click the **ConfigFree** icon.
- ❖ Click the **ConfigFree** icon  in the Notification Area, and then click the desired utility.

NOTE

If your computer is not connected to a network, the ConfigFree icon in the Notification Area is displayed with an “X.”

ConfigFree® Utilities

Connectivity Doctor

The Connectivity Doctor lets you analyze your network connections and fix network connection problems. Using Connectivity Doctor, you can view detailed network information by simply moving the mouse pointer.

The Connectivity Doctor works with the following network devices:

- ❖ Wired and wireless network devices
- ❖ Access points

The Connectivity Doctor displays the following information:

- ❖ Status of the PC Network Connections
- ❖ Status of wired and wireless connections
- ❖ Wireless Connection band (a/b/g etc.)

❖ Status of Wireless Connection switch

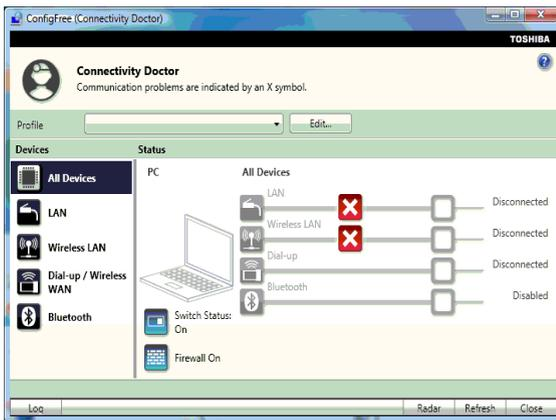

(Sample Image) Connectivity Doctor screen

Profile Settings

The Profile Settings utility lets you save network settings in “profiles.” ConfigFree® profiles are useful for easily switching network settings and devices. You can switch network settings simply by selecting the profile with the desired settings.

If you visit a client company occasionally, for example, you can set up a profile to match that environment and connect to the network. Similarly, users who access networks in the office and at home can set up profiles to handle these networking environments.

A profile contains the currently configured network settings on the computer, as well as information about any network devices. The following settings can be saved (or “captured”) in a profile:

- ❖ **Internet settings**—includes LAN settings (proxy server settings) and the address of a home page that opens automatically when Internet Explorer® starts
- ❖ **Devices**—lets you enable or disable settings of wired and wireless network devices, infrared devices, and set the power status of *Bluetooth*® antennas
- ❖ **TCP/IP settings**—includes DHCP, IP address, subnet mask, default gateway, DNS server, and WINS server settings
- ❖ Personal firewall settings for Internet connections
- ❖ *Bluetooth*® Security Level (for example, high or medium)
- ❖ Enable UAC (User Account Control) setting

To create a profile:

- 1 Click the  icon in the Notification Area.
- 2 Move the pointer to **Profile**.
- 3 Click **Open Settings**.

The ConfigFree Profile Settings window appears.



(Sample Image) ConfigFree Profile Settings window

- 4 Click **Add** to start the Create Profile Wizard.

Chapter 6

If Something Goes Wrong

Some problems you may encounter when using your computer are relatively easy to identify and solve. Others may require help from your network administrator or the manufacturer of the software program.

This chapter aims to help you solve many problems by yourself. It covers the problems you are most likely to encounter.

If all else fails, contact Toshiba. You will find information on Toshiba's support services at the end of this chapter.

Problems that are easy to fix

Your program stops responding.

If you are working with a program that suddenly freezes all operations, chances are the program has stopped responding. You can exit the failed program without shutting down the operating system or closing other programs.

To close a program that has stopped responding:

- 1** Press Ctrl, Alt, and Del simultaneously (once), then click **Start Task Manager**.

The Windows® Task Manager window appears.

- 2 Click the **Applications** tab.

If a program has stopped responding, the words “not responding” appear beside its name in the list.

- 3 Select the program you want to close, then click **End Task**.

Closing the failed program should allow you to continue working. If it does not, continue with the next step.

- 4 Close the remaining programs one by one by selecting the program name, then **End Task**.

To power off your computer:

- 1 Click **Start**, and then click the arrow next to the Lock button in the lower-right part of the Start menu.

The Shut Down menu appears.

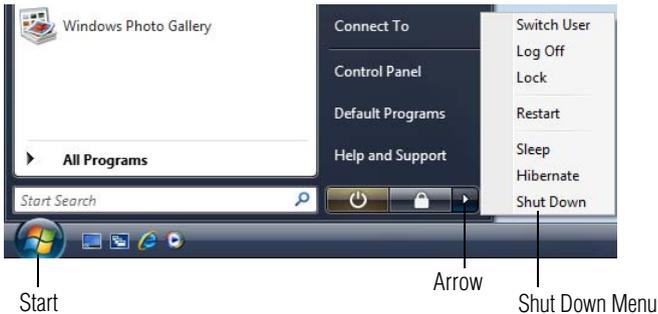

(Sample Image) Shut Down menu

- 2 Click **Shut Down**.

The computer shuts down completely.

Problems when you turn on the computer

These problems may occur when you turn on the power.

The computer will not start.

Make sure you attached the AC adaptor and power cord/cable properly or installed a charged battery.

Press and hold the power button for at least 10 seconds.

If you are using the AC adaptor, check that the wall outlet is working by plugging in another device, such as a lamp.

Verify that the computer is on by looking at the on/off indicator. If the indicator is glowing, the computer is on. Also, try turning the computer off and then on.

If you are using an AC adaptor, verify that the computer is receiving power from the external power source by looking at the AC power light. If the indicator is glowing, the computer is connected to a live external power source.

The computer starts but when you press a key nothing happens.

Verify that the active program accepts text input. Try clicking your mouse on an area where you can type text and try typing again.

Your computer may be in Sleep mode and have a software or resource conflict. When this happens turning the power on returns you to the problem instead of restarting the system. To clear the condition, press Ctrl, Alt, and Del simultaneously. Then shut down the computer via software, or follow the steps if your program stops responding (see [“Problems that are easy to fix”](#) on page 178).

Clearing the condition may get the computer running, but it will not solve a resource conflict. Read the documentation that came with the conflicting device and [“Resolving a hardware conflict”](#) on page 184.

The computer is not accessing the internal storage drive or the optional external diskette drive.

Your computer normally loads the operating system from the internal storage drive. If you have an internal storage drive problem, you will not be able to start the computer. Insert a system diskette into the optional external diskette drive and press F12 when the machine starts and use the arrow keys to select the boot-up device. (You may need to press F12 several times.)

The computer displays the WARNING RESUME FAILURE/Windows Error Recovery – Windows did not shut down successfully message.

To continue, select **Start Windows normally**. This can happen if the computer was put into Sleep mode and the battery has discharged. If you performed a shutdown before this message was displayed, a program or driver may have prevented Windows® from shutting down.

Data stored in the computer’s memory has been lost. Data stored in the computer’s internal storage drive may not be affected.

Always save your data even when you are using Sleep mode. If your battery fully discharges, information that has not been saved will be lost. Your computer can be configured to warn you when the battery is running low see [“What to do when the main battery runs low”](#) on page 115.

If you are running on battery power, it is recommended that you do not leave the computer in Sleep mode for long periods of time.

To charge the battery, leave the computer plugged into a live wall outlet for several hours. For more information see “[Charging batteries](#)” on page 111.

The computer displays the Non-System disk or disk error message.

Make sure there is no diskette in the optional external diskette drive. If there is a diskette in the drive, remove it and press any key to continue. If pressing any key does not work, press Ctrl, Alt, and Del to restart the computer. For more information see “[The computer is not accessing the internal storage drive or the optional external diskette drive.](#)” on page 180.

The AC power light is blinking.

If the AC power light is blinking, try the following steps:

- 1** Cut off power to the computer by disconnecting the AC adaptor and removing the battery. The error condition will be interrupted, and the AC power light will stop flashing.
- 2** Put the battery back into the computer. Do not connect the AC adaptor. Try turning the computer on again.

If the computer starts normally, the AC adaptor may be defective and will need to be replaced (see the Toshiba Web site at accessories.toshiba.com).

If the AC power light starts flashing, remove the battery, and continue with the steps below.

- 3** Connect the AC adaptor to the computer. Leave the battery out of the computer. Try turning the computer on again.

If the computer starts normally, the battery may need charging, may be depleted, or may be defective. Turn the computer on, insert the battery, and then leave the computer running for several hours, which will deliver a slow, steady “trickle-charge” to the battery. Once the battery has been trickle-charged, it may begin working correctly again.

If the trickle-charging does not prove effective, visit the Toshiba Web site at pcsupport.toshiba.com and see the Support Bulletin **Step-Charging the computer’s battery** (click the **Ask Iris**[®] link and search for the support bulletin by name).

- 4** Connect the AC adaptor to a different power outlet, preferably in a different room. If the computer starts normally, there may be a problem with the AC outlet itself, or the voltage level available from it.

- 5 Verify that the AC adaptor is the correct unit for your computer model. The computer may not be able to start from an AC adaptor that is rated for less current (amperage) than the computer requires, even if the rated voltage is correct, and the plug fits correctly in the DC-IN socket. The labels on the bottom of the computer and the AC adaptor show the specifications for voltage ("V") and current ("A") for each device. The voltage level must match exactly. The amperage rating of the AC adaptor must be equal to or greater than that required by the computer.

The Windows® operating system is not working

Once you are familiar with the desktop and used to the way the operating system responds to your work routine, you can easily detect if the operating system is not working correctly. For example:

- ❖ The operating system fails to start after the initial startup appears.
- ❖ The operating system takes a long time to start.
- ❖ The operating system responds differently from the normal routine.
- ❖ The screen does not look right.

Unless a hardware device has failed, problems usually occur when you change the system in some way such as installing a new program or adding a device.

If you experience any of these problems, use the options in the Startup menu to fix the problem.

Using Startup options to fix problems

If the operating system fails to start properly, you may have to change your system's configuration or verify the startup procedure to fix the problem. To do this, use the options in the Startup menu.

To open the Startup menu:

- 1 Restart your computer.
- 2 Press F8 when your computer starts and before Windows® starts loading.

The Windows® Advanced Boot Options menu displays these options:

- ❖ Safe Mode
- ❖ Safe Mode with Networking

- ❖ Safe Mode with Command Prompt
- ❖ Enable Boot Logging
- ❖ Enable low-resolution video (640x480)
- ❖ Last Known Good Configuration (advanced)
- ❖ Directory Services Restore Mode
- ❖ Debugging Mode
- ❖ Disable automatic restart on system failure
- ❖ Disable Driver Signature Enforcement
- ❖ Start Windows® normally

When you highlight each option using the arrow keys, Windows® displays information about each option at the bottom after **Description**.

See your Windows® documentation for further explanation.

NOTE

If your computer is connected to a network, the Startup menu may display different versions of Safe mode.

Internet problems

My Internet connection is very slow.

Many factors contribute to the speed with which you can surf the Internet. They include: network speed, network conditions, time of day (when everyone else is surfing, your access can be slow) and popularity of the sites you are trying to access. If accessing a particular site is very slow, try later.

My browser cannot find the URL address I typed in.

Make sure you separated the domain names of the address with the forward slash (/). Check the spelling of each name and the syntax of the address carefully. A single incorrect letter or missed character will make it impossible for your browser to locate the site.

My browser cannot find a site I bookmarked.

The World Wide Web is constantly changing. A site you bookmarked yesterday may not be available today or its server may be down for temporary repair. Try again later.

The Windows® operating system can help you

If the operating system has started properly but you still have a problem using your computer, the online Help can assist you in troubleshooting the problem.

To access the Windows® operating system Help and Support:

- 1 Click **Start**, then click **Help and Support**, or press F1.
The Help and Support window appears.
- 2 Then do one or both of the following:
 - ❖ In the search field, type in the topic for which you need help and follow the on-screen instructions.
 - ❖ Click one of the options listed in the window and then follow the on-screen instructions.

You can connect to Support Online by clicking **Microsoft Customer Support** or by going to Toshiba support at pcsupport.toshiba.com.

Resolving a hardware conflict

If you receive an error message telling you there is a device driver conflict or a general hardware problem, try using Windows® Help and Support to troubleshoot the problem first.

For help on hardware conflicts:

- 1 Click **Start**, then click **Help and Support**, or press F1.
- 2 Click **Troubleshooting** in the Find an answer section.
A list of category links appears.
- 3 Click a topic under **Hardware and drivers** and follow the steps.

If there is still a problem, the operating system should display a message that explains what the conflict is.

A plan of action

The smooth operation of the system depends on the interaction of all devices, programs, and features. If the system or one of its attached devices is not working, resolving the problem can be time-consuming and frustrating.

The recommended procedure for getting multiple devices to work together is to add and set up one device at a time. After you add each device, test it to make sure it and all previously connected devices work.

The device most recently connected to the system is the one most likely to be causing a conflict.

Resolving conflicts

There are several things you can do to resolve hardware conflicts:

- ❖ Get the most recent drivers from the manufacturer.
- ❖ Disable the device.
For an older device, remove it from the computer.
- ❖ Disable another system component and use its resources for the new device. See “[Fixing a problem with Device Manager](#)” on page 185.
- ❖ Reconfigure the device so that its requirements do not conflict. Refer to the device’s documentation for instructions about changing settings on the device.

Fixing a problem with Device Manager

Device Manager provides a way to check and change the configuration of a device.

CAUTION

Changing the default settings using Device Manager can cause other conflicts that make one or more devices unusable. Device Manager is a configuration tool for advanced users who understand configuration parameters and the ramifications of changing them.

Checking device properties

Device Manager provides a way to view the properties of a device. Properties include the name of the manufacturer, the type of device, the drivers installed, and the system resources assigned to the device.

To check a device’s properties:

- 1 Click **Start, Control Panel, System and Maintenance, System**, and then **Device Manager**.
- 2 To view the device(s) installed, double-click the device type.
- 3 To view the properties, double-click the device.

The operating system displays the Device Properties dialog box, which provides an array of tabs. They may include:

- ❖ The **General** tab, which provides basic information about the device.

- ❖ The **Resources** tab, which lists resources assigned to the monitor, optional external optical drive, optional external diskette drive, and other power-using functions. This tab does not appear if the device is not using resources.
- ❖ The **Driver** tab, which displays the drivers being used by the device. This tab also provides options for updating the driver or rolling back the driver in case the new version is causing a problem.

The tabs that appear in the dialog box vary from one device to another.

For more information about Device Manager, refer to Windows® online Help.

Memory problems

Incorrectly connected or faulty memory modules may cause errors that seem to be hardware or even software related. It is worthwhile checking for these first:

- 1 Click **Start**, and then click the arrow next to the Lock button in the lower-right part of the Start menu.
The Shut Down menu appears.
- 2 Click **Shut Down**.
The computer shuts down completely.
- 3 Remove the memory module, following the instructions in [“Removing a memory module” on page 58](#).
- 4 Reinstall the memory module, following the instructions in [“Installing a memory module” on page 53](#), and making sure the module is seated properly.
- 5 Check for the error again.
- 6 If the error recurs, remove the memory module entirely and check for the error again.

If removing the memory module eliminates the error, the memory module may be faulty. If the error recurs without the memory module installed, the error is not caused by the memory module.



TECHNICAL NOTE: You must have at least one memory module installed for the computer to work.

NOTE

For this model Slot A is the bottom slot. Slot B is the top slot. If only one memory module is to be installed, it must be installed in Slot A.

Power and the batteries

Your computer receives its power through the AC adaptor and power cord/cable or from the system batteries (battery, optional secondary battery, and real-time clock (RTC) battery). Power problems are interrelated. For example, a faulty AC adaptor or power cord/cable will neither power the computer nor recharge the batteries.

Here are some typical problems and how to solve them:

The AC power light does not come on when you plug in the AC adaptor and power cord/cable.

Make sure the AC adaptor and power cord/cable are firmly plugged into both the wall outlet and the computer.

If the AC power light still does not come on, check that the wall outlet is working properly by plugging in a lamp or other appliance.

The AC adaptor and power cord/cable work correctly, but the battery will not charge.

The battery does not charge while the computer is consuming full power. Try turning off the computer.

The battery may not be inserted correctly in the computer. Turn off the computer, remove the battery, clean the contacts with a soft dry cloth (if necessary) and replace the battery. See [“Removing the battery from the computer”](#) on page 119.

The battery may be too hot or too cold to charge properly. If you think this is the probable cause, let the battery reach room temperature and try again.

If the battery has completely discharged, it will not begin charging immediately. Leave the AC adaptor and power cord/cable connected, wait 20 minutes and see if the battery is charging.

If the battery light is glowing after 20 minutes, let the computer continue charging the battery for at least another 20 minutes before you turn on the computer.

If the battery light does not glow after 20 minutes, the battery may have reached the end of its useful life. Try replacing it.

The battery appears not to power the computer for as long as it usually does.

If you frequently repeat shallow charge and discharge, the battery meter may become inaccurate. Let the battery discharge completely, then try charging it again.

Check the power options via your Power Plans (see “Power Plans” on page 117). Have you added a device, such as a PC Card or memory module, that takes its power from the battery? Is your software using the internal storage drive more? Is the display power set to turn off automatically? Was the battery fully charged to begin with? All these conditions affect how long the charge lasts.

After a period of time, the battery will lose its ability to perform at maximum capacity and will need to be replaced. This is normal for all batteries. To purchase a new battery pack, see your accessories information included with your computer, or visit the Toshiba Web site at accessories.toshiba.com. Refer to this site often to stay current on the most recent software and hardware options for your computer, and for other product information.

For more information on maintaining battery power, see “Charging batteries” on page 111.

Keyboard problems

If, when you type, strange things happen or nothing happens, the problem may be related to the keyboard itself.

The keyboard produces unexpected characters.

A keypad overlay may be on. If the numlock light or cursor control mode light is on, press Fn + F10 to turn off the cursor control mode light, or Fn + F11 to turn off the numlock light.

If the problem occurs when both the keypad overlays are off, make sure the software you are using is not remapping the keyboard. Refer to the software documentation and check that the program does not assign different meanings to any of the keys.

You have connected an external keyboard and the operating system displays one or more keyboard error messages.

The keyboard you connected may be defective or incompatible with the computer. Try using a different make of keyboard.

Nothing happens when you press the keys on the external keyboard.

You may have plugged the external keyboard in while the computer was turned on. Using the computer's TouchPad:

- 1 Click **Start**, and then click the arrow next to the Lock button in the lower-right part of the Start menu.

The Shut Down menu appears.

- 2 Click **Restart**.

The computer will restart and recognize the device.

Display problems

Here are some typical display problems and their solutions:

The screen is blank.

Display Auto Off may have gone into effect. Press any key to activate the screen.

You may have activated the instant password feature by pressing Fn and F1 simultaneously. If you have registered a password, press any key, type the password and press Enter. If no password is registered, press any key. The screen reactivates and allows you to continue working.

If you are using the built-in screen, make sure the display priority is not set for an external monitor. To do this, press Fn and F5 simultaneously (once). If this does not correct the problem, press Fn and F5 simultaneously again to return the display priority to its previous setting.



HINT: Holding the Fn key and pressing the F5 key several times will advance you through the display options.

If you are using an external monitor:

- ❖ Check that the monitor is turned on.
- ❖ Check that the monitor's power cord/cable is firmly plugged into a working power outlet.
- ❖ Check that the cable connecting the external monitor to the computer is firmly attached.

- ❖ Try adjusting the contrast and brightness controls on the external monitor.
- ❖ Press Fn and F5 simultaneously to make sure the display priority is not set for the built-in screen.

The screen does not look right.

You can change the display settings by clicking a blank area of the desktop with the secondary control button, then clicking **Personalize**. This opens the Personalization window. Click **Windows Color and Appearance** to choose the colors for the screen. Click **Display settings** to choose the screen resolution.

The built-in screen flickers.

Some flickering is a normal result of the way the screen produces colors. To reduce the amount of flickering, try using fewer colors.

To change the number of colors displayed:

- 1 Right-click in a blank area of the Windows® desktop.
- 2 Click **Personalize**, and then **Display Settings**.
- 3 Change the Colors option and click **OK**.

For more information see Windows® Help.

A message displays saying that there is a problem with your display settings and that the adapter type is incorrect or the current settings do not work with your hardware.

Reduce the size of the color palette to one that is supported by the computer's internal display.

To change the display properties:

- 1 Right-click in a blank area of the Windows® desktop.
- 2 Click **Personalize**, and then **Display Settings**.
- 3 Adjust the screen resolution and/or color quality.
- 4 Click **OK**.

The display mode is set to Simultaneous and the external display device does not work.

Make sure the external monitor is capable of displaying at resolutions of 800 x 600 or higher. Devices that do not support this resolution will only work in Internal/External mode, and not simultaneous mode.

Small bright dots appear on your TFT display when you turn on your computer.

Small bright dots may appear on your screen display when you turn on your computer. Your display contains an extremely large number of thin-film transistors (TFT) and is manufactured using high-precision technology. Any small bright dots that may appear on your display are an intrinsic characteristic of the TFT manufacturing technology. Over a period of time, and depending on the usage of the computer, the brightness of the screen will deteriorate. This is also an intrinsic characteristic of the screen technology. When the computer is operated on battery power, the screen will dim and you may not be able to increase the brightness of the screen while on battery power.

Disk or internal storage drive problems

Problems with the internal storage drive or with a diskette drive usually show up as an inability to access the drive or as sector errors. Sometimes a drive problem may cause one or more files to appear to have garbage in them. Typical problems are:

You are having trouble accessing a drive, or one or more files appear to be missing.

Make sure you are identifying the drive by its correct name (A: or C:).

Error-checking

Run Error-checking, which analyzes the directories, files and File Allocation Table (FAT) on the disk and repairs any damage it finds.

To run Error-checking:

- 1 Click **Start**, and then **Computer**.
- 2 Right-click the drive you want to check.
- 3 On the pop-up menu, click **Properties**.

The drive's Properties box appears.

NOTE This feature is not available for optical drives.

- 4 Click the **Tools** tab.
- 5 Click the **Check now** button.
The Check Disk box appears.

- 6 You can choose one or both options:
 - ❖ Automatically fix file system errors
 - ❖ Scan for and attempt recovery of bad sectors

- 7 Click **Start**.

Error-checking tests and repairs the disk.

Your hard disk seems very slow.

If you have been using your computer for a long time, your files may have become fragmented. Run Disk Defragmenter.

To do this, click **Start, All Programs, Accessories, System Tools**, and then **Disk Defragmenter**. After it opens, click **Defragment now**.

Your data files are damaged or corrupted.

Refer to your software documentation for file recovery procedures. Many software packages automatically create backup files.

You may also be able to recover lost data using utility software. Consult your network administrator.

Some programs run correctly but others do not.

This is probably a configuration problem. If a program does not run properly, refer to its documentation and check that the hardware configuration meets its needs.

A diskette will not go into the optional external diskette drive.

You may already have a diskette in the drive. Make sure the drive is empty.

You may be inserting the diskette incorrectly. Hold the diskette with the hub side facing down, and insert it so that the metal head window cover goes into the drive first.

The metal cover or a loose label may be obstructing the path into the drive. Carefully inspect the diskette. If the metal cover is loose, replace the diskette. If the label is loose, replace the label and try inserting the diskette again.

The drive cannot read a diskette.

Try another diskette. If you can access the second diskette, the first diskette (not the drive) is probably causing the problem. Run Error-checking on the faulty diskette (for instructions see [“Disk or internal storage drive problems” on page 191](#)).

Optical drive problems

You cannot access a disc in the drive.

If the optical drive is an external drive, make sure that the drive's cable is properly connected to the computer.

Make sure the tray that holds the optical disc is closed properly. Press gently until it clicks into place.

Open the tray and remove the disc. Make sure the tray is clean. Any dirt or foreign object can interfere with the laser beam.

Examine the disc to see if it is dirty. If necessary, wipe it with a clean cloth dipped in water or a neutral cleaner.

Replace the disc in the tray. Make sure that the disc is lying flat, label side up. Close the tray carefully, making sure it has shut completely.

You press the disc eject button, but the drive tray does not slide out.

Make sure the computer is connected to a power source and turned on. The optical drive eject mechanism requires power to operate.

Make sure a program is not accessing the drive and preventing it from ejecting.

If you need to remove a disc and cannot turn on the computer (for example, if the battery is completely discharged), use a narrow object, such as a straightened paper clip, to press the manual eject button. This button is in the small hole next to the optical drive eject button on the face of the optical drive tray.

CAUTION

Never use a pencil to press the manual eject button. Pencil lead can break off inside the computer and damage it.

Some discs run correctly but others do not.

Check that the type of disc you are using is compatible with your optical drive. For more information regarding supported optical media formats, refer to the complete detail specifications for your computer at pcsupport.toshiba.com.

If the problem is with an optical data disc, refer to the software's documentation and check that the hardware configuration meets the program's needs.

The disc will not come out of the drive when you click the eject button on the screen.

Press the button on the optical drive itself. For additional information see [“You press the disc eject button, but the drive tray does not slide out.”](#) on page 193.

Sound system problems**No sound is coming from the computer’s speakers.**

Adjust the volume control.

Try pressing Fn + Esc to see if volume mute is disabled.

Check that the volume control on the computer is turned up.

If you are using external headphones or speakers, check that they are securely connected to your computer.

The computer emits a loud, high-pitched noise.

This is feedback between the microphone and the speakers. It occurs in any sound system when input from a microphone is fed to the speakers and the speaker volume is too loud. Adjust the volume control.

PC Card problems

PC Cards (PCMCIA-compatible) include many types of devices, such as a removable hard disk, additional memory, or a pager.

Most PC Card problems occur during installation and setup of new cards. If you are having trouble getting one or more of these devices to work together, several sections in this chapter may apply.

Resource conflicts can cause problems when using PC Cards. See [“Resolving a hardware conflict”](#) on page 184.

If your system does not have built-in drivers for your PC Card and the card did not come with an operating system driver, it may not work under the operating system. Contact the manufacturer of the PC Card for information about using the card under the operating system.

PC Card checklist

- ❖ Make sure the card is inserted properly into the slot.
- ❖ Make sure all cables are securely connected.
- ❖ Occasionally a defective PC Card slips through quality control. If another computer with a PC Card slot is available, try the card in that machine. If the card malfunctions again, it may be defective.

Resolving PC Card problems

Here are some common problems and their solutions:

The slot appears to be dead. PC Cards that used to work no longer work.

Check the PC Card status:

- 1 Click **Start, Control Panel, System and Maintenance**, and then **Device Manager**.
- 2 Double-click the appropriate PC Card, which will be listed under one of the categories shown, for example: Disk drives, Network adapters, Other, etc.

The operating system displays your PC Card's Properties dialog box, which contains information about your PC Card configuration and status.

The computer stops working (hangs) when you insert a PC Card.

The problem may be caused by an I/O (input/output) conflict between the PCMCIA socket and another device in the system. Use Device Manager to make sure each device has its own I/O base address. See [“Fixing a problem with Device Manager” on page 185](#) for more information.

Since all PC Cards share the same socket, each card is not required to have its own address.

Hot swapping (removing one PC Card and inserting another without turning the computer off) fails.

Follow this procedure before you remove a PC Card:



- 1 Click the **Safely Remove Hardware** icon in the Notification Area.
The Safely Remove Hardware screen appears.
- 2 Click **Safely remove** for the device you want to swap.

- 3 Select the item you wish to remove and click **OK**.
 - 4 Remove the device when told it is safe to do so.
-

CAUTION

Never swap modules when the computer is in Hibernation or Sleep mode. This is known as “warm swapping” and is not supported. For more information on Hibernation and Sleep modes see [“Hibernation mode” on page 79](#) and [“Sleep mode” on page 80](#).

The system does not recognize your PC Card.

Refer to the PC Card documentation.

Removing a malfunctioning card and reinstalling it can correct many problems.

A PC Card error occurs.

Reinsert the card to make sure it is properly connected.

If the card is attached to an external device, check that the connection is secure.

Refer to the card’s documentation, which should contain a troubleshooting section.

Printer problems

This section lists some of the most common printer problems.

The printer will not print.

Check that the printer is connected to a working power outlet, turned on and ready (on line).

Check that the printer has plenty of paper. Some printers will not start printing when there are just two or three sheets of paper left in the tray.

Make sure the printer cable is firmly attached to the computer and the printer.

Run the printer’s self-test to check for any problem with the printer itself.

Make sure you installed the proper printer drivers as shown in [“Setting up a printer” on page 76](#) or in the instructions that came with the printer.

You may have connected the printer while the computer is on. Disable Sleep mode, turn off the computer, and turn off the printer. Turn the printer back on, make sure it is online, and then turn the computer back on.

Try printing another file. For example, you could create and attempt to print a short test file using Notepad. If a Notepad file prints correctly, the problem may be in your original file.

If you cannot resolve the problem, contact the printer's manufacturer.

The printer will not print what you see on the screen.

Many programs display information on the screen differently from the way they print it. See if your program has a print preview mode. This mode lets you see your work exactly as it will print. Contact the software manufacturer for more information.

Modem problems

This section lists common modem problems.

The modem will not receive or transmit properly.

Make sure the cable from the modem to the telephone line is firmly connected to the computer's modem port and the telephone line jack.

Check the communications parameters (baud rate, parity, data length and stop bits) specified in the communications program. It should be set up to transmit at 300, 1200, 2400, 4800, 9600, 14400, 28800, 33600 bps (bits per second) or higher. Refer to the program's documentation and the modem manual for information on how to change these settings.

The modem is on, set up properly but still does not transmit or receive data.

Make sure the line has a dial tone. Connect a telephone handset to the line to check this.

The other system may be busy or off line. Try making a test transmission to someone else.

For more information regarding your system's V.92 modem, visit the Toshiba Web site at pcsupport.toshiba.com.

Wireless networking problems

NOTE

This section provides general troubleshooting tips for networking problems, specifically wireless (Wi-Fi®) networking.

The terms and concepts used assume a basic understanding of networks, and may be for more advanced users. If you need assistance or if you are not familiar with the terminology, please see Windows® Help and Support or contact your computer technician.

- ❖ If your computer is equipped with an internal Wi-Fi® adapter, verify that the Wireless antenna ON/OFF switch is ON (the wireless indicator light  will be lit).
 - ❖ Verify that your computer can detect access points or routers. If it can detect a Wi-Fi® access point or router then it may be a configuration issue.
-

NOTE

To determine if your computer has an internal Wi-Fi® adapter, check the device list in Device Manager (part of the Windows® Control Panel, Hardware and Sound). Some Toshiba models may have a Wireless antenna ON/OFF switch even though they do not have an internal Wi-Fi® adapter.

- ❖ Verify that signal strength is good using the utility provided with the Wi-Fi® adapter.
- ❖ If another computer is on the same network, verify that it has network access, and can connect to the Internet. If, for example, the other computer cannot browse to a public Web site, the ISP's (Internet Service Provider) service may be disrupted.
- ❖ Verify that the Service Set Identifier (SSID), or network name, is correct—i.e., that it matches the SSID assigned to the access point you are attempting to connect through. SSIDs are case-sensitive. Toshiba provides a Client Manager utility for setting and managing SSIDs.
- ❖ Check the Control Panel's Hardware and Sound Device Manager to verify that the Wi-Fi® adapter is recognized by the Windows® operating system, and that the driver is loaded. Carefully note any error messages—these will be very helpful if you should confer with a support technician at a later time.

- ❖ Verify that the network connection is configured to obtain its Internet Protocol (IP) address dynamically:
 - 1 Click **Start**, and then **Network**.
 - 2 Click **View Status**.
 - 3 Click **Details**.
 - 4 Verify that the **DHCP Enabled** setting is set to **Yes**.
 - 5 Click **Close**.
- ❖ Use IPCONFIG to verify that the computer has a useful IP address—one other than the private address of 169.254.xxx.xxx assigned by Windows®.
 - 1 Click **Start** to open the Start menu.
 - 2 Type `Cmd` in the search field.
 - 3 At the top-left of the Start menu, click `cmd.exe` to open the command prompt.
 - 4 Enter `IPCONFIG /ALL` and press Enter.

The IP address for each active network adapter will be displayed.
- ❖ Connect your computer directly to your router or broadband modem, by plugging a standard CAT5 Ethernet patch cable (sold separately) into your computer's RJ45 Ethernet port. If your connection problem disappears, the problem lies in the Wi-Fi® part of your network.
- ❖ Use the PING command to verify a connection to the gateway at 192.168.1.1 (a default gateway for most wireless routers).
 - 1 Click **Start** to open the Start menu.
 - 2 Type `Cmd` in the search field.
 - 3 At the top-left of the Start menu, click `cmd.exe`.
 - 4 Enter `PING 192.168.1.1` at the command prompt, and press Enter.
 - 5 If “Request Timed Out” or another error message appears in response, then the problem is probably Wi-Fi®-related.
- ❖ If you have enabled any security provisions (closed system, MAC address filtering, Wired Equivalent Privacy [WEP], etc.), check the access point vendor's Web site for recent firmware upgrades. Problems with WEP keys, in particular, are frequently addressed in new firmware releases.

The Windows® operating system wireless management facility does not work.

If you are using an external Wi-Fi® adapter (a PC Card, USB adapter, or other variety), check if the adapter comes with its own management utility. If it does, the utility may be disabling the Windows® operating system wireless management facility, in which case you must use the adapter's management utility. If the documentation that accompanies the adapter does not provide enough information to determine if this is the case, contact that vendor's support group for further advice.

DVD operating problems

If you experience a problem playing DVDs, you may be able to fix the problem yourself.

For general problems playing a DVD title, try the following steps:

- 1 Verify that the disc is in a format that the drive supports.
- 2 Ensure that the disc is properly inserted in the drive tray.
- 3 Use the DVD Player software that came with your computer to view DVD movies.
- 4 Clean the disc and try again.

A dirty drive can also cause audio problems. If you have tried several discs and all fail, consider sending your drive to an authorized service provider to get it cleaned.

- 5 Verify that your computer recognizes your optical drive by clicking **Start**, and then **Computer**. The optical drive should appear in the list.
- 6 See “[Checking device properties](#)” on page 185 for instructions on using Device Manager to view the optical drive properties.
- 7 Check the Toshiba Web site for new information on optical drives and their operation.

A blank screen appears while watching a DVD-ROM movie or title.

Change the setting for when to turn off the display using the following steps:

- 1 Click **Start**, **Control Panel**, **System and Maintenance**, and then **Power Options**.
- 2 Click **Choose when to turn off the display**.

- 3 Select **Never** on When to turn off the display.
- 4 Click **Save changes**.

The screen saver runs while you are watching a movie or title.

If the screen saver is enabled, it runs on top of any movie or title you are watching. To disable the screen saver:

- 1 Right-click on the desktop and click **Personalize** in the menu.
- 2 Select **None** for the screen saver.
- 3 Click **OK**.

Develop good computing habits

Save your work frequently.

You can never predict when your computer will lock, forcing you to close a program and lose unsaved changes. Many software programs build in an automatic backup, but you should not rely solely on this feature. Save your work! See [“Computing tips” on page 91](#) for instructions.

On a regular basis, back up the information stored on your internal storage drive.

Use Windows® to back up files, or the entire computer, to an optical disc, or external hard disk. Here are some ways you can do this:

- ❖ Use the Windows® operating system to back up files or your entire computer to an optical disc, or external hard disk.
- ❖ Copy files to a rewritable external storage device.
- ❖ Connect your computer to the office network and copy files to your network partition.

Some people use a combination of these methods, backing up all files to tape weekly and copying critical files to diskette on a daily basis.

If you have installed your own programs, you should back up these programs as well as your data files. If something goes wrong that requires you to reformat your internal storage drive and start again, reloading all your programs and data files from a backup source will save time.

Read the user’s guides.

It is very difficult to provide a fail-safe set of steps you can follow every time you experience a problem with the computer. Your ability to solve problems will improve as you learn about how the computer and its software work together.

Get familiar with all the user's guides provided with your computer, as well as the manuals that come with the programs and devices you purchase.

Your local computer store or book store sells a variety of self-help books you can use to supplement the information in the manuals.

Data and system configuration backup in the Windows® operating system

The Windows® operating system offers some easy-to-use features for backing up your Windows® settings and your data—documents and other important files. Take advantage of these features to protect yourself from much more difficult and time-consuming restoration procedures, and to safeguard your valuable data from loss.

Saving system configuration with Restore Points

The System Restore feature of the Windows® operating system quickly creates Restore Points—'snapshots' of your Windows® operating system configuration—and saves them for later recall. If you experience problems after installing some new hardware or software, you can easily select a previously established Control Point to 'turn back the clock,' restoring the Windows® operating system to the state it was in just prior to the installation. This is much easier and more effective than uninstalling the hardware or software, which often leaves behind unwanted files and settings. It is also easy to undo a Restore Point selection, if you change your mind.

Follow these steps to create a Restore Point using the System Restore utility:

- 1 Click **Start, All Programs, Accessories, System Tools**, and then **System Restore**.
- 2 Click **open System Protection**.

The System Protection tab of the System Properties window appears.

-
- 3 Click **Create**.
 - 4 In the input field, enter a name that is descriptive enough to be easily understood in the future, such as “Before installing Brand X Accounting app.” Then click **Create**.
 - 5 The Windows® operating system creates the Restore Point, automatically stamps it with the current date and time, and displays a message that the restore point was successfully created.
 - 6 Click **OK**.

Then, at a later time, you can re-establish your Windows® configuration using the saved Restore Point. To do this:

- 1 Click **Start, All Programs, Accessories, System Tools**, and then **System Restore**.
- 2 Click **Next**.
- 3 A list of previously created Restore Points displays, showing the timestamp and description of each Restore Point.

NOTE

This list may contain Restore Points that you did not create. Restore Points labeled System Checkpoint were automatically created by the Windows® operating system. Other Restore Points may have been created automatically by applications when they were installed.

- 4 Select the Restore Point you want to use, and then click **Next**. The utility displays the timestamp and description of the selected Restore Point.
- 5 Verify that the Restore Point you selected is the correct one. If it is not, click **Back** to return to step 4.
- 6 Close all programs and save all open files.
- 7 Click **Finish**, and then **Yes** to begin the system restore.
- 8 Your Windows® operating system configuration will now be restored to the state it was in when the chosen Restore Point was created, and then the computer will be automatically restarted.

Backing up your data or your entire computer with the Windows® operating system

The most valuable component of your computer system is the data you create and store on its internal storage drive. Since problems with either hardware or software can make the data inaccessible or even destroy it, the next most valuable component of your computer system may be a recent backup of your data.

Fortunately, the Windows® operating system offers a convenient way to back up your computer or just your important files to optical drives, or hard drives. An external hard drive is recommended in case the internal storage drive fails. No additional software is required. Most of the optical drives built into recent Toshiba portable computer models can write to (or ‘burn’) as well as read from optical discs. External optical disc writers are also widely available.

Follow these steps to back up your computer or files to optical discs, or a storage drive:

NOTE You cannot back up the computer while running on battery power. Connect the AC adaptor before continuing.

- 1 Prepare your backup target by connecting it and/or inserting a blank optical disc in the drive.
- 2 Click **Start**.
- 3 Click **Control Panel**.
- 4 Click **System and Maintenance**.
- 5 Click **Backup and Restore Center**.
- 6 You can choose to back up some files or the entire computer. Click either **Back up files** or **Back up computer**.

NOTE If you choose to back up your entire computer, you will be setting up a scheduled backup that will be performed periodically, and will only include the changes made since the last backup.

- 7 Follow the on-screen help to complete your backup.

For more help, click **Start, Help and Support**, and search for “back up.”

General tips for installing hardware and software

Here are a few tips to help ensure safe and easy installation of new hardware (printers, pointing devices, external hard drives, DVD writers, scanners, etc.) and software (applications like Microsoft® Office and Adobe® Photoshop®, or utility software such as special toolbars for your web browser).

- ❖ Create a Restore Point (refer to “[Saving system configuration with Restore Points](#)” on page 202). Before installing anything, use the System Restore utility to set a Restore Point (see the section titled Restore Points). If anything goes wrong, you will then be able to easily restore the Windows® operating system to the state it was in prior to the installation, undoing any changes that the installation process introduced.
- ❖ Back up your critical data (see “[Backing up your data or your entire computer with the Windows® operating system](#)” on page 204).
- ❖ Have your factory Restore/Reconfiguration CD(s) on hand in case you need any files from them (available on certain models).
- ❖ Do not guess—follow directions carefully! It is often necessary to run an installation utility first—before connecting a new hardware item to the computer. If the device is connected first, it may be very difficult to complete the installation successfully. Always carefully follow the installation instructions that accompany the hardware or software.
- ❖ Restart the Windows® operating system. Always restart the Windows® operating system after each installation, even if the installation utility does not prompt you to do so. This will ensure that the installation is completed, and will clean up anything that the installation utility left behind.
- ❖ Do one installation at a time. If you have several new items to add to your computer system, install just one at a time, creating Restore Points immediately before each successive installation. This will make it much easier to determine the origin of any new problems. For best results, follow this sequence:
 - 1** Back up critical data.
 - 2** Create a Restore Point.
 - 3** Install one item of hardware or software.

- 4 Restart the Windows® operating system.
- 5 Use the new hardware or software for a while, noting any new problems. Make sure that your critical applications (e-mail, business applications, etc.) are working correctly, and verify that important devices are still functioning.
- 6 For each additional hardware or software item, repeat these steps, starting at step 1 if any of your critical data has changed, or starting at step 2 if no critical data has changed.

The eSATA device is not recognized from Sleep or Hibernation mode.

A connected eSATA device may not be recognized if it is connected to the computer's eSATA/USB combo port while the computer is in Sleep mode or Hibernation mode. If this occurs, disconnect the eSATA device and then reconnect the device while the computer is turned on.

NOTE Before connecting the eSATA device to your computer and external power source, read the documentation that came with the device and follow the manufacturer's instructions.

If you need further assistance

If you have followed the recommendations in this chapter and are still having problems, you may need additional technical assistance. This section contains the steps to take to ask for help.

Before you contact Toshiba

Since some problems may be related to the operating system or the program you are using, it is important to investigate other sources of assistance first.

Try the following before you contact Toshiba:

- ❖ Review the troubleshooting information in your operating system documentation.
- ❖ If the problem occurs while you are running a program, consult the program's documentation for troubleshooting suggestions. Contact the software company's technical support group for their assistance.
- ❖ Consult the dealer from whom you purchased your computer and/or program. Your dealer is your best source for current information.

For the detailed specifications for your computer, visit pcsupport.toshiba.com. Go to the Tech Support Center, select your particular model from the list and go to the Detailed Specifications for that model.

For the number of a Toshiba dealer near you in the United States, call: (800) 457-7777.

Contacting Toshiba

If you still need help and suspect that the problem is hardware-related, Toshiba offers a variety of resources to help you.

Toshiba's Technical Support Web site

For technical support, or to stay current on the most recent software and hardware options for your computer, and for other product information, be sure to regularly check the Toshiba Web site at pcsupport.toshiba.com.

Toshiba voice contact

Before calling Toshiba, make sure you have:

- ❖ Your computer's serial number
- ❖ The computer and any optional devices related to the problem
- ❖ Backup copies of your Windows® operating system and all other preloaded software on your choice of media
- ❖ Name and version of the program involved in the problem along with its installation media
- ❖ Information about what you were doing when the problem occurred
- ❖ Exact error messages and when they occurred

For technical support, call the Toshiba's Customer Support Center:

Within the United States at (800) 457-7777

Outside the United States at (949) 859-4273

Other Toshiba Internet Web sites

toshiba.com	Worldwide Toshiba corporate site
computers.toshiba.com	Marketing and product information in the USA
accessories.toshiba.com	Accessories information in the USA
www.toshiba.ca	Canada
www.toshiba-Europe.com	Europe
www.toshiba.co.jp/index.htm	Japan
http://servicio.toshiba.com	Mexico and all of Latin America

Toshiba's worldwide offices

Australia

Toshiba (Australia) Pty. Limited
84-92 Talavera Road
North Ryde NSW 2113
Sydney
Australia

France

Toshiba Systèmes (France) S.A.
7, Rue Ampère; B. P. 131
92800 Puteaux Cédex
France

Italy

Centro Direzionale Colleoni
Palazzo Perseo
Via Paracelso 10
20041, Agrate Brianza
Milano, Italy

Latin America and Caribbean

Toshiba America Information
Systems
9740 Irvine Blvd.
Irvine, California 92618
USA

800-457-7777 (within the US)

949-859-4273 (outside of the US -
this call may incur long-distance
charges)

Canada

Toshiba Canada Ltd.
191 McNabb Street
Markham, Ontario
L3R - 8H2
Canada

Germany

Toshiba Europe GmbH
Leibnizstraße 2
D-93055 Regensburg
Germany

Japan

Toshiba Corporation, PCO-IO
1-1, Shibaura 1-Chome
Minato-Ku, Tokyo, 105-8001
Japan

Mexico

Toshiba de México S.A. de C.V.
Sierra Candela No.111, 6to. Piso
Col. Lomas de Chapultepec.
CP 11000 Mexico, DF.

Spain

Toshiba Information Systems
(España) S.A.
Parque Empresarial San Fernando
Edificio Europa, 1a Planta
Escalera A
28831 (Madrid) San Fernando de
Henares
Spain

United States

Toshiba America Information
Systems, Inc.
9740 Irvine Boulevard
Irvine, California 92618
United States

United Kingdom

Toshiba Information Systems
(U.K) Ltd.
Toshiba Court
Weybridge Business Park
Addlestone Road
Weybridge, Surrey KT15 2UL
United Kingdom

The Rest of Europe

Toshiba Europe (I.E.) GmbH
Hammfelddamm 8
D-4-1460 Neuss
Germany

For more information on additional Toshiba worldwide locations,
please visit: www.toshiba.co.jp/index.htm.

Appendix A

Hot Keys/TOSHIBA Cards

Hot keys and TOSHIBA Cards provide a quick way to modify selected system functions and to launch applications.

There are two types of TOSHIBA Cards: Hot Key Cards and Application Cards.

Hot Key Cards

The Hot Key Cards are used to set or modify the following system functions:

- ❖ Mute
- ❖ Lock (Instant security)
- ❖ Power Plan
- ❖ Sleep
- ❖ Hibernation
- ❖ Output (Display switch)
- ❖ Brightness control
- ❖ Wireless
- ❖ TouchPad
- ❖ Zoom (Display resolution)

Using the Hot Key Cards

The Hot Key Cards are normally hidden from view. The Cards appear when you press the Fn key.

NOTE

Hot keys are keys that, when pressed in combination with the Fn key, turn system functions on and off. Hot keys have a legend on the key indicating the option or feature the key controls.

To use the Hot Key Cards:

- 1 Press and hold the Fn key.

The TOSHIBA Cards appear along the top of the screen.



(Sample Image) Hot Key Card display

- 2 Double-click the Card for the system function to be modified.
The selected Card is displayed full-size with its available options below it. All other Cards are again hidden from view.
- 3 Click the desired option.

To use a Hot Key Card using a hot key:

- 1 Press and hold the Fn key.
- 2 Press the hot key associated with the desired function.

The associated hot key card appears at the top of the screen with its available options below it.

- 3 To cycle through the displayed options, hold down Fn and press the hot key repeatedly. Release the Fn key when the desired option is selected.

Application Cards

The Application Cards are used to launch these applications:



TOSHIBA Assist

For more information, refer to “[TOSHIBA Assist](#)” on page 143.



TOSHIBA HDD Protection utility

For more information, refer to “[TOSHIBA HDD Protection Utility](#)” on page 156.



PC Diagnostic Tool utility

For more information, refer to “[TOSHIBA PC Diagnostic Tool Utility](#)” on page 155.



ConfigFree utility

For more information, refer to “[ConfigFree®](#)” on page 174.



Bluetooth settings

This Application Card launches your *Bluetooth*® settings.



TOSHIBA Zooming utility

For more information, refer to “[TOSHIBA Zooming Utility](#)” on page 166.



Disc Creator utility

This Application Card launches the TOSHIBA Disc Creator utility.



TOSHIBA Hardware Setup utility

For more information, refer to “[TOSHIBA Hardware Setup](#)” on page 161.



TOSHIBA Button Support utility

For more information, refer to “[TOSHIBA Button Support](#)” on page 167.

NOTE Not all functions are supported on all models.

Using the Application Cards

To launch an application using the Application Cards:

- 1 Press and hold the Fn key.

The TOSHIBA Cards display at the top of the screen.



(Sample Image) TOSHIBA Card display

- 2 Click the “stacked” card on the far right of the display. The Application Cards are hidden under this card.
The Application Cards appear, and the Hot Key Cards are stacked under the Card on the far left.



(Sample Image) Application Card display

- 3 Click the Card for the application Card to appear.
- 4 Click the full-size Card to launch the application.

Card Case

The Card Case feature allows you to choose which cards appear in the Application Card display (see [“Using the Application Cards” on page 213](#)). To use the Card Case:

- 1 Click **Start, All Programs, Toshiba, Utilities**, and then **Settings for Flash Cards**.



(Sample Image) Enabling and Disabling Application Cards

- 2 Click the **Open cards case** button.
- 3 The Card Case displays two rows of Cards.
Cards that appear solid (not transparent) in the bottom row are enabled and can be selected when the Application Cards are displayed. The top row contains all of the disabled cards.
- 4 To enable a card, drag it from the top row to the bottom row.
To disable the card, drag it from the bottom row to the top row.
- 5 To close the Card Case, click the  icon in the top corner of the screen.

Hot key functions

Hot key functions are performed using either the Hot Key Cards or by pressing the associated hot key. This section lists the available hot key functions.

NOTE

Hot keys are keys that, when pressed in combination with the Fn key, turn system functions on and off. Hot keys have a legend on the key indicating the option or feature the key controls.

Volume Mute



or



This TOSHIBA Card or hot key enables/disables volume mute on your computer.

When volume mute is enabled, no sound will come from the speakers or headphones.

Selecting this Card or pressing the hot key displays the following options:



(Sample Image) Volume Mute options

- ❖ To enable mute, select .
- ❖ To disable mute, select .

Lock (Instant security)



or



(Sample Image) Security options

- ❖ To enable lock, select .
- ❖ To cancel, select .

The Fn + F1 hot key function activates instant security. The user logon screen will appear and a user with a valid account will need to log back on to gain access to the computer.

Power plan



or



This TOSHIBA Card or hot key displays the power plans and cycles through the power plans.

The properties of each power plan, and the power plans that are displayed by this function, are set in the Power Options window.

Selecting this Card or pressing the hot key displays the currently selectable power plans:



(Sample Image) Power Plan options

Cycle through the power plans, then select the desired power plan.

Sleep mode



or



This TOSHIBA Card or hot key places the computer into Sleep mode.

For more information about Sleep mode, please see [“Using and configuring Sleep mode”](#) on page 85.

Selecting this Card or pressing the hot key displays the following options:



(Sample Image) Sleep options

- ❖ To enable Sleep mode, select .
- ❖ To cancel, select .

Hibernation mode



or



This TOSHIBA Card or hot key places the computer into Hibernation mode.

If Hibernation mode is disabled, this hot key will not respond. For more information on Hibernation mode, see “Using and configuring Hibernation mode” on page 83.

Selecting this Card or pressing the hot key displays the following options:



(Sample Image) Hibernation options

- ❖ To enable Hibernation mode, select .
- ❖ To cancel, select .

Output (Display switch)



or



This TOSHIBA Card or hot key cycles through the power-on display options (only the first option is available when you do not have an external monitor attached) (the last option is available only if you are in Extended Display Mode).

NOTE

Some modes are only available with the appropriate device attached and turned on.

- ❖ LCD—Internal display only
- ❖ LCD + CRT—Internal display and external monitor simultaneously
- ❖ CRT—External monitor only
- ❖ LCD + CRT Multi Monitor—Internal display and external monitor, with one acting as the primary display and the other as an extended desktop
- ❖ Swap—Switch primary display between internal display and external monitor when using extended desktop

To use a simultaneous mode, you must set the resolution of the internal display panel to match the resolution of the external display device.

Selecting this Card or pressing the hot key displays the following options:



(Sample Image) Display mode options window

Cycle through the display modes, then select the desired mode.

Not all functions are supported on all models.

NOTE

Some systems also support an additional Swap Image Display mode. This mode is available only if the current setting is an extended desktop mode (Built-in Display and External Monitor, or Built-in Display and TV). In extended desktop mode, the image is split into two sides, one side per display device. To swap sides, select Swap Image Display.

Display brightness



This TOSHIBA Card decreases or increases the screen brightness.



This hot key decreases the screen brightness.



This hot key increases the screen brightness.

Selecting this Card or pressing either hot key displays the following options:



(Sample Image) Display brightness

Move the slider or press the appropriate hot key repeatedly to decrease or increase the display brightness.

Disabling or enabling wireless devices



or



This TOSHIBA Card or hot key enables/disables the optional wireless devices installed in your computer.

The wireless modes are:

- ❖ Wi-Fi® enabled—Enables just the Wi-Fi® module.
- ❖ *Bluetooth*® enabled—Enables just the *Bluetooth*® module.
- ❖ All disabled—Disables the *Bluetooth*® and Wi-Fi® modules.
- ❖ All enabled—Enables the *Bluetooth*® and Wi-Fi® modules.

Selecting this Card or pressing the hot key displays the following options:



(Sample Image) Wireless communication options

- ❖ To enable Wi-Fi®, select .
- ❖ To enable *Bluetooth*®, select .
- ❖ To enable all, select .
- ❖ To disable all, select .
- ❖ To cancel, select .

Disabling or enabling the Toshiba Dual Pointing Device



or



This TOSHIBA Card or hot key enables/disables the Toshiba Dual Pointing Device.

For more information on using the Toshiba Dual Pointing Device, see [“Using the Toshiba Dual Pointing Device”](#) on page 71.

Selecting this Card or pressing the hot key displays the following options:



(Sample Image) Disable or Enable Toshiba Dual Pointing Device options

- ❖ To enable the Toshiba Dual Pointing Device, select .
- ❖ To disable the Toshiba Dual Pointing Device, select .

Zoom (Display resolution)



or

Fn +  [Space bar]

This TOSHIBA Card or hot key switches screen resolution.

Selecting this Card or pressing the hot key displays the following options:



(Sample Image) Screen resolution options

Cycle through the screen resolutions, then select the desired resolution.

Keyboard hot key functions



This hot key turns the cursor control overlay on and off.



This hot key turns the numeric overlay on and off.



This hot key turns the scroll lock feature on and off.



This hot key turns the TOSHIBA Zooming Utility to zoom-out.



This hot key turns the TOSHIBA Zooming Utility to zoom-in.

Appendix B

Power Cord/Cable Connectors

Your computer ships with the correct power supply for the country of purchase. This appendix shows the shapes of the typical AC power cord/cable connectors for various parts of the world.

USA and Canada



UL approved
CSA approved

United Kingdom

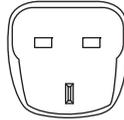

BS approved

Australia



AS approved

Europe



VDA approved
NEMKO approved

Appendix C

TOSHIBA PC Health Monitor

The TOSHIBA PC Health Monitor software program monitors computer system functions such as power consumption, the cooling system and the 3D Accelerometer. It alerts users to specific system conditions via pop-up messages. It also tracks the usage of the computer and related devices and logs service relevant information on the computer's internal storage drive.

The collected information includes device operation time and number of Actuations or status changes (i.e.: number of power button and Fn key combination uses, AC adaptor, battery, LCD, fan, HDD, sound volume, wireless communication switch, docking and USB information), date of initial system use, and also computer and device usage (i.e.: power settings, battery temperature and recharging, CPU, memory, backlight illumination time, and temperatures for various devices). The stored data uses a very small portion of the total hard disk capacity (approximately 3 MB or less per year).

This information is used to identify and provide a notification of system conditions that may affect the performance of your Toshiba computer. It may also be used to help diagnose problems should the computer require service by Toshiba or Toshiba's authorized service providers. Additionally, Toshiba may also use this information for quality assurance analysis.

Subject to the use restrictions above, the internal storage drive data logged may be transferred to entities located outside of your country or region of residence (e.g., European Union). Those countries may or may not have the same data protection laws or data protection levels as required by your home country or region.

Once enabled, you may disable the TOSHIBA PC Health Monitor at any time by uninstalling the software via Add/Remove Programs in the Windows® Control Panel. Doing so will automatically delete all collected information from the internal storage drive.

The TOSHIBA PC Health Monitor software does not extend or modify Toshiba's obligations under its standard limited warranty in any way. Toshiba's standard limited warranty terms and limitations apply.

Enabling the TOSHIBA PC Health Monitor

- 1 To enable the TOSHIBA PC Health Monitor, do one of the following:
 - ❖ Click **Start, All Programs, TOSHIBA, Utilities**, and then **PC Health Monitor**.
 - ❖ Click the TOSHIBA PC Health Monitor icon in the notification area, then click the message **TOSHIBA PC Health Monitor is not enabled. Please click here for more details.***

The TOSHIBA PC Health Monitor explanation screen displays.

- 2 Click **Next**, The “TOSHIBA PC Health Monitor Software Notice & Acceptance” screen displays. Read the information displayed carefully.
- 3 If you agree with the terms and conditions of use, select **Enable this software program now** and click **OK**. By enabling the PC Health Monitor software, you agree with the terms and conditions listed in the “TOSHIBA PC Health Monitor Software Notice & Acceptance” screen and to the use and sharing of the collected information. Once the program is enabled, the TOSHIBA PC Health Monitor screen is displayed, and the program will begin monitoring system functions and collecting information.

*This message will no longer be displayed after clicking **Enable this software program now** or **Disable this software program now** on the “TOSHIBA PC Health Monitor Software Notice & Acceptance” screen.

If a TOSHIBA PC Health Monitor message is displayed

A message will be displayed if any changes that may interfere with the operation of a program are detected. Follow the on-screen instructions.

For example, if the following message is displayed, use the numbered procedures to remedy the problem:

Please click [OK] to run the TOSHIBA Cooling Performance Diagnostic Tool to check the cooling performance of your PC.

- 1 Click **OK** to start the “TOSHIBA Cooling Performance Diagnostic Tool.”
- 2 If the “It is possible that the computer's cooling performance has decreased. And if you have access to the cooling module on your system; please clean the cooling module according to the instructions in your User's Guide” message is displayed after running the “TOSHIBA Cooling Performance Diagnostic Tool,” the cooling module requires cleaning. If there is no access to the cooling module, skip to step 4. Refer to “[Cleaning the cooling module](#)” section.

NOTE Access to the cooling module is available on certain models.

- 3 After cleaning the cooling module, run the **TOSHIBA Cooling Performance Diagnostic Tool** again.
Click **Start, All Programs, TOSHIBA, Utilities**, and then **TOSHIBA Cooling Performance Diagnostic Tool**.
- 4 If you are prompted to run the cooling diagnostic tool again, Toshiba recommends that you turn off the computer and contact TOSHIBA support. See “[If you need further assistance](#)” on page 206 for contact information.

It is possible that the computer cooling performance has decreased. We strongly recommend you have your computer checked by a Toshiba Authorized Service Provider. If you must use the computer for a short period of time before taking it to the Toshiba Authorized Service Provider, we recommend that you change the cooling method setting. Go to **TOSHIBA Power Saver Settings, Cooling Method**, then select **Battery Optimized**. This PC Cooling Performance Diagnostic Tool does not in any way expand or modify Toshiba's obligations under its standard limited warranty. Toshiba's standard limited warranty terms and limitations apply.

Cleaning the cooling module

The following information is dependent on if access to the cooling module is available. Access is available on certain models only.

NOTE

If you use the computer for a long period, the inside of the computer may become hot. Always allow the computer to cool to room temperature before you clean the cooling module.

To clean the cooling module, follow the steps detailed below:

- 1 Shut down the computer and make sure the Power indicator is off (refer to “Turning off the computer” on page 78 in the Getting Started chapter, if necessary).
- 2 Remove the AC adaptor and all cables and peripherals connected to the computer.
- 3 Close the display panel and turn the computer upside down.
- 4 Remove the battery pack (refer to “Removing the battery from the computer” on page 119 in the Mobile Computing chapter, if necessary).
- 5 Depending on your model, use either a thin-tipped tool to push the hole at the edge of the cooling module cover, or a screwdriver to remove the screw, and then slide the cover in the direction of the arrow to remove it.

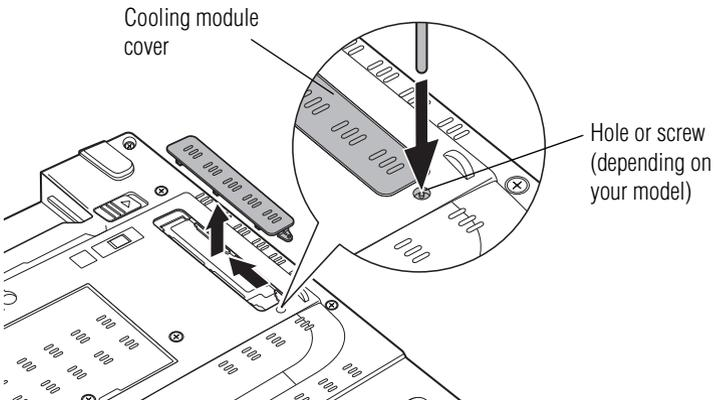

(Sample Illustration) Removing the cooling module cover

- 6 Clean the cooling module using a small vacuum designed for computers, or other cleaning tool.

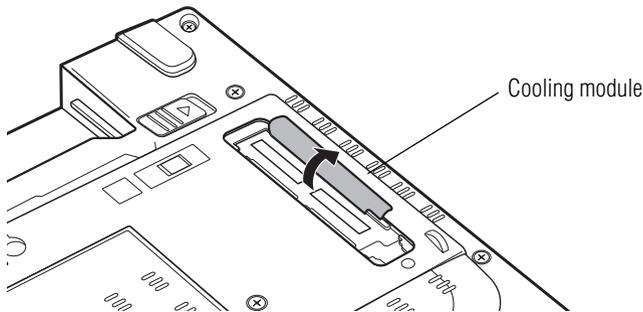

(Sample Illustration) Cooling module

NOTE Do not use a ballpoint pen or cotton swab for cleaning. It may clog the cooling module.

- 7 Slide the cooling module cover back into place on the computer to reattach it and/or secure it using the screw.
- 8 Re-install the battery pack (refer to [“Inserting a charged battery”](#) on page 121 in the Mobile Computing chapter, if necessary).
- 9 Turn your computer right side up.
- 10 Reconnect any cables that were removed in Step 2.
- 11 Restart your computer.

Glossary



TECHNICAL NOTE: Some features defined in this glossary may not be available on your computer.

Acronyms

The following acronyms may appear in this user's guide.

AC	alternating current
BIOS	basic input/output system
bps	bits per second
CD	compact disc
CD-ROM	compact disc read-only memory
CD-RW	compact disc rewrite memory
CMOS	complementary metal-oxide semiconductor
COM1	communications port 1 (serial port)
COM2	communications port 2 (serial port)
CPU	central processing unit
DC	direct current
DMA	direct memory access
DIMM	dual inline memory module

DOS	disk operating system
DPI	dots per inch
DSTN	dual supertwist nematic
DVD	digital versatile (or video) disc
DVD-ROM	digital versatile (or video) disc read-only memory
ECP	enhanced capabilities port
EPROM	erasable programmable read-only memory
FAT	file allocation table
FCC	Federal Communications Commission
GB	gigabyte
HDD	hard disk drive
HTML	Hypertext Markup Language
IEEE	Institute of Electrical and Electronics Engineers
I/O	input/output
IRQ	interrupt request
ISP	Internet service provider
KB	kilobyte
LAN	local area network
LCD	liquid crystal display
LPT1	line printer port 1 (parallel port)
LSI	large-scale integration
MB	megabyte
MIDI	Musical Instrument Digital Interface
PC	personal computer
PCI	Peripheral Component Interconnect
PCMCIA	Personal Computer Memory Card International Association
RAM	random access memory
RFI	radio frequency interference
ROM	read-only memory
RTC	real-time clock
SCSI	small computer system interface

SDRAM	synchronous dynamic random access memory
SRAM	static random access memory
SSD	Solid State Drive
SVGA	super video graphics adapter
TFT	thin film transistor
USB	universal serial bus
URL	uniform resource locator
WAN	wide area network
www	World Wide Web

Terms

The following terms may appear in this user's guide.

A

active-matrix display — A liquid crystal display (LCD) made from an array of liquid crystal cells using active-matrix technology. Also known as a “TFT display,” in its simplest form there is one thin film transistor (TFT) for each cell. This type of display works well with computers because of its shallow depth and high-quality color. Active-matrix displays are viewable from wider angles than most passive-matrix displays.

adapter — A device that provides a compatible connection between two units. For example, the computer's internal display adapter receives information from the software and translates it into images on the screen. An adapter can take a number of forms, from a microprocessor to a simple connector. An intelligent adapter (one that is capable of doing some processing) may also be called a controller.

alternating current (AC) — The type of power usually supplied to residential and commercial wall outlets. AC reverses its direction at regular intervals. Compare *direct current (DC)*.

application — A computer program that you use to perform tasks of a specific type. Applications include word processors, spreadsheets, and database management systems. See also *program*.

B

backup — A copy of a file, usually on a removable disk, kept in case the original file is lost or damaged.

basic input/output system (BIOS) — See *BIOS*.

baud rate — The speed at which a communication device, such as a printer or modem, transmits information. Baud rate is the number of signal changes per second (not necessarily the same as bits per second). See also *bits per second*.

BIOS (basic input/output system) — Basic instructions, stored in read-only memory (ROM), containing the information the computer needs to check hardware and load the operating system when you start up the computer.

bits per second (bps) — A way of measuring the speed at which information is passed between two devices. This is the basic unit of measure used in modem communications, and is similar, but not identical, to the baud rate. See also *baud rate*.

boot — To start the computer. The term “boot” originates from bootstrap program (as in “pulling itself up by its bootstraps”), a program that loads and initializes the operating system. See also *reboot*.

boot disk — See *system disk*.

boot priority (startup sequence) — The order in which the computer accesses its internal storage drives to locate the startup files. Under the default startup sequence, the computer looks for the startup files in the diskette drive before checking the internal storage drive.

bus — An electrical circuit that connects the central processing unit (CPU) with other parts of the computer, such as the video adapter, disk drives, and ports. It is the pathway through which data flows from one device to another. See also *bus speed*, *frontside bus*.

bus speed — The speed at which the central processing unit (CPU) communicates with the other parts of the computer.

C

cache — A section of very fast memory in which frequently used information is duplicated for quick access. Accessing data from cache is faster than accessing it from the computer’s main memory. See also *CPU cache*, *L1 cache*, *L2 cache*.

CD — An individual compact disc. See also *CD-ROM*.

CD-ROM (compact disc read-only memory) — A form of high-capacity storage that uses laser optics instead of magnetic means for reading data. See also *CD*. Compare *DVD-ROM*.

central processing unit (CPU) — The chip that functions as the “brain” of the computer. It takes information from outside sources, such as memory or keyboard input, processes the information, and sends the results to another device that uses the information.

character — Any letter, number, or symbol you can use on the computer. Some characters are non-printing characters, such as a paragraph break in a word-processing program. A character occupies one byte of computer storage.

chip — A small piece of silicon containing computer logic and circuits for processing, memory, input/output, and/or control functions. Chips are mounted on printed circuit boards.

click — To press and release the pointing device’s primary button without moving the pointing device. In the Windows® operating system, this refers to the pointing device’s left button, unless otherwise stated. See also *double-click*.

color palette — A set of specified colors that establishes the colors that can be displayed on the screen at a particular time.

compatibility — The extent to which computers, programs, or devices can work together harmoniously, using the same commands, formats, or language as another.

configuration — (1) The collection of components that make up a single computer system. (2) How parts of the system are set up (that is, configured).

controller — A device that controls the transfer of data from a computer to a peripheral device and vice versa. For example, disk drives, monitors, keyboards, and printers all require controllers.

CPU — See *central processing unit (CPU)*.

CPU cache — A section of very fast memory residing between the CPU and the computer’s main memory that temporarily stores data and instructions the CPU will need to execute commands and programs. See also *cache*, *L1 cache*, *L2 cache*.

cursor — A symbol that indicates the current position on the screen. The shape of the cursor varies, depending on the program you are using and what you are doing.

- D**
- default** — The setting selected by a program when the user does not specify an alternative setting.
- device** — A component attached to the computer. Devices may be external (outside the computer's case) or internal (inside the computer's case). Printers, disk drives, and modems are examples of devices.
- device driver** — A program (called a "driver") that permits a computer to communicate with a device.
- dialog box** — An on-screen window displayed by the operating system or a program giving a direction or requesting input from the user.
- direct current (DC)** — The type of power usually supplied by batteries. DC flows in one direction. Compare *alternating current (AC)*.
- direct memory access (DMA)** — A dedicated channel, bypassing the CPU, that enables direct data transfer between memory and a device.
- directory** — See *folder*.
- disable** — To turn a computer option off. See also *enable*.
- disc** — A round, flat piece of material, designed to be read from and written to by optical (laser) technology, and used in the production of optical discs, such as CDs and DVDs. Compare *disk*.
- disk** — A round, flat piece of material that can be magnetically influenced to hold information in digital form, and used in the production of magnetic disks, such as diskettes and hard disks. Compare *disc*. See also *diskette*, *hard disk*.
- disk drive** — The device that reads and writes information and programs on a diskette or hard disk. It rotates the disk at high speed past one or more read/write heads.
- diskette** — A thin, flexible disk in a protective jacket that stores magnetically encoded data. Diskettes can be removed from the computer and come in two sizes: 5.25-inch and 3.5-inch. Your computer uses 3.5-inch diskettes. See also *double-density diskette*, *high-density diskette*.
- document** — Any file created with an application and, if saved to disk, given a name by which it can be retrieved. See also *file*.

double-click — To press and release the pointing device's primary button rapidly twice without moving the pointing device. In the Windows® operating system, this refers to the pointing device's left button, unless otherwise stated.

double-density diskette — A 3.5-inch diskette that can hold up to 720 KB of information (half the capacity of a high-density diskette). See also *diskette*, *high-density diskette*.

download — (1) In communications, to receive a file from another computer through a modem or network. (2) To send font data from the computer to a printer. See also *upload*.

drag — To hold down the mouse button while moving the cursor to drag a selected object. In the Windows® operating system, this refers to the left mouse button, unless otherwise stated.

driver — See *device driver*.

DVD — An individual digital versatile (or video) disc. See also *DVD-ROM*.

DVD-ROM (digital versatile [or video] disc read-only memory) — A very high-capacity storage medium that uses laser optics for reading data. Each DVD-ROM can hold as much data as several CD-ROMs. Compare *CD-ROM*.

E

emulation — A technique in which a device or program imitates another device or program.

enable — To turn on a computer option. See also *disable*.

executable file — A computer program that is ready to run. Application programs and batch files are examples of executable files. Names of executable files usually end with a .bat or .exe extension.

expansion device — A device that connects to a computer to expand its capabilities. Other names for an expansion device are port expander, port replicator, docking station, or network adapter.

extension — See *file extension*.

external device — See *device*.

-
- F**
- file** — A collection of related information, saved on disk with a unique name. A file may be a program, information used by a program, or a document. See also *document*.
- file allocation table (FAT)** — The section of a storage drive that keeps track of the location of stored files.
- file name** — A set of characters that uniquely identifies a file within a particular folder. It consists of two parts: the actual name and the file name extension. See also *file extension*.
- file extension** — The three characters following the period (pronounced “dot”) at the end of a file name. The extension indicates the type of file. Examples are .exe for program files and .hlp for help files. See also *file name*.
- folder** — Also called directory. A container for organizing files saved to a disk. A folder is symbolized on screen by a graphical image (icon) of a file folder. A folder can contain files and other folders.
- format** — (verb) To prepare a blank disk for use with the computer’s operating system. Formatting creates a structure on the disk so the operating system can write information to the disk or read information from it.
- frontside bus** — The primary pathway (bus) between the CPU and the computer’s main memory. Also called “system bus.” See also *bus*.
- function keys** — The keys labeled F1 through F12, typically located on the keyboard. Their function is determined by the operating system and/or individual programs.
- G**
- ground** — A conductor to which all components of an electric circuit are connected. It has a potential of zero (0) volts, is connected to the earth, and is the point of reference for voltages in the circuit.
- H**
- hard disk** — A storage device composed of a rigid platter or platters that can be magnetically coded with data. Hard disks hold much more information than diskettes and are used for long-term storage of programs and data. The primary (or only) hard disk in a computer is usually fixed, but some computers have secondary hard disks that are removable.
- hardware** — The physical components of a computer system. Compare *software*.

Hibernation — A feature of many Toshiba computers that saves to the internal storage drive the current state of your work, including all open files and programs, when you turn the computer off. When you turn on the computer again, your work is returned to the same state it was when the computer was turned off. See also *Sleep*, *Suspend*.

high-density diskette — A 3.5-inch diskette that holds 1.44 MB of data. See also *diskette*.

hot key — (1) A feature in which certain keys in combination with the Fn key can set system options or control system parameters, such as the battery save mode. (2) A key or combination of keys that activates a memory resident program.

hot swapping — The ability to add or remove devices from a computer while the computer is running and have the operating system automatically recognize the change.

I icon — A small image displayed on the screen that represents a function, file, or program.

interlaced — A method of refreshing a computer screen, in which only every other line of pixels is refreshed. Interlaced monitors take two passes to create a complete screen image. Compare *non-interlaced*.

internal device — See *device*.

Internet — The decentralized, world-wide network of computers that provides electronic mail, the World Wide Web, and other services. See also *World Wide Web*.

K keyboard shortcut — A key or combination of keys that you use to perform a task instead of using a pointing device such as a mouse.

L L1 (level one) cache — Memory cache built into the processor to help improve processing speed. See also *cache*, *CPU cache*, *L2 cache*.

L2 (level two) cache — Memory cache installed on the motherboard to help improve processing speed. It is slower than L1 cache and faster than main memory. See also *cache*, *CPU cache*, *L1 cache*.

LAN (local area network) — A group of computers or other devices dispersed over a relatively limited area and connected by a communications link that enables any device to interact with any other on the network.

liquid crystal display (LCD) — A type of display that uses a liquid substance between two transparent electrode panels. When an electric current passes through the electrodes, the molecules in the liquid form a crystalline pattern that polarizes the light passing through it. A filter over the electrodes permits only non-polarized light to pass to the surface of the display, creating light and dark pixels.

load — To move information from a storage device (such as a hard disk) into memory for processing.

local area network — See *LAN*.

logical drive — A section of a disk that is recognized by the operating system as a separate disk drive. A system's logical drives may differ from its physical drives. For example, a single hard disk drive may be partitioned into two or more logical drives.

M

memory — Typically refers to the computer's main memory, where programs are run and data is temporarily stored and processed. Memory can be volatile and hold data temporarily, such as RAM, or it can be nonvolatile and hold data permanently, such as ROM. A computer's main memory is RAM. See *RAM*, *ROM*.

microprocessor — See *central processing unit (CPU)*.

MIDI (Musical Instrument Digital Interface) — A standard for connecting musical instruments, synthesizers, and computers. The MIDI standard provides a way of translating music into a form computers can use, and vice versa.

modem — Short for "modulator/demodulator." A device that converts information from digital to analog, and back to digital, enabling information to pass back and forth between digital computers and analog telephone lines.

motherboard — The computer's main circuit board that contains the processor, memory, and other primary components.

MS-DOS prompt — See *system prompt*.

multi-function drive — A DVD drive that can read and write to CD and DVD media.

multimedia — A combination of two or more media, such as sound, animation, and video in a computer program or presentation.

Musical Instrument Digital Interface — See *MIDI*.

- N** **network** — A collection of computers and associated devices that are connected by communications facilities. A network allows you to share data and peripheral devices, such as printers, with other users and to exchange electronic mail.
- non-interlaced** — A method of refreshing a computer screen, in which each pixel of every line is refreshed as the electron beam scans across and down the screen. Compare *interlaced*.
- non-system disk** — A disk for storing programs and data that cannot be used to start the computer. Compare *system disk*.
- O** **online** — Available through the computer. Online may refer to information being read from your own computer's internal storage drive, such as online documentation or online Help, or to information coming from another company on a company network or the Internet.
- operating system** — A set of programs that controls how the computer works. Examples of operating systems are the Windows Vista[®] Ultimate and Windows Vista[®] Home Basic operating systems.
- optical drive** — A drive which reads plastic coated discs on which information is recorded digitally, and uses a laser to read data, music, or videos.
- P** **palette** — See *color palette*.
- parallel** — Processes that occur simultaneously. In communications, it means the transmission of more than one bit of information at a time. On your computer, the parallel port provides a parallel communications interface between the computer and an appropriate device. Most modern printers are parallel. Compare *serial*.
- password** — A unique string of characters entered by a user to verify his or her identity to the computer or the network.
- PC Card** — A credit-card-sized expansion card designed to increase the capabilities of computers. PC Cards provide functions such as modem, fax/modem, hard disk drive, network adapter, sound card, or SCSI adapter.
- peripheral** — Any device, such as a printer or joystick, that is attached to the computer and controlled by the computer's CPU.
- pixel** — Short for "picture element." The smallest dot that can be produced on a screen or printer.

Plug and Play — Generally, refers to the computer's ability to automatically configure itself to work with peripheral devices. When capitalized, refers to a standard that, when followed by a device manufacturer, allows a computer to configure itself automatically to work with the device.

pointing device — Any device, such as the TouchPad or a mouse, that enables you to move the cursor on the screen.

port — A socket on the computer where you plug in a cable for connection to a network or a peripheral device.

processor — See *central processing unit (CPU)*.

program — A set of instructions that can be executed by a computer. The general classes of programs (also called software) are operating system, application, and utility. See also *operating system, application, utility*.

properties — The attributes of an object or device. For example, the properties of a file include the file's type, size, and creation date.

R

RAM (random access memory) — *Volatile* memory that can be written to as well as read. *Volatile* here means that information in RAM is lost when you turn off your computer. This type of memory is used for your computer's main memory. See also *memory*. Compare *ROM*.

random access memory — See *RAM*.

read-only memory — See *ROM*.

reboot — See *boot, restart*.

removable disk — A disk that can be removed from a disk drive. A diskette is one example of a removable disk.

resolution — A measure of the sharpness of the images that can be produced by a printer or displayed on a screen. For a printer, resolution is expressed in dots per inch (dpi). For a screen, it is expressed as the number of pixels available horizontally and vertically.

restart — Synonymous with reboot. To reset the computer by reloading the operating system without turning the computer off. See also *boot*.

RJ11 — A modular connector used on most U.S. telephone systems and direct-connect modems. The RJ11 connector is a 6-wire connector.

ROM (read-only memory) — Non-volatile memory that can be read but not written to. *Non-volatile* here means that information in ROM remains whether or not the computer is receiving power. This type of memory is used to store your computer's BIOS, which is essential instructions the computer reads when you start it up. See also *BIOS, memory*. Compare *RAM*.

S select — To highlight or otherwise specify text, data, or graphics with the intent to perform some operation on it.

serial — Processes that occur one at a time. In communications, it means the transmission of one bit at a time sequentially over a single channel. On your computer, the serial port provides a serial interface between the computer and an appropriate device. Compare *parallel*.

shortcut — See *keyboard shortcut*.

Sleep — A feature of some Windows® operating systems that allows you to turn off the computer without exiting your open applications and to continue from where you left off when you turn the computer on again.

software — See *program*. Compare *hardware*.

solid state drive — A data storage device that utilizes solid-state memory as opposed to a hard disk (see *hard disk*). Much like hard disks, solid state drives hold much more information than diskettes and are used for storage of programs and data.

Suspend — A feature of some Windows® operating systems that allows you to turn off the computer without exiting your open applications and to continue from where you left off when you turn the computer on again.

system disk — A diskette that contains the operating system files needed to start the computer. Any diskette can be formatted as a system disk. A system disk is also called a “bootable disk” or a “startup disk.” Compare *non-system disk*.

system prompt — The symbol (in the MS-DOS® operating system, generally a drive letter followed by a “greater than” sign) indicating where users are to enter commands.

T **TFT display** — See *active-matrix display*.

U **universal serial bus (USB)** — USB is a serial bus that supports a data transfer rate of up to 480 Mbps (480 million bits per second). USB can connect up to 127 peripheral devices through a single all-purpose USB port. USB allows hot swapping of peripherals. See also *bus*, *hot swapping*, *serial*.

upload — To send a file to another computer through a modem or network. See also *download*.

USB — See *universal serial bus (USB)*.

utility — A computer program designed to perform a narrowly focused operation or solve a specific problem. Utilities are often related to computer system management.

W **Web** — See *World Wide Web*.

Wi-Fi® — A registered trademark term of the Wi-Fi Alliance that stands for Wireless Fidelity, and is another term for the communication protocol to permit an Ethernet connection using wireless communication components.

World Wide Web (www) — The worldwide network of Web sites linked together over the Internet. A user of the Web can jump from site to site regardless of the location of the computer hosting the site. See also *Internet*.

Index

A

- AC adaptor 47
- AC power
 - connecting adaptor 48
- accessories
 - docking solutions 141
 - memory 52
- Accupoint®
 - using 72
- adding memory 52
- Alt keys 94
- Application Cards 212
- audio
 - files 134
- audio features 134

B

- backing up files 92
- battery
 - changing 119
 - charge indicator light 49, 113
 - charge not lasting 188
 - charging 47, 49
 - conserving power 116
 - disposal 124
 - low charge 115
 - monitoring power 49, 113
 - not charging 187
 - notifications 115
 - power plan 217
 - power plan hot key 118
 - real-time clock (RTC) 110
 - removing 119

BIOS Setup

see TOSHIBA Hardware Setup

Bridge Media Adapter

- inserting memory media 139
- removing memory media 140

button

- power 52, 62
- start 128

C

- CD, using 101
- character keys 93
- charging the battery 49
- checking device properties 185
- click 73
- communications
 - network connection 130

- set up 129
- computer
 - caring for 88
 - cleaning 89
 - moving 89
 - non-system disk or disk error message 181
 - not accessing disk drives 180
 - running on battery power 109
 - setting up 44, 54
 - warning resume failure message 180
- computer lock 89
- computing tips 91
- ConfigFree® 174
- connecting to a power source 47
- connection
 - set up 130
- control buttons 73
- Ctrl keys 94
- D**
- desktop
 - creating new icon 127
 - major features 127
- desktop exploration 126
- desktop icons 127
- Device Manager 185
 - checking properties 185
- devices
 - keyboard 75
 - mouse 75
- Disk Defragmenter 192
- disk drive
 - corrupted/damaged data files 192
 - missing files/trouble accessing a disk 191
 - running slow 192
- diskette drive
 - cannot insert a diskette 192
 - cannot read a diskette 192
 - connecting 77
 - external, connecting 77
- display
 - does not look normal/flickers 190
 - external monitor not working 190
 - screen is blank 189
- display device
 - external 73
- display output settings 74
- display, external
 - adjusting 75
- disposal information 27
- disposing of used batteries 124
- double-click 73
- DVD player
 - general problems 200
- DVD, using 101
- E**
- ENERGY STAR® 36
- error messages
 - device driver conflict 184
 - general hardware problem 184
 - non-system disk or disk error 181
 - problem with display settings/current settings not working with hardware 190
 - warning resume failure 180
- Error-checking 191
- eSATA
 - connecting to the eSATA/USB combo port 206
- expansion capability 141
- exploring the desktop 126
- external
 - monitor
 - not working 190
 - mouse 75
- external diskette drive
 - connecting 77
- external display, adjusting 75
- F**
- FAT (File Allocation Table) 191

- file extensions 100
- file, backing up 92
- files
 - backing up 101
 - printing 100
 - restoring 101
 - saving 98
- fingerprint
 - authentication 171
- fingerprint Authentication Utility
 - using 171
- Fn keys 94
- function keys 94
- H**
- hardware conflicts 184
 - resolving 185
- headphones
 - using 135
- Help and Support
 - Windows® operating system 184
- Hibernation mode 79
 - configuring 83
 - starting again from 85
- hot key
 - display brightness 221
 - Hibernation mode 219
 - keyboard overlays 225
 - Lock (Instant security) 216
 - Output (Display switch) 220
 - power plan 217
 - Sleep mode 218
 - volume mute 215
 - Zoom (Display resolution) 224
 - zooming 225
- Hot Key Cards 210
- Hot key functions 214
- hot key power plan 118
- http 132
- I**
- i.LINK® port 140
- icon 127
 - desktop 127
 - moving to desktop 127
 - recycle bin 127
 - safety 39
- installation
 - memory module 53
- installing
 - memory modules 52
 - mouse 75
- instant passwords, using 149
- Internet
 - bookmarked site not found 183
 - connecting to 133
 - features 133
 - slow connection 183
 - surfing 133
 - uploading and downloading files 134
 - URL address not found 183
 - using 132
- Internet Service Providers 132
- ISPs 132
- J**
- jack
 - RJ-11 131
- K**
- keyboard
 - character keys 93
 - function keys 94
 - hot keys 225
 - not working 180
 - overlay keys 95
 - special Windows® keys 94
 - troubleshooting 188
 - using 93
- keyboard, external 75
- keyboard, full-size 93
- L**
- lock
 - computer, using 89

M

- main battery
 - removing 119
- memory
 - adding 52
 - problem solving 186
 - removing memory module slot
 - cover 55
- memory module
 - inserting 56
 - installation 53
 - removing 60
- memory module slot 55
- microphone 134
- modem
 - connecting to telephone line 130
 - problem solving 197
- monitor 73
 - connecting 73
 - not working 189
- mouse
 - installing 75
- mouse utility 160

N

- network
 - accessing 130
 - Connect to the Internet 130
- networking
 - wireless 129
- Notification Area 128

O

- Opening the display panel 50
- optical disc positioning 104
- optical discs
 - handling 104
 - inserting 103
 - removing 106
- optical drive
 - problems 193
 - troubleshooting 193
 - using 101

- optical media
 - recording 105
- other documentation 40
- overlay keys 95

P

- password
 - deleting a supervisor 151
 - disabling a user 152
 - setting a user 151
 - supervisor
 - set up 150
 - types 149
- passwords
 - instant, using 149
 - setting 149
- PC Card
 - checklist 195
 - computer stops working 195
 - configuring 138
 - errors 196
 - hot swapping fails 195
 - inserting 136
 - not recognized 196
 - problem solving 194, 195
 - removing 137
 - setting up 138
- port
 - RGB 73
- power
 - computer will not start 179
 - connecting cable to AC adaptor
 - 48
 - cord/cable connectors 226
 - energy-saving features 108
 - problem solving 187
 - turning on 51
- power button 52, 62
- power plan
 - hot key 118
- power plans 117
- power source 47

- connecting 48
 - powering down
 - using Hibernation 83
 - using Shut Down 81
 - using Sleep 85
 - precautions 42
 - primary button 72, 73
 - printer
 - connecting 76
 - problem solving 196, 197
 - printing a file 100
 - problem solving
 - AC power 187
 - accessing disk drives 180
 - battery charge does not last 188
 - battery not charging 187
 - cannot insert diskette in drive 192
 - cannot read a diskette 192
 - changing display properties 190
 - checking device properties 185
 - computer hangs when PC Card inserted 195
 - computer will not power up 179
 - contacting Toshiba 206, 207
 - corrupted/damaged data files 192
 - Device Manager 185
 - disk drive is slow 192
 - display is blank 189
 - external display not working 190
 - external monitor 189
 - faulty memory 186
 - hardware conflict 184
 - high-pitched noise 194
 - Internet bookmarked site not found 183
 - Internet connection is slow 183
 - keyboard
 - not responding 180
 - missing files/trouble accessing a disk 191
 - modem not receiving or transmitting 197
 - no sound 194
 - non-system disk or disk error 181
 - PC Card 194
 - checklist 195
 - error occurs 196
 - hot swapping fails 195
 - not recognized 196
 - slot appears dead 195
 - power and batteries 187
 - printer 196, 197
 - program not responding 178
 - program not working properly
 - 192
 - screen does not look right/flickers
 - 190
 - Startup options 182
 - URL address not found 183
 - warning resume failure 180
 - Windows® operating system not working 182
 - program, starting 96
 - programs
 - not running correctly 192
 - projector 73
 - connecting 73
- R**
- real-time clock (RTC) battery 110
 - recording
 - sounds 134
 - recording sounds 134
 - recycle bin icon 127
 - registering computer 46
 - removing
 - main battery 119
 - RJ-11 jack 131
 - running the computer on battery power 109
- S**
- safety
 - computer 125
 - disposing of batteries 124

- icons 39
- precautions 42
- saving files 98
- screen
 - blank 189
 - does not look normal/flickers 190
- secondary button 72, 73
- set up communications 129
- setting up
 - adding memory 52
 - computer 44, 54
 - work environment 41
- setting up a connection 130
- Sleep mode 80
 - hot key 218
 - starting again from 88
- Smart Card Reader 138
- sound
 - problem solving 194
- sounds
 - recording 134
- speakers
 - using external 135
- start button 128
- Start Search field 98
- starting a program 96
 - Start Search field 98
 - Windows® Explorer 97
 - Windows® Start menu 96
- starting up the computer
 - from Shut down 83
 - from Sleep 88
- Startup menu
 - problem solving 182
- supervisor password, deleting 151
- supervisor password, set up 150
- S-video 73

T

- Taskbar 128
- telephone line
 - connecting to modem 130

- television
 - adjusting display 75
- Toshiba
 - registering computer 46
 - worldwide offices 208
- TOSHIBA Assist 143
- Toshiba Dual Pointing Device 71
- TOSHIBA Hardware Setup 161
- Toshiba online resources 107
- traveling tips 125
- troubleshooting
 - DVD player
 - general problems 200
 - external keyboard 188
 - keyboard 188
 - keypad overlay 188
 - optical drive 193
- turning on the computer 51
- turning on the power 51

U

- USB Sleep and Charge Utility 163
- user password, disabling 152
- user password, setting 151
- using 134
- using a file extension 100
- using the Toshiba Dual Pointing Device 71

Utilities 142

V

- video projector
 - adjusting display 75

W

- warranty
 - standard limited warranty 40
- Web 132
- Web Camera 136
- Web sites 207
- Wi-Fi®
 - wireless networking 129
- Windows® Explorer 97
- Windows® operating system

Help and Support 184

 problem solving 182

Windows® operating system desktop
 126

Windows® Start menu 96

wireless networking 129

Wizards

 Connect to the Internet 130

World Wide Web 132

www 132

Free Manuals Download Website

<http://myh66.com>

<http://usermanuals.us>

<http://www.somanuals.com>

<http://www.4manuals.cc>

<http://www.manual-lib.com>

<http://www.404manual.com>

<http://www.luxmanual.com>

<http://aubethermostatmanual.com>

Golf course search by state

<http://golfingnear.com>

Email search by domain

<http://emailbydomain.com>

Auto manuals search

<http://auto.somanuals.com>

TV manuals search

<http://tv.somanuals.com>