

TOSHIBA

Leading Innovation >>>

User's Manual

R850/R840/R830

Table of Contents

Preface

General Precautions

Chapter 1

Getting Started

Equipment checklist	1-1
Getting Started	1-2

Chapter 2

The Grand Tour

The Grand Tour for R850	2-1
The Grand Tour for R840	2-12
The Grand Tour for R830	2-23
Internal Hardware Components	2-34

Chapter 3

Operating Basics

TOSHIBA Dual Pointing Device	3-1
The Keyboard	3-2
Using the Fingerprint Sensor	3-8
Optical disc drives	3-15
Using Corel Digital Studio for TOSHIBA	3-24
TOSHIBA VIDEO PLAYER	3-25
Using WinDVD BD for TOSHIBA	3-28
Wireless communications	3-30
LAN	3-33
Optional devices	3-35
ExpressCard	3-35
Smart Card	3-37
Memory media slot	3-38
Memory media	3-39
Media care	3-40
Inserting a memory media	3-41
Removing a memory media	3-41
Additional memory module	3-42
External monitor	3-46
HDMI	3-47
DisplayPort	3-49
eSATA (External Serial ATA) devices	3-50
TOSHIBA Hi-Speed Port Replicator II	3-51
Security lock	3-52

	Optional TOSHIBA Accessories	3-53
	Sound System	3-53
	Video mode	3-55
	Computer Handling	3-55
	Heat dispersal	3-56
Chapter 4	Utilities & Advanced Usage	
	Utilities and Applications	4-1
	Special features	4-6
	Using the TOSHIBA Sleep Utility	4-9
	Using the TOSHIBA Face Recognition	4-11
	TOSHIBA Password Utility	4-14
	HW Setup	4-17
	TOSHIBA PC Health Monitor	4-22
	Using the Hard Disk Drive (HDD) Protection	4-23
	TOSHIBA HDD Protection Properties	4-24
	System Recovery	4-26
	Triple/Quad Multi Monitor	4-29
Chapter 5	Power and Power-Up Modes	
	Power conditions	5-1
	Monitoring of power condition	5-2
	Battery	5-3
	Power-up modes	5-10
	Panel power on/off	5-11
	System automatic Sleep/Hibernation	5-11
Chapter 6	Troubleshooting	
	Problem solving process	6-1
	Hardware and system checklist	6-4
	TOSHIBA support	6-18
Appendix A	Specifications	
Appendix B	AC Power Cord and Connectors	
Appendix C	Legal Footnotes	
Appendix D	Information for Wireless Devices	
	Index	

Copyright

© 2011 by TOSHIBA Corporation. All rights reserved. Under the copyright laws, this manual cannot be reproduced in any form without the prior written permission of TOSHIBA. No patent liability is assumed, with respect to the use of the information contained herein.

First edition April 2011

Copyright authority for music, movies, computer programs, databases and other intellectual property covered by copyright laws belongs to the author or to the copyright owner. Copyrighted material can be reproduced only for personal use or use within the home. Any other use beyond that stipulated above (including conversion to digital format, alteration, transfer of copied material and distribution on a network) without the permission of the copyright owner is a violation of copyright or author's rights and is subject to civil damages or criminal action. Please comply with copyright laws in making any reproduction from this manual.

Disclaimer

This manual has been validated and reviewed for accuracy. The instructions and descriptions it contains are accurate for your computer at the time of this manual's production. However, succeeding computers and manuals are subject to change without notice. TOSHIBA assumes no liability for damages incurred directly or indirectly from errors, omissions or discrepancies between the computer and the manual.

Trademarks

Intel, Intel SpeedStep, Intel Core and Centrino are trademarks or registered trademarks of Intel Corporation.

AMD, the AMD Arrow logo, PowerPlay, Vari-Bright and combinations thereof are trademarks of Advanced Micro Devices, Inc.

Windows, Microsoft and Windows logo are registered trademarks of Microsoft Corporation.

Bluetooth is a trademark owned by its proprietor and used by TOSHIBA under license.

HDMI, the HDMI logo and High-Definition Multimedia Interface are trademarks or registered trademarks of HDMI Licensing LLC.

DisplayPort and the DisplayPort logo are trademarks of Video Electronics Standards Association.

WinDVD is a trademark of the Corel Corporations.

Labelflash is a trademark of YAMAHA CORPORATION.

Photo CD is a trademark of Eastman Kodak Company.

ConfigFree is a trademark of TOSHIBA Corporation.

TouchPad is a trademark of Synaptics, Inc

Wi-Fi is a registered trademark of the Wi-Fi Alliance.

Secure Digital and SD are trademarks of SD Card Association.

Memory Stick, Memory Stick Duo, Memory Stick PRO, Memory Stick PRO Duo and Memory Stick Micro are trademarks or registered trademarks of Sony Corporation.

xD-Picture Card is a trademark of FUJIFILM Corporation.

ExpressCard is a trademark of PCMCIA.

MultiMediaCard and MMC are trademarks of MultiMediaCard Association.

Blu-ray Disc™, Blu-ray™ and the logos are trademarks of the Blu-ray Disc Association.

Atheros is a registered trademark of Atheros Communication, Inc.

Realtek is a registered trademark of Realtek Semiconductor Corporation.

Other trademarks and registered trademarks not listed above may be used in this manual.

FCC information

FCC notice "Declaration of Conformity Information"

This equipment has been tested and found to comply with the limits for a Class B digital device, pursuant to part 15 of the FCC rules. These limits are designed to provide reasonable protection against harmful interference in a residential installation. This equipment generates, uses and can radiate radio frequency energy and, if not installed and used in accordance with the instructions, may cause harmful interference to radio communications. However, there is no guarantee that interference will not occur in a particular installation. If this equipment does cause harmful interference to radio or television reception, which can be determined by turning the equipment off and on, the user is encouraged to try to correct the interference by one or more of the following measures:

- Reorient or relocate the receiving antenna.
- Increase the separation between the equipment and receiver.
- Connect the equipment into an outlet on a circuit different from that to which the receiver is connected.
- Consult the dealer or an experienced radio/TV technician for help.



Only peripherals complying with the FCC class B limits may be attached to this equipment. Operation with non-compliant peripherals or peripherals not recommended by TOSHIBA is likely to result in interference to radio and TV reception. Shielded cables must be used between the external devices and the computer's External RGB monitor port, Universal Serial Bus (USB 2.0 and 3.0) ports, eSATA/USB combo port, HDMI out port, DisplayPort and microphone jack. Changes or modifications made to this equipment, not expressly approved by TOSHIBA or parties authorized by TOSHIBA could void the user's authority to operate the equipment.

FCC conditions

This device complies with part 15 of the FCC Rules. Operation is subject to the following two conditions:

1. This device may not cause harmful interference.
2. This device must accept any interference received, including interference that may cause undesired operation.

Contact

Address: TOSHIBA America Information Systems, Inc.
9740 Irvine Boulevard
Irvine, California 92618-1697

Telephone: (949) 583-3000

EU Declaration of Conformity



This product is carrying the CE-Mark in accordance with the related European Directives. Responsible for CE-Marking is TOSHIBA Europe GmbH, Hammfelddamm 8, 41460 Neuss, Germany. The complete and official EU Declaration of Conformity can be found on TOSHIBA's web site <http://epps.toshiba-teg.com> on the Internet.

CE compliance

This product is labelled with the CE Mark in accordance with the related European Directives, notably Electromagnetic Compatibility Directive 2004/108/EC for the notebook and the electronic accessories including the supplied power adapter, the Radio Equipment and Telecommunications Terminal Equipment Directive 1999/5/EC in case of implemented telecommunication accessories and the Low Voltage Directive 2006/95/EC for the supplied power adapter. Furthermore the product complies with the Ecodesign Directive 2009/125/EC (ErP) and its related implementing measures.

This product and the original options are designed to observe the related EMC (Electromagnetic Compatibility) and safety standards. However, TOSHIBA cannot guarantee that this product still observes these EMC standards if options or cables not produced by TOSHIBA are connected or implemented. In this case the persons who have connected/implemented those options/cables have to provide assurance that the system (PC plus options/cables) still fulfils the required standards. To avoid general EMC problems, the following guidance should be noted:

- Only CE marked options should be connected/implemented
- Only best shielded cables should be connected

Working environment

This product was designed to fulfil the EMC (Electromagnetic Compatibility) requirements to be observed for so-called “Residential, commercial and light industry environments”. TOSHIBA do not approve the use of this product in working environments other than the above mentioned “Residential, commercial and light industry environments”.

For example, the following environments are not approved:

- Industrial Environments (e.g. environments where a mains voltage of 380 V three-phase is used)
- Medical Environments
- Automotive Environments
- Aircraft Environments

Any consequences resulting from the use of this product in working environments that are not approved are not the responsibility of TOSHIBA.

The consequences of the use of this product in non-approved working environments may be:

- Interference with other devices or machines in the near surrounding area.
- Malfunction of, or data loss from, this product caused by disturbances generated by other devices or machines in the near surrounding area.

Therefore TOSHIBA strongly recommend that the electromagnetic compatibility of this product should be suitably tested in all non-approved working environments before use. In the case of automobiles or aircraft, the manufacturer or airline respectively should be asked for permission before use of this product.

Furthermore, for general safety reasons, the use of this product in environments with explosive atmospheres is not permitted.

VCCI Class B Information

この装置は、クラスB情報技術装置です。この装置は、家庭環境で使用することを目的としていますが、この装置がラジオやテレビジョン受信機に近接して使用されると、受信障害を引き起こすことがあります。取扱説明書に従って正しい取り扱いをしてください。

VCCI-B

Video Standard Notice

THIS PRODUCT IS LICENSED UNDER THE AVC, THE VC-1 AND MPEG-4 VISUAL PATENT PORTFOLIO LICENSE FOR THE PERSONAL AND NON-COMMERCIAL USE OF A CONSUMER FOR (I) ENCODING VIDEO IN COMPLIANCE WITH THE ABOVE STANDARDS (“VIDEO”) AND/OR (II) DECODING AVC, VC-1 AND MPEG-4 VIDEO THAT WAS ENCODED BY A CONSUMER ENGAGED IN A PERSONAL AND NON-COMMERCIAL ACTIVITY AND/OR WAS OBTAINED FROM A VIDEO PROVIDER LICENSED BY MPEG LA TO PROVIDE SUCH VIDEO. NO

LICENSE IS GRANTED OR SHALL BE IMPLIED FOR ANY OTHER USE. ADDITIONAL INFORMATION INCLUDING THAT RELATING TO PROMOTIONAL, INTERNAL AND COMMERCIAL USES AND LICENSING MAY BE OBTAINED FROM MPEG LA, L.L.C. SEE [HTTP://WWW.MPEGLA.COM](http://WWW.MPEGLA.COM).

Canadian regulatory information (Canada only)

This digital apparatus does not exceed the Class B limits for radio noise emissions from digital apparatus as set out in the Radio Interference Regulation of the Canadian Department of Communications.

Note that Canadian Department of Communications (DOC) regulations provide, that changes or modifications not expressly approved by TOSHIBA Corporation could void your authority to operate this equipment.

This Class B digital apparatus meets all requirements of the Canadian Interference-Causng Equipment Regulations.

Cet appareil numérique de la class B respecte toutes les exgences du Règlement sur le matériel brouilleur du Canada.

GOST

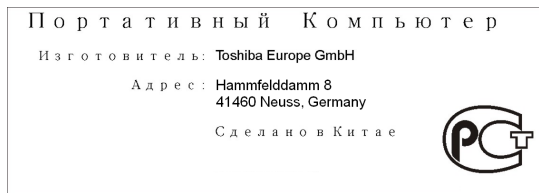

Following information is only valid for EU-member States:

Disposal of products



The crossed out wheeled dust bin symbol indicates that products must be collected and disposed of separately from household waste. Integrated batteries and accumulators can be disposed of with the product. They will be separated at the recycling centres.

The black bar indicates that the product was placed on the market after August 13, 2005.

By participating in separate collection of products and batteries, you will help to assure the proper disposal of products and batteries and thus help to prevent potential negative consequences for the environment and human health.

For more detailed information about the collection and recycling programmes available in your country, please visit our website (<http://eu.computers.toshiba-europe.com>) or contact your local city office or the shop where you purchased the product.

Disposal of batteries and/or accumulators



The crossed out wheeled dust bin symbol indicates that batteries and/or accumulators must be collected and disposed of separately from household waste.

If the battery or accumulator contains more than the specified values of lead (Pb), mercury (Hg), and/or cadmium (Cd) defined in the Battery Directive (2006/66/EC), then the chemical symbols for lead (Pb), mercury (Hg) and/or cadmium (Cd) will appear below the crossed out wheeled dust bin symbol.

By participating in separate collection of batteries, you will help to assure the proper disposal of products and batteries and thus help to prevent potential negative consequences for the environment and human health.

For more detailed information about the collection and recycling programmes available in your country, please visit our website (<http://eu.computers.toshiba-europe.com>) or contact your local city office or the shop where you purchased the product.



These symbols may not stick depending on the country and region where you purchased.

Disposing of the computer and the computer's batteries

- Discard this computer in accordance with applicable laws and regulations. For further information, contact your local government.
- This computer contains rechargeable batteries. After repeated use, the batteries will finally lose their ability to hold a charge and you will need to replace them. Under certain applicable laws and regulation, it may be illegal to dispose of old batteries by placing them in the trash.
- Please be kind to our shared environment. Check with your local government authority for details regarding where to recycle old batteries or how to dispose of them properly.

REACH - Compliance Statement

The new European Union (EU) chemical regulation, REACH (Registration, Evaluation, Authorization and Restriction of Chemicals), entered into force on 1 June 2007. TOSHIBA will meet all REACH requirements and is committed to provide our customers with information about the chemical substances in our products according to REACH regulation.

Please consult the following website www.toshiba-europe.com/computers/info/reach for information about the presence in our articles of substances included on the candidate list according to article 59(1) of Regulation (EC) No 1907/2006 („REACH“) in a concentration above 0.1 % weight by weight.

Following information is only for Turkey:

- Compliant with EEE Regulations: TOSHIBA meets all requirements of Turkish regulation 26891 “Restriction of the use of certain hazardous substances in electrical and electronic equipment”.
- The number of possible pixel failures of your display is defined according to ISO 13406-2 standards. If the number of pixel failures is less than this standard, they will not be counted as defect or failure.
- Battery is a consumption product, since the battery time depends on the usage of your computer. If the battery can not be charged at all, then it is a defect or failure. The changes in battery time is not a defect or failure.

Optical disc drive safety instructions



Be sure to check the precautions at the end of this section.



The drive model employs a laser system. To ensure proper use of this product, please read this instruction manual carefully and retain for future reference. Should the unit ever require maintenance, contact an authorized service location.

- *Use of controls, adjustments or the performance of procedures other than those specified may result in hazardous radiation exposure.*
- *To prevent direct exposure to the laser beam, do not try to open the enclosure.*

1. Panasonic System Networks

- DVD SuperMulti with Double Layer UJ8A2
- Blu-ray™ Writer drive UJ252

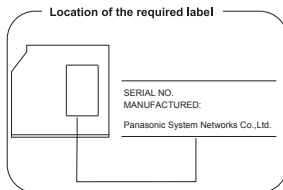
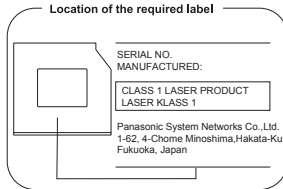

2. TOSHIBA SAMSUNG STORAGE TECHNOLOGY

- DVD SuperMulti with Double Layer TS-U633J

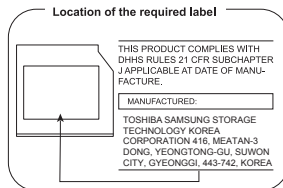

Precautions

CLASS 1 LASER PRODUCT LASER KLASSE 1 PRODUKT TO EN 60825-1 クラス1 レーザ 製品

CAUTION: This appliance contains a laser system and is classified as a “CLASS 1 LASER PRODUCT.” To use this model properly, read the instruction manual carefully and keep this manual for your future reference. In case of any trouble with this model, please contact your nearest “AUTHORIZED service station.” To prevent direct exposure to the laser beam, do not try to open the enclosure.

Preface

Congratulations on your purchase of this computer. This powerful notebook computer provides excellent expansion capability, includes multimedia functionality, and is designed to provide years of reliable, high-performance computing.

This manual tells how to set up and begin using your computer. It also provides detailed information on configuring your computer, basic operations and care, using optional devices and troubleshooting.

Conventions

This manual uses the following formats to describe, identify, and highlight terms and operating procedures.

Abbreviations

On first appearance, and whenever necessary for clarity, abbreviations are enclosed in parentheses following their definition. For example: Read Only Memory (ROM). Acronyms are also defined in the Glossary.

Icons

Icons identify ports, dials, and other parts of your computer. The indicator panel also uses icons to identify the components it is providing information on.

Keys

The keyboard keys are used in the text to describe many computer operations. A distinctive typeface identifies the key top symbols as they appear on the keyboard. For example, **ENTER** identifies the **ENTER** key.

Key operation

Some operations require you to simultaneously use two or more keys. We identify such operations by the key top symbols separated by a plus sign (+). For example, **CTRL + C** means you must hold down **CTRL** and at the same time press **C**. If three keys are used, hold down the first two and at the same time press the third.

ABC

When procedures require an action such as clicking an icon or entering text, the icon's name or the text you are to type in is represented in the typeface you see to the left.

Display

ABC

Names of windows or icons or text generated by the computer that appear on its display screen are presented in the type face you see to the left.

Messages

Messages are used in this manual to bring important information to your attention. Each type of message is identified as shown below.



Indicates a potentially hazardous situation, which could result in death or serious injury, if you do not follow instructions.



Pay attention! A caution informs you that improper use of equipment or failure to follow instructions may cause data loss or damage your equipment.



Please read. A note is a hint or advice that helps you make best use of your equipment.

Terminology

This term is defined in this document as follows:

Start	The word " Start " refers to the "  " button in Windows 7.
HDD or Hard disk drive	Some models are equipped with a "Solid State Drive (SSD)" instead of a hard disk drive. In this manual, the word "HDD" or "Hard disk drive" also refers to the SSD unless otherwise stated.
Illustration	In this manual, situations where the port and connector locations for this series are different, the locations are shown in the illustrations only for some models.

Short Name

Short Name is defined as shown below in this manual.

LCD	Model name	Short Name
39.6cm (15.6")	TECRA R850/Satellite Pro R850/Satellite R850	R850

LCD	Model name	Short Name
35.6cm (14.0")	TECRA R840/Satellite Pro R840/Satellite R840	R840
33.8cm (13.3")	PORTÉGÉ R830/Satellite R830	R830

General Precautions

TOSHIBA computers are designed to optimize safety, minimize strain and withstand the rigors of portability. However, certain precautions should be observed to further reduce the risk of personal injury or damage to the computer.

Be certain to read the general precautions below and to note the cautions included in the text of the manual.

Provide adequate ventilation

Always make sure your computer and AC adaptor have adequate ventilation and are protected from overheating when the power is turned on or when an AC adaptor is connected to a power outlet (even if your computer is in Sleep Mode). In this condition, observe the following:

- Never cover your computer or AC adaptor with any object.
- Never place your computer or AC adaptor near a heat source, such as an electric blanket or heater.
- Never cover or block the air vents including those located at the base of the computer.
- Always operate your computer on a hard flat surface. Using your computer on a carpet or other soft material can block the vents.
- Always provide sufficient space around the computer.
- Overheating your computer or AC adaptor could cause system failure, computer or AC adaptor damage or a fire, possibly resulting in serious injury.

Creating a computer-friendly environment

Place the computer on a flat surface that is large enough for the computer and any other items you are using, such as a printer.

Leave enough space around the computer and other equipment to provide adequate ventilation. Otherwise, they may overheat.

To keep your computer in prime operating condition, protect your work area from:

- Dust, moisture, and direct sunlight.
- Equipment that generates a strong electromagnetic field, such as stereo speakers (other than speakers that are connected to the computer) or speakerphones.
- Rapid changes in temperature or humidity and sources of temperature change such as air conditioner vents or heaters.
- Extreme heat, cold, or humidity.
- Liquids and corrosive chemicals.

Stress injury

Carefully read the *Instruction Manual for Safety and Comfort*. It contains information on the prevention of stress injuries to your hands and wrists that can be caused by extensive keyboard use. It also includes information on work space design, posture and lighting that can help reduce physical stress.

Heat injury

- Avoid prolonged physical contact with the computer. If the computer is used for long periods, its surface can become very warm. While the temperature will not feel hot to the touch, if you maintain physical contact with the computer for a long time, for example if you rest the computer on your lap or if you keep your hands on the palm rest, your skin might suffer a low-heat injury.
- If the computer has been used for a long time, avoid direct contact with the metal plate supporting the various interface ports as this can become hot.
- The surface of the AC adaptor can become hot when in use but this condition does not indicate a malfunction. If you need to transport the AC adaptor, you should disconnect it and let it cool before moving it.
- Do not lay the AC adaptor on a material that is sensitive to heat as the material could become damaged.

Pressure or impact damage

Do not apply heavy pressure to the computer or subject it to any form of strong impact as this can damage the computer's components or otherwise cause it to malfunction.

ExpressCard overheating

Some ExpressCards can become hot during prolonged use which may result in errors or instability in the operation of the device in question. In addition, you should also be careful when you remove an ExpressCard that has been used for a long time.

Mobile phones

Please be aware that the use of mobile phones can interfere with the audio system. The operation of the computer will not be impaired in any way, but it is recommended that a minimum distance of 30cm is maintained between the computer and a mobile phone that is in use.

Instruction Manual for Safety and Comfort

All important information on the safe and proper use of this computer is described in the enclosed *Instruction Manual for Safety and Comfort*. Be sure to read it before using the computer.

Chapter 1

Getting Started

This chapter provides an equipment checklist, and basic information to start using your computer.



Some of the features described in this manual may not function properly if you use an operating system that was not pre-installed by TOSHIBA.

Equipment checklist

Carefully unpack your computer, taking care to save the box and packaging materials for future use.

Hardware

Check to make sure you have all the following items:

- TOSHIBA Portable Personal Computer
- AC adaptor and power cord (2-pin plug or 3-pin plug)
- Battery pack (Is preinstalled in some computers)
- Spare AccuPoint (pointing device) cap (Is included with some models)

Documentation

- Quickstart
- Instruction Manual for Safety and Comfort
- Warranty Information

If any of the items are missing or damaged, contact your dealer immediately.

Software

The following Windows® operating system and utility software are pre-installed.

- Windows 7
- TOSHIBA Recovery Media Creator
- TOSHIBA Assist
- TOSHIBA ConfigFree™
- TOSHIBA Flash Cards
- TOSHIBA Disc Creator
- TOSHIBA VIDEO PLAYER

- TOSHIBA Resolution+ Plug-in For Windows Media Player
- TOSHIBA eco Utility
- TOSHIBA Bulletin Board
- TOSHIBA ReelTime
- TOSHIBA HW Setup Utility
- TOSHIBA Value Added Package
- TOSHIBA Web Camera Application
- TOSHIBA Face Recognition
- TOSHIBA HDD Protection
- TOSHIBA Service Station
- TOSHIBA PC Health Monitor
- TOSHIBA Sleep Utility
- TOSHIBA Fingerprint Utility
- User's Manual (this manual)



You may not have all the software listed above depending on the model you purchased.

Getting Started



- *All users should be sure to read the section [Starting up for the first time](#).*
- *Be sure to read the enclosed Instruction Manual for Safety and Comfort for information on the safe and proper use of this computer. It is intended to help you be more comfortable and productive while using a notebook computer. By following the recommendations in it you may reduce your chance of developing a painful or disabling injury to your hand, arms, shoulders or neck.*

This section provides basic information to start using your computer. It covers the following topics:

- Connecting the AC adaptor
- Opening the display
- Turning on the power
- Starting up for the first time
- Turning off the power
- Restarting the computer



- *Use a virus-check program and make sure it is updated regularly.*
- *Never format storage media without checking its content - formatting destroys all stored data.*

- *It is a good idea to periodically back up the internal hard disk drive or other main storage device to external media. General storage media is not durable or stable over long periods of time and under certain conditions may result in data loss.*
- *Before you install a device or application, save any data in memory to the hard disk drive or other storage media. Failure to do so may result in the loss of data.*

Connecting the AC adaptor

Attach the AC adaptor when you need to charge the battery or you want to operate from AC power. It is also the fastest way to get started, because the battery pack will need to be charged before you can operate from battery power.

The AC adaptor can automatically adjust to any voltage ranging from 100 to 240V and to a frequency of either 50 or 60 Hz, enabling you to use this computer in almost any country/region. The adaptor converts AC power to DC power and reduces the voltage supplied to this computer.



- *Always use the TOSHIBA AC adaptor that was included with your computer, or use AC adaptors specified by TOSHIBA to avoid any risk of fire or other damage to the computer. Use of an incompatible AC adaptor could cause fire or damage to the computer possibly resulting in serious injury. TOSHIBA assumes no liability for any damage caused by use of an incompatible adaptor.*
- *Never plug the AC adaptor into a power source that does not correspond to both the voltage and the frequency specified on the regulatory label of the unit. Failure to do so could result in a fire or electric shock, possibly resulting in serious injury.*
- *Always use or purchase power cables that comply with the legal voltage and frequency specifications and requirements in the country of use. Failure to do so could result in a fire or electric shock, possibly resulting in serious injury.*
- *The supplied power cord conforms to safety rules and regulations in the region the product is bought and should not be used outside this region. For use in other regions, please buy power cords that conform to safety rules and regulations in the particular region.*
- *Do not use a 3-pin to 2-pin conversion plug.*

- *When you connect the AC adaptor to the computer, always follow the steps in the exact order as described in the User's Manual. Connecting the power cable to a live electrical outlet should be the last step otherwise the adaptor DC output plug could hold an electrical charge and cause an electrical shock or minor bodily injury when touched. As a general safety precaution, avoid touching any metal parts.*
- *Never place your computer or AC adaptor on a wooden surface, furniture, or any other surface that could be marred by exposure to heat since the computer base and AC adaptor's surface increase in temperature during normal use.*
- *Always place your computer or AC adaptor on a flat and hard surface that is resistant to heat damage.*

Refer to the enclosed Instruction Manual for Safety and Comfort for detailed precautions and handling instructions.

1. Connect the power cord to the AC adaptor.

Figure 1-1 Connecting the power cord to the AC adaptor (2-pin plug)

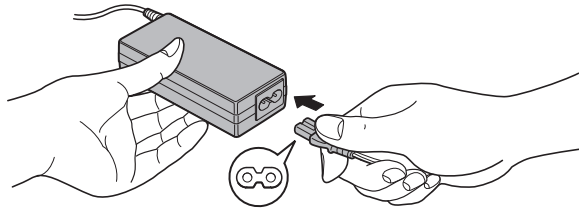
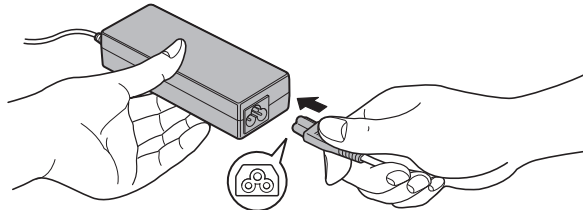

Figure 1-2 Connecting the power cord to the AC adaptor (3-pin plug)



Either a 2-pin or 3-pin adaptor/cord will be included with the computer depending on the model.

2. Connect the AC adaptor's DC output plug to the DC IN 19V jack on the left of the computer.

Figure 1-3 Connecting the DC output plug to the computer (R830)

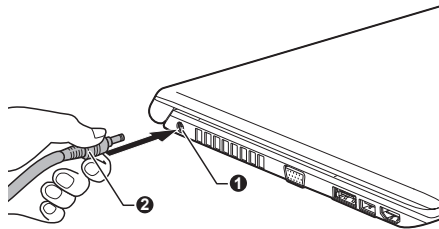

1. DC IN 19V jack

2. DC output plug

3. Plug the power cord into a live wall outlet - the **Battery** and **DC IN** indicators on the front of the computer should glow.

Opening the display

The display panel can be opened to a wide range of angles for optimal viewing.

While holding down the palm rest with one hand so that the main body of the computer is not raised, slowly lift the display panel - this will allow the angle of the display panel to be adjusted to provide optimum clarity.

Figure 1-4 Opening the display panel (R830)

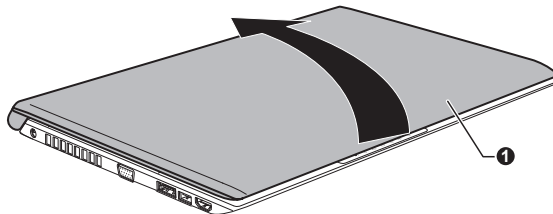

1. Display panel



Use reasonable care when opening and closing the display panel. Opening it vigorously or slamming it shut could damage the computer.



- *Be careful not to open the display panel too far as this could put stress on the display panel's hinges and cause damage.*
- *Do not press or push on the display panel.*
- *Do not lift the computer by the display panel.*
- *Do not close the display panel with pens or any other objects left in between the display panel and the keyboard.*

- *When opening or closing the display panel, place one hand on the palm rest to hold the computer in place and use the other hand to slowly open or close the display panel (Do not use excessive force when opening or closing the display panel).*

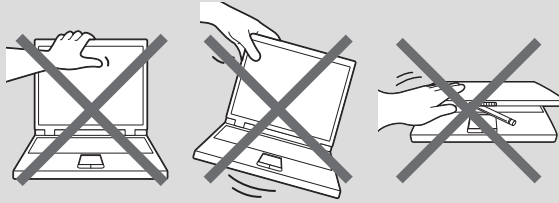

Turning on the power

This section describes how to turn on the power - the **Power** indicator will then indicate the status. Please refer to the [Monitoring of power condition](#) section in Chapter 5, Power and Power-Up Modes for more information.



- *After you turn on the power for the first time, do not turn it off until you have set up the operating system.*
- *Volume cannot be adjusted during Windows Setup.*

1. Open the display panel.
2. Press and hold the computer's power button for two or three seconds.

Figure 1-6 Turning on the power (R850)

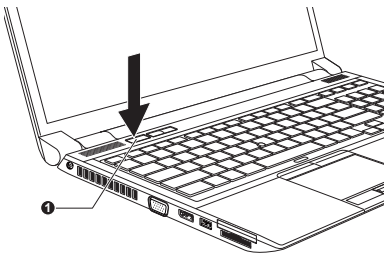

Figure 1-7 Turning on the power (R840)

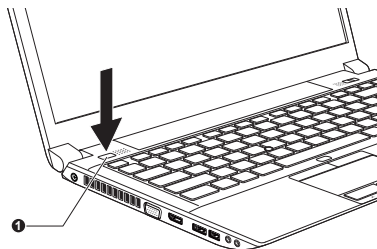
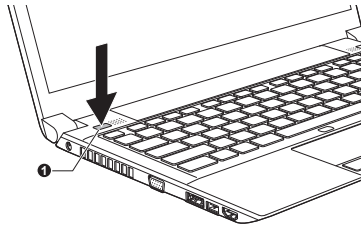

Figure 1-8 Turning on the power (R830)



1. Power button

Product appearance depends on the model you purchased.

Starting up for the first time

The Windows 7 Startup Screen will be the first screen displayed when you turn on the power. Follow the on-screen instructions on each screen in order to properly install the operating system.



When it is displayed, be sure to read the **Software License Terms** carefully.

Turning off the power

The power can be turned off in one of three modes, either Shut Down Mode, Hibernation Mode or Sleep Mode.

Shut Down Mode

When you turn off the power in Shut Down Mode no data will be saved and the computer will boot to the operating system's main screen the next time it is turned on.

1. If you have entered data, either save it to the hard disk drive or to other storage media.
2. Make sure all disk/disc activity has stopped before removing the disk/disc.



- Make sure the **Hard Disk Drive/Optical Disc Drive/eSATA** indicator is off. If you turn off the power while a disk (disc) is being accessed, you may lose data or damage the disk.
- Never turn off the power while an application is running. Doing so could cause loss of data.
- Never turn off the power, disconnect an external storage device or remove storage media during data read/write. Doing so can cause data loss.

3. Click **Start**.

4. Click the **Shut down** button ().
5. Turn off any peripheral devices connected to your computer.



Do not turn the computer or peripheral devices back on immediately - wait a short period to avoid any potential damage.

Sleep Mode

If you have to interrupt your work, you are able to turn off the power without exiting from your software by placing the computer into Sleep Mode. In this mode data is maintained in the computer's main memory so that when you turn on the power again, you can continue working right where you left off.



When you have to turn off your computer aboard an aircraft or in places where electronic devices are regulated or controlled, always completely shut down the computer. This includes turning off any wireless communication functionalities, and cancelling settings that reactivate the computer automatically, such as a timer recording function. Failure to completely shut down the computer in this way could allow the operating system to reactivate and run pre-programmed tasks or preserve unsaved data, which could interfere with aviation or other systems, possibly causing serious injury.



- *Before entering Sleep Mode, be sure to save your data.*
- *Do not install or remove a memory module while the computer is in Sleep Mode. The computer or the memory module could be damaged.*
- *Do not remove the battery pack while the computer is in Sleep Mode (unless the computer is connected to an AC power source). Data in memory could be lost.*



- *When the AC adaptor is connected, the computer will go into Sleep Mode according to the settings in the Power Options (to access it, **Start -> Control Panel -> System and Security -> Power Options**).*
- *To restore the operation of the computer from Sleep Mode, press and hold the power button or any key on the keyboard for a short amount of time. Please note that keyboard keys can only be used if the Wake-up on Keyboard option is enabled within the HW Setup utility.*
- *If the computer enters Sleep Mode while a network application is active, the application might not be restored when the computer is next turned on and the system returns from Sleep Mode.*
- *To prevent the computer from automatically entering Sleep Mode, disable Sleep Mode within the Power Options (to access it, **Start -> Control Panel -> System and Security -> Power Options**).*
- *To use the Hybrid Sleep function, configure it in the Power Options.*

Benefits of Sleep Mode

The Sleep Mode feature provides the following benefits:

- Restores the previous working environment more rapidly than does the Hibernation Mode feature.
- Saves power by shutting down the system when the computer receives no input or hardware access for the time period set by the System Sleep Mode feature.
- Allows the use of the panel power off feature.

Executing Sleep Mode



*You can also enable Sleep Mode by pressing **FN + F3** - please refer to the [Hot key functions](#) section in Chapter 3, *Operating Basics*, for further details.*

You can enter Sleep Mode in one of three ways:

- Click **Start**, point to the arrow icon () and then select **Sleep** from the menu.
- Close the display panel. Please note that this feature must be enabled within the Power Options (to access it, click **Start -> Control Panel -> System and Security -> Power Options**).
- Press the power button. Please note that this feature must be enabled within the Power Options (to access it, click **Start -> Control Panel -> System and Security -> Power Options**).

When you turn the power back on, you can continue where you left when you shut down the computer.



- *When the computer is in Sleep Mode, the power indicator will blink orange.*
- *If you are operating the computer on battery power, you can lengthen the overall operating time by turning it off into Hibernation Mode - Sleep Mode will consume more power while the computer is off.*

Sleep Mode limitations

Sleep Mode will not function under the following conditions:

- Power is turned back on immediately after shutting down.
- Memory circuits are exposed to static electricity or electrical noise.

Hibernation Mode

The Hibernation Mode feature saves the contents of memory to the hard disk drive when the computer is turned off so that, the next time it is turned on, the previous state is restored. Please note that the Hibernation Mode feature does not save the status of any peripheral devices connected to the computer.



- *Save your data. While entering Hibernation Mode, the computer saves the contents of memory to the hard disk drive. However, for safety sake, it is best to save your data manually.*
- *Data will be lost if you remove the battery or disconnect the AC adaptor before the save is completed. Wait for the **Hard Disk Drive/Optical Disc Drive/eSATA** indicator to go out.*
- *Do not install or remove a memory module while the computer is in Hibernation Mode. Data will be lost.*

Benefits of Hibernation Mode

The Hibernation Mode feature provides the following benefits:

- Saves data to the hard disk drive when the computer automatically shuts down because of a low battery condition.
- You can return to your previous working environment immediately when you turn on the computer.
- Saves power by shutting down the system when the computer receives no input or hardware access for the time period set by the System Hibernate feature.
- Allows the use of the panel power off feature.

Starting Hibernation Mode



*You can also enable Hibernation Mode by pressing **FN + F4** - please refer to the [Hot key functions](#) section in Chapter 3, *Operating Basics*, for further details.*

To enter Hibernation Mode, follow the steps below.

1. Click **Start**.
2. Point to the arrow icon () and then select **Hibernate** from the menu.

Automatic Hibernation Mode

The computer can be configured to enter Hibernation Mode automatically when you press the power button or close the lid. In order to define these settings, you can follow the steps as described below:

1. Click **Start** and click the **Control Panel**.
2. Click **System and Security** and click **Power Options**.
3. Click **Choose what the power button does** or **Choose what closing the lid does**.
4. Enable the desired Hibernation Mode settings for **When I press the power button** and **When I close the lid**.
5. Click the **Save changes** button.

Data save in Hibernation Mode

When you turn off the power in Hibernation Mode, the computer will take a moment to save the current data in memory to the hard disk drive. During this time, the **Hard Disk Drive** indicator will glow.

After you turn off the computer, and the content of memory has been saved to the hard disk drive, turn off the power to any peripheral devices.



Do not turn the computer or devices back on immediately. Wait a moment to let all capacitors fully discharge.

Restarting the computer

Certain conditions require that you reset the computer, for example if:

- You change certain computer settings.
- An error occurs and the computer does not respond to your keyboard commands.

If you need to restart the computer, there are three ways this can be achieved:

- Click **Start**, point to the arrow icon () and then select **Restart** from the menu.
- Press **CTRL**, **ALT** and **DEL** simultaneously (once) to display the menu window, then select **Restart** from the **Shut down options**.
- Press the power button and hold it down for five seconds. Once the computer has turned itself off, wait between ten and fifteen seconds before turning the power on again by pressing the power button.

Chapter 2

The Grand Tour

This chapter identifies the various components of the computer - it is recommended that you become familiar with each before you operate the computer.

Legal Footnote (Non-applicable Icons)

For more information regarding Non-applicable Icons, please refer to the Legal Footnotes section in Appendix C.



Please handle your computer carefully to avoid scratching or damaging the surface.

Short Name is defined as shown below in this manual.

LCD	Model name	Short Name
39.6cm (15.6")	TECRA R850/Satellite Pro R850/Satellite R850	R850
35.6cm (14.0")	TECRA R840/Satellite Pro R840/Satellite R840	R840
33.8cm (13.3")	PORTÉGÉ R830/Satellite R830	R830

The Grand Tour for R850

Front with the display closed (R850)

The following figure shows the computer's front with its display panel in the closed position.

Figure 2-1 Front of the computer with display panel closed (R850)

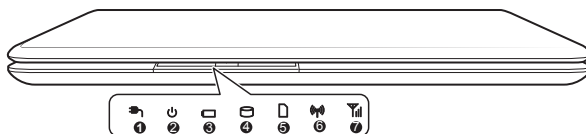

1. DC IN indicator
2. Power indicator
3. Battery indicator
4. Hard Disk Drive/Optical Disc Drive/eSATA indicator
5. Memory media slot indicator
6. Wireless communication indicator
7. Wireless WAN/WiMAX indicator



DC IN indicator

The **DC IN indicator** normally glows green when power is being correctly supplied from the AC power adaptor. However, if the output voltage from the adaptor is abnormal, or if the computer's power supply malfunctions, this indicator will flash orange.



Power indicator

The **Power indicator** normally glows green when the computer is turned on. However, if you turn the computer off into Sleep Mode, this indicator will flash orange - approximately two seconds on, two seconds off - both while the system is shutting down and while it remains turned off.



Battery indicator

The **Battery indicator** shows the condition of the battery's charge - green indicates the battery is fully charged, orange indicates the battery is charging, and flashing orange indicates a low battery condition.

Please refer to Chapter 5, [Power and Power-Up Modes](#) for more information on this feature.



Hard Disk Drive/Optical Disc Drive/eSATA indicator

The **Hard Disk Drive/Optical Disc Drive/eSATA indicator** blinks green whenever the computer is accessing the built-in hard disk drive, optical disc drive or eSATA device.



Memory media slot indicator

The **Memory media slot indicator** blinks green when the computer is accessing the memory media slot.



Wireless communication indicator

The **Wireless communication indicator** glows orange when the Wireless functions are turned on.

Some models are equipped with Wireless functions.



Wireless WAN/WiMAX indicator

The **Wireless WAN/WiMAX indicator** glows blue when the Wireless WAN/WiMAX functions are turned on.

In some models, the indicator will glow and blink in order to indicate the connection status of the Wireless WAN/WiMAX function.

Some models are equipped with a Wireless WAN/WiMAX function.

Left side (R850)

The following figure shows the computer's left side.

Figure 2-2 The left side of the computer (R850)

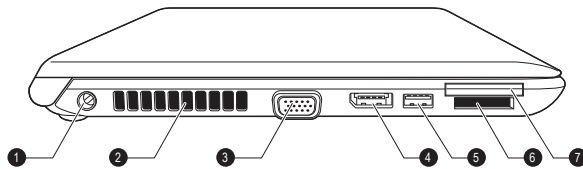

1. DC IN 19V jack

2. Cooling vents

3. External RGB monitor port

4. HDMI out port or DisplayPort*

5. Universal Serial Bus (USB 2.0 or 3.0) port

6. Memory media slot

7. ExpressCard slot or Smart Card slot*

* Provided with some models.

Product appearance depends on the model you purchased.



DC IN 19V jack

The AC adaptor connects to this jack in order to power the computer and charge its internal batteries. Please note that you should only use the model of AC adaptor supplied with the computer at the time of purchase - using the wrong AC adaptor can cause damage to the computer.

Cooling vents

The cooling vents help the processor to avoid overheating.



Do not block the cooling vents. Keep foreign metal objects, such as screws, staples and paper clips, out of the cooling vents. Foreign metal objects can create a short circuit, which can cause damage and fire, possibly resulting in serious injury.



External RGB monitor port

This port provides 15-pin, analog VGA port. Please refer to Appendix A for information on external RGB monitor port pin assignment. This port allows you to connect an external RGB monitor to the computer.



HDMI out port

HDMI out port can connect with Type A connector HDMI cable. Some models are equipped with an HDMI out port.



DisplayPort

One DisplayPort, which complies to the V1.1a standard, is provided on the left side of the computer. Some models are equipped with a DisplayPort.



Universal Serial Bus (USB 2.0 or 3.0) port

One Universal Serial Bus port, which complies to the USB 2.0 or 3.0 standard, is provided on the left side of the computer.

The USB port type may vary depending on the model you purchased. The Port with blue color is USB 3.0 port.

The USB 2.0 port is compliant with USB 2.0 standard and not compatible with USB 3.0 devices.

The USB 3.0 port is compliant with USB 3.0 standard and backward compatible with USB 2.0 devices.



Memory media slot

This slot lets you insert an SD™/SDHC™/SDXC™ memory card, miniSD™/microSD™ Card, Memory Stick™ (PRO™/Duo™/PRO Duo™/Micro™), xD-Picture Card™ and MultiMediaCard™. Refer to the Optional devices section in Chapter 3, *Operating Basics* for more information.



ExpressCard slot

This slot allows you to install a single ExpressCard/34 device.

Some models are equipped with an ExpressCard slot.



Smart Card slot

This slot allows you to install a smart card device.

Some models are equipped with a Smart Card slot.

Right side (R850)

The following figure shows the computer's right side.

Figure 2-3 The right side of the computer (R850)

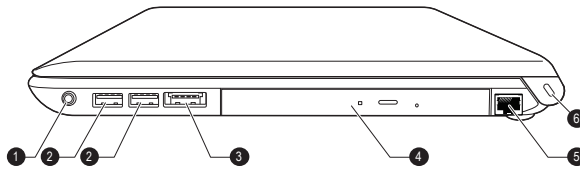

- | | |
|---|------------------------|
| 1. Headphone/Microphone jack | 4. Optical disc drive* |
| 2. Universal Serial Bus (USB 2.0) ports | 5. LAN jack |
| 3. eSATA/USB combo port | 6. Security lock slot |

* Provided with some models.

Product appearance depends on the model you purchased.



Headphone /Microphone jack

A 3.5 mm mini headphone/microphone jack enables connection of a monaural microphone or a stereo headphone.



Both the internal and external microphones will be disabled if you use a headset other than a 4-pin headset headphone.



Universal Serial Bus (USB 2.0) ports

Two Universal Serial Bus ports, which comply to the USB 2.0 standard, are provided on the right side of the computer.

 **eSATA/USB combo port** One eSATA/USB combo port, which complies to the USB 2.0 standard, is provided on the right side of the computer. This port has eSATA (External Serial ATA) function. The port with the icon ⚡ has [Sleep and Charge](#) function.

Optical disc drive The computer may be configured with a DVD Super Multi with Double Layer recording drive.



2.6GB and 5.2GB DVD-RAM media cannot be read from or written to.



LAN jack This jack lets you connect to a LAN. The adaptor has built-in support for Ethernet LAN (10 megabits per second, 10BASE-T), Fast Ethernet LAN (100 megabits per second, 100BASE-TX) or Gigabit Ethernet LAN (1000 megabits per second, 1000BASE-T). Refer to chapter 3, [Operating Basics](#), for details.



- *Do not connect any cable other than a LAN cable to the LAN jack. It could cause damage or malfunction.*
- *Do not connect the LAN cable to a power supply. It could cause damage or malfunction.*



Security lock slot A security cable can be attached to this slot and then connected to a desk or other large object in order to deter theft of the computer.



Please note that it is not possible to confirm the operation of all functions of all USB devices that are available. In view of this it may be noted that some functions associated with a specific device might not operate properly.



Keep foreign metal objects, such as screws, staples and paper clips, out of the Memory media slot, ExpressCard slot, eSATA/USB combo port and USB port. Foreign metal objects can create a short circuit, which can cause damage and fire, possibly resulting in serious injury.

Back (R850)

The following figure shows the computer's back.

Figure 2-4 The back of the computer (R850)

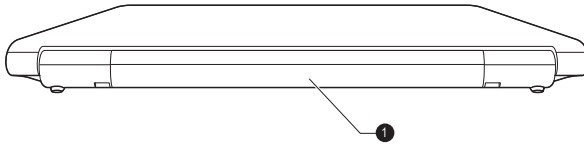

1. Battery pack

Battery pack

The rechargeable lithium-ion battery pack provides power to the computer when the AC adaptor is not connected. For more detailed information on the use and operation of the battery pack please refer to Chapter 5, [Power and Power-Up Modes](#).

Legal Footnote (Battery Life)

For more information regarding Battery Life, please refer to the Legal Footnotes section in Appendix C.

Underside (R850)

The following figure shows the underside of the computer. You should ensure that the display is closed before the computer is turned over to avoid causing any damage.

Figure 2-5 The underside of the computer (R850)

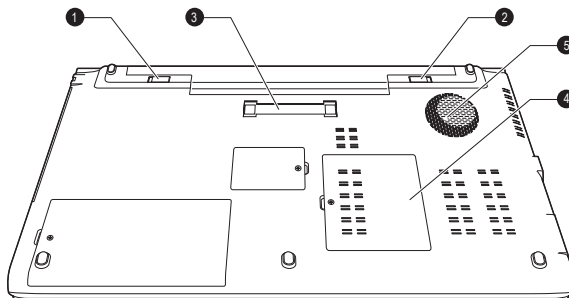

1. Battery lock

2. Battery release latch







3. Docking port*

4. Memory module slot

5. Cooling vents

* Provided with some models.

Product appearance depends on the model you purchased.

-
-   **Battery lock** Slide the battery lock to release the battery pack ready for removal.
-
-   **Battery release latch** Slide and hold this latch into its "Unlock" position in order to release the battery pack for removal. For more detailed information on removing the battery pack please refer to Chapter 5, [Power and Power-Up Modes](#).
-
-  **Docking port** This port enables connection of an optional TOSHIBA Hi-Speed Port Replicator II described in chapter 3, [Operating Basics](#).
Some models are equipped with a Docking port.
-
- 
 - *Only the TOSHIBA Hi-Speed Port Replicator II can be used with this computer. Do not attempt to use any other Port Replicator.*
 - *Keep foreign objects out of the docking port. A pin or similar object can damage the computer's circuitry.*
-
-  **Memory module slot** The memory module slot allows for the installation, replacement and removal of additional memory module.
1 GB, 2 GB or 4 GB memory modules can be installed in the computer's two memory slots for a maximum of 8 GB system memory. The actual amount of useable system memory will be less than the installed memory modules.
Refer to the [Additional memory module](#) section in Chapter 3, Operating Basics.
-
- Cooling vents** The cooling vents help the processor to avoid overheating.
-



Do not block the cooling vents. Keep foreign metal objects, such as screws, staples and paper clips, out of the cooling vents. Foreign metal objects can create a short circuit, which can cause damage and fire, possibly resulting in serious injury.

Carefully clean the dust on the cooling vents' surface using a soft cloth.

Front with the display open (R850)

This section shows the computer with the display panel open. In order to open the display, lift the display panel up and position it at a comfortable viewing angle for you.

Figure 2-6 The front of the computer with the display panel open (R850)

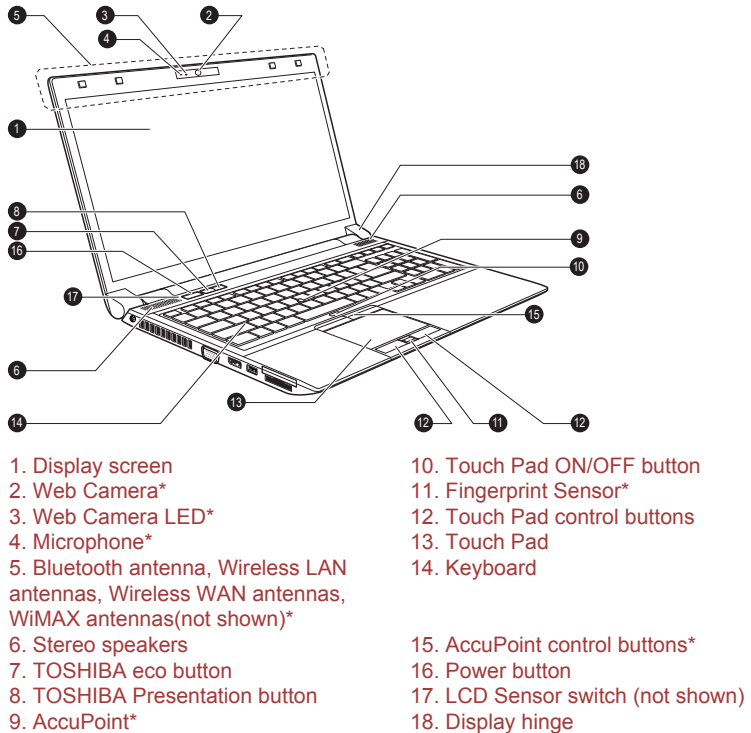

* Provided with some models.

Product appearance depends on the model you purchased.

Display screen

39.6cm (15.6") LCD screen, 16 million colors, configured with the following resolution:

- HD+, 1600 horizontal x 900 vertical pixels
- HD, 1366 horizontal x 768 vertical pixels

Please be aware that, when the computer is operating on the AC adaptor, the image displayed on the internal screen will be somewhat brighter than when it operates on battery power. This difference in brightness levels is intended to save power when operating on batteries.

Legal Footnote (LCD)

For more information regarding LCD, please refer to the Legal Footnotes section in Appendix C.

Web Camera LED	The Web Camera LED glows when the Web Camera is operating.
Web Camera	<p>Web Camera is a device that allows you to record video or take photographs with your computer. You can use it for video chatting or video conferences using a communication tool such as Windows Live Messenger. TOSHIBA Web Camera Application will help you to add various video effects to your video or photograph.</p> <p>Enables the transmission of video and use of video chat via the internet using specialized applications.</p> <p>Please refer to the Web Camera Application Online Help for details.</p>
Microphone	A built-in microphone allows you to import and record sounds for your application - please refer to the Sound System section in Chapter 3, Operating Basics for more information.



- *Do not point the web camera directly at the sun.*
- *Do not touch or press strongly on the web camera lens. Doing so may reduce image quality. Use an eyeglass cleaner (cleaner cloth) or other soft cloth to clean the lens if it becomes dirty.*
- *When recording in dimly lit environments, select "Night Mode" which allows for brighter images with less noise.*

Wireless LAN antennas	Some computers in this series are equipped with the Wireless LAN antennas.
------------------------------	--

Legal Footnote (Wireless LAN)







For more information regarding Wireless LAN, please refer to the Legal Footnotes section in Appendix C.

Wireless WAN antennas	Some computers in this series are equipped with the Wireless WAN antennas.
------------------------------	--

WiMAX antennas	Some computers in this series are equipped with the WiMAX antennas.
-----------------------	---

Bluetooth antenna	Some computers in this series are equipped with the Bluetooth antenna.
--------------------------	--

Stereo speakers	The speakers emit sound generated by your software as well as audio alarms, such as low battery condition, generated by the system.
------------------------	---

	eco button	Press this button to launch the TOSHIBA eco Utility. TOSHIBA eco Utility can be used only in Windows® 7.
	TOSHIBA Presentation button	The TOSHIBA Presentation button has the same functionality as the Connect display button in the Mobility Center.
	AccuPoint	A pointer control device located in the center of the keyboard is used to control the on-screen pointer. Refer to the Using the AccuPoint section in Chapter 3, Operating Basics. Some models are equipped with a AccuPoint.
	Touch Pad ON/OFF button	Pressing the Touch Pad ON/OFF button enables or disables the Touch Pad function.
	Touch Pad control buttons	The control buttons located below the Touch Pad allow you to select menu items or manipulate text and graphics as designated by the on-screen pointer.
	Touch Pad	The Touch Pad located in the palm rest is used to control the movement of the on-screen pointer. For more information, please refer to the Using the Touch Pad in Chapter 3, Operating Basics.
	Fingerprint Sensor	This sensor enables you to enroll and recognize a fingerprint. For detailed information on Fingerprint Sensor, refer to chapter 3, Using the Fingerprint Sensor . Some models are equipped with a Fingerprint Sensor.
	Keyboard	The internal keyboard provides dedicated numeric keys, dedicated cursor control keys,  and  Keys. Refer to the The Keyboard section in Chapter 3, Operating Basics, for details.
	AccuPoint control buttons	Control buttons below the keyboard let you select menu items or manipulate text and graphics designated by the on-screen pointer. Refer to the Using the AccuPoint section in Chapter 3, Operating Basics. Some models are equipped with the AccuPoint control buttons.
	Power button	Press this button to turn the computer's power on and off.

Display hinges

The display hinges allow the display panel to be positioned at a variety of easy-to-view angles.

LCD Sensor switch

This switch senses when the display panel is either closed or opened and activates the Panel Power Off/On feature as appropriate. For example, when you close the display panel the computer enters Hibernation Mode and shuts itself down and then, when you next open the display, the computer will automatically start up and return you to the application you were previously working on.

You can specify within the Power Options. To access it, click **Start -> Control Panel -> System and Security -> Power Options**.



Do not put any magnetic objects close to this switch as they may cause the computer to automatically enter Hibernation Mode and shut down even if the Panel Power Off feature is disabled.

The Grand Tour for R840

Front with the display closed (R840)

The following figure shows the computer's front with its display panel in the closed position.



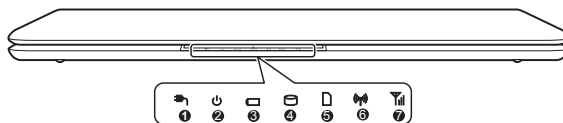



Figure 2-7 Front of the computer with display panel closed (R840)



1. DC IN indicator
2. Power indicator
3. Battery indicator
4. Hard Disk Drive/Optical Disc Drive/eSATA indicator
5. Memory media slot indicator
6. Wireless communication indicator
7. Wireless WAN/WiMAX indicator

**DC IN indicator**

The **DC IN indicator** normally glows green when power is being correctly supplied from the AC power adaptor. However, if the output voltage from the adaptor is abnormal, or if the computer's power supply malfunctions, this indicator will flash orange.

	Power indicator	The Power indicator normally glows green when the computer is turned on. However, if you turn the computer off into Sleep Mode, this indicator will flash orange - approximately two seconds on, two seconds off - both while the system is shutting down and while it remains turned off.
	Battery indicator	The Battery indicator shows the condition of the battery's charge - green indicates the battery is fully charged, orange indicates the battery is charging, and flashing orange indicates a low battery condition. Please refer to Chapter 5, <i>Power and Power-Up Modes</i> for more information on this feature.
	Hard Disk Drive/Optical Disc Drive/eSATA indicator	The Hard Disk Drive/Optical Disc Drive/eSATA indicator blinks green whenever the computer is accessing the built-in hard disk drive, optical disc drive or eSATA device.
	Memory media slot indicator	The Memory media slot indicator blinks green when the computer is accessing the memory media slot.
	Wireless communication indicator	The Wireless communication indicator glows orange when the Wireless functions are turned on. Some models are equipped with Wireless functions.
	Wireless WAN/WiMAX indicator	The Wireless WAN/WiMAX indicator glows blue when the Wireless WAN/WiMAX functions are turned on. In some models, the indicator will glow and blink in order to indicate the connection status of the Wireless WAN/WiMAX function. Some models are equipped with a Wireless WAN/WiMAX function.

Left side (R840)

The following figure shows the computer's left side.

Figure 2-8 The left side of the computer (R840)

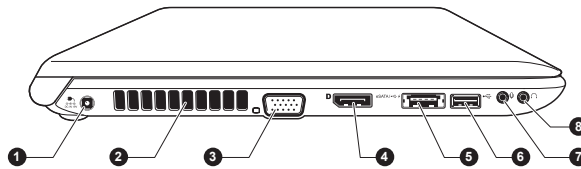

- | | |
|----------------------------------|--|
| 1. DC IN 19V jack | 5. eSATA/USB combo port |
| 2. Cooling vents | 6. Universal Serial Bus (USB 2.0) port |
| 3. External RGB monitor port | 7. Microphone jack |
| 4. HDMI out port or DisplayPort* | 8. Headphone jack |

* Provided with some models.

Product appearance depends on the model you purchased.



DC IN 19V jack

The AC adaptor connects to this jack in order to power the computer and charge its internal batteries. Please note that you should only use the model of AC adaptor supplied with the computer at the time of purchase - using the wrong AC adaptor can cause damage to the computer.

Cooling vents

The cooling vents help the processor to avoid overheating.



Do not block the cooling vents. Keep foreign metal objects, such as screws, staples and paper clips, out of the cooling vents. Foreign metal objects can create a short circuit, which can cause damage and fire, possibly resulting in serious injury.



External RGB monitor port

This port provides 15-pin, analog VGA port. Please refer to Appendix A for information on external RGB monitor port pin assignment. This port allows you to connect an external RGB monitor to the computer.







HDMI out port

HDMI out port can connect with Type A connector HDMI cable. Some models are equipped with an HDMI out port.



DisplayPort

One DisplayPort, which complies to the V1.1a standard, is provided on the left side of the computer. Some models are equipped with a DisplayPort.

eSATA / 	eSATA/USB combo port	One eSATA/USB combo port, which complies to the USB 2.0 standard, is provided on the left side of the computer. This port has eSATA (External Serial ATA) function. The port with the icon  has <i>Sleep and Charge</i> function.
	Universal Serial Bus (USB 2.0) port	One Universal Serial Bus port, which complies to the USB 2.0 standard, is provided on the left side of the computer.
	Microphone jack	A 3.5 mm mini microphone jack enables connection of a three-conductor mini jack for monaural microphone input.
	Headphone jack	A 3.5 mm mini headphone jack enables connection of stereo headphones.



The integrated sound system provides support for the computer's internal speakers and microphone, as well as allowing an external microphone and headphones to be connected via the appropriate jacks.

Right side (R840)

The following figure shows the computer's right side.

Figure 2-9 The right side of the computer (R840)

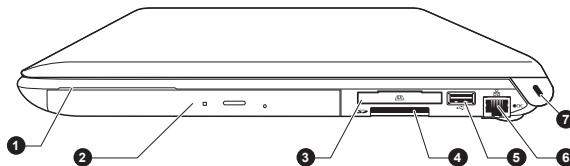

- | | |
|------------------------|---|
| 1. SmartCard slot* | 5. Universal Serial Bus (USB 2.0 or 3.0) port |
| 2. Optical disc drive* | 6. LAN jack |
| 3. ExpressCard slot* | 7. Security lock slot |
| 4. Memory media slot | |

* Provided with some models.

Product appearance depends on the model you purchased.



Smart Card slot	This slot allows you to install a smart card device. Some models are equipped with a Smart Card slot.
Optical disc drive	The computer may be configured with a DVD Super Multi with Double Layer recording drive.



2.6GB and 5.2GB DVD-RAM media cannot be read from or written to.



ExpressCard slot

This slot allows you to install a single ExpressCard/34 device.

Some models are equipped with a ExpressCard slot.



Memory media slot

This slot lets you insert an SD™/SDHC™/SDXC™ memory card, miniSD™/microSD™ Card and MultiMediaCard™. Refer to the Optional devices section in Chapter 3, [Operating Basics](#) for more information.



Universal Serial Bus (USB 2.0 or 3.0) port

One Universal Serial Bus port, which complies to the USB 2.0 or 3.0 standard, is provided on the right side of the computer.

The USB port type may vary depending on the model you purchased. The Port with blue color is USB 3.0 port.

The USB 2.0 port is compliant with USB 2.0 standard and not compatible with USB 3.0 devices.

The USB 3.0 port is compliant with USB 3.0 standard and backward compatible with USB 2.0 devices.



LAN jack

This jack lets you connect to a LAN. The adaptor has built-in support for Ethernet LAN (10 megabits per second, 10BASE-T), Fast Ethernet LAN (100 megabits per second, 100BASE-TX) or Gigabit Ethernet LAN (1000 megabits per second, 1000BASE-T). Refer to chapter 3, [Operating Basics](#), for details.



- *Do not connect any cable other than a LAN cable to the LAN jack. It could cause damage or malfunction.*
- *Do not connect the LAN cable to a power supply. It could cause damage or malfunction.*



Security lock slot

A security cable can be attached to this slot and then connected to a desk or other large object in order to deter theft of the computer.



Please note that it is not possible to confirm the operation of all functions of all USB devices that are available. In view of this it may be noted that some functions associated with a specific device might not operate properly.



Keep foreign metal objects, such as screws, staples and paper clips, out of the Memory media slot, ExpressCard slot, eSATA/USB combo port and USB port. Foreign metal objects can create a short circuit, which can cause damage and fire, possibly resulting in serious injury.

Back (R840)

The following figure shows the computer's back.

Figure 2-10 The back of the computer (R840)

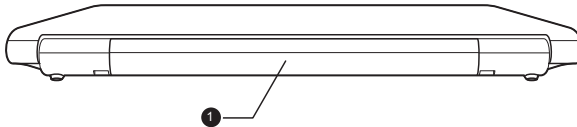

1. Battery pack

Battery pack

The rechargeable lithium-ion battery pack provides power to the computer when the AC adaptor is not connected. For more detailed information on the use and operation of the battery pack please refer to Chapter 5, [Power and Power-Up Modes](#).

Legal Footnote (Battery Life)

For more information regarding Battery Life, please refer to the Legal Footnotes section in Appendix C.

Underside (R840)

The following figure shows the underside of the computer. You should ensure that the display is closed before the computer is turned over to avoid causing any damage.



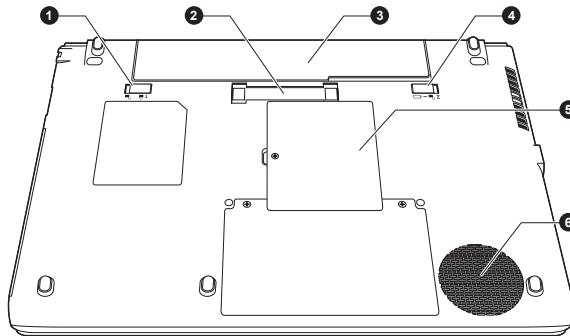

Figure 2-11 The underside of the computer (R840)



- | | |
|------------------|--------------------------|
| 1. Battery lock | 4. Battery release latch |
| 2. Docking port* | 5. Memory module slot |
| 3. Battery Pack | 6. Cooling vents |

* Provided with some models.

Product appearance depends on the model you purchased.

- | | | |
|---|---|---|
|  | <p>Battery lock</p> | <p>Slide the battery lock to release the battery pack ready for removal.</p> |
| <hr/> | | |
|  | <p>Docking port</p> | <p>This port enables connection of an optional TOSHIBA Hi-Speed Port Replicator II described in chapter 3, Operating Basics.</p> <p>Some models are equipped with a Docking port.</p> |
| <hr/> | | |
|  | <ul style="list-style-type: none"> ■ <i>Only the TOSHIBA Hi-Speed Port Replicator II can be used with this computer. Do not attempt to use any other Port Replicator.</i> ■ <i>Keep foreign objects out of the docking port. A pin or similar object can damage the computer's circuitry.</i> | |
| <hr/> | | |
|  | <p>Battery release latch</p> | <p>Slide and hold this latch into its "Unlock" position in order to release the battery pack for removal. For more detailed information on removing the battery pack please refer to Chapter 5, Power and Power-Up Modes.</p> |

**Memory module slot**

The memory module slot allows for the installation, replacement and removal of additional memory module.

1 GB, 2 GB or 4 GB memory modules can be installed in the computer's two memory slots for a maximum of 8 GB system memory. The actual amount of useable system memory will be less than the installed memory modules.

Refer to the [Additional memory module](#) section in Chapter 3, Operating Basics.

Cooling vents

The cooling vents help the processor to avoid overheating.



Do not block the cooling vents. Keep foreign metal objects, such as screws, staples and paper clips, out of the cooling vents. Foreign metal objects can create a short circuit, which can cause damage and fire, possibly resulting in serious injury.

Carefully clean the dust on the cooling vents' surface using a soft cloth.

Front with the display open (R840)

This section shows the computer with the display panel open. In order to open the display, lift the display panel up and position it at a comfortable viewing angle for you.

Figure 2-12 The front of the computer with the display panel open (R840)

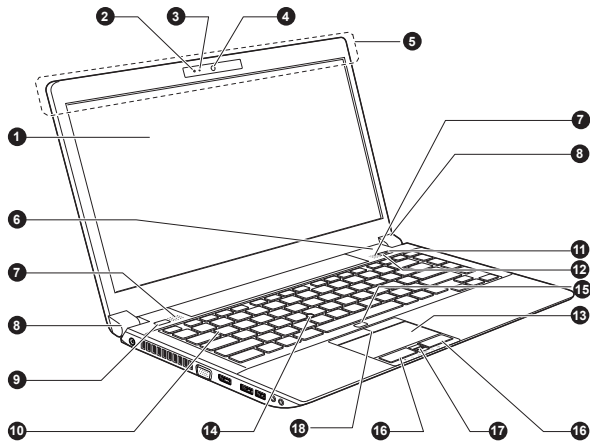

- | | |
|--|---------------------------------|
| 1. Display screen | 10. Keyboard |
| 2. Microphone* | 11. TOSHIBA Presentation button |
| 3. Web Camera LED* | 12. TOSHIBA eco button |
| 4. Web Camera* | 13. Touch Pad |
| 5. Bluetooth antenna, Wireless LAN antennas, Wireless WAN antennas, WiMAX antennas(not shown)* | 14. AccuPoint* |
| 6. LCD Sensor switch (not shown) | 15. Touch Pad ON/OFF button |
| 7. Stereo speakers | 16. Touch Pad control buttons |
| 8. Display hinge | 17. Fingerprint Sensor* |
| 9. Power button | 18. AccuPoint control buttons* |

* Provided with some models.

Product appearance depends on the model you purchased.

Display screen

35.6cm (14.0") LCD screen, 16 million colors, configured with the following resolution:

- HD+, 1600 horizontal x 900 vertical pixels
- HD, 1366 horizontal x 768 vertical pixels

Please be aware that, when the computer is operating on the AC adaptor, the image displayed on the internal screen will be somewhat brighter than when it operates on battery power. This difference in brightness levels is intended to save power when operating on batteries.

Legal Footnote (LCD)

For more information regarding LCD, please refer to the Legal Footnotes section in Appendix C.

Microphone	A built-in microphone allows you to import and record sounds for your application - please refer to the Sound System section in Chapter 3, Operating Basics for more information.
Web Camera LED	The Web Camera LED glows when the Web Camera is operating.
Web Camera	<p>Web Camera is a device that allows you to record video or take photographs with your computer. You can use it for video chatting or video conferences using a communication tool such as Windows Live Messenger. TOSHIBA Web Camera Application will help you to add various video effects to your video or photograph.</p> <p>Enables the transmission of video and use of video chat via the internet using specialized applications.</p> <p>Please refer to the Web Camera Application Online Help for details.</p>



- *Do not point the web camera directly at the sun.*
- *Do not touch or press strongly on the web camera lens. Doing so may reduce image quality. Use an eyeglass cleaner (cleaner cloth) or other soft cloth to clean the lens if it becomes dirty.*
- *When recording in dimly lit environments, select "Night Mode" which allows for brighter images with less noise.*

Wireless LAN antennas	Some computers in this series are equipped with the Wireless LAN antennas.
------------------------------	--

Legal Footnote (Wireless LAN)

For more information regarding Wireless LAN, please refer to the Legal Footnotes section in Appendix C.

Wireless WAN antennas	Some computers in this series are equipped with the Wireless WAN antennas.
------------------------------	--

WiMAX antennas	Some computers in this series are equipped with the WiMAX antennas.
-----------------------	---

Bluetooth antenna	Some computers in this series are equipped with the Bluetooth antenna.
--------------------------	--

LCD Sensor switch	<p>This switch senses when the display panel is either closed or opened and activates the Panel Power Off/On feature as appropriate. For example, when you close the display panel the computer enters Hibernation Mode and shuts itself down and then, when you next open the display, the computer will automatically start up and return you to the application you were previously working on.</p> <p>You can specify within the Power Options. To access it, click Start -> Control Panel -> System and Security -> Power Options.</p>
--------------------------	---



Do not put any magnetic objects close to this switch as they may cause the computer to automatically enter Hibernation Mode and shut down even if the Panel Power Off feature is disabled.

Stereo speakers	<p>The speakers emit sound generated by your software as well as audio alarms, such as low battery condition, generated by the system.</p>
Display hinges	<p>The display hinges allow the display panel to be positioned at a variety of easy-to-view angles.</p>
	<p>Power button</p> <p>Press this button to turn the computer's power on and off.</p>
Keyboard	<p>The internal keyboard provides the embedded numeric overlay keys, dedicated cursor control overlay keys, and Keys.</p> <p>Refer to the The Keyboard section in Chapter 3, Operating Basics, for details.</p>
	<p>TOSHIBA Presentation button</p> <p>The TOSHIBA Presentation button has the same functionality as the Connect display button in the Mobility Center.</p>
	<p>eco button</p> <p>Press this button to launch the TOSHIBA eco Utility. TOSHIBA eco Utility can be used only in Windows® 7.</p>
Touch Pad	<p>The Touch Pad located in the palm rest is used to control the movement of the on-screen pointer. For more information, please refer to the Using the Touch Pad in Chapter 3, Operating Basics.</p>

AccuPoint	A pointer control device located in the center of the keyboard is used to control the on-screen pointer. Refer to the Using the AccuPoint section in Chapter 3, Operating Basics. Some models are equipped with an AccuPoint.
 Touch Pad ON/OFF button	Pressing the Touch Pad ON/OFF button enables or disables the Touch Pad function.
Touch Pad control buttons	The control buttons located below the Touch Pad allow you to select menu items or manipulate text and graphics as designated by the on-screen pointer.
Fingerprint Sensor	This sensor enables you to enroll and recognize a fingerprint. For detailed information on Fingerprint Sensor, refer to chapter 3, Using the Fingerprint Sensor . Some models are equipped with a Fingerprint Sensor.
AccuPoint control buttons	Control buttons below the keyboard let you select menu items or manipulate text and graphics designated by the on-screen pointer. Refer to the Using the AccuPoint section in Chapter 3, Operating Basics. Some models are equipped with the AccuPoint control buttons.

The Grand Tour for R830





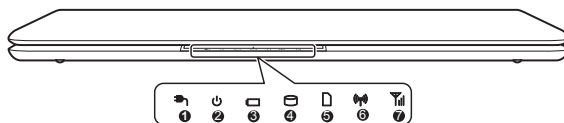

Front with the display closed (R830)

The following figure shows the computer's front with its display panel in the closed position.

Figure 2-13 Front of the computer with display panel closed (R830)



1. DC IN indicator
2. Power indicator
3. Battery indicator
4. Hard Disk Drive/Optical Disc Drive/eSATA indicator
5. Memory media slot indicator
6. Wireless communication indicator
7. Wireless WAN/WiMAX indicator

	DC IN indicator	The DC IN indicator normally glows green when power is being correctly supplied from the AC power adaptor. However, if the output voltage from the adaptor is abnormal, or if the computer's power supply malfunctions, this indicator will flash orange.
	Power indicator	The Power indicator normally glows green when the computer is turned on. However, if you turn the computer off into Sleep Mode, this indicator will flash orange - approximately two seconds on, two seconds off - both while the system is shutting down and while it remains turned off.
	Battery indicator	The Battery indicator shows the condition of the battery's charge - green indicates the battery is fully charged, orange indicates the battery is charging, and flashing orange indicates a low battery condition. Please refer to Chapter 5, Power and Power-Up Modes for more information on this feature.
	Hard Disk Drive/Optical Disc Drive/eSATA indicator	The Hard Disk Drive/Optical Disc Drive/eSATA indicator blinks green whenever the computer is accessing the built-in hard disk drive, optical disc drive or eSATA device.
	Memory media slot indicator	The Memory media slot indicator blinks green when the computer is accessing the memory media slot.
	Wireless communication indicator	The Wireless communication indicator glows orange when the Wireless functions are turned on. Some models are equipped with Wireless functions.
	Wireless WAN/WiMAX indicator	The Wireless WAN/WiMAX indicator glows blue when the Wireless WAN/WiMAX functions are turned on. In some models, the indicator will glow and blink in order to indicate the connection status of the Wireless WAN/WiMAX function. Some models are equipped with a Wireless WAN/WiMAX function.

Left side (R830)

The following figure shows the computer's left side.

Figure 2-14 The left side of the computer (R830)

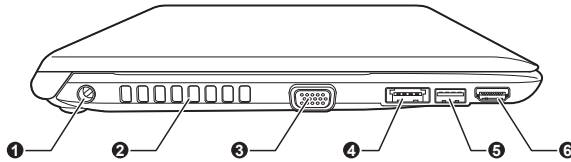

- | | |
|------------------------------|--|
| 1. DC IN 19V jack | 4. eSATA/USB combo port |
| 2. Cooling vents | 5. Universal Serial Bus (USB 2.0) port |
| 3. External RGB monitor port | 6. HDMI out port |

* Provided with some models.

Product appearance depends on the model you purchased.



DC IN 19V jack

The AC adaptor connects to this jack in order to power the computer and charge its internal batteries. Please note that you should only use the model of AC adaptor supplied with the computer at the time of purchase - using the wrong AC adaptor can cause damage to the computer.

Cooling vents

The cooling vents help the processor to avoid overheating.



Do not block the cooling vents. Keep foreign metal objects, such as screws, staples and paper clips, out of the cooling vents. Foreign metal objects can create a short circuit, which can cause damage and fire, possibly resulting in serious injury.



External RGB monitor port



This port provides 15-pin, analog VGA port. Please refer to Appendix A for information on external RGB monitor port pin assignment.

This port allows you to connect an external RGB monitor to the computer.



eSATA/USB combo port

One eSATA/USB combo port, which complies to the USB 2.0 standard, is provided on the left side of the computer. This port has eSATA (External Serial ATA) function. The port with the icon ⚡ has *Sleep and Charge* function.

	Universal Serial Bus (USB 2.0) port	One Universal Serial Bus port, which complies to the USB 2.0 standard, is provided on the left side of the computer.
	HDMI out port	HDMI out port can connect with Type A connector HDMI cable.

Right side (R830)

The following figure shows the computer's right side.

Figure 2-15 The right side of the computer (R830)

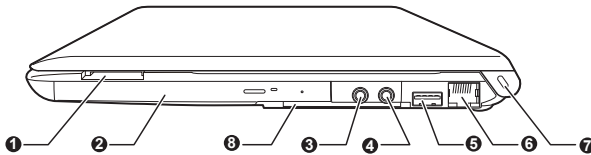

- | | |
|---|--|
| 1. Memory media slot | 6. LAN jack |
| 2. Optical disc drive* | 7. Security lock slot |
| 3. Headphone jack | 8. ExpressCard slot or SmartCard slot* |
| 4. Microphone jack | |
| 5. Universal Serial Bus (USB 2.0 or 3.0) port | |

* Provided with some models.

Product appearance depends on the model you purchased.



Memory media slot	This slot lets you insert an SD™/SDHC™/SDXC™ memory card, miniSD™/microSD™ Card and MultiMediaCard™. Refer to the Optional devices section in Chapter 3, Operating Basics for more information.
--------------------------	---

Optical disc drive	The computer may be configured with a DVD Super Multi with Double Layer recording drive or Blu-ray™ Writer drive.
---------------------------	---



2.6GB and 5.2GB DVD-RAM media cannot be read from or written to.



Headphone jack	A 3.5 mm mini headphone jack enables connection of stereo headphones.
-----------------------	---

**Microphone jack**

A 3.5 mm mini microphone jack enables connection of a three-conductor mini jack for monaural microphone input.



The integrated sound system provides support for the computer's internal speakers and microphone, as well as allowing an external microphone and headphones to be connected via the appropriate jacks.

**Universal Serial Bus (USB 2.0 or 3.0) port**

One Universal Serial Bus port, which complies to the USB 2.0 or 3.0 standard, is provided on the right side of the computer.

The USB port type may vary depending on the model you purchased. The Port with blue color is USB 3.0 port.

The USB 2.0 port is compliant with USB 2.0 standard and not compatible with USB 3.0 devices.

The USB 3.0 port is compliant with USB 3.0 standard and backward compatible with USB 2.0 devices.

**LAN jack**

This jack lets you connect to a LAN. The adaptor has built-in support for Ethernet LAN (10 megabits per second, 10BASE-T), Fast Ethernet LAN (100 megabits per second, 100BASE-TX) or Gigabit Ethernet LAN (1000 megabits per second, 1000BASE-T). Refer to chapter 3, [Operating Basics](#), for details.



- *Do not connect any cable other than a LAN cable to the LAN jack. It could cause damage or malfunction.*
- *Do not connect the LAN cable to a power supply. It could cause damage or malfunction.*

**Security lock slot**

A security cable can be attached to this slot and then connected to a desk or other large object in order to deter theft of the computer.

**ExpressCard slot**

This slot allows you to install a single ExpressCard/54 device.

Some models are equipped with a ExpressCard slot.

**Smart Card slot**

This slot allows you to install a smart card device. Some models are equipped with a Smart Card slot.



Please note that it is not possible to confirm the operation of all functions of all USB devices that are available. In view of this it may be noted that some functions associated with a specific device might not operate properly.



Keep foreign metal objects, such as screws, staples and paper clips, out of the Memory media slot, ExpressCard slot, eSATA/USB combo port and USB port. Foreign metal objects can create a short circuit, which can cause damage and fire, possibly resulting in serious injury.

Back (R830)

The following figure shows the computer's back.

Figure 2-16 The back of the computer (R830)

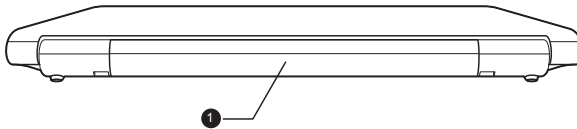
**1. Battery pack****Battery pack**

The rechargeable lithium-ion battery pack provides power to the computer when the AC adaptor is not connected. For more detailed information on the use and operation of the battery pack please refer to Chapter 5, [Power and Power-Up Modes](#).

Legal Footnote (Battery Life)

For more information regarding Battery Life, please refer to the Legal Footnotes section in Appendix C.

Underside (R830)

The following figure shows the underside of the computer. You should ensure that the display is closed before the computer is turned over to avoid causing any damage.

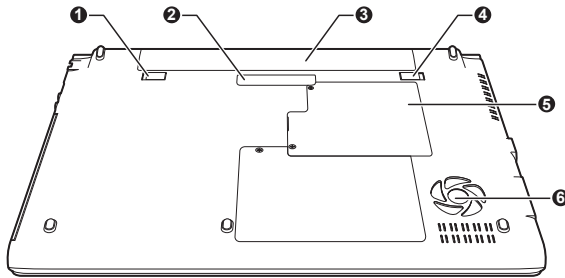

Figure 2-17 The underside of the computer (R830)



- | | |
|------------------|--------------------------|
| 1. Battery lock | 4. Battery release latch |
| 2. Docking port* | 5. Memory module slot |
| 3. Battery Pack | 6. Cooling vents |

* Provided with some models.

Product appearance depends on the model you purchased.



  **Battery lock** Slide the battery lock to release the battery pack ready for removal.



Docking port This port enables connection of an optional TOSHIBA Hi-Speed Port Replicator II described in chapter 3, [Operating Basics](#).
Some models are equipped with a Docking port.



- *Only the TOSHIBA Hi-Speed Port Replicator II can be used with this computer. Do not attempt to use any other Port Replicator.*
- *Keep foreign objects out of the docking port. A pin or similar object can damage the computer's circuitry.*

   **Battery release latch** Slide and hold this latch into its "Unlock" position in order to release the battery pack for removal. For more detailed information on removing the battery pack please refer to Chapter 5, [Power and Power-Up Modes](#).

**Memory module slot**

The memory module slot allows for the installation, replacement and removal of additional memory module.

1 GB, 2 GB or 4 GB memory modules can be installed in the computer's two memory slots for a maximum of 8 GB system memory. The actual amount of useable system memory will be less than the installed memory modules.

Refer to the [Additional memory module](#) section in Chapter 3, Operating Basics.

Cooling vents

The cooling vents help the processor to avoid overheating.



Do not block the cooling vents. Keep foreign metal objects, such as screws, staples and paper clips, out of the cooling vents. Foreign metal objects can create a short circuit, which can cause damage and fire, possibly resulting in serious injury.

Carefully clean the dust on the cooling vents' surface using a soft cloth.

Front with the display open (R830)

This section shows the computer with the display panel open. In order to open the display, lift the display panel up and position it at a comfortable viewing angle for you.

Figure 2-18 The front of the computer with the display panel open (R830)

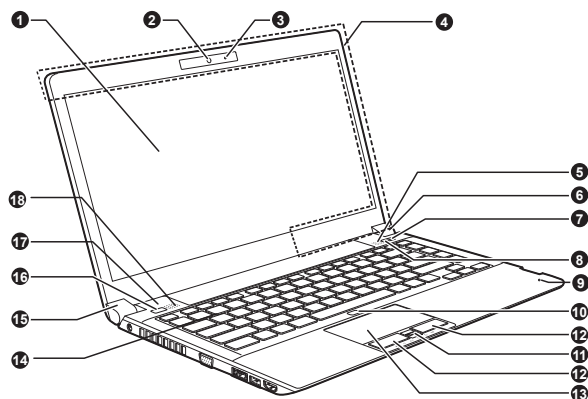

- | | |
|---|-----------------------------------|
| 1. Display screen | 10. Touch Pad ON/OFF button |
| 2. Web Camera* | 11. Fingerprint Sensor* |
| 3. Web Camera LED* | 12. Touch Pad control buttons |
| 4. Bluetooth antenna, Wireless LAN antennas, Wireless WAN antennas, WiMAX antennas (not shown)* | 13. Touch Pad |
| 5. Stereo speaker | 14. Keyboard |
| 6. Display hinge | 15. Display hinge |
| 7. TOSHIBA Presentation button | 16. Power button |
| 8. TOSHIBA eco button | 17. LCD Sensor switch (not shown) |
| 9. Microphone | 18. Stereo speaker |

* Provided with some models.

Product appearance depends on the model you purchased.

Display screen

33.8cm (13.3") LCD screen, 16 million colors, configured with the following resolution:

- HD, 1366 horizontal x 768 vertical pixels

Please be aware that, when the computer is operating on the AC adaptor, the image displayed on the internal screen will be somewhat brighter than when it operates on battery power. This difference in brightness levels is intended to save power when operating on batteries.

Legal Footnote (LCD)

For more information regarding LCD, please refer to the Legal Footnotes section in Appendix C.

Web Camera LED

The Web Camera LED glows when the Web Camera is operating.

Web Camera

Web Camera is a device that allows you to record video or take photographs with your computer. You can use it for video chatting or video conferences using a communication tool such as **Windows Live Messenger**. **TOSHIBA Web Camera Application** will help you to add various video effects to your video or photograph.

Enables the transmission of video and use of video chat via the internet using specialized applications.

Please refer to the Web Camera Application Online Help for details.



- *Do not point the web camera directly at the sun.*
- *Do not touch or press strongly on the web camera lens. Doing so may reduce image quality. Use an eyeglass cleaner (cleaner cloth) or other soft cloth to clean the lens if it becomes dirty.*
- *When recording in dimly lit environments, select "Night Mode" which allows for brighter images with less noise.*

Wireless LAN antennas

Some computers in this series are equipped with the Wireless LAN antennas.

Legal Footnote (Wireless LAN)

For more information regarding Wireless LAN, please refer to the Legal Footnotes section in Appendix C.

Wireless WAN antennas

Some computers in this series are equipped with the Wireless WAN antennas.

WiMAX antennas

Some computers in this series are equipped with the WiMAX antennas.

Bluetooth antenna

Some computers in this series are equipped with the Bluetooth antenna.

Stereo speakers

The speakers emit sound generated by your software as well as audio alarms, such as low battery condition, generated by the system.





Display hinges

The display hinges allow the display panel to be positioned at a variety of easy-to-view angles.



TOSHIBA Presentation button

The TOSHIBA Presentation button has the same functionality as the Connect display button in the Mobility Center.

	eco button	Press this button to launch the TOSHIBA eco Utility. TOSHIBA eco Utility can be used only in Windows® 7.
	Microphone	A built-in microphone allows you to import and record sounds for your application - please refer to the Sound System section in Chapter 3, Operating Basics for more information.
	Touch Pad ON/OFF button	Pressing the Touch Pad ON/OFF button enables or disables the Touch Pad function.
	Touch Pad control buttons	The control buttons located below the Touch Pad allow you to select menu items or manipulate text and graphics as designated by the on-screen pointer.
	Touch Pad	The Touch Pad located in the palm rest is used to control the movement of the on-screen pointer. For more information, please refer to the Using the Touch Pad in Chapter 3, Operating Basics.
	Fingerprint Sensor	This sensor enables you to enroll and recognize a fingerprint. For detailed information on Fingerprint Sensor, refer to chapter 3, Using the Fingerprint Sensor . Some models are equipped with a Fingerprint Sensor.
	Keyboard	The internal keyboard provides the embedded numeric overlay keys, dedicated cursor control overlay keys,  and  Keys. Refer to the The Keyboard section in Chapter 3, Operating Basics, for details.
	Power button	Press this button to turn the computer's power on and off.

LCD Sensor switch

This switch senses when the display panel is either closed or opened and activates the Panel Power Off/On feature as appropriate. For example, when you close the display panel the computer enters Hibernation Mode and shuts itself down and then, when you next open the display, the computer will automatically start up and return you to the application you were previously working on.

You can specify within the Power Options. To access it, click **Start -> Control Panel -> System and Security -> Power Options**.



Do not put any magnetic objects close to this switch as they may cause the computer to automatically enter Hibernation Mode and shut down even if the Panel Power Off feature is disabled.

Internal Hardware Components

This section describes the internal hardware components of your computer. The actual specifications may vary depending on the model you purchased.

CPU

The processor type varies depending on model. To check which type of processor is included in your model, open the TOSHIBA PC Diagnostic Tool Utility by clicking **Start -> All Programs -> TOSHIBA -> Utilities -> PC Diagnostic Tool**.

Legal Footnote (CPU)

For more information regarding CPU, please refer to the Legal Footnotes section in Appendix C.

Hard Disk Drive or Solid State Drive

The size of the hard disk drive varies depending on the model.

To check which type of HDD/SSD is included in your model, open the TOSHIBA PC Diagnostic Tool Utility by clicking **Start -> All Programs -> TOSHIBA -> Utilities -> PC Diagnostic Tool**.

Please note that part of the hard disk's overall capacity is reserved as administration space.



■ *In this manual, the word "HDD" or "Hard disk drive" also refers to the SSD unless otherwise stated.*

- *SSD is a large-capacity storage media which uses Solid-State Memory in place of a magnetic disk of the hard disk.*



Under certain unusual conditions of prolonged non-use and/or exposure to high temperatures, the SSD may be vulnerable to data retention errors.

Legal Footnote (Hard Disk Drive (HDD) Capacity)

For more information regarding Hard Disk Drive (HDD) Capacity, please refer to the Legal Footnotes section in Appendix C.

RTC battery

The internal RTC battery backs up the Real Time Clock (RTC) and calendar.

Video RAM

The memory in a computer's graphics adaptor, used to store the image displayed on a bitmap display.

The amount of Video RAM available is dependent on the computer's system memory.

Start -> Control Panel -> Appearance and Personalization -> Display -> Adjust resolution.

The amount of Video RAM can be verified by clicking the **Advanced settings** button in the Screen Resolution window.

Legal Footnote (Memory (Main System))

For more information regarding Memory (Main System), please refer to the Legal Footnotes section in Appendix C.

Display controller

The display controller interprets software commands into hardware commands that turn particular parts on the screen on or off.

The display controller also controls the video mode and uses industry standard rules to govern the screen resolution and the maximum number of colors that can be displayed at any one time. Therefore, software written for a given video mode will run on any computer that supports that mode.



Due to the display panel's increased resolution, lines may appear broken in when displaying images in full-screen text mode.

Graphics controller	The graphics controller maximizes display performance.
----------------------------	--

Legal Footnote (Graphics Processing Unit ("GPU"))

For more information regarding Graphics Processing Unit ("GPU"), please refer to the Legal Footnotes section in Appendix C.

Intel® Display Power Saving Technology (R850 & R840)

Intel GPU model may include the Display Power Saving Technology feature that can save the computer's power consumption by optimizing picture contrast on the internal LCD.

This feature can be used if the computer is:

- running under battery mode
- using the internal LCD display only

The Display Power Saving Technology feature is disabled at factory default. If you want to expand computer's battery life time, you can enable this feature.

The Display Power Saving Technology feature can be enabled in the Intel® Graphics and Media Control Panel.

You can access this control panel in one of the following ways:

- Click **Start -> Control Panel**. Select **Large icons** or **Small icons** in **View by**, and then click **Intel(R) Graphics and Media**.
- Right-click on the desktop and click **Graphics Properties...**

In this control panel:

1. Click **Power**.
2. Select **On battery** from the drop-down menu in **Power Source**.
3. Select the **Display Power Saving Technology** check box if the check box is not selected.
4. Set slider bar from **Maximum Quality** position to another position.
5. Click **OK**.

If you want to disable this feature, under the conditions mentioned above, adjust the setting towards **Maximum Quality**.

Intel® Display Power Saving Technology (R830)

Intel GPU model may include the Display Power Saving Technology feature that can save the computer's power consumption by optimizing picture contrast on the internal LCD.

This feature can be used if the computer is:

- running under battery mode
- using the internal LCD display only

The Display Power Saving Technology feature is enabled at factory default. If you want to disable this feature, you can disable it.

The Display Power Saving Technology feature can be disabled in the Intel® Graphics and Media Control Panel.

You can access this control panel in one of the following ways:

- Click **Start -> Control Panel**. Select **Large icons** or **Small icons** in **View by**, and then click **Intel(R) Graphics and Media**.
- Right-click on the desktop and click **Graphics Properties...**

In this control panel:

1. Click **Power**.
2. Select **On battery** from the drop-down menu in **Power Source**.
3. Clear the **Display Power Saving Technology** check box.
4. Click **OK**.

If you want to enable this feature, under the conditions mentioned above, select the **Display Power Saving Technology** check box.

AMD® Vari-Bright™

AMD GPU model may include the AMD® Vari-Bright™ feature that can save the computer's power consumption by optimizing picture contrast on the internal LCD.

This feature can be used if the computer is:

- running under battery mode
- using the internal LCD display only

The Vari-Bright™ feature is disabled at factory default. If you want to expand computer's battery life time, you can enable this feature.

The Vari-Bright feature can be enabled in the Catalyst Control Center.

To access this center, go to

Start -> All Programs -> Catalyst Control Center -> CCC

In this control center,

1. Select **Power**, and then select **PowerPlay™**.
2. Select the **Enable Vari-Bright™** check box.
3. Click **OK**.

If you want to disable this feature under the conditions mentioned above, clear the **Enable Vari-Bright™** check box.

Chapter 3

Operating Basics

This chapter describes the basic operations of your computer, highlights the precautions that should be taken when using it.

TOSHIBA Dual Pointing Device

Some models are equipped with a dual point system: a Touch Pad and an AccuPoint pointing stick.

Using the Touch Pad

To use the Touch Pad, simply touch and move your fingertip across it in the direction you want the on-screen pointer to go.

Figure 3-1 Touch Pad and Touch Pad control buttons (R850)

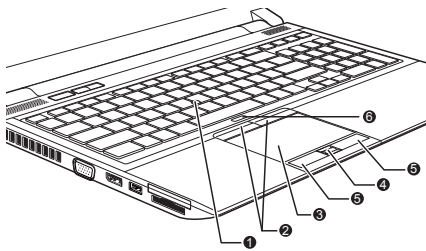

- | | |
|-------------------------------|------------------------------|
| 1. AccuPoint* | 4. Fingerprint Sensor* |
| 2. AccuPoint control buttons* | 5. Touch Pad control buttons |
| 3. Touch Pad | 6. Touch Pad ON/OFF button |
| * Provided with some models. | |

Pressing the Touch Pad ON/OFF button enables or disables the Touch Pad function.

The two buttons below the Touch Pad are used like the buttons on a standard mouse - press the left button to select a menu item or to manipulate text or graphics designated by the pointer, and press the right button to display a menu or other function depending on the software you are using.

Using the AccuPoint

To use the AccuPoint, simply push it with your finger tip in the direction you want to move the on-screen pointer.

Two buttons above the Touch Pad work in the same way with the AccuPoint as they do with the Touch Pad. Refer to the [Using the Touch Pad](#) section for details.

Some models are equipped with an AccuPoint.

AccuPoint precautions

Certain conditions can affect the on-screen pointer when using AccuPoint. For example, the pointer may travel contrary to AccuPoint operation or an error message may appear, if

- You touch the AccuPoint during power-up.
- You apply constant, soft pressure during power-up.
- There is a sudden temperature change.
- Strong stress is applied to the AccuPoint.

If an error message appears, reboot the computer. If an error message does not appear, wait a moment for the pointer to stop, then continue operation.

Replacing the cap

The AccuPoint cap is an expendable item that should be replaced after prolonged use. The spare AccuPoint cap is supplied with some models.

1. To remove the AccuPoint cap, firmly pinch the cap and pull it straight up.

Figure 3-2 Removing the AccuPoint cap (R850)

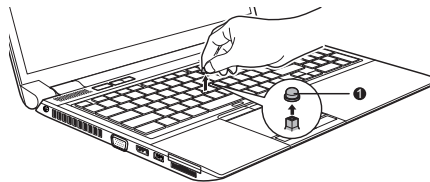

1. AccuPoint cap
2. Position a new cap on the peg and press it into place.



The peg is square, so be careful to align the cap's square hole with the peg.

The Keyboard

The computer's keyboard layouts are compatible with a 104/105-key enhanced keyboard - by pressing some keys in combination, all of the 104/105-key enhanced keyboard functions can be performed on the computer.

The number of keys available on your keyboard will depend on which country/region your computer is configured for, with keyboards being available for numerous languages.

In use there are six different types of keys, specifically typewriter keys, function keys, soft keys, Hot keys, Windows special keys and the keypad overlay.



Never remove the key caps on your keyboard. Doing so could cause damage to the parts under the key caps.

Keyboard indicators

The following figure shows the position of the **CAPS LOCK** indicator which shows the following conditions:

- When the **CAPS LOCK** indicator glows, the keyboard will produce capitals when any letter is typed.

Figure 3-3 CAPS LOCK indicator (R830)

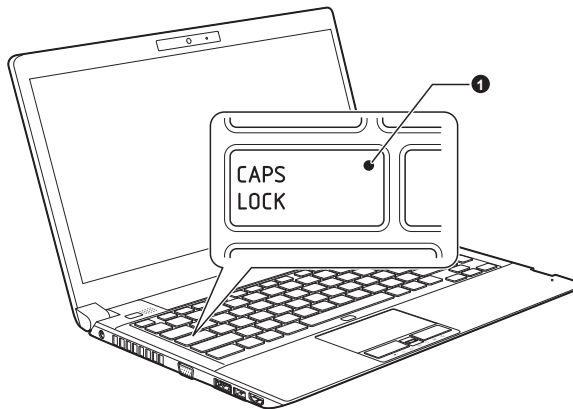

1. CAPS LOCK indicator

CAPS LOCK

This indicator glows green when letter keys are locked into their uppercase format.

Function keys: F1 ... F12

The function keys (not to be confused with the special **FN** key) are the twelve keys at the top of your keyboard - these keys function differently from other keys.



F1 through **F12** are called function keys because they execute programmed functions when pressed and, when used in combination with

the **FN** key, those keys marked with icons also execute specific functions on the computer.

Soft keys: FN key combinations

The **FN** (function) is used in combination with other keys to form soft keys. Soft keys are key combinations that enable, disable or configure specific features.



Please note that some software may disable or interfere with soft-key operations, and that the soft-key settings are not restored when the computer returns from Sleep Mode.

This computer's keyboard is designed to provide all the features of the 104-key enhanced keyboard.

Since the keyboard is smaller and has fewer keys, some of the enhanced keyboard functions must be simulated using two keys instead of one on the larger keyboard.

The **FN** key can be combined with the following keys to simulate functions similar to those of keys on the 104/105 key enhanced keyboard which are not on this computer's keyboard.

- Press **FN + F10** or **FN + F11** to access the computer's integrated keypad. When activated, the keys with grey markings on their bottom edge become either numeric keypad keys (**FN + F11**) or cursor control keys (**FN + F10**).
- Press **FN + F12 (ScrLock)** to lock the cursor on a specific line. The power on default is off.
- Press **FN + ENTER** to simulate **ENTER** on the enhanced keyboard's numeric keypad.



This function is supported with some models.

Hot key functions

Hot key functions let you enable or disable certain features of the computer. The Hot key functions can be performed using either the Hot Key Cards or by pressing the associated Hot keys (pressing **FN** + a function or **ESC** key).

Hot Key Cards

The Hot Key Cards are normally hidden from view. The Cards appear when you press the **FN** key.

To use the Hot Key Cards:

1. Press and hold the **FN** key. The TOSHIBA Flash Cards appear along the top of the screen.

2. Select the desired option.
The selected Card is displayed full-size with its available options below it. All other Cards are again hidden from view.
3. Click the desired option.

To use a Hot Key Card using a hot key:

1. Press and hold the **FN** key.
2. Press the hot key associated with the desired function. The associated hot key card appears at the top of the screen with its available options below it.
3. To cycle through the displayed options, hold down **FN** and press the hot key repeatedly. Release the **FN** key when the desired option is selected.

For more information, please refer to the TOSHIBA Flash Cards Help file.

To access this help, click **Start -> All Programs -> TOSHIBA -> Utilities -> Flash Cards - Help**.

Hot keys

This section describes the associated functions of the hot keys.

- **Mute**
Pressing **FN + ESC** turns the volume on and off.
- **Lock**
Pressing **FN + F1** enters "Lock computer mode". To restore your desktop, you need to log on again.
- **Power Plan**
Pressing **FN + F2** changes the power settings.
- **Sleep**
Pressing **FN + F3** switches the system to Sleep Mode.
- **Hibernate**
Pressing **FN + F4** switches the system to Hibernation Mode.
- **Output**
Pressing **FN + F5** changes the active display device.



To use a simultaneous mode, you must set the resolution of the internal display panel to match the resolution of the external display device.

- **Brightness Down**
Pressing **FN + F6** decreases the computer's display panel brightness in individual steps.
- **Brightness Up**
Pressing **FN + F7** increases the computer's display panel brightness in individual steps.
- **Wireless**
Pressing **FN + F8** switches the active wireless devices.



If no wireless communication device is installed, no dialog box will appear.

- **Touch Pad**
Pressing **FN + F9** enables or disables the Touch Pad function.
- **Zoom (Display resolution)**
Pressing **FN + Space** changes the display resolution.
- **ODD**
Pressing **FN + TAB** ejects the disc tray.
- **Reduce**
Pressing **FN + 1** reduces the icon size on the desktop or the font sizes within one of the supported application windows.
- **Enlarge**
Pressing **FN + 2** enlarges the icon size on the desktop or the font sizes within one of the supported application windows.
- **Volume down**
Pressing **FN + 3** decreases the volume in increment.
- **Volume up**
Pressing **FN + 4** increases the volume in increment.

FN Sticky key

You can use the TOSHIBA Accessibility Utility to make the FN key sticky, that is, you can press it once, release it, and then press an "F Number" key. To start the TOSHIBA Accessibility utility, click **Start -> All Programs -> TOSHIBA -> Utilities -> Accessibility**.

Windows special keys

The keyboard provides two keys that have special functions in Windows, the Windows Start Button key activates the **Start** menu while the application key has the same function as the secondary (right) mouse button.



This key activates the Windows **Start** menu.



This key has the same function as the secondary (right) mouse button.

Keypad overlay

This function is supported with some models.

Your computer's keyboard may not have a separate numeric keypad but includes a numeric keypad overlay which functions like one - this is located in the center of the keyboard with the relevant keys having grey letters at

their front edge. The overlay provides the same function as the numeric keypad on a standard 104/105-key enhanced keyboard.

Turning on the overlays

The numeric keypad overlay can be used for numeric data input or cursor and page control.

Arrow Mode

To turn on Arrow Mode, press **FN + F10** - the Arrow Mode indicator lights and you are able to access cursor and page control functions by using the keys. You are able to press **FN + F10** again to turn off this overlay function.

Numeric Mode

To turn on Numeric Mode, press **FN + F11** - the Numeric Mode indicator lights and you are able to access numeric characters by using the keys. You are able to press **FN + F11** again to turn off this overlay function.

Temporarily using normal keyboard (overlay on)

While using the overlay, you can temporarily access the normal keyboard functions without having to turn the overlay off:

1. Hold down **FN** key and press any other key - this key will operate as if the overlay were off.
2. Type upper-case characters by holding down **FN + SHIFT** and pressing a character key.
3. Release **FN** key to continue using the selected overlay function.

Temporarily using overlay (overlay off)

While using the normal keyboard function, you can temporarily use the keypad overlay without having to turn it on:

1. Hold down **FN** key.
2. Check the keyboard indicators as pressing the **FN** key will turn on the most recently used overlay function - if the Numeric Mode indicator lights you can use the overlay for numeric entry, while if the Arrow Mode indicator lights, you can use the overlay for cursor and page control function.
3. Release **FN** key to return to normal keyboard operation.

Temporarily changing modes

If the computer is in **Numeric Mode**, you can switch temporarily to **Arrow Mode** by pressing a **SHIFT** key, while if it is in **Arrow Mode**, you can switch temporarily to **Numeric Mode** by also pressing a **SHIFT** key.

Generating ASCII characters

Not all ASCII characters can be generated using normal keyboard operation, but you are able to generate these characters using their specific ASCII codes.

1. Hold down **ALT** with the overlay on or **ALT + FN** with overlay off.
2. Using the overlay keys, type the ASCII code of the character you require.
3. Release **ALT** or **ALT + FN** - the ASCII character will appear on the display screen.

Using the Fingerprint Sensor

This product has a fingerprint utility installed for the purpose of enrolling and recognizing fingerprints. By enrolling the ID and password onto the fingerprint authentication feature, it is no longer necessary to input the password from the keyboard. Fingerprint feature enables you to:

- Logon to Windows and access a security enabled homepage through Internet Explorer.
- Files and folders can be encrypted/decrypted and third party access to them prevented.
- Unlock the password-protected screen-saver.
- Authentication of the User Password (and, if applicable, the HDD (Hard Disk Drive) Password) when booting up the computer (boot authentication).
- Single Sign-On feature



Fingerprint cannot be used in models that do not have a fingerprint module installed.

How to Swipe your Finger

Using the following steps when swiping fingers for fingerprint registration or authentication will help to minimize authentication failures:

Align the first joint of the finger to the center of the sensor. Lightly touch the sensor and swipe finger levelly towards you until the sensor surface becomes visible. In performing this process, you should also take care to ensure that the center of your fingerprint is on the sensor.

The following illustrations show the recommended way to swipe your finger over the fingerprint sensor.

Figure 3-6 Swipe the finger

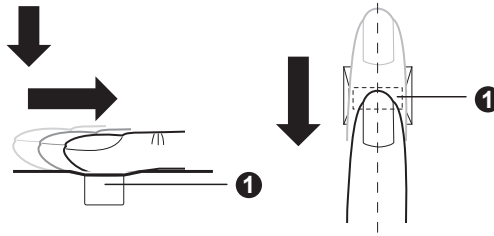

1. Sensor



- *Avoid swiping with your finger stiff or pressed too hard onto the sensor, and take care to ensure that the center of the fingerprint is touching the sensor before swiping. Either of these conditions may cause fingerprint reading to fail.*
- *Check the center of the fingerprint whorl before swiping and then ensure this is swiped along the center line of the sensor.*
- *There is a possibility of authentication failures if the finger is swiped too quickly or too slowly - follow any on-screen instructions to adjust the speed used during the swipe process.*

Points to note about the Fingerprint Sensor

Please be aware of the following considerations when using the fingerprint sensor. A failure to follow these guidelines might result in damage to the sensor, sensor failure, fingerprint recognition problems or a lower fingerprint recognition success rate.

- Do not scratch or poke the sensor with your nails or any hard or sharp objects.
- Do not press the sensor strongly.
- Do not touch the sensor with a wet finger or any wet objects - keep the sensor surface dry and free from water vapor.
- Do not touch the sensor with a soiled or dirty finger as minute foreign particles of dust and dirt may scratch it.
- Do not paste stickers or write on the sensor.
- Do not touch the sensor with a finger or any other object which may have a build-up of static electricity on it.

Observe the following before you place your finger on the sensor whether for fingerprint enrollment/registration or recognition.

- Wash and dry your hands thoroughly.
- Remove static electricity from your fingers by touching any metal surface. Static electricity is a common cause of sensor failures, especially when the weather is dry.

- Clean the sensor with a lint-free cloth - do not use detergent or any other chemicals to clean the sensor.
- Avoid the following finger conditions for enrollment or recognition as they may result in fingerprint enrollment errors or a drop in the fingerprint recognition success rate
- Soaked or swollen finger, for example as may occur after taking a bath.
 - Injured finger
 - Wet finger
 - Soiled or oily finger
 - Extremely dry skin condition on finger

Observe the following to improve the fingerprint recognition success rate.

- Enroll two or more fingers.
- Enroll additional fingers if a recognition failure often occurs when using already enrolled fingers.
- Check the condition of your finger - any conditions which have changed since enrollment, such as injury, rough skin, and extremely dry, wet, soiled, dirty, oily, soaked or swollen fingers, may lower the recognition success rate. Also if the fingerprint is worn down or the finger becomes thinner or fatter, the recognition success rate may be lowered.
- As the fingerprint for each finger is different and unique you should ensure that only the registered or enrolled fingerprint or fingerprints are used for identification.
- Check the position and speed at which you swipe your finger across the sensor - please refer to the preceding drawing.
- The fingerprint sensor compares and analyzes the unique characteristics in a fingerprint. However, there may be instances where certain users are unable to register their fingerprints due to insufficient unique characteristics in their fingerprints.
- The recognition success rate may differ from user to user.

Points to note about Fingerprint Utility

- If Windows 7 file encryption function EFS (Encryption File System) is used to encrypt a file, the file cannot be further encrypted using the encryption function of this software.
- You can back up the fingerprint data or the information registered to Automatic password input in IE.
- Please use Import/Export on TOSHIBA Fingerprint Utility main menu.
- Please also refer to the fingerprint utility Help file for more information. You can start it using the following method:
- Click **Start -> All Programs -> TOSHIBA -> Utilities -> TOSHIBA Fingerprint Utility**. The main screen is displayed. Click ? in the lower left corner of the screen.

Fingerprint utility limitations

TOSHIBA does not guarantee that the fingerprint utility technology will be completely secure or error-free, or that it will accurately screen out unauthorized users at all times. TOSHIBA is not liable for any failure or damage that might arise out of the use of the fingerprint software.



- *The fingerprint sensor compares and analyzes the unique characteristics in a fingerprint. However, there may be instances where certain users are unable to register their fingerprints due to insufficient unique characteristics in their fingerprints.*
- *The recognition success rate may differ from user to user.*

Setup Fingerprint Registration

Please use the following procedure when first using fingerprint authentication.



- *In use, the fingerprint authentication system will use the same username and password as defined within the Windows operating system. If no Windows password has been configured, you must do this before starting the fingerprint registration process.*
- *This sensor has the memory space for at least twenty fingerprint patterns. You might be able to register more fingerprint patterns depending on the sensor memory usage.*

1. Click **Start -> All Programs -> TOSHIBA -> Utilities -> TOSHIBA Fingerprint Utility**, or click the Fingerprint utility icon in the Taskbar.
2. The **Enroll** screen is displayed. Enter the current account password into the **Windows Password** field. If no Windows password has been configured, you will be asked to configure the new logon password. Then click **Next**.
3. Click the non-enrolled finger icon above the finger you want to register and then click **Next**.
4. The note for enrollment operation screen is displayed. Confirm the message and then click **Next**.
5. The scanning practice screen is displayed. You are able to practice swiping (three times) your finger to ensure you use the correct method. When you have finished practicing swiping your finger, click **Next**.
6. Swipe three times with the same finger. If scanning of fingerprint succeeds, "Enrollment succeeded! Do you want to save this fingerprint?" message box will appear. Click **OK**.
7. The following message will be displayed: "It's strongly recommended you enroll one more fingerprint.". Click **OK** and repeat Step 3, 4, 5 and 6 with another finger.



- *It is strongly recommended that you register 2 or more fingerprints.*
- *You cannot enroll the same fingerprint more than once, even on a different user account.*

Delete the Fingerprint Data

Saved fingerprint data is stored in special non-volatile memory inside the fingerprint sensor. Therefore, if you give the computer to someone else, or dispose of it in any way, the following process is recommended to delete your fingerprint information:

Delete the fingerprint data for the currently logged in user

1. Click **Start -> All Programs -> TOSHIBA -> Utilities -> TOSHIBA Fingerprint Utility**, or double click the utility icon in the Taskbar.
2. Swipe your finger across the fingerprint sensor.
3. The **TOSHIBA Fingerprint Utility** main menu is displayed. Select **Enroll** in the main menu.
4. In the **Enroll** window, it enables you to delete the fingerprint data for the currently logged in user. Click an enrolled finger you want to delete. "Are you sure you want to delete this fingerprint template?" message box will appear on the screen and then click **OK**. If you want to delete other fingerprints, repeat this step. If only one fingerprint is registered, the message "Sorry! At least one fingerprint is required." will appear after clicking **OK**. You are not allowed to delete a unique fingerprint.
5. Click **Close**.
6. "Are you sure you want to quit?" is displayed. Click **OK**. It will be returned to the **TOSHIBA Fingerprint Utility** main menu.

Delete all users fingerprints

1. In the **TOSHIBA Fingerprint Utility** main menu, click **Run as administrator** in the lower left.
2. User Account Control window is displayed. Click **Yes**.
3. Swipe your enrolled finger.
4. Select **Fingerprint Control** option.
5. A list of fingerprint information for all users is shown in the screen. Click **Delete All** in the lower right.
6. "Are you sure you want to delete all fingerprints?" message box will appear on the screen. Click **OK**.
7. Click **Close**.
8. "Are you sure you want to quit?" is displayed. Click **OK**. It will be returned to the **TOSHIBA Fingerprint Utility** main menu.

Windows Logon via Fingerprint Authentication

In place of the usual Windows logon by ID and password, fingerprint authentication also allows logon to Windows.

This is useful especially when many users are using the PCs, as user selection can be skipped.

Fingerprint Authentication Procedure

1. Start up the computer.
2. The Logon Authorization screen is displayed. Choose any of the enrolled fingers and swipe the fingerprint on the sensor. If authentication is successful, the user will be logged on to Windows.



- *If the fingerprint authentication fails, please logon using the Windows logon password.*
- *A warning message will be displayed when authentication is abnormal or authentication is not successful within a fixed duration.*

Fingerprint boot authentication and Single Sign-on feature

Overview about Fingerprint boot authentication

The fingerprint authentication system can be used to replace the keyboard based User Password authentication system when booting up.

If you do not want to use the fingerprint authentication system for password authentication when booting up, but prefer to use the keyboard-based system instead, click the user's tile when the Fingerprint System Authentication screen is displayed. This will switch the password input screen across to the keyboard-based one.



- *You must ensure that you use the TOSHIBA Password Utility to register a User Password before using the Fingerprint boot authentication and its extended function to allow fingerprints to be used to access the computer when it is turned on.*
- *When swiping your finger, please ensure that you do it slowly and at a constant speed. If you find that this does not improve the authentication rate, you should try to adjust the speed at which the finger is swiped.*
- *If there are any changes in the environment or settings related to authorization, you will be required to provide authorization information such as a User Password (and, if applicable, the HDD (Hard Disk Drive) password).*

Overview about Fingerprint Single Sign-on feature

This is a feature that allows the user to complete the authentication for both the User/BIOS Password (and, if applicable, the HDD (Hard Disk Drive) Password) and logging onto Windows using only one fingerprint authentication when booting up.

It is necessary to register the User/BIOS Password and Windows Logon Password before using the Fingerprint boot authentication and this Fingerprint Single Sign-On Feature. Please use the TOSHIBA Password Utility to register your User/BIOS Password. If Windows Logon is not the default for your system, see Manual to register your Windows Logon Password.

Only one fingerprint authentication is required to replace the User/BIOS Password (and, if applicable, the HDD (Hard Disk Drive) Password) and the Windows Logon Password.

How to Enable Fingerprint boot authentication and Single Sign-On feature

It is necessary to first enroll your fingerprint with the TOSHIBA Fingerprint Utility prior to enabling and configuring the boot authentication and Single Sign-On feature. You should check that your fingerprint is enrolled before configuring the settings.

1. Logon as Administrator (means a user has administrator privileges).
2. Click **Start -> All Programs -> TOSHIBA -> Utilities -> TOSHIBA Fingerprint Utility**.
3. Swipe your finger across the fingerprint sensor.
4. The **TOSHIBA Fingerprint Utility** main menu is displayed. Click **Run As Administrator** in lower left.
5. User Account Control window is displayed. Click **Yes**.
6. Swipe your finger across the fingerprint sensor.
7. Select **Setting** in the main menu to open the Setting window, you can
Select **Boot authentication** check box if you want to use the fingerprint boot authentication feature.
Select **Boot authentication** and **Single sign-on** check boxes if you want to use the Single Sign-on feature.
8. Click **Apply**.
9. "Save succeeded!" is displayed. Click **OK**.
10. Click **Close**.
11. "Are you sure you want to quit?" is displayed. Click **OK**. It will be returned to the **TOSHIBA Fingerprint Utility** main menu.

This modified configuration for fingerprint boot authentication and Single Sign-on feature becomes effective the next time the system is booted up.

Optical disc drives

The computer may be installed with an Optical Disc Drive. When the computer is accessing an optical disc, an indicator on the drive glows. Some models are equipped with an optical disc drive.

Formats

The drives support the following formats.

DVD Super Multi drive Double Layer

The drive supports the following formats: CD-ROM, DVD-ROM, DVD-Video, CD-DA, CD-Text, Photo CD™ (single/multi-session), CD-ROM Mode 1/Mode 2, CD-ROM XA Mode 2 (Form1, Form2), Enhanced CD (CD-EXTRA), Addressing Method 2, DVD-R, DVD-RW, DVD+R, DVD+RW, DVD-RAM, DVD-R DL (Format1), DVD+R DL.

Blu-ray™ Writer drive

In addition to the above formats, Blu-ray™ Writer drive supports BD-ROM, BD-ROM DL, BD-R, BD-R DL, BD-RE and BD-RE DL.

Using optical disc drives

The full-size drive provides high-performance execution of disc based programs. You can run either 12 cm (4.72") or 8 cm (3.15") discs without an adaptor.



Use the DVD playback application to view DVD-Video discs.

If you have an Optical disc drive, refer also to the [Writing discs](#) section for precautions on writing to discs.

To load discs, follow the steps as detailed below:

1. When the computer's power is on, press the eject button to open the disc tray slightly.

2. Grasp the disc tray gently and pull until it is fully opened.

Figure 3-7 Pressing the eject button and pulling the disc tray open (R830)

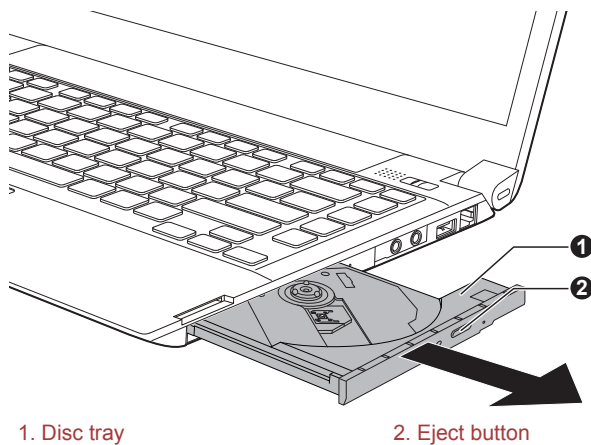

3. Lay the disc, label side up, in the disc tray.

Figure 3-8 Inserting a disc (R830)

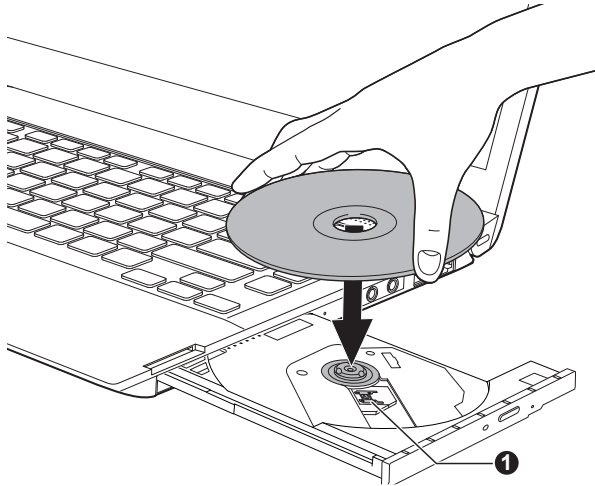

1. Laser lens



When the disc tray is fully opened, the edge of the computer will slightly cover the disc tray. Therefore, you will need to turn the disc at an angle when you place it in the disc tray. After seating the disc, however, make sure it lies flat.



- *Do not touch the laser lens or any portion of its surrounding casing as this could cause misalignment.*
- *Prevent foreign objects from entering the drive. Check the surface of the disc tray, especially the area behind the front edge of the disc tray, to make sure there are no such objects before closing the drive.*

4. Press gently at the center of the disc until you feel it click into place. The disc should lie below the top of the spindle, flush with the spindle base.
5. Push the center of the disc tray to close it. Press gently until it locks into place.



If the disc is not seated properly when the disc tray is closed, the disc might be damaged. Also, the disc tray might not open fully when you press the eject button.

Removing discs

To remove the disc, follow the steps as detailed below:



Do not press the eject button while the computer is accessing the media drive. Wait for the optical disc drive indicator to go out before you open the disc tray. Also, if the disc is spinning when you open the disc tray, wait for it to stop before you remove it.

1. To pop the disc tray partially open, press the eject button. Gently pull the disc tray out until it is fully opened.



When the disc tray pops open slightly, wait a moment to make sure the disc has stopped spinning before pulling the disc tray fully open.

2. The disc extends slightly over the sides of the disc tray so you can grasp it. Gently lift out the disc.
3. Push the center of the disc tray to close it. Press gently until it locks into place.

How to remove disc when the disc tray will not open

Pressing the eject button will not open the disc tray when the computer power is off. If the power is off, you can open the disc tray by inserting a slender object (about 15 mm) such as a straightened paper clip into the eject hole near the eject button.

Figure 3-9 Manual release with the eject hole (R830)

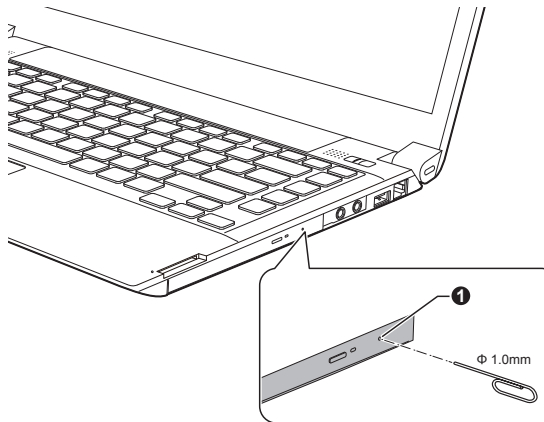

1. Eject hole



Turn off the power before you use the eject hole. If the disc is spinning when you open the disc tray, the disc could fly off the spindle and cause injury.

Writable discs

This section describes the types of writable discs. Check the specifications of your drive to see the types of discs it can write. Use TOSHIBA Disc Creator and Corel Digital Studio to write compact discs.

CDs

- CD-R discs can be written only once. The recorded data cannot be erased or changed.
- CD-RW discs including multi speed CD-RW discs, high-speed CD-RW discs and ultra-speed CD-RW discs can be recorded more than once.

DVDs

- DVD-R, DVD+R, DVD-R DL and DVD+R DL discs can be written only once. The recorded data cannot be erased or changed.
- DVD-RW, DVD+RW and DVD-RAM discs can be recorded more than once.

Blu-ray™ discs

- BD-R, BD-R DL discs can be written only once. The recorded data cannot be erased or changed.
- BD-RE, BD-RE DL discs can be recorded more than once.

Writing discs

The TOSHIBA Disc Creator is provided as writing software with this computer.

Corel Digital Studio can be used to write files in video format. TOSHIBA Disc Creator can be used to write data.

You can use the DVD Super Multi drive to write data to either CD-R, CD-RW, DVD-R, DVD-R DL, DVD-RW, DVD+R, DVD+R DL, DVD+RW or DVD-RAM discs.

You can use the Blu-ray™ Writer drive to write data to either CD-R, CD-RW, DVD-R, DVD-R DL, DVD-RW, DVD+R, DVD+R DL, DVD+RW, DVD-RAM, BD-R, BD-R DL, BD-RE or BD-RE DL discs.



When writing information to media using an optical drive, you should always ensure that you connect the AC adaptor to a live power socket. It is possible that, if data is written while powered by the battery pack, the write process may sometimes fail due to low battery power - in these instances data loss may occur.

Important message

Before you write or rewrite to any of the media supported by the Optical Disc Drive, please read and follow all of the setup and operating

instructions in this section. If you fail to do so, you may find that the Optical Disc Drive may not function properly, and you may fail to write or rewrite information successfully - this may cause you to either lose data or incur other damage to the drive or media.

Disclaimer

TOSHIBA does not bear responsibility for the following:

- Damage to any disc that may be caused by writing or rewriting with this product.
- Any change or loss of the recorded contents of media that may be caused by writing or rewriting with this product, or for any business profit loss or business interruption that may be caused by the change or loss of the recorded contents.
- Damage that may be caused by using third party equipment or software.

Given the technological limitations of current optical disc writing drives, you may experience unexpected writing or rewriting errors due to disc quality or problems with hardware devices. In view of this, it is good practice to make two or more copies of important data, in case of any undesired change or loss of the recorded contents.

Before writing or rewriting

- Based on TOSHIBA's limited compatibility testing, we suggest the following manufacturers of disc media, however, it must be noted that disc quality can affect writing or rewriting success rates. Please also be aware that in no event does TOSHIBA guarantee the operation, quality or performance of any disc.

CD-R:

TAIYO YUDEN CO., Ltd.

MITSUBISHI KAGAKU MEDIA CO., LTD.

CD-RW: (Multi-Speed, High-Speed and Ultra-Speed)

MITSUBISHI KAGAKU MEDIA CO., LTD.

DVD-R:

DVD Specifications for Recordable Disc for General Version 2.0

TAIYO YUDEN Co.,Ltd. (for 8x and 16x speed media)

MITSUBISHI KAGAKU MEDIA CO., LTD. (for 8x and 16x speed media)

Hitachi Maxell, Ltd. (for 8x and 16x speed media)

DVD-R DL:

MITSUBISHI KAGAKU MEDIA CO., LTD. (for 4x and 8x speed media)

DVD+R:

MITSUBISHI KAGAKU MEDIA CO., LTD. (for 8x and 16x speed media)

TAIYO YUDEN CO., Ltd. (for 8x and 16x speed media)

DVD+R DL:

MITSUBISHI KAGAKU MEDIA CO., LTD. (for 8x speed media)

DVD-RW:**DVD Specifications for Recordable Disc for Version 1.1 or version 1.2**

Victor Company of Japan, Ltd. (JVC) (for 2x, 4x and 6x speed media)

MITSUBISHI KAGAKU MEDIA CO., LTD. (for 2x, 4x and 6x speed media)

DVD+RW:

MITSUBISHI KAGAKU MEDIA CO., LTD. (for 4x and 8x speed media)

DVD-RAM: (DVD Super Multi drive only)**DVD Specifications for DVD-RAM Disc for Version 2.0, Version 2.1 or Version 2.2**

Panasonic Corporation (for 3x and 5x speed media)

Hitachi Maxell, Ltd. (for 3x and 5x speed media)

BD-R:

Panasonic Corporation

BD-R DL:

Panasonic Corporation

BD-RE:

Panasonic Corporation

BD-RE DL:

Panasonic Corporation



- *Some types and formats of DVD-R DL and DVD+R DL discs may be unreadable.*
- *DISC created in DVD-R DL format4 (Layer Jump Recording) cannot be read.*

When writing or rewriting

Please observe the following points while you write or rewrite data to a media:

- Always copy data from the hard disk drive to the optical media - do not use the cut-and-paste function as the original data will be lost if there is a write error.
Do not perform any of the following actions:
 - Change users in the Operating Systems.
 - Operate the computer for any other function, including such tasks as using a mouse or Touch Pad, or closing/opening the display panel.
 - Start a communication application such as a modem.
 - Apply impact or vibration to the computer.
 - Install, remove or connect external devices, including such items as an ExpressCard, memory media card, USB device, external monitor or an optical digital device.
 - Use the audio/video control button to reproduce music or voice.
 - Open the optical disc drive.
- Do not use shut down, log off, Sleep Mode or Hibernation Mode functions while writing or rewriting.
- Make sure that the writing/rewriting operation is completed before going into either Sleep Mode or Hibernation Mode (You can remove an optical media on the optical disc drive after writing is completed).
- If the media is of poor quality, or is dirty or damaged, writing or rewriting errors may occur.
- Set the computer on a level surface and avoid places subject to vibration such as airplanes, trains or cars. In addition, do not use the computer on an unstable surface such as a stand.
- Keep mobile phones and other wireless communication devices away from the computer.

TOSHIBA Disc Creator

Please be aware of the following limitations when you use the TOSHIBA Disc Creator:

- DVD Video cannot be created using TOSHIBA Disc Creator.
- DVD Audio cannot be created using TOSHIBA Disc Creator.
- You cannot use TOSHIBA Disc Creator's "Audio CD" function to record music to DVD-R, DVD-R DL, DVD-RW, DVD+R, DVD+R DL or DVD+RW media.
- Do not use the "Disc Backup" function of TOSHIBA Disc Creator in order to copy DVD Video or DVD-ROM material that has copyright protection.
- DVD-RAM discs cannot be backed up using the "Disc Backup" function of TOSHIBA Disc Creator.
- You cannot back up CD-ROM, CD-R or CD-RW media to DVD-R, DVD-R DL or DVD-RW media using the "Disc Backup" function of TOSHIBA Disc Creator.

- You cannot back up CD-ROM, CD-R or CD-RW media to DVD+R, DVD+R DL or DVD+RW media using the "Disc Backup" function of TOSHIBA Disc Creator.
- You cannot back up DVD-ROM, DVD Video, DVD-R, DVD-R DL, DVD-RW, DVD+R, DVD+R DL or DVD+RW to CD-R or CD-RW media using the "Disc Backup" function of TOSHIBA Disc Creator.
- TOSHIBA Disc Creator cannot record in packet format.
- You might not be able to use the "Disc Backup" function of TOSHIBA Disc Creator to back up a DVD-R, DVD-R DL, DVD-RW, DVD+R, DVD+R DL or DVD+RW disc that was made with other software on a different optical media recorder.
- If you add data to a DVD-R, DVD-R DL, DVD+R or DVD+R DL disc that you have already recorded to, you might not be able to read the added data under some circumstances. For example, it cannot be read under 16-bit operating systems, such as Windows 98SE and Windows Me, while in Windows NT4 you will need Service Pack 6 or later, and in Windows 2000, you will need Service Pack 2. In addition to this, some DVD-ROM and DVD-ROM / CD-R/RW drives cannot read this added data regardless of the operating system.
- TOSHIBA Disc Creator does not support recording to DVD-RAM discs - to achieve this you should use Windows Explorer or another similar utility.
- When you back up a DVD disc, be sure that the source drive supports recording to DVD-R, DVD-R DL, DVD-RW, DVD+R, DVD+R DL or DVD+RW media - if this is not the case then the source disc might not be backed up correctly.
- When you back up a DVD-R, DVD-R DL, DVD-RW, DVD+R, DVD+R DL or DVD+RW disc, be sure to use the same type of disc.
- You cannot partially delete any data written to a CD-RW, DVD-RW or DVD+RW disc.

Data Verification

To verify that data has been written or rewritten correctly to a data disc you should follow the steps below before you begin the writing/rewriting process:

1. Click **Start -> All Programs -> TOSHIBA -> CD&DVD Applications -> Disc Creator** to access the **TOSHIBA Disc Creator**.
2. Display the setting dialog box by one of the following two steps:
Click the **Recording settings** button () for writing on the main toolbar in the **Data CD/DVD** mode.
Select **Settings for Each Mode -> Data CD/DVD** in the **Settings** menu.
3. Mark the **Verify Written Data** check box.
4. Select **File Open** or **Full Compare** mode.
5. Click the **OK** button.

How to learn more about TOSHIBA Disc Creator

Please refer to the Help files for additional TOSHIBA Disc Creator information.

Using Corel Digital Studio for TOSHIBA

This feature is supported with some models.

How to make a DVD-Video or a Blu-ray Disc™ Movie

Simplified steps for making a DVD-Video or a Blu-ray Disc™ movie from adding video source:

1. Click **Start -> All Programs -> Corel Digital Studio for TOSHIBA -> Corel Digital Studio for TOSHIBA** to launch Corel Digital Studio.
2. Insert a disc in optical disc drive.
3. Find a source video and drag it onto Media Tray.
4. Click **Burn -> Video Disc**.
5. Select **DVD** or **Blu-ray** in **Select disc**.
6. Select **DVD-Video/AVCHD** or **BDMV** in **Project format**.
7. Input project name and select a style.
8. Click the **Go to menu editing** button.
9. Click the **Burn** button.

How to learn more about Corel Digital Studio

Please refer to the Help and Manual files for additional Corel Digital Studio information.

- Opening the Corel Digital Studio Manual
Press **F1** key when Corel Digital Studio is launched.

Important information for use

Note the following limitations when you write Video DVD or Blu-ray Disc™ movie, file convert or playback files.

Editing digital video

- Log in with Administrator rights to use Corel Digital Studio.
- Make sure that your computer is running on AC power when using Corel Digital Studio.
- Operate the computer at Full Power. Do not use power-saving features.
- While you are editing DVD, you can display preview. However, if another application is running. The preview might not display properly.
- Corel Digital Studio cannot edit or play copy protected content.
- Do not enter Sleep or Hibernation Mode while using Corel Digital Studio.

- Do not operate Corel Digital Studio immediately after turning on the computer. Please wait until all Disc Drive activity has stopped.
- CD recorder, DVD-Audio, Video CD functions are not supported in this version.
- Do not run software like a screen saver because it can put a heavy load on the CPU.
- Do not support mp3 decode and encode.
- DVD-VR format is not supported in this version.

Before recording the video to DVD or Blu-ray Disc™

- When you record DVD disc or Blu-ray Disc™, please use only discs recommended by the Drive manufacturer.
- Do not set the working drive to a slow device like a USB1.1 hard disk drive or it will fail to write DVD or Blu-ray Disc™.
- Do not perform any of the following actions:
 - Operate the computer for any other function, including using a mouse or Touch Pad, or closing/opening the display panel.
 - Bump or cause vibration to the computer.
 - Use the Mode control button and Audio/Video control button to reproduce music or voice.
 - Open the optical disc drive.
 - Install, remove or connect external devices, including the following: memory media card, USB device, external display, optical digital devices.
- Please verify your disc after recording important data.
- Not support to output VCD and SVCD format.
- Force eject disc.

About recorded DVDs and Blu-ray™ discs

- Some DVD-ROM drives for personal computers or other DVD players may not be able to read DVD-R/+R/-RW/+RW/-RAM discs.
- When playing your recorded DVD on your computer, please use the TOSHIBA VIDEO PLAYER software application.
- When playing your recorded Blu-ray Disc™ on your computer, please use the WinDVD BD for TOSHIBA software application.
- If you use an over-used rewritable disc, the full formatting might be locked. Please use a brand new disc.

TOSHIBA VIDEO PLAYER

Please be aware of the following limitations when you use the TOSHIBA VIDEO PLAYER:

Notes on use

- This software can only be used on Windows 7.
- TOSHIBA VIDEO PLAYER software is supported for playback of DVD-Video and DVD-VR.
- Frame dropping, audio skipping or out of sync audio and video may occur during playback of some DVD-Video titles.
- Close all other applications when using the TOSHIBA VIDEO PLAYER. Do not open any other applications or carry out any other operations during video playback. Playback may stop or not function properly in some situations.
- Unfinalized DVDs created on home DVD recorders may not be playable on the computer.
- Use DVD-Video discs with a region code which is either "the same as the factory default setting" (if applicable) or "ALL".
- Do not playback video while watching or recording television programs using other applications. Doing so may cause DVD-Video playback or television program recording errors. In addition, if prescheduled recording starts during DVD-Video playback it may cause DVD-Video playback or television program recording errors. Please view DVD-Video during times when there is no recording prescheduled.
- The resume function cannot be used with some discs on the TOSHIBA VIDEO PLAYER.
- It is recommended the AC adaptor be connected when playing video. Power saving features may interfere with smooth playback. When playing DVD-Video using battery power, set the Power Options to "Balance".
- The screen saver is disabled during video playback using the TOSHIBA VIDEO PLAYER. The computer will not automatically go into Hibernation, Sleep, or shut-down mode.
- Do not configure the Display automatic power off function to run while the TOSHIBA VIDEO PLAYER is running.
- Do not switch to Hibernation or Sleep Mode when running the TOSHIBA VIDEO PLAYER.
- Do not lock the computer using the **Windows logo () + L** keys or the **FN + F1** keys when running the TOSHIBA VIDEO PLAYER.
- The TOSHIBA VIDEO PLAYER does not have a parental control function.
- In order to protect copyrights, the Windows Print Screen function is disabled when TOSHIBA VIDEO PLAYER is running.
- (Print Screen functions are disabled even when running other applications besides TOSHIBA VIDEO PLAYER and when TOSHIBA VIDEO PLAYER is minimized.) Please close the TOSHIBA VIDEO PLAYER to use the Print Screen function.
- Carry out the installation/uninstallation of the TOSHIBA VIDEO PLAYER under a user account with administrator rights.

- Do not change Windows Users while TOSHIBA VIDEO PLAYER is running.
- For some DVD-Video discs, using the control window to change the audio track will also change the subtitle track.
- If you see the screen blinking while playing DVD with subtitle on at Media Player, please use TOSHIBA VIDEO PLAYER or Media Center to play DVD.

Display Devices & Audio

- TOSHIBA VIDEO PLAYER will only run when "Colors" is set to "True Color (32 bit)". Click **Start -> Control Panel -> Appearance and Personalization -> Display -> Adjust resolution**, click "Advanced settings", select "Monitor" tab, set "colors" to "True color (32 bit)".
- If the DVD-Video image is not displayed on an external display or television, stop the TOSHIBA VIDEO PLAYER, and change the screen resolution. To change the screen resolution, click **Start -> Control Panel -> Appearance and Personalization -> Display -> Adjust resolution**. However, video cannot be output to some external displays and televisions due to output or playback conditions.
- When viewing DVD-Video on an external display or TV, change the display device before playing. DVD-Video cannot be displayed simultaneously (in clone mode) on both the computer's display panel and an external display.
- Do not change the screen resolution while running the TOSHIBA VIDEO PLAYER.
- Do not change the display device while running the TOSHIBA VIDEO PLAYER.

Starting TOSHIBA VIDEO PLAYER

Use the following procedure to start TOSHIBA VIDEO PLAYER.

1. Insert a DVD-Video in the optical disc drive while Windows® 7 is running.

When a DVD-Video disc is set in the DVD drive (for models with DVD drive), if the application selection screen appears, select **Play DVD movie, (using TOSHIBA VIDEO PLAYER)** to launch the TOSHIBA VIDEO PLAYER.

2. Select **Start -> All Programs -> TOSHIBA VIDEO PLAYER -> TOSHIBA VIDEO PLAYER** to start TOSHIBA VIDEO PLAYER.

Operating TOSHIBA VIDEO PLAYER

Notes on Using TOSHIBA VIDEO PLAYER.

- Screen display and available features may vary amongst DVD-Videos and scenes.

- If the menu is opened in the Display Area using the Control window's Top Menu or Menu buttons, touch pad and mouse menu operations may not be able to be used.

Open TOSHIBA VIDEO PLAYER HELP

TOSHIBA VIDEO PLAYER features and instructions are also explained in detail in "TOSHIBA VIDEO PLAYER HELP". Use the following procedure to open "TOSHIBA VIDEO PLAYER HELP".

Click the "Help" button () in the Display Area.

Using WinDVD BD for TOSHIBA

Please be aware of the following limitations when you use WinDVD BD for TOSHIBA:

Notes on use

- "WinDVD BD for TOSHIBA" is for Blu-ray Disc™ playback only. DVD playback is not supported. Please use "TOSHIBA VIDEO PLAYER" for DVD playback.
- Playback of high bit rate content may cause frame dropping, audio skipping or decrease in computer performance.
- Close all other applications before playing back Blu-ray Disc™. Do not open any other applications or carry out any other operations during Blu-ray Disc™ playback.
- Do not switch to Hibernation or Sleep Mode when running the "WinDVD BD for TOSHIBA".
- Because Blu-ray Disc™ playback operates according to programs built into the content, operation methods, operation screens, sound effects, icons and other features may vary from disc to disc. For more information on these items refer to instructions included with content or contact the content manufacturers directly.
- Make sure to connect the computer's AC adapter when playing a Blu-ray Disc™.
- "WinDVD BD for TOSHIBA" supports AACS (Advanced Access Control System) copy protection technology. Renewal of the AACS key integrated into this product is required for uninterrupted enjoyment of Blu-ray Disc™. An Internet connection is required for renewal. AACS key renewal is provided free of charge for 5 years after the purchase of this product, however renewal beyond 5 years is subject to conditions specified by the software provider, Corel Corporation.

- Do not playback Blu-ray Disc™ while recording television programs using “Windows Media Center” “My TV” or other applications. Doing so may cause Blu-ray Disc™ playback or television program recording errors. In addition, if pre-scheduled recording starts during Blu-ray Disc™ Video playback it may cause Blu-ray Disc™ Video playback or television program recording errors. Please view Blu-ray Disc™ Video during times when there is no recording prescheduled.
- While playing a BD-J title, keyboard shortcut is ineffective.
- Resume play function cannot be used with some discs on “WinDVD BD for TOSHIBA”.
- The interactive function on Blu-ray™ Discs may not work depending on the contents or network situation.
- Blu-ray™ drives and their associated media are manufactured according to the specifications of three marketing regions. Region codes can be set from WinDVD BD ([Region] tab in [Setup] dialogue). When you purchase Blu-ray™ Video, make sure it matches your drive, otherwise it will not play properly.
- To playback video on an external display or TV using “WinDVD BD for TOSHIBA”, use output devices like external displays or TV that have HDCP supported HDMI port. The video cannot be displayed on an external display or TV connected to the RGB connector.
- The Blu-ray Disc™ movie can be played only on internal LCD displays or external devices connected via an HDMI output. In Clone mode (Dual View), WinDVD plays on a display which set to as the Primary display and shows black screen on the other displays.
- This product does not play HD DVD discs. Blu-ray™ discs with high definition content are required for HD viewing.

Starting WinDVD BD for TOSHIBA

Use the following procedure to start “WinDVD BD for TOSHIBA”.

1. When a Blu-ray Disc™ is set in the Blu-ray™ drive, WinDVD BD for TOSHIBA starts automatically.
2. Select **Start -> All Programs -> Corel -> Corel WinDVD BD** to start “WinDVD BD for TOSHIBA”.

Operating WinDVD BD for TOSHIBA

Notes on Using “WinDVD BD for TOSHIBA”.

- Screen display and available features may vary amongst Blu-ray™ Videos and scenes.
- If the menu is opened in the Display Area using the Control window's Top Menu or Menu buttons, Touch Pad and mouse menu operations may not be able to be used.

Open WinDVD BD for TOSHIBA HELP

WinDVD BD for TOSHIBA features and instructions are also explained in detail in “WinDVD Help”. Use the following procedure to open “WinDVD Help”.

- Click the “Corel Guide” button  in the Display Area.

Wireless communications

The computer’s wireless communication function supports some wireless communication devices.

Only some models are equipped with both Wireless LAN and Bluetooth functions.



- *Do not use the Wireless LAN (Wi-Fi) or Bluetooth functionalities near a microwave oven or in areas subject to radio interference or magnetic fields. Interference from a microwave oven or other source can disrupt Wi-Fi or Bluetooth operation.*
- *Turn all wireless functionalities off when near a person who may have a cardiac pacemaker implant or other medical electric device. Radio waves may affect pacemaker or medical device operation, possibly resulting in serious injury. Follow the instruction of your medical device when using any wireless functionality.*
- *Always turn off wireless functionality if the computer is near automatic control equipment or appliances such as automatic doors or fire detectors. Radio waves can cause malfunction of such equipment, possibly resulting in serious injury.*
- *It may not be possible to make a network connection to a specified network name using the ad hoc network function. If this occurs, the new network(*) will have to be configured for all computers connected to the same network in order to re-enable network connections.
* Please be sure to use new network name.*

Wireless LAN

The Wireless LAN is compatible with other LAN systems based on Direct Sequence Spread Spectrum / Orthogonal Frequency Division Multiplexing radio technology that complies with the IEEE802.11 Wireless LAN standard.

- Frequency Channel Selection of 5GHz for IEEE 802.11a or/and IEEE802.11n
- Frequency Channel Selection of 2.4GHz for IEEE 802.11b/g or/and IEEE802.11n
- Roaming over multiple channels
- Card power management

- Wired Equivalent Privacy (WEP) data encryption based on an 128-bit encryption algorithm
- Wi-Fi Protected Access™ (WPA™)



The transmission speed over the wireless LAN, and the distance over which the wireless LAN can reach, may vary depending on surrounding electromagnetic environment, obstacles, access point design and configuration, client design and software/hardware configurations. The transmission rate described is the theoretical maximum speed as specified under the appropriate standard - the actual transmission speed will be lower than the theoretical maximum speed.

Setting

1. Please make sure that the **Wireless Communication** function is on.
2. Click **Start -> Control Panel -> Network and Internet -> Network and Sharing Center**.
3. Click **Set up a new connection or network**.
4. Follow the wizard. You will need the name of the wireless network together with security settings. Consult the documentation accompanied with your router or ask your wireless network administrator for the settings.

Security

- TOSHIBA strongly recommend that you enable encryption functionality, otherwise your computer will be open to illegal access by an outsider using a wireless connection. If this occurs, the outsider may illegally access your system, eavesdrop, or cause the loss or destruction of stored data.
- TOSHIBA is not liable for the loss of data due to eavesdropping or illegal access through the wireless LAN and the damage thereof.

Card Specifications

Form Factor	PCI Express Mini Card
Compatibility	<ul style="list-style-type: none"> ■ IEEE 802.11 Standard for Wireless LANs ■ Wi-Fi (Wireless Fidelity) certified by the Wi-Fi Alliance. The "Wi-Fi CERTIFIED" logo is a certification mark of the Wi-Fi Alliance.
Network Operating System	<ul style="list-style-type: none"> ■ Microsoft Windows Networking
Media Access Protocol	<ul style="list-style-type: none"> ■ CSMA/CA (Collision Avoidance) with Acknowledgment (ACK)

Radio Characteristics

Radio Characteristics of Wireless LAN module may vary according to:

- Country/region where the product was purchased
- Type of product

Wireless communication is often subject to local radio regulations. Although Wireless LAN wireless networking products have been designed for operation in the license-free 2.4GHz and 5GHz band, local radio regulations may impose a number of limitations to the use of wireless communication equipment.

Radio Frequency	<ul style="list-style-type: none"> ■ Band 5GHz (5150-5850 MHz) (Revision a and n) ■ Band 2.4GHz (2400-2483.5 MHz) (Revision b/g and n)
------------------------	--

The range of the wireless signal is related to the transmit rate of the wireless communication. Communications at lower transmit range may travel larger distances.

- The range of your wireless devices can be affected when the antennas are placed near metal surfaces and solid high-density materials.
- Range is also impacted due to "obstacles" in the signal path of the radio that may either absorb or reflect the radio signal.

Bluetooth wireless technology

Some computers in this series have Bluetooth wireless communication function which eliminates the need for cables between electronic devices such as computers, printers and mobile phones. When it is enabled, Bluetooth provides the wireless personal area network environment which is safe and trustworthy, that is quick and easy.

You cannot use the computer's built-in Bluetooth functions and an external Bluetooth adaptor simultaneously. For reference, Bluetooth wireless technology has the following features:

Worldwide operation

The Bluetooth radio transmitter and receiver operate in the 2.4GHz band, which is license-free and compatible with radio systems in most countries in the world.

Radio links

You can easily establish links between two or more devices, with these links being maintained even if the devices are not within a line-of-sight of each other.

Security

Two advanced security mechanisms ensure a high level of security:

- Authentication prevents access to critical data and makes it impossible to falsify the origin of a message.

- Encryption prevents eavesdropping and maintains link privacy.

Bluetooth Stack for Windows by TOSHIBA

Please note that this software is specifically designed for the following operating systems:

- Windows 7

Information regarding the use of this software with these operating systems is listed below, with further details being contained with the electronic help files supplied with the software.



This Bluetooth Stack is based on the Bluetooth Version 1.1/1.2/2.0+EDR/2.1+EDR/3.0/3.0+HS specification, depending on the model you purchased. However, TOSHIBA cannot confirm the compatibility between any computing products and/or other electronic devices that use Bluetooth, other than TOSHIBA notebook computers.

Release Notes related to the Bluetooth Stack for Windows by TOSHIBA

1. Fax application software: Please be aware that there is some fax application software that you cannot use on this Bluetooth Stack.
2. Multi-user considerations: The use of Bluetooth is not supported in a multi-user environment. This means that, when you use Bluetooth, other users that are logged into the same computer will not be able to use this type of functionality.

Product Support:

The latest information regarding operating system support, language support or available upgrades can be found on our web site <http://www.toshiba-europe.com/computers/tnt/bluetooth.htm> in Europe or www.pcsupport.toshiba.com in the United States.

LAN

The computer has built-in support for Ethernet LAN (10 megabits per second, 10BASE-T), Fast Ethernet LAN (100 megabits per second, 100BASE-TX) or Gigabit Ethernet LAN (1000 megabits per second, 1000BASE-T).

This section describes how to connect/disconnect to a LAN.



Do not install or remove a memory module while Wake-up on LAN is enabled.



- *The Wake-up on LAN function consumes power even when the system is off. Leave the AC adaptor connected while using this feature.*
- *The Link speed (10/100/1000 megabits per second) changes automatically depending on the network conditions (connected device, cable or noise and so on).*

LAN cable types



The computer must be configured properly before connecting to a LAN. Logging onto a LAN using the computer's default settings could cause a malfunction in LAN operation. Check with your LAN administrator regarding set-up procedures.

If you are using Gigabit Ethernet LAN (1000 megabits per second, 1000BASE-T), be sure to connect with a CAT5e cable or higher. You cannot use a CAT3 or CAT5 cable.

If you are using Fast Ethernet LAN (100 megabits per second, 100BASE-TX), be sure to connect with a CAT5 cable or higher. You cannot use a CAT3 cable.

If you are using Ethernet LAN (10 megabits per second, 10BASE-T), you can connect with a CAT3 or higher cable.

Connecting the LAN cable

To connect the LAN cable, follow the steps as detailed below:



- *Connect the AC adaptor before connecting the LAN cable. The AC adaptor must remain connected during LAN use. If you disconnect the AC Adaptor while the computer is accessing a LAN, the system may hang up.*
- *Do not connect any other cable to the LAN jack except the LAN cable. Otherwise, malfunctions or damage may occur.*
- *Do not connect any power supplying device to the LAN cable that is connected to the LAN jack. Otherwise, malfunctions or damage may occur.*

1. Turn off the power to all external devices connected to the computer.

2. Plug one end of the cable into the LAN jack. Press gently until you hear the latch click into place.

Figure 3-10 Connecting the LAN cable (R830)

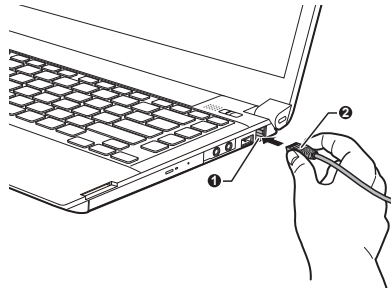

1. LAN jack

2. LAN cable

3. Plug the other end of the cable into a LAN hub connector or router. Check with your LAN administrator and hardware or software vendor before using or configuring a network connection.

Optional devices

Optional devices can expand the computer's capabilities and its versatility. This section describes the connection or installation of the following devices:

Cards/memory

- ExpressCard (ExpressCard/34 or ExpressCard/54)
- Smart Card
- Memory media slot
- Additional memory module

Peripheral devices

- External monitor
- HDMI
- DisplayPort
- eSATA devices
- TOSHIBA Hi-Speed Port Replicator II

Other

- Security lock
- Optional TOSHIBA accessories

ExpressCard

Some models are equipped with a single ExpressCard slot into which any ExpressCard device that meets industry standards, either manufactured by

TOSHIBA or another vendor, can be installed. The slot supports hot plug connection and utilizes the PCI Express interface that supports the reading and writing of data at a theoretical maximum rate of 2.5Gbps.

Inserting an ExpressCard

The Windows hot-install feature allows you to insert ExpressCards while the computer is turned on.



Do not insert an ExpressCard while the computer is in Sleep Mode or Hibernation Mode as you may find that some cards do not work properly.

To insert an ExpressCard, follow the steps as detailed below:

1. Press the Dummy card in order to eject the Dummy card partially out of the computer.
2. Grasp the Dummy card and draw it.
3. Insert the ExpressCard into the ExpressCard slot on the hand side of the computer.
4. Press the ExpressCard gently to ensure a firm connection is made.

Figure 3-11 Inserting the ExpressCard (R830)

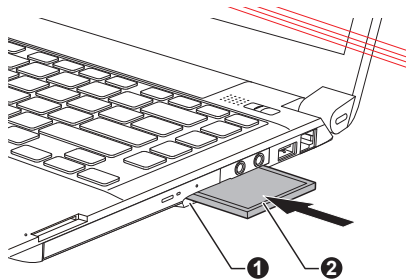

1. ExpressCard slot

2. ExpressCard

5. After inserting the ExpressCard you should refer to its documentation and also check the configuration in Windows in order to ensure that it is correct.

Removing an ExpressCard

To remove an ExpressCard, follow the steps as detailed below.

1. Open the **Safely Remove Hardware and Eject Media** icon on the Windows Taskbar.
2. Point to **ExpressCard** and click the left Touch Pad control button.
3. Press the ExpressCard in order to eject the ExpressCard partially out of the computer.
4. Grasp the ExpressCard and remove it.
5. Insert the Dummy card into the ExpressCard slot.



When you do not use an ExpressCard, please be sure to insert a Dummy card.

Smart Card

A Smart Card is a credit card sized plastic card. An extremely thin integrated circuit (IC chip) is embedded into the card on which information can be recorded. These cards can be used for a wide variety of applications including telephone related and electronic monetary payments.

This section contains information on the proper use of the Smart Card slot, and it is strongly recommended that you read it before operating the computer.

Some models are equipped with a Smart Card slot.



■ *Your computer supports ISO7816-3 asynchronous cards (support protocols are T=0 and T=1) with a working voltage of 5V.*

Inserting a Smart Card

The Smart Card slot is located on the side of the computer. The Windows hot-install feature allows you to insert a Smart Card while the computer is turned on.

To install a Smart Card, follow the steps as detailed below:

1. Insert the Smart Card into the Smart Card slot with the metal connectors facing up.
2. Press the Smart Card gently to ensure a firm connection is made. The computer will identify the Smart Card and display an icon in the Windows Taskbar.



- *When inserting a Smart Card into the Smart Card slot, make sure to confirm that the card is oriented correctly before inserting.*
- *Insert the Smart Card until it reaches the end of the Smart Card slot. There will be about 2cm of the Smart Card sticking out of the Smart Card slot. Do not attempt to insert it further.*
- *Always remove the Smart Card from the Smart Card slot before moving the computer.*
- *Remove the Smart Card after use.*

Failure to follow these instructions may result in damage to the computer and/or damage to the Smart Card.

3. After inserting the Smart Card, you should refer to its documentation and also check the configuration in Windows in order to ensure that it is correct.

Removing a Smart Card

To remove a Smart Card, follow the steps as detailed below:

1. Open the **Safely Remove Hardware and Eject Media** icon on the Windows Taskbar.



- *Before removing the Smart Card, confirm that the Smart Card is not working with any program or system.*
- *Be careful not to bend the Smart Card while removing it from the computer.*

2. Point to **Smart Card** and click the left Touch Pad control button.
3. Grasp the Smart Card and remove it.

Memory media slot

The computer is equipped with a memory media slot that can accommodate some kinds of memory media with various memory capacities so that you can easily transfer data from devices, such as digital cameras and Personal Digital Assistants.



Keep foreign objects out of the memory media slot. Never allow metal objects, such as screws, staples and paper clips, to enter the computer or Keyboard. Foreign metal objects can create a short circuit, which can cause computer damage and fire, possibly resulting in serious injury.



- *Please note that an adaptor is required to use miniSD/microSD Card, Memory Stick Duo, Memory Stick PRO Duo and Memory Stick Micro.*
- *Please note that not all memory media have been tested and verified to work correctly. Therefore, it is not possible to guarantee that all memory media will operate properly.*
- *The slot for some models does not support Magic Gate functions.*

Figure 3-12 Examples of memory media



Secure Digital (SD)
Card



microSD card adaptor
and microSD card



MultiMediaCard
(MMC)



Memory Stick



xD picture card

Memory media

This section provides the important safety precautions in order to handle your memory media.



Points to note about the memory media card

SD/SDHC/SDXC memory cards comply with SDMI (Secure Digital Music Initiative), which is a technology adopted to prevent unlawful copy or playback of digital music. For this reason, you cannot copy or playback protected material on another computer or other device, and you may not reproduce any copyrighted material except for your personal enjoyment.

Below is a simple explanation for distinguishing SD memory cards from SDHC memory cards and SDXC memory cards.

- SD, SDHC and SDXC memory cards appear the same externally. However, the logo on memory cards is different, so pay careful attention to the logo when purchasing.



- The SD memory card logo is ().
- The SDHC memory card logo is ().
- The SDXC memory card logo is ().

- The maximum capacity of SD memory cards is 2GB. The maximum capacity of SDHC memory cards is 32GB.

Card Type	Capacities
SD	8MB, 16MB, 32MB, 64MB, 128MB, 256MB, 512MB, 1GB, 2GB
SDHC	4GB, 8GB, 16GB, 32GB
SDXC	64GB

Memory media format

New media cards are formatted according to specific standards. If you wish to reformat a media card, be sure to do so with a device that uses media cards.

Formatting an memory media card

Memory media cards are sold already formatted in conformity to specific standards. If you reformat an memory card, be sure to reformat it with a device such as digital camera or digital audio player that uses the memory cards, not with the format command provided within Windows.



Should you need to format all areas of the memory card, including the protected area, you will need to obtain an appropriate application that applies the copy protection system.

Media care

Observe the following precautions when handling the card.

Card care

- Do not twist or bend cards.
- Do not expose cards to liquids or store in humid areas or lay media close to containers of liquid.
- Do not touch the metal part of a card or expose it to liquids or let it get dirty.
- After using card, return it to its case.
- The card is designed so that it can be inserted only one way. Do not try to force the card into the slot.
- Do not leave a card partially inserted in the slot. Press the card until you hear it click into place.

Memory card care

- Set the write-protect switch to the lock position, if you do not want to record data.
- Memory cards have a limited lifespan, so it is important to backup important data.
- Do not write to a card if the battery power is low. Low power could affect writing accuracy.
- Do not remove a card while read/write is in progress.



For more details on using memory cards, see manuals accompanying the cards.

About the write-protect

The memory media cards have a function for protect.

- SD Card (SD memory card, SDHC memory card and SDXC memory card)
- Memory Stick (Memory Stick, Memory Stick PRO, Memory Stick Duo, Memory Stick PRO Duo, Memory Stick Micro)



Set the write-protect switch to the lock position, if you do not want to record data.

Inserting a memory media

The following instructions apply to all types of supported media devices. To insert a memory media, follow the steps as detailed below:

1. Turn the memory media so that the contacts (metal areas) are face down.
2. Insert the memory media into the memory media slot on the side of the computer.
3. Press the memory media gently to ensure a firm connection is made.

Figure 3-13 Inserting a memory media (R830)

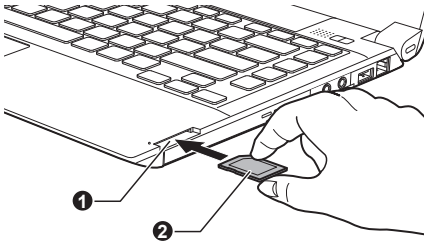

1. Memory media slot

2. Memory media



- *Make sure memory media is oriented properly before you insert it. If you insert the media in wrong direction, you may not be able to remove it.*
- *When inserting memory media, do not touch the metal contacts. You could expose the storage area to static electricity, which can destroy data.*
- *Do not turn the computer off or switch to Sleep Mode or Hibernation Mode while files are being copied - doing so may cause data to be lost.*

Removing a memory media

The following instructions apply to all types of supported media devices. To remove a memory media, follow the steps as detailed below:

1. Open the **Safely Remove Hardware and Eject Media** icon on the Windows Taskbar.
2. Point to **memory media** and click the left Touch Pad control button.
3. Press the memory media to partially extend it out of the computer.
4. Grasp the media and remove it.



- Make sure the **Memory Media slot** indicator is out before you remove the memory media or turn off the computer's power. If you remove the memory media or turn off the power while the computer is accessing the memory media, you may lose data or damage the media.
- Do not remove the memory media while the computer is in Sleep or Hibernation Mode. The computer could become unstable or data in the memory media could be lost.
- Do not remove only the Memory Stick Duo/Memory Stick PRO Duo/Memory Stick Micro/miniSD/microSD Card while leaving the adaptor in the memory media slot.

Additional memory module

You can install additional memory into the computer in order to increase the amount of system memory that is available. This section describes how to install and remove optional memory modules.



- You should place a mat beneath the computer in order to prevent the computer's lid from becoming scratched or damaged when you are installing/replacing the memory module. In this instance you should avoid mats that are made of materials that hold or generate static electricity.
- When installing or removing a memory module, you must ensure that you do not touch any other internal areas of the computer.
- Insert the two memory modules into Slot A and Slot B respectively. The computer will operate in dual channel mode. You can access the inserted memory modules efficiently in dual channel.



- Use only memory modules approved by TOSHIBA.
- Do not try to install or remove a memory module under the following conditions.
 - a. The computer is turned on.
 - b. The computer was shut down in either Sleep or Hibernation Mode.
 - c. Wake-up on LAN is enabled.
 - d. The wireless communication function is on.
 - e. Sleep and Charge function is enabled.
- Be careful not to let screws or other foreign matter fall into the computer. It could cause malfunction or electric shock.

- *Additional memory module is a precision electronic component that may be fatally damaged by static electricity. Since the human body can carry static electricity, it is important that you discharge yourself before touching or installing any additional memory modules. To discharge your body's static electricity, simply touch any metal close to you with bare hands.*



Use a point size 1 Phillips screwdriver for R850/R840 and point size 0 Phillips screwdriver for R830 to remove and fasten the screws - the use of an incorrect screwdriver can damage the screw heads.

Installing a memory module

To install a memory module, follow the steps as detailed below:

1. Shut down the computer - make sure the **Power** indicator is off (refer to the [Turning off the power](#) section in Chapter 1, Getting Started if required).
2. Remove the AC adaptor and all cables and peripherals connected to the computer.
3. Close the display panel.
4. Turn the computer upside down and remove the battery pack (refer to [Replacing the battery pack](#) section in Chapter 5, Power and Power-Up Modes, if required).
5. Loosen the screw(s) securing the memory module cover in place - please note that the screw(s) are attached to the cover in order to prevent them from being lost.
6. Slide your fingernail or a thin object under the cover and lift it off.

Figure 3-14 Removing the memory module cover (R830)

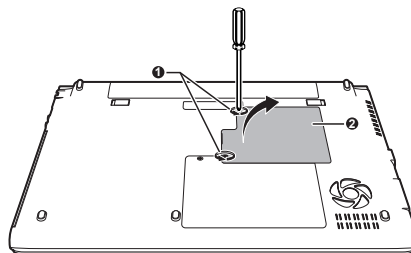

1. Screws

2. Memory module cover

7. Align the notch of the memory module with that of the memory slot and gently insert the module into the slot at about a 30 degree angle before holding it down until the latches on either side snap into place.

Figure 3-15 Seating the memory module (R830)

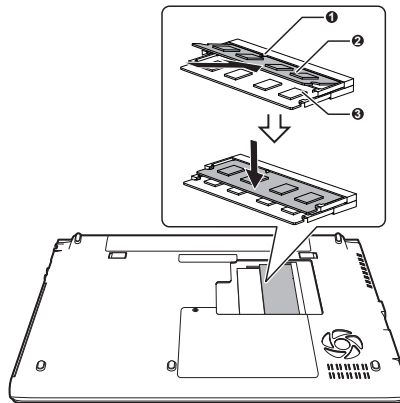

1. Notch
2. Slot B

3. Slot A



- *Never allow metal objects, such as screws, staples and paper clips, to enter the computer. Foreign metal objects can create a short circuit, which can cause computer damage and fire, possibly resulting in serious injury.*
- *Do not touch the connectors on the memory module or on the computer. Debris on the connectors may cause memory access problems.*



- *The slot A is reserved for the first memory module. Use the slot B for expanded memory. If only one module is installed, use the slot A.*
- *Align the grooves along the edges of the memory module with the locking tabs on the connector and insert the module into the connector firmly - if you find it difficult to install the memory module, gently prise the locking tabs outwards using the tip of your finger.*
- *Please also ensure that you hold the memory module along its left and right hand edges - the edges with the grooves in.*

8. Seat the memory module cover in place and secure it with the screw(s).



Take care to ensure that the memory module cover is firmly closed.

Figure 3-16 Seating the memory module cover (R830)

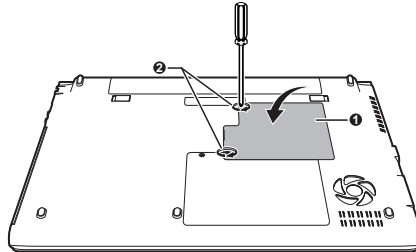

1. Memory module cover

2. Screws

9. Install the battery pack - refer to [Replacing the battery pack](#) section in Chapter 5, Power and Power-Up Modes, if required.
10. Turn your computer over.
11. Turn the computer on and make sure the added memory is recognized - to confirmed it, **Start -> Control Panel -> System and Security -> System** icon.

Removing a memory module

To remove the memory module, follow the steps as detailed below:

1. Shut down the computer - make sure the **Power** indicator is off (refer to the [Turning off the power](#) section in Chapter 1, Getting Started if required).
2. Remove the AC adaptor and all cables and peripherals connected to the computer.
3. Close the display panel.
4. Turn the computer upside down and remove the battery pack.
5. Loosen the screw(s) securing the memory module cover in place - please note that the screws are attached to the cover in order to prevent them from being lost.
6. Slide your fingernail or a thin object under the cover and lift it off.
7. Push the latches away from the module in order to release it - a spring will force one end of the module up at an angle.



8. Grasp the module by its edges and remove it from the computer.

- *If you use the computer for a long time, the memory modules and the circuits locating close to the memory modules will become hot. In this case, let them cool to room temperature before you replace them. Or you will get burnt if you touch any of them.*
- *Do not touch the connectors on the memory module or on the computer. Debris on the connectors may cause memory access problems.*

Figure 3-17 Removing the memory module (R830)

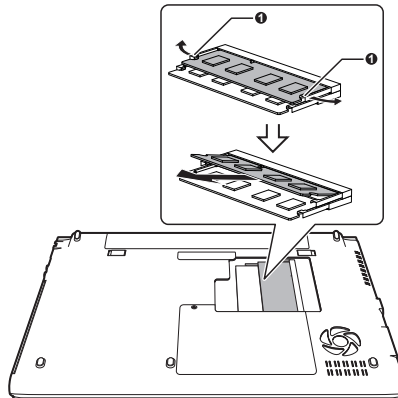

1. Latches

9. Seat the memory module cover in place and secure it with the screw(s).



Take care to ensure that the memory module cover is firmly closed.

10. Install the battery pack.
11. Turn your computer over.

External monitor

An external analog monitor can be connected to the External RGB monitor port on the computer. To connect a monitor, follow the steps as detailed below:

Connecting the monitor cable

1. Connect the monitor cable to the External RGB monitor port.

Figure 3-18 Connecting the monitor cable to the External RGB monitor port (R830)

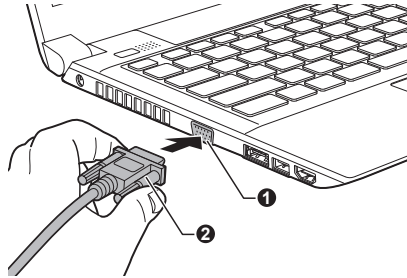

1. External RGB monitor port

2. Monitor cable



There are no fastening screws for an external monitor cable on this computer's External RGB monitor port. However, external monitor cables which have connectors with fastening screws can still be used.

2. Turn the external monitor's power on.

When you turn on the power, the computer will automatically recognize the monitor and determine whether it is a color or monochrome device. In the event that you find that there are issues getting an image displayed on the correct monitor, you should consider using the **FN + F5** hot key to change the display settings (if you then disconnect the external monitor before you turn the computer's power off, be sure to press **FN + F5** hot key again to switch to the internal display).

Please refer to the [The Keyboard](#) section for further details on using hot keys to change the display setting.



Do not disconnect the external monitor while in Sleep or Hibernation Mode. Turn off the computer before disconnecting the external monitor.

When displaying desktop at external analog monitor, desktop is sometimes displayed on the center of the monitor with black bars around desktop (with small size).

At that time, please read the manual of the monitor and set the display mode which is supporting at the monitor. Then it will be displayed with suitable size with correct aspect ratio.

HDMI

Some models are equipped with an HDMI out port.

An HDMI monitor can be connected to the HDMI out port on the computer. To connect monitor, follow the steps as detailed below:



As the port operation of all HDMI (High-Definition Multimedia Interface) monitors have not been confirmed, some HDMI monitors may not function properly.

Connecting the HDMI out port

1. Plug one end of the HDMI cable into the HDMI in port of the HDMI device.
2. Plug the other end of the HDMI cable into the HDMI out port on your computer.

Figure 3-19 Connecting the HDMI out port (R830)

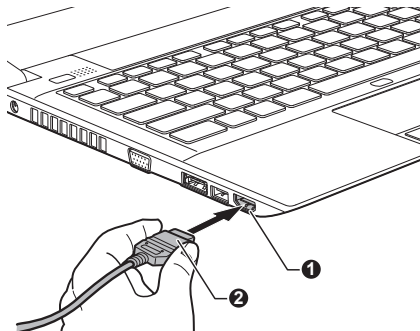

1. HDMI out port

2. HDMI cable



Please connect or disconnect an HDMI device to or from the computer under the following conditions:

- The computer is turned on.
- The computer is completely turned off.

Do not do so when the computer is in Sleep Mode or Hibernation Mode.



- When you connect a television or external monitor to the HDMI port, the display output device is set to HDMI.
- When you unplug the HDMI cable and re-plug it, please wait at least 5 seconds before you re-plug the HDMI cable again.

- *When you change the display output device by hot key like **FN + F5**, the playback device may not switch automatically. In this case, in order to set the playback device to the same device as the display output device, please adjust the playback device manually by the following steps:*
 1. Click **Start -> Control Panel -> Hardware and Sound -> Sound**.
 2. In the **Playback** tab, select the playback device which you want to switch to.
 3. To use the internal speakers on your computer, select **Speakers**. To use the television or the external monitor that you have connected to the computer, select a different playback device.
 4. Click the **Set Default** button.
 5. Click **OK** to close the **Sound** dialog.

Settings for display video on HDMI

To view video on the HDMI device, be sure to configure the following settings otherwise you may find that nothing is displayed.



*Be sure to use the **FN + F5** HotKey to select the display device before starting to play video. Do not change the display device while playing video.*

Do not change the display device under the following conditions.

- *While data is being read or written.*
- *While communication is being carried out.*

Select HD Format

To select the display mode, follow the steps as detailed below:

1. Click **Start** and click **Control Panel**.
2. Click **Appearance and Personalization**.
3. Click **Display**.
4. Click **Change display settings**.
5. Click **Advanced settings**.
6. Click **List All Modes**.
7. Select one of the mode at **List All Modes**.

DisplayPort

Some models are equipped with a DisplayPort. This port enables you to connect an external monitor.

Connecting the DisplayPort

1. Plug one end of the DisplayPort cable into the DisplayPort on your external monitor.
2. Turn on the external monitor.
3. Plug the other end of the DisplayPort cable into the DisplayPort on your computer.



- *As the port operation of all external monitors have not been confirmed, some monitors may not function properly.*
- *When you change the display output device by hot key like **FN + F5**, the playback device may not switch automatically. In this case, in order to set the playback device to the same device as the display output device, please adjust the playback device manually by the following steps:*
 1. *Click **Start -> Control Panel -> Hardware and Sound -> Sound**.*
 2. *In the **Playback** tab, select the playback device which you want to switch to.*
 3. *To use the internal speakers on your computer, select **Speakers**. To use the television or the external monitor that you have connected to the computer, select a different playback device.*
 4. *Click the **Set Default** button.*
 5. *Click **OK** to close the **Sound** dialog.*

eSATA (External Serial ATA) devices

An device corresponding to eSATA function can be connected to the eSATA/USB combo port on the computer.

Connecting the eSATA device

To connect an eSATA device, follow the steps as detailed below:

1. Connect an eSATA cable to the eSATA/USB combo port.



*Make sure the connector is properly aligned with the socket.
Do not try to force the connection, doing so can damage the connecting pins.*

Figure 3-20 Connecting an eSATA cable to the eSATA/USB combo port (R830)

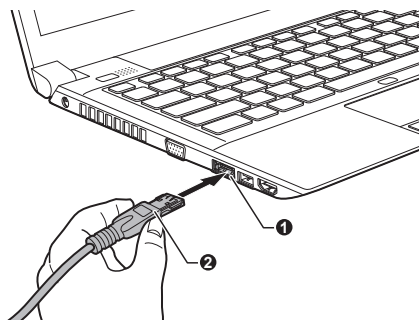

1. eSATA/USB combo port

2. eSATA cable



- A connected eSATA device may not be recognized if it is connected to the computer's eSATA/USB combo port while the computer is in Sleep Mode or Hibernation Mode. If this occurs, disconnect the eSATA device and then reconnect the device while the computer is turned on.
- If you connect an eSATA device after the computer has already been turned on, it will take about ten seconds for it to be recognized by the computer. Do not attempt to disconnect and reconnect the drive before this period has elapsed.

Disconnecting an eSATA device

When you have finished using an eSATA device, you can follow the procedures below in order to disconnect it:

1. Wait for the indicator light of an eSATA device to go out to make sure all activity has stopped.
2. Click the **Safely Remove Hardware and Eject Media** icon on the Windows Taskbar.
3. Click an eSATA device that you want to remove.
4. Carefully pull an eSATA device's eSATA/USB combo connector out from within the computer's eSATA/USB combo port.



If you disconnect an eSATA device or turn off the power while the computer is accessing the drive you may lose data or damage an eSATA device or the drive.

TOSHIBA Hi-Speed Port Replicator II

In addition to the ports available on the computer, the TOSHIBA Hi-Speed Port Replicator II also provides several kinds of ports.

The TOSHIBA Hi-Speed Port Replicator II connects directly to the docking interface on the underside of the computer. The AC adaptor connects the TOSHIBA Hi-Speed Port Replicator II to a power source.



- *You must connect the AC adaptor before you connect to a TOSHIBA Hi-Speed Port Replicator II.*
- *When a TOSHIBA Hi-Speed Port Replicator II is connected to the computer, you can not use the following computer's ports: LAN jack, DC IN 19V jack and External RGB monitor port.*
- *When connecting an AC Adaptor to the TOSHIBA Hi-Speed Port Replicator II, use only the AC Adaptor included with TOSHIBA Hi-Speed Port Replicator II. Do not use the computer's AC Adaptor.*
- *When the replicator is docked, booting from USB 3.0 ports may be not available. To check whether your computer supports booting from USB 3.0, please contact TOSHIBA support for assistance.*
- *Refer to the TOSHIBA Hi-Speed Port Replicator II User's Manual for more details.*

Security lock

A security locks enable you to anchor your computer a desk or other heavy object in order to help prevent unauthorized removal or theft. The computer has a security lock slot on its right side into which you can attach one end of the security cable, while the other end attaches to a desk or similar object. The methods used for attaching security cables differ from product to product. Please refer to the instructions for the product you are using for more information.

Connecting the security lock

In order to connect a security cable to the computer, follow the steps as detailed below:

1. Turn the computer so its right side faces you.
2. Align the security cable with the lock slot and secure it in place.

Figure 3-21 Security lock (R830)

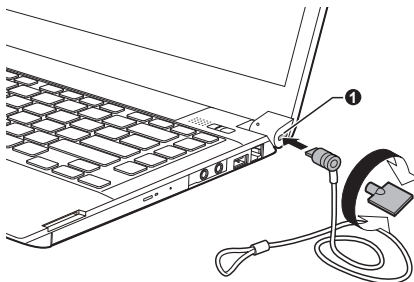

1. Security lock slot

Optional TOSHIBA Accessories

You are able to add a number of options and accessories in order to make your computer even more powerful and convenient to use. For reference, the following list details some of the items that are available from your reseller or TOSHIBA dealer:

Memory Kit	1 GB, 2 GB or 4GB memory modules (DDR3-1333) can easily be installed in the computer. The available option memory depends on TOSHIBA authorization.
Universal AC Adaptor	If you frequently use your computer at more than one site, it may be convenient to purchase an additional AC adaptor to be kept at each site in order to remove the need to always carry the adaptor with you.
Battery Pack	An additional battery pack can be purchased for use as either a spare or replacement. Please refer to Chapter 5, <i>Power and Power-Up Modes</i> for further information.
TOSHIBA Hi-Speed Port Replicator II	The TOSHIBA Hi-Speed Port Replicator II provides several kinds of ports. Please refer to the TOSHIBA Hi-Speed Port Replicator II User's manual for more details.

Sound System

This section describes some of the audio control functions.

Volume Mixer

The Volume Mixer utility lets you control the audio volume for playback of devices and applications under Windows.

- To launch the Volume Mixer utility, right click on the speaker icon on the Taskbar, and select **Open Volume Mixer** from the sub menu.
- To adjust the volume level of speakers or headphones, move the **Speakers** slider.
- To adjust the volume level of an application that you are using, move the slider for the corresponding application.

Microphone Level

Follow the steps below to change the microphone recording level.

1. Right click on the speaker icon on the Taskbar, and select **Recording devices** from the sub menu.

2. Select **Microphone**, and click **Properties**.
3. On the **Levels** tab move the **Microphone** slider to increase or decrease the microphone volume level.

If you feel the microphone volume level is inadequate, move the **Microphone Boost** slider to a higher level.

Audio Enhancements

In order to apply the sound effects for your current speaker, follow the steps below.

1. Right click on the speaker icon on the Taskbar, and select **Playback Devices** from the sub menu.
2. Select **Speakers**, and click **Properties**.
3. On the **Enhancements** tab select the sound effects you would like, and click **Apply**.

Realtek HD Audio Manager

You can confirm and change the audio configuration using the **Realtek Audio Manager**. To launch the **Realtek Audio Manager**, click **Start -> Control Panel**, select **Large icons** from **View by**, then click **Realtek HD Audio Manager**.

When you first launch the Realtek Audio Manager, you will see two device tabs. **Speakers** is the default output device. **Microphone** is the default input device. To change the default device, click the **Set Default Device** button under the chosen device tab.

Information

Click the **information** button  to view hardware information, software information, and language setting.

Power Management

The audio controller in your computer can be turned off when the audio function is not used. To adjust the configuration of audio power management, click the **Power Management** button  .

- When audio power management is enabled, the circle button at the upper left of the Power Management is blue and convex.
- When audio power management is disabled, the button is black and concave.

Speaker Configuration

Click the **Auto Test** button  to confirm the internal speakers or the headphone sound is coming from the right direction.

Default Format

You can change the sample rate and bit depth of sound.

Video mode

Video mode settings are configured via the **Screen Resolution** dialog.

To open the **Screen Resolution** dialog, click **Start -> Control Panel -> Appearance and Personalization -> Display -> Change display settings**.



If you are running some applications (for example a 3D application or video playback and so on), you may see some disturbance, flickering or frame dropping on your screen.

If that occurs, adjust the resolution of display, lowering it until the screen is displayed properly.

Disabling Windows Aero™ may also help correct this issue.

Computer Handling

This section explains computer handling and maintenance.

Cleaning the computer

To help ensure long, trouble-free operation, keep the computer free of dust and dirt, and use care with all liquids around it.

- Be careful not to spill liquids into the computer. If the computer does get wet, turn the power off immediately and let the computer dry completely - in these circumstance you should get the computer inspected by an authorized service provider in order to assess the scope of any damage.
- Clean the plastics of the computer using a slightly water dampened cloth.
- You can clean the display screen by spraying a small amount of glass cleaner onto a soft, clean cloth and then wiping the screen gently with the cloth.



Never spray cleaner directly onto the computer or let liquid run into any part of it. Never use harsh or caustic chemical products to clean the computer.

Moving the computer

While the computer is designed for flexible day-to-day usage you should exercise a few simple precautions when moving it in order to help ensure trouble-free operation.

- Before moving the computer, it is recommended that you change the setting associated with the Hard Disk Drive Protection feature. Please refer to the section, *Heat dispersal*, in this chapter for further information.
- Make sure all disk/disc activity has ended before moving the computer - check that the HDD and other indicators on the front of the computer are off.
- Turn off (shut down) the computer.
- Disconnect the AC adaptor and all peripherals before moving the computer.
- Close the display panel.
- Do not pick up the computer by its display panel.
- Before carrying your computer, shut it down, disconnect the AC adaptor and allow it to cool down - a failure to follow this instruction may result in minor heat injury.
- Be careful not to subject the computer to impact or shock - a failure to follow this instruction could result in damage to computer, computer failure or loss of data.
- Never transport your computer with any cards installed - this may cause damage to either the computer and/or the card resulting in product failure.
- Always use a suitable carry case when transporting the computer.
- When carrying your computer, be sure to hold it securely so that it does not fall or hit anything.
- Do not carry your computer by holding any of its protruding elements.

Heat dispersal

To protect against overheating, the processor is equipped with an internal temperature sensor which activates a cooling fan or lowers the processing speed if the computer's internal temperature rises to a certain level. You are able to select whether to control this temperature by either turning on the fan first, then if necessary lowering the processor speed, or by lowering the processor speed first, then if necessary turning on the fan. Both of these functions are controlled through the Power Options.

When the processor's temperature falls within normal range, the fan will be turned off and the processor operation returned to its standard speed.



If the processor's temperature reaches an unacceptably high level with either setting, the computer automatically shuts down to prevent any damage. In this instance all unsaved data in memory will be lost.

Chapter 4

Utilities & Advanced Usage

This chapter describes the utilities and special features of this computer, and the advanced usage of some utilities.

Utilities and Applications

This section describes the pre-installed utilities that come with the computer and details how to start them. For further information on their operation, you may refer to each utility's online manual, help files or README.TXT file (if applicable).

TOSHIBA Power Saver	TOSHIBA Power Saver provides you with the features of more various power supply managements.
TOSHIBA Button Support	<p>This utility controls the following computer button functions.</p> <ul style="list-style-type: none"> ■ Eco button ■ TOSHIBA Presentation button <p>The starting application from the button can be changed.</p>
TOSHIBA PC Diagnostic Tool	The TOSHIBA PC Diagnostic Tool will display basic system configuration information and allow the functionality of some of the computer's built-in hardware devices to be tested.
TOSHIBA Password Utility	The TOSHIBA Password utility allows you to set a password in order to restrict access to the computer.
TOSHIBA Flash Cards	<p>The TOSHIBA Flash Cards provide a quick way to modify selected system functions.</p> <ul style="list-style-type: none"> ■ Hot key function
HW Setup	This utility allows you to customize your hardware settings according to the way you work with the computer and the peripherals you use.

TOSHIBA Accessibility The TOSHIBA Accessibility utility provides support to movement impaired users when they need to use the TOSHIBA Hot-key functions. In use, the utility allows you to make the **FN** key "sticky", that is you can press it once, release it, and they press one of the **Function** keys in order to access its specific function. When set, the **FN** key will remain active until another key is pressed.

Fingerprint Utility This product has a fingerprint utility installed for the purpose of enrolling and recognizing fingerprints which can then be linked to a username and password in order to remove the need to input these details from the keyboard. Just by swiping an enrolled finger against the fingerprint sensor, the following functions will be enabled:

- Logon to Windows and access a security enabled homepage through Internet Explorer.
- Files and folders can be encrypted/decrypted and third party access to them is prevented.
- Unlock the password-protected screen-saver.
- Authentication of the User Password (and, if applicable, the HDD (Hard Disk Drive) Password) when booting up the computer (Power-on Security).
- Single Sign-on feature

Fingerprint security cannot be used in models that do not have a fingerprint module installed.

TOSHIBA Face Recognition TOSHIBA Face Recognition uses a face verification library to verify the face data of users when they log in to Windows. If the verification is successful, the user will be logged into Windows automatically. The user can thus avoid having to enter a password or the like, which makes the login process easier.

For more information, please refer to the [Using the TOSHIBA Face Recognition](#) section.

TOSHIBA VIDEO PLAYER	<p>This software is provided for playback of Video. It has an on-screen interface and functions. Click Start -> All Programs -> TOSHIBA VIDEO PLAYER -> TOSHIBA VIDEO PLAYER.</p> <p>For details on how to use TOSHIBA VIDEO PLAYER, see the help file.</p>
Bluetooth Stack for Windows by Toshiba	<p>This software enables communication between the computer and external Bluetooth devices such as printers and mobile phones.</p> <p>Bluetooth functions cannot be used in models that do not have a Bluetooth module installed.</p>
TOSHIBA Assist	<p>TOSHIBA Assist is a graphical user interface that provides access to specific tools, utilities and applications that make the use and configuration of the computer easier.</p> <p>To access this utility, click Start -> All Programs -> TOSHIBA -> Utilities -> TOSHIBA Assist.</p>
TOSHIBA ConfigFree	<p>TOSHIBA ConfigFree is a suite of utilities that improve the ease and control of communication devices and network connections, help in the identification of communication problems and allow the creation of profiles if you need to switch between different locations and communication networks.</p> <p>To access this utility, click Start -> All Programs -> TOSHIBA -> ConfigFree.</p>
TOSHIBA eco Utility	<p>This computer is equipped with "eco mode". This mode slightly lowers performance of some devices to reduce electric power consumption. You can realize measurable power savings by using it continuously. TOSHIBA eco Utility helps you monitor your power savings by showing approximate real time power consumption. Furthermore, it shows approximate accumulated power consumption and approximate accumulated power savings when using eco mode daily, weekly, and monthly. You can track power savings by using eco mode continuously.</p> <p>To access this utility, click Start -> All Programs -> TOSHIBA -> Utilities -> eco Utility.</p>

TOSHIBA Disc Creator	<p>You can create discs in a number of formats including audio discs that can be played on a standard disc player, and data discs which can store copies of the files and folders on your computer's hard disk drive. This software can be used on models with an optical disc drive.</p> <p>To start this utility, click Start -> All Programs -> TOSHIBA -> CD&DVD Applications -> Disc Creator.</p>
TOSHIBA DVD-RAM Utility	<p>This utility has the function of Physical Format and Write-Protect to DVD-RAM. This utility is contained the setup module of TOSHIBA Disc Creator. To start this utility, click Start -> All Programs -> TOSHIBA -> CD&DVD Applications -> DVD-RAM Utility.</p>
TOSHIBA HDD/SSD Alert Utility	<p>This utility includes wizard functions to monitor the Disk Drive operating status and execute the system backup.</p> <p>To access the utility, click Start -> All Programs -> TOSHIBA -> Utilities -> HDD SSD Alert.</p>
WinDVD BD for TOSHIBA	<p>This software is provided for playback of Blu-ray Disc™. It has an on-screen interface and functions.</p> <p>To start this utility, click Start -> All Programs -> Corel -> Corel WinDVD BD.</p>
Corel Digital Studio for TOSHIBA	<p>Corel Digital Studio for TOSHIBA allows users to instantly create Blu-ray Disc™ movie, DVD video or slideshow discs via a user-friendly wizard interface with specific task oriented features.</p> <p>The Labelflash feature also allows texts and images to be printed on the label surface of Labelflash compatible media without using a printer.</p> <p>This feature of Corel Digital Studio for TOSHIBA is only available in some models.</p>

TOSHIBA Service Station	<p>This application allows your computer to automatically search for TOSHIBA software updates or other alerts from TOSHIBA that are specific to your computer system and its programs. When enabled, this application periodically transmits to our servers a limited amount of system information, which will be treated in strict accordance with the rules and regulations as well as applicable data protection law.</p> <p>To access this utility, click Start -> All Programs -> TOSHIBA -> Utilities -> Service Station.</p>
TOSHIBA Sleep Utility	<p>This utility is able to either enable or disable the Sleep and Charge function.</p> <p>Shows the positions of USB ports that support the USB Sleep and Charge function and displays the battery's remaining capacity.</p> <p>To access this utility, click Start -> All Programs -> TOSHIBA -> Utilities -> Sleep Utility.</p>
TOSHIBA Bulletin Board	<p>Bulletin Board is a convenient place to pin things to visually organize in a fun and creative way.</p> <p>Simply drag and drop your favorite pictures, files or notes to pin them on the Board. You can use it to create thumbnail shortcuts, reminders, to-do list and so on according to your personal style.</p> <p>To access this utility, click Start -> All Programs -> TOSHIBA -> TOSHIBA Bulletin Board.</p>
TOSHIBA ReelTime	<p>This application is a graphical history/indexing tool that enables you to view recently accessed files in a fun and easy-to-use format. View and scroll through your history of opened or imported files via thumbnails in an intuitive user interface.</p> <p>To access this utility, click Start -> All Programs -> TOSHIBA -> TOSHIBA ReelTime.</p>
TOSHIBA Wireless LAN Indicator	<p>TOSHIBA Wireless LAN Indicator utility displays the system's Wireless LAN connection status on the logon screen.</p> <p>You can quickly check the current Wireless LAN connection status before logging into Windows.</p> <p>To change the settings of this utility, click Start -> All Programs -> TOSHIBA -> Networking -> Wireless LAN Indicator - Settings.</p>

TOSHIBA Media Controller	<p>This application allows you to control your music, pictures and videos by streaming content to any compatible device in your home.</p> <p>To access this utility, click Start -> All Programs -> TOSHIBA -> TOSHIBA Media Controller -> TOSHIBA Media Controller.</p> <p>For more information, please refer to the TOSHIBA Media Controller Help.</p>
TOSHIBA Resolution+ Plug-in for Windows Media Player	<p>The plug-in lets you upconverts wmv and mp4 videos on Windows Media Player.</p> <p>For more information, please refer to the TOSHIBA Resolution+ Plug-in for Windows Media Player Help.</p> <p>To access it, click Start -> All Programs -> TOSHIBA -> TOSHIBA Resolution+ Plug-in for Windows Media Player -> TOSHIBA Resolution+ Plug-in for Windows Media Player - Help.</p>
Trusted Platform Module (TPM)	<p>The TPM (Trusted Platform Module) is a security encryption device for the hard disk drive.</p> <p>BIOS setup and Infineon TPM Software Professional Package must be installed and configured in order to use TPM.</p>



To enable TPM through the BIOS setup:

1. Turn on the computer while pressing the **F2** key. When the **TOSHIBA Leading Innovation >>>** screen appears, release the **F2** key.
2. Set the **TPM** in the **Security** tab to **Enabled**.
3. Press the **F10** key.
4. Press the **Y** key to accept the changes. The computer will restart.

*In order to change the TPM setting when the **Hide TPM** setting is currently set to Yes, switch the Hide TPM setting from **Yes** to **No**.*

Special features

The following features are either unique to TOSHIBA computers or are advanced features which make the computer more convenient to use.

Access each function using the following procedures.

*1 To access the Power Options, click **Start -> Control Panel -> System and Security -> Power Options**.

eco button	Press this button to launch the TOSHIBA eco Utility. This button changes On and Off of eco Mode. When eco Mode is On , the icon turns green. When eco Mode is Off , the icon turns gray.
TOSHIBA Presentation button	The TOSHIBA Presentation button has the same functionality as the Connect display button in the Mobility Center.
Hot keys	Hot keys are specific key combinations that let you quickly change the system configuration directly from the keyboard without running a system program.
Display automatic power off ^{*1}	This feature automatically cuts off power to the computer's display panel when there is no keyboard input for a specified time, with power being restored the next time a key is pressed. This can be specified in the Power Options.
HDD automatic power off ^{*1}	This feature automatically cuts off power to the hard disk drive when it is not accessed for a specified time, with power being restored when the hard disk drive is next accessed. This can be specified in the Power Options.
System automatic Sleep/Hibernation Mode ^{*1}	This feature automatically shuts down the system into either Sleep Mode or Hibernation Mode when there is no input or hardware access for a specified time. This can be specified in the Power Options.
Keypad overlay	A ten-key numeric keypad is integrated into the keyboard. Please refer to the Keypad overlay section in Chapter 3, Operating Basics, for information on using this feature.
Power on password	Two levels of password security, supervisor and user, are available to prevent unauthorized access to your computer.
Instant security	A specific hot key function automatically locks the system providing data security.
Intelligent power supply ^{*1}	A microprocessor in the computer's intelligent power supply detects the battery's charge, automatically calculates the remaining battery capacity and protects electronic components from abnormal conditions such as a voltage overload from the AC adaptor. This can be specified in the Power Options.

Battery save mode *1	This feature lets you configure the computer in order to save battery power. This can be specified in the Power Options.
Panel power on/off *1	This feature automatically turns power to the computer off when the display panel is closed, and turns it back on when the display panel is opened. This can be specified in the Power Options.
Low battery automatic Hibernation Mode *1	When battery power is exhausted to the point that computer operation cannot be continued, the system automatically enters Hibernation Mode and shuts itself down. This can be specified in the Power Options.
Heat dispersal *1	To protect against overheating, the processor has an internal temperature sensor so that, if the computer's internal temperature rises to a certain level, the cooling fan is turned on or the processing speed is lowered. This can be specified in the Power Options.
TOSHIBA HDD Protection	This feature uses the acceleration sensor built in the computer to detect vibration and shocks, and automatically moves the hard disk drive's read/write head to a safe position in order to reduce the risk of damage that could be caused by head-to-disk contact. Refer to the Using the Hard Disk Drive (HDD) Protection section for more details.
Hibernation Mode	This feature lets you turn off the power to the computer without exiting from your software. The contents of main memory are automatically saved to the hard disk drive so that when you next turn the power on again, you can continue working right where you left off. Refer to the Turning off the power section in Chapter 1, Getting Started, for more details.
Sleep Mode	If you have to interrupt your work, you can use this feature to allow you to turn off power to the computer without exiting from your software. Data is maintained in the computer's main memory so that when you next turn on the power, you can continue working right where you left off.

USB Wakeup function	<p>This function restores the computer from Sleep Mode depending on the external devices connected to the USB ports.</p> <p>For example, if a mouse or USB keyboard is connected to a USB port, clicking the mouse button or pressing the keyboard will wakeup the computer.</p>
Sleep and Charge function	<p>This feature allows you to charge USB-compatible external devices such as mobile phones or portable digital music players via the USB port when your computer is in Sleep Mode, Hibernation Mode or in the shutdown state.</p> <p>This function is worked by the TOSHIBA Sleep Utility.</p>
TOSHIBA PC Health Monitor	<p>The TOSHIBA PC Health Monitor application proactively monitors a number of system functions such as power consumption, battery health and system cooling, informing you of significant system conditions. This application recognizes the system and individual component serial numbers and will track specific activities related to their usage.</p>

Using the TOSHIBA Sleep Utility

This utility displays whether the Sleep and Charge function is enabled or disabled and shows the positions of USB ports that support the Sleep and Charge function. It also displays the remaining battery capacity.

Sleep and Charge

Your computer can supply USB bus power (DC5V) to the USB port even when the power of the computer is turned OFF. "Power OFF" includes Sleep Mode, Hibernation Mode or shutdown state.

This function can be used for ports that support the Sleep and Charge function (hereinafter called "compatible ports").

Compatible ports are USB ports that have the (⚡) symbol icon.

You can use the Sleep and Charge function to charge certain USB-compatible external devices such as mobile phones or portable digital music players.

However, the Sleep and Charge function may not work with certain external devices even if they are compliant with the USB specification. In those cases, turn the power of the computer ON to charge the device.



- *When Sleep and Charge function is enabled, USB bus power (DC5V) will be supplied to compatible ports even when the power of the computer is turned OFF. USB bus power (DC5V) is similarly supplied to the external devices which are connected to the compatible ports. However, some external devices cannot be charged solely by supplying USB bus power (DC5V). As for the specifications of the external devices, please contact the device manufacturer or check the specifications of the external devices thoroughly before use.*
- *Using the sleep and charge function to charge external devices will take longer than charging the devices with their own chargers.*
- *If Sleep and Charge function is enabled, the computer's battery will discharge during hibernation or when the computer is turned off. It is recommended that you connect the AC adaptor to the computer when enabling the Sleep and Charge function.*
- *External devices connected to the USB bus power (DC5V) function that interfaces with the power ON/OFF of the computer may always be in an operational state.*
- *When there is a current overflow of the external devices connected to the compatible ports, USB bus power (DC5V) supply may be stopped for safety reasons.*
- *When Sleep and Charge function is enabled, the USB Wakeup function does not work for compatible ports. In that case, if there is a USB port that does not have the Sleep and Charge function-compatible icon (+), attach the mouse or keyboard to it. If all USB ports have the Sleep and Charge function-compatible icon (+), change to disable Sleep and Charge function. The USB Wakeup function will now work, but the Sleep and Charge function will be disabled.*



Metal paper clips or hair pins/clips will generate heat if they come into contact with USB ports. Do not allow USB ports to come into contact with metal products, for example when carrying the computer in your bag.

Starting the TOSHIBA Sleep Utility

To start the utility, click **Start -> All Programs -> TOSHIBA -> Utilities -> Sleep Utility**.

Enabling Sleep and Charge

This utility can be used to enable and disable the Sleep and Charge function.

Select the **Enable Sleep and Charge** check box to enable this function for the compatible USB ports. The default state is disabled.

Power supply mode settings

Your PC has multiple charging modes so that many different USB devices can be supported for Sleep and Charge function. **Auto Mode** (Default) is suitable for a wide range of digital audio players.

However, determining which mode is suitable for your USB device is unknown without trying. Try each mode, using the following procedure, from **Auto Mode** to **Alternate Mode** to find the suitable mode for your USB device to charge.

This function may not be able to be used with some connected external devices even if the appropriate mode is selected. In this situation, clear the "Enable Sleep and Charge" check box and stop using this function.

Battery Settings

This utility can be used to specify the lower limit of remaining battery life for Sleep and Charge. Move the slider bar to specify the lower limit. If the remaining battery life falls below the setting, the Sleep and Charge function will be stopped.

Using the TOSHIBA Face Recognition

TOSHIBA Face Recognition uses a face verification library to verify the face data of users when they log in to Windows. The user can thus avoid having to enter a password or the like, which makes the login process easier.



- *TOSHIBA Face Recognition does not guarantee the correct identification of a user. Changes to the likeness of a registrant, such as hair style changes, wearing a cap, or wearing glasses may effect the recognition rates when such changes occur after the registrant had registered.*
- *TOSHIBA Face Recognition may incorrectly recognize faces that are similar to a registrant.*
- *For high security purposes, TOSHIBA Face Recognition is not a suitable substitute for Windows passwords. When security is a high priority, use your established Windows passwords to log in.*
- *Bright background light and/or shadows may prevent a registrant from being recognized correctly. In that case, log in using your Windows password. If recognition of a registrant fails repeatedly, refer to your computer documentation to learn ways to improve recognition performance.*
- *TOSHIBA Face Recognition records face data in a log when face recognition fails. When transferring ownership or disposing of your computer, please uninstall the application or delete all the logs created by the application. For details on how to do this, see help file.*

- *TOSHIBA Face Recognition can be used only in Windows Vista and Windows 7.*

Disclaimer

TOSHIBA does not guarantee that the face recognition utility technology will be completely secure or error-free. TOSHIBA does not guarantee that the face recognition utility will accurately screen out unauthorized users at all times. TOSHIBA is not liable for any failure or damage that might arise out of the use of the face recognition software or utility.

TOSHIBA, ITS AFFILIATES AND SUPPLIERS SHALL HAVE NO RESPONSIBILITY FOR DAMAGE TO OR LOSS OF ANY BUSINESS, PROFITS, PROGRAMS, DATA, NETWORK SYSTEMS OR REMOVABLE STORAGE MEDIA ARISING OUT OF OR RESULTING FROM THE USE OF THE PRODUCT, EVEN IF ADVISED OF THE POSSIBILITY THEREOF.

How to register the Face Recognition Data

Take a picture for facial verification purposes, and register the data needed when you log in. To register the data needed when you log in, follow the steps as described below:

1. To launch this utility, click **Start -> All Programs -> TOSHIBA -> Utilities -> Face Recognition**.

The **Registration** screen is displayed for a logged-in user whose face has not been registered.

The **Management** screen is displayed for a logged-in user whose face has already been registered.

2. Click **Run as administrator** in lower left of the **Management** screen, and then click the **Register** button. The **Registration** screen is displayed.

If you wish to practice, click on the **Next** button in the **Registration** screen.

If you do not wish to practice, click on the **Skip** button in the **Registration** screen.

3. Click the **Next** button to start the guide. Please follow the guide to practice

Click the **Back** button to practice the guide once more.

4. Click the **Next** button to start image-capturing process.

Adjust the position of your face so that it fits within the face-shaped frame.

5. Once your face has been positioned properly, the recording will commence.
Start moving your neck very slightly to the left and right, and then move your neck up and down.
6. Registration will end after you have repeatedly moved your neck left, right, up and down.
When the register succeeds, below message will be displayed on the screen:
"Registration successful. Now we'll do the verification test. Click the Next button."
Click the **Next** button to perform the verification test.
7. Perform the verification test. Face the screen as you do when you register.
If verification fails, click the **Back** button and re-register. Please refer to step 6 from step 4.
8. If verification is successful, click the **Next** button and register an account.
9. Register the account. Fill in all the fields.
10. The **Management** screen is displayed. The registered account name will be displayed. Clicking on it will cause the captured image of your face to be displayed on the left.

How to Delete the Face Recognition Data

Delete image data, account information, and personal record data created during registration. To delete the Face Recognition Data, follow the steps as described below:

1. To launch this utility, click **Start -> All Programs -> TOSHIBA -> Utilities -> Face Recognition**. The **Management** screen is displayed.
2. Select a user which is displayed in the **Management** screen.
3. Click the **Delete** button. "You are about to delete the user data. Would you like to continue?" will be displayed on the screen.
 - If you do not want the data to be deleted, click the **No** button and you will then be returned to the **Management** screen.
 - Clicking on the **Yes** button will remove the selected user from the **Management** screen.

How to launch the help file

For further information on this utility, please refer to help file.

1. To launch the help file, click **Start -> All Programs -> TOSHIBA -> Utilities -> Face Recognition Help**.

Windows Logon via TOSHIBA Face Recognition

This section explains how to login to Windows with TOSHIBA Face Recognition. Two authentication modes are provided.

- **1:N Mode Login screen:** If the face authentication tile is selected by default, you can log in without using the keyboard or mouse.
- **1:1 Mode Login screen:** This mode is essentially the same as AUTO mode, but the **Select Account** screen will appear before the **Display Captured Image** screen, and you will need to select the user account to be authenticated in order to start the authentication process.

1:N Mode Login screen

1. Turn on the computer.
2. The **Select Tiles** screen will be displayed.
3. Select **Start face recognition** (F7).
4. "Please face the camera" will be displayed.
5. Verification will be performed. If the authentication is successful, the image data taken in step 4 will be faded in and placed over one another.

If an error occurs during authentication, you will be returned to the **Select Tiles** screen.

6. The Windows **Welcome** screen will be displayed, and will be logged in automatically to Windows.

1:1 Mode Login screen

1. Turn on the computer.
2. The **Select Tiles** screen will be displayed.
3. Select **Start face recognition** (F7).
4. The **Select Account** screen will be displayed.
5. Select the account, and click the **arrow** button.
6. "Please face the camera" will be displayed.
7. Verification will be performed. If the authentication is successful, the image data taken in step 6 will be faded in and placed over one another.

If an error occurs during authentication, you will be returned to the **Select Tiles** screen.

8. The Windows **Welcome** screen will be displayed, and will be logged in automatically to Windows.

If authentication was successful, but an authentication error subsequently occurred during the login to Windows, you will be asked to provide your account information.

TOSHIBA Password Utility

The TOSHIBA Password Utility provides two levels of password security: User and Supervisor.



Passwords set by the TOSHIBA Password Utility function are different from the Windows password.

User Password

To start the utility, point to or click the following items:

Start -> All Programs -> TOSHIBA -> Utilities -> Password Utility

User authentication may be required to validate user rights when using TOSHIBA Password Utility to delete or change passwords, etc.

User Password field

■ **Set** (button)

Click this button to register a password of up to 50 characters. After a password is set, you will be prompted to enter it when you start the computer. Check "Set the same string simultaneously as the HDD User Password" when setting the HDD User Password.



- *After you set the password, a dialog box will be displayed asking whether you want to save it to a floppy diskette or other media. If you forget the password, you can open the password file on another computer. Be sure to keep the media in a safe place.*
- *When entering the character string to register the password, enter from the keyboard character by character and do not enter as ASCII code or copy-and-paste the character string. In addition, ensure that the registered password is correct by outputting the character string to the password file.*
- *When entering a password, do not enter any characters (for example "!" or "#") produced by pressing the **SHIFT** or **ALT** keys and so on.*

■ **Delete** (button)

Click this button to delete a registered password. Before you can delete a password, you must first enter the current password correctly. Please use BIOS Setup to change or delete the HDD Passwords or to set the HDD Master Password.



To start BIOS Setup;

- 1. Turn on the computer.*
- 2. Press the **F2** key when the **TOSHIBA Leading Innovation >>>** screen appears.*

To end the BIOS Setup;

- 1. Press **F10**, and then press **Y** to accept the changes. The computer will restart.*

- **Change** (button)

Click this button to change a registered password. Before you can change a password, you must first enter the current password correctly. Please use BIOS Setup to change or delete the HDD Passwords or to set the HDD Master Password.

- **Owner String** (text box)

You can use this box to associate text with the password. After you enter text, click **Apply** or **OK**. When the computer is started, this text will be displayed together with the prompt asking you to enter a password.



- *If you forget your HDD User Password, TOSHIBA will NOT be able to assist you, and your HDD will be rendered COMPLETELY and PERMANENTLY INOPERABLE. TOSHIBA will NOT be held responsible for any loss of any data, any loss of use or access to your HDD, or for any other losses to you or any other person or organization that result from the loss of access to your HDD. If you can't accept this risk, don't register the HDD User Password.*

- *When saving the HDD User Password shut down or restart the computer. If the computer is not shut down or restarted, the saved data may not be correctly reflected. For more information on shutting down or restarting the computer, refer to [Turning on the power](#) in Chapter 1.*

Supervisor Password

If you set a Supervisor Password, some functions might be restricted when a user logs on with the User Password. To set a Supervisor Password, execute the file TOSPU.EXE. The file is located at:

C:\Program Files\Toshiba>PasswordUtility\TOSPU.exe

This utility lets you do the following:

- Set, delete or change the Supervisor Password.
- Specify restrictions for general users.

Starting the computer by password

If you have already registered a password, there are several ways to start the computer:

- Swipe your fingerprint on the sensor if you have already registered the fingerprint with the Fingerprint utility and enabled Fingerprint System Boot Authentication. If you would not like to swipe your finger or cannot authenticate the fingerprint for some reasons, push the **BACK SPACE** key to skip the fingerprint authentication screen.
- Enter the password manually.



The password is necessary only if the computer was turned off in Shut Down Mode or Hibernation Mode.

It is not needed in Sleep Mode and Restart.

To enter a password manually, follow the steps as detailed below:

1. Turn on the power as described in Chapter 1, [Getting Started](#). The following message will appear in the screen:

Password=

2. Enter the Password.
3. Press **ENTER**.



If you enter the password incorrectly three times in a row, the computer shuts off. In this case, you must turn the computer back on to retry password entry.

HW Setup

This section explains how to use the TOSHIBA HW Setup program to configure your computer, and provides information on settings for various functions.

Accessing HW Setup

To run the HW Setup program, click **Start -> All Programs -> TOSHIBA -> Utilities -> HWSetup**.

HW Setup window

The HW Setup window contains a number of tabs (General, Display, CPU, Boot Setting, Keyboard, LAN, SATA, USB and Advanced) to allow specific functions of the computer to be configured.

In addition there are also three buttons : OK, Cancel and Apply.

OK	Accepts your changes and closes the HW Setup window.
Cancel	Closes the window without accepting your changes.
Apply	Accepts all your changes without closing the HW Setup window.

General

This window displays the BIOS/EC version and contains two buttons : **Default** and **About**.

Default	Return all HW Setup values to the factory settings.
About	Display the HW Setup version.

Setup

This field displays the installed **BIOS version**, **EC version** and **date**.

Display

This tab lets you customize your computer's display settings for either the internal display or an external monitor.

Power On Display

This tab allows you to select the display to be used when the computer is started. Please note that this setting is only available on standard VGA mode and is not available as part of the Windows Desktop properties.



The Power On Display is supported with some models.

Auto-Selected	Selects an external monitor if one is connected, otherwise, it selects the internal display. (Default)
System LCD Only	Selects the internal LCD, even if an external monitor is connected.

CPU

This function allows you to set the processor's operating mode.

Dynamic CPU Frequency Mode

This option allows you to configure the power saving modes associated with the processor - the following settings are available:

Dynamically Switchable	The processor's power consumption and automatic clock speed switching functions are enabled - in use the processor's operation is automatically switched when necessary (default).
Always High	The processor's power consumption and automatic clock speed switching functions are disabled - in use the processor will always run at its highest level of power consumption and its highest speed.

Always Low

The processor's power consumption and automatic clock speed switching functions are disabled - in use the processor will always run at a lower level of power consumption and a low speed.

Boot Setting

This function allows you to modify the boot settings.

Boot Priority Options

This tab allows you to set the priority for booting the computer. The Boot Priority Options setting window will be displayed. Click the up and down arrow buttons to adjust the priority.

You can override the settings and manually select a boot device by pressing one of the following keys while the computer is booting:

U	Selects the USB floppy diskette drive* ¹
N	Selects the network.
1	Selects the built-in hard disk drive.
C	Selects the CD-ROM* ² .
M	Selects the USB memory drive.
E	Selects the eSATA HDD.

*¹ The floppy diskette drive will be used to start the computer when there is a bootable disk contained in the external drive.

*² The optical disc drive will be used to start the computer when there is a bootable disk contained in the drive.

To change the boot drive, follow the steps below.

1. Hold down **F12** and boot the computer. when the **TOSHIBA Leading Innovation >>>** screen appears, release the **F12** key.
2. Use the up and down cursor keys to select the boot device you want and press **ENTER**.



If a Supervisor Password has been set, manual boot device selection functions may be restricted.

The boot device selection methods described above will not change the boot priority settings that have been configured in HW Setup. In addition, if you press a key other than one of those listed, or if the selected device is not installed, the system will continue to boot according to the current and available settings in HW Setup.

USB Memory BIOS Support Type

This option allows you to set the type of the USB memory to be used as a startup device.

HDD	Sets the USB memory to be the equivalent of a hard disk drive (default). With this setting, the USB memory device can be used to start the computer as though it were a hard disk drive based on the hard disk drive settings within both the Boot Priority and HDD Priority options detailed previously.
FDD	Sets the USB memory to be the equivalent of a floppy diskette drive. With this setting, the USB memory device can be used to start the computer as though it were a floppy diskette based on the floppy diskette drive settings within the Boot Priority option detailed previously.

Panel Open - Power On

This feature allows you to change the **Panel Open - Power On** setting.

Enabled	Enables the Panel Open - Power On function. When you open the display panel while your computer is turned off, the system will boot up automatically.
Disabled	Disables the Panel Open - Power On function (Default).

Keyboard

Wake-up on Keyboard

When this feature is enabled, and the computer is in Sleep Mode, you can turn on the system by pressing any key. However, please be aware that this option will only work with the internal keyboard and only when the computer is in Sleep Mode.

Enabled	Enables the Wake-up on Keyboard function.
Disabled	Disables the Wake-up on Keyboard function. (Default)

LAN

Wake-up on LAN

This feature lets the computer's power be turned on from shutdown when it receives a wake-up packet (Magic packet) from the LAN.



Do not install or remove a memory module while Wake-up on LAN is enabled.



- *The Wake-up on LAN function consumes power even when the system is off. Leave the AC adaptor connected while using this feature.*
- *Regarding Wake-up on LAN from sleep or hibernation, you must check the "Allow the device to wake the computer" check box within the LAN Device properties. (This feature does not effect the Wake-up on LAN from sleep or hibernation.)*

Power will be automatically turned on when a signal is received from an administrator's computer which is connected via a network.

The following settings can be changed when the Built-in LAN is **Enabled**.

Connect the AC adaptor when using the Wake-up on LAN function. The battery retention time will be shorter than the times listed in this manual when this function is enabled. Refer to the [Batteries exhausted time](#) section in chapter 5, Power and Power-Up Modes.

Enabled	Enables Wake-up on LAN from shutdown.
Disabled	Disables Wake-up on LAN from shutdown. (Default)

Built-in LAN

This feature enables or disables the Built-in LAN.

Enabled	Enables Built-in LAN functions. (Default)
Disabled	Disables Built-in LAN functions.

USB

Legacy USB Support

Use this option to enable or disable USB Legacy Emulation. If your operating system does not support USB, you can still use a USB mouse and keyboard by setting the Legacy USB Support item to enabled.

Enabled	Enables the USB Legacy Emulation. (Default)
Disabled	Disabled Disables the USB Legacy Emulation.

SATA

This feature allows you to set conditions for SATA.

eSATA

This feature allows you to enable/disable the eSATA port.

Enabled	Enables the eSATA port (Default).
Disabled	Disables the eSATA port in order to save power.

SATA Interface setting

This feature allows you to set SATA interface setting.

Performance	Let HDD work with maximum performance. (Default)
Battery life	Let HDD work with battery life mode. If this setting is selected, this caused performance down.

Advanced

This tab allows you to set the conditions for each device or function.

You can enable or disable the device or function you selected for power management. Disabled mode consumes less power.



If you disable a device or function, you must re-enable it before you can use it again.

TOSHIBA PC Health Monitor

The TOSHIBA PC Health Monitor application proactively monitors a number of system functions such as power consumption, battery health and the system cooling, informing you of significant system conditions. This application recognizes the system and individual component serial numbers, and will track specific activities related to the computer and their usage.

The collected information includes device operation time and number of actuations or status changes (i.e.: number of power button and **FN** key combination uses, AC adaptor, battery, LCD, fan, HDD, sound volume, wireless communication switch, TOSHIBA Express Port Replicator and USB information), date of initial system use, and also computer and device usage (i.e.: power settings, battery temperature and recharging, CPU, memory, backlight illumination time, and temperatures for various devices). The stored data uses a very small portion of the total hard disk capacity, approximately 10MB or less per year.

This information is used to identify and provide a notification of system conditions which may effect the performance of your TOSHIBA computer. It may also be used to help diagnose problems should the computer require service by TOSHIBA or TOSHIBA's authorized service providers. Additionally, TOSHIBA may also use this information for quality assurance analysis.

Subject to the use restrictions above, the HDD data logged may be transferred to entities located outside of your country or region of residence

(e.g., European Union). Those countries may or may not have the same data protection laws or data protection levels as required by your home country or region.

Once enabled, you may disable the TOSHIBA PC Health Monitor at any time by uninstalling the software via **Uninstall a program** in the **Control Panel**. Doing so will automatically delete all collected information from the HDD.

The TOSHIBA PC Health Monitor software does not extend or modify TOSHIBA's obligations under its standard limited warranty in any way. TOSHIBA's standard limited warranty terms and limitations apply.

Starting the TOSHIBA PC Health Monitor

The TOSHIBA PC Health Monitor can be started using the following methods:

- Click **Start -> All Programs -> TOSHIBA -> Utilities -> PC Health Monitor**.
- Click the icon () in the notification area, then click the "Enable PC Health Monitor..." message the first time you run the application and "Run PC Health Monitor..." every time thereafter.

No matter which method is used, the TOSHIBA PC Health Monitor explanation screen will be displayed.

Clicking **Next** will display the "PC Health Monitor Software Notice & Acceptance" screen. Please carefully read the information displayed. Selecting **ACCEPT** and clicking **OK** will enable the program. By enabling the TOSHIBA PC Health Monitor software, you agree with these terms and conditions and to the use and sharing of the collected information. Once the program is enabled, the TOSHIBA PC Health Monitor screen is displayed, and the program will begin monitoring system functions and collecting information.

If a TOSHIBA PC Health Monitor message is displayed.

A message will be displayed if any changes which may interfere with the operation of the program are detected. Follow the instructions displayed on screen in the message.

Using the Hard Disk Drive (HDD) Protection

This computer has a function for reducing the risk of damage on the hard disk drive.

Using an acceleration sensor built into the computer, TOSHIBA HDD Protection detects vibration shocks and similar signs of movement of the computer, and automatically moves the Hard Disk Drive head to a safe position to reduce the risk of damage that could be caused by head-to-disk contact.



- *The TOSHIBA HDD Protection function does not guarantee that the hard disk drive will not be damaged.*
- *During audio/video playback, when the computer detects a shock or vibration and the hard disk drive's head is parked, the playback might be temporarily interrupted.*
- *TOSHIBA HDD Protection cannot be used in models that are equipped with SSD.*

When vibration is detected, a message will be displayed on the screen, and the icon in the Taskbar notification area will change to the protection state. This message is displayed until the **OK** button is pressed or 30 seconds pass. When vibration subsides, the icon returns to the normal state.

Taskbar icon



Normal TOSHIBA HDD Protection is enabled.



Protection TOSHIBA HDD Protection is active. The hard disk drive head is in a safe position.



OFF TOSHIBA HDD Protection is disabled.

TOSHIBA HDD Protection Properties

You can change the TOSHIBA HDD Protection settings by using the TOSHIBA HDD Protection Properties window. To open the window, click **Start -> All Programs -> TOSHIBA -> Utilities -> HDD Protection Settings**. The window can also be started from the icon on the Taskbar or from the **Control Panel**.

HDD Protection

You can choose whether to enable or disable TOSHIBA HDD Protection.

Detection Level

This function can be set to four levels. The sensitivity levels in which vibrations, impacts and their similar signs are detected can be set to OFF, 1, 2 and 3 in ascending order. Level 3 is recommended for better protection of the computer. However, when the computer is used in a mobile environment or in other unstable conditions, setting the detection level to 3 could result in frequent execution of TOSHIBA HDD Protection, which will slow Hard Disk Drive reading and writing. Set a lower detection level when the speed of Hard Disk Drive reading and writing is a priority.

Different detection levels can be set depending on whether the computer is used as handheld or mobile usages, or whether it is used in a stable

environment such as on a table in the workplace or at home. By setting different detection levels for the computer depending on whether it runs with the AC power (desktop) or with batteries (handheld or mobile usage), the detection level automatically switches according to the power connection mode.

3D Viewer

This feature displays a 3D object on the screen which moves in according to tilting or vibration of the computer.

When the TOSHIBA HDD Protection detects computer vibration the Hard Disk Drive head is parked and the 3D object disk rotation will stop. When the head is un-parked the disk will begin to rotate again.

The **3D Viewer** can be started from the icon in the task tray.



- *This 3D object virtually represents the Computer's internal Hard Disk Drive. This representation may vary from the actual number of disks, disk rotation, head movement, part size, shape and direction.*
- *This feature may use a large amount of CPU and memory on some models. The computer may become slow or sluggish when attempting to run other applications while the 3D Viewer is displayed.*
- *Intensely shaking the computer or other subjecting it to strong impacts may cause damage to the computer.*

Details

To open the Details window, click the **Setup Detail** button in the TOSHIBA HDD Protection Properties window.

Detection Level Amplification

When the AC adaptor is disconnected or the lid is closed, HDD Detection assumes that the computer will be carried and sets the detection level to the maximum for 10 seconds.

HDD Protection Message

Specify whether to display a message when TOSHIBA HDD Protection is active.



This function does not work when the computer is booting, in Sleep Mode, in Hibernation Mode, in transition to Hibernation Mode, recovering from Hibernation Mode, or powered off. Do not subject the computer to vibration or impact while the function is disabled.

System Recovery

There is a hidden partition allocated on the hard disk drive for the System Recovery Options in the event of a problem.

You can also create recovery media and restore the system.

The following items will be described in this section:

- System Recovery Options
- Creating Recovery Media
- Restoring the pre-installed software from your created Recovery Media
- Restoring the pre-installed software from the Recovery hard disk drive



The System Recovery Options feature will be unusable if this partition is deleted.

System Recovery Options

The System Recovery Options feature is installed on the hard disk when shipped from the factory. The System Recovery Options menu includes tools to repair startup problems, run diagnostics or restore the system.

See the **Windows Help and Support** content for more information about **Startup Repair**.

The System Recovery Options can also be run manually to repair problems.

The procedure is as follows. Follow the instructions shown on the on-screen menu.

1. Turn off the computer.
2. While holding the **F8** key, turn on the computer.
3. The **Advanced Boot Options** menu will be displayed. Use the arrow keys to select **Repair Your Computer** and press **ENTER**.
4. Follow the on-screen instructions.



Check your Windows® manual for more information on backing up your system (including the system image backup feature).

Creating Recovery Media

This section describes how to create Recovery Media.



- *Be sure to connect the AC adaptor when you create Recovery Media.*
- *Be sure to close all other software programs except the Recovery Media Creator.*
- *Do not run software such as screen savers which can put a heavy load on the CPU.*

- *Operate the computer at full power.*
- *Do not use power-saving features.*
- *Do not write to the media when the virus check software is running. Wait for it to finish, then disable virus detection programs including any software that checks files automatically in the background.*
- *Do not use utilities, including those intended to enhance hard disk drive access speed. They may cause unstable operation and damage data.*
- *Do not shut down/log off or Sleep/Hibernate while writing or rewriting the media.*
- *Set the computer on a level surface and avoid places subjected to vibrations such as airplanes, trains, or cars.*
- *Do not use on an unstable surface such as a stand.*

A recovery image of the software on your computer is stored on the hard disk drive, and can be copied to either DVD or USB Flash Memory by using the following steps:

1. Select either blank disc or USB Flash Memory.
The application will allow you to choose from a variety of different media onto which the recovery image can be copied including disc media and USB Flash Memory.



- *Please note that some of the above media may not be compatible with the external optical disc drive connected to your computer. You should therefore verify the external optical disc drive supports the blank media you have chosen before proceeding.*
- *USB Flash Memory will be formatted and all the data in the USB Flash Memory will be lost when proceeding.*

2. Turn on your computer and allow it to load the Windows 7 operating system from the hard disk drive as normal.
3. Insert the first blank disc into the external optical disc drive tray, or insert the USB Flash Memory into one available USB port.
4. Double click the **Recovery Media Creator** icon on the Windows 7 desktop, or select the application from **Start** Menu.
5. After Recovery Media Creator starts, select the type of media and the title you wish to copy, and then click the **Create** button.

Restoring the pre-installed software from your created Recovery Media

If the pre-installed files are damaged, you are able to either use the Recovery Media you have created or the hard disk drive recovery process to restore the computer to the state it was in when you originally received it. To perform this restoration, follow the steps below:



When the sound mute feature has been activated by pressing the **FN + ESC** key, be sure to disable this to allow sounds to be heard before starting the restore process. Please refer to [The Keyboard](#) in Chapter 3, *Operating Basics*, for further details.

You can not use System Recovery Options if restoring the pre-installed software without System Recovery Options.



When you reinstall the Windows operating system, the hard disk will be reformatted and all data will be lost.

1. Load the Recovery Media into the external ODD or insert the recovery USB Flash Memory into one available USB port.
2. Turn off the computer's power.
3. While holding down **F12** key on the keyboard, turn on your computer - when the **TOSHIBA Leading Innovation >>>** logo screen appears, release the **F12** key.
4. Use the up and down cursor key to select the appropriate option from the menu according to your actual recovery media. Please refer to the [Boot Setting](#) section for further information.
5. A menu will be displayed from which you should follow the on-screen instructions.



If you have previously chosen to remove the recovery partition and are trying to create "Recovery Media", you will see the following message: "The Recovery Media Creator can not be launched because there is no recovery partition."

When there is no recovery partition, the Recovery Media Creator cannot make Recovery Media.

However, if you have already created a "Recovery Media", you can use it to restore the recovery partition.

If you have not created "Recovery Media", please contact TOSHIBA support for assistance.

Restoring the pre-installed software from the Recovery hard disk drive

A portion of the total hard disk drive space is configured as a hidden recovery partition. This partition stores files which can be used to restore pre-installed software in the event of a problem.

If you subsequently set up your hard disk drive again, do not change, delete or add partitions in a manner other than specified in the manual, otherwise you may find that space for the required software is not available.

In addition, if you use a third-party partitioning program to reconfigure the partitions on your hard disk drive, you may find that it becomes impossible to setup your computer.



*When the sound mute feature has been activated by pressing the **FN + ESC** key, be sure to disable this to allow sounds to be heard before starting the restore process. Please refer to [The Keyboard](#) in Chapter 3, *Operating Basics*, for further details.*

You can not use System Recovery Options if restoring the pre-installed software without System Recovery Options.



When you reinstall the Windows operating system, the hard disk will be reformatted and all data will be lost.

1. Turn off your computer.
2. While holding down **0** (zero) key on the keyboard, turn on your computer.
3. A menu will be displayed from which you should follow the on-screen instructions.

Triple/Quad Multi Monitor

AMD GPU model may include the Triple/Quad Multi Monitor function that can display image on Triple or Quad Multi Monitor independently.

The Triple/Quad Multi Monitor function can be used only in Windows 7.

Triple Multi Monitor

The following Monitor combination is required to support Triple Multi Monitor.

DisplayPort Model without TOSHIBA Hi-Speed Port Replicator II:

Computer	LCD	Yes				
	RGB	Yes				
	DisplayPort	Yes				

DisplayPort Model With TOSHIBA Hi-Speed Port Replicator II:

Computer	LCD	Yes	Yes	Yes	-	-
	RGB	-	-	-	-	-
	DisplayPort	Yes	Yes	Yes	Yes	Yes

Replicator	RGB	Yes	-	-	Yes	Yes
	HDMI	-	Yes	-	Yes	-
	DisplayPort	-	-	Yes	-	Yes

HDMI Model With TOSHIBA Hi-Speed Port Replicator II:

Computer	LCD	Yes	Yes	-
	RGB	-	-	-
	HDMI	Yes	-	Yes
Replicator	RGB	-	Yes	Yes
	HDMI	-	-	-
	DisplayPort	Yes	Yes	Yes

Quad Multi Monitor

DisplayPort Model With TOSHIBA Hi-Speed Port Replicator II:

Computer	LCD	Yes
	RGB	-
	DisplayPort	Yes
Replicator	RGB	Yes
	HDMI	-
	DisplayPort	Yes



Yes: Support.

Chapter 5

Power and Power-Up Modes

The computer's power resources include the AC adaptor, battery pack and any internal batteries. This chapter provides details on making the most effective use of these resources, and includes information on charging and changing batteries, tips for saving battery power, and information on the different power-up modes.

Power conditions

The computer's operating capability and battery charge status are affected by different power conditions, including whether an AC adaptor is connected, whether a battery pack is installed and what the charge level is for that battery.

		Power on	Power off (no operation)
AC adaptor connected	Battery fully charged	<ul style="list-style-type: none"> Operates No charge LED: Battery green DC IN green 	<ul style="list-style-type: none"> No charge LED: Battery green DC IN green
	Battery partially charged or no charge	<ul style="list-style-type: none"> Operates Charge LED: Battery orange DC IN green 	<ul style="list-style-type: none"> Quick charge LED: Battery orange DC IN green
	No battery installed	<ul style="list-style-type: none"> Operates No charge LED: Battery off DC IN green 	<ul style="list-style-type: none"> No charge LED: Battery off DC IN green

		Power on	Power off (no operation)
AC adaptor not connected	Remaining battery capacity is above low battery trigger point	<ul style="list-style-type: none"> Operates LED: Battery off DC IN off	
	Remaining battery capacity is below low battery trigger point	<ul style="list-style-type: none"> Operates LED: Battery flashes orange DC IN off	
	Remaining battery capacity is exhausted	Computer shuts down	
	No battery installed	<ul style="list-style-type: none"> No operation LED: Battery off DC IN off	

Monitoring of power condition

As shown in the below table, the **Battery**, **DC IN** and **Power** indicators on the system indicator panel alert you to the computer's operating capability and battery charge status.

Battery indicator

Check the **Battery** indicator to determine the status of the battery pack. The following indicator lights indicate the battery status:

Flashing orange	The battery charge is low, the AC adaptor must be connected in order to recharge the battery.
Orange	Indicates the AC adaptor is connected and the battery is charging.
Green	Indicates the AC adaptor is connected and the battery is fully charged.
No light	Under any other conditions, the indicator does not light.



*If the battery pack becomes too hot while it is being charged, the charge will stop and the **Battery** indicator will go out. When the battery pack's temperature falls to a normal range, charging will resume - this process will occur regardless of whether the computer's power is on or off.*

DC IN indicator

Check the **DC IN** indicator to determine the power status with the AC adaptor connected - the following indicator conditions should be noted:

Green	Indicates the AC adaptor is connected and is correctly supplying power to the computer.
Flashing orange	Indicates a problem with the power supply. You should initially try plugging the AC adaptor into another power outlet - if it still does not operate properly, you should contact TOSHIBA Support.
No light	Under any other conditions, the indicator does not light.

Power indicator

Check the **Power** indicator to determine the power status of the computer - the following indicator conditions should be noted:

Green	Indicates power is being supplied to the computer and the computer is turned on.
Blinking orange	Indicates that the computer is in Sleep Mode and that there is sufficient power available (AC adaptor or battery) to maintain this condition. In Sleep Mode, this indicator will turn on for one second and off for two seconds.
No light	Under any other conditions, the indicator does not light.

Battery

This section explains battery types, use, recharging methods and handling.

Battery types

The computer has different types of batteries.

Battery pack

When the AC adaptor is not connected, the computer's main power source is a removable lithium ion battery pack, also referred to in this manual as the main battery. You can purchase additional battery packs for extended

use of the computer away from an AC power source although you should not change the battery pack while the AC adaptor is connected.

Before you remove the battery pack, save your data and shut down the computer, or place the computer into Hibernation Mode. Please be aware that, when placing the computer into Hibernation Mode, the contents of memory will be saved to the hard disk drive, although for safety sake, it is best to also save your data manually.

Real Time Clock (RTC) battery

The Real Time Clock (RTC) battery provides power for the internal real time clock and calendar function and also maintains the system configuration while the computer is turned off. If the RTC battery becomes completely discharged, the system will lose this information and the real time clock and calendar will stop working - in this instance the following message will be displayed when you turn on the power:

****** RTC Power Failure **** Check system. Then press [F2] key.**

You can change the Real Time Clock settings by turning on the computer while pressing the **F2** key and then release **F2** key when the **TOSHIBA Leading Innovation >>>** screen appears. Please refer to Chapter 6 [Troubleshooting](#) for further information.



The RTC battery does not charge while the computer is turned off even if the AC adaptor is attached.

Care and use of the battery pack

This section provides the important safety precautions in order to handle your battery pack properly.

Refer to the enclosed **Instruction Manual for Safety and Comfort** for detailed precautions and handling instructions.



- *Make sure the battery is securely installed in the computer before attempting to charge the battery pack. Improper installation could generate smoke or fire, or cause the battery pack to rupture.*
- *Keep the battery pack out of reach of infants and children. It can cause injury.*



- *The lithium ion battery pack can explode if not replaced, used, handled or disposed of properly. Dispose of the battery as required by local ordinances or regulations. Use only batteries recommended by TOSHIBA as replacements.*

- *The computer's RTC battery is a Ni-MH battery and should be replaced only by your dealer or by a TOSHIBA service representative. The battery can explode if not properly replaced, used, handled or disposed. Dispose of the battery as required by local ordinances or regulations.*
- *Charge the battery pack only in an ambient temperature between 5 and 35 degrees Celsius. Otherwise, the electrolyte solution might leak, battery pack performance might deteriorate and the battery life might be shortened.*
- *Never install or remove the battery pack without first turning off the power and disconnecting the AC adaptor. Never remove the battery pack while the computer is in Sleep Mode. Data could be lost.*



Never remove the battery pack while the Wake-up on LAN function is enabled. Data will be lost. Before you remove a battery pack, disable the Wake-up on LAN function.

Charging the batteries

When the power in the battery pack becomes low, the **Battery** indicator will flash orange to indicate that only a few minutes of battery power remain. If you continue to use the computer while the **Battery** indicator flashes, the computer will enable Hibernation Mode so that you do not lose any data, and automatically turn itself off.

You must recharge a battery pack when it becomes discharged.

Procedures

To recharge a battery pack while it is installed in the computer, connect the AC adaptor to the DC IN 19V jack and plug the other end into a working outlet - the **Battery** indicator will glow orange while the battery is being charged.



Use only the computer connected to an AC power source or optional TOSHIBA Battery charger to charge the battery pack. Never attempt to charge the battery pack with any other charger.

Charging Time (hours) for R850 series

Battery type	Power off	Power on
Battery pack (48Wh, 6 cell)	about 3	about 3 ~11
Battery pack (66Wh, 6 cell)	about 4	about 4 ~15

Battery type	Power off	Power on
RTC battery	Doesn't charge	about 10
RTC battery (High Capacity)	Doesn't charge	about 20

Charging Time (hours) for R830/R840 series

Battery type	Power off	Power on
Battery pack (66Wh, 6 cell)	about 5	about 5 ~15
Battery pack (93Wh, 9 cell)	about 5	about 5 ~21.5
RTC battery	Doesn't charge	about 10

Battery charging notice

The battery may not begin charging immediately under the following conditions:

- The battery is extremely hot or cold (if the battery is extremely hot, it might not charge at all). To ensure the battery charges to its full capacity, you should charge it at room temperature of between 5°C to 35°C (41°F to 95°F).
- The battery is nearly completely discharged. In this instance you should leave the AC adaptor connected for a few minutes and the battery should begin charging.

The **Battery** indicator may show a rapid decrease in battery operating time when you try to charge a battery under the following conditions:

- The battery has not been used for a long time.
- The battery has completely discharged and been left in the computer for a long time.
- A cool battery is installed in a warm computer.

In such cases you should follow the steps as detailed below:

1. Fully discharge the battery by leaving it in the computer with the power on until the system automatically turns itself off.
2. Connect the AC adaptor to the DC IN 19V jack of the computer, and to a wall outlet that is supplying power.
3. Charge the battery until the **Battery** indicator glows green.

Repeat these steps two or three times until the battery recovers normal capacity.

Monitoring battery capacity

Remaining battery power can be monitored using the following methods.

- Clicking the battery icon on the Taskbar
- Via the Battery Status in the Windows Mobility Center window



- *You should wait at least 16 seconds after turning on the computer before trying to monitor the remaining operating time. This is because the computer needs this time to check the battery's remaining capacity and then calculate the remaining operating time, based on this together with the current power consumption.*
- *Please be aware that the actual remaining operating time may differ slightly from the calculated time.*
- *With repeated discharges and recharges, the battery's capacity will gradually decrease. In view of this it will be noted that an often used, older battery will not operate for as long as a new battery even when both are fully charged.*

Maximizing battery operating time

A battery's usefulness depends on how long it can supply power on a single charge, while how long the charge lasts in a battery depends on:

- Processor speed
- Screen brightness
- System Sleep Mode
- System Hibernation Mode
- Display power off period
- Hard disk drive power off period
- How often and for how long you use the hard disk drive and external disk(c) drives, for example, optical disc and floppy diskette drive.
- How much charge the battery contained to begin with.
- How you use optional devices, such as a USB device, to which the battery supplies power.
- Whether you enable Sleep Mode, which can conserve battery power if you are frequently turning the computer off and on.
- Where you store your programs and data.
- Whether you close the display panel when you are not using the keyboard - closing the display saves power.
- The environmental temperature - operating time decreases at low temperatures.
- The condition of the battery terminals - you should always ensure the terminals stay clean by wiping them with a clean dry cloth before installing the battery pack.

Batteries exhausted time

When you turn off the power of your computer with batteries fully charged, the batteries will be exhausted within the following approximate period:

Retention Time for R850 series

Battery type	Sleep Mode	Shut Down Mode
Battery pack (48Wh, 6 cell)	about 4 days	about 75 days
Battery pack (66Wh, 6 cell)	about 5 days	about 100 days
RTC battery	about 30 days	about 30 days
RTC battery (High Capacity)	about 90 days	about 90 days

Retention Time for R840 series

Battery type	Sleep Mode	Shut Down Mode
Battery pack (66Wh, 6 cell)	about 5 days	about 70 days
Battery pack (93Wh, 9 cell)	about 5 days	about 105 days
RTC battery	about 30 days	about 30 days

Retention Time for R830 series

Battery type	Sleep Mode	Shut Down Mode
Battery pack (66Wh, 6 cell)	about 5 days	about 115 days
Battery pack (93Wh, 9 cell)	about 7 days	about 165 days
RTC battery	about 30 days	about 30 days

Extending battery life

To maximize the life of your battery packs:

- At least once a month, disconnect the computer from a power source and operate it on battery power until the battery pack fully discharges. Before doing so, follow the steps as detailed below.

1. Turn off the computer's power.
 2. Disconnect the AC adaptor and turn on the computer's power - if it does not turn on then go to Step 4.
 3. Operate the computer on battery power for five minutes. If you find that the battery pack has at least five minutes of operating time, continue operating until the battery pack is fully discharged, however, if the **Battery** indicator flashes or there is some other warning to indicate a low battery condition, go to Step 4.
 4. Connect the AC adaptor to the DC IN 19V jack of the computer, and to a wall outlet that is supplying power. The **DC IN** indicator should glow green, and the **Battery** indicator should glow orange to indicate that the battery pack is being charged, however, in the event that **DC IN** indicator does not glow this indicates that power is not being supplied - check the connections for the AC adaptor and the power cord.
 5. Charge the battery pack until the **Battery** indicator glows green.
- If you have extra battery packs, rotate their use.
 - If you will not be using the system for an extended period, for example for more than one month, remove the battery pack from the computer.
 - Store spare battery packs in a cool dry place out of direct sunlight.

Replacing the battery pack

Please be aware that the battery pack is classified as a consumable item.

The operating life of the battery pack will gradually reduce through repeated charging and discharging, and will need to be replaced when it reaches the end of its operating life. In addition to this, you might also replace a discharged battery pack with a charged spare when you are operating your computer away from an AC power source for an extended period of time.

This section explains how to remove and install the battery pack, and begins with the removal process which is detailed through the following steps.



- *Do not remove the battery pack while the computer is in Sleep Mode. Data is stored in RAM, so if the computer loses power it could be lost.*
- *In Hibernation Mode, data will be lost if you remove the battery pack or disconnect the AC adaptor before the save is completed. Wait for the **Hard Disk Drive/Optical Disc Drive/eSATA** indicator to go out.*
- *Do not touch the battery release latch while holding the computer or the battery pack might fall out due to the unintentional release of the battery release latch and cause injuries.*

Removing the battery pack

To remove a discharged battery, follow the steps as detailed below:

1. Save your work.
2. Turn the computer's power off - ensure that the **Power** indicator is off.
3. Remove all cables and peripherals that are connected to the computer.
4. Close the display panel and turn the computer upside down.
5. Slide the battery lock into its unlocked (⏏) position.
6. Slide and hold the battery release latch to disengage the battery pack and then remove it from the computer.

Figure 5-1 Releasing the battery pack (R830)

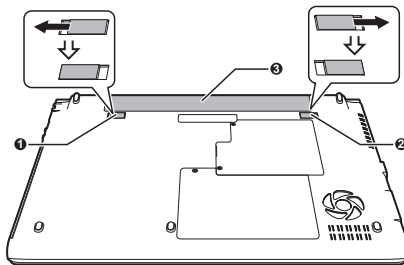

1. Battery lock

2. Battery release latch

3. Battery pack

Installing the battery pack

To install a battery pack, follow the steps as detailed below:



Do not touch the battery release latch while holding the computer or the battery pack might fall out due to the unintentional release of the battery release latch and cause injuries.

1. Insert the battery pack as far as it will go into the computer.
2. Ensure that the battery pack is securely in place and the battery lock is in its locked position.
3. Turn your computer over.

Power-up modes

The computer has three different power-up modes as follows:

- **Shut Down Mode:** The computer will shut down without saving data - in view of this you must always save your work before you turn the computer off.
- **Hibernation Mode:** Data in memory will be saved to the hard disk drive.
- **Sleep Mode:** Data will be maintained in the computer's memory.



Please refer to the sections [Turning on the power](#) and [Turning off the power](#) in Chapter 1, *Getting Started* for further information.

Windows utilities

You can configure various settings associated with both Sleep Mode and Hibernation Mode within the Power Options (to access it, **Start** -> **Control Panel** -> **System and Security** -> **Power Options**).

Hot keys

You can use the **FN + F3** hot key to enter Sleep Mode or **FN + F4** to enter Hibernation Mode.

Panel power on/off

You can set up your computer so that power is turned off automatically when you close the display panel, and turned on again when you open it. Please note that this function is only available for Sleep Mode or Hibernation Mode, not for Shut Down Mode.



If the panel power off function is enabled, and you manually shut down Windows, do not close the display panel until the shut down process has been completed.

System automatic Sleep/Hibernation

This feature automatically turns off the system in Sleep or Hibernation Mode if the computer is not used for a set duration. Refer to [Special features](#), in Chapter 4 for an explanation of how to set the duration.

Chapter 6

Troubleshooting

TOSHIBA have designed this computer for durability, however, should problems occur you are able to use the procedures detailed in this chapter to help determine the cause.

All users should become familiar with this chapter as knowing what might go wrong can help prevent problems from occurring in the first place.

Problem solving process

Resolving problems will be much easier if you observe the following guidelines:

- Stop immediately when you recognize a problem exists as taking further action may result in data loss or damage, or you may destroy valuable problem related information that can help solve the problem.
- Observe what is happening - write down what the system is doing and what actions you performed immediately before the problem occurred. Make a screenshot of the current display.

Please also be aware that the questions and procedures described in this chapter are meant only as a guide, they are not definitive problem solving techniques. In reality many problems can be solved simply, but a few may require help from TOSHIBA Support - if you find you need to consult others, be prepared to describe the problem in as much detail as possible.

Preliminary checklist

You should always consider the simplest solution first - the items detailed in this checklist are easy to fix and yet can cause what appears to be a serious problem:

- Make sure you turn on all peripheral devices before you turn on the computer - this includes your printer and any other external device you are using.
- Before you attach an external device you should first turn the computer off, then when you turn the computer back on again it will recognize the new device.
- Make sure all optional accessories are configured properly in the computer's setup program and that all required driver software has been loaded (please refer to the documentation included with the optional accessories for further information on its installation and configuration).

- Check all cables to ensure they are correctly and firmly attached to the computer - loose cables can cause signal errors.
- Inspect all connecting cables for loose wires and all connectors for loose pins.
- Check that your disc media is correctly loaded.

Always try to make detailed notes of your observations and keep them in a permanent error log - this will help you to describe your problems to TOSHIBA Support. In addition, if a problem recurs, the log you have made will help to identify the problem faster.

Analyzing the problem

Sometimes the computer will give you clues that can help you identify why it is malfunctioning. In view of this you should keep the following questions in mind:

- Which part of the computer is not operating properly - keyboard, hard disk drive, display panel, touch pad, touch pad control buttons - as each device will produce different symptoms.
- Check the options within the operating system to ensure that its configuration is set properly.
- What appears on the display? Does it display any messages or random characters? Make a screenshot of the current display and, if possible, look up the messages in the documentation included with the computer, software or operating system.
- Check that all connecting cables are correctly and firmly attached as loose cables can cause erroneous or intermittent signals.
- Do any indicators light, if so, which ones, what color are they and do they stay on or blink? Write down what you see.
- Do you hear any beeps, if so how many, are they long or short and are they high pitched or low pitched? In addition, is the computer making any unusual noises? Write down what you hear.

Record your observations so you can describe them in detail to TOSHIBA Support.

Software

The problems may be caused by your software or disk. If you cannot load a software package, the media may be damaged or the program might be corrupted - in these instances try loading another copy of the software if possible.

If an error message appears while you are using a software package you should refer to the documentation supplied with it as this will usually include a problem solving section or a summary of error messages.

Next, you should check any error messages against the operating system documentation.

Hardware

If you cannot find a software problem, you should then check the setup and configuration of your hardware. First run through the items in the preliminary checklist as described previously then, if you still cannot correct the problem, try to identify the source - the next section provides checklists for individual components and peripherals.



Before using a peripheral device or application software that is not an authorized TOSHIBA part or product, make sure the device or software can be used with your computer. Use of incompatible devices may cause injury or may damage your computer.

If something goes wrong

Your program stops responding

If you are working with a program that suddenly freezes all operations, chances are the program has stopped responding. You can exit the failed program without shutting down the operating system or closing other programs.

To close a program that has stopped responding:

1. Press **CTRL**, **ALT**, and **DEL** simultaneously (once), then click **Start Task Manager**. The Windows® Task Manager window appears.
2. Click the **Applications** tab. If a program has stopped responding, the words "not responding" appear beside its name in the list.
3. Select the program you want to close, then click **End Task**. Closing the failed program should allow you to continue working. If it does not, continue with the next step.
4. Close the remaining programs one by one by selecting the program name, then **End Task**. Closing all programs should allow you to continue working. If it does not, power off your computer and then restart it.

The computer will not start

Make sure you attached the AC adaptor and power cord/cable properly or installed a charged battery.

If you are using the AC adaptor, check that the wall outlet is working by plugging in another device, such as a lamp.

Verify that the computer is on by looking at the **Power** indicator.

If the indicator is glowing, the computer is on. Also, try turning the computer off and then on.

If you are using an AC adaptor, verify that the computer is receiving power from the external power source by looking at the AC power light. If the

indicator is glowing, the computer is connected to a live external power source.

Hardware and system checklist

This section discusses problems caused by your computer's hardware or attached peripherals. Basic problems may occur in the following areas:

- Power
- Keyboard
- Internal display panel
- Hard disk drive
- Optical Disc Drive
- ExpressCard
- Smart Card
- Memory Media Card
- Dual Pointing Device
- Fingerprint Sensor
- USB device
- eSATA device
- Additional memory module
- Sound system
- External monitor
- LAN
- Wireless LAN
- Bluetooth

Power

When the computer is not plugged into an AC power outlet, the battery pack is the primary power source. However, your computer also has a number of other power resources, including an intelligent power supply and a Real Time Clock (RTC) battery, all of which are interrelated with any one having the ability to produce apparent power problems.

Overheating power down

If the processor's temperature reaches an unacceptably high level with either setting, the computer will automatically shut down to prevent any damage - in this instance all unsaved data in memory will be lost.

Problem	Procedure
Computer shuts down and DC IN indicator blinks orange	<p>Leave the computer off until the DC IN indicator stops blinking. It is recommended to leave the computer off until the interior reaches room temperature even though the DC IN indicator stops blinking.</p> <p>If the computer has reached room temperature and it still does not start, or if it starts but shuts down quickly, contact TOSHIBA Support.</p>
Computer shuts down and its DC IN indicator is flashing green	This indicates a problem with the heat dispersal system - you should contact TOSHIBA Support.

AC power

If you have trouble turning on the computer with the AC adaptor connected you should check the status of the **DC IN** indicator.

Please refer to Chapter 5, *Power and Power-Up Modes* for further information.

Problem	Procedure
AC adaptor doesn't power the computer (DC IN indicator does not glow green)	Check the connections to make sure that the power cord/adaptor is firmly connected to the computer and a working power outlet. Check the condition of the cord and terminals. If the cord is frayed or damaged it should be replaced, while if the terminals are soiled, they should be cleaned with a clean cotton cloth. If the AC adaptor still does not power the computer, you should contact TOSHIBA Support.

Battery

If you suspect a problem with the battery, you should check the status of the **DC IN** indicator as well as the **Battery** indicator.

Problem	Procedure
Battery doesn't power the computer	The battery may be discharged - connect the AC adaptor to recharge the battery.

Problem	Procedure
<p>Battery doesn't charge when the AC adaptor is attached (Battery indicator does not glow orange).</p>	<p>If the battery is completely discharged, it will not begin charging immediately, in these instances you should wait a few minutes before trying again. If the battery still does not charge, you should check that the power outlet the AC adaptor is connected to is supplying power - this can be tested by plugging another appliance into it.</p> <hr/> <p>Check whether the battery is hot or cold to the touch - if so, it will not charge properly and should be allowed to reach room temperature before you try again.</p> <hr/> <p>Unplug the AC adaptor and remove the battery to make sure its connecting terminals are clean - if necessary wipe them with a soft dry cloth lightly dipped in alcohol.</p> <p>Connect the AC adaptor and replace the battery, taking care to ensure that it is securely seated in the computer.</p> <p>Check the Battery indicator - if it does not glow, allow the computer to charge the battery for at least twenty minutes. If the Battery indicator starts to glow after this period, allow the battery to continue to charge for at least another twenty minutes before turning on the computer. However, if the indicator still does not glow, the battery may be at the end of its operating life and should be replaced. However, if you do not believe the battery is at the end of its operating life, you should speak to TOSHIBA Support.</p>
<p>Battery doesn't power the computer as long as expected</p>	<p>If you frequently recharge a partially charged battery, the battery might not charge to its full potential - in these instances you should fully discharge the battery and then attempt to charge it again.</p> <hr/> <p>Check the Power saver option under Select a power plan in the Power Options.</p>

Real Time Clock

Problem	Procedure
<p>The following message is displayed on the screen:</p> <p>RTC Power Failure. Check system. Then press [F2] key.</p>	<p>The charge in the Real Time Clock (RTC) battery has run out - you will need to set the date and time in the BIOS setup application by using the following steps:</p> <ol style="list-style-type: none"> 1. Turn on the computer. 2. Press the F2 key when the TOSHIBA Leading Innovation >>> screen appears - the BIOS setup application will load. 3. Set the date in the System Date field. 4. Set the time in the System Time field. 5. Press F10 - a confirmation message will be displayed. 6. Press the ENTER key - the BIOS setup application will end and the computer will restart.

Keyboard

Keyboard problems can be caused by the setup and configuration of the computer - please refer to the section [The Keyboard](#) in Chapter 3, Operating Basics, for further information.

Problem	Procedure
Some letter keys produce numbers	Check that the numeric keypad overlay is not activated - press the FN + F11 hot key and try typing again.
Output to screen is garbled	<p>Please refer to your software's documentation to ensure that its is not remapping the keyboard in any way (remapping involves changing or reassigning the function of each key).</p> <p>If you are still unable to use the keyboard, you should contact TOSHIBA Support.</p>

Internal display panel

Apparent computer's display panel problems may be related to the computer's setup and configuration - please refer to the [HW Setup](#) section in Chapter 4, Utilities & Advanced Usage, for further information.

Problem	Procedure
No display	Press the FN + F5 hot keys to adjust the display priority, and to make sure it is not set for output to an external monitor.
Markings appear on the computer's display panel.	These marks may have come from contact with the keyboard and Touch Pad while the display panel has been closed. You should try to remove the marks by gently wiping the display panel with a clean dry cloth or, if this fails, with a good quality LCD screen cleaner. In this latter instance you should always follow the instructions with the screen cleaner and always ensure you let the display panel dry properly before closing it.

Hard disk drive

Problem	Procedure
Computer does not boot from hard disk drive	<p>Check to see whether there is a disc in the optical disc drive - if so remove it and try to start the computer again.</p> <p>If this has no effect, check the Boot Priority setting within the TOSHIBA HW Setup utility - please refer to the Boot Setting section in Chapter 4, Utilities & Advanced Usage for further information.</p>
Slow performance	<p>The files on the hard disk drive may be fragmented - in this instance you should run the disk Defragmentation utility to check the condition of your files and the hard disk drive. Please refer to the operating system's documentation or online Help File for further information on operating and using the Defragmentation utility.</p> <p>As a last resort you should reformat the hard disk drive and then reload the operating system and all other files and data. If you are still unable to resolve the problem, contact TOSHIBA Support.</p>

Optical Disc Drive

For more information, refer to Chapter 3, [Operating Basics](#).

Problem	Procedure
You cannot access a disc in the drive.	<p data-bbox="501 121 1028 188">Make sure the drive's disc tray is securely closed. Press gently until it clicks into place.</p> <hr/> <p data-bbox="501 204 987 287">Open the disc tray and make sure the disc is properly seated. It should lie flat with the label facing up.</p> <hr/> <p data-bbox="501 303 1021 386">A foreign object in the disc tray could block laser light from reading the disc. Make sure there is no obstruction. Remove any foreign object.</p> <hr/> <p data-bbox="501 402 1028 531">Check whether the disc is dirty. If it is, wipe it with a clean cloth dipped in water or a neutral cleaner. Refer to the Media care section in Chapter 3 for details on cleaning.</p>

Memory Media Card

For further information, please refer to Chapter 3, [Operating Basics](#).

Problem	Procedure
Memory media card error occurs	<p data-bbox="501 716 1043 799">Remove the memory media card from the computer and then reinsert it in order to ensure it is firmly connected.</p> <p data-bbox="501 815 1043 917">If the problem persists, then you should refer to the documentation supplied with your memory media card for further information.</p>
You cannot write to a memory media card	<p data-bbox="501 917 1010 1023">Remove the memory media card from the computer and check to ensure that it is not write protected.</p>
You cannot read a file	<p data-bbox="501 1023 1032 1125">Check to ensure the required file is actually on the memory media card that is inserted into the computer.</p> <p data-bbox="501 1125 972 1189">If you are still unable to resolve the problem, contact TOSHIBA Support.</p>

Smart Card

For further information, please refer to Chapter 3, [Operating Basics](#).

Problem	Procedure
Smart Card error occurs	<p>Remove the Smart Card from the computer, make sure to confirm that the card oriented correctly and reinsert it in order to ensure it is firmly connected.</p> <p>If the problem persists, then you should refer to the documentation supplied with your Smart Card for further information.</p>

Dual Pointing device

If you are using a USB mouse, you should also refer to both the [USB mouse](#) section in this chapter, and the documentation supplied with your mouse.

Touch Pad/AccuPoint

Problem	Procedure
Either the Touch Pad or the AccuPoint does not work.	<p>Check the Device Select settings.</p> <p>Click Start -> Control Panel -> Hardware and Sound -> Mouse.</p>
On-screen pointer does not respond to pointing device operation	<p>In this instance the system might be busy - Try moving the mouse again after waiting a short while.</p>
Double-tapping (Touch Pad) or double-clicking (AccuPoint) does not work	<p>In this instance, you should initially try changing the double-click speed setting within the Mouse Control utility.</p> <ol style="list-style-type: none"> 1. To access this utility, click Start -> Control Panel -> Hardware and Sound -> Mouse. 2. Within the Mouse Properties window, click the Buttons tab. 3. Set the double-click speed as required and click OK.
The on-screen pointer moves too fast or too slow	<p>In this instance, you should initially try changing the speed setting within the Mouse Control utility.</p> <ol style="list-style-type: none"> 1. To access this utility, click Start -> Control Panel -> Hardware and Sound -> Mouse. 2. Within the Mouse Properties window, click the Pointer Options tab. 3. Set the pointer speed as required and click OK.

Problem	Procedure
The reaction of Touch pad is either too sensitive or not sensitive enough.	Adjust the touch Sensitivity. To access it, click Start -> Control Panel -> Hardware and Sound -> Mouse . If you are still unable to resolve the problem, contact TOSHIBA Support.

USB mouse

Problem	Procedure
On-screen pointer does not respond to mouse operation	In this instance the system might be busy - Try moving the mouse again after waiting a short while. Remove the mouse from the computer and then reconnect it to a free USB port it in order to ensure it is firmly attached.
Double-clicking does not work	In this instance, you should initially try changing the double-click speed setting within the Mouse Control utility. <ol style="list-style-type: none"> To access this utility, click Start -> Control Panel -> Hardware and Sound -> Mouse. Within the Mouse Properties window, click the Buttons tab. Set the double-click speed as required and click OK.
The on-screen pointer moves too fast or too slow	In this instance, you should initially try changing the speed setting within the Mouse Control utility. <ol style="list-style-type: none"> To access this utility, click Start -> Control Panel -> Hardware and Sound -> Mouse. Within the Mouse Properties window, click the Pointer Options tab. Set the pointer speed as required and click OK.
The on-screen pointer moves erratically	The elements of the mouse responsible for detecting movement might be dirty - please refer to the documentation supplied with the mouse for instructions on how to clean it. If you are still unable to resolve the problem, contact TOSHIBA Support.

Fingerprint Sensor

Problem	Procedure
Reading of the fingerprint was not successful.	<p>In this instance you should try the fingerprint reading operation again using the correct finger position - please refer to Using the Fingerprint Sensor in Chapter 3, Operating Basics for further information.</p> <p>Alternatively, you should try the recognition process again using another enrolled finger.</p> <p>The fingerprint sensor compares and analyzes the unique characteristics in a fingerprint. However, there may be instances where certain users are unable to register their fingerprints due to insufficient unique characteristics in their fingerprints.</p> <p>The recognition success rate may differ from user to user.</p>
The fingerprint cannot be read due to injuries to the finger.	<p>In this instance you should try the recognition process again using another enrolled finger. However, if fingerprints from all the enrolled fingers cannot be read, you should instead log into the computer by using the keyboard to input the password.</p> <p>If you are still unable to resolve the problem, contact TOSHIBA Support.</p>

USB device

In addition to the information in this section, please also refer to the documentation supplied with your USB device.

Problem	Procedure
USB device does not work	<p>Remove the USB device from the computer and then reconnect it to a free port in order to ensure it is firmly attached.</p> <p>Ensure that any required USB device drivers are properly installed - to achieve this you should refer to both the device documentation and the operating system documentation.</p>

Sleep and Charge function

For more information and settings, please refer to the [Using the TOSHIBA Sleep Utility](#) section in Chapter 4, Utilities & Advanced Usage.

Problem	Procedure
<p>I cannot use the Sleep and Charge function.</p>	<p>Sleep and Charge function may be disabled. Select the "Enable Sleep and Charge" check box in the TOSHIBA Sleep utility to enable this function.</p> <p>When there is a current overflow of the external device connected to the compatible port, USB bus power (DC5V) supply may be stopped for safety reasons. When this happens, disconnect an external device if some external devices are connected. After that, turn the power of the computer ON/OFF to restore the function. If this function can not be still used even if only one external device is connected, stop using the external device because its current is over the acceptable value of this computer.</p> <p>Some external devices may not be able to use the Sleep and Charge function. In this case, please try one or more of the following methods.</p> <ul style="list-style-type: none"> ■ Select another mode. ■ Turn OFF the computer while external devices are connected. ■ Connect external devices after turning OFF of the computer. <p>If this function can not be still used, change the setting to disable the function and stop using this function.</p>
<p>The battery depletes quickly even when I turned OFF the power of the computer.</p>	<p>If Sleep and Charge function is enabled, the computer's battery will discharge during hibernation or when the computer is turned off. Connect the AC adaptor to the computer or disable the Sleep and Charge function.</p>
<p>External devices connected to the compatible ports do not work when connected to a compatible port.</p>	<p>Some external devices may not work when connected to a compatible port if the Sleep and Charge function is enabled. Reconnect the external device after turning the computer ON.</p> <p>If the external device still does not work, connect device to an USB port that does not have the Sleep and Charge function-compatible icon () or change to disable the Sleep and Charge function.</p>

Problem	Procedure
The "USB Wakeup function" does not work.	<p>When Sleep and Charge function is enabled, the "USB WakeUp" function does not work for ports that support the Sleep and Charge function.</p> <p>In that case, use an USB port that does not have the USB Sleep and Charge function-compatible icon () or change to disable Sleep and Charge function.</p>

eSATA device

In addition to the information in this section, please also refer to the documentation supplied with your eSATA device.

Problem	Procedure
eSATA device does not work	<p>Remove the eSATA device from the computer and then reconnect it to a free port it in order to ensure it is firmly attached.</p> <p>A connected eSATA device may not be recognized if it is connected to the computer's eSATA/USB combo port while the computer is in Sleep Mode or Hibernation Mode. If this occurs, disconnect the eSATA device and then reconnect the device while the computer is turned on.</p> <p>Ensure that any required eSATA device drivers are properly installed - to achieve this you should refer to both the device documentation and the operating system documentation.</p> <p>If you are still unable to resolve the problem, contact TOSHIBA Support.</p>

Additional memory module

Please also refer to Chapter 3, [Operating Basics](#), for further information on installing and removing memory modules.

Problem	Procedure
<p>If there is a memory malfunction, the Power indicator will repeatedly flash (on for 0.5 seconds, off for 0.5 seconds) in the following patterns;</p> <p>If there is an error in only Slot A: orange twice, then green once.</p> <p>If there is an error in only Slot B: orange once, then green twice.</p> <p>If there are errors in both Slot A and Slot B: orange twice, then green twice.</p>	<p>In the event the Power indicator flashes when the computer is turned on, you should first check that the installed memory module(s) are compatible with the computer. If there is an error with a compatible memory module, there is a possibility the memory module is damaged.</p> <p>If you determine that an incompatible module has been installed, you should follow the steps as detailed below:</p> <ol style="list-style-type: none"> 1. Turn off the computer. 2. Disconnect the AC adaptor and all peripheral devices. 3. Remove the battery pack. 4. Remove the incompatible memory module. 5. Install the battery and/or connect the AC adaptor. 6. Turn on the computer. <p>If you are still unable to resolve the problem, contact TOSHIBA Support.</p>

Sound system

In addition to the information in this section, please also refer to the documentation supplied with your audio device.

Problem	Procedure
No sound is heard	<p>Adjust the volume.</p> <p>To increase the volume click the volume up button, and to decrease it click the volume down button.</p> <p>Check the software volume settings.</p> <p>Please check to see if Mute is turned to Off</p> <p>Check to make sure the headphone connection is secure.</p> <p>Check within the Windows Device Manager application to ensure the sound device is enabled and that the device is properly working.</p>

Problem	Procedure
Annoying sound is heard	<p>In this instance you may be experiencing feedback from either the internal microphone or an external microphone connected to the computer - please refer to Sound System in Chapter 3, Operating Basics for further information.</p> <p>Volume cannot be adjusted during Windows start up or shut down.</p> <p>If you are still unable to resolve the problem, contact TOSHIBA Support.</p>

External monitor

Please also refer to Chapter 3, [Operating Basics](#), and to the documentation supplied with your monitor for further information.

Problem	Procedure
Monitor does not turn on	<p>After confirming that the monitor's power switch is on, you should check the connections to make sure that the power cord/adaptor is firmly connected to the monitor and to a working power outlet.</p>

Problem	Procedure
No display	<p>Try adjusting the contrast and brightness controls on the external monitor.</p> <p>Press the FN + F5 hot key in order to change the display priority and ensure that it is not set for the internal display only.</p> <p>Check to see if the external monitor is connected.</p> <p>When the external monitor is set as the primary display device in extended desktop mode, it will not display when the computer wakes up from Sleep Mode if the external monitor has been disconnected while in Sleep Mode.</p> <p>To keep this from happening, do not disconnect the external monitor while the computer is in Sleep or Hibernation Mode.</p> <p>Remember to turn off the computer before disconnecting the external monitor.</p> <p>When the display panel and an external monitor are set to clone mode and they are turned off by the timer, the display panel or the external monitor may not display when turned on again.</p> <p>If this occurs, press FN + F5 to re-set the display panel and external monitor to clone mode.</p>
Display error occurs	<p>Check that the cable connecting the external monitor to the computer is firmly attached.</p> <p>If you are still unable to resolve the problem, contact TOSHIBA Support.</p>

LAN

Problem	Procedure
Cannot access LAN	<p>Check for a firm cable connection between the LAN jack and the LAN hub.</p>
Wake-up on LAN does not work	<p>Make sure the AC adaptor is connected. The Wake-up on LAN function consumes power even when the system is off.</p> <p>If problems persist, consult your LAN administrator.</p>

Wireless LAN

If the following procedures do not restore LAN access, consult your LAN administrator. For more information on wireless communication, refer to Chapter 3, *Operating Basics*.

Problem	Procedure
Cannot access Wireless LAN	<p>Make sure the computer's Wireless communication function is on.</p> <p>If problems persist, contact your LAN administrator.</p>

Bluetooth

For further information on Bluetooth wireless communication, please refer to Chapter 3, *Operating Basics*.

Problem	Procedure
Cannot access Bluetooth device	<p>Check to ensure the computer's Wireless Communication function is on.</p> <p>Check to ensure the Bluetooth Manager application is running on the computer and that power to the external Bluetooth device is turned on.</p> <p>Check to ensure that no optional Bluetooth Adaptor is installed in the computer - the built-in Bluetooth hardware cannot operate simultaneously with another Bluetooth controller.</p> <p>If you are still unable to resolve the problem, contact TOSHIBA Support.</p>

TOSHIBA support

If you require any additional help using your computer or if you are having problems operating the computer, you may need to contact TOSHIBA for additional technical assistance.

Before you call

Some problems you experience may be related to software or the operating system so it is important that you investigate other sources of assistance first. Before contacting TOSHIBA, try the following:

- Review troubleshooting sections in the documentation supplied with your software and/or peripheral devices.

- If a problem occurs when you are running software applications, consult the software documentation for troubleshooting suggestions and consider calling the software company's technical support department for assistance.
- Consult the reseller or dealer from where you purchased your computer and/or software - they are your best resource for current information and support.

TOSHIBA technical support

If you are still unable to solve the problem and suspect that it is hardware related, visit TOSHIBA technical support website <http://www.toshiba.co.jp/worldwide/>.

Appendix A

Specifications

This appendix summarizes the computer's technical specifications.

Physical Dimensions

Physical Dimensions shown below do not include parts that extend beyond the main body.

R850	379(w) x 252 (d) x 20.8~25.4 (h) millimeters (with 6 cell battery)
R840	341(w) x 239 (d) x 19.9~27.6 (h) millimeters (with 6 cell battery)
R830	316(w) x 227 (d) x 16.8~26.6 (h) millimeters (with 6 cell battery)

Environmental Requirements

Conditions	Ambient temperature	Relative humidity
Operating	5°C (41°F) to 35°C (95°F)	20% to 80% (noncondensing)
Non-operating	-20°C (-4°F) to 60°C (140°F)	10% to 90% (noncondensing)
Wet-bulb temperature	26°C maximum	
Conditions	Altitude (from sea level)	
Operating	-60 to 3,000 meters	
Non-operating	-60 to 10,000 meters maximum	

Power Requirements

AC adaptor	100-240V AC 50 or 60 Hz (cycles per second)
Computer	19V DC

External RGB monitor port pin assignment

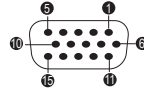

Pin	Signal Name	Description	I/O
1	CRV	Red Video Signal	O
2	CGV	Green Video Signal	O
3	CBV	Blue Video Signal	O
4	Reserved	Reserved	
5	GND	Ground	
6	GND	Ground	
7	GND	Ground	
8	GND	Ground	
9	+5V	Power Supply	
10	GND	Ground	
11	Reserved	Reserved	
12	SDA	Data Signal	I/O
13	HSYNC	Horizontal Sync Signal	O
14	VSYNC	Vertical Sync Signal	O
15	SCL	Data Clock Signal	O

I/O (I): Input to computer

I/O (O): Output from computer

Appendix B

AC Power Cord and Connectors

The power cord's AC input plug must be compatible with the various international AC power outlets and the cord must meet the standards for the country/region in which it is used. All cords must meet the following specifications:

Wire size:	Minimum 0.75 mm ²
Current rating:	Minimum 2.5 amperes

Certification agencies

China:	CQC		
U.S. and Canada:	UL listed and CSA certified No. 18 AWG, Type SVT or SPT-2		
Australia:	AS		
Japan:	DENANHO		
Europe:			
Austria:	OVE	Italy:	IMQ
Belgium:	CEBEC	The Netherlands:	KEMA
Denmark:	DEMKO	Norway:	NEMKO
Finland:	FIMKO	Sweden:	SEMKO
France:	LCIE	Switzerland:	SEV
Germany:	VDE	United Kingdom:	BSI

In Europe, two conductors power cord must be VDE type, H05VVH2-F or H03VVH2-F and for three conductors power cord must be VDE type, H05VV-F.

For the United States and Canada, two pin plug configuration must be a 2-15P (250V) or 1-15P (125V) and three pin plug configuration must be

6-15P (250V) or 5-15P (125V) as designated in the U.S. National Electrical code handbook and the Canadian Electrical Code Part II.

The following illustrations show the plug shapes for the U.S.A. and Canada, the United Kingdom, Australia, Europe and China.

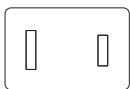
USA

UL approved

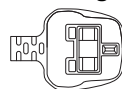
United Kingdom

BS approved

Australia

AS approved

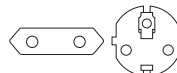
Europe

Approved by the appropriate agency

Canada

CSA approved

China

CCC approved

Appendix C

Legal Footnotes

This chapter states the Legal Footnotes information applicable to TOSHIBA computers.

Non-applicable Icons

Certain computer chassis are designed to accommodate all possible configurations for an entire product series. Therefore, please be aware that your selected model may not have all the features and specifications corresponding to all of the icons or switches shown on the computer chassis.

CPU

Central Processing Unit ("CPU") Performance Legal Footnotes.

CPU performance in your computer product may vary from specifications under the following conditions:

- use of certain external peripheral products
- use of battery power instead of AC power
- use of certain multimedia, computer generated graphics or video applications
- use of standard telephone lines or low speed network connections
- use of complex modeling software, such as high end computer aided design applications
- use of several applications or functionalities simultaneously
- use of computer in areas with low air pressure (high altitude >1,000 meters or >3,280 feet above sea level)
- use of computer at temperatures outside the range of 5°C to 30°C (41°F to 86°F) or >25°C (77°F) at high altitude (all temperature references are approximate and may vary depending on the specific computer model - please refer to your computer documentation or visit the TOSHIBA website at www.pcsupport.toshiba.com for details).

CPU performance may also vary from specifications due to design configuration.

Under some conditions, your computer product may automatically shut-down. This is a normal protective feature designed to reduce the risk of lost data or damage to the product when used outside recommended conditions. To avoid risk of lost data, always make back-up copies of data by periodically storing it on an external storage medium. For optimum performance, use your computer product only under recommended

conditions. Read additional restrictions in your product documentation. Contact TOSHIBA technical service and support, refer to [Troubleshooting](#) section in Chapter 6 Troubleshooting for more information.

64-Bit Computing

64-bit processors are designed to take advantage of 32 and 64 bit computing.

64-bit computing requires that the following hardware and software requirements are met:

- 64-bit Operating System
- 64-bit CPU, Chipset and BIOS (Basic Input/Output System)
- 64-bit Device drivers
- 64-bit applications

Certain device drivers and/or applications may not be compatible with a 64-bit CPU and therefore may not function properly.

Memory (Main System)

Part of the main system memory may be used by the graphics system for graphics performance and therefore reduce the amount of main system memory available for other computing activities. The amount of main system memory allocated to support graphics may vary depending on the graphics system, applications utilized, system memory size and other factors.

If your computer is configured with more than 3 GB memory, the memory might be displayed as approximately 3 GB only (depending on the computer's hardware specifications).

This is correct because the operating system usually displays the available memory instead of the physical memory (RAM) built into the computer.

Various system components (like the video adapter's GPU and PCI devices like Wireless LAN, etc.) require their own memory space. Since a 32-bit operating system cannot address more than 4 GB of memory, these system resources overlap the physical memory. It is a technical limitation that the overlapped memory is not available to the operating system. Even though some tools might display the actual physical memory built into your computer, the memory available to the operating system will still be approximately 3 GB only.

Computers configured with a 64-bit operating system can address 4 GB or more of system memory.

Battery Life

Battery life may vary considerably depending on product model, configuration, applications, power management settings and features utilized, as well as the natural performance variations produced by the design of individual components. Published battery life numbers are

achieved on select models and configurations tested by TOSHIBA at the time of publication. Recharge time varies depending on usage. Battery may not charge while computer is consuming full power.

After going through many charge and discharge cycles, the battery will lose its ability to perform at maximum capacity and will need to be replaced.

This is a normal phenomenon for all batteries. To purchase a new battery pack, see the accessories information that is shipped with your computer.

Hard Disk Drive (HDD) Capacity

1 Gigabyte (GB) means $10^9 = 1,000,000,000$ bytes using powers of 10. The computer operating system, however, reports storage capacity using powers of 2 for the definition of $1 \text{ GB} = 2^{30} = 1,073,741,824$ bytes, and therefore shows less storage capacity. Available storage capacity will also be less if the product includes one or more pre-installed operating systems, such as Microsoft Operating System and/or pre-installed software applications, or media content. Actual formatted capacity may vary.

LCD

Over a period of time, and depending on the usage of the computer, the brightness of the LCD screen will deteriorate. This is an intrinsic characteristic of LCD technology.

Maximum brightness is only available when operating in AC power mode. Screen will dim when the computer is operated on battery power and you may not be able to increase the brightness of the screen.

Graphics Processing Unit ("GPU")

Graphics Processing Unit ("GPU") performance may vary depending on product model, design configuration, applications, power management settings and features utilized. GPU performance is only optimized when operating in AC power mode and may decrease considerably when operating in battery power mode.

Total Available Graphics Memory is the total of, as applicable, Dedicated Video Memory, System Video Memory and Shared System Memory. Shared System Memory will vary depending on system memory size and other factors.

Wireless LAN

The transmission speed over the wireless LAN and the distance over which wireless LAN can reach may vary depending on surrounding electromagnetic environment, obstacles, access point design and configuration, and client design and software/hardware configurations.

The actual transmission speed will be lower than the theoretical maximum speed.

Copy Protection

Applicable copy protection standards included in certain media may prevent or limit recording or viewing of the media.

Appendix D

Information for Wireless Devices

Wireless LAN Interoperability

The Wireless LAN is compatible with other LAN systems Direct Sequence Spread Spectrum (DSSS) /Orthogonal Frequency Division Multiplexing (OFDM) radio technology, and is compliant to:

- The IEEE 802.11 Standard on Wireless LANs (Revision a/b/g/n or b/g/n), as defined and approved by the Institute of Electrical and Electronics Engineers.
- The Wireless Fidelity (**Wi-Fi**®) certification as defined by the **Wi-Fi Alliance**®.

The Wi-Fi CERTIFIED™ logo is a certification mark of the Wi-Fi Alliance®.

Bluetooth wireless technology Interoperability

Bluetooth™ Cards from TOSHIBA are designed to be interoperable with any product with Bluetooth wireless technology that is based on Frequency Hopping Spread Spectrum (FHSS) radio technology, and is compliant to:

- Bluetooth Specification Ver. 3.0+HS or Ver. 3.0 (depending on the model you purchased), as defined and approved by the Bluetooth Special Interest Group.
- Logo certification with Bluetooth wireless technology as defined by the Bluetooth Special interest Group.

CAUTION about Wireless Devices



The wireless devices have not completed verification of connection and operation with all devices which are using the Wireless LAN or Bluetooth radio technology.

Bluetooth and Wireless LAN devices operate within the same radio frequency range and may interfere with one another. If you use Bluetooth and Wireless LAN devices simultaneously, you may occasionally experience a less than optimal network performance or even lose your network connection.

If you should experience any such problem, immediately turn off either one of your Bluetooth or Wireless LAN.

Please visit <http://www.pc.support.global.toshiba.com>, if you have any questions about using Wireless LAN or Bluetooth Card from TOSHIBA.

In Europe visit <http://www.toshiba-europe.com/computers/tnt/bluetooth.htm>
 Your Bluetooth product is not compatible with devices using Bluetooth Version 1.0B specifications

Wireless Devices and your health

Wireless products, like other radio devices, emit radio frequency electromagnetic energy. The level of energy emitted by Wireless products however is far much less than the electromagnetic energy emitted by wireless devices like for example mobile phones.

Because Wireless products operate within the guidelines found in radio frequency safety standards and recommendations, TOSHIBA believes Wireless products is safe for use by consumers. These standards and recommendations reflect the consensus of the scientific community and result from deliberations of panels and committees of scientists who continually review and interpret the extensive research literature.

In some situations or environments, the use of Wireless products may be restricted by the proprietor of the building or responsible representatives of the organization. These situations may for example include:

- Using the Wireless products equipment on board of airplanes, or
- In any other environment where the risk of interference to other devices or services is perceived or identified as harmful.

If you are uncertain of the policy that applies on the use of wireless devices in a specific organization or environment (e.g. airports), you are encouraged to ask for authorization to use the Wireless device prior to turning on the equipment.

Radio Regulatory Information

The Wireless device is must be installed and used in strict accordance with the manufacturer's instructions as described in the user documentation that comes with the product. This product complies with the following radio frequency and safety standards.

Europe

Restrictions for Use of 2400.0-2483.5MHz Frequencies in Europe

France:	Outdoor use limited to 10mW e.i.r.p. within the band 2454-2483.5MHz	Military Radiolocation use.Refarming of the 2.4GHz band has been ongoing in recent years to allow current relaxed regulation Full implementation planned 2012.
----------------	---	--

Italy:	-	For private use, a general authorization is required if WAS/ RLAN's are used outside own premises. For public use, a general authorization is required.
Luxembourg:	Implemented	General authorization required for network and service supply.
Norway:	Implemented	This subsection does not apply for the geographical area within a radius of 20 km from the centre of Ny-Alesund.
Russian Federation:	-	Only for indoor applications.

Restrictions for Use of 5150-5350MHz Frequencies in Europe

Italy:	-	For private use, a general authorization is required if WAS/ RLAN's are used outside own premises.
Luxembourg:	Implemented	General authorization required for network and service supply.
Russian Federation:	Limited	e.i.r.p 100mW. Permitted to use only for indoor applications, closed industrial and warehouse areas, and on board aircraft. <ol style="list-style-type: none"> 1. Permitted to use for local networks of aircraft crew service communications on board aircraft in area of the airport and at all stages of flight. 2. Permitted to use for public wireless access local networks on board aircraft during a flight at the altitude not less than 3000m.

Restrictions for Use of 5470-5725MHz Frequencies in Europe

Italy:	-	For private use, a general authorization is required if WAS/ RLAN's are used outside own premises.
Luxembourg:	Implemented	General authorization required for network and service supply
Russian Federation:	Limited	e.i.r.p 100mW. Permitted to use only for indoor applications, closed industrial and warehouse areas, and on board aircraft. <ol style="list-style-type: none"> 1. Permitted to use for local networks of aircraft crew service communications on board aircraft in area of the airport and at all stages of flight. 2. Permitted to use for public wireless access local networks on board aircraft during a flight at the altitude not less than 3000m.

To remain in conformance with European spectrum usage laws for Wireless LAN operation, the above 2.4GHz and 5GHz channel limitations apply for outdoor usage. The user should use the wireless LAN utility to check the current channel of operation. If operation is occurring outside of the allowable frequencies for outdoor use, as listed above, the user must contact the applicable national spectrum regulator to request a license for outdoor operation.

Canada - Industry Canada (IC)

This device complies with RSS 210 of Industry Canada. Operation is subject to the following two conditions: (1) this device may not cause interference, and (2) this device must accept any interference, including interference that may cause undesired operation of this device.

The term "IC" before the equipment certification number only signifies that the Industry Canada technical specifications were met.

USA-Federal Communications Commission (FCC)

This equipment has been tested and found to comply with the limits for a Class B digital device, pursuant to Part 15 of FCC Rules. These limits are

designed to provide reasonable protection against harmful interference in a residential installation.

Refer to the FCC information section for the detailed information.

Caution: Exposure to Radio Frequency Radiation

The radiated output power of the Wireless device is far below the FCC radio frequency exposure limits. Nevertheless, the Wireless device shall be used in such a manner that the potential for human contact during normal operation is minimized.

In the usual operating configuration, the distance between the antenna and the user should not be less than 20cm. Please refer to the computer user's manual for the details regarding antenna location.

The installer of this radio equipment must ensure that the antenna is located or pointed such that it does not emit RF field in excess of Health Canada limits for the general population; consult Safety Code 6, obtainable from Health Canada's website www.hc-sc.gc.ca

Caution: Radio Frequency Interference Requirements

This device is restricted to indoor use due to its operation in the 5.15 to 5.25GHz frequency range.

Taiwan

Article 12	Without permission granted by the NCC, any company, enterprise, or user is not allowed to change frequency, enhance transmitting power or alter original characteristic as well as performance to an approved low power radio frequency devices.
Article 14	<p>The low power radio-frequency devices shall not influence aircraft security and interfere legal communications;</p> <p>If found, the user shall cease operating immediately until no interference is achieved.</p> <p>The said legal communications means radio communications is operated in compliance with the Telecommunications Act.</p> <p>The low power radio-frequency devices must be susceptible with the interference from legal communications or ISM radio wave radiated devices.</p>

Using this equipment in Japan

In Japan, the frequency bandwidth of 2,400MHz to 2,483.5MHz for second generation low-power data communication systems such as this equipment overlaps that of mobile object identification systems (premises radio station and specified low-power radio station).

1. Important notice

The frequency bandwidth of this equipment may operate within the same range as industrial devices, scientific devices, medical devices, microwave ovens, licensed radio stations and non-licensed specified low-power radio stations for mobile object identification systems (RFID) used in factory production lines (Other Radio Stations).

1. Before using this equipment, ensure that it does not interfere with any of the equipment listed above.
2. If this equipment causes RF interference to other radio stations, promptly change the frequency being used, change the location of use, or turn off the source of emissions.
3. Contact an authorized TOSHIBA service provider if you have problems with interference caused by this product to Other Radio Stations.

2. Indication for Wireless LAN

The indication shown below appears on this equipment.



1. 2.4 : This equipment uses a frequency of 2.4GHz.
2. DS : This equipment uses DS-SS modulation.
3. OF : This equipment uses OFDM modulation.
4. 4 : The interference range of this equipment is less than 40m.
5. ■ ■ ■ : This equipment uses a frequency bandwidth from 2,400MHz to 2,483.5MHz. It is possible to avoid the band of mobile object identification systems.

3. Indication for Bluetooth

The indication shown below appears on this equipment.



1. 2.4 : This equipment uses a frequency of 2.4 GHz.
2. FH : This equipment uses FH-SS modulation.
3. 1 : The interference range of this equipment is less than 10 m.

4.  : This equipment uses a frequency bandwidth from 2,400 MHz to 2,483.5 MHz. It is impossible to avoid the band of mobile object identification systems.

4. About the JEITA

5GHz Wireless LAN supports W52/W53/W56 Channel.

IEEE802.11b/g/n			
IEEE802.11a/n			
W52	W52	W53	W56

Device Authorization

This device obtains the Technical Regulation Conformity Certification and it belongs to the device class of radio equipment of low-power data communication system radio station stipulated in the Telecommunications Business Law of Japan.

- Atheros AR9285 Wireless Network Adapter b/g/n (b/g) Wireless LAN
The Name of the radio equipment: AR5B95
DSP Research, Inc.
Approval Number: D081038003
- Intel® Centrino® Advanced-N 6205 a/b/g/n (a/b/g) Wireless LAN
The Name of the radio equipment: 62205ANHMW
DSP Research, Inc.
Approval Number: D100944003
- Intel® Centrino® Wireless-N 1000 BGN b/g/n (b/g) Wireless LAN
The Name of the radio equipment: 112BNHMW
DSP Research, Inc.
Approval Number: D090380003
- Atheros AR938x Wireless Network Adapter a/b/g/n (a/b/g) Wireless LAN
The Name of the radio equipment: AR5BHB116
DSP Research, Inc.
Approval Number: D101136003
- Intel® Centrino® Advanced-N + WiMAX 6250 Wireless LAN and WiMAX
The Name of the radio equipment: 622ANXHMW
DSP Research, Inc.
Approval Number: D090856003

- Intel® Centrino® Wireless-N + WiMAX 6150 Wireless LAN and WiMAX
The Name of the radio equipment: 612BNXHMW
DSP Research, Inc.
Approval Number: D100898003
- Intel® Centrino® Advanced-N 6230 a/b/g/n (a/b/g) Wireless LAN and Bluetooth
The Name of the radio equipment: 62230ANHMW
DSP Research, Inc.
Approval Number: D101045003
- Atheros AR9002WB-1NG Wireless Network Adapter b/g/n (b/g) Wireless LAN and Bluetooth
The Name of the radio equipment: AR5B195
DSP Research, Inc.
Approval Number: D091014003
- BCM92070MD_REF Bluetooth
The Name of the radio equipment: BCM92070MD_REF
JAPAN APPROVALS INSTITUTE FOR TELECOMMUNICATIONS EQUIPMENT
Approval Number: D091274003

The following restrictions apply:

- Do not disassemble or modify the device.
- Do not install the embedded wireless module into other device.

When using the wireless device in any country or region, refer to the section Approved Countries/Regions for use in the online manual.

Radio approvals for wireless devices

Approved Countries/Regions for the Atheros® AR9285 Wireless Network Adapter b/g/n (b/g) Wireless LAN

This equipment is approved to the radio standard by the countries/regions in the following table.



Do not use this equipment in the countries/regions which are not listed in the table below.



- Available channel of Peer-to-peer connection by ad-hoc mode is Ch1-Ch11.
- Connection with an access point by the Infrastructure mode is Ch1-Ch13.

As of Feb. 2011

Albania	Argentina	Australia	Austria
Azerbaijan	Bahrain	Belgium	Bolivia
Bosnia and Herzegovina	Bulgaria	Cambodia	Canada
Chile	China	Colombia	Costa Rica
Croatia	Cyprus	Czech Republic	Denmark
Dominican Republic	Ecuador	Egypt	El Salvador
Estonia	Finland	France	Germany
Ghana	Greece	Guatemala	Hong Kong
Hungary	Iceland	India	Indonesia
Ireland	Italy	Japan	Jordan
Kazakhstan	Kenya	Kuwait	Kyrgyzstan
Latvia	Lebanon	Liechtenstein	Lithuania
Luxembourg	Macedonia	Malaysia	Malta
Mexico	Monaco	Montenegro	Netherlands
New Zealand	Norway	Oman	Pakistan
Panama	Papua New Guinea	Paraguay	Peru
Philippines	Poland	Portugal	Puerto Rico
Qatar	Romania	Saudi Arabia	Serbia
Singapore	Slovak Republic	Slovenia	South Africa
South Korea	Spain	Sri Lanka	Sweden
Switzerland	Taiwan	Thailand	Turkey
UAE	UK	Ukraine	Uruguay
USA	Venezuela	Vietnam	Yemen
Zimbabwe			

Approved Countries/Regions for the Intel® Centrino® Advanced-N 6205 a/b/g/n (a/b/g) Wireless LAN

This equipment is approved to the radio standard by the countries/regions in the following table.



Do not use this equipment in the countries/regions which are not listed in the table below.



- *An ad-hoc mode is not available in 802.11a and 802.11n mode.*
- *Available channel of Peer-to-peer connection by ad-hoc mode is Ch1-Ch11.*
- *Available channel at connection with an access point by the Infrastructure mode is Ch1-Ch13, Ch36, Ch40, Ch44, Ch48, Ch52, Ch56, Ch60, Ch64, Ch100, Ch104, Ch108, Ch112, Ch116, Ch120, Ch124, Ch128, Ch132, Ch136, Ch140, Ch149, Ch153, Ch157, Ch161, Ch165.*

As of Feb. 2011

Aruba	Australia	Austria	Azerbaijan
Bahrain	Belgium	Bermuda	Bolivia
Bosnia and Herzegovina	Brazil	Brunei	Bulgaria
Canada	Chile	China	Colombia
Costa Rica	Cyprus	Czech Republic	Denmark
Dominican Republic	Ecuador	El Salvador	Estonia
Finland	France	Georgia	Germany
Greece	Guatemala	Hong Kong	Hungary
Iceland	India	Indonesia	Ireland
Italy	Japan	Jordan	Kazakhstan
Kenya	Kuwait	Kyrgyzstan	Latvia
Liechtenstein	Lithuania	Luxemburg	Malawi
Malta	Mauritius	Mexico	Monaco
Montenegro	Nepal	Netherlands	New Zealand
Nicaragua	Nigeria	Norway	Oman
Pakistan	Panama	Papua New Guinea	Paraguay
Peru	Philippines	Poland	Portugal
Puerto Rico	Qatar	Romania	Rwanda
Saudi Arabia	Serbia	Slovakia	Slovenia

South Korea	Spain	Sri Lanka	Sweden
Switzerland	Tanzania	Thailand	Trinidad and Tobago
Turkey	UK	Uruguay	USA
Zimbabwe			

Approved Countries/Regions for the Intel® Centrino® Wireless-N 1000 BGN (b/g) Wireless LAN

This equipment is approved to the radio standard by the countries/regions in the following table.



Do not use this equipment in the countries/regions which are not listed in the table below.



- *An ad-hoc mode is not available in 802.11n mode.*
- *Available channel of Peer-to-peer connection by ad-hoc mode is Ch1-Ch11.*
- *Connection with an access point by the Infrastructure mode is Ch1-Ch13.*

As of Feb. 2011

Argentina	Australia	Austria	Azerbaijan
Bahamas	Bahrain	Belgium	Bosnia and Herzegovina
Brazil	Brunei	Bulgaria	Cambodia
Canada	Chile	China	Costa Rica
Croatia	Cyprus	Czech Republic	Denmark
Dominican Republic	Ecuador	Egypt	Estonia
Finland	France	Germany	Ghana
Greece	Honduras	Hong Kong	Hungary
Iceland	India	Indonesia	Ireland
Italy	Jamaica	Japan	Jordan
Kenya	Kuwait	Latvia	Lebanon
Liechtenstein	Lithuania	Luxemburg	Malawi

Malaysia	Malta	Mexico	Monaco
Montenegro	Nepal	Netherlands	New Zealand
Nicaragua	Norway	Oman	Pakistan
Papua New Guinea	Paraguay	Peru	Philippines
Poland	Portugal	Qatar	Romania
Rwanda	Saudi Arabia	Serbia	Singapore
Slovakia	Slovenia	South Africa	South Korea
Spain	Sweden	Switzerland	Taiwan
Tanzania	Thailand	Tunisia	UAE
UK	Ukraine	Uruguay	USA
Venezuela	Vietnam	Zimbabwe	

Approved Countries/Regions for the Atheros AR938x Wireless Network Adapter a/b/g/n (a/b/g) Wireless LAN

This equipment is approved to the radio standard by the countries/regions in the following table.



Do not use this equipment in the countries/regions which are not listed in the table below.



- *An ad-hoc mode is not available in 802.11a and 802.11n mode.*
- *Available channel of Peer-to-peer connection by ad-hoc mode is Ch1-Ch11.*
- *Available channel at connection with an access point by the Infrastructure mode is Ch1-Ch13, Ch36, Ch40, Ch44, Ch48, Ch52, Ch56, Ch60, Ch64, Ch100, Ch104, Ch108, Ch112, Ch116, Ch120, Ch124, Ch128, Ch132, Ch136, Ch140, Ch149, Ch153, Ch157, Ch161, Ch165.*

As of Feb. 2011

Argentina	Australia	Austria	Azerbaijan
Bahrain	Belgium	Bolivia	Bosnia and Herzegovina
Brazil	Bulgaria	Cambodia	Canada
Chile	China	Costa Rica	Croatia

Cyprus	Czech Republic	Denmark	Dominican Republic
Ecuador	Estonia	Finland	France
Germany	Ghana	Greece	Hong Kong
Hungary	Iceland	India	Indonesia
Ireland	Italy	Japan	Jordan
Latvia	Lebanon	Liechtenstein	Lithuania
Luxembourg	Malaysia	Malta	Montenegro
Netherlands	New Zealand	Nicaragua	Norway
Papua New Guinea	Peru	Philippines	Poland
Portugal	Qatar	Romania	Rwanda
Serbia	Singapore	Slovakia	Slovenia
South Korea	Spain	Sweden	Switzerland
Taiwan	Tanzania	Thailand	Tunisia
U.K.	UAE	Ukraine	Uruguay
USA	Venezuela	Vietnam	Zimbabwe

Approved Countries/Regions for the Intel® Centrino® Advanced-N + WiMAX 6250 Wireless LAN and WiMAX

This equipment is approved to the radio standard by the countries/regions in the following table.



Do not use this equipment in the countries/regions which are not listed in the table below.



- An ad-hoc mode is not available in 802.11a and 802.11n mode.
- Available channel of Peer-to-peer connection by ad-hoc mode is Ch1-Ch11.
- Available channel at connection with an access point by the Infrastructure mode is Ch1-Ch13, Ch36, Ch40, Ch44, Ch48, Ch52, Ch56, Ch60, Ch64, Ch100, Ch104, Ch108, Ch112, Ch116, Ch120, Ch124, Ch128, Ch132, Ch136, Ch140, Ch149, Ch153, Ch157, Ch161, Ch165.

As of Feb. 2011

Japan

USA

Approved Countries/Regions for the Intel® Centrino® Wireless-N + WiMAX 6150 Wireless LAN and WiMAX

This equipment is approved to the radio standard by the countries/regions in the following table.



Do not use this equipment in the countries/regions which are not listed in the table below.



- *An ad-hoc mode is not available in 802.11n mode.*
- *Available channel of Peer-to-peer connection by ad-hoc mode is Ch1-Ch11.*
- *Connection with an access point by the Infrastructure mode is Ch1-Ch13.*

As of Feb. 2011

Japan

USA

Approved Countries/Regions for the Intel® Centrino® Advanced-N 6230 a/b/g/n (a/b/g) Wireless LAN and Bluetooth

This equipment is approved to the radio standard by the countries/regions in the following table.



Do not use this equipment in the countries/regions which are not listed in the table below.



- *An ad-hoc mode is not available in 802.11a and 802.11n mode*
- *Available channel of Peer-to-peer connection by ad-hoc mode is Ch1-Ch11.*
- *Available channel at connection with an access point by the Infrastructure mode is Ch1-Ch13, Ch36, Ch40, Ch44, Ch48, Ch52, Ch56, Ch60, Ch64, Ch100, Ch104, Ch108, Ch112, Ch116, Ch120, Ch124, Ch128, Ch132, Ch136, Ch140, Ch149, Ch153, Ch157, Ch161, Ch165.*

As of Feb. 2011

Australia

Austria

Austria

Bahamas

Bahrain	Bangladesh	Barbados	Belgium
Bermuda	Bolivia	Bosnia and Herzegovina	Brazil
Bulgaria	Canada	Chile	China
Colombia	Costa Rica	Cyprus	Czech Republic
Denmark	El Salvador	Estonia	Finland
France	Georgia	Germany	Greece
Guatemala	Hong Kong	Hungary	Iceland
Indonesia	Ireland	Italy	Japan
Jordan	Kazakhstan	Kyrgyzstan	Latvia
Liechtenstein	Lithuania	Luxemburg	Malta
Mexico	Montenegro	Netherlands	New Zealand
Norway	Panama	Philippines	Poland
Portugal	Puerto Rico	Qatar	Romania
Romania	Saudi Arabia	Slovakia	Slovenia
South Korea	Spain	Sri Lanka	Sweden
Switzerland	Taiwan	Thailand	Turkey
UK	Uruguay	USA	

Approved Countries/Regions for the Atheros AR9002WB-1NG Wireless Network Adapter b/g/n (b/g) Wireless LAN and Bluetooth

This equipment is approved to the radio standard by the countries/regions in the following table.



Do not use this equipment in the countries/regions which are not listed in the table below.



- Available channel of Peer-to-peer connection by ad-hoc mode is Ch1-Ch11.
- Connection with an access point by the Infrastructure mode is Ch1-Ch13.

As of Feb. 2011

Albania	Algeria	Angola	Argentina
---------	---------	--------	-----------

Australia	Austria	Azerbaijan	Bahrain
Bangladesh	Belarus	Belgium	Bolivia
Bosnia and Herzegovina	Botswana	Brazil	Bulgaria
Burkina Faso	Burundi	Cambodia	Cameroon
Canada	Central African Republic	Chile	China
Colombia	Comoros	Costa Rica	Croatia
Cyprus	Czech Republic	Democratic Republic of the Congo	Denmark
Dominican Republic	Ecuador	Egypt	El Salvador
Estonia	Finland	France	Georgia
Germany	Ghana	Greece	Guatemala
Honduras	Hong Kong	Hungary	Iceland
India	Indonesia	Ireland	Israel
Italy	Ivory Coast	Japan	Jordan
Kazakhstan	Kenya	Kuwait	Kyrgyzstan
Latvia	Lebanon	Lesotho	Liberia
Libya	Liechtenstein	Lithuania	Luxembourg
Madagascar	Malawi	Malaysia	Malta
Mauritius	Mexico	Monaco	Montenegro
Morocco	Mozambique	Namibia	Netherlands
New Zealand	Nicaragua	Niger	Nigeria
Norway	Oman	Pakistan	Panama
Paraguay	Peru	Philippines	Poland
Portugal	Puerto Rico	Qatar	Republic of Chad
Republic of Djibouti	Republic of The Gambia	Reunion	Romania
Rwanda	Saudi Arabia	Senegal	Serbia
Sierra Leone	Singapore	Slovak Republic	Slovenia
South Africa	South Korea	Spain	Sri Lanka

Swaziland	Sweden	Switzerland	Taiwan
Tajikistan	Thailand	Togo	Tunisia
Turkey	Turkmenista	UAE	UK
Ukraine	Uruguay	USA	Venezuela
Vietnam	Yemen	Zambia	Zimbabwe

Approved Countries/Regions for BCM92070MD_REF Bluetooth

This equipment is approved to the radio standard by the countries/regions in the following table.



Do not use this equipment in the countries/regions which are not listed in the table below.

As of Feb. 2011

Albania	Argentina	Australia	Austria
Azerbaijan	Bahrain	Belgium	Bolivia
Bosnia and Herzegovina	Bulgaria	Cambodia	Canada
Chile	China	Colombia	Costa Rica
Croatia	Cyprus	Czech Republic	Denmark
Dominican Republic	Ecuador	Egypt	El Salvador
Estonia	Finland	France	Germany
Ghana	Greece	Guatemala	Honduras
Hong Kong	Hungary	Iceland	India
Indonesia	Ireland	Italy	Japan
Jordan	Kazakhstan	Kenya	Kuwait
Kyrgyzstan	Latvia	Lebanon	Lesotho
Liechtenstein	Lithuania	Luxembourg	Malawi
Malaysia	Malta	Mexico	Monaco
Montenegro	Mozambique	Namibia	Netherlands
New Zealand	Nicaragua	Nigeria	Norway

Oman	Pakistan	Panama	Papua New Guinea
Paraguay	Peru	Philippines	Poland
Portugal	Puerto Rico	Qatar	Romania
Russia	Saudi Arabia	Senegal	Serbia
Singapore	Slovak Republic	Slovenia	South Africa
South Korea	Spain	Sri Lanka	Sweden
Switzerland	Taiwan	Thailand	Turkey
UAE	UK	Ukraine	Uruguay
USA	Venezuela	Vietnam	Zimbabwe

Index

A

AC adaptor
 additional 3-53
 connecting 1-3
 DC IN 19V jack 2-3, 2-14,
 2-25

ASCII characters 3-8

B

Battery
 extending life 5-8
 monitoring capacity 5-7
 real time clock 2-35, 5-4
 save mode 4-8
 types 5-3

Battery indicator

Battery pack
 additional 5-1
 replacing 5-9

Bluetooth
 Bluetooth Stack for
 Windows by Toshiba 4-3
 problems 6-18

Boot Priority 4-19

C

Cleaning the computer 3-55

Cooling vents 2-3, 2-8, 2-14,
2-19, 2-25, 2-30

D

DC IN
 indicator 2-2, 2-12, 2-24

DC IN indicator 5-3

Display
 automatic power off 4-7
 brightness down 3-5
 brightness up 3-5
 hinges 2-12, 2-22, 2-32
 opening 1-5
 screen 2-9, 2-20, 2-31

Display controller 2-35

Documentation list 1-1

Dual Pointing Device
 AccuPoint 3-1
 Touch Pad control
 buttons 3-1
 Touch Pad 3-1, 6-10

E

Equipment checklist 1-1

eSATA device
 problems

ExpressCard
 inserting 3-36
 removing 3-36

External monitor
 problems 6-16

External RGB monitor 2-14,
2-25

F

Fingerprint Sensor
problems 6-12
using 3-8

FN + 1 (reduce) 3-6

FN + 2 (enlarge) 3-6

FN + 3 (Volume down) 3-6

FN + 4 (Volume up) 3-6

FN + Enter 3-4

FN + ESC (Mute)

FN + F1 (Lock)

FN + F10 (Arrow mode) 3-4

FN + F11 (Numeric mode) 3-4

FN + F12 (ScrLock) 3-4

FN + F2 (Power Plan)

FN + F3 (Sleep)

FN + F4 (Hibernate)

FN + F5 (Output)

FN + F6 (Brightness Down)

FN + F7 (Brightness Up)

FN + F8 (Wireless)

FN + F9 (Touch Pad)

FN + space (Zoom)

Function keys 3-3

G

Graphics controller 2-36

H

Hard disk drive
automatic power off 4-7

HDD Protection 4-23

HDMI out port 2-4, 2-14, 2-26

Heat dispersal 3-56, 4-8

Hibernation Mode 1-9, 4-8

Hot keys

Brightness Down 3-5

Brightness Up 3-5

Hibernate 3-5

Lock 3-5

Mute 3-5

Output 3-5

Power Plan 3-5

Sleep 3-5

Touch Pad 3-6

Wireless 3-5

Zoom 3-6

HW Setup

accessing 4-17

Boot 4-19

display 4-18

general 4-17

keyboard 4-20

LAN 4-20

SATA 4-22

USB 4-21

window 4-17

K

Keyboard

FN Sticky key 3-6

- Function keys F1...F12 3-3
 - Hot key functions 3-4
 - problems 6-7
 - Windows special keys 3-6
- L**
- Keypad overlay
 - Arrow mode 3-7
 - Numeric mode 3-7
 - temporarily using normal keyboard (overlay on) 3-7
 - temporarily using overlay (overlay off) 3-7
 - turning on the overlays 3-7
 - LAN
 - cable types 3-34
 - connecting 3-34
 - problems 6-17
- M**
- Media care
 - Card care 3-40
 - Memory card care 3-40
 - Memory
 - additional 3-53
 - installing 3-43
 - problems 6-14
 - removing 3-45
 - memory media card
 - inserting 3-41
 - removing 3-41
 - Memory media slot 3-38
 - Moving the computer 3-55
 - MultiMediaCard
 - removing 3-41
- O**
- Optical disc drive
 - using writing
- P**
- Password
 - power on 4-7
 - Starting the computer by 4-16
 - Supervisor 4-16
 - user 4-15
 - Pointing Device
 - Touch Pad 2-11, 2-22, 2-33
 - Power
 - conditions 5-1
 - Hibernation Mode 1-9
 - panel on/off 4-8, 5-11
 - Shut Down mode (Boot Mode) 1-7
 - Sleep Mode 1-8
 - System Auto Off 5-11
 - turning off 1-7
 - turning on 1-6
 - Problems
 - AC power 6-5
 - Additional memory module 6-14
 - Analyzing the problem 6-2
 - Battery 6-5
 - Bluetooth 6-18
 - Dual Pointing device 6-10
 - eSATA device 6-14
 - External monitor 6-16
 - Fingerprint Sensor 6-12
 - Hard disc drive 6-8, 6-9

Hardware and system checklist 6-4	ENTER 3-4
Internal display panel 6-7	ScrLock 3-4
Keyboard 6-7	
LAN 6-17	Sound system problems 6-15
Memory Media Card 6-9	
Optical Disc Drive 6-8	
Overheating power down 6-4	
Power 6-4	
Real Time Clock 6-7	
Smart Card 6-9	
Sound system 6-15	
TOSHIBA support 6-18	
Touch Pad 6-10	
USB device 6-12	
USB mouse 6-11	
Wireless LAN 6-18	
R	T
	TOSHIBA Assist 4-3
	TOSHIBA ConfigFree 4-3
	TOSHIBA Disc Creator 3-22, 4-4
	TOSHIBA DVD-RAM Utility 4-4
	TOSHIBA HDD/SSD Alert Utility 4-4
	TOSHIBA PC Diagnostic Tool 4-1
	U
Recovery hard disk drive 4-28	USB device problems 6-12
Recovery Media 4-27	
Restarting the computer 1-11	
S	V
SD/SDHC/SDXC Card formatting 3-39 note 3-39	Video mode 3-55
	Video RAM 2-35
Security lock 3-52	
Sleep Mode setting 1-8	
System automatic 4-7	
	W
Smart Card inserting 3-37 problems 6-10 removing 3-38	Web Camera 2-10, 2-21, 2-32
	Wireless communication indicator 2-3, 2-13, 2-24
Soft keys	Wireless LAN problems 6-18

Wireless WAN
indicator 2-3, 2-13, 2-24

Free Manuals Download Website

<http://myh66.com>

<http://usermanuals.us>

<http://www.somanuals.com>

<http://www.4manuals.cc>

<http://www.manual-lib.com>

<http://www.404manual.com>

<http://www.luxmanual.com>

<http://aubethermostatmanual.com>

Golf course search by state

<http://golfingnear.com>

Email search by domain

<http://emailbydomain.com>

Auto manuals search

<http://auto.somanuals.com>

TV manuals search

<http://tv.somanuals.com>