

**TOSHIBA**

Leading Innovation >>>

# User's Manual

**Satellite L40-A/L40t-A/L40D-A/  
L40Dt-A**

**Satellite S40-A/S40t-A/S40D-A/  
S40Dt-A**

**Satellite P40-A/P40t-A**

**Series**

---

# Table of Contents

<i>Chapter 1</i>	<b>TOSHIBA Legal, Regulatory and Safety</b>	
	Copyright, Disclaimer and Trademarks .....	1-1
	Regulatory Information .....	1-2
	Video Standard Notice .....	1-7
	OpenSSL Toolkit License Issues .....	1-7
	ENERGY STAR® Program .....	1-10
	Disposing of the computer and the computer's batteries .....	1-11
	Optical disc drive safety instructions .....	1-11
	General Precautions .....	1-12
	Safety Icons .....	1-15
<i>Chapter 2</i>	<b>Getting Started</b>	
	Equipment checklist .....	2-1
	Conventions .....	2-1
	Using your computer for the first time .....	2-2
	Turning off the power .....	2-8
<i>Chapter 3</i>	<b>The Grand Tour</b>	
	Front with the display closed .....	3-1
	Left side .....	3-2
	Right side .....	3-3
	Back .....	3-5
	Underside .....	3-5
	Front with the display open .....	3-6
	Internal Hardware Components .....	3-9
	Power Condition Descriptions .....	3-13
<i>Chapter 4</i>	<b>Operating Basics</b>	
	Using the Touch Screen .....	4-1
	Using the Touch Pad .....	4-2
	The Keyboard .....	4-3
	Optical disc drives .....	4-5
	TOSHIBA VIDEO PLAYER .....	4-12
	TOSHIBA Blu-ray Disc Player .....	4-14
	3D Playback on an External 3D Device .....	4-16
	Battery .....	4-21
	LAN .....	4-24
	Additional memory module .....	4-26

Memory media .....	4-30
External Display .....	4-34
Security lock .....	4-37
Optional TOSHIBA Accessories .....	4-37
Sound System and Video mode .....	4-38

*Chapter 5*

**Utilities and Advanced Usage**

Utilities and Applications .....	5-1
Special features .....	5-5
TOSHIBA Password Utility .....	5-7
TOSHIBA System Settings .....	5-10
USB Charge .....	5-11
System ON CDP Charge .....	5-13
Sleep and Music .....	5-13
TOSHIBA Media Player by sMedio TrueLink+ .....	5-14
Using CyberLink MediaShow 6 for TOSHIBA .....	5-16
TOSHIBA PC Health Monitor .....	5-18
AirGet for TOSHIBA .....	5-19
Using the Hard Disk Drive (HDD) Protection .....	5-21
System Recovery .....	5-23

*Chapter 6*

**Troubleshooting**

Problem solving process .....	6-1
Hardware and system checklist .....	6-4
TOSHIBA support .....	6-14

*Chapter 7*

**Appendix**

Specifications .....	7-1
AC Power Cord and Connectors .....	7-2
Information for Wireless Devices .....	7-4
Legal Footnotes .....	7-13
Glossary .....	7-16

**Index**



---

# Chapter 1

## TOSHIBA Legal, Regulatory and Safety

This chapter states the Legal, regulatory and safety information applicable to TOSHIBA computers.

### Copyright, Disclaimer and Trademarks

#### Copyright

© 2013 by TOSHIBA Corporation. All rights reserved. Under the copyright laws, this manual cannot be reproduced in any form without the prior written permission of TOSHIBA. No patent liability is assumed, with respect to the use of the information contained herein.

First edition March 2013

Copyright authority for music, movies, computer programs, databases and other intellectual property covered by copyright laws belongs to the author or to the copyright owner. Copyrighted material can be reproduced only for personal use or use within the home. Any other use beyond that stipulated above (including conversion to digital format, alteration, transfer of copied material and distribution on a network) without the permission of the copyright owner is a violation of copyright or author's rights and is subject to civil damages or criminal action. Please comply with copyright laws in making any reproduction from this manual.

#### Disclaimer

This manual has been validated and reviewed for accuracy. The instructions and descriptions it contains are accurate for your computer at the time of this manual's production. However, succeeding computers and manuals are subject to change without notice. TOSHIBA assumes no liability for damages incurred directly or indirectly from errors, omissions or discrepancies between the computer and the manual.

#### Trademarks

Intel, Intel SpeedStep, Intel Core and Centrino are trademarks or registered trademarks of Intel Corporation.

AMD, the AMD Arrow logo, PowerPlay, Vari-Bright and combinations thereof are trademarks of Advanced Micro Devices, Inc.

---

Windows, Microsoft and Windows logo are registered trademarks of Microsoft Corporation.

The Bluetooth® word mark and logos are registered trademarks owned by Bluetooth SIG, Inc. and any use of such marks by Toshiba Corporation and its affiliates is under license.

The terms HDMI and HDMI High-Definition Multimedia Interface, and the HDMI Logo are trademarks or registered trademarks of HDMI Licensing LLC in the United States and other countries.

sMedio, Airget and sMedio TrueLink+ are trademarks or registered trademarks of sMedio, Inc.

TouchPad is a trademark of Synaptics, Inc.

Secure Digital and SD are trademarks of SD Card Association.

MultiMediaCard and MMC are trademarks of MultiMediaCard Association.

Blu-ray Disc™, Blu-ray™, BDXL™ and the logos are trademarks of the Blu-ray Disc Association.

QUALCOMM is a trademark of Qualcomm Incorporated, registered in the United States and other countries. ATHEROS is a trademark of Qualcomm Atheros, Inc., registered in the United States and other countries.

DTS, the Symbol, & DTS and the Symbol together are registered trademarks and DTS Studio Sound is a trademark of DTS, Inc. © DTS, Inc. All Rights Reserved.

Realtek is a registered trademark of Realtek Semiconductor Corporation.

All other product names and service names in this manual may be trademarks or registered trademarks of their respective companies.

## Regulatory Information

### FCC information

#### ***FCC notice "Declaration of Conformity Information"***

This equipment has been tested and found to comply with the limits for a Class B digital device, pursuant to part 15 of the FCC rules. These limits are designed to provide reasonable protection against harmful interference in a residential installation. This equipment generates, uses and can radiate radio frequency energy and, if not installed and used in accordance with the instructions, may cause harmful interference to radio communications. However, there is no guarantee that interference will not occur in a particular installation. If this equipment does cause harmful interference to radio or television reception, which can be determined by turning the equipment off and on, the user is encouraged to try to correct the interference by one or more of the following measures:

- Reorient or relocate the receiving antenna.
- Increase the separation between the equipment and receiver.

- Connect the equipment into an outlet on a circuit different from that to which the receiver is connected.
- Consult the dealer or an experienced radio/TV technician for help.



*Only peripherals complying with the FCC class B limits may be attached to this equipment. Operation with non-compliant peripherals or peripherals not recommended by TOSHIBA is likely to result in interference to radio and TV reception. Shielded cables must be used between the external devices and the computer's External RGB monitor port, Universal Serial Bus (USB 2.0 and 3.0) ports, HDMI port and microphone jack. Changes or modifications made to this equipment, not expressly approved by TOSHIBA or parties authorized by TOSHIBA could void the user's authority to operate the equipment.*

### ***FCC conditions***

This device complies with part 15 of the FCC Rules. Operation is subject to the following two conditions:

1. This device may not cause harmful interference.
2. This device must accept any interference received, including interference that may cause undesired operation.

### ***Contact***

**Address:** TOSHIBA America Information Systems, Inc.  
9740 Irvine Boulevard  
Irvine, California 92618-1697

**Telephone:** (949) 583-3000



*This information is only applicable for the countries/regions where it is required.*

## **EU Declaration of Conformity**



This product is carrying the CE-Mark in accordance with the related European Directives. Responsible for CE-Marking is TOSHIBA EUROPE GMBH, Hammfelddamm 8, 41460 Neuss, Germany. The complete and official EU Declaration of Conformity can be found on TOSHIBA's web site <http://epps.toshiba-teg.com> on the Internet.

---

## ***CE compliance***

This product is labeled with the CE Mark in accordance with the applicable European Directives, notably RoHS Directive 2011/65/EU, Radio Equipment and Telecommunications Terminal Directive 1999/5/EC, Ecodesign Directive 2009/125/EC (ErP) and the related implementing measures.

This product and the original options are designed to observe the related EMC (Electromagnetic Compatibility) and safety standards. However, TOSHIBA cannot guarantee that this product still observes these EMC standards if options or cables not produced by TOSHIBA are connected or implemented. In this case the persons who have connected/implemented those options/cables have to provide assurance that the system (PC plus options/cables) still fulfils the required standards. To avoid general EMC problems, the following guidance should be noted:

- Only CE marked options should be connected/implemented
- Only best shielded cables should be connected

## ***Working environment***

This product was designed to fulfil the EMC (Electromagnetic Compatibility) requirements to be observed for so-called “Residential, commercial and light industry environments”. TOSHIBA do not approve the use of this product in working environments other than the above mentioned “Residential, commercial and light industry environments”.

For example, the following environments are not approved:

- Industrial Environments (e.g. environments where a mains voltage of 380 V three-phase is used)
- Medical Environments
- Automotive Environments
- Aircraft Environments

Any consequences resulting from the use of this product in working environments that are not approved are not the responsibility of TOSHIBA.

The consequences of the use of this product in non-approved working environments may be:

- Interference with other devices or machines in the near surrounding area.
- Malfunction of, or data loss from, this product caused by disturbances generated by other devices or machines in the near surrounding area.

Therefore TOSHIBA strongly recommend that the electromagnetic compatibility of this product should be suitably tested in all non-approved working environments before use. In the case of automobiles or aircraft, the manufacturer or airline respectively should be asked for permission before use of this product.

Furthermore, for general safety reasons, the use of this product in environments with explosive atmospheres is not permitted.



---

## VCCI Class B Information

この装置は、クラスB情報技術装置です。この装置は、家庭環境で使用することを目的としていますが、この装置がラジオやテレビジョン受信機に近接して使用されると、受信障害を引き起こすことがあります。取扱説明書に従って正しい取り扱いをしてください。

VCCI-B

## Canadian regulatory information (Canada only)

This digital apparatus does not exceed the Class B limits for radio noise emissions from digital apparatus as set out in the Radio Interference Regulation of the Canadian Department of Communications.

Note that Canadian Department of Communications (DOC) regulations provide, that changes or modifications not expressly approved by TOSHIBA Corporation could void your authority to operate this equipment.

This Class B digital apparatus meets all requirements of the Canadian Interference-Causing Equipment Regulations.

Cet appareil numérique de la class B respecte toutes les exgences du Règlement sur le matériel brouilleur du Canada.

## Following information is only valid for EU-member States:

### *Disposal of products*



The crossed out wheeled dust bin symbol indicates that products must be collected and disposed of separately from household waste. Integrated batteries and accumulators can be disposed of with the product. They will be separated at the recycling centres.

The black bar indicates that the product was placed on the market after August 13, 2005.

By participating in separate collection of products and batteries, you will help to assure the proper disposal of products and batteries and thus help to prevent potential negative consequences for the environment and human health.

For more detailed information about the collection and recycling programmes available in your country, please visit our website (<http://eu.computers.toshiba-europe.com>) or contact your local city office or the shop where you purchased the product.

## Disposal of batteries and/or accumulators



Pb, Hg, Cd

The crossed out wheeled dust bin symbol indicates that batteries and/or accumulators must be collected and disposed of separately from household waste.

If the battery or accumulator contains more than the specified values of lead (Pb), mercury (Hg), and/or cadmium (Cd) defined in the Battery Directive (2006/66/EC), then the chemical symbols for lead (Pb), mercury (Hg) and/or cadmium (Cd) will appear below the crossed out wheeled dust bin symbol.

By participating in separate collection of batteries, you will help to assure the proper disposal of products and batteries and thus help to prevent potential negative consequences for the environment and human health.

For more detailed information about the collection and recycling programmes available in your country, please visit our website (<http://eu.computers.toshiba-europe.com>) or contact your local city office or the shop where you purchased the product.



*These symbols may not stick depending on the country and region where you purchased.*

## REACH - Compliance Statement

The new European Union (EU) chemical regulation, REACH (Registration, Evaluation, Authorization and Restriction of Chemicals), entered into force on 1 June 2007. TOSHIBA will meet all REACH requirements and is committed to provide our customers with information about the chemical substances in our products according to REACH regulation.

Please consult the following website [www.toshiba-europe.com/computers/info/reach](http://www.toshiba-europe.com/computers/info/reach) for information about the presence in our articles of substances included on the candidate list according to article 59(1) of Regulation (EC) No 1907/2006 („REACH“) in a concentration above 0.1 % weight by weight.

## Following information is only for Turkey:

- Compliant with EEE Regulations: TOSHIBA meets all requirements of Turkish regulation 26891 “Restriction of the use of certain hazardous substances in electrical and electronic equipment”.
- The number of possible pixel failures of your display is defined according to ISO 9241-307 standards. If the number of pixel failures is less than this standard, they will not be counted as defect or failure.

- Battery is a consumption product, since the battery time depends on the usage of your computer. If the battery can not be charged at all, then it is a defect or failure. The changes in battery time is not a defect or failure.

## Following information is only for India:



The use of this symbol indicates that this product may not be treated as household waste.

By ensuring this product is disposed of correctly, you will help prevent potential negative consequences for the environment and human health, which could otherwise be caused by inappropriate waste handling of this product.

For more detailed information about recycling of this product, please visit our website (<http://www.toshiba-india.com>) or contact call center (1800-200-8674).



*These symbols may not stick depending on the country and region where you purchased.*

## Video Standard Notice

THIS PRODUCT IS LICENSED UNDER THE AVC, THE VC-1 AND MPEG-4 VISUAL PATENT PORTFOLIO LICENSE FOR THE PERSONAL AND NON-COMMERCIAL USE OF A CONSUMER FOR (I) ENCODING VIDEO IN COMPLIANCE WITH THE ABOVE STANDARDS ("VIDEO") AND/OR (II) DECODING AVC, VC-1 AND MPEG-4 VIDEO THAT WAS ENCODED BY A CONSUMER ENGAGED IN A PERSONAL AND NONCOMMERCIAL ACTIVITY AND/OR WAS OBTAINED FROM A VIDEO PROVIDER LICENSED BY MPEG LA TO PROVIDE SUCH VIDEO. NO LICENSE IS GRANTED OR SHALL BE IMPLIED FOR ANY OTHER USE. ADDITIONAL INFORMATION INCLUDING THAT RELATING TO PROMOTIONAL, INTERNAL AND COMMERCIAL USES AND LICENSING MAY BE OBTAINED FROM MPEG LA, L.L.C. SEE [HTTP://WWW.MPEGLA.COM](http://www.mpegla.com).

## OpenSSL Toolkit License Issues

LICENSE ISSUES

=====

The OpenSSL toolkit stays under a dual license, i.e. both the conditions of the OpenSSL License and the original SSLeay license apply to the toolkit. See below for the actual license texts. Actually both licenses are BSD-style Open Source licenses. In case of any license issues related to OpenSSL please contact [openssl-core@openssl.org](mailto:openssl-core@openssl.org).

OpenSSL License

-----

/\*-----

Copyright (c) 1998-2011 The OpenSSL Project. All rights reserved.

Redistribution and use in source and binary forms, with or without modification, are permitted provided that the following conditions are met:

1. Redistributions of source code must retain the above copyright notice, this list of conditions and the following disclaimer.
2. Redistributions in binary form must reproduce the above copyright notice, this list of conditions and the following disclaimer in the documentation and/or other materials provided with the distribution.
3. All advertising materials mentioning features or use of this software must display the following acknowledgment:

"This product includes software developed by the OpenSSL Project for use in the OpenSSL Toolkit. (<http://www.openssl.org/>)"

4. The names "OpenSSL Toolkit" and "OpenSSL Project" must not be used to endorse or promote products derived from this software without prior written permission. For written permission, please contact [openssl-core@openssl.org](mailto:openssl-core@openssl.org).
5. Products derived from this software may not be called "OpenSSL" nor may "OpenSSL" appear in their names without prior written permission of the OpenSSL Project.
6. Redistributions of any form whatsoever must retain the following acknowledgment:

"This product includes software developed by the OpenSSL Project for use in the OpenSSL Toolkit (<http://www.openssl.org/>)"

THIS SOFTWARE IS PROVIDED BY THE OpenSSL PROJECT ``AS IS'' AND ANY EXPRESSED OR IMPLIED WARRANTIES, INCLUDING, BUT NOT LIMITED TO, THE IMPLIED WARRANTIES OF MERCHANTABILITY AND FITNESS FOR A PARTICULAR PURPOSE ARE DISCLAIMED. IN NO EVENT SHALL THE OpenSSL PROJECT OR ITS CONTRIBUTORS BE LIABLE FOR ANY DIRECT, INDIRECT, INCIDENTAL, SPECIAL, EXEMPLARY, OR CONSEQUENTIAL DAMAGES (INCLUDING, BUT NOT LIMITED TO, PROCUREMENT OF SUBSTITUTE GOODS OR SERVICES; LOSS OF USE, DATA, OR PROFITS; OR BUSINESS INTERRUPTION) HOWEVER CAUSED AND ON ANY THEORY OF LIABILITY, WHETHER IN CONTRACT, STRICT LIABILITY, OR TORT (INCLUDING NEGLIGENCE OR OTHERWISE) ARISING IN ANY WAY OUT OF THE USE OF THIS SOFTWARE, EVEN IF ADVISED OF THE POSSIBILITY OF SUCH DAMAGE.

=====

This product includes cryptographic software written by Eric Young ([eay@cryptsoft.com](mailto:eay@cryptsoft.com)). This product includes software written by Tim Hudson ([tjh@cryptsoft.com](mailto:tjh@cryptsoft.com)).

\*/

Original SSLeay License

---

-----  
/\* Copyright (C) 1995-1998 Eric Young (eay@cryptsoft.com)

All rights reserved.

This package is an SSL implementation written by Eric Young (eay@cryptsoft.com).

The implementation was written so as to conform with Netscapes SSL.

This library is free for commercial and non-commercial use as long as the following conditions are aheared to. The following conditions apply to all code found in this distribution, be it the RC4, RSA, lhash, DES, etc., code; not just the SSL code. The SSL documentation included with this distribution is covered by the same copyright terms except that the holder is Tim Hudson (tjh@cryptsoft.com).

Copyright remains Eric Young's, and as such any Copyright notices in the code are not to be removed.

If this package is used in a product, Eric Young should be given attribution as the author of the parts of the library used.

This can be in the form of a textual message at program startup or in documentation (online or textual) provided with the package.

Redistribution and use in source and binary forms, with or without modification, are permitted provided that the following conditions are met:

1. Redistributions of source code must retain the copyright notice, this list of conditions and the following disclaimer.
2. Redistributions in binary form must reproduce the above copyright notice, this list of conditions and the following disclaimer in the documentation and/or other materials provided with the distribution.
3. All advertising materials mentioning features or use of this software must display the following acknowledgement:

"This product includes cryptographic software written by Eric Young (eay@cryptsoft.com)"

The word 'cryptographic' can be left out if the rouines from the library being used are not cryptographic related :-).

4. If you include any Windows specific code (or a derivative thereof) from the apps directory (application code) you must include an acknowledgement:

"This product includes software written by Tim Hudson (tjh@cryptsoft.com)"

THIS SOFTWARE IS PROVIDED BY ERIC YOUNG ``AS IS'' AND ANY EXPRESS OR IMPLIED WARRANTIES, INCLUDING, BUT NOT LIMITED TO, THE IMPLIED WARRANTIES OF MERCHANTABILITY AND FITNESS FOR A PARTICULAR PURPOSE ARE DISCLAIMED. IN NO EVENT SHALL THE AUTHOR OR CONTRIBUTORS BE LIABLE FOR ANY DIRECT, INDIRECT, INCIDENTAL, SPECIAL, EXEMPLARY, OR CONSEQUENTIAL DAMAGES (INCLUDING, BUT NOT LIMITED TO, PROCUREMENT OF SUBSTITUTE GOODS OR SERVICES; LOSS OF

---

USE, DATA, OR PROFITS; OR BUSINESS INTERRUPTION) HOWEVER CAUSED AND ON ANY THEORY OF LIABILITY, WHETHER IN CONTRACT, STRICT LIABILITY, OR TORT (INCLUDING NEGLIGENCE OR OTHERWISE) ARISING IN ANY WAY OUT OF THE USE OF THIS SOFTWARE, EVEN IF ADVISED OF THE POSSIBILITY OF SUCH DAMAGE.

The licence and distribution terms for any publically available version or derivative of this code cannot be changed. i.e. this code cannot simply be copied and put under another distribution licence [including the GNU Public Licence.]

\*/

## ENERGY STAR® Program



Your Computer model may be ENERGY STAR® compliant. If the model you purchased is compliant, it is labeled with the ENERGY STAR logo on the computer and the following information applies.

TOSHIBA is a partner in the ENERGY STAR Program and has designed this computer to meet the latest ENERGY STAR guidelines for energy efficiency. Your computer ships with the power management options preset to a configuration that will provide the most stable operating environment and optimum system performance for both AC power and battery modes.

To conserve energy, your computer is set to enter the low-power Sleep Mode which shuts down the system and display within 15 minutes of inactivity in AC power mode.

TOSHIBA recommends that you leave this and other energy saving features active, so that your computer will operate at its maximum energy efficiency. You can wake the computer from Sleep Mode by pressing the power button.

Products that earn the ENERGY STAR prevent greenhouse gas emissions by meeting strict energy efficiency guidelines set by the US EPA and the EU Commission. According to the EPA, a computer meeting the new ENERGY STAR specifications will use between 20% and 50% less energy depending on how it is used. Visit <http://www.eu-energystar.org> or <http://www.energystar.gov> for more information regarding the ENERGY STAR Program.

---

## Disposing of the computer and the computer's batteries

Contact an authorized TOSHIBA service provider for details regarding how to dispose of the computer and the batteries.

## Optical disc drive safety instructions



*Be sure to check the precautions at the end of this section.*



- *The drive model employs a laser system. To ensure proper use of this product, please read this instruction manual carefully and retain for future reference. Should the unit ever require maintenance, contact an authorized service location.*
- *Use of controls, adjustments or the performance of procedures other than those specified may result in hazardous radiation exposure.*
- *To prevent direct exposure to the laser beam, do not try to open the enclosure.*

## Location of the Required Label

(Sample shown below. Location of the label and manufacturing information may vary.)

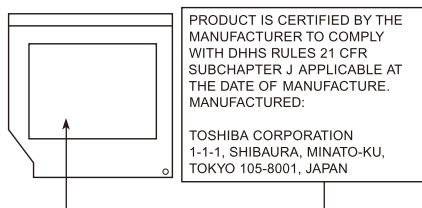

---

## Precautions

CLASS 1 LASER PRODUCT LASER KLASSE 1 PRODUKT TO EN 60825-1 クラス1レーザー製品
--

**CAUTION:** This appliance contains a laser system and is classified as a “CLASS 1 LASER PRODUCT.” To use this model properly, read the instruction manual carefully and keep this manual for your future reference. In case of any trouble with this model, please contact your nearest “AUTHORIZED service station.” To prevent direct exposure to the laser beam, do not try to open the enclosure.

## General Precautions

TOSHIBA computers are designed to optimize safety, minimize strain and withstand the rigors of portability. However, certain precautions should be observed to further reduce the risk of personal injury or damage to the computer.

Be certain to read the general precautions below and to note the cautions included in the text of the manual.

### Provide adequate ventilation

Always make sure your computer and AC adaptor have adequate ventilation and are protected from overheating when the power is turned on or when an AC adaptor is connected to a power outlet (even if your computer is in Sleep Mode). In this condition, observe the following:

- Never cover your computer or AC adaptor with any object.
- Never place your computer or AC adaptor near a heat source, such as an electric blanket or heater.
- Never cover or block the air vents including those located at the base of the computer.
- Always operate your computer on a hard flat surface. Using your computer on a carpet or other soft material can block the vents.
- Always provide sufficient space around the computer.

Overheating your computer or AC adaptor could cause system failure, computer or AC adaptor damage or a fire, possibly resulting in serious injury.

### Creating a computer-friendly environment

Place the computer on a flat surface that is large enough for the computer and any other items you are using, such as a printer.



---

Leave enough space around the computer and other equipment to provide adequate ventilation. Otherwise, they may overheat.

To keep your computer in prime operating condition, protect your work area from:

- Dust, moisture, and direct sunlight.
- Equipment that generates a strong electromagnetic field, such as stereo speakers (other than speakers that are connected to the computer) or speakerphones.
- Rapid changes in temperature or humidity and sources of temperature change such as air conditioner vents or heaters.
- Extreme heat, cold, or humidity.
- Liquids and corrosive chemicals.

## Stress injury

Carefully read the *Instruction Manual for Safety and Comfort*. It contains information on the prevention of stress injuries to your hands and wrists that can be caused by extensive keyboard use. It also includes information on work space design, posture and lighting that can help reduce physical stress.

## Heat injury

- Avoid prolonged physical contact with the computer. If the computer is used for long periods, its surface can become very warm. While the temperature will not feel hot to the touch, if you maintain physical contact with the computer for a long time, for example if you rest the computer on your lap or if you keep your hands on the palm rest, your skin might suffer a low-heat injury.
- If the computer has been used for a long time, avoid direct contact with the metal plate supporting the various interface ports as this can become hot.
- The surface of the AC adaptor can become hot when in use but this condition does not indicate a malfunction. If you need to transport the AC adaptor, you should disconnect it and let it cool before moving it.
- Do not lay the AC adaptor on a material that is sensitive to heat as the material could become damaged.

## Pressure or impact damage

Do not apply heavy pressure to the computer or subject it to any form of strong impact as this can damage the computer's components or otherwise cause it to malfunction.

## Cleaning the computer

To help ensure long, trouble-free operation, keep the computer free of dust and dirt, and use care with all liquids around it.

- 
- Be careful not to spill liquids into the computer. If the computer does get wet, turn the power off immediately and let the computer dry completely - in these circumstance you should get the computer inspected by an authorized service provider in order to assess the scope of any damage.
  - Clean the plastics of the computer using a slightly water dampened cloth.
  - You can clean the display screen by spraying a small amount of glass cleaner onto a soft, clean cloth and then wiping the screen gently with the cloth.



*Never spray cleaner directly onto the computer or let liquid run into any part of it. Never use harsh or caustic chemical products to clean the computer.*

## Moving the computer

While the computer is designed for flexible day-to-day usage you should exercise a few simple precautions when moving it in order to help ensure trouble-free operation.

- Make sure all disk/disc activity has ended before moving the computer.
- Turn off (shut down) the computer.
- Disconnect the AC adaptor and all peripherals before moving the computer.
- Close the display panel.
- Do not pick up the computer by its display panel.
- Before carrying your computer, shut it down, disconnect the AC adaptor and allow it to cool down - a failure to follow this instruction may result in minor heat injury.
- Be careful not to subject the computer to impact or shock - a failure to follow this instruction could result in damage to computer, computer failure or loss of data.
- Never transport your computer with any cards installed - this may cause damage to either the computer and/or the card resulting in computer failure.
- Always use a suitable carry case when transporting the computer.
- When carrying your computer, be sure to hold it securely so that it does not fall or hit anything.
- Do not carry your computer by holding any of its protruding elements.

## Mobile phones

Please be aware that the use of mobile phones can interfere with the audio system. The operation of the computer will not be impaired in any way, but it is recommended that a minimum distance of 30cm is maintained between the computer and a mobile phone that is in use.

---

## Instruction Manual for Safety and Comfort

All important information on the safe and proper use of this computer is described in the enclosed Instruction Manual for Safety and Comfort. Be sure to read it before using the computer.

### Safety Icons

Safety icons are used in this manual to bring important information to your attention. Each type of message is identified as shown below.



*Indicates a potentially hazardous situation, which could result in death or serious injury, if you do not follow instructions.*



*A caution informs you that improper use of equipment or failure to follow instructions may cause data loss, equipment damage, or may result in minor or moderate injury.*



*Please read. A note is a hint or advice that helps you make best use of your equipment.*

---

# Chapter 2

## Getting Started

This chapter provides an equipment checklist, and basic information to start using your computer.



*Some of the features described in this manual may not function properly if you use an operating system that was not pre-installed by TOSHIBA.*

### Equipment checklist

Carefully unpack your computer, taking care to save the box and packaging materials for future use.

#### Hardware

Check to make sure you have all the following items:

- TOSHIBA Portable Personal Computer
- AC adaptor and power cord (2-pin plug or 3-pin plug)

#### Documentation

- User Information Guide
- Instruction Manual for Safety and Comfort

If any of the items are missing or damaged, contact your dealer immediately.

### Conventions

This manual uses the following formats to describe, identify, and highlight terms and operating procedures.

---

**HDD or Hard disk drive**

Some models are equipped with a "Solid State Drive (SSD)" instead of a hard disk drive. In this manual, the word "HDD" or "Hard disk drive" also refers to the SSD unless otherwise stated.

---

**Click**

- Tap the Touch Pad or click the left Touch Pad control button once.
  - Left click the mouse once.
  - Tap the touch screen once (only for touch screen models).
-

<b>Right-click</b>	<ul style="list-style-type: none"> <li>■ Click the right Touch Pad control button once.</li> <li>■ Right click the mouse once.</li> <li>■ Press and hold on the touch screen (only for touch screen models).</li> </ul>
<b>Double-click</b>	<ul style="list-style-type: none"> <li>■ Tap the Touch Pad or click the left Touch Pad control button twice.</li> <li>■ Left click the mouse twice.</li> <li>■ Tap the touch screen twice (only for touch screen models).</li> </ul>
<b>Charm</b>	By swiping in from the right edge (only for touch screen models) or pointing the mouse pointer to the lower-right (or upper-right) corner of your screen, you will find a list of charms: <b>Search, Share, Start, Devices</b> and <b>Settings</b> .
<b>Desktop</b>	Click the <b>Desktop</b> tile from the Start screen to access the desktop.
<b>Start screen</b>	You can go to the Start screen by clicking the <b>Start</b> charm. You can also use the Windows® logo key (  ) on your keyboard to go to Start screen. For detailed information, please refer to the Windows Help and Support.

## Using your computer for the first time



*Be sure to read the enclosed Instruction Manual for Safety and Comfort for information on the safe and proper use of this computer. It is intended to help you be more comfortable and productive while using a notebook computer. By following the recommendations in it you may reduce your chance of developing a painful or disabling injury to your hand, arms, shoulders or neck.*

This section provides basic information to start using your computer. It covers the following topics:

- Connecting the AC adaptor
- Opening the display
- Turning on the power
- Initial setup
- Getting to know Windows



- *Use a virus-check program and make sure it is updated regularly.*
- *Never format storage media without checking its content - formatting destroys all stored data.*

- *It is a good idea to periodically back up the internal Hard Disk Drive or other main storage device to external media. General storage media is not durable or stable over long periods of time and under certain conditions may result in data loss.*
- *Before you install a device or application, save any data in memory to the Hard Disk Drive or other storage media. Failure to do so may result in the loss of data.*

## Connecting the AC adaptor

Attach the AC adaptor when you need to charge the battery or you want to operate from AC power. It is also the fastest way to get started, because the battery pack will need to be charged before you can operate from battery power.

The AC adaptor can automatically adjust to any voltage ranging from 100 to 240 volts and to a frequency of either 50 or 60 hertz, enabling you to use this computer in almost any country/region. The adaptor converts AC power to DC power and reduces the voltage supplied to this computer.



- *Always use the TOSHIBA AC adaptor that was included with your computer, or use AC adaptors specified by TOSHIBA to avoid any risk of fire or other damage to the computer. Use of an incompatible AC adaptor could cause fire or damage to the computer possibly resulting in serious injury. TOSHIBA assumes no liability for any damage caused by use of an incompatible adaptor.*
- *Never plug the AC adaptor into a power source that does not correspond to both the voltage and the frequency specified on the regulatory label of the unit. Failure to do so could result in a fire or electric shock, possibly resulting in serious injury.*
- *Always use or purchase power cables that comply with the legal voltage and frequency specifications and requirements in the country of use. Failure to do so could result in a fire or electric shock, possibly resulting in serious injury.*
- *The supplied power cord conforms to safety rules and regulations in the region the computer is bought and should not be used outside this region. For use in other regions, please buy power cords that conform to safety rules and regulations in the particular region.*
- *Do not use a 3-pin to 2-pin conversion plug.*

- *When you connect the AC adaptor to the computer, always follow the steps in the exact order as described in this User's Manual. Connecting the power cable to a live electrical outlet should be the last step otherwise the adaptor DC output plug could hold an electrical charge and cause an electrical shock or minor bodily injury when touched. As a general safety precaution, avoid touching any metal parts.*
- *Never place your computer or AC adaptor on a wooden surface, furniture, or any other surface that could be marred by exposure to heat since the computer base and AC adaptor's surface increase in temperature during normal use.*
- *Always place your computer or AC adaptor on a flat and hard surface that is resistant to heat damage.*

*Refer to the enclosed Instruction Manual for Safety and Comfort for detailed precautions and handling instructions.*

1. Connect the power cord to the AC adaptor.

*Figure 2-1 Connecting the power cord to the AC adaptor (2-pin plug)*

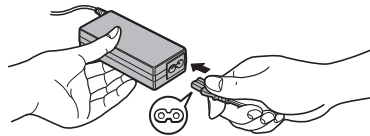

*Figure 2-2 Connecting the power cord to the AC adaptor (3-pin plug)*

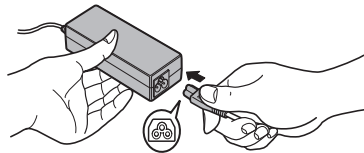

*Either a 2-pin or 3-pin adaptor/cord will be included with the computer depending on the model.*

2. Connect the AC adaptor's DC output plug to the DC IN 19V jack on your computer.

*Figure 2-3 Connecting the DC output plug to the computer*

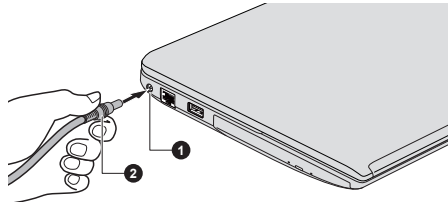

1. DC IN 19V jack

2. DC output plug

3. Plug the power cord into a live wall outlet - the **DC IN/Battery** indicator should glow.

## Opening the display

The display panel can be opened to a wide range of angles for optimal viewing.

While holding down the palm rest with one hand so that the main body of the computer is not raised, slowly lift the display panel - this will allow the angle of the display panel to be adjusted to provide optimum clarity.

*Figure 2-4 Opening the display panel*

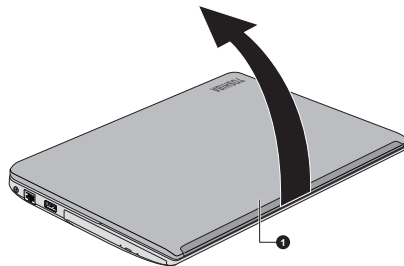

1. Display panel



*Use reasonable care when opening and closing the display panel. Opening it vigorously or slamming it shut could damage the computer.*



- *Be careful not to open the display panel too far as this could put stress on the display panel's hinges and cause damage.*
- *Do not press or push on the display panel.*
- *Do not lift the computer by the display panel.*
- *Do not close the display panel with pens or any other objects left in between the display panel and the keyboard.*



- *When opening or closing the display panel, place one hand on the palm rest to hold the computer in place and use the other hand to slowly open or close the display panel (Do not use excessive force when opening or closing the display panel).*

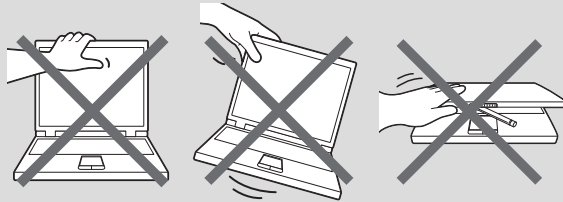

## Turning on the power

This section describes how to turn on the power - the **Power** indicator will then indicate the status. Please refer to the [Power Condition Descriptions](#) section for more information.



- *After you turn on the power for the first time, do not turn it off until you have set up the operating system.*
- *Volume cannot be adjusted during Windows Setup.*

1. Open the display panel.
2. Press the computer's power button.

*Figure 2-5 Turning on the power*

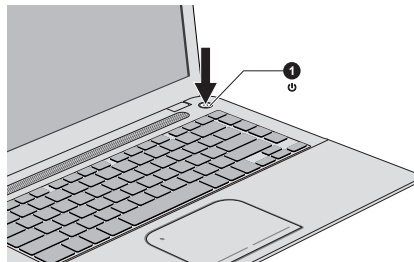

1. Power button

Product appearance depends on the model you purchased.

## Initial setup

The Windows 8 Startup Screen will be the first screen displayed when you turn on the power. Follow the on-screen instructions on each screen in order to properly install the operating system.



When it is displayed, be sure to read the **License Terms** carefully.

## Getting to know Windows

For detailed information on what is new and how to operate Windows 8, please refer to the Windows Help and Support.

### **Start screen**

The Start screen is the launching pad for everything you can do in the Windows operating system, providing new and easy ways to access everything from your favorite apps and Web sites to your contacts and other important information.

From the Start screen, you can just start typing to search for what you want. From there, you can easily switch between results for apps, files, and more.

### **Charms**

Use the Windows Charms to start apps, find documents, set up system components, and perform most other computing tasks.

By pointing the mouse pointer to the upper or lower right corner of your screen, you will find a list of charms: **Search**, **Share**, **Start**, **Devices** and **Settings**.



---

#### **Search**

This Charm allows you to locate items on your computer. It can help you find apps, documents, photos, and your favorite music.

---



---

#### **Share**

This Charm allows you to share items (links, photos and more).

---



---

#### **Start**

This Charm takes you to the Start screen or, if already on the Start screen, returns you to your last app.

---



---

#### **Devices**

This Charm allows you to manage your hardware devices.

---



---

#### **Settings**

This Charm allows you to access your computer's settings.

---

### **Tiles**

Tiles can be accessed and launched from the Start screen.

---

Typical Start screen tiles are the Desktop tile and Mail tile, as well as tiles representing all other applications downloaded to your system.

### **Windows Store**

Although many applications will be pre-installed or built-in to your computer, you will also have the ability to download many other applications at the click of your mouse.

In the Windows Store you can search for and browse thousands of apps, all grouped into easy to find categories.

## **Turning off the power**

The power can be turned off in one of the following modes, either Shut Down Mode, Sleep Mode or Hibernation Mode.

### **Shut Down Mode**

When you turn off the power in Shut Down Mode, no data will be saved and the computer will boot to the operating system's main screen the next time it is turned on.

1. If you have entered data, either save it to the Hard Disk Drive or to other storage media.
2. Make sure all disk/disc activity has stopped before removing the disk/disc.



- *If you turn off the power while a disk (disc) is being accessed, you may lose data or damage the disk.*
- *Never turn off the power while an application is running. Doing so could cause loss of data.*
- *Never turn off the power, disconnect an external storage device or remove storage media during data read/write. Doing so can cause data loss.*

3. Click the **Settings** charm.
4. Click **Power** and then select **Shut down**.
5. Turn off any peripheral devices connected to your computer.



*Do not turn the computer or peripheral devices back on immediately - wait a short period to avoid any potential damage.*

### **Restarting the computer**

Certain conditions require that you reset the computer, for example if:

- You change certain computer settings.

If you need to restart the computer, there are two ways this can be achieved:

- In the **Settings** charm, click **Power** and then select **Restart**.
- Press **CTRL, ALT and DEL** simultaneously (once) to display the menu window, and then select **Restart** by clicking the power icon (⏻) in the lower-right corner.

## Sleep Mode

If you have to interrupt your work, you are able to turn off the power without exiting from your software by placing the computer into Sleep Mode. In this mode data is maintained in the computer's main memory so that when you turn on the power again, you can continue working right where you left off.



*When you have to turn off your computer aboard an aircraft or in places where electronic devices are regulated or controlled, always completely shut down the computer. This includes turning off any wireless communication functionalities, and cancelling settings that reactivate the computer automatically, such as a timer recording function. Failure to completely shut down the computer in this way could allow the operating system to reactivate and run pre-programmed tasks or preserve unsaved data, which could interfere with aviation or other systems, possibly causing serious injury.*



- Before entering Sleep Mode, be sure to save your data.
- Do not switch to Sleep Mode while transferring data to external media, such as USB devices, memory media or other external memory devices. Data will be lost.
- Do not install or remove a memory module while the computer is in Sleep Mode. The computer or the memory module could be damaged.



- When the AC adaptor is connected, the computer will go into Sleep Mode according to the settings in the Power Options (to access it, click **Desktop -> Desktop Assist -> Control Panel -> System and Security -> Power Options**).
- To restore the operation of the computer from Sleep Mode, press and hold the power button or any key on the keyboard for a short amount of time. Please note that keyboard keys can only be used if the Wake-up on Keyboard option is enabled within the TOSHIBA System Settings.
- If the computer enters Sleep Mode while a network application is active, the application might not be restored when the computer is next turned on and the system returns from Sleep Mode.
- To prevent the computer from automatically entering Sleep Mode, disable Sleep Mode within the Power Options.
- To use the Hybrid Sleep function, configure it in the Power Options.

---

## Benefits of Sleep Mode

The Sleep Mode feature provides the following benefits:

- Restores the previous working environment more rapidly than the Hibernation Mode feature.
- Saves power by shutting down the system when the computer receives no input or hardware access for the time period set by the System Sleep Mode feature.
- Allows the use of the panel power off feature.

## Executing Sleep Mode

You can enter Sleep Mode in one of three ways:

- In the **Settings** charm, click **Power** and then select **Sleep**.
- Close the display panel. Please note that this feature must be enabled within the Power Options.
- Press the power button. Please note that this feature must be enabled within the Power Options.

When you turn the power back on, you can continue where you left off when you shut down the computer.



- *When the computer is in Sleep Mode, the Power indicator will blink white.*
- *If you are operating the computer on battery power, you can lengthen the overall operating time by turning it off into Hibernation Mode - Sleep Mode will consume more power while the computer is off.*

## Sleep Mode limitations

Sleep Mode will not function under the following conditions:

- Power is turned back on immediately after shutting down.
- Memory circuits are exposed to static electricity or electrical noise.

## Hibernation Mode

The Hibernation Mode feature saves the contents of memory to the Hard Disk Drive when the computer is turned off so that, the next time it is turned on, the previous state is restored. Please note that the Hibernation Mode feature does not save the status of any peripheral devices connected to the computer.



- *Save your data. While entering Hibernation Mode, the computer saves the contents of memory to the Hard Disk Drive. However, for safety sake, it is best to save your data manually.*
- *Data will be lost if you disconnect the AC adaptor before the save is completed.*

- *Do not install or remove a memory module while the computer is in Hibernation Mode. Data will be lost.*
- *Do not switch to Hibernation Mode while transferring data to external media, such as USB devices, memory media or other external memory devices, as Data will be lost.*

### ***Benefits of Hibernation Mode***

The Hibernation Mode feature provides the following benefits:

- Saves data to the Hard Disk Drive when the computer automatically shuts down because of a low battery condition.
- You can return to your previous working environment immediately when you turn on the computer.
- Saves power by shutting down the system when the computer receives no input or hardware access for the time period set by the System Hibernate feature.
- Allows the use of the panel power off feature.

### ***Starting Hibernation Mode***

To enter Hibernation Mode, follow the steps below.

1. Click the **Settings** charm.
2. Click **Power** and then select **Hibernate**.



*In order to show **Hibernate** in Power menu, you need to setup according to the following steps:*

1. Click **Desktop -> Desktop Assist -> Control Panel -> System and Security -> Power Options**.
2. Click **Choose what the power button does** or **Choose what closing the lid does**.
3. Click **Change settings that are currently unavailable**.
4. Select the **Hibernate** check box from Shutdown settings.
5. Click the **Save changes** button.

### ***Automatic Hibernation Mode***

The computer can be configured to enter Hibernation Mode automatically when you press the power button or close the lid. In order to define these settings, you can follow the steps as described below:

1. Click **Power Options** and then click **Choose what the power button does** or **Choose what closing the lid does**.
2. Enable the desired Hibernation Mode settings for **When I press the power button** and **When I close the lid**.
3. Click the **Save changes** button.

---

### ***Data save in Hibernation Mode***

When you turn off the power in Hibernation Mode, the computer will take a moment to save the current data in memory to the Hard Disk Drive.

After you turn off the computer, and the content of memory has been saved to the Hard Disk Drive, turn off the power to any peripheral devices.



*Do not turn the computer or devices back on immediately. Wait a moment to let all capacitors fully discharge.*

# Chapter 3

## The Grand Tour

This chapter identifies the various components of the computer - it is recommended that you become familiar with each before you operate the computer.

### Legal Footnote (Non-applicable Icons)

For more information regarding Non-applicable Icons, please refer to the [Legal Footnotes](#) section.



*Please handle your computer carefully to avoid scratching or damaging the surface.*

## Front with the display closed

The following figure shows the front of the computer with the display panel in the closed position.

*Figure 3-1 Front of the computer with display panel closed*

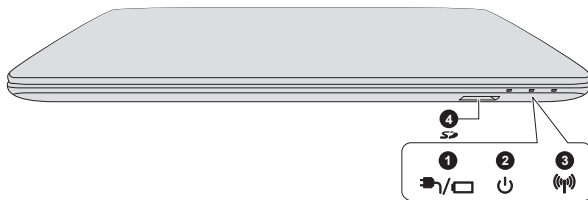

1. DC IN/Battery indicator
2. Power indicator

3. Wireless communication indicator
4. Memory media slot

Product appearance depends on the model you purchased.



### DC IN/Battery indicator

The **DC IN/Battery** indicator shows the condition of the DC IN and the battery's charge - white indicates the battery is fully charged while the power is being correctly supplied from the AC power adaptor.

Please refer to the [Power Condition Descriptions](#) section for more information on this feature.





### Power indicator

The **Power** indicator glows white when the computer is turned on. However, if you turn the computer off into Sleep Mode, this indicator will blink white.



### Wireless communication indicator

The **Wireless communication** indicator glows amber when the Bluetooth or Wireless LAN functions are turned on.

Only some models are equipped with Bluetooth and Wireless LAN functions.



### Memory media slot

This slot lets you insert an SD™/SDHC™/SDXC™ memory card, miniSD™/microSD™ Card and MultiMediaCard™. Refer to the [Memory media](#) section for more information.



*Keep foreign metal objects, such as screws, staples and paper clips, out of the Memory media slot. Foreign metal objects can create a short circuit, which can cause damage and fire, possibly resulting in serious injury.*

## Left side

The following figure shows the left side of the computer.

*Figure 3-2 The left side of the computer*

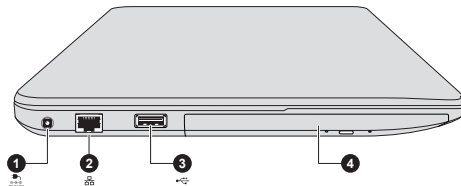

1. DC IN 19V jack

2. LAN jack

3. Universal Serial Bus (USB 2.0) port

4. Optical disc drive\*

\* Provided with some models.

Product appearance depends on the model you purchased.



### DC IN 19V jack

The AC adaptor connects to this jack in order to power the computer and charge its internal batteries. Please note that you should only use the model of AC adaptor supplied with the computer at the time of purchase - using the wrong AC adaptor can cause damage to the computer.



### LAN jack

This jack lets you connect to a LAN. The adaptor has built-in support for Ethernet LAN (10 megabits per second, 10BASE-T), or Fast Ethernet LAN (100 megabits per second, 100BASE-TX). Some models are equipped with a Gigabit Ethernet LAN (1000 megabits per second, 1000BASE-T). Refer to [Operating Basics](#), for details.



*Do not connect any cable other than a LAN cable to the LAN jack. It could cause damage or malfunction.*



### Universal Serial Bus (USB 2.0) port

One Universal Serial Bus port, which complies to the USB 2.0 standard, is provided on the left side of the computer.

The USB 2.0 port is not compatible with USB 3.0 devices.



*Please note that it is not possible to confirm the operation of all functions of all USB devices that are available. Some functions associated with a specific device might not operate properly.*



*Keep foreign metal objects, such as screws, staples and paper clips, out of the USB port. Foreign metal objects can create a short circuit, which can cause damage and fire, possibly resulting in serious injury.*

### Optical disc drive

The computer may be configured with a DVD Super Multi drive, Blu-ray™ Combo drive or Blu-ray™ Writer drive.



*2.6GB and 5.2GB DVD-RAM media cannot be read from or written to.*

## Right side

The following figure shows the right side of the computer.

Figure 3-3 The right side of the computer

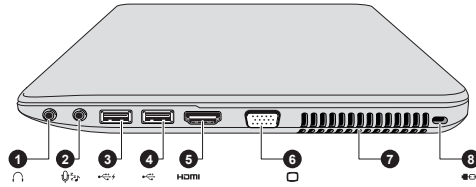

1. Headphone jack
2. Microphone jack
3. Universal Serial Bus (USB 3.0)port
4. Universal Serial Bus (USB 3.0)port
5. HDMI out port
6. External RGB monitor port
7. Cooling vents
8. Security lock slot

Product appearance depends on the model you purchased.



### Headphone jack

A 3.5 mm mini headphone jack enables connection of stereo headphones.



### Microphone jack

A 3.5 mm mini microphone jack enables connection of a mini jack for monaural microphone input.

The jack with the icon (  ) has *Sleep and Music* function.



*The integrated sound system provides support for the computer's internal speakers and microphone, as well as allowing an external microphone and headphones to be connected via the appropriate jacks.*



### Universal Serial Bus (USB 3.0) port

Two Universal Serial Bus ports, which comply to the USB 3.0 standard, are provided on the right side of the computer.

The USB 3.0 port is compliant with USB 3.0 standard and backward compatible with USB 2.0 devices.

The port with the icon (  ) has Sleep and Charge function.



*USB 3.0 port(s) may work as USB 2.0 port(s) when operating in USB Legacy Emulation mode.*



### HDMI out port

HDMI out port can connect with Type A connector HDMI cable.



**External RGB monitor port**

This port provides 15-pin, analog RGB port. Please refer to the [External RGB monitor port pin assignment](#) section for information on external RGB monitor port pin assignment. This port allows you to connect an external RGB monitor to the computer.

**Cooling vents**

The cooling vents help the processor to avoid overheating.



**Security lock slot**

A security cable can be attached to this slot and then connected to a desk or other large object in order to deter theft of the computer.

## Back

The following figure shows the back of the computer.

*Figure 3-4 The back of the computer*



Product appearance depends on the model you purchased.

## Underside

The following figure shows the underside of the computer. You should ensure that the display is closed before the computer is turned over to avoid causing any damage.

*Figure 3-5 The underside of the computer*

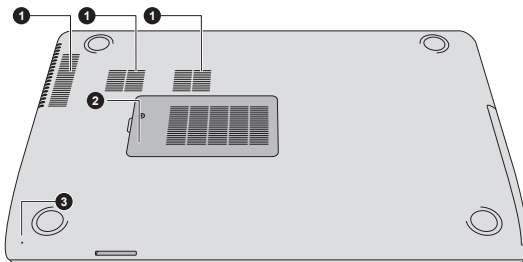

1. Cooling vents

2. Memory module slot

3. Force shut down hole

Product appearance depends on the model you purchased.



### Memory module slot

The memory module slot allows for the installation, replacement and removal of additional memory module.

The size of the memory modules varies depending on the model. The actual amount of useable system memory will be less than the installed memory modules.

Refer to the [Additional memory module](#) section.

### Cooling vents

The cooling vents help the processor to avoid overheating.



*Do not block the cooling vents. Keep foreign metal objects, such as screws, staples and paper clips, out of the cooling vents. Foreign metal objects can create a short circuit, which can cause damage and fire, possibly resulting in serious injury.*

*Carefully clean the dust on the cooling vents' surface using a soft cloth.*

### Force shut down hole

Insert a slender object such as a needle into this hole to force a shut down when the computer is hung.

## Front with the display open

This section shows the computer with the display panel open. In order to open the display, lift the display panel up and position it at a comfortable viewing angle for you.

*Figure 3-6 The front of the computer with the display panel open(non-touch model)*

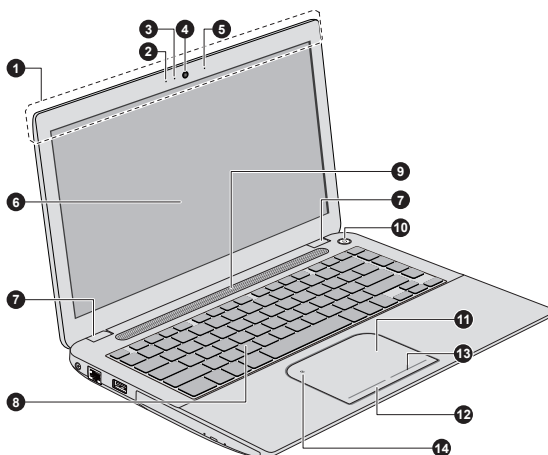
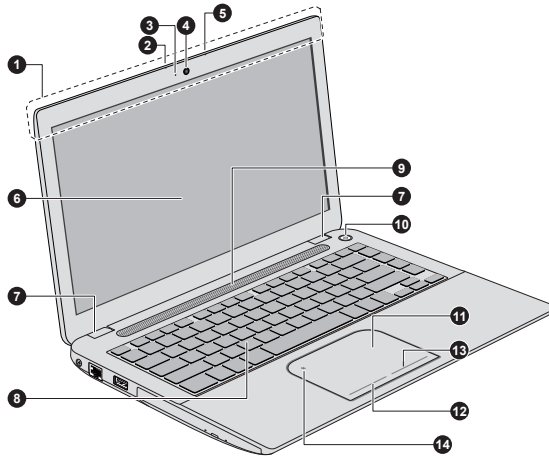

Figure 3-7 The front of the computer with the display panel open(touch mode)



- |   |                                |
|---|--------------------------------|
| 1. Wireless communication antennas (not shown)* | 8. Keyboard                    |
| 2. Microphone                                   | 9. Stereo speakers             |
| 3. Web Camera LED                               | 10. Power button               |
| 4. Web Camera                                   | 11. Touch Pad                  |
| 5. Microphone                                   | 12. Touch Pad control button   |
| 6. Display screen                               | 13. Touch Pad control button   |
| 7. Display hinges                               | 14. Touch Pad ON/OFF indicator |

\* Provided with some models.

Product appearance depends on the model you purchased.

---

**Wireless communication antennas**

Some computers in this series are equipped with the Wireless LAN/Bluetooth antennas.

---

Legal Footnote (Wireless LAN)

For more information regarding Wireless LAN, please refer to the [Legal Footnotes](#) section.

---

**Microphone**

The built-in microphone allows you to import and record sounds for your application - please refer to the [Sound System and Video mode](#) section for more information.

---

**Web Camera LED**

The Web Camera LED glows when the Web Camera is operating.

---

**Web Camera**

**Web Camera** is a device that allows you to record video or take photographs with your computer. You can use it for video chatting or video conferences using a communication tool.



- *Do not point the web camera directly at the sun.*
- *Do not touch or press strongly on the web camera lens. Doing so may reduce image quality. Use an eyeglass cleaner (cleaner cloth) or other soft cloth to clean the lens if it becomes dirty.*

---

<b>Display screen</b>	35.6cm (14.0") LCD screen, configured with the following resolutions: <ul style="list-style-type: none"><li>■ HD, 1366 horizontal x 768 vertical pixels</li><li>■ FHD, 1920 horizontal x 1080 vertical pixels</li></ul> Please be aware that, when the computer is operating on the AC adaptor, the image displayed on the internal screen will be somewhat brighter than when it operates on battery power. This difference in brightness levels is intended to save power when operating on batteries.
-----------------------	--

---

#### Legal Footnote (LCD)

For more information regarding LCD, please refer to the [Legal Footnotes](#) section.

---

<b>Display hinges</b>	The display hinges allow the display panel to be positioned at a variety of easy-to-view angles.
<b>Keyboard</b>	Your computer's keyboard contains character keys, control keys, function keys, and special Windows keys, providing all the functionality of a full-size keyboard.  Refer to the <a href="#">The Keyboard</a> section for details.
<b>Stereo speakers</b>	The speakers emit sound generated by your software as well as audio alarms, such as low battery condition, generated by the system.
 <b>Power button</b>	Press this button to turn the computer's power on or off.
<b>Touch Pad</b>	The Touch Pad located in the palm rest is used to control the movement of the on-screen pointer.  To use the Touch Pad, simply touch and move your fingertip across it in the direction you want the on-screen pointer to go.

---

---

**Touch Pad control buttons**

The two buttons located on the bottom of the Touch Pad are used like the buttons on a standard mouse - press the left button to select a menu item or to manipulate text or graphics designated by the pointer, and press the right button to display a menu or other function depending on the software you are using.

---

**Touch Pad ON/OFF indicator**

Double tap this indicator to enable/disable the Touch Pad. It also shows the status of the Touch Pad:

- Enabled: off
  - Disabled: glows white
- 

## Internal Hardware Components

This section describes the internal hardware components of your computer. The actual specifications may vary depending on the model you purchased.

**Battery pack**

This computer includes a battery pack inside. However, please do not attempt to dismount or replace it by yourself. Please contact an authorized TOSHIBA service provider, if necessary.

The rechargeable lithium-ion battery pack provides power to the computer when the AC adaptor is not connected.

For more detailed information on the use and operation of the battery pack please refer to the [Battery](#) section.

---

**Legal Footnote (Battery Life)**

For more information regarding Battery Life, please refer to the [Legal Footnotes](#) section.

---

**CPU**

The processor type varies depending on model.

To check which type of processor is included in your model, open the TOSHIBA PC Health Monitor utility by clicking **Desktop -> Desktop Assist -> Support & Recovery -> PC Health Monitor**, and then click **PC Information**.

---

**Legal Footnote (CPU)**



---

For more information regarding CPU, please refer to the [Legal Footnotes](#) section.

---

**Hard Disk Drive or Solid State Drive**

The capacity of the hard disk drive varies depending on the model.

To check which type of HDD/SSD is included in your model, open the TOSHIBA PC Health Monitor utility by clicking **Desktop -> Desktop Assist -> Support & Recovery -> PC Health Monitor**, and then click **PC Information**.

Please note that part of the hard disk's overall capacity is reserved as administration space.



■ *In this manual, the word "HDD" or "Hard disk drive" also refers to the SSD unless otherwise stated.*

■ *SSD is a large-capacity storage media which uses Solid-State Memory in place of a magnetic disk of the hard disk.*



*Under certain unusual conditions of prolonged non-use and/or exposure to high temperatures, the SSD may be vulnerable to data retention errors.*

---

Legal Footnote (Hard Disk Drive (HDD) Capacity)

For more information regarding Hard Disk Drive (HDD) Capacity, please refer to the [Legal Footnotes](#) section.

---

**RTC battery**

The internal RTC battery backs up the Real Time Clock (RTC) and calendar.

---

**Video RAM**

The memory in a computer's graphics adaptor, used to store the image displayed on a bitmap display.

The amount of Video RAM available is dependent on the computer's system memory.

**Desktop -> Desktop Assist -> Control Panel -> Appearance and Personalization -> Display -> Adjust resolution.**

The amount of Video RAM can be verified by clicking the **Advanced settings** button in the Screen Resolution window.

---

Legal Footnote (Memory (Main System))

---

For more information regarding Memory (Main System), please refer to the [Legal Footnotes](#) section.

### Display controller

The display controller interprets software commands into hardware commands that turn particular parts on the screen on or off.

The display controller also controls the video mode and uses industry standard rules to govern the screen resolution and the maximum number of colors that can be displayed at a time. Therefore, software written for a given video mode will run on any computer that supports that mode.

---

### Legal Footnote (Graphics Processing Unit (GPU))

For more information regarding Graphics Processing Unit (GPU), please refer to the [Legal Footnotes](#) section.

## Graphics Control

Some NVIDIA graphics models may include NVIDIA® Optimus™ technology feature.

NVIDIA® Optimus™ technology intelligently optimizes notebook performance by seamlessly switching between a discrete NVIDIA GPU for great graphics performance and an Intel integrated graphics chip for sustained battery life. Switching is automatic and does not require the user to reboot the computer.

In the Manage 3D Settings menu of NVIDIA Control Panel, you can change the global 3D settings and create overrides for specific programs. The overrides will be used automatically each time the specified programs are launched.



- *Please use the default setting for NVIDIA Optimus technology.*
- *If the program does not run normally after the setting has been changed, please restore the program to the default setting.*
- *If the program does not run normally, please restore the **Preferred graphics processor** to the default setting.*
- *When you use some video playback programs to play video files, the preferred graphics processor in the "Program Settings" tab cannot be changed to the graphics other than "Integrated Graphics".*

*To access the Program Settings, click "NVIDIA Control Panel" -> "Manage 3D settings" -> "Program Settings".*

---

To launch the NVIDIA Control Panel, Click **Desktop -> Desktop Assist -> Control Panel -> Hardware and Sound -> NVIDIA Control Panel**.

For more information about the NVIDIA Control Panel system, please refer to the NVIDIA Control Panel Help. To access it, click **Help** from the main menu and then select **NVIDIA Control Panel Help**.



*On Optimus models, two kinds of Display Drivers are installed: “Intel® HD Graphics Driver” and “NVIDIA Graphics Driver XXX.XX”.*

*Do not uninstall the display driver from “Uninstall Program” in the Control Panel.*

*If you have to uninstall the display driver, please follow the steps below:*

- 1. Uninstall “NVIDIA Graphics Driver XXX.XX”.*
- 2. Then uninstall “Intel® HD Graphics Driver”.*

## **Intel® Display Power Saving Technology**

Intel GPU models may include the Display Power Saving Technology feature that can save the computer’s power consumption by optimizing picture contrast on the internal LCD.

This feature can be used if the computer is:

- running under battery mode
- using the internal LCD display only

The Display Power Saving Technology feature is enabled as the factory default. If you want to disable this feature, you can disable it.

The Display Power Saving Technology feature can be disabled in the Intel® HD Graphics Control Panel/Intel® Graphics and Media Control Panel.

You can access this control panel in the following way:

- Right-click on the desktop and click **Graphics Properties...**

In Intel® HD Graphics Control Panel:

1. Click **Power** and select **On battery**.
2. Click **Off** under **Display Power Saving Technology**.
3. Click **Apply**.

If you want to enable this feature, under the conditions mentioned above, click **On** under **Display Power Saving Technology**.

In Intel® Graphics and Media Control Panel:

1. Click **Power**.
2. Select **On battery** from the drop-down menu in **Power Source**.
3. Clear the **Display Power Saving Technology** check box.
4. Click **OK**.

If you want to enable this feature, under the conditions mentioned above, select the **Display Power Saving Technology** check box.

## AMD® Vari-Bright™

AMD GPU models may include the AMD® Vari-Bright™ feature that can save the computer's power consumption by optimizing picture contrast on the internal LCD.

This feature can be used if the computer is:

- running under battery mode
- using the internal LCD display only

The Vari-Bright feature can be enabled in the AMD VISION Engine Control Center/Catalyst Control Center. You can access the center in the following way:

- Right-click on the desktop and click **AMD VISION Engine Control Center/Catalyst Control Center**.

In this control panel:

1. Select **PowerPlay™** under **Power**.
2. Select **Enable PowerPlay™** check box, and then select the **Enable Vari-Bright™** check box.

If you want to improve the picture quality under the conditions mentioned above, adjust the setting towards Maximize Quality or disable this feature.

## Power Condition Descriptions

### Power conditions

The computer's operating capability and battery charge status are affected by different power conditions, including whether an AC adaptor is connected and what the charge level is for that battery.



*The LED in the table below refers to the **DC IN/Battery** indicator.*

		Power on	Power off (no operation)
<b>AC adaptor connected</b>	Battery fully charged	<ul style="list-style-type: none"><li>• Operates</li><li>• No charge</li><li>• LED: white</li></ul>	<ul style="list-style-type: none"><li>• No charge</li><li>• LED: white</li></ul>
	Battery partially charged or no charge	<ul style="list-style-type: none"><li>• Operates</li><li>• Charge</li><li>• LED: amber</li></ul>	<ul style="list-style-type: none"><li>• Quick charge</li><li>• LED: amber</li></ul>

		Power on	Power off (no operation)
<b>AC adaptor not connected</b>	Remaining battery capacity is above low battery trigger point	<ul style="list-style-type: none"> <li>Operates</li> <li>LED: off</li> </ul>	
	Remaining battery capacity is below low battery trigger point	<ul style="list-style-type: none"> <li>Operates</li> <li>LED: flashes amber</li> </ul>	
	Remaining battery capacity is exhausted	Computer shuts down	

## DC IN/Battery indicator

Check the **DC IN/Battery** indicator to determine the status of the battery pack and the power status with the AC adaptor connected. The following indicator conditions should be noted:

<b>Flashing amber</b>	The battery charge is low. The AC adaptor must be connected in order to recharge the battery.
<b>Amber</b>	Indicates the AC adaptor is connected and the battery is charging.
<b>White</b>	Indicates the AC adaptor is connected and the battery is fully charged.
<b>No light</b>	Under any other conditions, the indicator does not light.



*If the battery pack becomes too hot while it is being charged, the charge will stop and the **DC IN/Battery** indicator will go out. When the battery pack's temperature falls to a normal range, charging will resume - this process will occur regardless of whether the computer's power is on or off.*

## Power indicator

Check the **Power** indicator to determine the power status of the computer - the following indicator conditions should be noted:

<b>White</b>	Indicates power is being supplied to the computer and the computer is turned on.
--------------	--

---

<b>Flashing white</b>	Indicates that the computer is in Sleep Mode and that there is sufficient power available (AC adaptor or battery) to maintain this condition.
<b>No light</b>	Under any other conditions, the indicator does not light.

---

---

# Chapter 4

## Operating Basics

This chapter describes the basic operations of your computer, and highlights the precautions that should be taken when using it.

### Using the Touch Screen

Some models are equipped with a touch screen.

You can use your finger to manipulate icons, buttons, menu items, the onscreen keyboard, and other items on the touch screen.

**Tap**

Simply tap your finger once on the touch screen to activate an item, such as an app.

**Press and hold**

Press your finger down and leave it there for a few seconds. This will show information to help you learn more about an item or will open a menu specific to what you are doing.

**Pinch or stretch**

Touch the screen or an item with two or more fingers, and then move the fingers toward each other (pinch) or away from each other (stretch). This will show different levels of information or visually zooms in or out.

**Rotate**

Put two or more fingers on an item and then turn your hand to rotate things in the direction you turn your hand. Only some items can be rotated.

**Slide**

Drag your finger on the touch screen to move through what's on the screen.



## Swipe

Quickly move your finger in from the edge of the screen, without pausing when you first touch it.

Swipe from the left edge: shows your recently opened apps, and so on.

Swipe from the right edge: opens or closes the charms (Search, Share, Start, Devices, Settings).

Swipe from the top edge: opens or closes the app command bar.

---

For details and more advanced touch screen gestures to interact with Windows 8, please refer to Help and Support.

## Using the Touch Pad

The Touch Pad located in the palm rest may support the following gestures:



### Tap

Tap once on the Touch Pad to activate an item, such as an app.



### Two-Finger Tap

Tap once on the Touch Pad with two fingers together to display a menu or other function depending on the software you are using. (Similar to right-click)



### Pinch or stretch

Place two or more fingers down on the Touch Pad and move them toward each other (pinch) or away from each other (stretch). This will show different levels of information or visually zooms in or out.



### Two-Finger Scroll

Place two fingers down and slide them vertically or horizontally from anywhere on the Touch Pad. This allows you to operate the scroll bars of a window.





## Swipe

Quickly move your finger in from the edge of the Touch Pad, without pausing when you first touch it.

Swipe from the left edge: shows your recently opened apps.

Swipe from the right edge: opens or closes the charms (Search, Share, Start, Devices, Settings).

Swipe from the top edge: opens or closes the app command bar.



*Some of the Touch Pad operations described in this section are only supported in certain applications.*

## The Keyboard

The number of keys available on your keyboard will depend on which country/region your computer is configured for, with keyboards being available for numerous languages.

There are different types of keys, specifically typewriter keys, function keys, soft keys, Windows special keys and the keypad overlay.



*Never remove the key caps on your keyboard. Doing so could cause damage to the parts under the key caps.*

### Keyboard indicator

The following figure shows the position of the **CAPS LOCK** indicator which shows the following condition:

- When the **CAPS LOCK** indicator glows, the keyboard will produce capitals when any letter is typed.

*Figure 4-1 Keypad indicators*

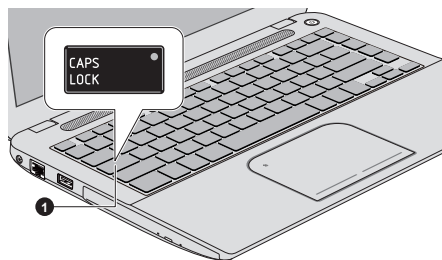

1. CAPS LOCK indicator

#### **CAPS LOCK**

This indicator glows green when letter keys are locked into their uppercase format.

## Function Key

The function keys (F1 ~ F12) are the twelve keys at the top of your keyboard.



You can configure the function keys mode as "Special function mode" or "Standard F1-F12 mode" by clicking **Desktop -> Desktop Assist -> Tools & Utilities -> System Settings -> Keyboard**.

"Special function mode" allows you to use special functions without pressing the **FN** key.

Special function mode	Standard F1-F12 mode	Function
F1	FN + F1	Launches the help file supplied with the software.
F2	FN + F2	Decreases the computer's display panel brightness in individual steps.
F3	FN + F3	Increases the computer's display panel brightness in individual steps.
F4	FN + F4	Changes the active display device. To use a simultaneous mode, you must set the resolution of the internal display panel to match the resolution of the external display device.
F5	FN + F5	Enables or disables the Touch Pad.
F6	FN + F6	Moves media backward.
F7	FN + F7	Plays or pauses media playback.
F8	FN + F8	Moves media forward.
F9	FN + F9	Decreases the computer's volume.
F10	FN + F10	Increases the computer's volume.
F11	FN + F11	Turns the sound on or off.
F12	FN + F12	Turns the Airplane mode on or off.
FN + 1	FN + 1	Reduces the icon size on the desktop or the font sizes within one of the supported application windows.
FN + 2	FN + 2	Enlarges the icon size on the desktop or the font sizes within one of the supported application windows.

Special function mode	Standard F1-F12 mode	Function
FN + Space	FN + Space	Changes the display resolution.
FN + Z	FN + Z	Turns the keyboard backlight on or off. This function is supported with some models



*Some functions will show the toast notification at the edges of the screen.*

*Those toast notifications are disabled at factory default. You can enable them in the TOSHIBA Function Key application.*

*To access it, click **Desktop -> Desktop Assist -> Tools & Utilities -> Function Key.***

## Windows special keys

The keyboard provides two keys that have special functions in Windows, the Windows Start Button key activates the **Start screen** while the application key has the same function as the secondary (right) mouse button.



This key activates the Windows **Start screen** .



This key has the same function as the secondary (right) mouse button.

## Generating ASCII characters

Not all ASCII characters can be generated using normal keyboard operation, but you are able to generate these characters using their specific ASCII codes.

1. Hold down the **ALT** key.
2. Using the numeric keypad, type the ASCII code of the character you require.
3. Release **ALT** - the ASCII character will appear on the display screen.

## Optical disc drives

The computer may be installed with a DVD Super Multi drive, Blu-ray™ Combo drive or Blu-ray™ Writer drive (BDXL™). When the computer is accessing an optical disc, the indicator on the drive glows.

## Formats

The drives support the following formats.

---

### ***DVD Super Multi drive***

The drive supports the following formats: CD-ROM, DVD-ROM, DVD-Video, CD-DA, CD-Text, Photo CD™ (single/multi-session), CD-ROM Mode 1/Mode 2, CD-ROM XA Mode 2 (Form1, Form2), Enhanced CD (CD-EXTRA), Addressing Method 2, DVD-R, DVD-RW, DVD+R, DVD+RW, DVD-RAM, DVD-R DL (Format1), DVD+R DL.

### ***Blu-ray™ Combo drive***

In addition to the above formats, Blu-ray™ Combo drive supports BD-ROM and BD-ROM DL.

### ***Blu-ray™ Writer drive***

In addition to the above formats, Blu-ray™ Writer drive supports BD-R, BD-R DL, BD-RE and BD-RE DL.

### ***Blu-ray™ Writer drive BDXL™***

In addition to the above formats, Blu-ray™ Writer drive BDXL™ supports BD-R TL, BD-R QL and BD-RE TL.



*Some types and formats of DVD-R DL and DVD+R DL discs may be unreadable.*

## **Using optical disc drives**

The full-size drive provides high-performance execution of disc based programs. You can run either 12 cm (4.72") or 8 cm (3.15") discs without an adaptor.



*Use the DVD playback application to view DVD-Video discs.*

For precautions on writing to discs, refer to the [Writing discs](#) section.

To load discs, follow the steps as detailed below:

1. When the computer's power is on, press the eject button to open the disc tray slightly.

2. Grasp the disc tray gently and pull until it is fully opened.

*Figure 4-2 Pressing the eject button and pulling the disc tray open*

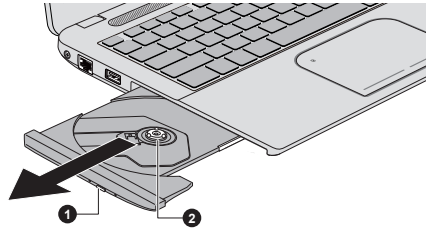

1. Eject button

2. Disc tray

3. Lay the disc, label side up, in the disc tray.

*Figure 4-3 Inserting a disc*

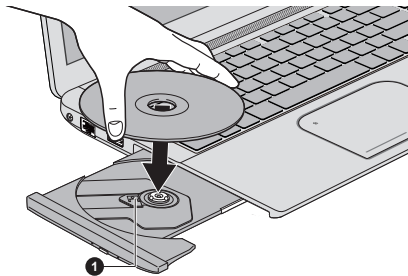

1. Laser lens



*When the disc tray is fully opened, the edge of the computer will cover the disc tray slightly. Therefore, you will need to turn the disc at an angle when you place it in the disc tray. After seating the disc, however, make sure it lies flat.*



- *Do not touch the laser lens or any portion of its surrounding casing as this could cause misalignment.*
- *Prevent foreign objects from entering the drive. Check the surface of the disc tray, especially the area behind the front edge of the disc tray, to make sure there are no such objects before closing the drive.*

4. Press gently at the center of the disc until you feel it click into place. The disc should lie below the top of the spindle, flush with the spindle base.
5. Push the center of the disc tray to close it. Press gently until it locks into place.



*If the disc is not seated properly when the disc tray is closed, the disc might be damaged. Also, the disc tray might not open fully when you press the eject button.*

## Removing discs

To remove the disc, follow the steps as detailed below:



*Do not press the eject button while the computer is accessing the optical disc drive. Wait for the optical disc drive indicator to go out before you open the disc tray. Also, if the disc is spinning when you open the disc tray, wait for it to stop before you remove it.*

1. To pop the disc tray partially open, press the eject button. Gently pull the disc tray out until it is fully opened.



*When the disc tray pops open slightly, wait a moment to make sure the disc has stopped spinning before pulling the disc tray fully open.*

2. The disc extends slightly over the sides of the disc tray so you can grasp it. Gently lift out the disc.
3. Push the center of the disc tray to close it. Press gently until it locks into place.

## How to remove disc when the disc tray will not open

Pressing the eject button will not open the disc tray when the computer power is off. If the power is off, you can open the disc tray by inserting a slender object (about 20 mm) such as a straightened paper clip into the manual eject hole near the eject button.

Figure 4-4 Manual release with the eject hole

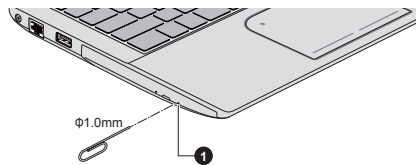

1. Manual Eject hole



*Turn off the power before you use the manual eject hole. If the disc is spinning when you open the disc tray, the disc could fly off the spindle and cause injury.*

## Writable discs

This section describes the types of writable discs. Check the specifications of your drive to see the types of discs it can write.

### CDs

- CD-R discs can be written only once. The recorded data cannot be erased or changed.

- CD-RW discs including multi speed CD-RW discs, high-speed CD-RW discs and ultra-speed CD-RW discs can be recorded more than once.

### **DVDs**

- DVD-R, DVD+R, DVD-R DL and DVD+R DL discs can be written only once. The recorded data cannot be erased or changed.
- DVD-RW, DVD+RW and DVD-RAM discs can be recorded more than once.

### **Blu-ray™ discs**

- BD-R, BD-R DL, BD-R TL and BD-R QL discs can be written only once. The recorded data cannot be erased or changed.
- BD-RE, BD-RE DL and BD-RE TL discs can be recorded more than once.

## **Writing discs**

You can use the DVD Super Multi drive or Blu-ray™ Combo drive to write data to either CD-R, CD-RW, DVD-R, DVD-R DL, DVD-RW, DVD+R, DVD+R DL, DVD+RW or DVD-RAM discs.

You can use the Blu-ray™ Writer drive to write data to either CD-R, CD-RW, DVD-R, DVD-R DL, DVD-RW, DVD+R, DVD+R DL, DVD+RW, DVD-RAM, BD-R, BD-R DL, BD-RE or BD-RE DL discs.

You can use the Blu-ray™ Writer drive BDXL™ to write data to either CD-R, CD-RW, DVD-R, DVD-R DL, DVD-RW, DVD+R, DVD+R DL, DVD+RW, DVD-RAM, BD-R, BD-R DL, BD-RE, BD-RE DL, BD-R TL, BD-R QL or BD-RE TL discs.



*When writing information to media using an optical drive, you should always ensure that you connect the AC adaptor to a live electrical outlet. It is possible that, if data is written while powered by the battery pack, the write process may sometimes fail due to low battery power - in these instances data loss may occur.*

### **Important message**

Before you write or rewrite to any of the media supported by the optical disc drive, please read and follow all of the setup and operating instructions in this section. If you fail to do so, you may find that the optical disc drive may not function properly, and you may fail to write or rewrite information successfully - this may cause you to either lose data or incur other damage to the drive or media.

### **Disclaimer**

TOSHIBA does not assume responsibility for the following:

- 
- Damage to any disc that may be caused by writing or rewriting with this product.
  - Any change or loss of the recorded contents of media that may be caused by writing or rewriting with this product, or for any business profit loss or business interruption that may be caused by the change or loss of the recorded contents.
  - Damage that may be caused by using third party equipment or software.

Given the technological limitations of current optical disc writing drives, you may experience unexpected writing or rewriting errors due to disc quality or problems with hardware devices. In view of this, it is good practice to make two or more copies of important data, in case of any undesired change or loss of the recorded contents.

## Before writing or rewriting

- Based on TOSHIBA's limited compatibility testing, we suggest the following manufacturers of disc media, however, it must be noted that disc quality can affect write or rewrite success rates. Please also be aware that in no event does TOSHIBA guarantee the operation, quality or performance of any disc.

### **CD-R:**

TAIYO YUDEN CO., Ltd.

MITSUBISHI KAGAKU MEDIA CO., LTD.

### **CD-RW: (Multi-Speed, High-Speed and Ultra-Speed)**

MITSUBISHI KAGAKU MEDIA CO., LTD.

### **DVD-R:**

#### **DVD Specifications for Recordable Disc for General Version 2.0**

TAIYO YUDEN Co.,Ltd. (for 8x and 16x speed media)

MITSUBISHI KAGAKU MEDIA CO., LTD. (for 8x and 16x speed media)

Hitachi Maxell, Ltd. (for 8x and 16x speed media)

### **DVD-R DL:**

MITSUBISHI KAGAKU MEDIA CO., LTD. (for 4x and 8x speed media)

### **DVD+R:**

MITSUBISHI KAGAKU MEDIA CO., LTD. (for 8x and 16x speed media)

TAIYO YUDEN CO., Ltd. (for 8x and 16x speed media)

### **DVD+R DL:**

MITSUBISHI KAGAKU MEDIA CO., LTD. (for 8x speed media)



---

**DVD-RW:****DVD Specifications for Recordable Disc for Version 1.1 or version 1.2**

Victor Company of Japan, Ltd. (JVC) (for 2x, 4x and 6x speed media)

MITSUBISHI KAGAKU MEDIA CO., LTD. (for 2x, 4x and 6x speed media)

**DVD+RW:**

MITSUBISHI KAGAKU MEDIA CO., LTD. (for 4x and 8x speed media)

**DVD-RAM: (DVD Super Multi drive only)****DVD Specifications for DVD-RAM Disc for Version 2.0, Version 2.1 or Version 2.2**

Panasonic Corporation (for 3x and 5x speed media)

Hitachi Maxell, Ltd. (for 3x and 5x speed media)

**BD-R:**

Panasonic Corporation

**BD-R DL:**

Panasonic Corporation

**BD-RE:**

Panasonic Corporation

**BD-RE DL:**

Panasonic Corporation

**BD-R TL:**

TDK.

SHARP

**BD-RE TL:**

Panasonic Corporation



- *Some types and formats of DVD-R DL and DVD+R DL discs may be unreadable.*
- *Disc created in DVD-R DL format4 (Layer Jump Recording) cannot be read.*

***When writing or rewriting***

Please observe the following points while you write or rewrite data to a media:

- 
- Always copy data from the hard disk drive to the optical media - do not use the cut-and-paste function as the original data will be lost if there is a write error.
- Do not perform any of the following actions:
- Change users in the Operating Systems.
  - Operate the computer for any other function, including such tasks as using a mouse or Touch Pad, or closing/opening the display panel.
  - Start a communication application.
  - Apply impact or vibration to the computer.
  - Install, remove or connect external devices, including such items as a memory media card, USB device, external monitor or an optical digital device.
  - Use the audio/video control button to reproduce music or voice.
  - Open the optical disc drive.
- Do not use shut down, log off, Sleep Mode or Hibernation Mode functions while writing or rewriting.
  - Make sure that the write/rewrite operation is completed before going into either Sleep Mode or Hibernation Mode (You can remove an optical media on the optical disc drive after writing is completed).
  - If the media is of poor quality, or is dirty or damaged, writing or rewriting errors may occur.
  - Set the computer on a level surface and avoid places subject to vibration such as airplanes, trains or cars. In addition, do not use the computer on an unstable surface such as a stand.
  - Keep mobile phones and other wireless communication devices away from the computer.

## TOSHIBA VIDEO PLAYER

Please be aware of the following limitations when you use the TOSHIBA VIDEO PLAYER:

### Notes on use

- This software can only be used on Windows 8.
- TOSHIBA VIDEO PLAYER software is supported for playback of DVD and video file.
- Frame dropping, audio skipping or out of sync audio and video may occur during playback of some video titles.
- Close all other applications when using the TOSHIBA VIDEO PLAYER. Do not open any other applications or carry out any other operations during video playback. Playback may stop or not function properly in some situations.
- Unfinalized DVDs created on home DVD recorders may not be playable on the computer.
- Use DVD-Video discs with a region code which is either "the same as the factory default setting" (if applicable) or "ALL".

- 
- Do not playback video while watching or recording television programs using other applications. Doing so may cause video playback or television program recording errors. In addition, if prescheduled recording starts during video playback it may cause video playback or television program recording errors. Please view video during times when there is no recording prescheduled.
  - The resume function cannot be used with some discs on the TOSHIBA VIDEO PLAYER.
  - It is recommended the AC adaptor be connected when playing video. Power saving features may interfere with smooth playback. When playing video using battery power, set the Power Options to "Balance".
  - The screen saver is disabled during video playback using the TOSHIBA VIDEO PLAYER. The computer will not automatically go into Hibernation, Sleep, or shut-down mode.
  - Do not configure the Display automatic power off function to run while the TOSHIBA VIDEO PLAYER is running.
  - Do not switch to Hibernation or Sleep Mode when running the TOSHIBA VIDEO PLAYER.
  - Do not lock the computer using the Windows logo (  ) + L keys when running the TOSHIBA VIDEO PLAYER.
  - The TOSHIBA VIDEO PLAYER does not have a parental control function.
  - In order to protect copyrights, the Windows Print Screen function is disabled when TOSHIBA VIDEO PLAYER is running.
  - (Print Screen functions are disabled even when running other applications besides TOSHIBA VIDEO PLAYER and when TOSHIBA VIDEO PLAYER is minimized.) Please close the TOSHIBA VIDEO PLAYER to use the Print Screen function.
  - Carry out the installation/uninstallation of the TOSHIBA VIDEO PLAYER under a user account with administrator rights.
  - Do not change Windows Users while TOSHIBA VIDEO PLAYER is running.
  - For some DVD or video files, using the control window to change the audio track will also change the subtitle track.
  - This software can only playback MPEG2, MP4 and WTV files created by the preinstalled applications on the same computer. Playback may not function properly if you use the files other than these types.

## Display Devices & Audio

- If the video image is not displayed on an external display or television, stop the TOSHIBA VIDEO PLAYER, and change the screen resolution. To change the screen resolution, click **Desktop -> Desktop Assist -> Control Panel -> Appearance and Personalization -> Display -> Adjust resolution**. However, video cannot be output to some external displays and televisions due to output or playback conditions.

- 
- When viewing video on an external display or TV, change the display device before playing. Video can be played only on internal LCD displays or external displays. In Clone mode (Dual View), TOSHIBA VIDEO PLAYER may not function properly.
  - Do not change the screen resolution while running the TOSHIBA VIDEO PLAYER.
  - Do not change the display device while running the TOSHIBA VIDEO PLAYER.

## Starting TOSHIBA VIDEO PLAYER

Use the following procedure to start TOSHIBA VIDEO PLAYER.

1. Insert a DVD-Video in the optical disc drive while the operating system is running.  
When a DVD-Video disc is set in the DVD drive (for models with DVD drive), TOSHIBA VIDEO PLAYER may start automatically.
2. Click **Desktop -> Desktop Assist -> Media & Entertainment -> TOSHIBA VIDEO PLAYER** to start TOSHIBA VIDEO PLAYER.

## Operating TOSHIBA VIDEO PLAYER

Notes on Using TOSHIBA VIDEO PLAYER.

- Screen display and available features may vary amongst videos and scenes.
- If the menu is opened in the Display Area using the Control window's Top Menu or Menu buttons, Touch Pad and mouse menu operations may not be able to be used.

## Open TOSHIBA VIDEO PLAYER Manual

TOSHIBA VIDEO PLAYER features and instructions are explained in details in TOSHIBA VIDEO PLAYER Manual. Use the following procedure to open TOSHIBA VIDEO PLAYER Manual.

Press the **F1** key when TOSHIBA VIDEO PLAYER is launched and click the **Help** button.

## TOSHIBA Blu-ray Disc Player

Please be aware of the following limitations when you use TOSHIBA Blu-ray Disc Player.

### Notes on Use

- This software can only be used on Windows 8.
- Playback of high bit rate content may cause frame dropping, audio skipping or decrease in computer performance.

- 
- Close all other applications before playing back video. Do not open any other applications or carry out any other operations during video playback.
  - Do not switch to Hibernation or Sleep Mode when running the TOSHIBA Blu-ray Disc Player.
  - Because Blu-ray Disc™ playback operates according to programs built into the content, operation methods, operation screens, sound effects, icons and other features may vary from disc to disc. For more information on these items refer to instructions included with content or contact the content manufacturers directly.
  - Make sure to connect the computer's AC adapter when playing a video.
  - TOSHIBA Blu-ray Disc Player supports AACS (Advanced Access Control System) copy protection technology. Renewal of the AACS key integrated into this product is required for uninterrupted enjoyment of Blu-ray Disc™. An Internet connection is required for renewal.
  - AACS key renewal is provided free of charge for 5 years after the purchase of this product, however renewal beyond 5 years is subject to conditions specified by the software provider, TOSHIBA Corporation.
  - Do not playback video while recording television programs using other applications. Doing so may cause video playback or television program recording errors. In addition, if pre-scheduled recording starts during video playback it may cause video playback or television program recording errors. Please view video during times when there is no recording prescheduled.
  - While playing a BD-J title, keyboard shortcut is ineffective.
  - Resume play function cannot be used with some discs on TOSHIBA Blu-ray Disc Player.
  - The interactive function on Blu-ray™ discs may not work depending on the contents or network situation.
  - Blu-ray™ drives and their associated media are manufactured according to the specifications of three marketing regions. Region codes can be set from TOSHIBA Blu-ray Disc Player. (Click the **Setting** button in the Display Area. And click the **Region** Menu). When you purchase Blu-ray™ Video, make sure it matches your drive, otherwise it will not play properly.
  - To playback video on an external display or TV using TOSHIBA Blu-ray Disc Player, use output devices like external displays or TV that have HDCP supported HDMI port. The video cannot be displayed on an external display or TV connected to the RGB connector.
  - The Blu-ray Disc™ movie can be played only on internal LCD displays or external devices connected via an HDMI output. In Clone mode (Dual View), TOSHIBA Blu-ray Disc Player may not function properly.
  - This product does not play HD DVD discs. Blu-ray™ discs with high definition content are required for HD viewing.

- This software can only playback MPEG2, MP4 and WTV files created by the preinstalled applications on the same computer. Playback may not function properly if you use the files other than these types.

## Starting TOSHIBA Blu-ray Disc Player

Use the following procedure to start TOSHIBA Blu-ray Disc Player.

- Insert a Blu-ray™ Movie Disc in the optical disc drive while the operating system is running.

When a Blu-ray™ Movie Disc is set in the Blu-ray™ drive (for models with Blu-ray™ drive), TOSHIBA Blu-ray Disc Player may start automatically.

- Click **Desktop -> Desktop Assist -> Media & Entertainment -> TOSHIBA Blu-ray Disc Player.**

## Operating TOSHIBA Blu-ray Disc Player

Notes on using TOSHIBA Blu-ray Disc Player.

- Screen display and available features may vary amongst Blu-ray™ Videos and scenes.
- If the menu is opened in the Display Area using the Control window's Top Menu or Menu buttons, Touch Pad and mouse menu operations may not be able to be used.

## Open TOSHIBA Blu-ray Disc Player Manual

TOSHIBA Blu-ray Disc Player features and instructions are explained in details in TOSHIBA Blu-ray Disc Player Manual.

Use the following procedure to open TOSHIBA Blu-ray Disc Player Manual.

- Press the **F1** key when TOSHIBA Blu-ray Disc Player is launched and click the **Help** button.

## 3D Playback on an External 3D Device

3D playback on an external 3D device feature is only provided with some models.

Effect of 3D can be shown only on an external 3D devices connected via an HDMI output. It cannot be shown on the internal display. In order for 3D playback to work on external display/TV, you need a 3D enabled display/TV that has an HDCP compliant HDMI port.



*3D playback feature supports the following resolutions: 1920x1080 24Hz and 1280x720 60Hz.*

*Please change the Screen Resolution to one of the above before using 3D playback function.*

---

## Important Safety Information for 3D Function

- Please refrain from or stop viewing if you feel ill or experience discomfort before or while watching 3D video images.
- Please refrain from viewing 3D video images if you experience convulsions, photosensitivity reaction, or heart disease.
- Due to the possibility of impact on vision development, viewers of 3D video images should be aged 6 or older. Children and teenagers may be more susceptible to health issues associated with viewing in 3D and should be closely supervised to avoid prolonged viewing without rest.
- Avoid use of the 3D function when under the influence of alcohol.
- Please read the user's manual that comes with the computer carefully before using the 3D playback function.
- The 3D effect differs between individuals.

## Notes on 3D Playback for TOSHIBA VIDEO PLAYER

TOSHIBA VIDEO PLAYER has 3D playback function, which can playback 3D video content, and 2D home video content (DVD or video file) in 3D using real-time 2Dto3D conversion.

- Effect of 3D can be shown only on an external 3D devices connected via an HDMI output. It cannot be shown on the internal display.
- The 2Dto3D conversion function uses TOSHIBA's original algorithm to apply a 3D effect to your own 2D videos. However, note that this function does not provide the same video content as a video originally provided in 3D, and does not create a new video in the 3D format but only plays 2D videos in a 3D like mode.
- The 2Dto3D conversion function is meant for the enjoyment of your own 2D home video and other 2D contents you created, in 3D according to your personal preferences.
- The TOSHIBA VIDEO PLAYER is set by default in the 2D format. By pressing the 2Dto3D conversion function button, you decide to activate the 2Dto3D conversion function and therefore decide to watch your 2D content in 3D. The TOSHIBA VIDEO PLAYER will not run the 2Dto3D conversion function automatically. Please see the warnings in this section as regard to potential copyright infringement and confirm you have any necessary authorization.

- 
- The TOSHIBA VIDEO PLAYER is intended for playing DVD-Video, DVD-VR and video files and for viewing 2D home video content in 3D. The 3D playback of any video content not created by the user may require the permission of third parties, where such content is protected by copyright. The protection of intellectual property rights is essential for TOSHIBA. In this respect, TOSHIBA underlines that the Player should not be used in a manner infringing such rights. It is your responsibility to ensure that you do not infringe any applicable intellectual property laws when you decide to use the Player and, more specifically, the 2Dto3D conversion function of the TOSHIBA VIDEO PLAYER.
  - Some functions are not functionable during 3D playback. In such cases, any corresponding buttons will be disabled.
  - You may experience some time lag if you perform any of the following operations when the “Video Display Window” is at full-screen size.
    - Bring up windows such as [Right-Click Menu], [Settings Window], [Title/Chapter Search], [File Select] or [Error Message].
    - Operate on Windows
    - Operate on other applications
  - Please make sure AC adapter is used when playing with the enabled 3D playback feature.
  - 3D playback occurs only in full-screen size. When you enable 3D playback, the “Video Display Window” automatically enlarges to fullscreen size.
  - In order for 3D playback to work on external display/TV, you need a 3D enabled display/TV that has an HDCP compliant HDMI port.
  - 3D video content can only be displayed on external display using HDMI “with 3D”.
  - The 3D effect differs among individuals.
  - Viewing 3D playback may cause discomfort. In this case, please stop viewing and consult your doctor.
  - Please consider if it is suitable or a need for time limit before allowing your child to watch a 3D content.
  - Depending on the lighting condition of your room, you may experience some flickerings when you have the 3D glasses on.
  - Upconvert and 3D Playback functions cannot be used at the same time. Switching to 3D playback while upconvert is running will cause the upconvert function to switch off automatically.
  - Depending on the video content, it might not be able to playback in 3D.
  - Only Side-by-Side and Interleave 3D video formats are supported for playback of 3D video content.



---

## Notes on 3D Playback for TOSHIBA Blu-ray Disc Player

The 3D playback function can playback 3D video content, and your 2D home video content and other 2D content created by you (DVD or video file) in 3D using real-time 2Dto3D conversion.

- The 3D playback function CANNOT be used to playback 2D video contents of Blu-ray Disc or AVCHD in 3D using real-time 2Dto3D conversion.
- The Player's 3D playback function is meant for only personal home use. Please take note that applicable copyright laws may prohibit the public display when you offer 3D viewing of third party video contents to unidentified persons or mass public.
- The 2Dto3D conversion function uses TOSHIBA's original algorithm to apply a 3D effect to your own 2D videos. However, note that this function does not provide the same video content as a video originally provided in 3D, and does not create a new video in the 3D format but only plays 2D videos in a 3D like mode.
- The picture generated by 2Dto3D conversion function is not the same as a picture produced for 3D playback use. The 2Dto3D conversion function simply uses TOSHIBA's original algorithm to apply pseudo 3D effect to the 2D content.
- The Player is set by default in the 2D format. By pressing the 2Dto3D conversion function button, you decide to activate the 2Dto3D conversion function and therefore decide to watch your 2D content in 3D. The Player will not run the 2Dto3D conversion function automatically. Please see the warnings in this section as regards potential copyright infringement and confirm you have any necessary authorization.
- The Player is intended for playing DVD-Video, DVD-VR and video files and for viewing 2D home video content and other 2D content created by you in 3D. The 3D playback of any video content not created by the user may require the direct or indirect permission of third parties, where such content is protected by copyright, unless otherwise permitted under applicable law. The protection of intellectual property rights is essential for TOSHIBA. In this respect, TOSHIBA underlines that the Player should not be used in a manner infringing such rights. It is your responsibility to ensure that you do not infringe any applicable intellectual property laws when you decide to use the Player and, more specifically, when you decide to activate the 2Dto3D conversion function of the Player.
- Some functions cannot be used during 3D playback. In such cases, any buttons used for those functions may be disabled.

- 
- Depending on the system environment, the player may automatically switch into 2D if you perform any of the following operations during 3D playback. Furthermore, you may experience some time lag when the switching occurs.
    - Opening windows or pop-ups such as [Right-Click Menu], [Settings Window], [File Select] or [Error Message].
    - Using Windows features.
    - Using any other applications.
  - Please make sure to use AC adapter when playing with 3D playback feature enabled.
  - Depending on the system environment, 3D playback may only be used when the "Video Display Window" is at full-screen. 3D playback may not function when windowed.
  - In order for the 3D playback to work on an external display/TV, you need a 3D enabled display/TV that has an HDCP compliant HDMI port.
  - 3D video content can only be displayed on an external display connected using HDMI "with 3D".
  - 3D Settings can be changed on the "Settings" Screen, but the default settings are highly recommended. Changing the settings may cause the 3D stereoscopic effect to become stronger, which in turn may cause eye fatigue.
  - The 3D effect differs between individuals. Please refrain from or stop viewing and check your equipment settings, if you can see doubly-substituted video images or cannot feel the 3D stereoscopic effect when watching 3D video images. Still, if you cannot see correctly, please refrain from or stop viewing.
  - Please refrain from or stop viewing if you feel ill or experience discomfort before or while watching 3D video images.
  - Please position yourself directly in front of the display when watching 3D video images. And please take regular breaks in between.
  - Due to the possibility of impact on vision development, viewers of 3D video images should be aged 6 or older.
  - Please consider whether it is suitable or is there a need for limiting the viewing time before allowing your child to watch a 3D content.
  - This software does not have parental lock for 3D video viewing. Please use the login-password functions of Windows if you are worried about the effect of 3D playback on your child's visual function.
  - This software can playback MPEG2, MP4, and WTV files. Your own 2D video contents recorded using home video camcorder and other content created by you can be played in either 2D, or 3D using real-time 2Dto3D conversion. As for playback of 3D video content, only Side-by-Side and Interleave 3D video formats are supported.
  - Not all files can be played.

---

# Battery

This section explains battery types, use, recharging methods and handling.

## Battery types

The computer has different types of batteries.

### **Battery pack**

When the AC adaptor is not connected, the computer's main power source is this lithium ion battery pack, also referred to in this manual as the main battery.

### **Real Time Clock (RTC) battery**

The Real Time Clock (RTC) battery provides power for the internal real time clock and calendar function and also maintains the system configuration while the computer is turned off. If the RTC battery becomes completely discharged, the system will lose this information and the real time clock and calendar will stop working.

You can change the Real Time Clock settings in the BIOS setup utility. Please refer to [Troubleshooting](#) for further information.

## Care and use of the battery pack

This section provides the important safety precautions in order to handle your battery pack properly.

Refer to the enclosed **Instruction Manual for Safety and Comfort** for detailed precautions and handling instructions.



- *The computer's RTC battery is a lithium ion battery and should be replaced only by your dealer or by a TOSHIBA service representative. The battery can explode if not properly replaced, used, handled or disposed. Dispose of the battery as required by local ordinances or regulations.*
- *Charge the battery pack only in an ambient temperature between 5 and 35 degrees Celsius. Otherwise, the electrolyte solution might leak, battery pack performance might deteriorate and the battery life might be shortened.*

## Charging the batteries

When the power in the battery pack becomes low, the **DC IN/Battery** indicator will flash amber to indicate that only a few minutes of battery power remain. If you continue to use the computer while the **DC IN/Battery** indicator flashes, the computer will enable Hibernation Mode so that you do not lose any data, and automatically turn itself off.

You must recharge a battery pack when it becomes discharged.

---

## Procedures

To recharge a battery pack, connect the AC adaptor to the DC IN 19V jack and plug the other end into a working outlet - the **DC IN/Battery** indicator will glow amber while the battery is being charged.

## Charging Time

The following table shows the approximate time required to fully charge a discharged battery.

Battery type	Power off	Power on
Battery pack (43Wh, 4 cell)	about 3 hours	about 12 hours



*Please be aware that the charging time when the computer is on is affected by ambient temperature, the temperature of the computer and how you are using the computer - if you make heavy use of external devices for example, the battery might scarcely charge at all during operation.*

## Battery charging notice

The battery may not begin charging immediately under the following conditions:

- The battery is extremely hot or cold (if the battery is extremely hot, it might not charge at all). To ensure the battery charges to its full capacity, you should charge it at room temperature of between 5°C to 35°C (41°F to 95°F).
- The battery is nearly completely discharged. In this instance you should leave the AC adaptor connected for a few minutes and the battery should begin charging.

The **DC IN/Battery** indicator may show a rapid decrease in battery operating time when you try to charge a battery under the following conditions:

- The battery has not been used for a long time.
- The battery has completely discharged and been left in the computer for a long time.

In such cases you should follow the steps as detailed below:

1. Fully discharge the battery by leaving it in the computer with the power on until the system automatically turns itself off.
2. Connect the AC adaptor to the DC IN 19V jack of the computer, and to a wall outlet that is supplying power.
3. Charge the battery until the **DC IN/Battery** indicator glows white.

Repeat these steps two or three times until the battery recovers normal capacity.

---

## Monitoring battery capacity

Remaining battery power can be monitored using the following methods.

- Clicking the battery icon on the Taskbar
- Via the Battery Status in the Windows Mobility Center window



- *You should wait at least 16 seconds after turning on the computer before trying to monitor the remaining operating time. This is because the computer needs this time to check the battery's remaining capacity and then calculate the remaining operating time, based on this together with the current power consumption.*
- *Please be aware that the actual remaining operating time may differ slightly from the calculated time.*
- *With repeated discharges and recharges, the battery's capacity will gradually decrease. In view of this it will be noted that an often used, older battery will not operate for as long as a new battery even when both are fully charged.*

## Maximizing battery operating time

A battery's usefulness depends on how long it can supply power on a single charge, while how long the charge lasts in a battery depends on:

- Processor speed
- Screen brightness
- System Sleep Mode
- System Hibernation Mode
- Display power off period
- Hard Disk Drive power off period
- How often and for how long you use the Hard Disk Drive and external disk drives, for example, optical disc.
- How much charge the battery contained to begin with.
- How you use optional devices, such as a USB device, to which the battery supplies power.
- Whether you enable Sleep Mode, which can conserve battery power if you are frequently turning the computer off and on.
- Where you store your programs and data.
- Whether you close the display panel when you are not using the keyboard - closing the display saves power.
- The environmental temperature - operating time decreases at low temperatures.
- Whether you enable Sleep and Charge function.

## Batteries exhausted time

When you turn off the power of your computer with batteries fully charged, the batteries will be exhausted within the following approximate period.

---

Battery type	Sleep Mode	Shut Down Mode
Battery pack (43Wh, 4 cell)	about 3 days	about 30 days

---

## Extending battery life

To maximize the life of your battery packs:

At least once a month, disconnect the computer from a power source and operate it on battery power until the battery pack fully discharges. Before doing so, follow the steps as detailed below.

1. Turn off the computer's power.
2. Disconnect the AC adaptor and turn on the computer's power - if it does not turn on then go to Step 4.
3. Operate the computer on battery power for five minutes. If you find that the battery pack has at least five minutes of operating time, continue operating until the battery pack is fully discharged, however, if the **DC IN/Battery** indicator flashes or there is some other warning to indicate a low battery condition, go to Step 4.
4. Connect the AC adaptor to the DC IN 19V jack of the computer, and to a wall outlet that is supplying power. The **DC IN/Battery** indicator should glow amber to indicate that the battery pack is being charged, however, in the event that **DC IN/Battery** indicator does not glow this indicates that power is not being supplied - check the connections for the AC adaptor and the power cord.
5. Charge the battery pack until the **DC IN/Battery** indicator glows white.

## LAN

The computer has built-in support for Ethernet LAN (10 megabits per second, 10BASE-T), Fast Ethernet LAN (100 megabits per second, 100BASE-TX) or Gigabit Ethernet LAN (1000 megabits per second, 1000BASE-T).

This section describes how to connect/disconnect to a LAN.



*Do not install or remove a memory module while Wake-up on LAN is enabled.*



■ *The Wake-up on LAN function consumes power even when the system is off. Leave the AC adaptor connected while using this feature.*

- 
- *The Link speed (10/100/1000 megabits per second) changes automatically depending on the network conditions (connected device, cable or noise and so on).*

## LAN cable types



*The computer must be configured properly before connecting to a LAN. Logging onto a LAN using the computer's default settings could cause a malfunction in LAN operation. Check with your LAN administrator regarding set-up procedures.*

If you are using Gigabit Ethernet LAN (1000 megabits per second, 1000BASE-T), be sure to connect with a CAT5e cable or higher. You cannot use a CAT3 or CAT5 cable.

If you are using Fast Ethernet LAN (100 megabits per second, 100BASE-TX), be sure to connect with a CAT5 cable or higher. You cannot use a CAT3 cable.

If you are using Ethernet LAN (10 megabits per second, 10BASE-T), you can connect with a CAT3 or higher cable.

## Connecting the LAN cable



To connect the LAN cable, follow the steps as detailed below:

- *Connect the AC adaptor before connecting the LAN cable. The AC adaptor must remain connected during LAN use. If you disconnect the AC Adaptor while the computer is accessing a LAN, the system may hang up.*
- *Do not connect any other cable to the LAN jack except the LAN cable. Otherwise, malfunctions or damage may occur.*
- *Do not connect any power supplying device to the LAN cable that is connected to the LAN jack. Otherwise, malfunctions or damage may occur.*

1. Turn off the power to all external devices connected to the computer.

2. Plug one end of the cable into the LAN jack. Press gently until you hear the latch click into place.

*Figure 4-5 Connecting the LAN cable*

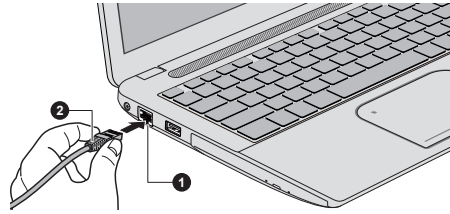

1. LAN jack

2. LAN cable

3. Plug the other end of the cable into a LAN hub connector or router. Check with your LAN administrator and hardware or software vendor before using or configuring a network connection.

## Additional memory module

You can install additional memory into the computer in order to increase the amount of system memory that is available. This section describes how to install and remove optional memory modules.



- *You should place a mat beneath the computer in order to prevent the computer's lid from becoming scratched or damaged when you are installing/replacing the memory module. In this instance you should avoid mats that are made of materials that hold or generate static electricity.*
- *When installing or removing a memory module, you must ensure that you do not touch any other internal areas of the computer.*



- *Use only memory modules approved by TOSHIBA.*
- *Do not try to install or remove a memory module under the following conditions.*
  - a. The computer is turned on.*
  - b. The computer was shut down in either Sleep or Hibernation Mode.*
  - c. Wake-up on LAN is enabled.*
  - d. The wireless communication function is on.*
  - e. Sleep and Charge function is enabled.*
- *Be careful not to let screws or other foreign matter fall into the computer. It could cause malfunction or electric shock.*



- *Additional memory module is a precision electronic component that may be fatally damaged by static electricity. Since the human body can carry static electricity, it is important that you discharge yourself before touching or installing any additional memory modules. To discharge your body's static electricity, simply touch any metal close to you with bare hands.*



*Use a point size 0 Phillips screwdriver to remove and fasten the screws - the use of an incorrect screwdriver can damage the screw heads.*

## Installing a memory module

To install a memory module, follow the steps as detailed below:

1. Click **Power** in the **Settings** charm, and then select **Restart**.
2. Hold down the **F2** key and then release this key one second after the computer is power on - the BIOS setup utility will load.

In the BIOS setup screen, select **Exit -> Disable Build-in Battery, and Power Off**.

3. Remove the AC adaptor and all cables and peripherals connected to the computer.
4. Close the display panel and turn the computer upside down.
5. Loosen the screw securing the memory module cover in place - please note that the screw is attached to the cover in order to prevent it from being lost.
6. Slide your fingernail or a thin object under the cover and lift it off.

*Figure 4-6 Removing the memory module cover*

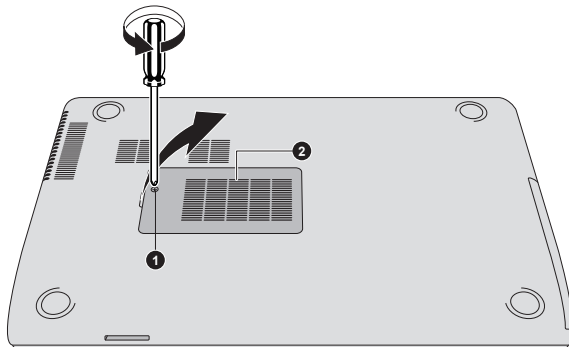

1. Screw

2. Memory module cover

Product appearance depends on the model you purchased.

7. Align the notch of the memory module with that of the memory slot and gently insert the module into the slot at about a 30 degree angle before holding it down until the latches on either side snap into place.

*Figure 4-7 Seating the memory module*

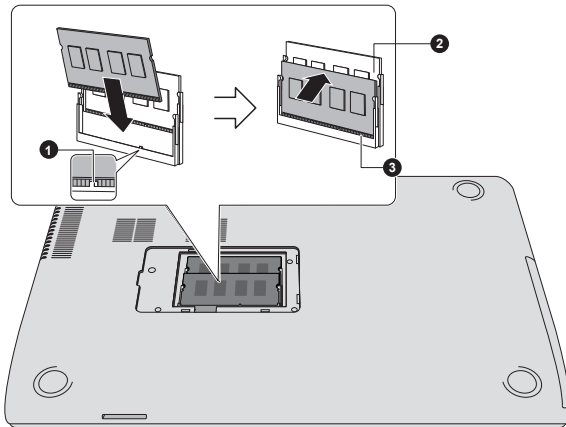

1. Notch  
2. Slot B

3. Slot A

Product appearance depends on the model you purchased.



- Never allow metal objects, such as screws, staples and paper clips, to enter the computer. Foreign metal objects can create a short circuit, which can cause computer damage and fire, possibly resulting in serious injury.
- Do not touch the connectors on the memory module or on the computer. Debris on the connectors may cause memory access problems.



- The slot A is reserved for the first memory module. Use the slot B for expanded memory. If only one module is installed, use the slot A.
- Align the grooves along the edges of the memory module with the locking tabs on the connector and insert the module into the connector firmly - if you find it difficult to install the memory module, gently prise the locking tabs outwards using the tip of your finger.
- Please also ensure that you hold the memory module along its left and right hand edges - the edges with the grooves in.

8. Seat the memory module cover in place and secure it with the screw.



*Take care to ensure that the memory module cover is firmly closed.*

*Figure 4-8 Seating the memory module cover*

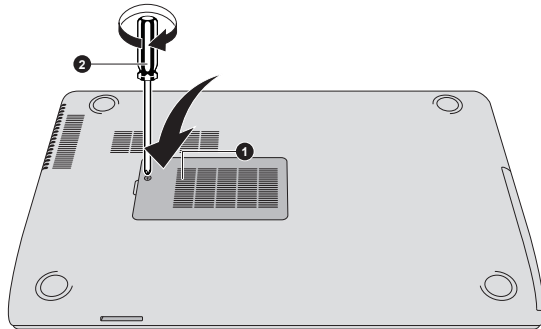

1. Memory module cover

2. Screw

*Product appearance depends on the model you purchased.*

9. Turn your computer over.
10. Connect the AC adaptor and turn the computer on. Make sure the added memory is recognized - to confirmed it, click **Desktop -> Desktop Assist -> Control Panel -> System and Security -> System**.

## Removing a memory module

To remove the memory module, follow the steps as detailed below:

1. Click **Power** in the **Settings** charm, and then select **Restart**.
2. Hold down the **F2** key and then release this key one second after the computer is power on - the BIOS setup utility will load.  
In the BIOS setup screen, select **Exit -> Disable Build-in Battery, and Power Off**.
3. Remove the AC adaptor and all cables and peripherals connected to the computer.
4. Close the display panel and turn the computer upside down.
5. Loosen the screw securing the memory module cover in place - please note that the screw is attached to the cover in order to prevent it from being lost.
6. Slide your fingernail or a thin object under the cover and lift it off.
7. Push the latches away from the module in order to release it - a spring will force one end of the module up at an angle.

8. Grasp the module by its edges and remove it from the computer.



- *If you use the computer for a long time, the memory modules and the circuits locating close to the memory modules will become hot. In this case, let them cool to room temperature before you replace them. Or you will get burnt if you touch any of them.*
- *Do not touch the connectors on the memory module or on the computer. Debris on the connectors may cause memory access problems.*

Figure 4-9 Removing the memory module

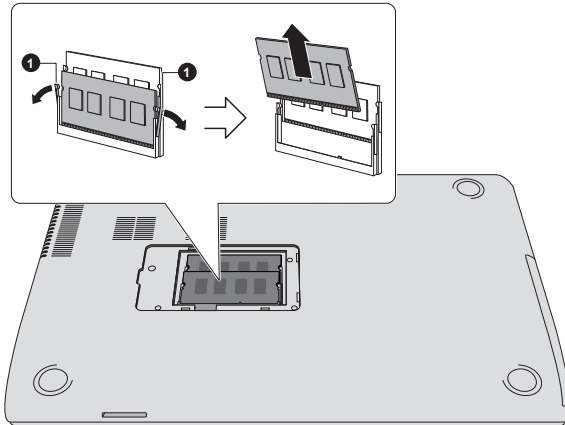

1. Latches

Product appearance depends on the model you purchased.

9. Seat the memory module cover in place and secure it with the screw.



*Take care to ensure that the memory module cover is firmly closed.*

10. Turn your computer over.
11. Connect the AC adaptor and turn the computer on.

## Memory media

The computer is equipped with a memory media slot that can accommodate some kinds of memory media with various memory capacities so that you can easily transfer data from devices, such as digital cameras and Personal Digital Assistants.



*Keep foreign objects out of the memory media slot. Never allow metal objects, such as screws, staples and paper clips, to enter the computer or Keyboard. Foreign metal objects can create a short circuit, which can cause computer damage and fire, possibly resulting in serious injury.*



- Please note that an adaptor is required to use miniSD/microSD Card.
- Please note that not all memory media have been tested and verified to work correctly. Therefore, it is not possible to guarantee that all memory media will operate properly.
- The slot does not support Magic Gate functions.

Figure 4-10 Examples of memory media



Secure Digital (SD) Card

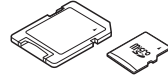

microSD card adaptor and  
microSD card



MultiMediaCard (MMC)



## Points to note about the memory media card

SD/SDHC/SDXC memory cards comply with SDMI (Secure Digital Music Initiative), which is a technology adopted to prevent unlawful copy or playback of digital music. For this reason, you cannot copy or playback protected material on another computer or other device, and you may not reproduce any copyrighted material except for your personal enjoyment.

Below is a simple explanation for distinguishing SD memory cards from SDHC memory cards and SDXC memory cards.

- SD, SDHC and SDXC memory cards appear the same externally. However, the logo on memory cards is different, so pay careful attention to the logo when purchasing.



- The SD memory card logo is (  ).
- The SDHC memory card logo is (  ).
- The SDXC memory card logo is (  ).

- The maximum capacity of SD memory cards is 2GB. The maximum capacity of SDHC memory cards is 32GB. The maximum capacity of SDXC memory cards is 64GB.

## Memory media format

New media cards are formatted according to specific standards. If you wish to reformat a media card, be sure to do so with a device that uses media cards.

---

## **Formatting a memory media card**

Memory media cards are sold already formatted in conformity to specific standards. If you reformat a memory card, be sure to reformat it with a device such as digital camera or digital audio player that uses the memory cards, not with the format command provided within Windows.



*Should you need to format all areas of the memory card, including the protected area, you will need to obtain an appropriate application that applies the copy protection system.*

## **Media care**

Observe the following precautions when handling the card.

- Do not twist or bend cards.
- Do not expose cards to liquids or store in humid areas or lay media close to containers of liquid.
- Do not touch the metal part of a card or expose it to liquids or let it get dirty.
- After using card, return it to its case.
- The card is designed so that it can be inserted only one way. Do not try to force the card into the slot.
- Do not leave a card partially inserted in the slot. Press the card until you hear it click into place.
- Set the write-protect switch to the lock position, if you do not want to record data.
- Memory cards have a limited lifespan, so it is important to backup important data.
- Do not write to a card if the battery power is low. Low power could affect writing accuracy.
- Do not remove a card while read/write is in progress.



*For more details on using memory cards, see manuals accompanying the cards.*

## **About the write-protect feature**

Memory media cards have a write-protect function.

- SD Card (SD memory card, SDHC memory card and SDXC memory card)



*Set the write-protect switch to the lock position, if you do not want to record data.*

## Inserting memory media

The following instructions apply to all types of supported media devices. To insert memory media, follow the steps as detailed below:

1. Turn the memory media so that the contacts (metal areas) face down.
2. Insert the memory media into the memory media slot on the front of the computer.
3. Press the memory media gently until it clicks into place.

Figure 4-11 Inserting memory media

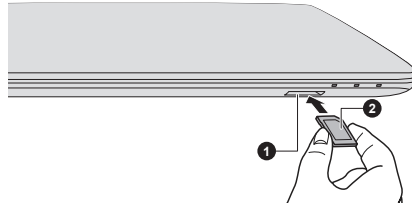

1. Memory media slot

2. Memory media



- *Make sure the memory media is oriented properly before you insert it. If you insert the media in wrong direction, you may not be able to remove it.*
- *When inserting the memory media, do not touch the metal contacts. You could expose the storage area to static electricity, which can destroy data.*
- *Do not turn the computer off or switch to Sleep Mode or Hibernation Mode while files are being copied - doing so may cause data to be lost.*

## Removing memory media

The following instructions apply to all types of supported media devices. To remove memory media, follow the steps as detailed below:

1. Click the **Desktop** tile and open the **Safely Remove Hardware and Eject Media** icon on the Windows Taskbar.
2. Select **memory media**.
3. Push the memory media until you hear a click to partially release it.
4. Grasp it and pull it out of the slot.



- *If you remove the memory media or turn off the power while the computer is accessing the memory media, you may lose data or damage the media.*
- *Do not remove the memory media while the computer is in Sleep or Hibernation Mode. The computer could become unstable or data in the memory media could be lost.*

- Do not remove only the miniSD/microSD Card while leaving the adaptor in the memory media slot.

## External Display

Your computer video capabilities can be enhanced with additional displays. External displays allows you to share your desktop or extend the desktop area.

### Connecting an external display

Your computer comes with a built-in display, but you can also connect other external displays via available ports on the computer.



*Some models may include the Triple Monitor function that can display image on Triple Monitor independently.*

#### External RGB monitor port

An external analog monitor can be connected to the External RGB monitor port on the computer. To connect an external analog monitor, follow the steps as detailed below:

1. Connect the RGB cable to the External RGB monitor port.

*Figure 4-12 Connecting the RGB cable to the External RGB monitor port*

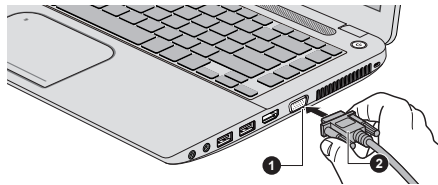

1. External RGB monitor port

2. RGB cable



*There are no fastening screws for an external monitor cable on the External RGB monitor port. However, external monitor cables which have connectors with fastening screws can still be used.*

2. Turn the external monitor's power on.

When you turn on the power, the computer will automatically recognize the monitor and determine whether it is a color or monochrome device.

When displaying desktop on an external analog monitor, desktop is sometimes displayed on the center of the monitor with black bars around desktop (with small size).

At that time, please read the manual of the monitor and set the display mode which is supporting at the monitor. Then it will be displayed with suitable size with correct aspect ratio.



## **The HDMI out port**

HDMI (High-Definition Multimedia Interface) port digitally transfers both video and audio data without reducing the quality. HDMI-compatible external display devices including televisions can be connected via the HDMI port.

To connect an HDMI-compatible display device, follow the steps as detailed below:



*As the port operation of all HDMI display devices have not been confirmed, some HDMI display devices may not function properly.*

*To connect a device to the HDMI out port, you must purchase an HDMI cable.*

1. Plug one end of the HDMI cable into the HDMI in port of the HDMI display device.
2. Plug the other end of the HDMI cable into the HDMI out port on your computer.
3. Turn the HDMI display device's power on.

*Figure 4-13 Connecting the HDMI out port*

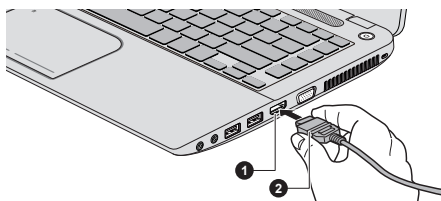

1. HDMI out port

2. HDMI cable



*Please do not plug/unplug an HDMI device under the following conditions:*

- *The system is starting up.*
- *The system is shutting down.*

*When you connect a television or external monitor to the HDMI port, the display output device is set to HDMI.*

*When you unplug the HDMI cable and re-plug it, please wait at least 5 seconds before you re-plug the HDMI cable again.*

*When you change the display output device, the playback device may not switch automatically. In this case, in order to set the playback device to the same device as the display output device, please adjust the playback device manually by the following steps:*

1. Click **Desktop -> Desktop Assist -> Control Panel -> Hardware and Sound -> Sound**.
2. In the **Playback** tab, select the playback device which you want to switch to.

3. To use the internal speakers on your computer, select **Speakers**. To use the television or the external monitor that you have connected to the computer, select a different playback device.
4. Click the **Set Default** button.
5. Click **OK** to close the **Sound** dialog.

### **Settings for display video on HDMI**

To view video on the HDMI display device, be sure to configure the following settings otherwise you may find that nothing is displayed.



*Be sure to use the function key to select the display device before starting to play video. Do not change the display device while playing video.*

*Do not change the display device under the following conditions.*

- *While data is being read or written.*
- *While communication is being carried out.*

### **Selecting HD Format**

To select the display mode, follow the steps as detailed below:

1. Click **Desktop -> Desktop Assist -> Control Panel**.
2. Click **Appearance and Personalization**.
3. Click **Display**.
4. Click **Change display settings**.
5. Click **Advanced settings**.
6. Click **List All Modes**.
7. Select one of the mode at **List All Modes**.

## **Wireless display**

Some models support Intel Wireless Display (Intel WiDi), a wireless technology which utilizes Wi-Fi to allow the computer to be wirelessly connected to external displays including TVs as extended screens. With Intel WiDi, documents, streamed/local media contents or other online contents can be shared wirelessly with others.

To use Intel WiDi, either one of the following devices is required:

- A compatible external display with built-in support for Intel WiDi.
- An external display with HDMI port and a digital adaptor featuring Intel WiDi.

The adaptor is a device that connects to the external display via HDMI port and can receive Wi-Fi signals from your computer.

Type "Intel WiDi" from the Start screen and click **Intel(R) WiDi**. Intel WiDi application will launch and you are ready to start the connection.

To learn more details on how to complete the connection, please refer to the application help.



*Some copy protected media contents may not play on the external displays via Intel WiDi.*

## Changing the display settings

After one or more external displays are connected, the operating system can automatically detect, identify and setup the display settings.

You can also manually manage how the external displays will work and change the display settings by pressing **P** while holding down the **Windows** (  ) key. If you disconnect the external display before you turn the computer's power off, be sure to switch to the internal display.

## Security lock

A security lock enables you to anchor your computer to a desk or other heavy object in order to help prevent unauthorized removal or theft. The computer has a security lock slot on its right side into which you can attach one end of the security cable, while the other end attaches to a desk or similar object. The methods used for attaching security cables differ from product to product. Please refer to the instructions for the product you are using for more information.

## Connecting the security lock

In order to connect a security cable to the computer, follow the steps as detailed below:

1. Turn the computer so its right side faces you.
2. Align the security cable with the lock slot and secure it in place.

*Figure 4-14 Security lock*

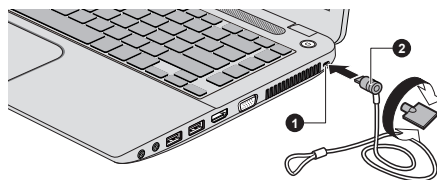

1. Security lock slot

2. Security lock

## Optional TOSHIBA Accessories

You are able to add a number of options and accessories in order to make your computer even more powerful and convenient to use. For reference, the following list details some of the items that are available from your reseller or TOSHIBA dealer:

---

**Memory Kit**

DDR3/DDR3L-1600/1866 memory modules can easily be installed in the computer.

The available option memory depends on TOSHIBA authorization.

---

**Universal AC Adaptor**

If you frequently use your computer at more than one site, it may be convenient to purchase an additional AC adaptor to be kept at each site in order to remove the need to always carry the adaptor with you.

---

## Sound System and Video mode

This section describes some of the audio control functions.

### Volume Mixer

The Volume Mixer utility lets you control the audio volume for playback of devices and applications under Windows.

- To launch the Volume Mixer utility, click **Desktop** and right click on the speaker icon on the Taskbar, and then select **Open Volume Mixer** from the sub menu.
- To adjust the volume level of speakers or headphones, move the **Speakers** slider.
- To adjust the volume level of an application that you are using, move the slider for the corresponding application.

### Microphone Level

Follow the steps below to change the microphone recording level.

1. Right click on the speaker icon on the Taskbar, and select **Recording devices** from the sub menu.
2. Select **Microphone**, and click **Properties**.
3. On the **Levels** tab move the **Microphone** slider to increase or decrease the microphone volume level.

If you feel the microphone volume level is inadequate, move the **Microphone Boost** slider to a higher level.

### Audio Enhancements

In order to apply the sound effects for your current speaker, follow the steps below.

1. Click **Desktop** and right click on the **Speakers** icon on the Taskbar, and then select **Playback devices** from the sub menu.
2. Select **Speakers**, and click **Properties**.
3. On the **Enhancements** tab select the sound effects you would like, and click **Apply**.

---

## DTS Studio Sound

DTS Studio Sound™ is a premium audio enhancement suite that utilizes revolutionary audio technology to provide the most immersive and realistic listening experience ever offered for a two speaker playback environment.

DTS Studio Sound is provided with some models. It provides the following features:

- Advanced audio rendering to match 2D and 3D video content for enveloping surround sound
- Accurate placement of audio cues for immersive surround sound from any PC speaker configuration laptop / desktop speakers or headphones
- Broad sweet spot with elevated sound image
- Maximum volume output delivering maximum volume without creating clipping or distortion
- Dialog enhancement for clear and intelligible vocals
- Bass enhancement for rich, low frequency production
- High frequency definition for crisp details
- Consistent volume level across content

To access the utility, Click **Desktop -> Desktop Assist -> Media & Entertainment -> DTS Studio Sound**.

U.S. patents apply to this product. See <http://patents.dts.com>.  
Manufactured under license from DTS Licensing Limited.

## DTS Sound

DTS Sound™ utilizes advanced patented techniques to retrieve audio cues buried in the original source material and deliver immersive surround sound complete with deep, rich bass and crystal clear dialog.

DTS Sound is provided with some models. It provides the following features:

- Immersive surround sound with bass and dialog enhancement
- Broad sweet spot with elevated sound image
- Improved volume output delivering maximum volume without creating clipping or distortion
- Dialog enhancement for clear and intelligible vocals
- Bass enhancement for rich, low frequency production
- High frequency definition for crisp details

To access the utility, Click **Desktop -> Desktop Assist -> Media & Entertainment -> DTS Sound**.

U.S. patents apply to this product. See <http://patents.dts.com>.  
Manufactured under license from DTS Licensing Limited.

---

## Realtek HD Audio Manager

You can confirm and change the audio configuration using the **Realtek HD Audio Manager**. To launch the **Realtek HD Audio Manager**:

- Click **Desktop -> Desktop Assist -> Control Panel -> Hardware and Sound -> Realtek HD Audio Manager**.

When you first launch the Realtek HD Audio Manager, you will see two device tabs. **Speakers** is the default output device. **Microphone** is the default input device. To change the default device, click the **Set Default Device** button under the chosen device tab.

### *Information*

Click the **Information** button to view hardware information, software information, and language setting.

### *Power Management*

The audio controller in your computer can be turned off when the audio function is not used. To adjust the configuration of audio power management, click the **Power Management** button .

- When audio power management is enabled, the circle button at the upper left of the Power Management is blue and convex.
- When audio power management is disabled, the button is black and concave.

### *Speaker Configuration*

Click the **Auto Test** button to confirm the internal speakers or the headphone sound is coming from the right direction.

### *Default Format*

You can change the sample rate and bit depth of sound.

## Video mode

Video mode settings are configured via the **Screen Resolution** dialog.

To open the **Screen Resolution** dialog, click **Desktop -> Desktop Assist -> Control Panel -> Appearance and Personalization -> Display -> Change display settings**.



*If you are running some applications (for example a 3D application or video playback), you may see some disturbance, flickering or frame dropping on your screen.*

*If that occurs, adjust the resolution of display, lowering it until the screen is displayed properly.*

---

# Chapter 5

## Utilities and Advanced Usage

This chapter describes the utilities and special features of this computer, and the advanced usage of some utilities.

### Utilities and Applications

This section describes the pre-installed utilities that come with the computer and details how to start them. For further information on their operation, you may refer to each utility's online manual, help files or README.TXT file (if applicable).



*All the utilities described here can be accessed from **Desktop -> Desktop Assist**.*

*Furthermore, some utilities can also be launched from Start screen and desktop shortcut.*

---

#### **TOSHIBA Desktop Assist**

TOSHIBA Desktop Assist is a graphical user interface that provides access to specific tools and TOSHIBA utilities and applications that make the use and configuration of the computer easier.

To access this utility, click **Desktop -> Desktop Assist**.

---

---

## **TOSHIBA Display Utility**

TOSHIBA Display Utility includes Desktop Text Size utility, Split Screen utility and Other Settings. Desktop Text Size allows you to make the text size bigger or smaller on the desktop according to your usage and favorite. You can change the text size on the display and on the title bar of windows by changing the scaling of the text size. When the scaling is smaller, more information will appear on the display simultaneously but the text size becomes smaller. When the scaling is larger, less information will appear on the display simultaneously but the text size becomes larger. You can install Split Screen utility by yourself. Split Screen utility enables you to create multiple display zones on a screen and to fit the active windows to within those zones. To access this utility, click **Desktop -> Desktop Assist -> Tools & Utilities -> Display Utility**. For details on Desktop Text Size utility and Split Screen utility, see the help file.

---

## **TOSHIBA Password Utility**

This utility allows you to set a password in order to restrict access to the computer.

To access this utility, click **Desktop -> Desktop Assist -> Tools & Utilities -> TOSHIBA Password Utility**.

---

## **TOSHIBA System Settings**

This utility allows you to customize your hardware settings according to the way you work with the computer and the peripherals you use.

To access this utility, click **Desktop -> Desktop Assist -> Tools & Utilities -> System Settings**.

---

## **TOSHIBA HDD Protection**

This feature uses the acceleration sensor built in the computer to detect vibration and shocks, and automatically moves the hard disk drive's read/write head to a safe position in order to reduce the risk of damage that could be caused by head-to-disk contact. Refer to the [Using the Hard Disk Drive \(HDD\) Protection](#) section for more details.

---

## **TOSHIBA HDD Accelerator**

TOSHIBA HDD Accelerator is a utility that can improve hard drive access performance by using part of the main memory of the computer as a cache.

To access this utility, click **Desktop -> Desktop Assist -> Tools & Utilities -> System Settings -> HDD Accelerator**.

---



---

## **TOSHIBA VIDEO PLAYER**

This software is provided for playback of DVD Video. To access this utility, click **Desktop -> Desktop Assist -> Media & Entertainment -> TOSHIBA VIDEO PLAYER**.

For details on how to use TOSHIBA VIDEO PLAYER, see the help file.

---

## **TOSHIBA eco Utility**

This computer is equipped with "eco mode". This mode slightly lowers performance of some devices to reduce electric power consumption. You can realize measurable power savings by using it continuously.

TOSHIBA eco Utility helps control the power consumption of your computer. Various information can help you understand your degree of contribution to the environment.

Furthermore, this utility contains Peak shift function that can help reduce power usage during periods of peak demand by shifting some power consumption to periods when demand is lower.

To access this utility, click **Desktop -> Desktop Assist -> Tools & Utilities -> eco Utility**.

For details on TOSHIBA eco utility, see the help file.

---

## **TOSHIBA Blu-ray Disc Player**

This software is provided for playback of Blu-ray Disc™. It has an on-screen interface and functions. To start this utility, click **Desktop -> Desktop Assist -> Media & Entertainment -> TOSHIBA Blu-ray Disc Player**. For details on how to use TOSHIBA Blu-ray Disc Player, see the help file.

---

## **TOSHIBA Media Player by sMedio TrueLink+**

This software is a multimedia player which can be used to play back video, music and photo.

TOSHIBA Media Player can play back contents on a local library/home network/SkyDrive.

To access it, click the **Media Player** icon on the Start screen.

For details, please refer to the Tutorial and Online help.

---

---

**TOSHIBA Function Key**

This utility allows you to perform some features by pressing a specified key or combined with the FN key.

To setup this utility, click **Desktop -> Desktop Assist -> Tools & Utilities -> Function Key**.

For details, please refer to the [Function Key](#) section.

---

**CyberLink MediaShow 6 for TOSHIBA**

This software helps you manage and share all of your digital photos and videos. It also allows quick creation of new professional looking media such as custom slideshows, screen savers, movie discs, and more using your photos and videos.

To start this utility, type **CyberLink** from the Start screen, and then click **CyberLink MediaShow 6 for TOSHIBA** from the list that appears.

For details on how to use CyberLink MediaShow, see the help file by clicking ? button in the main window.

---

**TOSHIBA Service Station**

This application allows your computer to automatically search for TOSHIBA software updates or other alerts from TOSHIBA that are specific to your computer system and its programs. When enabled, this application periodically transmits to our servers a limited amount of system information, which will be treated in strict accordance with the rules and regulations as well as applicable data protection law.

To access this utility, click **Desktop -> Desktop Assist -> Support & Recovery -> Service Station**.

---

**TOSHIBA PC Health Monitor**

The TOSHIBA PC Health Monitor application proactively monitors a number of system functions such as power consumption, battery health and system cooling, informing you of significant system conditions. This application recognizes the system and individual component serial numbers and will track specific activities related to their usage.

To access this utility, click **Desktop -> Desktop Assist -> Support & Recovery -> PC Health Monitor**.

For details on TOSHIBA PC Health Monitor, see the help file.

---

<b>TOSHIBA Resolution+ Plug-in for Windows Media Player</b>	<p>The plug-in lets you upconverts wmv and mp4 videos on Windows Media Player.</p> <p>For more information, please refer to the TOSHIBA Resolution+ Plug-in for Windows Media Player Help.</p> <p>To access it, click <b>Desktop -&gt; Desktop Assist -&gt; Media &amp; Entertainment -&gt; TOSHIBA Resolution+ Plug-in for Windows Media Player - Help</b>.</p>
<b>TOSHIBA Audio Enhancement</b>	<p>TOSHIBA Audio Enhancement provides you the function of audio source filtering, earphone audio enhancement, or speaker audio enhancement.</p> <p>To change the settings, click <b>Desktop -&gt; Desktop Assist -&gt; Media &amp; Entertainment -&gt; Audio Enhancement</b>.</p>
<b>AirGet for TOSHIBA</b>	<p>This software is provided for remote access to photos and documents in your computer from mobile devices.</p> <p>This computer is used as a home server. The client application should be installed in the mobile device.</p> <p>To access this software, type <b>AirGet</b> from the Start screen, and then click <b>AirGet for TOSHIBA</b> from the list that appears.</p> <p>For details on how to use AirGet, see the help file.</p>



*You may not have all the software listed above depending on the model you purchased.*

*To access the setup files of the drivers/utilities, type **Applications** from the Start screen, and then click **Applications and Drivers** from the list that appears.*

*TOSHIBA Media Player by sMedio TrueLink+ application is not included in the setup files above but can be downloaded from Windows Store.*

## Special features

The following features are either unique to TOSHIBA computers or are advanced features which make the computer more convenient to use.

Access each function using the following procedures.

\*1 To access the Power Options, click **Desktop -> Desktop Assist -> Control Panel -> System and Security -> Power Options**.

<b>Display automatic power off</b> *1	This feature automatically cuts off power to the computer's display panel when there is no keyboard input for a specified time, with power being restored the next time a key is pressed. This can be specified in the Power Options.
<b>HDD automatic power off</b> *1	This feature automatically cuts off power to the hard disk drive when it is not accessed for a specified time, with power being restored when the hard disk drive is next accessed. This can be specified in the Power Options.
<b>System automatic Sleep/Hibernation Mode</b> *1	This feature automatically shuts down the system into either Sleep Mode or Hibernation Mode when there is no input or hardware access for a specified time. This can be specified in the Power Options.
<b>Power on password</b>	Two levels of password security, supervisor and user, are available to prevent unauthorized access to your computer.
<b>Intelligent power supply</b> *1	A microprocessor in the computer's intelligent power supply detects the battery's charge, automatically calculates the remaining battery capacity and protects electronic components from abnormal conditions such as a voltage overload from the AC adaptor. This can be specified in the Power Options.
<b>Battery save mode</b> *1	This feature lets you configure the computer in order to save battery power. This can be specified in the Power Options.
<b>Panel power on/off</b> *1	This feature automatically turns power to the computer off when the display panel is closed, and turns it back on when the display panel is opened. This can be specified in the Power Options.
<b>Low battery automatic Hibernation Mode</b> *1	When battery power is exhausted to the point that computer operation cannot be continued, the system automatically enters Hibernation Mode and shuts itself down. This can be specified in the Power Options.
<b>Sleep Mode</b>	If you have to interrupt your work, you can use this feature to allow you to turn off power to the computer without exiting from your software. Data is maintained in the computer's main memory so that when you next turn on the power, you can continue working right where you left off.

---

<b>Hibernation Mode</b>	This feature lets you turn off the power to the computer without exiting from your software. The contents of main memory are automatically saved to the Hard Disk Drive so that when you next turn the power on again, you can continue working right where you left off. Refer to the <a href="#">Turning off the power</a> section, for more details.
<b>USB Wakeup function</b>	<p>This function restores the computer from Sleep Mode depending on the external devices connected to the USB ports.</p> <p>For example, if a mouse or USB keyboard is connected to a USB port, clicking the mouse button or pressing the keyboard will wakeup the computer.</p>
<b>Heat dispersal **1</b>	<p>To protect against overheating, the processor is equipped with an internal temperature sensor which activates a cooling fan or lowers the processing speed if the computer's internal temperature rises to a certain level. You are able to select whether to control this temperature by either turning on the fan first, then if necessary lowering the processor speed, or by lowering the processor speed first, then if necessary turning on the fan. Both of these functions are controlled through the Power Options.</p> <p>When the processor's temperature falls within normal range, the fan and the processor operation will return to its standard speed.</p> <p>If the processor's temperature reaches an unacceptably high level with either setting, the computer automatically shuts down to prevent any damage. In this instance all unsaved data in memory will be lost.</p>

---

## TOSHIBA Password Utility

The TOSHIBA Password Utility provides two levels of password security: User and Supervisor.



*Passwords set by the TOSHIBA Password Utility function are different from the Windows password.*

### User Password

To start the utility, click the following items:

---

## Desktop -> Desktop Assist -> Tools & Utilities -> TOSHIBA Password Utility -> User Password

User authentication may be required to validate user rights when using TOSHIBA Password Utility to delete or change passwords, etc.

### ■ **Set** (button)

Click this button to register a password. After a password is set, you will be prompted to enter it when you start the computer.



- *After you set the password, a dialog box will be displayed asking whether you want to save it to other media. If you forget the password, you can open the password file on another computer. Be sure to keep the media in a safe place.*
- *When entering the character string to register the password, enter from the keyboard character by character and do not enter as ASCII code or copy-and-paste the character string. In addition, ensure that the registered password is correct by outputting the character string to the password file.*
- *When entering a password, do not enter any characters (for example "!" or "#") produced by pressing the **SHIFT** or **ALT** keys.*

### ■ **Delete** (button)

Click this button to delete a registered password. Before you can delete a password, you must first enter the current password correctly.

### ■ **Change** (button)

Click this button to change a registered password. Before you can change a password, you must first enter the current password correctly.

### ■ **Owner String** (text box)

You can use this box to associate text with the password. After you enter text, click **Apply** or **OK**. When the computer is started, this text will be displayed together with the prompt asking you to enter a password.



*You can use BIOS Setup to set, change or delete the HDD Password or HDD Master Password.*

### ■ *To start BIOS Setup.*

1. In the **Settings** charm, click **Power** and then select **Restart**.
2. Hold down the **F2** key and then release this key one second after the computer is power on - the BIOS setup utility will load.

- *To end the BIOS Setup, press **F10**, and then press **ENTER** to accept the changes. The computer will restart.*



- If you forget your HDD User Password, TOSHIBA will NOT be able to assist you, and your HDD will be rendered COMPLETELY and PERMANENTLY INOPERABLE. TOSHIBA will NOT be held responsible for any loss of any data, any loss of use or access to your HDD, or for any other losses to you or any other person or organization that result from the loss of access to your HDD. If you can't accept this risk, don't register the HDD User Password.
- When saving the HDD User Password shut down or restart the computer. If the computer is not shut down or restarted, the saved data may not be correctly reflected. For more information on shutting down or restarting the computer, refer to [Turning on the power](#).

## Supervisor Password

If you set a Supervisor Password, some functions might be restricted when a user logs on with the User Password. To set a Supervisor Password:

**Desktop -> Desktop Assist -> Tools & Utilities -> TOSHIBA Password Utility -> Supervisor Password**

This utility lets you do the following:

- Register or delete the Supervisor Password.
- Specify restrictions for general users.

## Starting the computer using a password

If you have already registered a user password, there is one way to start the computer:

- Enter the password manually.



*The password is necessary only if the computer was shut down in Hibernation mode or boot mode. It is not needed in Sleep mode and Restart.*

To enter a password manually, follow the steps as detailed below:

1. Turn on the power as described in the [Getting Started](#) section. The following message will appear in the screen:

**Enter Password [ ]**



*At this point, the function keys do not work. They will function after you enter the password.*

2. Enter the Password.

3. Press **ENTER**.



*If you enter the password incorrectly three times in a row, or if you don't enter the password within 1 minute, the computer shuts off. In this case, some features that can power on the computer automatically (Wake-up on LAN, Task Scheduler, etc) may not work. You must turn the computer back on to retry password entry.*

## TOSHIBA System Settings

TOSHIBA System Settings is the TOSHIBA configuration management tool available through the Windows operating system.

To run TOSHIBA System Settings, click **Desktop -> Desktop Assist -> Tools & Utilities -> System Settings**.

The TOSHIBA System Settings window contains a number of tabs to allow specific functions of the computer to be configured.

In addition there are also three buttons: OK, Cancel and Apply.

<b>OK</b>	Accepts your changes and closes the TOSHIBA System Settings window.
<b>Cancel</b>	Closes the window without accepting your changes.
<b>Apply</b>	Accepts all your changes without closing the TOSHIBA System Settings window.



*Some options shown in grey are possible to confirm their status.*

TOSHIBA System Settings screen may have the following tabs:

- **General**—Allows you to view the current BIOS version or change certain settings back to their default values
- **Sleep Utilities**—Allows you to set advanced features for sleep mode, hibernate mode, and shutdown state
- **Display**—Allows you to select the internal LCD and/or external monitor when the computer boots up
- **Boot Options**—Allows you to change the sequence in which your computer searches the drives for the operating system
- **Keyboard**—Allows you to access the wake-on keyboard function, or to configure the function keys
- **USB**—Allows you to set conditions for USB
- **SATA**—Allows you to set conditions for SATA
- **LAN**—Allows you to set conditions for LAN



*The settings or options explained here may vary depending on the model you purchased.*



---

*After you changed the settings, a dialog box may appear to prompt you that the changes will take effect after the computer is restarted. Make sure to restart your computer immediately to apply these changes.*

## USB Charge

The port with the icon ( ⚡ ) supports the following feature:

- USB Sleep and Charge

### USB Sleep and Charge

You can use the Sleep and Charge function to charge certain USB-compatible external devices such as mobile phones or portable digital music players. Your computer can supply USB bus power (DC5V) to the compatible port even when the computer is turned OFF. "Power OFF" includes Sleep Mode, Hibernation Mode or shutdown state.

To set USB Sleep and Charge feature, click **Desktop -> Desktop Assist -> Tools & Utilities -> System Settings -> Sleep Utilities -> Sleep and Charge**.

Move the slider to enable or disable the Sleep and Charge function.



- *The Sleep and Charge function may not work with certain external devices even if they are compliant with the USB specification. In those cases, turn the power of the computer ON to charge the device.*
- *When Sleep and Charge function is enabled, USB bus power (DC5V) will be supplied to compatible ports even when the power of the computer is turned OFF. USB bus power (DC5V) is similarly supplied to the external devices which are connected to the compatible ports. However, some external devices cannot be charged solely by supplying USB bus power (DC5V). As for the specifications of the external devices, please contact the device manufacturer or check the specifications of the external devices thoroughly before use.*
- *Using the sleep and charge function to charge external devices will take longer than charging the devices with their own chargers.*
- *If Sleep and Charge function is enabled, the computer's battery will discharge during hibernation or when the computer is turned off. It is recommended that you connect the AC adaptor to the computer while using Sleep and Charge function.*
- *External devices connected to the USB bus power (DC5V) function that interfaces with the power ON/OFF of the computer may always be in an operational state.*
- *When there is a current overflow of the external devices connected to the compatible ports, USB bus power (DC5V) supply may be stopped for safety reasons.*

- *When Sleep and Charge function is enabled, the USB Wakeup function may not work for compatible ports. In that case, if there is a USB port that does not have the Sleep and Charge function, attach the mouse or keyboard to it. If all USB ports have the Sleep and Charge function, change to disable Sleep and Charge function. The USB Wakeup function will now work, but the Sleep and Charge function will be disabled.*



*Metal paper clips or hair pins/clips will generate heat if they come into contact with USB ports. Do not allow USB ports to come into contact with metal products, for example when carrying the computer in your bag.*

Your PC has multiple charging modes so that many different USB devices can be supported for Sleep and Charge function.

**Auto Mode** (Default) is suitable for a wide range of digital audio players. While using **Auto Mode**, your computer can supply USB bus power at maximum 2.0A to the compatible ports while the computer is turned off. When USB device cannot be charged by **Auto Mode**, change to **Alternate Mode**.

This function may not be able to be used with some connected external devices even if the appropriate mode is selected. In this situation, disable and stop using this function.

Some external devices cannot use **Auto Mode**. As for the specifications of the external devices, please contact the device's manufacture or check the specifications of the external device thoroughly before use.

Always use the USB cable that was included with your USB device.

### **Function under Battery Mode**

This option can be used to enable/disable sleep and charge under battery mode. It also displays the remaining battery capacity.

Move the slider to enable or disable this function.

<b>Enabled</b>	Enables Sleep and Charge function under battery mode.
<b>Disabled</b>	Enables Sleep and Charge function only when the AC adaptor is connected.
<b>Disable features when the battery level reaches</b>	Specifies the lower limit of remaining battery life by moving the slider bar. If the remaining battery life falls below the setting, the Sleep and Charge function will be stopped.  This setting is only available when the <b>Function under Battery Mode</b> is enabled.

---

## System ON CDP Charge

This function enable/disable CDP (Charging Downstream Port) to use rapid USB charge while the computer is powered on. When "System ON CDP Charge Mode" is enabled, your computer can supply USB bus power (DC5V, 1.5A) to the compatible ports while the computer is turned on.

To set System ON CDP Charge Mode, click **Desktop -> Desktop Assist -> Tools & Utilities -> System Settings -> USB**.

<b>Enabled</b>	Rapid USB battery charge at maximum 1.5A while PC is powered On.
<b>Disabled</b>	Conventional USB battery charge while PC is powered On.



*The "System ON CDP Charge Mode" may not work with certain external devices even if they are compliant with the USB specifications. In those cases, use a USB port without "USB Sleep and Charge function" or disable "System ON CDP Charge Mode".*

*It is recommended that AC adaptor be connected to the computer while supplying USB bus power (DC5V, 1.5A).*

*When your computer battery capacity is too low to continue, "System ON CDP Charge Mode" may not work. In those cases, connect the AC adaptor and reboot the computer.*

*Always use the USB cable that was included with your USB device.*

*When "System ON CDP Charge Mode" or "USB Sleep and Charge function" is enabled, the "USB Wakeup" function may not work. In that case, use a USB port without "USB Sleep and Charge function" or disable both "System ON CDP Charge Mode" and "USB Sleep and Charge function".*

## Sleep and Music

The Microphone jack with the icon ( ) supports the Sleep and Music function.

Your can use your computer's speaker for the portable audio device, even when the power of the computer is turned OFF.

"Power OFF" includes Sleep Mode, Hibernation Mode or shutdown state.

To set Sleep and Music feature, click **Desktop -> Desktop Assist -> Tools & Utilities -> System Settings -> Sleep Utilities -> Sleep and Music**.

Move the slider to enable or disable the Sleep and Music function.



- *When Sleep and Music function is enabled, it is not possible to mute sound from the speaker even by connecting headphones to the Headphone jack. There is also no sound from the headphone.*
- *When Sleep and Music function is enabled, it is possible to play sound from the computer's speaker by connecting an audio cable to the Microphone jack. Using this function discharges the computer's battery. Therefore, it is recommended that the computer be connected to an external power source via the AC Adaptor.*
- *When using the Sleep and Music function, connect the computer and Audio device with an audio cable.*
- *When using the Sleep and Music function, the volume level can not be changed from the computer.*
- *The volume adjustment and mute setting might be different between Windows mode and Sleep and Music mode. Before connecting the audio device to the computer, turn down the volume of the audio device. Sound quality may also be different.*
- *Use the Sleep and Music function with the display open.*

### Function under Battery Mode

This option can be used to enable/disable Sleep and Music under battery mode. It also displays the remaining battery capacity.

Move the slider to enable or disable this function.

<b>Enabled</b>	Enables Sleep and Music function under battery mode.
<b>Disabled</b>	Enables Sleep and Music function only when the AC adaptor is connected.
<b>Disable features when the battery level reaches</b>	Specifies the lower limit of remaining battery life by moving the slider bar. If the remaining battery life falls below the setting, the Sleep and Music function will be stopped.  This setting is only available when the <b>Function under Battery Mode</b> is enabled.

## TOSHIBA Media Player by sMedio TrueLink+

Please be aware of the following limitations when you use the TOSHIBA Media Player by sMedio TrueLink+:

### Notes on use

This software is a multimedia player which can be used to play back video, music and photo. However, some files may not be able to play back normally.

- 
- It is recommended that the AC adaptor be connected while TOSHIBA Media Player is running. Power saving features may interfere with smooth playback. When TOSHIBA Media Player is used with a battery power, set the Power Options to "Balance".
  - The screen saver is disabled while TOSHIBA Media Player is playing a video file or slideshows of photos.
  - The computer will not enter Sleep, Hibernation and shut-down mode automatically, while TOSHIBA Media Player is running.
  - The display automatic power off function is disabled while TOSHIBA Media Player is playing a video file or slideshows of photos.
  - The Resolution+ function was specially adjusted for the internal monitor. Hence, please turn OFF Resolution+ when viewing on external monitor.
  - Playback of high bit rate content may cause frame dropping, audio skipping or decrease in computer performance.  
The above problems could be remedied by turning Resolution+ off.
  - Tap/click the Refresh button on app commands to refresh the content displayed on Library Screen. It won't be refreshed automatically.
  - If sleep, hibernation, shutdown or reboot operation is in process during uploading the files to SkyDrive, the operation will not be properly completed.
  - This app doesn't support to playback content protected by DRM. If you try to play DRM protected content with Resolution+ On state, this app may be closed.
  - Photos uploaded to SkyDrive are limited to a maximum resolution of 2048 x 2048 pixels. Any photo over that resolution will be scaled proportionally to a maximum size of 2048 x 2048 pixels.
  - This app doesn't support DMS.

## Operating TOSHIBA Media Player by sMedio TrueLink+

The steps for playing a video file on a local library:

1. Click **My Local Library** on the Start Page of TOSHIBA Media Player.
2. Click a video file to playback.

The steps for playing a music file on a local library:

1. Click **My Local Library** on the Start Page of TOSHIBA Media Player.
2. Click **Music** in the upper-left corner of the screen.
3. Select an artist icon or album icon for playback.
4. Click a music file to playback.

The steps for playing a photo file on a local library:

1. Click **My Local Library** on the Start Page of TOSHIBA Media Player.
2. Click **Photos** in the upper-left corner of the screen.
3. Select a folder icon or date icon for playback.
4. Click a photo file to playback.

---

## Opening TOSHIBA Media Player by sMedio TrueLink+ Manual

The features and operations about TOSHIBA Media Player are explained in the TOSHIBA Media Player Manual.

Use the following procedure to open TOSHIBA Media Player Manual:

Click the **Tutorials** icon on the Start Page of TOSHIBA Media Player.

Use the following procedure to open TOSHIBA Media Player Online help:

When TOSHIBA Media Player is running, click **Help** of the Settings charm.

## Using CyberLink MediaShow 6 for TOSHIBA

This feature is supported by some models.

### How to create a DVD-Video or a Blu-ray Disc™ Movie

The following are simplified steps for creating a DVD-Video Disc, an AVCHD Disc or a Blu-ray Disc™ movie by importing your video sources.

1. Type **CyberLink** from the Start screen, and then click **CyberLink MediaShow 6 for TOSHIBA** from the list that appears.
2. Insert a DVD-R, DVD+R, DVD-RW, DVD+RW, BD-R or BD-RE disc into the optical disc drive.
3. Add your media files by dragging it to **Media Tray**.
4. Click **Create -> Movie Disc**.
5. Select **DVD-Video**, **AVCHD** or **Blu-ray Disc** from **Step1: Choose disc format**.
6. Select a destination drive.
7. Specify your movie disc title from **Step 2: Enter movie disc title**.
8. Select a template from **Step 3: Select menu template**.
9. Setup the advanced video & audio properties by clicking **Advanced** button on the top.
10. Start burning your movie disc by clicking **Burn** button.

### How to learn more

Please refer to the Help and Manual files for additional information about CyberLink MediaShow by pressing **F1** after the application is launched.

### Important information for use

Note the following limitations when you create movie discs and convert/playback media files.

#### *Playing digital video*

- High-resolution video playback may not be smooth depending on your environment.

---

## ***Editing digital video***

- Log in with Administrator rights to use CyberLink MediaShow.
- Make sure that your computer is running on AC power while using CyberLink MediaShow.
- Operate the computer at Full Power. Do not use power-saving features.
- CyberLink MediaShow cannot edit or play copy-protected content.
- Do not enter Sleep or Hibernation Mode while using CyberLink MediaShow.
- Do not operate CyberLink MediaShow immediately after turning on the computer. Please wait until all Disc Drive activity has stopped.
- Do not run software like a screen saver because it can put a heavy load on the CPU.
- DVD-VR format is not supported.

## ***Before recording DVD-Video, AVCHD or Blu-ray Disc™***

- When you record DVD-Video, AVCHD or Blu-ray Disc™, please use only discs recommended by the Drive manufacturer.
- The following types of discs are supported for recording:  
DVD-R, DVD-R DL, DVD-RW, DVD+R, DVD+R DL & DVD+RW  
BD-R, BD-R DL, BD-RE & BD-RE DL
- Do not set the working drive to a slow device like a USB1.1 hard disk drive or it will fail to write DVD-Video, AVCHD or Blu-ray Disc™.
- Do not perform any of the following actions:
  - Operate the computer for any other function, including using a mouse or Touch Pad, or closing/opening the display panel.
  - Bump or cause vibration to the computer.
  - Use the Mode control button and Audio/Video control button to reproduce music or voice.
  - Force eject the optical drive when burning.
  - Install, remove or connect external devices, including memory media cards, USB devices, external displays, optical digital devices.
- VCD and SVCD format for output is not supported.

## ***About recorded DVD, AVCHD and Blu-ray™ discs***

- Some DVD-ROM drives for personal computers or other DVD players may not be able to read DVD-R/DVD+R/DVD-RW/DVD+RW/DVD-RAM discs.
- When playing your recorded DVD on your computer, please use TOSHIBA VIDEO PLAYER.
- When playing your recorded Blu-ray Disc™ on your computer, please use the TOSHIBA Blu-ray Disc Player.
- If you use an over-used rewritable disc, the full formatting might be locked. Please use a brand new disc.

---

## **Internet Connection**

- An Internet connection is required for uploading and downloading.

## **TOSHIBA PC Health Monitor**

The TOSHIBA PC Health Monitor application proactively monitors a number of system functions such as power consumption, battery health and the system cooling, informing you of significant system conditions. This application recognizes the system and individual component serial numbers, and will track specific activities related to the computer and their usage.

The collected information includes device operation time and number of actuations or status changes (i.e.: number of power button and **FN** key combination uses, AC adaptor, battery, LCD, fan, HDD/SSD, sound volume, wireless communication functionalities and USB information), date of initial system use, and also computer and device usage (i.e.: power settings, battery temperature and recharging, CPU, memory, backlight illumination time, and temperatures for various devices). The stored data uses a very small portion of the total hard disk capacity, approximately 10MB or less per year.

This information is used to identify and provide a notification of system conditions which may effect the performance of your TOSHIBA computer. It may also be used to help diagnose problems should the computer require service by TOSHIBA or TOSHIBA's authorized service providers. Additionally, TOSHIBA may also use this information for quality assurance analysis.

Subject to the use restrictions above, the HDD data logged may be transferred to entities located outside of your country or region of residence (e.g., European Union). Those countries may or may not have the same data protection laws or data protection levels as required by your home country or region.

Once enabled, you may disable the TOSHIBA PC Health Monitor at any time by uninstalling the software via **Uninstall a program** in the **Control Panel**. Doing so will automatically delete all collected information from the HDD/SSD.

The TOSHIBA PC Health Monitor software does not extend or modify TOSHIBA's obligations under its standard limited warranty in any way. TOSHIBA's standard limited warranty terms and limitations apply.

## **Starting the TOSHIBA PC Health Monitor**

The TOSHIBA PC Health Monitor can be started by clicking **Desktop -> Desktop Assist -> Support & Recovery -> PC Health Monitor**.

The TOSHIBA PC Health Monitor main screen will be displayed and on clicking **Please click here to enable TOSHIBA PC Health Monitor**, the "PC Health Monitor Software Notice & Acceptance" screen will be



---

displayed. Please carefully read the information displayed. Selecting **ACCEPT** and clicking **OK** will enable the program. By enabling the TOSHIBA PC Health Monitor software, you agree with these terms and conditions and to the use and sharing of the collected information. Once the program is enabled, the TOSHIBA PC Health Monitor screen is displayed, and the program will begin monitoring system functions and collecting information.



*A message will be displayed if any changes which may interfere with the operation of the program are detected. Follow the instructions displayed on screen in the message.*

## AirGet for TOSHIBA

This software is provided for remote access to photos and documents in your computer from mobile devices.

### Notes on use

Please be aware of the following limitations when you are using the AirGet for TOSHIBA.

- The following error message may appear when Internet cannot be accessed at the launch of AirGet on your mobile device: "AirGet could not connect to the server. Please check your connection and try again."
- Video playback may restart from the beginning if your mobile device resumes from sleep mode.
- The quality of video and music streaming will vary based on your environment. In a poor environment, you may experience poor quality playback, skipping, or out of sync audio during video playback.
- The software converts video and audio based on pre-defined resolution templates of mobile device, therefore you may experience diminished video and audio quality.
- The library file list will not refresh automatically. Click the Refresh button to refresh the list.
- Wake on LAN requires a specific environment and may not work correctly unless the environment supports WOL and is set up correctly.
- If you cancel during the uninstall process, it may cause the application icon to be removed from the Apps list. To recover the application, you can repair it by clicking **Desktop -> Desktop Assist -> Control Panel -> Programs -> Programs and Features**. Select **AirGet for TOSHIBA** and then click **Repair** on the menu bar.
- If you tap the upload/download button during video playback, the current video will restart playback from the beginning.

---

## Preparation

Before using AirGet for TOSHIBA, you need to install AirGet for TOSHIBA in your mobile device and pair the device with your computer by the following steps:

1. Make sure both computer and mobile device have internet connections.
2. Launch the AirGet for TOSHIBA installed in your computer by typing **AirGet** from the Start screen, and then clicking **AirGet for TOSHIBA** from the list that appears.
3. Download and install **AirGet for TOSHIBA** on your mobile device. Please refer to the manual of your mobile device for downloading and installation of a mobile app.
4. After you accept EULA and Terms of Services, follow the onscreen instructions and click **Start** on Getting Started.
5. Tap the **Pair Device** button on your mobile device.
6. Do device pairing using QR code or PIN code. Scan QR code displayed on the computer using mobile device or input PIN code displayed on the computer to mobile device.
7. After pairing is completed, click **Test** to test **Remote Wake up** and then click **Done** to go to the main menu. You can also skip the **Remote Wake up** test by clicking **Skip**.

## Using AirGet for TOSHIBA

AirGet for TOSHIBA enables you to access files stored in your computer from mobile device.

- If the computer and mobile device are connected to the same network (e.g. home network), you can play (browse)/upload/download photos, music, videos, and documents.
- If the computer and mobile device are using different network (e.g. you are outside home), you can play (browse)/upload/download photos and documents.

And also you can share your photos with your friends or families.

### *Download files from the computer to mobile device*

1. Launch AirGet for TOSHIBA client on your mobile device.
2. Tap **Remote PC** icon on lower left corner of the screen, and select the content which you want to download from Media Library.
3. Tap **Download** icon on upper right corner to download the file. If you cannot see any menu, tap screen then the menu bar will appear.

### *Upload files from mobile device to your computer*

1. Launch AirGet for TOSHIBA client on your mobile device.
2. Tap **Library** icon, and select the content from Media Library.

3. Tap **Upload** icon on upper right corner to upload the file. If you cannot see any menu, tap screen then the menu bar will appear.

## How to learn more

The features and operations are explained in the AirGet for TOSHIBA Manual.

To open this manual, click the **help** icon on the About screen.

## Using the Hard Disk Drive (HDD) Protection

Some models have the function for reducing the risk of damage on the hard disk drive.

Using an acceleration sensor built into the computer, HDD Protection detects vibration shocks and similar signs of movement of the computer, and automatically moves the Hard Disk Drive head to a safe position to reduce the risk of damage that could be caused by head-to-disk contact.



- *HDD Protection function does not guarantee that the hard disk drive will not be damaged.*
- *During audio/video playback, when the computer detects a shock or vibration and the hard disk drive's head is parked, the playback might be temporarily interrupted.*
- *HDD Protection cannot be used in models that are equipped with SSD.*

When vibration is detected, a notification will be displayed on the screen, and the icon in the Taskbar will change to the protection state. This message is displayed until the **OK** button is pressed or 30 seconds pass. When vibration subsides, the icon returns to the normal state.

## Setting up HDD Protection

You can change HDD Protection settings.

To open the utility, click **Desktop -> Desktop Assist -> Tools & Utilities -> System Settings -> HDD Protection**. The utility can also be started from the icon in the Taskbar or from the **Control Panel**.

### **HDD Protection**

You can enable or disable HDD Protection by moving the slider to the right or left.



*HDD Protection does not work when the computer is booting, in Sleep Mode, in Hibernation Mode, in transition to Hibernation Mode, recovering from Hibernation Mode, or powered off. Do not subject the computer to vibration or impact while the protection is disabled.*

---

## ***HDD Protection Message***

Move the slider to the right to enable notification when vibration is detected.

## ***System Tray Icon***

Move the slider to the right to show HDD Protection icon in the Taskbar.

There are the following conditions for HDD Protection icon.



**Normal**

TOSHIBA HDD Protection is enabled.



**Protection**

TOSHIBA HDD Protection is active. The hard disk drive head is in a safe position.



**OFF**

TOSHIBA HDD Protection is disabled.

---

## ***Detection Level***

There are four sensitivity levels in which vibrations, impacts and their similar signs are detected can be set to OFF, 1, 2 and 3 in ascending order. Level 3 is recommended for better protection of the computer. However, when the computer is used in a mobile environment or in other unstable conditions, setting the detection level to 3 could result in frequent execution of HDD Protection, which will slow down Hard Disk Drive reading and writing. Set a lower detection level when the speed of Hard Disk Drive reading and writing is a priority.

Different detection levels can be set depending on whether the computer is used as handheld or mobile usages, or whether it is used in a stable environment such as on a table in the workplace or at home. By setting different detection levels for the computer depending on whether it runs with the AC power (desktop) or with batteries (handheld or mobile usage), the detection level automatically switches according to the power connection mode.

## ***Detection Level Amplification***

When the AC adaptor is disconnected, HDD Detection assumes that the computer will be carried and sets the detection level to the maximum for 10 seconds.

## ***Default***

You can reset HDD Protection settings to factory default by first clicking **Default** button and then **Apply** button.

---

### 3D Viewer

This feature displays a 3D object on the screen which moves in according to tilting or vibration of the computer.

When HDD Protection detects computer vibration the Hard Disk Drive head is parked and the 3D object disk rotation will stop. When the head is un-parked the disk will begin to rotate again.

Click **3D Viewer** button to start.



- *This 3D object virtually represents the Computer's internal Hard Disk Drive. This representation may vary from the actual number of disks, disk rotation, head movement, part size, shape and direction.*
- *This feature may use a large amount of CPU and memory on some models. The computer may become slow or sluggish when attempting to run other applications while the 3D Viewer is displayed.*
- *Intensely shaking the computer or other subjecting it to strong impacts may cause damage to the computer.*

## System Recovery

There is a hidden partition allocated on the Hard Disk Drive for the System Recovery Options in the event of a problem.

You can also create recovery media and restore the system.

The following items will be described in this section:

- Creating Recovery Media
- Restoring the pre-installed software from your created Recovery Media
- Restoring the pre-installed software from the Recovery Hard Disk Drive

### Creating Recovery Media

This section describes how to create Recovery Media.



- *Be sure to connect the AC adaptor when you create Recovery Media.*
- *Be sure to close all other software programs except the Recovery Media Creator.*
- *Do not run software such as screen savers which can put a heavy load on the CPU.*
- *Operate the computer at full power.*
- *Do not use power-saving features.*
- *Do not write to the media when the virus check software is running. Wait for it to finish, then disable virus detection programs including any software that checks files automatically in the background.*

- *Do not use utilities, including those intended to enhance Hard Disk Drive access speed. They may cause unstable operation and damage data.*
- *Do not shut down/log off or Sleep/Hibernate while writing or rewriting the media.*
- *Set the computer on a level surface and avoid places subjected to vibrations such as airplanes, trains, or cars.*
- *Do not use on an unstable surface such as a stand.*

A recovery image of the software on your computer is stored on the Hard Disk Drive, and can be copied to either disc media or USB Flash Memory by using the following steps:

1. Select either blank disc or USB Flash Memory.  
The application will allow you to choose from a variety of different media onto which the recovery image can be copied including disc media and USB Flash Memory.



- *Please note that some of the disc media may not be compatible with the optical disc drive connected to your computer. You should therefore verify the optical disc drive supports the blank media you have chosen before proceeding.*
- *USB Flash Memory will be formatted and all the data in the USB Flash Memory will be lost when proceeding.*

2. Turn on your computer and allow it to load the Windows operating system from the Hard Disk Drive as normal.
3. Insert the first blank disc into the optical disc drive tray, or insert the USB Flash Memory into one available USB port.
4. Click **Desktop -> Desktop Assist -> Support & Recovery -> Recovery Media Creator**.
5. After Recovery Media Creator starts, select the type of media and the title you wish to copy, and then click the **Create** button.

## Restoring the pre-installed software from your created Recovery Media

If the pre-installed files are damaged, you are able to use the Recovery Media you have created to restore the computer to the state it was in when you originally received it. To perform this restoration, follow the steps below:



- *When you reinstall the Windows operating system, the hard disk will be reformatted and all data will be lost.*

- Please make sure that the Boot Speed is set to **Normal**. (To access it, click **Desktop -> Desktop Assist -> Tool & Utilities -> System Settings -> Boot Options**.)
- Please make sure to use the default Boot Mode option in the BIOS setup utility before restoring.
  1. In the **Settings** charm, click **Power** and then select **Restart**.
  2. Hold down the **F2** key and then release this key one second after the computer is power on - the BIOS setup utility will load.

In the BIOS setup screen, select **Advanced -> System Configuration -> Boot Mode -> UEFI Boot** (Default).

If you set the Boot Mode as **CSM Boot**, the recovery media created by Recovery Media Creator will **NOT** be able to restore.

If you create a recovery image using advanced recovery tools from Control Panel, please also make sure to use the default Boot Mode option (**UEFI Boot**) in the BIOS setup utility before restoring.

1. Load the Recovery Media into the Optical Disc Drive or insert the recovery USB Flash Memory into one available USB port.
2. In the **Settings** charm, click **Power** and then select **Restart**.
3. Hold down the **F12** key and then release this key one second after the computer is power on.
4. Use the up and down cursor key to select the appropriate option from the menu according to your actual recovery media.
5. A menu will be displayed from which you should follow the on-screen instructions.



*If you have previously chosen to remove the recovery partition and are trying to create "Recovery Media", you will see the following message: "The Recovery Media Creator can not be launched because there is no recovery partition."*

*When there is no recovery partition, the Recovery Media Creator cannot make Recovery Media.*

*However, if you have already created a "Recovery Media", you can use it to restore the recovery partition.*

*If you have not created "Recovery Media", please contact TOSHIBA support for assistance.*

## **Restoring the pre-installed software from the Recovery Hard Disk Drive**

A portion of the total Hard Disk Drive space is configured as a hidden recovery partition. This partition stores files which can be used to restore pre-installed software in the event of a problem.

---

If you subsequently set up your Hard Disk Drive again, do not change, delete or add partitions in a manner other than specified in the manual, otherwise you may find that space for the required software is not available.

In addition, if you use a third-party partitioning program to reconfigure the partitions on your Hard Disk Drive, you may find that it becomes impossible to setup your computer.



*Make sure that the AC adaptor is connected during the restoring process.*



*When you reinstall the Windows operating system, the hard disk may be reformatted and all data may be lost.*

1. In the **Settings** charm, click **Power** and then select **Restart**.
2. Hold down **0** (zero) key and then release this key one second after the computer is power on.
3. Select **Troubleshoot**.
4. Select **Reset your PC**.
5. Follow the on screen instructions to finish the recovery.

You can also perform the restoration through PC settings in the operating system:

1. Click the **Settings** charm and click **Change PC settings**.
2. Click **General** under PC settings.
3. Scroll down to **Remove everything and reinstall Windows** and click **Get started**.
4. Follow the on screen instructions to finish the recovery.



---

# Chapter 6

## Troubleshooting

TOSHIBA has designed this computer for durability, however, should problems occur you are able to use the procedures detailed in this chapter to help determine the cause.

All users should become familiar with this chapter as knowing what might go wrong can help prevent problems from occurring in the first place.

### Problem solving process

Resolving problems will be much easier if you observe the following guidelines:

- Stop immediately when you recognize a problem exists as taking further action may result in data loss or damage, or you may destroy valuable problem related information that can help solve the problem.
- Observe what is happening - write down what the system is doing and what actions you performed immediately before the problem occurred. Make a screenshot of the current display.

Please also be aware that the questions and procedures described in this chapter are meant only as a guide, they are not definitive problem solving techniques. In reality many problems can be solved simply, but a few may require help from TOSHIBA Support - if you find you need to consult others, be prepared to describe the problem in as much detail as possible.

### Preliminary checklist

You should always consider the simplest solution first - the items detailed in this checklist are easy to fix and yet can cause what appears to be a serious problem:

- Make sure you turn on all peripheral devices before you turn on the computer - this includes your printer and any other external device you are using.
- Before you attach an external device you should first turn the computer off, then when you turn the computer back on again it will recognize the new device.
- Make sure all optional accessories are configured properly in the computer's setup program and that all required driver software has been loaded (please refer to the documentation included with the optional accessories for further information on its installation and configuration).

- 
- Check all cables to ensure they are correctly and firmly attached to the computer - loose cables can cause signal errors.
  - Inspect all connecting cables for loose wires and all connectors for loose pins.
  - Check that your disc media is correctly loaded

Always try to make detailed notes of your observations and keep them in a permanent error log - this will help you to describe your problems to TOSHIBA Support. In addition, if a problem recurs, the log you have made will help to identify the problem faster.

## Analyzing the problem

Sometimes the computer will give you clues that can help you identify why it is malfunctioning. In view of this you should keep the following questions in mind:

- Which part of the computer is not operating properly - keyboard, Hard Disk Drive, display panel, Touch Pad, Touch Pad control buttons - as each device will produce different symptoms.
- Check the options within the operating system to ensure that its configuration is set properly.
- What appears on the display? Does it display any messages or random characters? Make a screenshot of the current display and, if possible, look up the messages in the documentation included with the computer, software or operating system.
- Check that all connecting cables are correctly and firmly attached as loose cables can cause erroneous or intermittent signals.
- Do any indicators light, if so, which ones, what color are they and do they stay on or blink? Write down what you see.
- Do you hear any beeps, if so how many, are they long or short and are they high pitched or low pitched? In addition, is the computer making any unusual noises? Write down what you hear.

Record your observations so you can describe them in detail to TOSHIBA Support.

---

### Software

The problems may be caused by your software or disk. If you cannot load a software package, the media may be damaged or the program might be corrupted - in these instances try loading another copy of the software if possible.

If an error message appears while you are using a software package you should refer to the documentation supplied with it as this will usually include a problem solving section or a summary of error messages.

Next, you should check any error messages against the operating system documentation.

---

---

## Hardware

If you cannot find a software problem, you should then check the setup and configuration of your hardware. First run through the items in the preliminary checklist as described previously then, if you still cannot correct the problem, try to identify the source - the next section provides checklists for individual components and peripherals.



*Before using a peripheral device or application software that is not an authorized TOSHIBA part or product, make sure the device or software can be used with your computer. Use of incompatible devices may cause injury or may damage your computer.*

## If something goes wrong

### ***Your computer does not respond to the keyboard commands***

If an error occurs and the computer does not respond to your keyboard commands, follow the steps below:

Press the power button and hold it down for five seconds. Once the computer has turned itself off, wait between ten and fifteen seconds before turning the power on again by pressing the power button.

### ***Your program stops responding***

If you are working with a program that suddenly freezes all operations, chances are the program has stopped responding. You can exit the failed program without shutting down the operating system or closing other programs.

To close a program that has stopped responding:

1. Press **CTRL**, **ALT**, and **DEL** simultaneously (once), then click **Task Manager**. The Windows Task Manager window appears.
2. Select the program you want to close, then click **End Task**. Closing the failed program should allow you to continue working. If it does not, continue with the next step.
3. Close the remaining programs one by one by selecting the program name, then **End Task**. Closing all programs should allow you to continue working. If it does not, power off your computer and then restart it.

### ***The computer will not start***

Make sure you attached the AC adaptor and power cord/cable properly.

If you are using the AC adaptor, check that the wall outlet is working by plugging in another device, such as a lamp.

Verify that the computer is on by looking at the **Power** indicator.

---

If the indicator is glowing, the computer is on. Also, try turning the computer off and then on.

If you are using an AC adaptor, verify that the computer is receiving power from the external power source by looking at the **DC IN/Battery** indicator. If the indicator is glowing, the computer is connected to a live external power source.

### ***The computer will not load advanced options during startup***

By holding down one of the following keys during startup, your computer will load advanced options as shown below.

<b>Key</b>	<b>Advanced option</b>
F2	BIOS utility
F12	Boot menu
0 (zero)	Recovery options

If your computer starts to load the Operating System instead of desired advanced options, follow the steps below:

1. In the **Settings** charm, click **Power** and then select **Restart**.
2. Hold down the corresponding key and then release this key one second after the computer is power on.
3. Follow the on-screen instructions to proceed.

## **Hardware and system checklist**

This section discusses problems caused by your computer's hardware or attached peripherals. Basic problems may occur in the following areas:

- Power
- Keyboard
- Internal display panel
- Hard Disk Drive
- Optical Disc Drive
- Memory Media Card
- Pointing Device
- USB device
- Additional memory module
- Sound system
- External monitor
- LAN
- Wireless LAN
- Bluetooth

### **Power**

When the computer is not plugged into an AC power outlet, the battery pack is the primary power source. However, your computer also has a number of other power resources, including an intelligent power supply and a Real Time Clock (RTC) battery, all of which are interrelated with any one having the ability to produce apparent power problems.

---

### **Overheating power down**

If the processor's temperature reaches an unacceptably high level with either setting, the computer will automatically shut down to prevent any damage - in this instance all unsaved data in memory will be lost.

<b>Problem</b>	<b>Procedure</b>
Computer shuts down automatically.	Leave the computer off until the it reaches room temperature. If the computer has reached room temperature and it still does not start, or if it starts but shuts down quickly, contact TOSHIBA Support.

### **AC power**

If you have trouble turning on the computer with the AC adaptor connected you should check the status of the DC IN/Battery indicator. Please refer to the [Power Condition Descriptions](#) section for further information.

<b>Problem</b>	<b>Procedure</b>
AC adaptor doesn't power the computer	<p>Check the connections to make sure that the power cord/adaptor is firmly connected to the computer and a working power outlet.</p> <p>Check the condition of the cord and terminals. If the cord is frayed or damaged it should be replaced, while if the terminals are soiled, they should be cleaned with a clean cotton cloth.</p> <p>If the AC adaptor still does not power the computer, you should contact TOSHIBA Support.</p>

### **Battery**

If you suspect a problem with the battery, you should check the status of the DC IN/Battery indicator.

<b>Problem</b>	<b>Procedure</b>
Battery doesn't power the computer	The battery may be discharged - connect the AC adaptor to recharge the battery.
Battery doesn't charge when the AC adaptor is attached.	If the battery is completely discharged, it will not begin charging immediately, in these instances you should wait a few minutes before trying again. If the battery still does not charge, you should check that the power outlet the AC adaptor is connected to is supplying power - this can be tested by plugging another appliance into it.

Problem	Procedure
Battery doesn't power the computer as long as expected	<p>If you frequently recharge a partially charged battery, the battery might not charge to its full potential - in these instances you should fully discharge the battery and then attempt to charge it again.</p> <p>Check the <b>Power saver</b> option under <b>Select a power plan</b> in the <b>Power Options</b>.</p>

### Real Time Clock

Problem	Procedure
The BIOS setting and system date/time are lost.	<p>The charge in the Real Time Clock (RTC) battery has run out - you will need to set the date and time in the BIOS setup application by using the following steps:</p> <ol style="list-style-type: none"> <li>1. In the <b>Settings</b> charm, click <b>Power</b> and then select <b>Restart</b>.</li> <li>2. Hold down the <b>F2</b> key and then release this key one second after the computer is power on - the BIOS setup utility will load.</li> <li>3. Set the date in the <b>System Date</b> field.</li> <li>4. Set the time in the <b>System Time</b> field.</li> <li>5. Press <b>F10</b> - a confirmation message will be displayed.</li> <li>6. Press the <b>ENTER</b> key - the BIOS setup application will end and the computer will restart.</li> </ol>

## Keyboard

Keyboard problems can be caused by the setup and configuration of the computer - please refer to the [The Keyboard](#) section for further information.

Problem	Procedure
Output to screen is garbled	<p>Please refer to your software's documentation to ensure that it is not remapping the keyboard in any way (remapping involves changing or reassigning the function of each key).</p> <p>If you are still unable to use the keyboard, you should contact TOSHIBA Support.</p>

---

## Internal display panel

Apparent computer's display panel problems may be related to the computer's setup and configuration.

Problem	Procedure
No display	Press the function keys to adjust the display priority, and to make sure it is not set for output to an external monitor.
Markings appear on the computer's display panel.	These marks may have come from contact with the keyboard and Touch Pad while the display panel has been closed. You should try to remove the marks by gently wiping the display panel with a clean dry cloth or, if this fails, with a good quality LCD screen cleaner. In this latter instance you should always follow the instructions with the screen cleaner and always ensure you let the display panel dry properly before closing it.

## Hard Disk Drive

Problem	Procedure
Computer does not boot from Hard Disk Drive	Check to see whether there is a disc in the optical disc drive - if so remove it and try to start the computer again.  If this has no effect, check the <b>Boot Priority Options</b> setting within the TOSHIBA System Settings.
Slow performance	The files on the Hard Disk Drive may be fragmented - in this instance you should run the disk Defragmentation utility to check the condition of your files and the Hard Disk Drive. Please refer to the operating system's documentation or online Help File for further information on operating and using the Defragmentation utility.  As a last resort you should reformat the Hard Disk Drive and then reload the operating system and all other files and data. If you are still unable to resolve the problem, contact TOSHIBA Support.

## Optical Disc Drive

For further information, please refer to [Operating Basics](#).

Problem	Procedure
You cannot access a CD/DVD/Blu-ray Disc™ in the drive	<p>Make sure the drive's disc tray is securely closed. Press gently until it clicks into place.</p> <p>Open the disc tray and make sure the disc is properly seated. It should lie flat with the label facing up.</p> <p>A foreign object in the disc tray could block laser light from reading the disc. Make sure there is no obstruction. Remove any foreign object.</p> <p>Check whether the disc is dirty. If it is, wipe it with a clean cloth dipped in water or a neutral cleaner.</p>

## Memory Media Card

For further information, please refer to [Operating Basics](#).

Problem	Procedure
Memory media card error occurs	<p>Remove the memory media card from the computer and then reinsert it in order to ensure it is firmly connected.</p> <p>If the problem persists, then you should refer to the documentation supplied with your memory media card for further information.</p>
You cannot write to a memory media card	<p>Remove the memory media card from the computer and check to ensure that it is not write protected.</p>
You cannot read a file	<p>Check to ensure the required file is actually on the memory media card that is inserted into the computer.</p> <p>If you are still unable to resolve the problem, contact TOSHIBA Support.</p>

## Pointing device

If you are using a USB mouse, you should also refer to both the [USB mouse](#) section and the documentation supplied with your mouse.

### ***Touch Pad***

Problem	Procedure
The Touch Pad does not work.	<p>Check the Device Select settings.</p> <p>Click <b>Desktop -&gt; Desktop Assist -&gt; Control Panel -&gt; Hardware and Sound -&gt; Mouse</b>.</p>



<b>Problem</b>	<b>Procedure</b>
On-screen pointer does not respond to pointing device operation	In this instance the system might be busy - Try moving the mouse again after waiting a short while.
Double-tapping (Touch Pad) does not work	<p>In this instance, you should initially try changing the double-click speed setting within the Mouse Control utility.</p> <ol style="list-style-type: none"> <li>1. To access this utility, click <b>Desktop -&gt; Desktop Assist -&gt; Control Panel -&gt; Hardware and Sound -&gt; Mouse</b>.</li> <li>2. Within the Mouse Properties window, click the <b>Buttons</b> tab.</li> <li>3. Set the double-click speed as required and click <b>OK</b>.</li> </ol>
The on-screen pointer moves too fast or too slow	<p>In this instance, you should initially try changing the speed setting within the Mouse Control utility.</p> <ol style="list-style-type: none"> <li>1. To access this utility, click <b>Desktop -&gt; Desktop Assist -&gt; Control Panel -&gt; Hardware and Sound -&gt; Mouse</b>.</li> <li>2. Within the Mouse Properties window, click the <b>Pointer Options</b> tab.</li> <li>3. Set the pointer speed as required and click <b>OK</b>.</li> </ol>
The reaction of Touch pad is either too sensitive or not sensitive enough.	<p>Adjust the touch Sensitivity.</p> <p>To access it, click <b>Desktop -&gt; Desktop Assist -&gt; Control Panel -&gt; Hardware and Sound -&gt; Mouse</b>.</p> <p>If you are still unable to resolve the problem, contact TOSHIBA Support.</p>

### **USB mouse**

<b>Problem</b>	<b>Procedure</b>
On-screen pointer does not respond to mouse operation	<p>In this instance the system might be busy - Try moving the mouse again after waiting a short while.</p> <hr/> <p>Remove the mouse from the computer and then reconnect it to a free USB port in order to ensure it is firmly attached.</p>

Problem	Procedure
Double-clicking does not work	<p>In this instance, you should initially try changing the double-click speed setting within the Mouse Control utility.</p> <ol style="list-style-type: none"> <li>1. To access this utility, click <b>Desktop -&gt; Desktop Assist -&gt; Control Panel -&gt; Hardware and Sound -&gt; Mouse</b>.</li> <li>2. Within the Mouse Properties window, click the <b>Buttons</b> tab.</li> <li>3. Set the double-click speed as required and click <b>OK</b>.</li> </ol>
The on-screen pointer moves too fast or too slow	<p>In this instance, you should initially try changing the speed setting within the Mouse Control utility.</p> <ol style="list-style-type: none"> <li>1. To access this utility, click <b>Desktop -&gt; Desktop Assist -&gt; Control Panel -&gt; Hardware and Sound -&gt; Mouse</b>.</li> <li>2. Within the Mouse Properties window, click the <b>Pointer Options</b> tab.</li> <li>3. Set the pointer speed as required and click <b>OK</b>.</li> </ol>
The on-screen pointer moves erratically	<p>The elements of the mouse responsible for detecting movement might be dirty - please refer to the documentation supplied with the mouse for instructions on how to clean it.</p> <p>If you are still unable to resolve the problem, contact TOSHIBA Support.</p>

## USB device

In addition to the information in this section, please also refer to the documentation supplied with your USB device.

Problem	Procedure
USB device does not work	<p>Remove the USB device from the computer and then reconnect it to a free port in order to ensure it is firmly attached.</p> <p>Ensure that any required USB device drivers are properly installed - to achieve this you should refer to both the device documentation and the operating system documentation.</p>

---

## **Sleep and Charge function**

For more information and settings, please refer to the [USB Sleep and Charge](#) section.

<b>Problem</b>	<b>Procedure</b>
I cannot use the Sleep and Charge function.	<p>Sleep and Charge function may be disabled.</p> <p>Enable the <b>Sleep and Charge</b> function in the TOSHIBA System Settings.</p> <p>When there is a current overflow of the external device connected to the compatible port, USB bus power (DC5V) supply may be stopped for safety reasons. When this happens, disconnect an external device if some external devices are connected. After that, turn the power of the computer ON/OFF to restore the function. If this function can not be still used even if only one external device is connected, stop using the external device because its current is over the acceptable value of this computer.</p> <p>Some external devices may not be able to use the Sleep and Charge function. In this case, please try one or more of the following methods.</p> <ul style="list-style-type: none"><li>■ Turn OFF the computer while external devices are connected.</li><li>■ Connect external devices after turning OFF of the computer.</li></ul> <p>If this function can not be still used, change the setting to disable the function and stop using this function.</p>
The battery depletes quickly even when I turned OFF the power of the computer.	<p>If Sleep and Charge function is enabled, the computer's battery will discharge during hibernation or when the computer is turned off.</p> <p>Connect the AC adaptor to the computer or disable the Sleep and Charge function.</p>
External devices connected to the compatible ports do not work when connected to a compatible port.	<p>Some external devices may not work when connected to a compatible port if the Sleep and Charge function is enabled.</p> <p>Reconnect the external device after turning the computer ON.</p> <p>If the external device still does not work, connect device to an USB port that does not have the Sleep and Charge function or change to disable the Sleep and Charge function.</p>

---

<b>Problem</b>	<b>Procedure</b>
The "USB Wakeup function" does not work.	When Sleep and Charge function is enabled, the "USB WakeUp" function does not work for ports that support the Sleep and Charge function.  In that case, use an USB port that does not have the USB Sleep and Charge function or change to disable Sleep and Charge function.

---

## Sound system

In addition to the information in this section, please also refer to the documentation supplied with your audio device.

<b>Problem</b>	<b>Procedure</b>
No sound is heard	Press the function keys to increase or decrease volume.  Check the software volume settings.  Please check to see if Mute is turned to Off  Check to make sure the headphone connection is secure.  Check within the Windows Device Manager application to ensure the sound device is enabled and that the device is properly working.
Annoying sound is heard	In this instance you may be experiencing feedback from either the internal microphone or an external microphone connected to the computer - please refer to <a href="#">Sound System and Video mode</a> for further information.  Volume cannot be adjusted during Windows start up or shut down.  If you are still unable to resolve the problem, contact TOSHIBA Support.

---

## External monitor

Please also refer to [Operating Basics](#), and to the documentation supplied with your monitor for further information.

<b>Problem</b>	<b>Procedure</b>
Monitor does not turn on	After confirming that the monitor's power switch is on, you should check the connections to make sure that the power cord/adaptor is firmly connected to the monitor and to a working power outlet.
No display	<p>Try adjusting the contrast and brightness controls on the external monitor.</p> <p>Press the function key in order to change the display priority and ensure that it is not set for the internal display only.</p> <p>Check to see if the external monitor is connected.</p> <p>When the external monitor is set as the primary display device in extended desktop mode, it will not display when the computer wakes up from Sleep Mode if the external monitor has been disconnected while in Sleep Mode.</p> <p>To keep this from happening, do not disconnect the external monitor while the computer is in Sleep or Hibernation Mode.</p> <p>Remember to turn off the computer before disconnecting the external monitor.</p> <p>When the display panel and an external monitor are set to clone mode and they are turned off by the timer, the display panel or the external monitor may not display when turned on again.</p> <p>If this occurs, press the function key to re-set the display panel and external monitor to clone mode.</p>
Display error occurs	<p>Check that the cable connecting the external monitor to the computer is firmly attached.</p> <p>If you are still unable to resolve the problem, contact TOSHIBA Support.</p>

## LAN

<b>Problem</b>	<b>Procedure</b>
Cannot access LAN	Check for a firm cable connection between the LAN jack and the LAN hub.

---

<b>Problem</b>	<b>Procedure</b>
Wake-up on LAN does not work	Make sure the AC adaptor is connected. The Wake-up on LAN function consumes power even when the system is off.  If problems persist, consult your LAN administrator.

---

## Wireless LAN

<b>Problem</b>	<b>Procedure</b>
Cannot access Wireless LAN	Make sure the computer's Wireless communication function is on.  If problems persist, contact your LAN administrator.

---

## Bluetooth

<b>Problem</b>	<b>Procedure</b>
Cannot access Bluetooth device	Check to ensure the computer's Wireless Communication function is on.  Check to ensure the Bluetooth Manager application is running on the computer and that power to the external Bluetooth device is turned on.  Check to ensure that no optional Bluetooth Adaptor is installed in the computer - the built-in Bluetooth hardware cannot operate simultaneously with another Bluetooth controller.  If you are still unable to resolve the problem, contact TOSHIBA Support.

---

## TOSHIBA support

If you require any additional help using your computer or if you are having problems operating the computer, you may need to contact TOSHIBA for additional technical assistance.

### Before you call

Some problems you experience may be related to software or the operating system so it is important that you investigate other sources of assistance first. Before contacting TOSHIBA, try the following:

- Review troubleshooting sections in the documentation supplied with your software and/or peripheral devices.

- 
- If a problem occurs when you are running software applications, consult the software documentation for troubleshooting suggestions and consider calling the software company's technical support department for assistance.
  - Consult the reseller or dealer from where you purchased your computer and/or software - they are your best resource for current information and support.

## **TOSHIBA technical support**

If you are still unable to solve the problem and suspect that it is hardware related, visit TOSHIBA technical support website <http://www.toshiba.co.jp/worldwide/>.

---

# Chapter 7

## Appendix

### Specifications

This section summarizes the computer's technical specifications.

#### Physical Dimensions

Physical Dimensions shown below do not include parts that extend beyond the main body. The physical dimensions may vary depending on the model you purchased.

---

<b>Size</b>	■ Approximately 340 (w) x 234 (d) x 22.90~26.10/23.15~28.40(h) millimeters (not including parts that extend beyond the main body).
-------------	---

---

#### Environmental Requirements

Conditions	Ambient temperature	Relative humidity
<b>Operating</b>	5°C (41°F) to 35°C (95°F)	20% to 80% (noncondensing)
<b>Non-operating</b>	-20°C (-4°F) to 60°C (140°F)	10% to 90% (noncondensing)
<b>Wet-bulb temperature</b>	29°C maximum	

---

Conditions	Altitude (from sea level)
<b>Operating</b>	-60 to 3,000 meters
<b>Non-operating</b>	-60 to 10,000 meters maximum

---

#### Power Requirements

---

<b>AC adaptor</b>	100-240V AC 50 or 60 Hz (cycles per second)
<b>Computer</b>	19V DC

---



## External RGB monitor port pin assignment

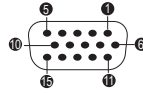

Pin	Signal Name	Description	I/O
1	CRV	Red Video Signal	O
2	CGV	Green Video Signal	O
3	CBV	Blue Video Signal	O
4	Reserved	Reserved	
5	GND	Ground	
6	GND	Ground	
7	GND	Ground	
8	GND	Ground	
9	+5V	Power Supply	
10	GND	Ground	
11	Reserved	Reserved	
12	SDA	Data Signal	I/O
13	HSYNC	Horizontal Sync Signal	O
14	VSYNC	Vertical Sync Signal	O
15	SCL	Data Clock Signal	O

I/O (I): Input to computer

I/O (O): Output from computer

## AC Power Cord and Connectors

The power cord's AC input plug must be compatible with the various international AC power outlets and the cord must meet the standards for the country/region in which it is used. All cords must meet the following specifications:

**Wire size:** Minimum 0.75 mm<sup>2</sup>

**Current rating:** Minimum 2.5 amperes

---

## Certification agencies

<b>China:</b>	CQC		
<b>U.S. and Canada:</b>	UL listed and CSA certified No. 18 AWG, Type SVT or SPT-2		
<b>Australia:</b>	AS		
<b>Japan:</b>	DENANHO		
<b>Europe:</b>			
<b>Austria:</b>	OVE	<b>Italy:</b>	IMQ
<b>Belgium:</b>	CEBEC	<b>The Netherlands:</b>	KEMA
<b>Denmark:</b>	DEMKO	<b>Norway:</b>	NEMKO
<b>Finland:</b>	FIMKO	<b>Sweden:</b>	SEMKO
<b>France:</b>	LCIE	<b>Switzerland:</b>	SEV
<b>Germany:</b>	VDE	<b>United Kingdom:</b>	BSI

In Europe, two conductors power cord must be VDE type, H05VVH2-F or H03VVH2-F and for three conductors power cord must be VDE type, H05VV-F.

For the United States and Canada, two pin plug configuration must be a 2-15P (250V) or 1-15P (125V) and three pin plug configuration must be 6-15P (250V) or 5-15P (125V) as designated in the U.S. National Electrical code handbook and the Canadian Electrical Code Part II.

The following illustrations show the plug shapes for the U.S.A. and Canada, the United Kingdom, Australia, Europe and China.

### USA

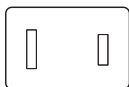

UL approved

### United Kingdom

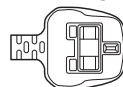

BS approved

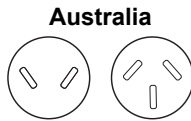

AS approved

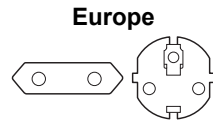

Approved by the appropriate agency

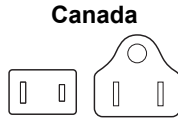

CSA approved



CCC approved

## Information for Wireless Devices

### Wireless Technology Interoperability

The Wireless LAN is compatible with other LAN systems Direct Sequence Spread Spectrum (DSSS) /Orthogonal Frequency Division Multiplexing (OFDM) radio technology, and is compliant to:

- The IEEE 802.11 Standard on Wireless LANs (Revision a/b/g/n or b/g/n), as defined and approved by the Institute of Electrical and Electronics Engineers.

Bluetooth® Cards are designed to be interoperable with any product with Bluetooth wireless technology that is based on Frequency Hopping Spread Spectrum (FHSS) radio technology, and is compliant to:

- Bluetooth Specification (depending on the model you purchased), as defined and approved by the Bluetooth Special Interest Group.
- Logo certification with Bluetooth wireless technology as defined by the Bluetooth Special interest Group.

This Bluetooth product is not compatible with devices using Bluetooth Version 1.0B specifications.



*The wireless devices have not completed verification of connection and operation with all devices which are using the Wireless LAN or Bluetooth radio technology.*

*Bluetooth and Wireless LAN devices operate within the same radio frequency range and may interfere with one another. If you use Bluetooth and Wireless LAN devices simultaneously, you may occasionally experience a less than optimal network performance or even lose your network connection.*

*If you should experience any such problem, immediately turn off either one of your Bluetooth or Wireless LAN.*

---

Please visit <http://www.pc.support.global.toshiba.com>, if you have any questions about using Wireless LAN or Bluetooth Card from TOSHIBA.  
In Europe visit <http://www.toshiba-europe.com/computers/tnt/bluetooth.htm>

## Wireless Devices and your health

Wireless products, like other radio devices, emit radio frequency electromagnetic energy. The level of energy emitted by Wireless products however is far much less than the electromagnetic energy emitted by wireless devices like for example mobile phones.

Because Wireless products operate within the guidelines found in radio frequency safety standards and recommendations, TOSHIBA believes Wireless products are safe for use by consumers. These standards and recommendations reflect the consensus of the scientific community and result from deliberations of panels and committees of scientists who continually review and interpret the extensive research literature.

In some situations or environments, the use of Wireless products may be restricted by the proprietor of the building or responsible representatives of the organization. These situations may for example include:

- Using the Wireless products equipment on board of airplanes, or
- In any other environment where the risk of interference to other devices or services is perceived or identified as harmful.

If you are uncertain of the policy that applies on the use of wireless devices in a specific organization or environment (e.g. airports), you are encouraged to ask for authorization to use the Wireless device prior to turning on the equipment.

## Wireless LAN Technology

The computer's wireless communication function supports some wireless communication devices.

Only some models are equipped with both Wireless LAN and Bluetooth functions.



- *Do not use the Wireless LAN (Wi-Fi) or Bluetooth functionalities near a microwave oven or in areas subject to radio interference or magnetic fields. Interference from a microwave oven or other source can disrupt Wi-Fi or Bluetooth operation.*
- *Turn all wireless functionalities off when near a person who may have a cardiac pacemaker implant or other medical electric device. Radio waves may affect pacemaker or medical device operation, possibly resulting in serious injury. Follow the instruction for your medical device when using any wireless functionality.*

- *Always turn off wireless functionality if the computer is near automatic control equipment or appliances such as automatic doors or fire detectors. Radio waves can cause malfunction of such equipment, possibly resulting in serious injury.*
- *It may not be possible to make a network connection to a specified network name using the ad hoc network function. If this occurs, the new network (\*) will have to be configured for all computers connected to the same network in order to re-enable network connections.*  
\* Please be sure to use new network name.

### **Security**

- TOSHIBA strongly recommend that you enable encryption functionality, otherwise your computer will be open to illegal access by an outsider using a wireless connection. If this occurs, the outsider may illegally access your system, eavesdrop, or cause the loss or destruction of stored data.
- TOSHIBA is not liable for the loss of data due to eavesdropping or illegal access through the wireless LAN and the damage thereof.

### **Card Specifications**

<b>Form Factor</b>	PCI Express Mini Card
<b>Compatibility</b>	■ IEEE 802.11 Standard for Wireless LANs
<b>Network Operating System</b>	■ Microsoft Windows Networking
<b>Media Access Protocol</b>	■ CSMA/CA (Collision Avoidance) with Acknowledgment (ACK)

### **Radio Characteristics**

Radio Characteristics of Wireless LAN module may vary according to:

- Country/region where the product was purchased
- Type of product

Wireless communication is often subject to local radio regulations. Although Wireless LAN wireless networking products have been designed for operation in the license-free 2.4GHz and 5GHz band, local radio regulations may impose a number of limitations to the use of wireless communication equipment.

<b>Radio Frequency</b>	■ Band 5GHz (5150-5850 MHz) (Revision a and n)
	■ Band 2.4GHz (2400-2483.5 MHz) (Revision b/g and n)

---

The range of the wireless signal is related to the transmit rate of the wireless communication. Communications at lower transmit range may travel larger distances.

- The range of your wireless devices can be affected when the antennas are placed near metal surfaces and solid high-density materials.
- Range is also impacted due to "obstacles" in the signal path of the radio that may either absorb or reflect the radio signal.

## **Bluetooth wireless technology**

Some computers in this series have Bluetooth wireless communication function which eliminates the need for cables between electronic devices such as computers, printers and mobile phones. When it is enabled, Bluetooth provides the wireless personal area network environment which is safe and trustworthy, that is quick and easy.

You cannot use the computer's built-in Bluetooth functions and an external Bluetooth adaptor simultaneously. For reference, Bluetooth wireless technology has the following features:

### ***Security***

Two advanced security mechanisms ensure a high level of security:

- Authentication prevents access to critical data and makes it impossible to falsify the origin of a message.
- Encryption prevents eavesdropping and maintains link privacy.

### ***Worldwide operation***

The Bluetooth radio transmitter and receiver operate in the 2.4GHz band, which is license-free and compatible with radio systems in most countries in the world.

### ***Radio links***

You can easily establish links between two or more devices, with these links being maintained even if the devices are not within a line-of-sight of each other.

### ***Radio Frequency Interference Requirements***

This device is restricted to indoor use due to its operation in the 5.15 to 5.25GHz frequency range.

## **Radio Regulatory Information**

The Wireless device must be installed and used in strict accordance with the manufacturer's instructions as described in the user documentation that comes with the product. This product complies with the following radio frequency and safety standards.

---

## **Europe**

### ***Restrictions for Use of 2400.0-2483.5MHz Frequencies in Europe***

<b>France:</b>	Outdoor use limited to 10mW e.i.r.p. within the band 2454-2483.5MHz	Military Radiolocation use.Refarming of the 2.4GHz band has been ongoing in recent years to allow current relaxed regulation Full implementation planned 2012.
<b>Italy:</b>	-	For private use, a general authorization is required if WAS/ RLAN's are used outside own premises. For public use, a general authorization is required.
<b>Luxembourg:</b>	Implemented	General authorization required for network and service supply.
<b>Norway:</b>	Implemented	This subsection does not apply for the geographical area within a radius of 20 km from the centre of Ny-Alesund.
<b>Russian Federation:</b>	-	Only for indoor applications.

### ***Restrictions for Use of 5150-5350MHz Frequencies in Europe***

<b>Italy:</b>	-	For private use, a general authorization is required if WAS/ RLAN's are used outside own premises.
<b>Luxembourg:</b>	Implemented	General authorization required for network and service supply.

<b>Russian Federation:</b>	Limited	<p>e.i.r.p 100mW. Permitted to use only for indoor applications, closed industrial and warehouse areas, and on board aircraft.</p> <ol style="list-style-type: none"> <li>1. Permitted to use for local networks of aircraft crew service communications on board aircraft in area of the airport and at all stages of flight.</li> <li>2. Permitted to use for public wireless access local networks on board aircraft during a flight at the altitude not less than 3000m.</li> </ol>
----------------------------	---------	---

---

***Restrictions for Use of 5470-5725MHz Frequencies in Europe***

---

<b>Italy:</b>	-	For private use, a general authorization is required if WAS/ RLAN's are used outside own premises.
<b>Luxembourg:</b>	Implemented	General authorization required for network and service supply
<b>Russian Federation:</b>	Limited	<p>e.i.r.p 100mW. Permitted to use only for indoor applications, closed industrial and warehouse areas, and on board aircraft.</p> <ol style="list-style-type: none"> <li>1. Permitted to use for local networks of aircraft crew service communications on board aircraft in area of the airport and at all stages of flight.</li> <li>2. Permitted to use for public wireless access local networks on board aircraft during a flight at the altitude not less than 3000m.</li> </ol>

---

To remain in conformance with European spectrum usage laws for Wireless LAN operation, the above 2.4GHz and 5GHz channel limitations apply for outdoor usage. The user should use the wireless LAN utility to



---

check the current channel of operation. If operation is occurring outside of the allowable frequencies for outdoor use, as listed above, the user must contact the applicable national spectrum regulator to request a license for outdoor operation.

### **Canada - Industry Canada (IC)**

This device complies with RSS 210 of Industry Canada. Operation is subject to the following two conditions: (1) this device may not cause interference, and (2) this device must accept any interference, including interference that may cause undesired operation of this device.

The term "IC" before the equipment certification number only signifies that the Industry Canada technical specifications were met.

### **USA-Federal Communications Commission (FCC)**

This equipment has been tested and found to comply with the limits for a Class B digital device, pursuant to Part 15 of FCC Rules. These limits are designed to provide reasonable protection against harmful interference in a residential installation.

Refer to the FCC information section for the detailed information.



*The radiated output power of the Wireless device is far below the FCC radio frequency exposure limits. Nevertheless, the Wireless device shall be used in such a manner that the potential for human contact during normal operation is minimized.*

*In the usual operating configuration, the distance between the antenna and the user should not be less than 20cm. Please refer to the computer user's manual for the details regarding antenna location.*

*The installer of this radio equipment must ensure that the antenna is located or pointed such that it does not emit RF field in excess of Health Canada limits for the general population; consult Safety Code 6, obtainable from Health Canada's website [www.hc-sc.gc.ca](http://www.hc-sc.gc.ca)*

### **Taiwan**

---

#### **Article 12**

Without permission granted by the NCC, any company, enterprise, or user is not allowed to change frequency, enhance transmitting power or alter original characteristic as well as performance to an approved low power radio frequency devices.

---

## Article 14

The low power radio-frequency devices shall not influence aircraft security and interfere legal communications;

If found, the user shall cease operating immediately until no interference is achieved.

The said legal communications means radio communications is operated in compliance with the Telecommunications Act.

The low power radio-frequency devices must be susceptible with the interference from legal communications or ISM radio wave radiated devices.

### ***Using this equipment in Japan***

In Japan, the frequency bandwidth of 2,400MHz to 2,483.5MHz for second generation low-power data communication systems such as this equipment overlaps that of mobile object identification systems (premises radio station and specified low-power radio station).

#### ***1. Important notice***

The frequency bandwidth of this equipment may operate within the same range as industrial devices, scientific devices, medical devices, microwave ovens, licensed radio stations and non-licensed specified low-power radio stations for mobile object identification systems (RFID) used in factory production lines (Other Radio Stations).

1. Before using this equipment, ensure that it does not interfere with any of the equipment listed above.
2. If this equipment causes RF interference to other radio stations, promptly change the frequency being used, change the location of use, or turn off the source of emissions.
3. Contact an authorized TOSHIBA service provider if you have problems with interference caused by this product to Other Radio Stations.

#### ***2. Indication for Wireless LAN***

The indication shown below appears on this equipment.

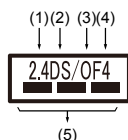

1. 2.4 : This equipment uses a frequency of 2.4GHz.
2. DS : This equipment uses DS-SS modulation.
3. OF : This equipment uses OFDM modulation.
4. 4 : The interference range of this equipment is less than 40m.
5. ■ ■ ■ : This equipment uses a frequency bandwidth from 2,400MHz to 2,483.5MHz. It is possible to avoid the band of mobile object identification systems.

### 3. Indication for Bluetooth

The indication shown below appears on this equipment.

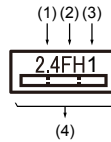

1. 2.4 : This equipment uses a frequency of 2.4 GHz.
2. FH : This equipment uses FH-SS modulation.
3. 1 : The interference range of this equipment is less than 10m.
4. □ □ □ : This equipment uses a frequency bandwidth from 2,400 MHz to 2,483.5 MHz. It is impossible to avoid the band of mobile object identification systems.

### 4. About the JEITA

5GHz Wireless LAN supports W52/W53/W56 Channel.

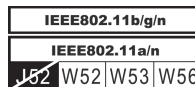

## Device Authorization

This device obtains the Technical Regulation Conformity Certification and it belongs to the device class of radio equipment of low-power data communication system radio station stipulated in the Telecommunications Business Law of Japan.

- Intel® Centrino® Wireless-N 2230 Wireless LAN and Bluetooth

The Name of the radio equipment: 2230BNHMW

DSP Research, Inc.

Approval Number: D111287003

- Realtek® RTL8188EE 802.11n Wireless LAN  
The Name of the radio equipment: RTL8188EE  
DSP Research, Inc.  
Approval Number: D120135003
- Atheros QCWB335 Wireless Network Adapter b/g/n(b/g) and Bluetooth  
The Name of the radio equipment: QCWB335  
DSP Research, Inc.  
Approval Number: D120156003

The following restrictions apply:

- Do not disassemble or modify the device.
- Do not install the embedded wireless module into other device.

## Radio approvals for wireless devices

This equipment is approved to the radio standard by the countries/regions in the following table.



*If you use this equipment in the countries/regions which are not listed in the table below, please contact TOSHIBA Support.*

As of March 2013

Austria	Belgium	Bulgaria	Canada
Cyprus	Czech Rep	Denmark	Estonia
Finland	France	Germany	Greece
Hong Kong	Hungary	Iceland	India
Indonesia	Ireland	Italy	Japan
Korea	Latvia	Liechtenstein	Lithuania
Luxemburg	Malta	Monaco	Netherlands
Norway	Philippines	Poland	Portugal
Romania	Slovak Republic	Slovenia	Spain
Sweden	Switzerland	UK	USA

## Legal Footnotes

### Non-applicable Icons

Certain computer chassis are designed to accommodate all possible configurations for an entire product series. Therefore, please be aware that

---

your selected model may not have all the features and specifications corresponding to all of the icons or switches shown on the computer chassis.

## CPU

Central Processing Unit (CPU) Performance Legal Footnotes.

CPU performance in your computer product may vary from specifications under the following conditions:

- use of certain external peripheral products
- use of battery power instead of AC power
- use of certain multimedia, computer generated graphics or video applications
- use of standard telephone lines or low speed network connections
- use of complex modeling software, such as high end computer aided design applications
- use of several applications or functionalities simultaneously
- use of computer in areas with low air pressure (high altitude >1,000 meters or >3,280 feet above sea level)
- use of computer at temperatures outside the range of 5°C to 30°C (41°F to 86°F) or >25°C (77°F) at high altitude (all temperature references are approximate and may vary depending on the specific computer model - please refer to your computer documentation or visit the TOSHIBA website at [www.pcsupport.toshiba.com](http://www.pcsupport.toshiba.com) for details).

CPU performance may also vary from specifications due to design configuration.

Under some conditions, your computer product may automatically shut-down. This is a normal protective feature designed to reduce the risk of lost data or damage to the product when used outside recommended conditions. To avoid risk of lost data, always make back-up copies of data by periodically storing it on an external storage medium. For optimum performance, use your computer product only under recommended conditions. Read additional restrictions in your product documentation. Contact TOSHIBA technical service and support, refer to [TOSHIBA support](#) section for more information.

### ***64-Bit Computing***

Certain 32-bit device drivers and/or applications may not be compatible with a 64-bit CPU/operating system and therefore may not function properly.

## Memory (Main System)

Part of the main system memory may be used by the graphics system for graphics performance and therefore reduce the amount of main system memory available for other computing activities. The amount of main system memory allocated to support graphics may vary depending on the

---

graphics system, applications utilized, system memory size and other factors.

If your computer is configured with more than 3 GB memory, the memory might be displayed as approximately 3 GB only (depending on the computer's hardware specifications).

This is correct because the operating system usually displays the available memory instead of the physical memory (RAM) built into the computer.

Various system components (like the video adapter's GPU and PCI devices like Wireless LAN, etc.) require their own memory space. Since a 32-bit operating system cannot address more than 4 GB of memory, these system resources overlap the physical memory. It is a technical limitation that the overlapped memory is not available to the operating system. Even though some tools might display the actual physical memory built into your computer, the memory available to the operating system will still be approximately 3 GB only.

Computers configured with a 64-bit operating system can address 4 GB or more of system memory.

## Battery Life

Battery life may vary considerably depending on product model, configuration, applications, power management settings and features utilized, as well as the natural performance variations produced by the design of individual components. Published battery life numbers are achieved on select models and configurations tested by TOSHIBA at the time of publication. Recharge time varies depending on usage. Battery may not charge while computer is consuming full power.

After going through many charge and discharge cycles, the battery will lose its ability to perform at maximum capacity and will need to be replaced. This is a normal phenomenon for all batteries. To purchase a new battery pack, see the accessories information that is shipped with your computer.

## Hard Disk Drive (HDD) Capacity

1 Gigabyte (GB) means  $10^9 = 1,000,000,000$  bytes using powers of 10. The computer operating system, however, reports storage capacity using powers of 2 for the definition of  $1 \text{ GB} = 2^{30} = 1,073,741,824$  bytes, and therefore shows less storage capacity. Available storage capacity will also be less if the product includes one or more pre-installed operating systems, such as Microsoft Operating System and/or pre-installed software applications, or media content. Actual formatted capacity may vary.

## LCD

Over a period of time, and depending on the usage of the computer, the brightness of the LCD screen will deteriorate. This is an intrinsic characteristic of LCD technology.

---

Maximum brightness is only available when operating in AC power mode. Screen will dim when the computer is operated on battery power and you may not be able to increase the brightness of the screen.

## Graphics Processing Unit (GPU)

Graphics processing unit (GPU) performance may vary depending on product model, design configuration, applications, power management settings and features utilized. GPU performance is only optimized when operating in AC power mode and may decrease considerably when operating in battery power mode.

Total Available Graphics Memory is the total of, as applicable, Dedicated Video Memory, System Video Memory and Shared System Memory. Shared System Memory will vary depending on system memory size and other factors.

## Wireless LAN

The transmission speed over the wireless LAN and the distance over which wireless LAN can reach may vary depending on surrounding electromagnetic environment, obstacles, access point design and configuration, and client design and software/hardware configurations.

The actual transmission speed will be lower than the theoretical maximum speed.

## Copy Protection

Applicable copy protection standards included in certain media may prevent or limit recording or viewing of the media.

## Glossary

The terms in this glossary cover topics related to this manual. Alternate naming is included for reference.

### Abbreviations

<b>AC:</b>	Alternating Current
<b>AMT:</b>	Intel Active Management Technology
<b>ASCII:</b>	American Standard Code for Information Interchange
<b>BIOS:</b>	Basic Input/output System
<b>BD-ROM:</b>	Blu-ray Disc Read-only Memory
<b>bps:</b>	bits per second
<b>CD:</b>	Compact Disc
<b>CD-ROM:</b>	Compact Disc Read-only Memory
<b>CD-RW:</b>	Compact Disc-rewritable

---

<b>CMOS:</b>	Complementary Metal-oxide Semiconductor
<b>CPU:</b>	Central Processing Unit
<b>DC:</b>	Direct Current
<b>DDR:</b>	Double Data Rate
<b>DIMM:</b>	Dual Inline Memory Module
<b>DVD:</b>	Digital Versatile Disc
<b>DVD-R:</b>	Digital Versatile Disc-recordable
<b>DVD-RAM:</b>	Digital Versatile Disc-random Access Memory
<b>DVD-R DL:</b>	Digital Versatile Disc Recordable Dual Layer
<b>DVD-ROM:</b>	Digital Versatile Disc-read Only Memory
<b>DVD-RW:</b>	Digital Versatile Disc-rewritable
<b>DVD+R DL:</b>	Digital Versatile Disc Recordable Double Layer
<b>FAT:</b>	File Allocation Table
<b>FCC:</b>	Federal Communications Commission
<b>GB:</b>	gigabyte
<b>GBps:</b>	gigabytes per second
<b>HDD:</b>	Hard Disk Drive
<b>HDMI:</b>	High-definition Multimedia Interface
<b>HDMI CEC:</b>	High-definition Multimedia Interface Consumer Electronics Control
<b>HTML:</b>	Hypertext Markup Language
<b>IEEE:</b>	Institute of Electrical and Electronics Engineers
<b>I/O:</b>	Input/Output
<b>IRQ:</b>	interrupt request
<b>ISP:</b>	Internet Service Provider
<b>KB:</b>	kilobyte
<b>LAN:</b>	Local Area Network
<b>LCD:</b>	Liquid Crystal Display
<b>LED:</b>	Light Emitting Diode
<b>MB:</b>	megabyte
<b>MBps:</b>	megabytes per second
<b>MMC:</b>	Multi Media Card
<b>OCR:</b>	Optical Character Recognition (Reader)
<b>PC:</b>	Personal Computer
<b>PCI:</b>	Peripheral Component Interconnect

---



---

<b>PCMCIA:</b>	Personal Computer Memory Card International Association
<b>RAM:</b>	Random Access Memory
<b>RGB:</b>	Red, Green, and Blue
<b>RFI:</b>	Radio Frequency Interference
<b>ROM:</b>	Read Only Memory
<b>RTC:</b>	Real Time Clock
<b>S/P DIF:</b>	Sony/philips Digital Interface Format
<b>SD:</b>	Secure Digital
<b>SDHC:</b>	Secure Digital High Capacity
<b>SDRAM:</b>	Synchronous Dynamic Random Access Memory
<b>SSD:</b>	Solid State Drive
<b>TFT:</b>	Thin-film Transistor
<b>URL:</b>	Uniform Resource Locator
<b>USB:</b>	Universal Serial Bus
<b>UXGA:</b>	Ultra Extended Graphics Array
<b>VGA:</b>	Video Graphics Array
<b>WAN:</b>	Wide Area Network
<b>WSXGA:</b>	Wide Super Extended Graphics Array
<b>WSXGA+:</b>	Wide Super Extended Graphics Array Plus
<b>WUXGA:</b>	Wide Ultra Extended Graphics Array
<b>WXGA:</b>	Wide Extended Graphics Array
<b>WXGA+:</b>	Wide Extended Graphics Array Plus
<b>www:</b>	World Wide Web
<b>XGA:</b>	Extended Graphics Array

---

---

# Index

## A

- AC adaptor
  - additional 4-38
  - connecting 2-3
  - DC IN 19V jack 3-2

- ASCII characters 4-5

## B

- Battery
  - extending life 4-24
  - monitoring capacity 4-23
  - real time clock 3-10, 4-21
  - save mode 5-6
  - types 4-21

- Battery indicator

- Bluetooth 7-7

## C

- Cleaning the computer 1-13

- Cooling vents 3-5, 3-6, 3-9

## D

- DC IN
  - indicator 3-1

- DC IN/Battery indicator 3-14

- Display
  - automatic power off 5-6
  - hinges 3-8
  - opening 2-5
  - screen 3-8

- Display controller 3-11

- Documentation list 2-1

- Dual Pointing Device
  - Touch Pad 6-8

- DVD Super Multi drive
  - using
  - writing

## E

- Equipment checklist 2-1

- External monitor
  - problems 6-13

## H

- Hard disk drive
  - automatic power off 5-6

- HDMI out port 3-4

## K

- Keyboard
  - function keys 4-4
  - Function keys F1...F12 4-4
  - problems 6-6
  - Windows special keys 4-5

## L

- LAN
  - cable types 4-25
  - connecting 4-25

---

## M

Media care  
Card care 4-32  
Memory card care 4-32

Memory  
installing 4-27  
removing 4-29

memory media card  
inserting 4-33  
removing 4-33

Memory media slot 4-30

Moving the computer 1-14

MultiMediaCard  
removing 4-33

## P

Password  
power on 5-6  
Starting the computer by  
password 5-9  
Supervisor 5-9  
user 5-7

Pointing Device  
Touch Pad 3-8

Power  
conditions 3-13  
Hibernation Mode 2-10  
panel on/off 5-6  
Shut Down mode 2-8  
Sleep Mode 2-9  
turning off 2-8  
turning on 2-6

## Problems

AC power 6-5  
Analyzing the problem 6-2  
Battery 6-5  
Dual Pointing device 6-8  
External monitor 6-12  
Hardware and system  
checklist 6-4  
HDD 6-7  
Internal display panel 6-7  
Keyboard 6-6  
Memory Media Card 6-8  
Overheating power  
down 6-5  
Power 6-4  
Real Time Clock 6-6  
Sound system 6-12  
TOSHIBA support 6-14  
Touch Pad 6-8  
USB device 6-10  
USB mouse 6-9

## R

Recovery hard disk drive 5-25

Recovery Media 5-24

Restarting the computer 2-8

## S

SD/SDHC/SDXC Card  
formatting 4-32  
note 4-31

Security lock 4-37

Sleep Mode  
setting 2-9  
System automatic 5-6

Sound system  
problems 6-12

---

## T

TOSHIBA Desktop Assist 5-1

## U

USB device  
problems 6-10

## V

Video mode 4-40

Video RAM 3-10

## W

Web Camera 3-7

Wireless communication 7-5

## Free Manuals Download Website

<http://myh66.com>

<http://usermanuals.us>

<http://www.somanuals.com>

<http://www.4manuals.cc>

<http://www.manual-lib.com>

<http://www.404manual.com>

<http://www.luxmanual.com>

<http://aubethermostatmanual.com>

Golf course search by state

<http://golfingnear.com>

Email search by domain

<http://emailbydomain.com>

Auto manuals search

<http://auto.somanuals.com>

TV manuals search

<http://tv.somanuals.com>