

TOSHIBA

PCX5000

Wireless Cable Modem Gateway
Owner's Manual



TOSHIBA

Warning:

This product may not be exported outside the US and Canada without US Department of Commerce, Bureau of Export Administration authorization. Any export or re-export by the purchaser, directly or indirectly, in contravention of U.S. Export Administration Regulation is prohibited.

Product and company names in this Owner's manual are trademarks or trade names of their respective companies.

Copyright 2002, Toshiba Corporation. All rights reserved. This manual may not be reproduced, in part or in whole, without the permission of Toshiba Corporation. The content of this manual is subject to change without notice in the future. Toshiba Corporation assumes no liability for damages resulting from the use of this product or the information contained in this manual.

Table of Contents

Introduction	4
Features.....	4
System Requirements.....	4
Contact Information.....	4
Important Rules for Safe Operation	5
Installation.....	5
Use and Maintenance.....	6
Service.....	6
Overview	7
How does the PCX5000 work?	7
How does the PCX5000 connect to a computer?.....	7
How does the PCX5000 differ from a stand-alone DOCSIS cable modem?	7
What is DOCSIS?	7
Getting Started	8
Contacting your Cable Provider.....	8
Package Contents for the PCX5000 Wireless Cable Modem Gateway	8
PCX5000 Front and Rear View.....	9
CD-ROM Contents	10
Viewing the Owner's Manual	10
Setting Up Your PCX5000 and Computers	11
Installing the PCX5000	11
Mounting the PCX5000 on a Wall.....	13
Configuring Your Computers	14
Installing the Ethernet Connections	14
Installing the USB Drivers.....	15
Configuring the Computer for Wireless Operation.....	16
Windows Network Configuration.....	17
Network Configuration for Windows 98SE and Windows Me:	17
Network Configuration for Windows 2000:.....	18
Network Configuration for Windows XP:	19
Macintosh Ethernet and Wireless Network Configuration.....	20
Macintosh OS 9 Configuration.....	20
Macintosh OS X Configuration.....	22
Configuring the PCX5000 Gateway	23
The PCX5000 Administration Pages.....	25
PCX5000 Wireless Configuration	34
SofaWare Advanced Security Features	37
Appendix	43
Frequently Asked Questions.....	43
LED Diagnostics.....	47
Specifications	48
Regulatory.....	49
Glossary.....	50
STANDARD LIMITED WARRANTY	52
End-User License Agreement.....	53

TOSHIBA

Introduction

Congratulations on your new purchase!

Your new Toshiba DOCSIS Wireless Cable Modem Gateway will provide you with high-speed access to the Internet through your cable TV (CATV) network, allowing you to access your favorite sites at a fraction of the time it takes traditional telephone modems. In addition, your service will be always connected and Internet access may be shared with multiple computers. Those two features give you the information you want, when you want it, and your telephone line is kept free.

The PCX5000 is one product that contains a Cable Modem, Router/Hub, Firewall and Wireless Access Point. The integration of all these devices allows you to install a secure home computer network at a minimal cost and effort.

Features

- DOCSIS Certified Cable Modem
- Ethernet Switch with four 10/100 BaseT interfaces
- 802.11b Wireless interface with:
 - Built-in antenna
 - 64 and 128 bit encryption
- USB Interface for Microsoft Windows 98SE, 2000, Me and XP
- Built-in Configurable Firewall and Router with:
 - Network Address Translation (NAT)
 - Stateful Packet Inspection
 - DMZ Support
 - Pin-hole Functionality for Networked Applications
- DHCP Server for up to 25 Clients
- Embedded HTTP Management and Administration Interface
- Compatible with Microsoft Windows 98SE, 2000, Me and XP; MAC OS 9 and OS X
- Free Technical Support
- 3 Year Limited Warranty

System Requirements

- 100-120V 50/60Hz AC Power Source
- Microsoft Windows 98SE, 2000, Me and XP; MAC OS 9 or OS X based computer(s)
- A CD ROM Drive in one computer with a 10/100 Ethernet or USB Interface
- One of the following in each networked computer:
 - 10/100 Ethernet Interface
 - USB Interface (Windows OS only)
 - 802.11b Wireless Interface

Contact Information

Support Information

Phone: (949) 583-3223

Fax: (949) 583-3597

Web: http://toshibacablemodems.buscom.net/form_techsetup.html

Sales Information

Phone: (949) 461-4840email:

cablesales@networks.toshiba.com

Web Page

<http://networks.toshiba.com>

TOSHIBA

Important Rules for Safe Operation



In addition to the careful attention devoted to quality standards in the manufacture of your Toshiba PCX5000, safety is a major factor in the design of every product. However, safety is your responsibility, as well. This section lists important information that will help assure your enjoyment and proper use of the PCX5000 and accessory equipment. Please read it carefully before operating and using your modem.

Installation

Read and Follow Instructions - You should read all the safety and operating instructions before operating the modem. Follow all operating instructions.

Retain Instructions - You should save all the safety and operating instructions for your future reference.

Heed Warnings - Comply with all warnings on the PCX5000 and in the operating instructions.

Use the Recommended AC Adapter - You must use the adapter that comes with your Toshiba PCX5000.

Check Power Sources - The AC adapter for your Toshiba PCX5000 must be used with a AC100V-120V 50Hz/60Hz supply outlet. If you are not sure of the type of power supplied to your home, consult your dealer or local power company.

Be Careful of Overloading - Do not overload wall outlets or extension cords, as this can result in a risk of fire or electric shock. Overloaded AC outlets, extension cords, frayed power cords, damaged or cracked wire insulation, and broken plugs are dangerous. Periodically examine the cord, and if its appearance indicates damage or deteriorated insulation, have it replaced by your service technician.

Protect Power Cords - Route power supply cords so that they are not likely to be walked on or pinched by items placed upon or against them. Pay particular attention to cords where they are attached to plugs and convenience receptacles, and examine the point where the power cord attaches to the PCX5000.

Check Ventilation - Slots and openings in the enclosure are provided for ventilation to ensure reliable operation of the PCX5000 and to protect it from overheating. Do not block or cover these openings. Never block these openings by placing the PCX5000 on a bed, sofa, rug, or other similar surface. Never place the PCX5000 near or over a radiator or heat register, or any other heat source (including amplifiers). Do not place the PCX5000 in a built-in installation, such as a bookcase or equipment rack, unless you provide proper ventilation.

Do Not Use Accessories - Do not use attachments, unless they are recommended by Toshiba, as they may cause electrical or fire hazards.

Do Not Use Near Water - Do not use the PCX5000 near water - for example, near a bathtub, sink or laundry tub, in a wet basement or near a swimming pool.

Do Not Place Near a High Temperature Source - Do not use the PCX5000 near a source of heat such as a kitchen range, a fireplace or a radiator.

Use Caution in Mounting the PCX5000 - Do not place the PCX5000 on an unstable surface. The PCX5000 may fall, causing serious injury to a child or adult, as well as serious damage to the PCX5000.

Use Care when Mounting on the wall - When mounting the modem to the wall, take extra precautions to assure the modem is mounted securely. If the modem is not mounted securely, and the modem falls, it may cause serious injury to a child or adult, as well as serious damage to the PCX5000.

Do Not Use Near Medical Equipment - Do not operate the modem near equipment that is susceptible to electrical interference, or is used for medical purposes. Do not use the modem near a pacemaker or a patient care area in the hospital.

Ground the Cable Systems - Be sure that the outside cable system is grounded to provide some protection against voltage surges and built-up static charges.

Section 810 of the national Electric Code, ANSI/NFPA No. 70-1984 (Section 54 of the Canadian Electrical Code, Part 1) provides information with respect to proper grounding of the cable systems.

TOSHIBA



Important Information!

- **Do not disconnect the RF cable from your PCX5000 while the power to your modem is on.**
- **Wait at least 10 seconds between disconnecting and reconnecting the PCX5000 with the AC power adapter.**
- **Unplug the PCX5000 from the wall outlet carefully, as the AC adapter may be hot.**

Use and Maintenance

Unplug Power Before Cleaning - Do not use liquid or aerosol cleaners. Use a damp cloth for cleaning.

Keep Objects Out of Openings - Never push objects of any kind into the PCX5000 through openings such as the ventilation holes, as they may touch high voltage circuits and "short-out" parts, which could result in a fire or electric shock. Never spill liquid on the PCX5000.

Protect From Lightning – Unplug the PCX5000 during a lightning storm, or when leaving it unattended and unused for a long period. Remove the power adapter from the wall outlet, and disconnect the cable system. This will prevent damage to the PCX5000 due to lightning and power line surges. Take care not to touch the metal portion of PCX5000 or cables in a lightning storm.

Service

Do Not Remove Covers - Do not attempt to service the PCX5000 yourself, as opening or removing covers may expose you to dangerous voltage or other hazards. Refer all servicing to qualified service personnel. **Removing the cover will VOID your warranty.**

Refer Servicing to Qualified Service Personnel under the Conditions Listed Below

- If the power supply cord or plug is damaged.
- If liquid has been spilled or objects have fallen into the PCX5000.
- If the PCX5000 has been exposed to rain or water.
- If the PCX5000 does not operate normally as per the operating instructions.
- If the PCX5000 has been dropped or the case has been damaged.
- When the PCX5000 exhibits a distinct change in operation, such as the inability to complete its self-test.

Require Safety Check - Upon completion of any service or repairs to the PCX5000, ask the service technician to perform the recommended safety checks to verify that the PCX5000 is in a safe operating condition.

Security Precautions

The PCX5000 provides your home network with the highest level of security. However, no product can provide you with absolute protection against a determined effort to break into your system. We recommend using additional security precautions, such as encrypting files and folders to protect highly valuable or sensitive information.

If you are using the wireless access capability of the PCX5000 and the wireless security options (encryption and access control) are disabled, an unauthorized user can penetrate your computers with a remote wireless device. See the section "**PCX5000 Wireless Configuration**" in this manual to set the appropriate wireless security parameters.

Range of Wireless Communication

The range of the wireless signal may vary according to the actual radio conditions at the location where the wireless LAN product is installed. The range of wireless devices may be affected by metal surfaces and high-density materials such as concrete walls. Range is also impacted due to "obstacles" in the signal path of the radio that may either absorb or reflect the radio signal.

TOSHIBA

Overview

The PCX5000 provides you with high-speed data communications over the television cable network by following the widely accepted DOCSIS standard. This standard, as defined by CableLabs™, offers a combination of high performance and interoperability among all major cable system operators in North America.

How does the PCX5000 work?

Digital signals are represented by high and low electrical voltage levels. The speed of how fast these levels can switch and still be transmitted is determined by the "bandwidth" of the transmission system. The pair of wires used in a telephone connection has a greatly limited bandwidth because of their electrical characteristics. When a device called a modem is connected between the computer output and the phone line, it generates an electrical wave whose strength and phase change in step with the highs and lows of the computer's digital output. It is because of the "smoothness" of the resultant signal that a higher data rate can be transmitted.

A cable modem "modulates" and "demodulates" electrical signals in the same way that the telephone modem does. However, since coaxial cable can transmit much higher frequencies, cable modems are far more complex. None of the activity caused by the PCX5000 disturbs your regular cable TV reception.

How does the PCX5000 connect to a computer?

The 10/100 Ethernet connection, USB connection and 802.11b wireless connection used in this device are emerging as the most popular means of networking computers together and to the Internet.

How does the PCX5000 differ from a stand-alone DOCSIS cable modem?

The standalone cable modem is designed to connect one computer. The PCX5000 is designed to connect multiple computers using 10/100 Ethernet, USB and 802.11b wireless interface. For standalone cable modems, you typically need to purchase an additional networking device called a router to connect more than one computer to the cable modem. With the PCX5000, all of your computers can share your high-speed connection.

The PCX5000 also includes advance security features such as a Stateful Inspection firewall that can protect your personal information and your equipment from malicious damage by hackers. The PCX5000 Stateful Inspection firewall is intelligent enough to know what applications should be allowed to access your network, and those that should be excluded.

What is DOCSIS?

Data Over Cable Service Interface Specifications. DOCSIS defines interface requirements for cable modems involved in high-speed data distribution over a cable television network. On November 17, 1997, Cable Television Laboratories, Inc. (CableLabs) and its members established a formal path of certification for cable modem equipment suppliers to obtain an interoperability seal for their products based on the DOCSIS specification. This certification process provides cable modem equipment suppliers with a fast, market-oriented method for attaining cable industry acknowledgment of compliance with DOCSIS.

TOSHIBA

Getting Started

Contacting your Cable Provider.

Please keep in mind that you will need to notify your cable internet provider before using the new Toshiba PCX5000, even if you have a cable modem that is currently functioning with your computer.

Package Contents for the PCX5000 Wireless Cable Modem Gateway

Make sure that you have received the following items. Contact your dealer immediately if any item is missing or damaged,

- One Toshiba PCX5000 Wireless Cable Modem Gateway
- One 10/100BaseT LAN Cable (6 feet)
- One USB Cable (5 feet)
- One AC Power Adapter
- One CD-ROM containing:
- One Quick Start Guide
- One Warranty Statement

TOSHIBA

PCX5000 Front and Rear View

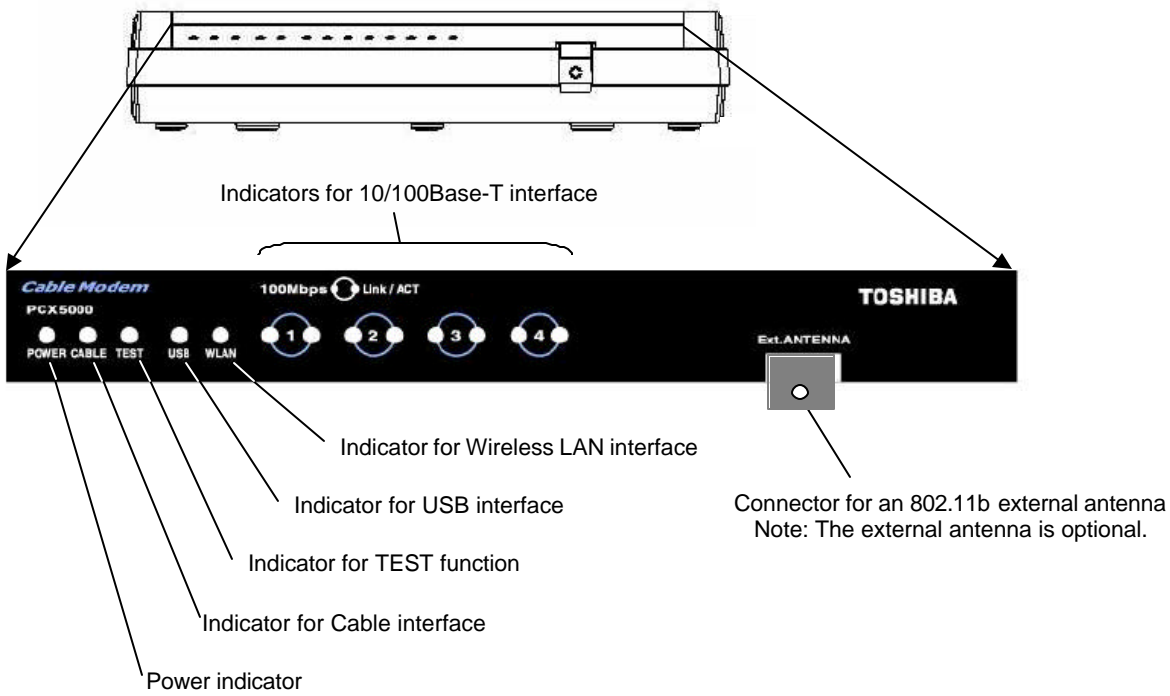

Front View (figure 1)

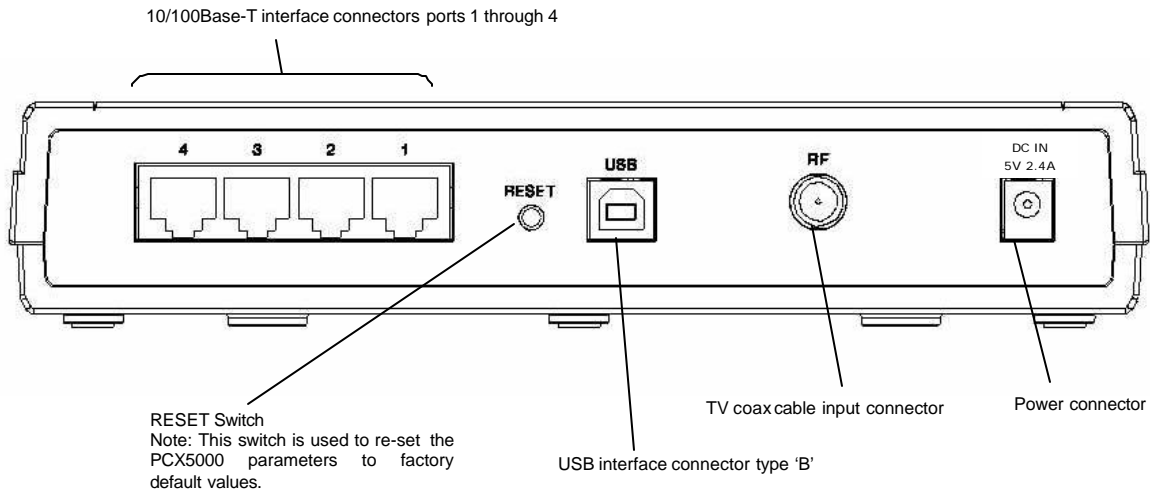

Rear View (figure 2)

TOSHIBA

CD-ROM Contents

The included CD-ROM contains:

- Owner's Manual (PDF)
- USB Drivers for Windows 98SE, 2000, Me and XP
- Acrobat(R)Reader™ Software

This CD-ROM is readable by Windows and Macintosh computers.



Important Information!

DO NOT insert this CD-ROM into a music CD player, as that may cause damage to your ears or the music CD player.

Viewing the Owner's Manual

This owner's manual is in the PDF format. To view this manual, perform the following steps:

1. Insert the CD-ROM into your computer's CD drive.
2. Open the file "**PCX5000.pdf**" in the folder "**Manual**".
3. The Adobe Acrobat®Reader™ Software should launch automatically. The Acrobat Reader must already be installed on your computer.

TOSHIBA

Setting Up Your PCX5000 and Computers

The steps for connecting your PCX5000 to your home computer network are as follows:

1. Install the PCX5000 in your cable TV and home computer network.
2. Configure your computers' Ethernet, USB or wireless interfaces.
3. Configure your computers' TCP/IP network settings.
4. Configure the PCX5000 for operating in your environment.

Installing the PCX5000

To avoid overheating problems, do not place any objects on top of the PCX5000. Do not block the ventilation holes on the top of the unit. The top of the unit should be at least four inches from any obstruction.

Connect the PCX5000 using the following steps, referring to figure 3.

1. Turn off the TV and computer.
2. Connect the cable TV coax cable to the input connector of a signal splitter.
3. Connect a coaxial cable from one of the output connectors of the splitter to the input connector of the television set.
4. Connect a coaxial cable from the other output connector of the splitter to the cable TV coax input connector (marked "RF") on the PCX5000 rear panel.
5. Connect the 10/100 Ethernet and/or USB cable(s) from your computer(s) to the 10/100 Ethernet and/or USB connector(s) on the PCX5000 rear panel.

You can use any combination of the following three ways to connect your computer(s) to the PCX5000.

- Ethernet (up to four computers directly connected)
 - USB (one computer)
 - Wireless (up to 126 computers)
6. Connect the AC power adapter to the DC IN 5V 2.4A jack on the PCX5000 rear panel. Then plug in the AC power adapter to the wall electrical outlet.

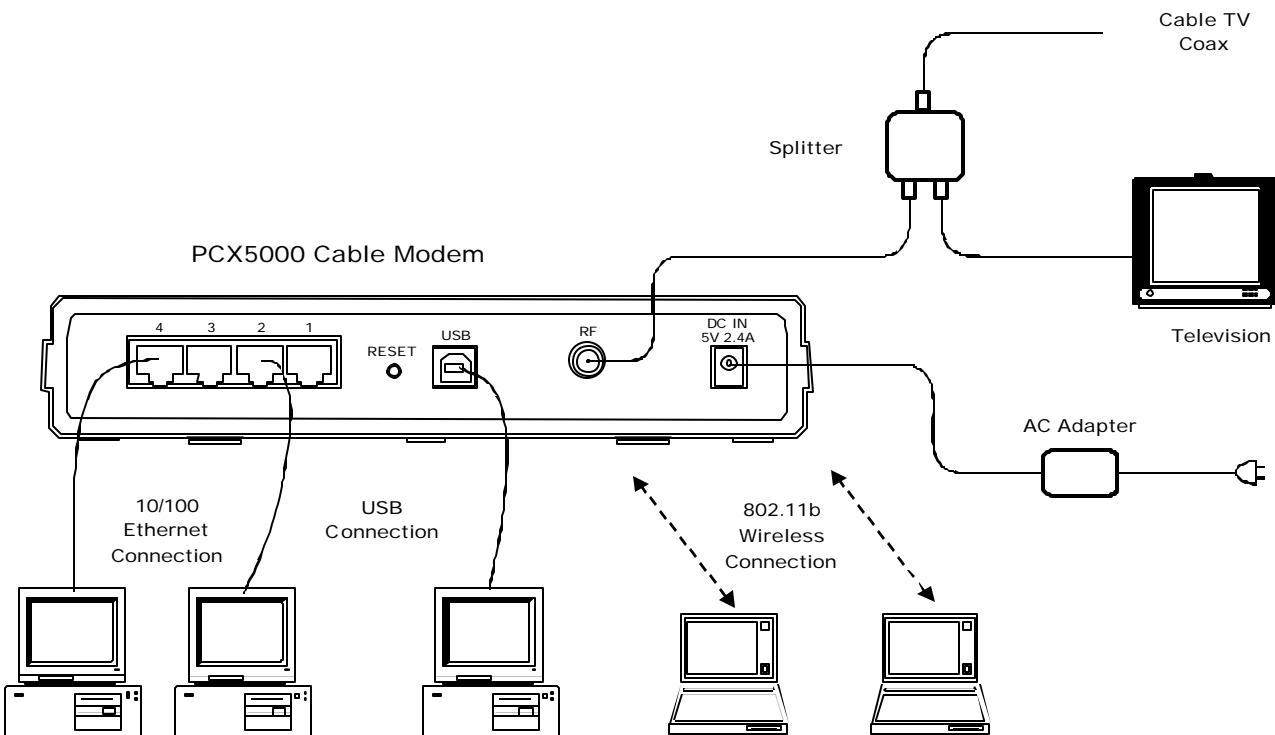

PCX5000 to Computer Connection (figure 3)

TOSHIBA

Once the AC adapter is connected to the modem, the power indicator LED on the PCX5000 front panel will light. The PCX5000 will start operating once power is connected. No additional operator intervention is required. The PCX5000 will perform its self-test, and then automatically find the data channel and register itself on the cable provider's system. The front panel indicators (LEDs) show that the PCX5000 is operating properly when they are in the following condition (refer to figure 4):

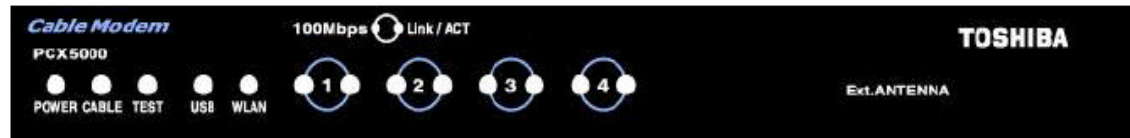

PCX5000 Front Panel (figure 4)

POWER	– On
CABLE	– On
TEST	– Off
USB	– On or flashing when USB is connected, Off when USB is not connected.
WLAN	– Flashing when 802.11b wireless data is transmitted/received, Off when wireless is not active.
100Mbps[1-4]	– (Left LED) On when 100BaseT Ethernet is connected, Off when 10BaseT is connected or no connection.
Link/Act[1-4]	– (Right LED) On or flashing when Ethernet is connected, Off when Ethernet is not connected.

If the PCX5000 front panel LEDs are not operating as described by the notes above, you may refer to the “**Diagnostics LEDs**” section in the appendix of this manual for more information.

If the PCX5000 appears to be operating correctly, you may now proceed to the next step.

7. If you are using the USB interface, install the USB driver following the instructions described in the “**Installing the USB Drivers**” section of this manual before proceeding to the “**Windows Network Configuration**” sections.

If you are connecting to the PCX5000 via the Ethernet connections, and already have the Ethernet hardware configured on your computers, you may power up your computers and proceed to the “**Windows Network Configuration**” or “**Macintosh Ethernet and Wireless Network Configuration**” section.

If you plan to use a wireless connection, please refer to “**PCX5000 Wireless Configuration**” sections of this manual before proceeding to the section, “**Windows Network Configuration**” or “**Macintosh Ethernet and Wireless Network Configuration**” section..

8. Once you have completed these steps, you should be able to connect to the Internet at high speed. If you are still having problems making your connection, please refer to the Q&A section at the end of this owner's manual.

TOSHIBA

Mounting the PCX5000 on a Wall

You may hang the PCX5000 on a wall with two mounting screws.

Pick a site on the wall while noting the following:

- Position the unit where it is easy to see the LEDs.
- Select a place where the AC power adapter may rest on a flat surface. Do not allow the AC adapter to hang from the cord!

Position the mounting screws as follows, referring to figure 5 below:

- Place the screws level with each other at a distance of 4-3/4 inches.
- Leave the head of screw rising 3/16's of an inch out of the wall
- Mount the PCX5000 on the screws.

Note: Wall mounting hardware is not included with the PCX5000. Please select screws and anchors suitable for the wall.



!!!CAUTION!!!

Take extra precautions to mount the PCX5000 securely. If the PCX5000 is not mounted securely and falls, serious harm or damage may result.

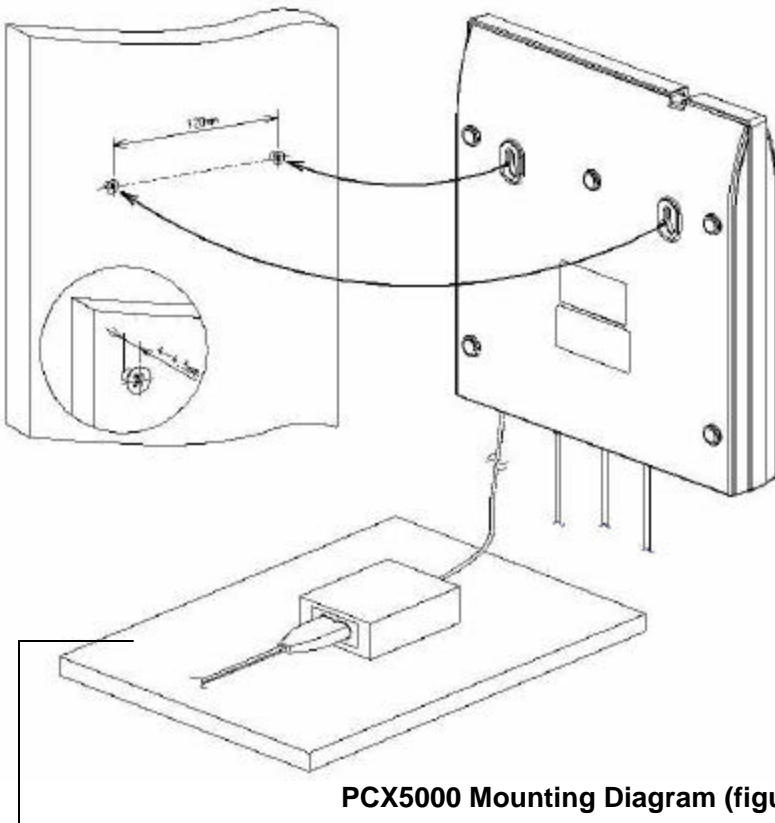

PCX5000 Mounting Diagram (figure 5)

Place the AC power adapter on a flat surface like a table.

TOSHIBA

Configuring Your Computers

The following sections describe the typical steps needed to configure your computer network to communicate with the PCX5000. These procedures apply to all of the interfaces (Ethernet, USB, and wireless) which you will connect to the PCX5000.

Examples of the network configuration steps for Windows 98SE, Me, 2000 and XP are explained with screen shots in the “**Windows Network Configuration**” section. Macintosh configurations for OS 9 and OS X are explained in the “**Macintosh Ethernet and Wireless Network Configuration**” section. These procedures instruct you on how to set up your computer to obtain an IP address automatically.

Before proceeding to the network setting section for your Windows or Macintosh computer, please verify you have correctly installed and configured the networking interfaces for Ethernet, USB or wireless 802.11b. **Macintosh users please note that the PCX5000 does not support a USB connection for the Macintosh computer.** Macintosh users must use an Ethernet or wireless (AirPort) connection.

Installing the Ethernet Connections

The PCX5000 has four 10/100 Ethernet ports that can be used to connect directly to a total of four computers. Each port can be shared with more than one computer by connecting an Ethernet hub or switch in between the PCX5000 and multiple computers. Each computer must have an Ethernet port or card to connect directly or indirectly to the PCX5000.

Note that the PCX5000 is a stand-alone device and requires no special Ethernet driver to be installed on your computers.

Your computer may already be configured with a built-in Ethernet port, or you may need to use an add-in card. In either case, verify your Ethernet port is working correctly and your computer is correctly configured for the TCP/IP protocol. Follow the instructions in the “**Windows Network Configuration**” section for your operating system. If you do not have an entry for an Ethernet adapter or TCP/IP protocol in the “**Network**” panel window, refer to your computer or Ethernet card adapter documentation. You may need to reinstall your Ethernet adapter card, drivers and TCP/IP protocol.

Macintosh users should refer to the “**Macintosh Ethernet and Wireless Network Configuration**” section to configure their network settings.

Once you have completed the network settings for your computer, you should be able to access the Internet at high speed with the Ethernet interface. If you are still having problems making a connection, please refer to the Frequently Asked Questions section in the appendix at the end of this owner's manual.

TOSHIBA

Installing the USB Drivers

If you are using the USB (Universal Serial Bus) interface to connect the PCX5000 to your Windows PC via the USB, you must install the **"USB Driver"** in your computer. The USB Driver for your operating system is located in the CD-ROM shipped with the PCX5000.

Please note that these USB Drivers only support a computer running Microsoft Windows 98SE, 2000, Me and XP. These drivers are not supported on the following operating systems: Windows 98 First Edition; Windows 95 or any earlier version of Microsoft Windows or DOS OS; Macintosh; Unix/Linux; and IBM OS/2.

Before installing and using these drivers, please be sure to read the **"End-User License Agreement"** which is enclosed in appendix of this owner's manual. You will be deemed to agree to this agreement if you use these drivers.

Preparation

1. Confirm the PCX5000 is ready by verifying the status panel LEDs. (See "PCX5000 Front Panel - figure 4")
2. Insert the USB Drivers CD-ROM into your CD-ROM drive.
3. Plug the "Type B" end of the USB cable into the back of the PCX5000.
4. Plug the "Type A" end of the USB cable into the USB port of your computer.
5. Turn on your computer.

Installing the USB Drivers

After following the instructions described in **"Preparation"** on this page, your Windows PC should finish its boot process and display a window identifying the PCX5000 as a new device and requesting its driver.

In general, follow these steps for installing the USB drivers.

1. Select **"Search for the Best Driver"** for your device" and click **"Next"**.
2. Select **"CD-ROM drive"** and click **"Next"**.
3. Windows should then begin installation.
4. Click **"Finish"** to complete the installation.

The following is an example for Windows 2000. Windows 98SE, Me and XP operating systems should operate in the same way.

Windows 2000 USB Driver Installation Example

Step 1: Shortly after restarting your computer, you should see the following pop-up window:



Step 2: After a few seconds, the **Found New Hardware Wizard** will prompt you through the driver install process. Press the **"Next"** button. The next set of windows will prompt you to specify the location of the driver. Select **"Search for a suitable driver for my device (recommended)"**, press **"Next"** and then select **"CD-ROM drives"** for the driver location.

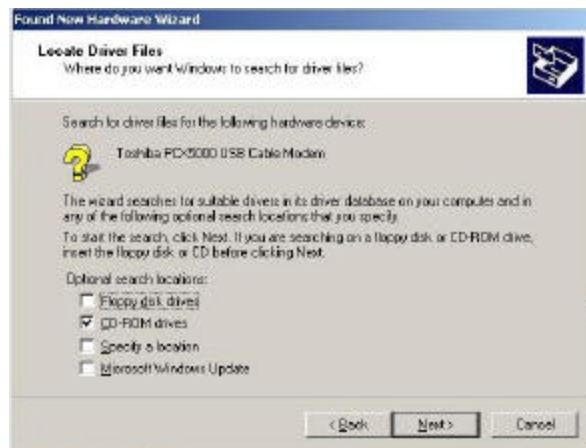

TOSHIBA

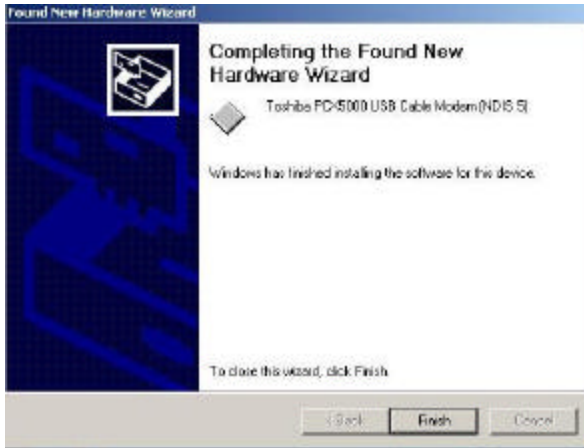

Step 3: Windows will search the CD-ROM drive for the USB driver. When it has found the driver, it will prompt you to go ahead with the installation. Press the “**Next**” button again.

Step 4: The process will repeat for installing the “**Toshiba PCX5000 Cable Modem networking support**”. When the installation is complete, you should see the following window on the left:

Step 5: Press the “**Finish**” button. You may now proceed to the “**Windows Networking Configuration**” section.



Important Information!

If you have trouble installing the USB drivers for your new PCX5000, you may have inadvertently installed the USB Composite Device Driver that Windows 98SE automatically loads. To correct this problem, please execute the following instructions:

USB Composite Driver Removal

1. Make sure that the USB cable is plugged into your computer.
2. Restart your computer.
3. At the Windows desktop, click on the “**Start**” button; select “**Settings**” and then “**Control Panel**”.
4. From inside the “**Control Panel**”, choose “**System**”.
5. Choose the tab on the top of the screen for “**Device Manager**”.
6. Click the “+” next to “**Universal Serial Bus Controllers**”.
7. Click “**USB Composite Device**” to select it and choose “**Remove**”.
8. Once the USB Composite Device is removed, restart your computer and follow the instructions starting with the “**Preparation**” section of this page.

Configuring the Computer for Wireless Operation

Please refer to the specific configuration instructions included with your wireless device for installation instruction. Wireless device must be 802.11b(Wi-Fi) compliant to be used with the PCX5000. These devices can be a PCI card, a PCMCIA card, or USB-based wireless access device.

The default settings for your wireless device to communicate with the PCX5000 are as follows.

Wireless: **Enabled** or **On**

Wireless Network Name (also called the ESSID): **PCX5000**

Encryption: **Disabled**

Channel: **6**

Mode: **Infrastructure**

Your wireless device may have more settings. Refer to your device documentation for the default settings and configure up your wireless device appropriately.

Detailed instructions for the Macintosh AirPort wireless card are provided in the “Macintosh Ethernet and Wireless Network Configuration” section of this manual.

TOSHIBA

Windows Network Configuration

Network Configuration for Windows 98SE and Windows Me:

The following is an example of how to configure a Windows 98SE and Me PC for TCP/IP network settings:

Step 1: At the Windows Desktop, click “Start”, then select “Settings”, and click “Control Panel” as shown in the screen below. The Control Panel window will appear.

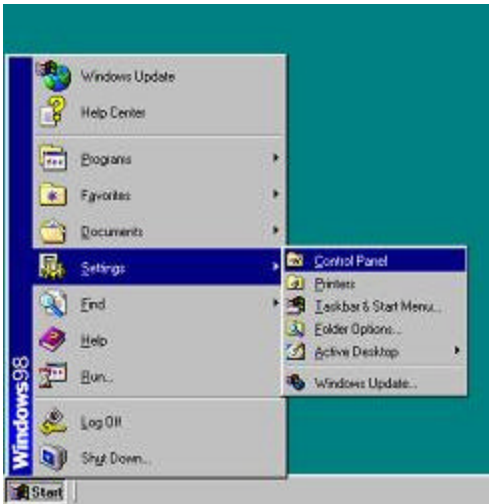

Step 2: At the Control Panel window, select and double click on the “Network” icon.



Step 3: In the Network panel window, scroll down to the TCP/IP network adapter in your computer. Select the “TCP/IP” line item and click on the “Properties” button.



Step 4: In the TCP/IP Properties panel, choose the “Obtain an IP address automatically” button and then press the “OK” button.



Step 5: Once you have completed the steps above, a notice to restart your computer will come up. Restart your computer.

Step 6: You should now be able to access the PCX5000 configuration pages. Launch the browser and open location:” <http://192.168.100.1> Proceed to the “Configuring the PCX5000 Gateway” section of this manual.

TOSHIBA

Network Configuration for Windows 2000:

The following is an example of how to configure the Windows 2000 TCP/IP network settings:

Step 1: At the Windows 2000 Desktop, click “**Start**”, then select “**Settings**”, and click on the “**Control Panel**” as shown in the screen below.

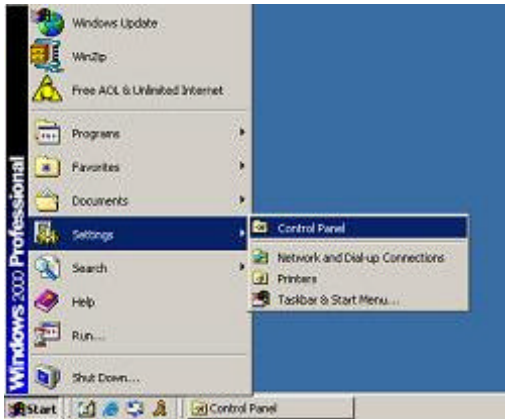

Step 2: At the Control Panel window, select and double click on the “**Network and Dial-up Connections**” icon.

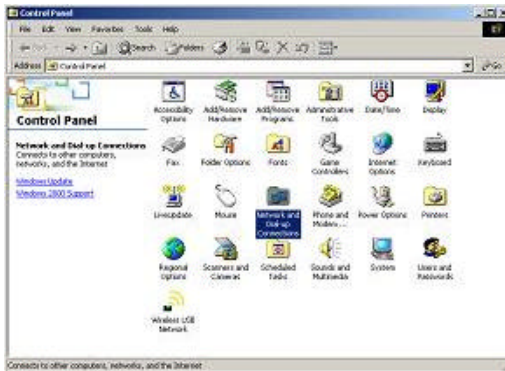

Step 3: In the Network and Dial-up Connections panel window, select and right click on the “**Local Area Connections**” icon, then select and click on the “**Properties**” menu item.

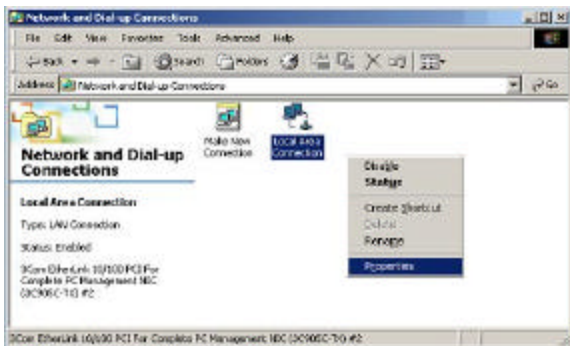

Step 4: In the Local Area Connection Properties panel, select the “**Internet Protocol (TCP/IP)**” item and then click on the “**Properties**” button.

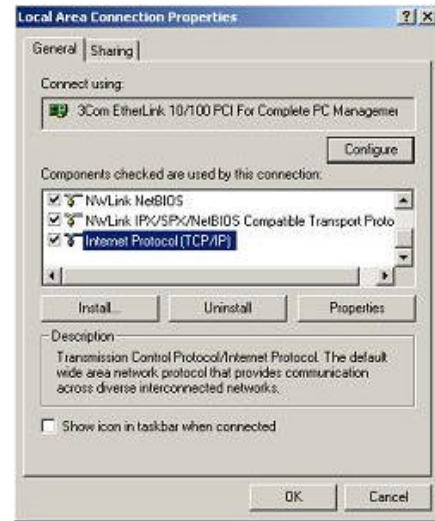

Step 5: In the Internet Protocol (TCP/IP) Properties panel, select “**Obtain an IP address automatically**”. Close each panel by pressing the “**OK**” button.

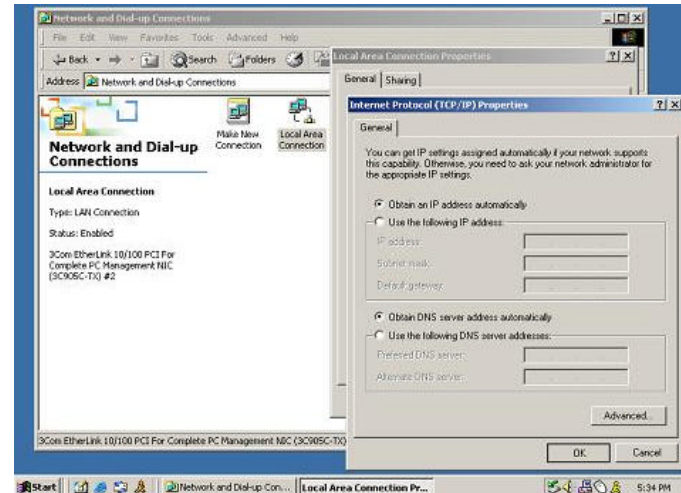

Step 6: You should now be able to access the PCX5000 configuration pages. Launch your browser and open location: <http://192.168.100.1>. Proceed now to the “**Configuring the PCX5000 Gateway**” section of this manual,

TOSHIBA

Network Configuration for Windows XP:

The following is an example of how to configure the Windows XP TCP/IP network settings:

Step 1: At the Windows XP Desktop, click **“Start”**, then select and click on the **“Control Panel”** item as shown in the screen below.



Step 2: At the Control Panel window, select and double click on the **“Network and Internet Connections”** icon.

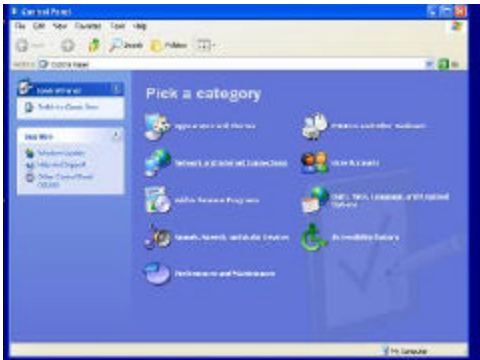

Step 3: In the Network and Internet Connections window, click on the **“Network Connections”** icon located in the lower right corner of the window.

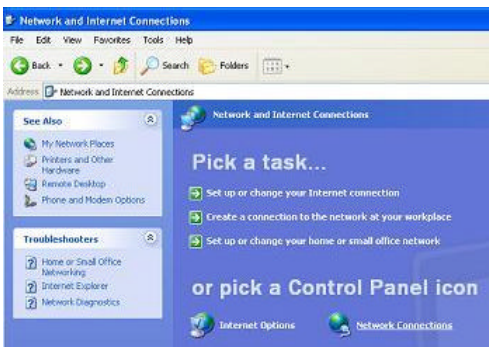

Step 4: In the Network Connections window, click on the **“Local Area Connection”** icon for your Ethernet adapter. Then click on the **“Properties”** button in the Local Area Connection Status panel. In the Local Area Connections Properties panel, select the **“Internet Protocol (TCP/IP)”** item and then click on the **“Properties”** button.

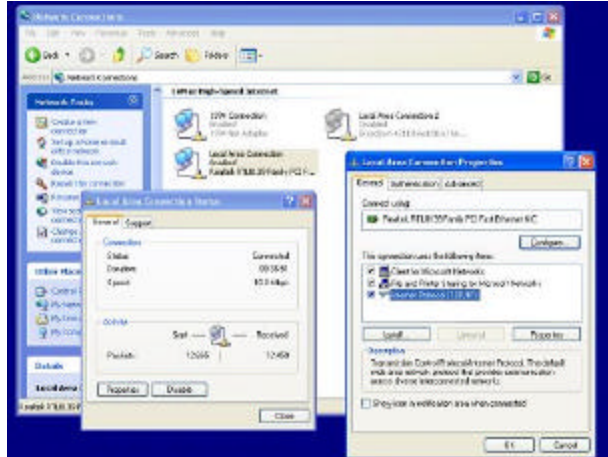

Step 5: In the Internet Protocol (TCP/IP) Properties panel, select **“Obtain an IP address automatically”**. Click the **“OK”** button at the bottom of the panel. Close each panel by pressing the **“OK”** buttons.



Step 6: You should now be able to access the PCX5000 configuration pages. Launch the browser and open location:” <http://192.168.100.1> Proceed to the **“Configuring the PCX5000 Gateway”** section of this manual.

TOSHIBA

Macintosh Ethernet and Wireless Network Configuration

The following screens describe how to configure the network settings for a Macintosh OS 9 computer.

Macintosh OS 9 Configuration Ethernet Settings

Step 1: At the Macintosh desktop, click the Apple icon at the top left of the screen, select **'Control Panel'**, and then click on the **"TCP/IP"** listing on the side panel.



Step 2: In the TCP/IP (Setup Ethernet) panel, select the Ethernet port you are using to connect your Macintosh to the PCX5000 in the Show choice box. The default port is **"Built-in Ethernet"**. Then select **"Using DHCP Server"** in the **Configure** choice box. Close the panel by clicking on the top left corner. You will be prompted to save the configuration.

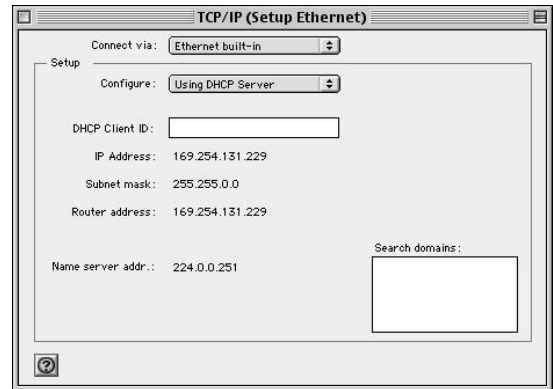

Step 3: You should now be able to access the **PCX5000 Configuration Pages**. Launch the browser supplied with the Macintosh and open location:” <http://192.168.100.1>” Proceed to the **Configuring the PCX5000** section of this manual.

TOSHIBA

Macintosh OS 9 AirPort Settings

If you are using the AirPort wireless connection, first verify the PCX5000 wireless link is turned on. Refer to the **“PCX5000 Wireless Configuration”** page in this manual.

Step 1: Using the same procedure described previously to set the Ethernet TCP/IP configuration, navigate to the TCP/IP (Setup Ethernet) panel and select **“AirPort”** in the **Connect via** choice box. Then select **“Using DHCP Server”** in the **Configure** choice box. You will be prompted to save the changes.

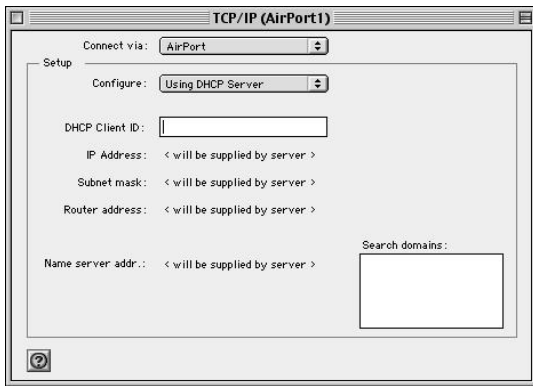

Step 2: At the Macintosh Desktop, double click on the **“Macintosh HD”** icon, and navigate to the **“AirPort Setup Assistant”** icon located in the Applications/Utilities/Assistants folder. Launch the **“AirPort Setup Assistant”** application by double clicking the icon. Select **“Set up your computer to join an existing AirPort network”**. Press the right arrow button to continue.



The Setup Assistant will scan for nearby 802.11b wireless base stations. If the PCX5000 is in range, it will respond with a message announcing it has joined the network.

If the AirPort Assistant cannot find a wireless network, verify the Macintosh is in range of the PCX5000 and that the PCX5000 has had the wireless option turned on.

Step 3: If the AirPort Setup Assistant is successful in finding the PCX5000 wireless base station, it will display a panel stating, **“The AirPort Assistant is now ready to configure your computer to access the network “PCX5000.”** Press the **“Go Ahead”** button to proceed.



Step 4: After several seconds, you will be notified that the AirPort Assistant was successful, and prompted to press the **“Connect Now”** button. After pressing the **“Connect Now”** button, your browser should launch automatically.

Step 5: You should now be able to access the Internet. You should immediately enable wireless encryption. With a 10/100 Ethernet connection, open location: <http://192.168.100.1>. Proceed now to the **“PCX5000 Wireless Configuration”** section of this manual to set the wireless security options.

TOSHIBA

Macintosh OS X Configuration Ethernet Settings

The following screen shots give an example of how to configure the network settings for a Macintosh OS X computer.

Step 1: At the Macintosh desktop, select the Apple icon at the top left of the screen, click on “**System Preferences**”, then select and click on the “**Network**” icon at the top of the panel.



Step 2: In the Network panel, Select “**Active Network Ports**” in the **Show** choice box to verify your networking interfaces (**Built-in Ethernet, Add-on Ethernet, or AirPort**) are active.

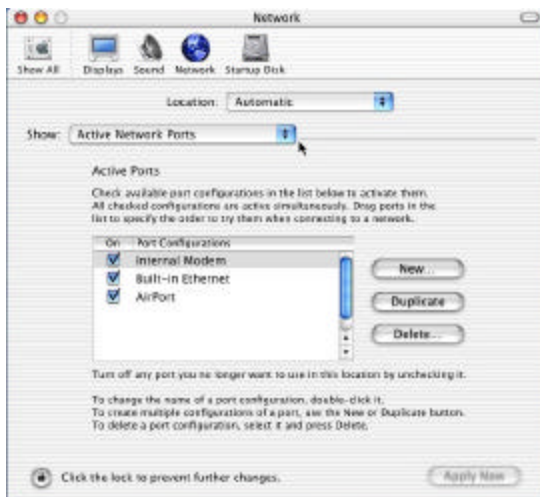

Step 3: Then select the Ethernet port you are using to connect your Macintosh to the PCX5000 in the Show choice box. The default port is “**Built-in Ethernet**”. Click on the TCP/IP tab and select “**Using DHCP**” in the **Configure** choice box.

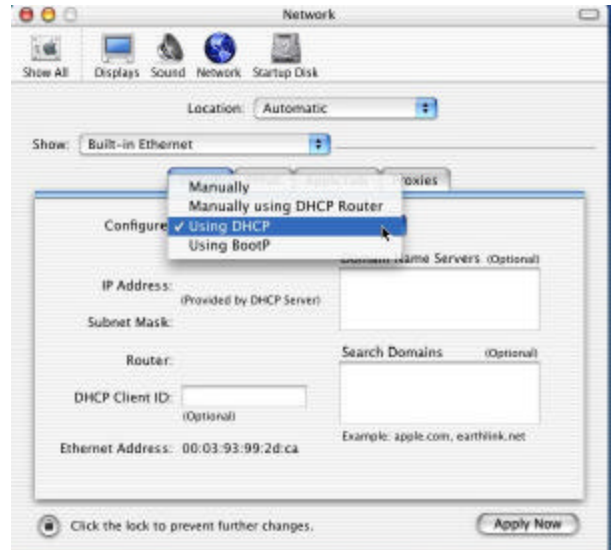

Step 4: Click the “**Apply Now**” button at the bottom right corner of the menu.

Step 5: You should now be able to access the PCX5000 configuration pages. Launch the browser supplied with the Macintosh and open location: ”<http://192.168.100.1>” Proceed now to the “**Configuring the PCX5000 Gateway**” section of this manual.

TOSHIBA

Macintosh OS X AirPort Settings

If you are using the AirPort wireless connection, first verify the PCX5000 wireless link is turned on. Refer to the **“PCX5000 Wireless Configuration”** page in this manual.

Step 1: In the Macintosh OS X toolbar (located at the top of the desktop) select the AirPort broadcast icon and choose **“Turn AirPort On”**.

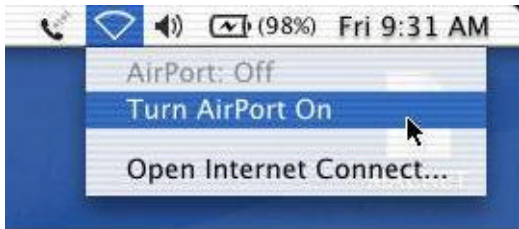

Step 2: At the Macintosh desktop, double click on the **“Macintosh HD”** icon, and navigate to the **“AirPort Setup Assistant”** icon located in the **“Applications/Utilities”** folder. Launch the **“AirPort Setup Assistant”** application by double clicking the icon. Select **“Set up your computer to join an existing AirPort network”**. Press the **“Continue”** button.

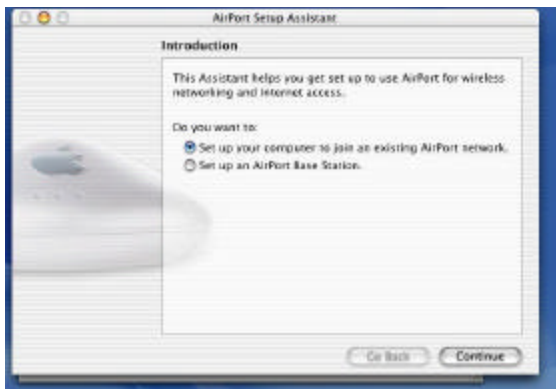

The Setup Assistant will scan for nearby 802.11b wireless base stations. If the PCX5000 is in range, it will respond with a message announcing it has joined the network.

If the AirPort Assistant cannot find a wireless network, verify the Macintosh is in range of the PCX5000 and that the PCX5000 has had the wireless option turned on (see **PCX5000 Wireless Configuration**).

Step 3: At the Macintosh desktop, select the Apple icon at the top right of the screen, click on **“System Preferences”**, and select and click on the **“Network”** icon at the top of the

panel. Then select **“AirPort”** in the **Show** choice box. Select the TCP/IP tab and select **“Using DHCP”** in the **Configure** choice box.

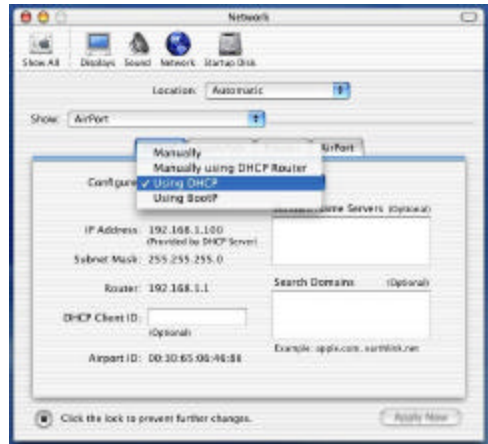

Step 4: While in the Network Panel, select the **“AirPort”** tab. Verify the Wireless Network Name of the PCX5000 (default is **“PCX5000”**) in the **“Preferred Network:”** text entry box. The PCX5000 should be listed as one of the available networks recognized by the AirPort card.

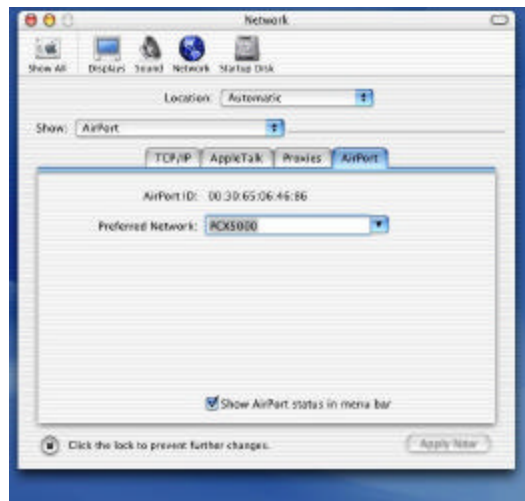

Step 5: You should now be able to access the Internet. You should immediately enable wireless encryption. With a 10/100 Ethernet connection, open location: **“http://192.168.100.1”**. Proceed now to the **“PCX5000 Wireless Configuration”** section of this manual to set the wireless security options.

Configuring the

PCX5000 Gateway

TOSHIBA

The following sections describe how to configure the network and security settings for the PCX5000. You should be able to access these settings once you have completed the Ethernet or USB installation for your computer. In most cases, you will not need to change the default settings of the PCX5000.

If you plan to use the wireless access capability of the PCX5000, please review the **‘PCX5000 Wireless Configuration’** section to set your security parameters. The default settings do not protect your home network from an attack by an unauthorized wireless user.

The PCX5000 contains an embedded Web server that allows you to change its configuration. The PCX5000 configuration web pages may be accessed through any Internet browser such as Microsoft Internet Explorer (5.0 or later recommended).

These web pages are password protected to prevent unauthorized changes.

The PCX5000 configuration options are available in these web page locations:

<u>Configuration Option:</u>	<u>PCX5000 Web page location:</u>
Turn the firewall On/Off (default: On)	see “Security->Firewall” Web page
Setup access rules	“Security->Allow”
Setup DMZ (Demilitarized Zone)	“Security->DMZ”
Setup host name	“System->Internet->Advanced Setup”
Setup fixed IP addresses for modem, PC’s	“System->Internet->Advanced Setup”
Change modem’s DHCP server settings	“System->My Network”
Change modem’s password	“System->Password”
Upgrade firewall security	“System->Upgrade”
Enable wireless encryption	“Wireless”

You may also check the PCX5000 status:

View firewall report	see “Security->Report”
View Internet statistics	“Security->Report”
View modem Status	“Status”

To access the PCX5000 Web page:

1. Launch Web browser(Internet Explorer 5.0 or later recommended) on a computer connected to the PCX5000.
2. Go to address: <http://192.168.100.1>

The PCX5000 Welcome page will appear.

TOSHIBA

The PCX5000 Administration Pages

This section describes how to access the PCX5000 settings through the browser interface.

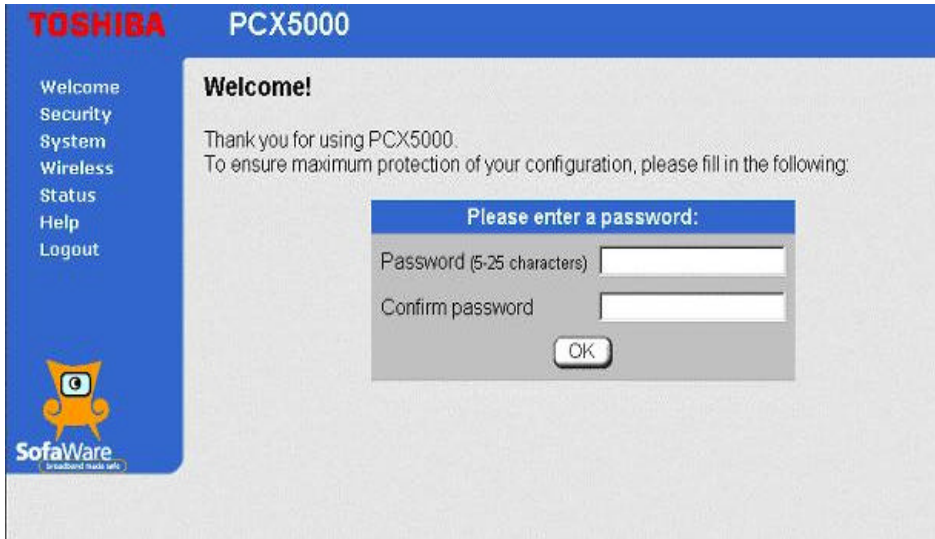

Login for the first time:

If you are accessing the PCX5000 for the first time, or have reset the modem to its factory defaults, you will be prompted for a login password. Enter the password of your choice into the dialog box. Retain this password for future reference. You will need to enter this password to access the PCX5000 internal settings.

Note: Write down the password in a secure place, as you will need it again to make changes to the PCX5000 configuration. If you forget your password, you may reset your PCX5000 to factory defaults using the Reset button (see figure 2). The Reset button is located behind the PCX5000 and should be pressed for at least 10 seconds until the modem reboots.



If you have accessed the PCX5000 configuration page before, the screen above appears:

Enter your password and click "OK".

Note: You will be automatically logged off after 10 minutes if no user input is received. You will need to re-enter your password in order to access the PCX5000 administration pages.

TOSHIBA

PCX5000 Welcome Page

TOSHIBA PCX5000

- Welcome
- Security
- System
- Wireless
- Status
- Help
- Logout

Welcome to TOSHIBA's PCX5000

The PCX5000 protects your network by incorporating the SofaWare Firewall, based on the industry-leading FireWall-1 from Check Point Software Technologies.

To the left is the navigation bar, which contains links to the major functions of the portal. Click 'help' for more information.

Your PCX5000 enables you to enhance your SofaWare security to allow multiple security levels, detailed reporting and advanced configuration options.

To learn more about how to upgrade the security of your PCX5000 click [here](#).

© Copyright 2001,2002 TOSHIBA CORPORATION, all rights reserved.
TOSHIBA is a registered trademark of the TOSHIBA CORPORATION.
Check Point is a registered trademark of Check Point Software Technologies Ltd.
SofaWare is a registered trademark of SofaWare Technologies Ltd.

Once the correct password has been entered, you may access each of the PCX5000 administration pages.

The **Main Menu Side Bar**, located on the left side of the web page, is used to navigate to a particular configuration section.

Main Menu Side Bar Detail

TOSHIBA	
•Welcome	Welcome – The initial start-up screen
Security	Security – Firewall configuration pages
System	System – Router and password configuration and status
Wireless	Wireless – Wireless access point configuration
Status	Status – PCX5000 status information
Help	Help – Simple references
Logout	Logout – Exit the PCX5000 administration site

TOSHIBA

The **Security** pages are used for configuring the firewall.

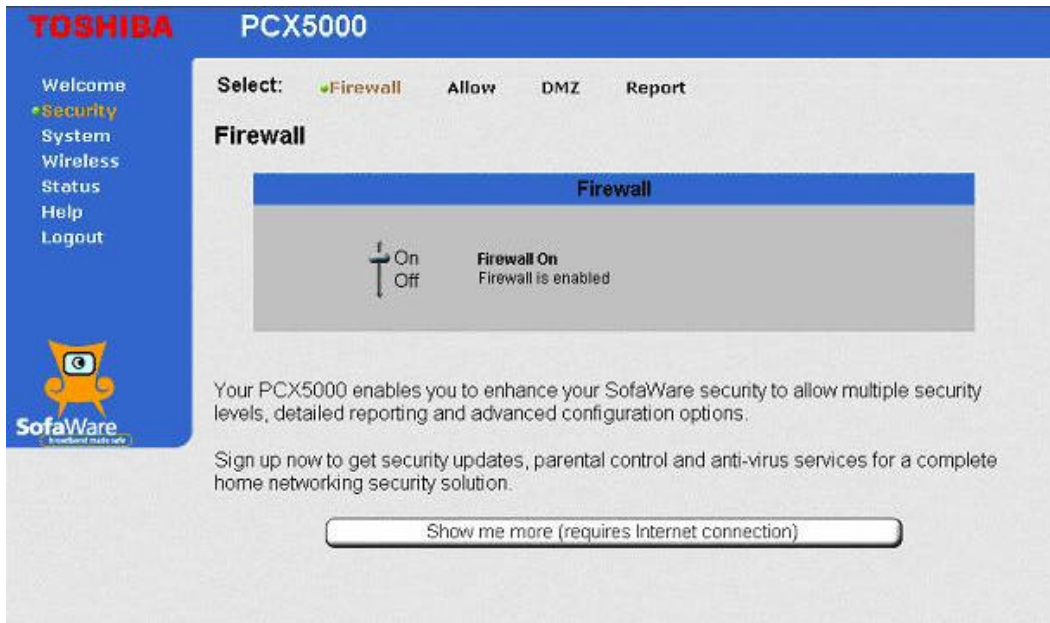

The screenshot shows the Toshiba PCX5000 web interface. At the top, it says 'TOSHIBA PCX5000'. On the left is a navigation menu with 'Welcome', 'Security' (highlighted), 'System', 'Wireless', 'Status', 'Help', and 'Logout'. Below the menu is the 'SofaWare' logo. The main content area has a 'Select:' dropdown menu with 'Firewall' selected, and tabs for 'Allow', 'DMZ', and 'Report'. The 'Firewall' section shows a toggle switch set to 'On' and the text 'Firewall On' and 'Firewall is enabled'. Below this, there is a paragraph: 'Your PCX5000 enables you to enhance your SofaWare security to allow multiple security levels, detailed reporting and advanced configuration options.' and another paragraph: 'Sign up now to get security updates, parental control and anti-virus services for a complete home networking security solution.' with a button 'Show me more (requires Internet connection)'.

The **Firewall** page displays the state of the firewall. The default setting for the firewall is **“On”**. This setting is recommended for connecting to the Internet for most typical home installations.

When the firewall is turned **“On”**:

- The Stateful Inspection firewall engine will be enabled.
- The PCX5000 will operate in “router” mode, which will enable the internal DHCP Server. Please refer to **“System Configuration/My Network”** web page description to change the network addresses.
- The PCX5000 will enable NAT (network address translation - see Glossary). The PCX5000 automatically obtains a single IP address from the CSP (Cable Service Provider) and shares this IP address with all of the computers on the home network.

If the firewall is turned **“Off”**:

- The Stateful Inspection firewall engine will be disabled.
- The PCX5000 will operate in “bridge” mode, which will disable the internal DHCP Server and NAT (network address translation).

It is not recommended to turn the firewall off unless you already have a firewall appliance or router that is installed in between the PCX5000 and your computers.



Important Information!

Turning Off the firewall will leave your computer vulnerable to an attack.



Important Information!

When you turn on/off the firewall, you need to power off and on PCX5000 and reboot your PC after PCX5000 starts.

TOSHIBA

The **Security/Allow** page is used to allow network applications such as a peer-to-peer music file sharing program to work with your firewall.

TOSHIBA PCX500

Welcome
Security
System
Wireless
Status
Help
Logout

Select: Firewall Allow DMZ Report

Allow Rules

I want to **permit incoming** access from the Internet to my internal network, for the following port ranges:

#	Ports	Protocol	Home IP
New:	<input type="text"/> - <input type="text"/>	ANY	<input type="text"/>

Add Clear

SofaWare

PCX5000 utilizes a Stateful Inspection Firewall that in most cases will recognize those applications that need access through the firewall, and will automatically configure the modem appropriately. If you experience problems with network access in using an application, refer to the application documentation for “**port numbers**” and “**protocols**” that are used by that application. Enter the port and protocol information, as well as the IP address of the computer running the application.

The **Security/DMZ** page is used to allow unlimited access from the Internet to a computer in your home network. The default setting for this page is all computers are protected.

TOSHIBA PCX500

Welcome
Security
System
Wireless
Status
Help
Logout

Select: Firewall Allow DMZ Report

DMZ IP Address

I want to allow **unlimited** access from the Internet to the following computer.

Warning: Entering an IP address may make the designated computer vulnerable to hacker attacks.

DMZ IP Address

Clear

Apply Cancel

SofaWare

The DMZ IP Address is used to identify a single computer on your network that will reside outside of the firewall and allow for unlimited access to and from the Internet.



Important information!

If you enter the IP Address of a computer, the Firewall will not protect this computer.

TOSHIBA

The **Security/Reports** page provides the Firewall statistics.

TOSHIBA PCX5000

Welcome
•Security
System
Wireless
Status
Help
Logout

Select: Firewall Allow DMZ **Report**

Reports

During the last 1 days the SofaWare firewall in your PCX5000 blocked 103 attacks.

Refresh

Your PCX5000 enables you to enhance your SofaWare security to allow multiple security levels, detailed reporting and advanced configuration options.

Sign up now to get security updates, parental control and anti-virus services for a complete home networking security solution.

Show me more (requires Internet connection)

By clicking the **“Show me more”** button, you will get more information regarding the enhanced firewall functionality available through the SofaWare upgrade. The SofaWare upgrade provides more detailed reports on intrusion statistics for your firewall.

The **Systems/Internet** page shows the current Internet connection status. If you have successfully connected to the Internet, the **Status** field should display **“Connected”** and the IP address of the PCX5000 will be displayed.

TOSHIBA PCX5000

Welcome
Security
•System
Wireless
Status
Help
Logout

Select: **Internet** My Network Password Upgrade

Internet

Connection	
Status	Connected
Connection Duration	N/A

Activity	
Received Packets	0
Sent Packets	0

Internet	
IP Address	192.168.100.1
MAC Address	00:90:83:7e:ed:c0

Advanced Setup

If you are having trouble making an Internet connection, you may need to specify a **“Host Name”**. Some CSP’s (Cable Service Providers) require you to enter a host name to access their network. With a Windows PC, you may identify the host name of your computer by right clicking the **“Start”** button in the tool bar, selecting **“Explore”** and clicking on the **“Network Neighborhood”** icon (Windows 98SE or Me) or **“My Network Places”** icon (Windows 2000, XP).

TOSHIBA

If a host name is required, click the “**Advanced Setup**” button on the PCX5000 **System/Internet** page. The following screen will appear that will allow you to enter the host name:

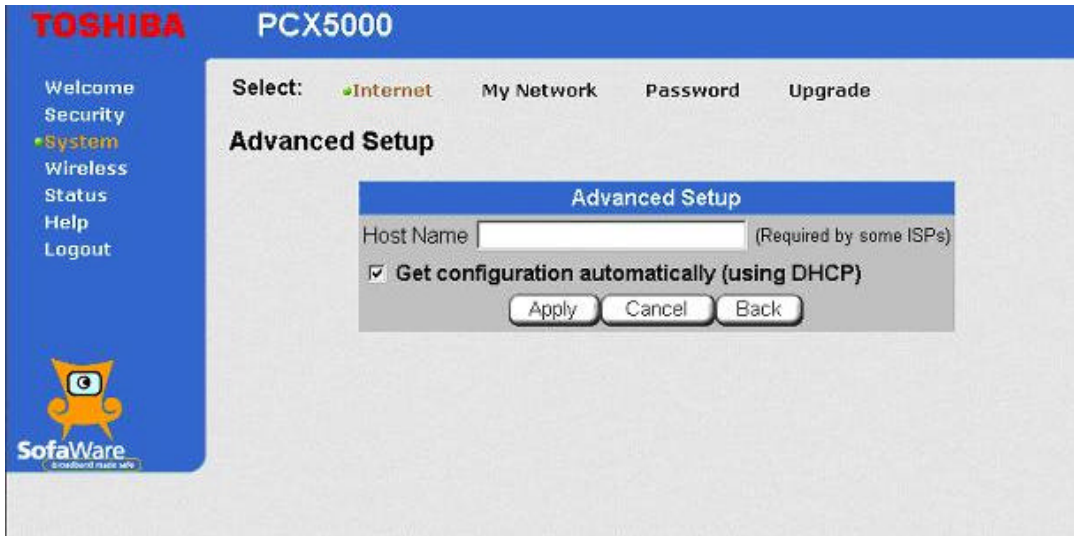

The screenshot shows the Toshiba PCX5000 web interface. The top navigation bar includes 'Welcome', 'Security', 'System', 'Wireless', 'Status', 'Help', and 'Logout'. The 'System' menu is expanded. The main content area is titled 'Advanced Setup' and shows 'Select: Internet My Network Password Upgrade'. A modal window titled 'Advanced Setup' is open, containing a 'Host Name' text box (with '(Required by some ISPs)' to its right), a checked checkbox for 'Get configuration automatically (using DHCP)', and 'Apply', 'Cancel', and 'Back' buttons.

The **Get configuration automatically (using DHCP)** check box should be left checked. When enabled, the PCX5000 will automatically configure its routing settings based on the information provided by the Cable Service Provider.

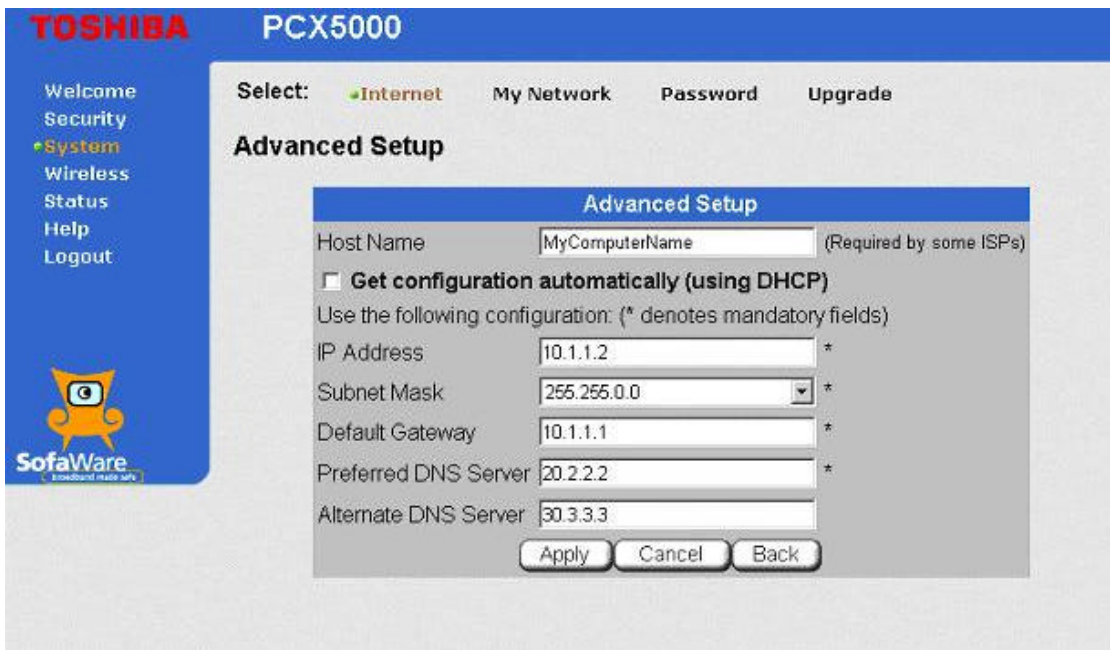

The screenshot shows the Toshiba PCX5000 web interface with the 'Advanced Setup' modal window open. The 'Get configuration automatically (using DHCP)' checkbox is unchecked. Below it, the text reads 'Use the following configuration: (* denotes mandatory fields)'. The fields are: 'IP Address' (10.1.1.2), 'Subnet Mask' (255.255.0.0), 'Default Gateway' (10.1.1.1), 'Preferred DNS Server' (20.2.2.2), and 'Alternate DNS Server' (30.3.3.3). Each field has an asterisk to its right. 'Apply', 'Cancel', and 'Back' buttons are at the bottom.

Some CSP's may require fixed IP addresses for your computer, gateway, and DNS Server(s). In this case, your cable operator will provide you with these addresses and they may be entered on the Advanced Setup page. To access this page, **uncheck** the “**Get configuration automatically (using DHCP)**” box.

Note: You must enter the **IP Address**, **Subnet Mask**, **Default Gateway**, and **Preferred DNS Server** when manually entering the router settings

IP Address – This is the fixed address of the PCX5000 for access to the Internet. Your CSP should supply this address.

Subnet Mask –Your CSP should supply this number.

Default Gateway – The address of the router at your CSP that provides the gateway to the Internet. Your CSP should supply this address.

TOSHIBA

Preferred DNS Server – This is the address of the Domain Name System (DNS) server. The DNS server translates an address name like “yahoo.com” into a numerical address. Your CSP should supply this address.

Alternate DNS Server – This is the address of an alternate DNS server, if available. This optional setting is supplied by your CSP.

After entering this information, make sure to click the “**Apply**” button to activate the changes.

The **Systems/My Network** page is used to assign the IP addresses for your LAN if you are using the DHCP function in the PCX5000. The default setting for the **DHCP server** is “**Enabled**”.

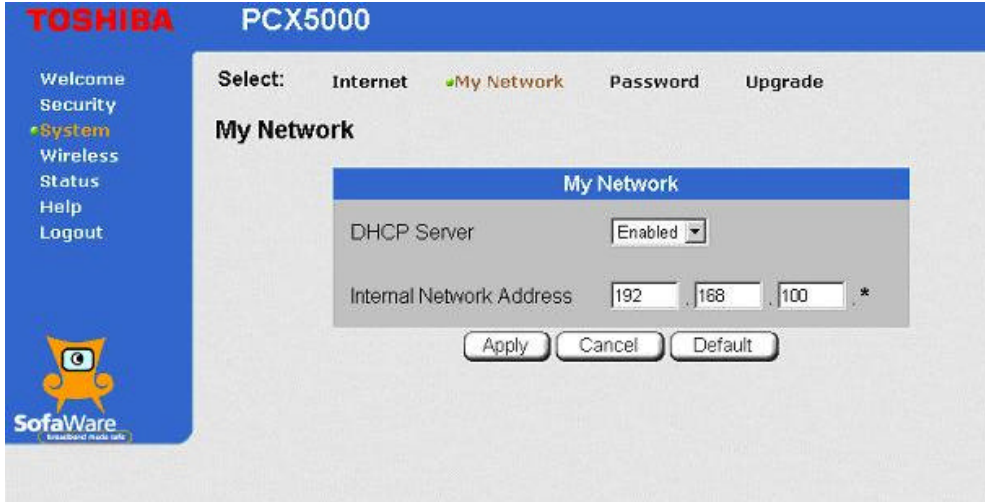

The DHCP server works only when the Firewall/NAT is turned “**On**” as described in the **Security/Firewall** web page. If you already have a DHCP server on your LAN, set the **DHCP server** setting to “**Disabled**”

If you are using a different address with your DHCP server, enter that internal network address in the **My Network** fields.

Note: If you change Internal Network address to ‘xxx.yyy.zzz.*’, the Gateway IP address will always be ‘xxx.yyy.zzz.254’.

Regardless of the Internal Network Address setting, the IP address of PCX5000 configuration Web pages will remain “**192.168.100.1**”.

TOSHIBA

The **System/Password** page is used to change the login password for accessing the PCX5000 configuration Web pages.

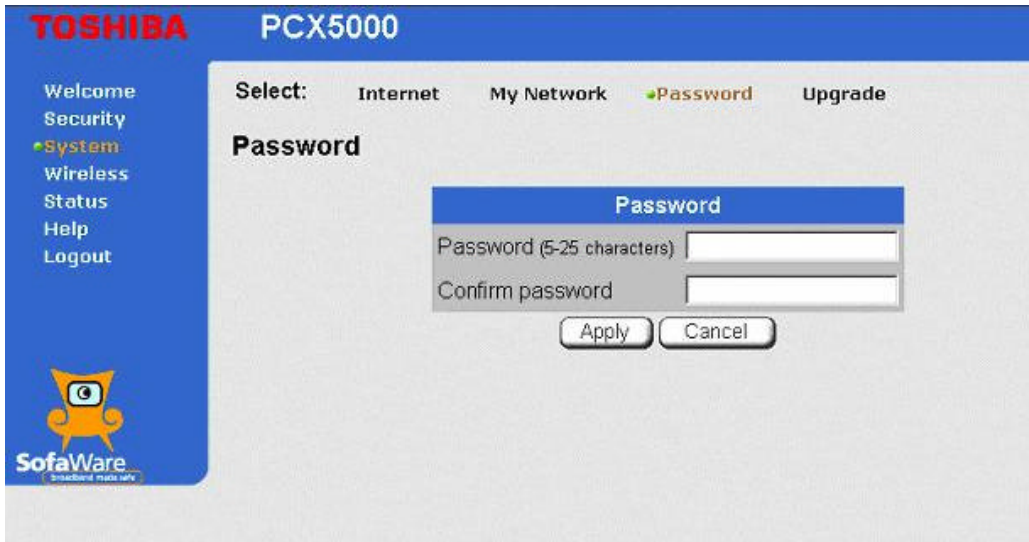

System/Upgrade page is used to upgrade the PCX5000 security features.

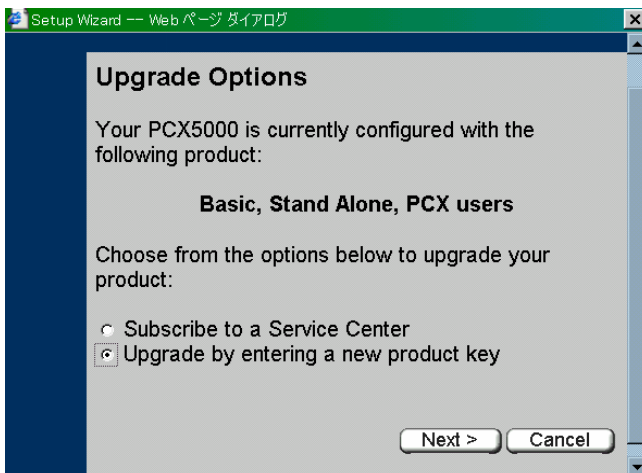
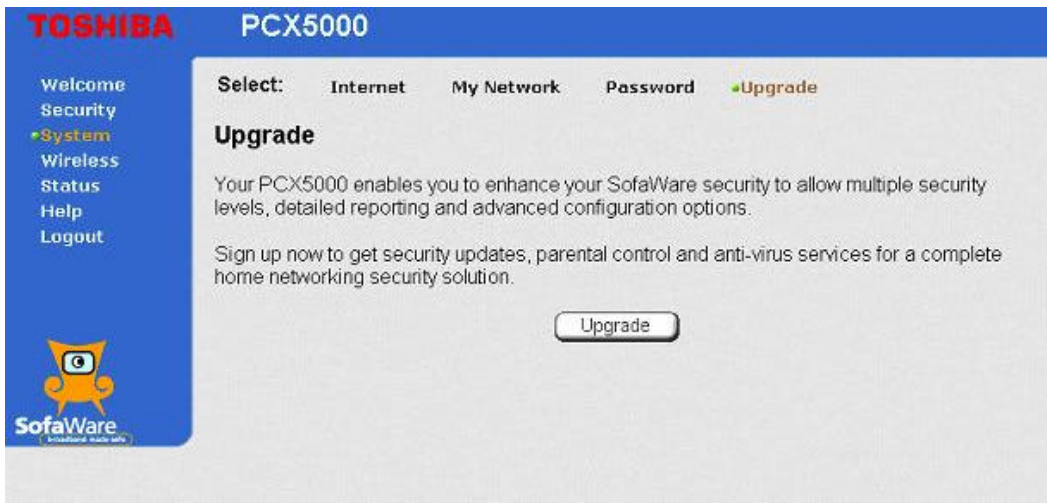

Additional security features are available through the SofaWare upgrade option. Clicking this button will display current upgrade options.

To upgrade your PCX5000,

1. Select the "**Upgrade by entering a new product key**".
2. Click "**Next**".

TOSHIBA



3. Then the new screen appears.
4. Enter your product key that you bought beforehand at the Sofaware Web site.
5. Click "**Next**".

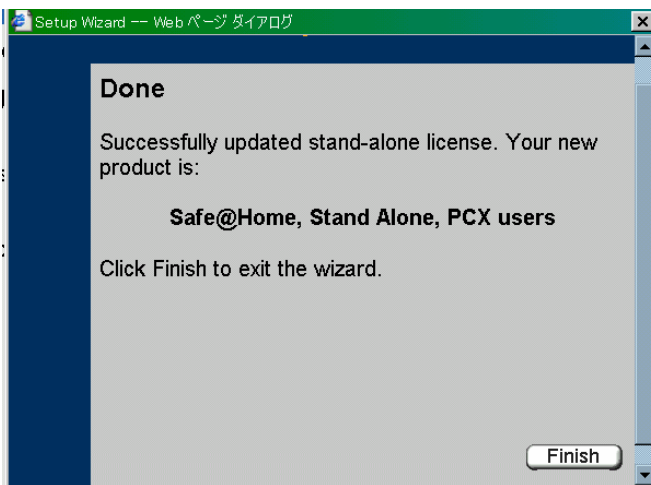

6. Then the new screen appears.
7. Click "**Finish**".

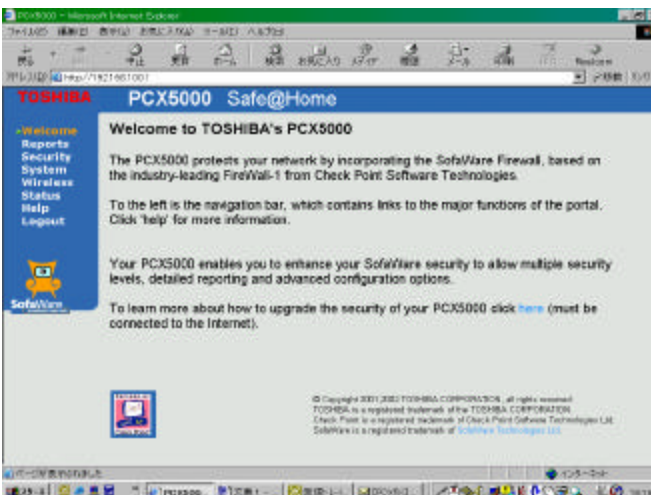

8. The new screen appears.

For more information upgrade options, please access the following Web site:
<http://www.sofaware.com/pcx5000/upgrade>

TOSHIBA

PCX5000 Wireless Configuration

The PCX5000 includes an embedded 802.11b wireless access point to provide wireless connectivity to the Internet. The **Wireless Settings** page is used to set the parameters needed for a wireless network.



Wireless Enabled check box - When checked, the wireless 802.11b network is on. When unchecked, the wireless 802.11b network is off.

Wireless Net Name entry box - Also called the ESSID, the Wireless Net Name is the unique name shared by all devices on the wireless network. All wireless devices on the network **MUST** use the same Wireless Net Name to communicate with each other and the access point. The name can be up to 32 characters long. By default, the PCX5000 uses **“PCX5000”** as the Wireless Net Name.

Exclude Other Nets check box - When checked, the PCX5000 will only recognize wireless devices whose network name exactly matches the one entered into the **Wireless Net Name** entry box. Wireless devices whose network name does not match will not be allowed to connect to the network. When unchecked, the PCX5000 allows wireless devices whose network name matches and wireless devices whose network name is ‘ANY’ to connect. All other network names will be rejected.

Wireless Channel selection box - Selects the wireless channel to use. Valid selections are 1 to 11. The default is 6.

Note: You may change the Wireless Channel number when other wireless devices or access points exist in adjacent area.

Enable Wireless Encryption check box - When unchecked, wireless encryption is disabled. When checked, the PCX5000 will utilize encryption to secure the wireless connection. Enabling wireless encryption will expand the Wireless Settings configuration page.



Important Information!

Leaving the **“Enable Wireless Encryption”** check box unchecked may allow an unauthorized user to gain access to your home network. It is strongly recommended to enable wireless encryption if you are using a wireless access device.

TOSHIBA

When wireless encryption is enabled, the **Wireless Settings** page expands to include encryption options.

The screenshot shows the Toshiba PCX5000 Wireless Settings interface. On the left is a navigation menu with 'Welcome', 'Security System', 'Wireless Status', 'Help', and 'Logout'. The main content area is titled 'Wireless Settings' and contains the following options:

- Wireless Enabled:**
- Wireless Net Name:** PCX5000
- Exclude Other Nets:**
- Wireless Channel:** 6
- Enable Wireless Encryption:**
- Exclude Unencrypted:**
- Key Entry Type:** Choose Option
- Key Entry Mode:** Alpha
- Encryption Keys:** Four input fields labeled 1), 2), 3), and 4).
- Transmit Using Key:** 1

Buttons for 'Apply' and 'Cancel' are located at the bottom of the settings area.

Exclude Unencrypted check box: When checked, only wireless devices with matching encryption keys will be allowed to connect to the PCX5000. When unchecked, wireless devices with matching encryption keys and wireless devices with no encryption will be allowed to connect. It is strongly recommended for security reasons to check this box.

Key Entry Type selection box: Selects the type of encryption to use (64-bit or 128-bit). 128-bit encryptions offers stronger security, but may slow down your connection.

Key Entry Mode selection box: Encryption keys may be entered as alphanumeric characters (select Key Entry Mode “**Alpha**”) or Hexadecimal numbers (use entry mode “**Hex**”).

Encryption Key entry box: The PCX5000 can decrypt up to four separate encryption keys. Enter up to four encryption keys in these entry boxes. Typically, only one key is used. This key may be entered into any entry box.

Transmit Using Key selection box: Select the encryption key to use when transmitting.



Important Information!

When you are using the encryption options, you will not make a wireless connection if the encryption keys for the computer’s wireless access card and the PCX5000 do not exactly match.



Important Information!

When an Encryption Key of PC corresponds with one of 4 Encryption Keys of PCX5000, PC can access PCX5000.

TOSHIBA

The **Status** page summarizes basic information useful for installation and diagnostics.

Cable Modem Information:	Status
Cable Modem Information:	Toshiba Toshiba PCX5000 HW 7.31 SW 1.7.021SV-01
RF MAC Address:	00:90:83:80:23:3b
USB MAC Address:	00:90:83:80:23:3a
LAN MAC Address:	00:90:83:7e:ed:c3
802.11b MAC Address:	00:02:2d:4e:b1:64
Serial Number:	6208397627
Operational Status:	Operational
Uptime:	0d 0h 2m 19s
Last Status - prior reboot:	Not available
Power Level:	
Received: 0.2 dBmV	Transmitted: 30.0 dBmV
Received SNR:	37.4 dB
Frequency:	
Downstream: 117.00 MHz	Upstream: 40.00 MHz

PCX5000 Information

RF MAC Address

USB MAC Address

LAN MAC Address

802.11b MAC Address

Serial Number

Operational Status

Uptime

Last Status - prior reboot

Power Level Received

Power Level Transmitted

Received SNR

Frequency Downstream

Frequency Upstream

- Hardware and software version information
- MAC address of the RF interface
- MAC address for the USB interface
- MAC address used for router functions
- MAC address of the 802.11b wireless interface
- The serial number of the unit
- The current status of the PCX5000
- The time since the last PCX5000 reset
- The status of the PCX5000 prior to the last reboot
- The power of the downstream signal in dBmV
- The power of the upstream signal in dBmV
- The signal-to-noise ratio of the downstream signal in dB
- The frequency of the downstream signal
- The frequency of the upstream signal

TOSHIBA

SofaWare Advanced Security Features

This section explains the extended security capabilities available through the SofaWare upgrade. You may purchase this upgrade by clicking on the link in the PCX5000 Welcome page or visiting the site: <http://www.SofaWare.com/pcx5000/upgrade>.

After entering the upgrade key set, you should see this **Welcome** page. Note the “**Safe@Home**” title in the banner indicating you are running the upgraded security software.

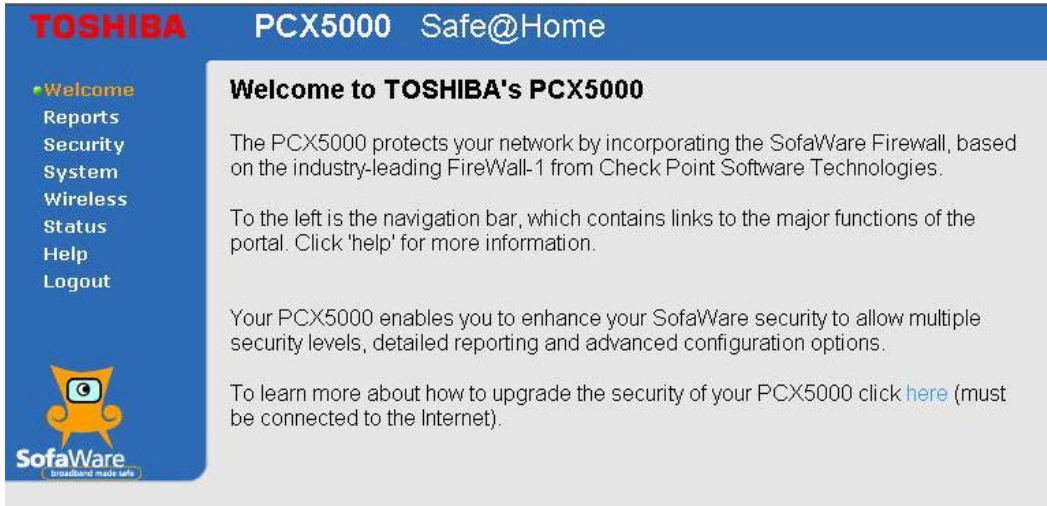

Advanced capabilities provided by the SofaWare security upgrade include:

- Enhanced security reporting and diagnostics for your home network
- High, medium and low settings for firewall security
- Simplified specification of ports and protocols needed by applications such as mail, ftp and http servers that you may host at home

Reports Pages

The reports pages are a set of screens that display a history of events concerning your home network (**Event Log**), a list of computers active on the home network (**Active Computers**), and current connections between the computers and the Internet (**Active Connections**).

The **Event Log** lists activities monitored by the PCX5000, including startup, connections made by your computers, blocked connections, and attempts made by external users who may be trying to break into your network.

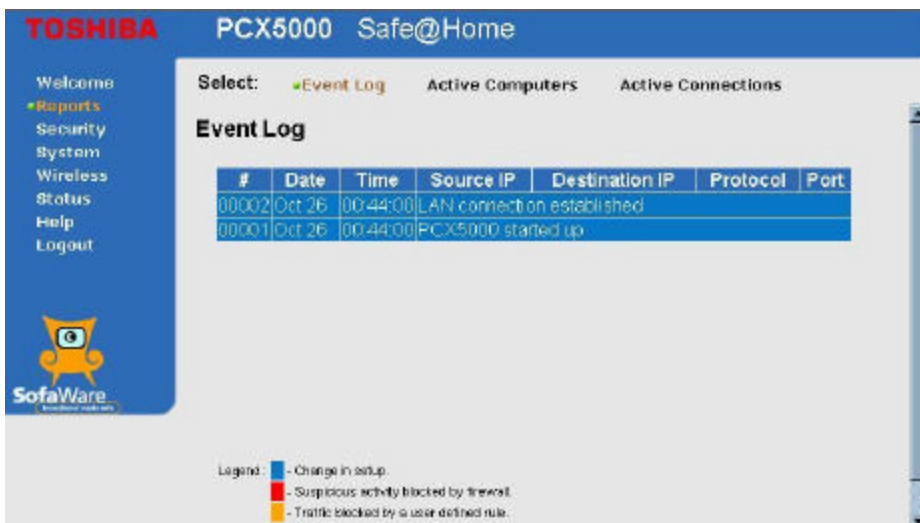

TOSHIBA

The **Active Computers** page lists all computers on your home network that have been recognized by the PCX5000 and are allowed to access the internet.

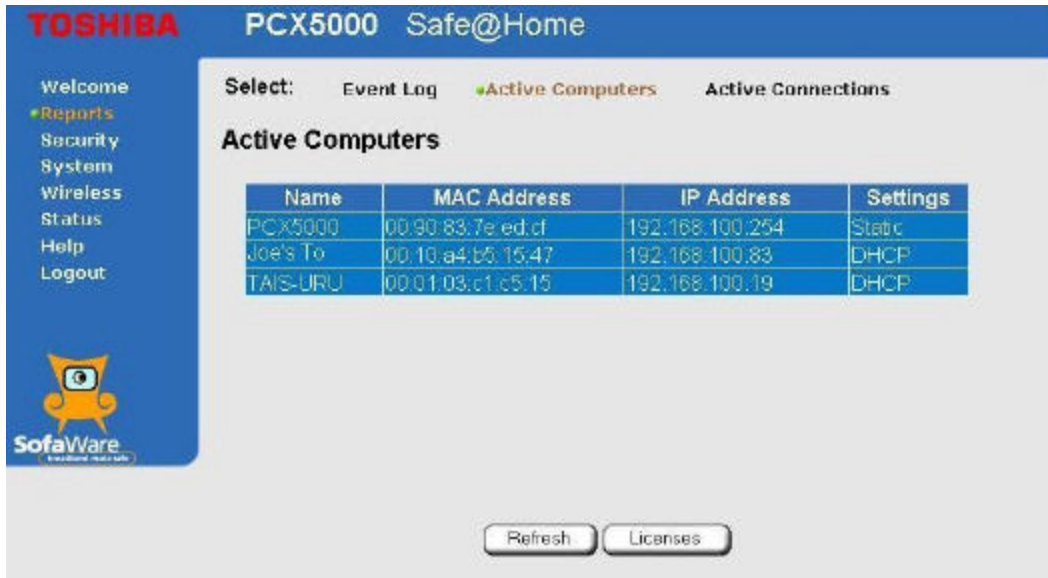

The screenshot shows the Toshiba PCX5000 Safe@Home web interface. The top navigation bar includes the Toshiba logo, the model name 'PCX5000', and the 'Safe@Home' branding. A left-hand menu contains links for 'Welcome', 'Reports', 'Security System', 'Wireless Status', 'Help', and 'Logout'. The main content area features a 'Select:' menu with options for 'Event Log', 'Active Computers' (which is selected), and 'Active Connections'. Below this is a table titled 'Active Computers' with the following data:

Name	MAC Address	IP Address	Settings
PCX5000	00:90:83:7e:ed:c1	192.168.100.254	Static
Joe's To	00:10:a4:b5:15:47	192.168.100.83	DHCP
TAIS-URU	00:01:03:c1:c5:15	192.168.100.19	DHCP

At the bottom of the interface, there are two buttons: 'Refresh' and 'Licenses'.



The screenshot shows a 'License Information' dialog box with the following data:

License Information	
Total Licensed Computers	5
Used Licenses	2

A 'Close' button is located at the bottom of the dialog box.

Pressing the **'Licenses'** button will list the number of licensed users authorized with the SofaWare Safe@Home upgrade.

TOSHIBA

The **Active Connections** page displays all active sessions between your home network and the Internet. Information displayed includes the IP addresses of active computers, the IP addresses of the sites they are connected with, ports used for the connection, and the protocols.

TOSHIBA PCX5000 Safe@Home

Welcome

- Reports
- Security
- System
- Wireless
- Status
- Help
- Logout

Select: Event Log Active Computers **Active Connections**

Active Connections

This page shows the currently opened connections between your network and the outside world.

Source IP	Destination IP	Port	Protocol
192.168.100.19 (TAIS-URU)	64.58.190.146	53 (DNS)	UDP
192.168.100.19 (TAIS-URU)	64.12.147.57	80 (HTTP)	TCP
192.168.100.19 (TAIS-URU)	64.236.16.137	80 (HTTP)	TCP
192.168.100.19 (TAIS-URU)	205.188.165.121	80 (HTTP)	TCP
192.168.100.33	64.58.191.9	53 (DNS)	UDP
192.168.100.33	192.175.48.1	53 (DNS)	UDP
192.168.100.33	159.119.100.13	38293	UDP
192.168.100.33	64.58.190.146	53 (DNS)	UDP

Done Internet

WHOIS information dialog:

The **Destination IP** address on 'Active Connection' is linked to **WHOIS** dialog. You can confirm who owns the IP address which you accessed on this dialog. This information is not provided by PCX5000, and is furnished without responsibility for accuracy.

WHOIS Resolve Entry for 192.160.73.62	
OrgName	Cable Television Laboratories, Inc.
OrgID	CTL-12
NetRange	192.160.73.0 - 192.160.73.255
CIDR	192.160.73.0/24
Network Name	CABLELABS
NetHandle	NET-192-160-73-0-1
Parent	NET-192-0-0-0-0
NetType	Direct Assignment
NameServer	ONDAR.CABLELABS.COM DMTU.MT.NS.ELS-GMS.ATT.NET KAIGAL.CABLELABS.COM
Comment	
RegDate	1992-05-14
Updated	2001-03-15
TechHandle	ID1-ARIN

TOSHIBA

The enhanced **Security** pages enable additional flexibility in configuring the firewall. The first page displayed, **Fire wall**, provides for three levels of security (Low, Medium and High). The default setting is "Medium" security.

- | | |
|--------|---|
| Low | All outbound traffic is allowed
All inbound traffic is blocked except for ICMP echo's ("ping") |
| Medium | All outbound traffic is allowed except for Windows file sharing (NBT ports 137, 138, 139 and 445).
All inbound traffic is blocked. |
| High | Restrictions apply to outbound traffic, allowing only Web traffic (HTTP, HTTPS), Email (IMAP, POP3, SMTP), FTP, NNTP, Telnet, DNS, IKE, 2746 UDP and 256 TCP traffic out. All inbound traffic is blocked. |

The screenshot shows a web browser window titled "PCX5000 - Microsoft Internet Explorer" with the address bar showing "http://192.168.100.1/index.html". The page content includes the Toshiba logo, "PCX5000 Safe@Home", and a navigation menu on the left. The main content area is titled "Firewall" and shows the status "Firewall On" with "Firewall is enabled" and "High security" selected. The "High security" option is described as "Enforces strict control on all incoming and outgoing connections." Below this, there is a paragraph of text and a "Show me more" button.



Important Information!

When you turn on/off the firewall, you need to power off and on PCX5000 and reboot your PC after PCX5000 starts.

TOSHIBA

The **Virtual Servers** page allows you to specify computers on your home network to serve as web, ftp, mail or other servers. You need not know the port numbers needed for each service.

The screenshot shows the PCX5000 web interface in Microsoft Internet Explorer. The browser title is "PCX5000 - Microsoft Internet Explorer" and the address bar shows "http://192.168.100.1/index.html". The page header includes the Toshiba logo and "PCX5000 Safe@Home". A navigation menu on the left lists: Welcome, Reports, Security (highlighted), System, Wireless, Status, Help, and Logout. Below the menu is the SofaWare logo with the tagline "broadband made safe".

The main content area has a "Select:" menu with options: Firewall, Servers (selected), Allow, Block, and DMZ. The title "Virtual Servers" is displayed. Below the title is a descriptive paragraph: "This page enables you to selectively allow incoming network traffic of several known applications and Internet services into your home. For more information refer to the help pages."

#	Allow	Category	Application Name	Host IP
1	<input type="checkbox"/>	Applications	Web Server	<input type="text"/> This Computer <input type="button" value="Clear"/>
2	<input type="checkbox"/>	Applications	FTP	<input type="text"/> This Computer <input type="button" value="Clear"/>
3	<input type="checkbox"/>	Applications	Telnet	<input type="text"/> This Computer <input type="button" value="Clear"/>
4	<input type="checkbox"/>	Applications	POP3	<input type="text"/> This Computer <input type="button" value="Clear"/>
5	<input type="checkbox"/>	Applications	SMTP	<input type="text"/> This Computer <input type="button" value="Clear"/>

At the bottom of the table are "Apply" and "Cancel" buttons.

The remaining configuration pages operate in the same manner as the standard version of the PCX5000 software.

TOSHIBA

The **Allow/Block** Rules provide you with greater flexibility in defining and customizing your security policy. You can allow additional inbound services which are not on the '**Virtual Servers**' list, or block outbound communications for specific port ranges.

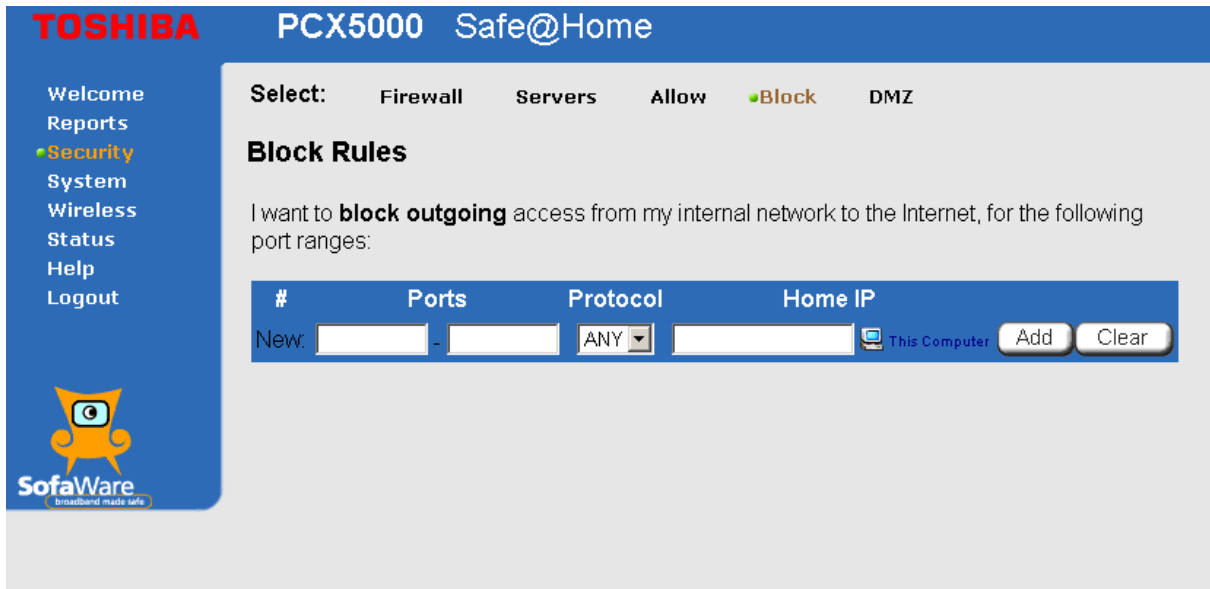

The screenshot shows the Toshiba PCX5000 Safe@Home web interface. The top navigation bar includes the Toshiba logo, the model name 'PCX5000', and the service name 'Safe@Home'. A left-hand menu contains links for 'Welcome', 'Reports', 'Security' (highlighted), 'System', 'Wireless', 'Status', 'Help', and 'Logout'. Below the menu is the SofaWare logo with the tagline 'broadband made safe'. The main content area has a 'Select:' menu with options: 'Firewall', 'Servers', 'Allow', 'Block' (selected), and 'DMZ'. The page title is 'Block Rules'. A text box contains the instruction: 'I want to **block outgoing** access from my internal network to the Internet, for the following port ranges:'. Below this is a table with columns: '#', 'Ports', 'Protocol', and 'Home IP'. A 'New:' row contains input fields for port ranges, a protocol dropdown menu set to 'ANY', and a 'Home IP' field with a 'This Computer' icon. 'Add' and 'Clear' buttons are located to the right of the 'Home IP' field.

If you wish to permit incoming access from the Internet to your internal network for specific port ranges, you must create a new '**Allow**' rule. If you wish to block outgoing access from your internal network to the Internet for specific port ranges, you must create a new '**Block**' rule.

TOSHIBA

Appendix

Frequently Asked Questions

Q: I have forgotten my password. What should I do?

A: Reset your PCX5000 to factory defaults using the Reset button. The Reset button is located behind the PCX5000 and should be pressed until the device reboots (in about 10 seconds). Note that all the configuration information you entered previously will have to be re-entered.

Q: Where can I download the driver for my PCX5000?

A: If you are only using the 10/100 Ethernet interface to connect your computers to the PCX5000, there is no special driver needed on the computers.

If you are using the USB interface to connect a computer to the PCX5000, you must install the PCX5000 USB Driver for Microsoft Windows 98SE, 2000, Me or XP. Drivers for each of these operating systems are included in the CD-ROM packaged with this product.

You may download new versions of the USB drivers through the support web site:

<http://www.toshiba.com/taisnpd/support/downloads.html>

Q: Do I need to turn off the PCX5000?

A: No, you can leave PCX5000 powered up, however, you should power down the PCX5000 and your computers during an electrical (lightning) storm.

Q: How do I share my Internet connection between several PCs?

A: Simply connect your computers to the PCX5000 and set “**assign IP address automatically**” in each of the computer’s local network settings. The PCX5000 runs a “**DHCP server**” that will automatically assign unique IP addresses to all your computers and allow them to connect to the Internet at the same time.

Q: Can I change the internal IP address range of my PCX5000?

A: Yes, you may change the internal subnet range. When doing so, the gateway IP address will change automatically to be the last address on your new subnet. For example, if you change your subnet range to **10.0.10.x**, the internal IP address of the gateway will automatically change to **10.0.10.254**.

Please refer to the “Configuring the PCX5000 Gateway” section of the manual.

Note: The IP address of the PCX5000 web configuration page does not change. It is fixed at **192.168.100.1**.

Q: How do I configure a PC with a static IP address?

A: To configure a PC with a static IP address, use the upper IP range (x.x.x.128-x.x.x.253) reserved for that purpose. The PCX5000 will not dynamically assign any other PC with these IP addresses.

Remember to set the subnet mask (255.255.255.0), gateway IP (default is 192.168.100.254) and DNS addresses as provided by your service provider.

TOSHIBA

Q: Can I dial into my home network using the PCX5000?

A: No, the PCX5000 does not have the capability to dial and connect via the telephone network.

Q: Can I dial into my company's VPN using the PCX5000?

A: No, the PCX5000 does not have the capability to dial and connect via the telephone network. However, once connected to the Internet via the CATV network, the PCX5000 does support VPN pass through allowing the VPN software in your PC be used to direct connect your PC to your company's VPN via the Internet.

Q: How do I use the PCX5000 with an existing router?

A: You may use the PCX5000 in bridge mode. The PCX5000 will operate solely as a cable modem and route all traffic to an external router. See **"What is bridge mode?"**

Q: Does the PCX5000 support IPX or AppleTalk?

A: No, the PCX5000 only supports the TCP/IP protocol with Apple products.

Q: Can I use a non-Windows PC or PDA to connect with the PCX5000?

A: Yes, as long as that device supports the TCP/IP protocol.

Q: What is unique about the PCX5000 Internet security solution?

A: Most cable and DSL routers implement only Network Address Translation (NAT), rather than full-fledged Stateful Inspection firewall protection. The PCX5000 uses SofaWare technology, based on Check Point Software Technologies' enterprise-strength firewall. Running this advanced firewall enables the PCX5000 to:

- Enforce a strict security policy on all inbound and outbound Internet traffic, allowing into the network all authorized traffic and only that.
- Support numerous common consumer applications and protocols.
- Protect from denial of service attacks.
- Log intrusion attempts.

Q: What is the security policy enforced by the PCX5000 firewall?

A: The default security policy of the PCX5000 firewall blocks all traffic initiated from the outside of your home network, and allows all outgoing traffic initiated from your home computers except for NetBIOS (Microsoft file and printer sharing protocol).

The advanced security version from SofaWare supports these preset security levels:

Low	All outbound traffic is allowed All inbound traffic is blocked except for ICMP echo's ("ping")
Medium	All outbound traffic is allowed except for Windows file sharing (NBT ports 137, 138, 139 and 445). All inbound traffic is blocked.
High	Restrictions apply to outbound traffic, allowing only Web traffic (HTTP, HTTPS), Email (IMAP, POP3, SMTP), FTP, NNTP, Telnet, DNS, IKE, 2746 UDP and 256 TCP traffic out. All inbound traffic is blocked.

Note: The default policy of the standard product is "Medium".

TOSHIBA

Q: What do I need to do in order to host a web or mail server behind the PCX5000?

A: To enable remote access to a web server behind the cable modem, you will need to open the firewall for incoming web traffic with these instructions.

1. Open the PCX5000 configuration page at <http://192.168.100.1/>
2. In the left hand menu, click on "**Security**".
3. In the top menu, click on "**Allow**".
4. In the "**Ports**" text box, type "**80**".
5. From the "**Protocol**" dropdown menu, choose "**TCP**".
6. In the "**Home IP**" text box, type the IP address for the computer you will use for your web server.
7. Repeat the process using port number "**25**", "**SMTP**" for the protocol, and entering the IP address for your mail server.
8. Click "**Add**" to apply the allow rules created.

Using the advanced security upgrade from SofaWare, the following procedure should be used:

1. Open the PCX5000 configuration page at <http://192.168.100.1/>
2. In the left hand menu, click on "**Security**".
3. In the top menu, click on "**Servers**".
4. Check the "**Allow**" checkbox for the Web Server application.
5. In the "**Home IP**" text box, type the IP address for the computer you will use for your web server.
6. Click "**Add**" to apply the allow rules created.

Internet users will need to connect to your web server through the external IP address of the cable modem, assigned by your cable provider. You will need to register a domain name with your provider to make it easy for external users to find your site – otherwise, they will need to use an IP address.

Q: How is the configuration and management performed for the PCX5000?

A: The PCX5000 is managed locally from its Web-based interface or centrally by the service provider.

Q: What additional subscription services are available for my PCX5000?

A: Select cable service providers may offer add-on subscription security services options that include:

- Enhanced Firewall security services such as proactive security policy updates that keep your firewall up-to-date against the latest attacks.
- Parental control services that block access to objectionable Web sites.
- Email anti-virus services that scan email attachments before they are downloaded to your mailbox.

Q: How do I upgrade my PCX5000?

A: To upgrade your PCX5000, you will need to purchase an upgrade from <http://www.sofaware.com/pcx5000/upgrade/>

After you have completed the purchase process and have a product key, proceed with the following steps:

1. Open the PCX5000 configuration page at <http://192.168.100.1/>
2. In the left hand menu click on "**System**"
3. In the top menu click on "**Upgrade**"
4. Click on the "**Upgrade**" button
5. Choose the upgrade option "**Upgrade by entering a new product key**"
6. Enter your product key

After completing these steps, you should notice that the user interface includes the new features of the upgrade such as multiple security policies and detailed reporting.

TOSHIBA

Q: How will I be notified of new firmware upgrades?

A: Your cable operator will automatically apply firmware updates.

Q: What is router mode?

A: Router mode allows all of your computers to share a single IP address. This single shared IP address (WAN IP) is provided by your CSP. The PCX5000 will dynamically assign local addresses to all of your computers and enable them to share your connection. In router mode, the PCX5000 implements a Stateful Inspection Firewall to protect all of your computers from unauthorized access from the Internet. The PCX5000 is shipped with router mode enabled.

Q: What is bridge mode?

A: Bridge mode disables the sharing of single IP address. Each of your computers will need to obtain a unique IP address from your CSP. Contact your CSP to find out how to obtain additional IP addresses for multiple computers. In bridge mode, the PCX5000 disables the Stateful Inspection Firewall thus allowing all data from your computers to flow freely to/from the Internet. The PCX5000 is shipped with bridge mode disabled.

Q: What should I do if the PCX5000 configuration pages are not displayed properly?

A: Follow these steps:

1. Make sure you are using browser versions IE 5.0 or Netscape 4.5 or later.
2. If you are using Internet Explorer, click on "Tools" menu, and then "Internet Options". In the "General" menu, under "Temporary Internet files", click on the "Settings" button. In the Settings menu, click on the "Automatically" option under "Check for new versions of stored pages".

Q: What should I do if I cannot access the PCX5000 configuration pages?

A: Follow these steps:

1. Make sure the PCX5000 modem is turned on.
2. Make sure your PCX5000 is properly connected to the networked computers.
3. If you have more than one PC connected, try accessing to the PCX5000 pages from a different PC. If you succeed, check your original PC's connections and network settings.
4. Turn off the PCX5000 and turn it on again after 10 seconds.
5. Type the PCX5000 IP address in the browsers' "Open Location" address bar. The default IP address is 192.168.100.1.
6. Check your browser settings for any Proxy server settings and disable them.
7. Check your operating system network settings. Make sure no static IP addresses are defined.

TOSHIBA

LED Diagnostics

The PCX5000 has 13 status LEDs. The purpose of each LED (left to right) is detailed in the following table:

Function	Color	Definition
POWER	Green	<ul style="list-style-type: none"> ▪ dark for power off ▪ bright for power on
CABLE	Green	<ul style="list-style-type: none"> ▪ dark for no downstream RF carrier present or power off ▪ flashing slowly (approximately every second) for downstream RF carrier present and ranging in progress ▪ flashing fast (approximately 0.1 seconds) for registration in progress ▪ on for the PCX5000 registered and ready to transfer data
TEST	Amber	<ul style="list-style-type: none"> ▪ dark for initial self-test of the PCX5000 OK or power off ▪ flashing for initial self-test of the PCX5000 in progress or software down loading of the PCX5000 in progress ▪ on for self-test failure of the PCX5000
USB	Green	<ul style="list-style-type: none"> ▪ dark for no USB link has been detected ▪ on for USB link and no activity ▪ flashing for user data going through USB Interface
WLAN	Green	<ul style="list-style-type: none"> ▪ dark for no WLAN link has been detected ▪ flashing for user data going through WLAN
10/100 Mbps [1-4]	Green	<ul style="list-style-type: none"> ▪ dark for 10Base-T connection ▪ on for 100Base-T connection
Link/Act [1-4]	Green	<ul style="list-style-type: none"> ▪ dark for no carrier to/from computer present or power off ▪ on for carrier to/from computer present ▪ flashing for user data going through Ethernet

TOSHIBA

Specifications

Model Name		PCX5000
Model Number		DAZ8850F
Compliant Standard		DOCSIS 1.0 (1.1Based)
Interface	Computer Interface	10/100Base-T (10/100Mbps, full/half-duplex, auto-sensing) 4 port; USB Device (12Mbps, full speed mode) 1 port
	Wireless Interface	IEEE 802.11b
	Cable Interface	F type female 75ohm
Receiver	Demodulation	64/256QAM
	Physical Speed	30Mbps (64QAM) /43Mbps (256QAM)
	Frequency Range	88MHz to 860MHz (edge to edge)
	Bandwidth	6MHz
	Input Signal Level	-15dBmV to +15dBmV (Automatically Gain Controlled by CM)
Transmitter	Modulation	QPSK / 16QAM
	Physical Speed	320, 640, 1280, 2560, 5120kpbs (QPSK) 640, 1280, 2560, 5120, 10240kps (16QAM)
	Frequency Range	5 to 42MHz (edge to edge)
	Bandwidth	0.2, 0.4, 0.8, 1.6, 3.2MHz
	Output Signal Level	+8dBmV to +58dBmV (QPSK) +8dBmV to +55dBmV (16QAM) (Output signal level of CM is automatically controlled by CMTS through power ranging function) Step: 1dB
Max. Number of CPEs		NAT-ON: 252 NAT-OFF: 31 (31 MAC address)
Filtering	MAC Address	1 to 31 (set by MIB)
	LLC	16
	IP	32
DHCP Server	Subnet / Mask	192.168.100.xx / 255.255.255.0 (factory default)
	Lease Address Range	192.168.100.2 to 192.168.100.127 (factory default)
	Reserved Addresses	192.168.100.128 to 192.168.100.253 (factory default)
Gateway Address		192.168.100.254 (factory default)
HTTP Web Server	LAN-Side Address	192.168.100.1
Frequency Search	Frequency Cache	4 entries
	Channel Plan	Supports 3 North American Channel Plan (STD, IRC, HRC)
Safety		UL1950, UL1310 (AC-DC adapter)
EMC		FCC Part 15 class B
Power Supply	AC-DC Adapter	100-120V±10%, 50/60Hz (Note: AC Adapter itself is 100-240V, but AC cord is 120V)
	Internal Power Supply	DC 5V 2.4A (change connector)
	Consumption	10 Watts (approximately)
OSS	Protocol	SNMP/ICMP
	MIB	MIB II / MCNS MIB / Toshiba MIB
Environment	Operating temperature	32°F (0°C) to 104°F (40°C)
	Operating humidity	10% to 90%(Non condensing)
	Storage temperature	-4°F (-20°C) to 140°F (60°C)
Orientation		Horizontal and wall mounting
Reset switch		Reset to factory default
LED		POWER, CABLE, TEST, USB, WLAN, 10/100Mbps[1-4], LINK/ACT[1-4]
Dimensions (without A C-DC Adapter)		8.5" x 8".8 x 1.7" (WxDxH) unit: inch
Weight		2.1lbs. (approximately)

TOSHIBA

Regulatory

FCC Notice:

This equipment has been tested and found to comply with the limits for a Class B personal computer and peripherals, pursuant to Part 15 of the FCC Rules. These limits are designed to provide reasonable protection against harmful interference in a residential installation. This equipment generates, uses and can radiate radio frequency energy and, if not installed and used in accordance with the instructions, may cause harmful interference to radio communications. However, there is no guarantee that interference will not occur in a particular installation. If this unit does cause harmful interference to radio or television reception, which can be determined by turning the equipment off and on, the user is encouraged to try to correct the interference by one or more of the following measures:

- Reorient or relocate the receiving antenna.
- Increase the separation between the equipment and receiver.
- Connect the equipment into an outlet on a circuit different from that to which the receiver is connected.
- Consult the dealer or experienced radio/TV technician for help.

TOSHIBA

Glossary

10/100BaseT(10/100 Ethernet)

Unshielded, twisted pair cable with an RJ-45 connector, used with Ethernet LAN. "10/100" indicates dual speed (10 Mbps or 100 Mbps), "Base" refers to baseband technology, and "T" means twisted pair cable.

Cable TV Coax

Cable that allows wide bandwidth transmission over long distances. Coaxial cable (coax) comprises an inner conductor surrounded by insulation. An outer conductor wraps around the insulation, which, in turn, is covered by an outer plastic covering.

DHCP

Any machine requires a unique IP address to connect to the internet using Internet Protocol. Dynamic Host Configuration Protocol (DHCP) is a communications protocol that assigns Internet Protocol (IP) addresses to computers on the network. DHCP uses the concept of a "lease" or amount of time that a given IP address will be valid for a computer.

DMZ

A DMZ (demilitarized zone) allows one computer to be exposed to the Internet. An example of using a DMZ would be exposing a public server, while preventing outside users from getting direct access from this server back to the private network.

Domain Name System (DNS)

The Domain Name System (DNS) refers to the internet domain names, or easy-to-remember "handles", that are translated into IP addresses. An example of a Domain Name is 'www.toshiba.com'.

Ethernet card

A plug-in circuit board installed in an expansion slot of a personal computer. The Ethernet card (sometimes called a Network Interface Card, or NIC) takes parallel data from the computer, converts it to serial data, puts it into a packet format, and sends it over the 10/100 LAN cable.

F connector

A type of coaxial connector, labeled RF on the rear of the Toshiba PCX5000 that connects the modem to the cable system.

Firewall

A program or a set of related programs, located on a network gateway server protecting your private network resources from users (and abusers) on the Internet. A firewall inspects each packet to determine whether it complies with the security policy and blocks illegal traffic. Packets do not enter the home network unless they comply with the security policy.

Gateway

A gateway is a network point that acts as an entrance to another network.

Headend

The equipment, in the central office of the service provider, where the cable signals originate.

Hybrid Fiber/ Coaxial (HFC) system

A system where the trunk of the cable plant is fiber technology. Somewhere near the subscriber's home, the fiber is connected to a coaxial cable, and the signal is converted so that it is compatible with the fiber media. The coaxial cable then runs through the branches of the network and is finally dropped into the home.

HUB

A device used to connect multiple computers to the PCX5000.

Internet

A collection of interconnected networks used for worldwide computer-based communications.

IP Address

A unique, 32-bit address assigned to every device in a network. An IP (Internet Protocol) address has two parts: 1) a network address and 2) a host address. Each network is assigned an address by a government agency, and each company administrator assigns an address to each host computer.

TOSHIBA

MAC Address

The MAC (Media Access Control) address is a computer's unique hardware number. When connected to the Internet from your computer, a mapping relates your IP address to your computer's physical (MAC) address on the LAN.

Modem registration

The process the Toshiba PCX5000 uses to make itself known to the headend equipment. Once authorized by the router, the modem is assigned upstream and downstream channels for data communication.

NAT

Network Address Translation (NAT) is the translation or mapping of an IP address to a different IP address. NAT is used to map several internal IP addresses to a single IP address, thereby sharing a single IP address assigned by the CSP among several computers. Stateful Inspection Network Address Translation (NAT) implementation supports hundreds of pre-defined applications, and protocols.

Network driver

A (software) file included with the Ethernet card. The file is loaded on the computer to allow the computer to recognize the Ethernet card. See Ethernet Card.

RJ-45

Connector on the Toshiba PCX5000, labeled 10/100 that connects the modem to a computer or to a HUB.

Subscriber

A computer user in the home who accesses a data service using the Toshiba PCX5000.

Subnet

A network subdivision. When subnetting is used, the IP (Internet Protocol) address is divided into a subnet number and a host number. Hosts and gateways identify the bits used for the network and subnet number using a subnet mask.

TCP/IP communication stack

Software in the subscriber computer that processes packets through the communication layers. The subscriber configures the IP address for the computer and the router default gateway in the software. The TCP/IP communication stack handles all the communications with the subscriber's application.

URL

A URL (Uniform Resource Locator) is the address of a file (resource) accessible on the Internet. The type of resource depends on the Internet application protocol. On the Web (which uses the Hypertext Transfer Protocol), an example of a URL is 'http://www.toshiba.com'.

USB

Universal Serial Bus, standardized for easy connections between the computer and the other peripherals. USB connects more than computers and peripherals.

WEP

WEP is Wired Equivalent Privacy, based on the use of 64-bit or 128-bit keys and the popular RC4 encryption algorithm as described in the IEEE802.11 standard. Wireless devices without a valid WEP key will be excluded from network traffic.

TOSHIBA

STANDARD LIMITED WARRANTY

TOSHIBA AMERICA INFORMATION SYSTEMS, INC. NETWORK PRODUCTS DIVISION FOR THE UNITED STATES AND CANADA

What are the terms and duration of this Limited Warranty?

Toshiba America Information Systems, Inc. ("TAIS") warrants to the first end-user customer that this Toshiba DOCSIS PCX5000 ("Product") will substantially comply with manufacturer's published specifications under normal use for a period of three (3) years from date of purchase when purchased new from TAIS or a TAIS authorized reseller in the United States of America or Canada. After three (3) years, this Limited Warranty shall be void.

If this Product fails to perform as warranted during the warranty period, TAIS will at its option repair or replace the Product at no expense to you, except as provided below. During the warranty period, TAIS will repair or replace defective Product or parts with new or reconditioned Product or parts at its option. All repair or replacement of the Product must be performed by TAIS or a TAIS Authorized Service Provider. Reconditioned Product or parts will be equal in performance to the original Product or parts. All original Products or parts replaced by TAIS become property of TAIS. Any replaced or repaired Product or part is warranted under the same terms as this Limited Warranty for a period of ninety (90) days after the date of repair or replacement, or for the remainder of the initial warranty period, whichever is longer.

What is not covered by this Limited Warranty?

This Limited Warranty DOES NOT INCLUDE repair or replacement to correct any damage caused by improper installation or maintenance, improper connection with any device, external electrical fault, accident, disaster, misuse, abuse, modification to the Product not approved in writing by TAIS, service other than by TAIS or a TAIS Authorized Service Provider, or any other cause outside normal usage parameters. TAIS shall not be responsible for damage to or loss of any programs or data, or the costs of recovering such programs or data. This Limited Warranty is valid only in the United States and Canada. You are responsible for payment, at current rates, for any repair or replacement not covered under this Limited Warranty.

How do I obtain warranty service?

In order to receive warranty service, you must contact TAIS at the number below within thirty (30) days after discovering that the Product does not comply with its specifications.

Product proof of purchase may be required in order to validate warranty eligibility. If the Product requires service, you will be given a return authorization number and instructions for shipping the Product to TAIS or the location of the nearest TAIS Authorized Service Provider. You must pre-pay all transportation, taxes, duties and insurance charges incurred for shipment to TAIS or an Authorized Service Provider, and properly pack the Product for shipment in the original packaging or equivalent. You will not be reimbursed for these expenses. If the Product is not insured, and the Product is lost or damaged during transit, you are responsible for such loss or damage.

Disclaimer and Limitation of Remedy

ALL OTHER EXPRESS OR IMPLIED WARRANTIES OR CONDITIONS, INCLUDING THE IMPLIED WARRANTIES OF MERCHANTABILITY AND FITNESS FOR A PARTICULAR PURPOSE, ARE HEREBY DISCLAIMED. TAIS EXPRESSLY DISCLAIMS ALL WARRANTIES NOT STATED ABOVE. ANY IMPLIED WARRANTIES THAT MAY BE IMPOSED BY LAW ARE LIMITED IN DURATION TO THE TERM OF THIS LIMITED WARRANTY. SOME STATES OR PROVINCES DO NOT ALLOW LIMITATIONS ON HOW LONG AN IMPLIED WARRANTY MAY LAST, SO THE ABOVE LIMITATIONS MAY NOT APPLY TO YOU.

IF THE PRODUCT DOES NOT PERFORM AS WARRANTED, THE SOLE AND EXCLUSIVE REMEDY SHALL BE REPAIR OR REPLACEMENT. IN NO EVENT SHALL TAIS, TOSHIBA CORPORATION, OR ANY DEALER, DISTRIBUTOR OR AUTHORIZED SERVICE PROVIDER BE LIABLE FOR ANY DAMAGES IN EXCESS OF THE PURCHASE PRICE OF THE PRODUCT. THIS LIMITATION APPLIES TO DAMAGES OF ANY KIND, INCLUDING BUT NOT LIMITED TO DIRECT OR INDIRECT DAMAGES, LOST PROFITS, LOST SAVINGS, LOST DATA, OR OTHER SPECIAL, INCIDENTAL, EXEMPLARY OR CONSEQUENTIAL DAMAGES, WHETHER FOR BREACH OF CONTRACT, TORT OR OTHERWISE, OR WHETHER ARISING OUT OF THE USE OF OR INABILITY TO USE THE PRODUCT, EVEN IF TAIS, TOSHIBA CORPORATION, OR ANY DEALER, DISTRIBUTOR OR AUTHORIZED SERVICE PROVIDER HAS BEEN ADVISED OF THE POSSIBILITY OF SUCH DAMAGES, OR OF ANY CLAIM BY ANY OTHER PARTY. SOME STATES OR PROVINCES DO NOT ALLOW THE EXCLUSION OR LIMITATION OF INCIDENTAL OR CONSEQUENTIAL DAMAGES, SO THE ABOVE LIMITATION OR EXCLUSION MAY NOT APPLY TO YOU.

THIS LIMITED WARRANTY GIVES YOU SPECIFIC RIGHTS, AND YOU MAY ALSO HAVE OTHER RIGHTS, WHICH VARY FROM STATE TO STATE AND FROM PROVINCE TO PROVINCE.

TOSHIBA AMERICA INFORMATION SYSTEMS, INC.
Network Products Division
9740 Irvine Boulevard
Irvine, California 92618-1697
USA

Phone number: (949) 583-3223

TOSHIBA

End-User License Agreement

This End-User License Agreement (hereinafter this "Agreement") is a legally-binding agreement between the customer, either an individual or a single legal entity (hereinafter "the Customer") and Toshiba Corporation (hereinafter "Toshiba") with respect to the following software (hereinafter "Software"):

- (a) USB Driver Software for Toshiba PCX5000, and
- (b) Any software incorporated in or attached to Toshiba PCX5000.

By installing, copying, or otherwise using the Software, the Customer shall be deemed to agree to the terms and conditions of this Agreement. If the Customer does not agree to the terms and conditions of this Agreement, the Customer shall be requested to return promptly the whole system of Toshiba PCX5000 including the Software unused to the distributor or other from whom the Customer has received the system.

1. Title to Software

The Customer acknowledges that Toshiba or its supplier(s) retains all title to the Software and all applicable intellectual property rights in the Software, including without limitation, copyrights, patents, trade secrets and trademarks.

2. Grant of License

This Agreement grants the Customer a non-exclusive license to:

- (a) Install the Software recorded on an external media into the Customer's personal computer(s) and use the Software on and with a single personal computer for the purpose of processing the internal data of the Customer for use of Toshiba PCX5000 (hereinafter "Purpose"), and
- (b) Make one (1) copy of the Software recorded on an external media for the purpose of backup.

3. Restrictions

The Customer may:

- (a) Not disassemble, decompile or reverse engineer the Software,
- (b) Not make copies of the Software for any purpose other than backup,
- (c) Not install or use the Software for any purpose other than the Purpose or provide any third party or any employee of the Customer with access to the Software for any purpose other than the Purpose,
- (d) Not modify the Software or create derivative works of the Software,
- (e) Not sell, offer to sell, distribute (including through multiple tiers) the copies of the Software or publish the Software, or
- (f) Not rent or lease the Software.

Not remove or erase any copyright notice or legend from the Software.

4. Transfer

The Customer may permanently transfer all of the Customer's rights under this Agreement to any third party, provided that the Customer retain no copies and the recipient agrees to the terms and conditions of this Agreement.

5. Export

The Customer agrees not to export, license or otherwise transfer the Software to any country where such transfer is prohibited by the United States Export Administration Act, or any successor legislation, or in violation of the laws and regulations of Japan or any other country.

6. Termination

Without prejudice to any other rights, Toshiba may terminate this Agreement if the Customer fails to comply with the terms and conditions of this Agreement. In such event, the Customer must immediately cease to use the Software and all copies thereof.

7. United States Government Restricted Rights

If the Customer is an institution, department or other organization unit of the United States Government, the Software will be classified as "Commercial Computer Software" and the United States Government will be acquiring only "Restricted Rights" in the Software.

8. Miscellaneous

The governing law of this Agreement shall be the laws of Japan. Disputes in connection with this Agreement shall be subject to the exclusive original jurisdiction of Tokyo District Court of Japan.

9. No Warranty

THE SOFTWARE IS PROVIDED "AS IS". TO THE MAXIMUM EXTENT PERMITTED BY APPLICABLE LAW, TOSHIBA AND ITS SUPPLIER(S) MAKE NO WARRANTY OF ANY KIND, EITHER EXPRESS, IMPLIED, OR STATUTORY REGARDING THE SOFTWARE. TOSHIBA AND ITS SUPPLIER(S) EXPRESSLY DISCLAIM ANY IMPLIED WARRANTIES OF MERCHANTABILITY, FITNESS FOR A PARTICULAR PURPOSE, NONINFRINGEMENT OF INTELLECTUAL PROPERTY RIGHTS, AND ANY OTHER WARRANTY.

10. Limitation of Liability

TO THE MAXIMUM EXTENT PERMITTED BY APPLICABLE LAW, IN NO EVENT SHALL TOSHIBA OR ITS SUPPLIER(S) BE LIABLE FOR ANY DAMAGES WHATSOEVER, INCLUDING WITHOUT LIMITATION, DIRECT, INDIRECT, INCIDENTAL, CONSEQUENTIAL OR SPECIAL DAMAGES, LOSS OF PROFITS, REVENUE, LOSS OF BUSINESS, LOSS OF DATA OR LOSS OF USE, IRRESPECTIVE OF WHETHER TOSHIBA OR ITS SUPPLIER(S) HAS ADVANCE NOTICE OF THE POSSIBILITY OF SUCH DAMAGES. THE CUSTOMER AND TOSHIBA AGREE THAT THESE LIMITATIONS ON POTENTIAL LIABILITIES WERE AN ESSENTIAL ELEMENT IN SETTING CONDITIONS UNDER THIS AGREEMENT.

Toshiba:

Toshiba Corporation

Computer & Network Platform Division

1-1, Shibaura 1-chome, Minato-ku, Tokyo 105-8001, Japan

Free Manuals Download Website

<http://myh66.com>

<http://usermanuals.us>

<http://www.somanuals.com>

<http://www.4manuals.cc>

<http://www.manual-lib.com>

<http://www.404manual.com>

<http://www.luxmanual.com>

<http://aubethermostatmanual.com>

Golf course search by state

<http://golfingnear.com>

Email search by domain

<http://emailbydomain.com>

Auto manuals search

<http://auto.somanuals.com>

TV manuals search

<http://tv.somanuals.com>