

Toshiba Personal Computer
Satellite L600D/L640D/L645D, Satellite Pro
L600D/Pro L640D/Pro L645D
Maintenance Manual

TOSHIBA CORPORATION

File Number 960-Q08

Copyright

© 2010 by Toshiba Corporation. All rights reserved. Under the copyright laws, this manual cannot be reproduced in any form without the prior written permission of Toshiba. No patent liability is assumed with respect to the use of the information contained herein.

Toshiba Personal Computer Satellite L600D/L640D/L645D, Satellite Pro L600D/Pro L640D/Pro L645D Maintenance Manual

First edition March.2010

Disclaimer

The information presented in this manual has been reviewed and validated for accuracy. The included set of instructions and descriptions are accurate for the Satellite L600D/L640D/L645D, Satellite Pro L600D/Pro L640D/Pro L645D Series at the time of this manual's production. However, succeeding computers and manuals are subject to change without notice. Therefore, Toshiba assumes no liability for damages incurred directly or indirectly from errors, omissions, or discrepancies between any succeeding product and this manual.

Trademarks

AMD, Phenom2, Turion, Athlon, and Sempron are trademarks or registered trademarks of AMD or its subsidiaries in the United States and other countries/regions.
Windows and Microsoft are registered trademarks of Microsoft Corporation.
Other trademarks and registered trademarks not listed above may be used in this manual.

Preface

This maintenance manual describes how to perform hardware service maintenance for the Toshiba Personal Computer Satellite L600D/L640D/L645D, Satellite Pro L600D/Pro L640D/Pro L645D Series.

The procedures described in this manual are intended to help service technicians isolate faulty Field Replaceable Units (FRUs) and replace them in the field.

SAFETY PRECAUTIONS

Four types of messages are used in this manual to bring important information to your attention. Each of these messages will be italicized and identified as shown below.

DANGER: “Danger” indicates the existence of a hazard that could result in death or serious bodily injury, if the safety instruction is not observed.

WARNING: “Warning” indicates the existence of a hazard that could result in bodily injury, if the safety instruction is not observed.

CAUTION: “Caution” indicates the existence of a hazard that could result in property damage, if the safety instruction is not observed.

NOTE: “Note” contains general information that relates to your safe maintenance service.

Improper repair of the computer may result in safety hazards. Toshiba requires service technicians and authorized dealers or service providers to ensure the following safety precautions are adhered to strictly.

- Be sure to fasten screws securely with the right screwdriver. If a screw is not fully fastened, it could come loose, creating a danger of a short circuit, which could cause overheating, smoke or fire.
- If you replace the battery pack or RTC battery, be sure to use only the same model battery or an equivalent battery recommended by Toshiba. Installation of the wrong battery can cause the battery to explode.

The manual is divided into the following parts:

- Chapter 1 Hardware Overview describes the Satellite L600D/L640D/L645D, Satellite Pro L600D/Pro L640D/Pro L645D system unit and each FRU.
- Chapter 2 Troubleshooting Procedures explains how to diagnose and resolve FRU problems.
- Chapter 3 Test and Diagnostics describes how to perform test and diagnostic operations for maintenance service.
- Chapter 4 Replacement Procedures describes the removal and replacement of the FRUs.
- Appendices The appendices describe the following:
 - Handling the LCD Module
 - Board layout
 - Pin assignments
 - Keyboard scan/character code
 - Key layout
 - Wiring diagrams

Conventions

This manual uses the following formats to describe, identify, and highlight terms and operating procedures.

Acronyms

On the first appearance and whenever necessary for clarification acronyms are enclosed in parentheses following their definition. For example:

Read Only Memory (ROM)

Keys

Keys are used in the text to describe many operations. The key top symbol as it appears on the keyboard is printed in **boldface** type.

Key operation

Some operations require you to simultaneously use two or more keys. We identify such operations by the key top symbols separated by a plus (+) sign. For example, **Ctrl + Pause (Break)** means you must hold down **Ctrl** and at the same time press **Pause (Break)**. If three keys are used, hold down the first two and at the same time press the third.

User input

Text that you are instructed to type in is shown in the boldface type below:

DISKCOPY A: B:

The display

Text generated by the computer that appears on its display is presented in the typeface below:

Format complete
System transferred

Table of Contents

Chapter 1 Hardware Overview

1.1	Features	1
1.2	System Block Diagram	6
1.3	2.5-inch Hard Disk Drive.....	9
1.4	Keyboard.....	12
1.5	TFT Color Display	13
1.6	Power Rails	15
1.7	Batteries	16
1.8	AC Adapter	19
1.9	ODD.....	20

Chapter 2 Troubleshooting Procedures

2.1	Troubleshooting	1
2.2	Troubleshooting Flowchart.....	2
2.3	Power Supply Troubleshooting.....	7
	Procedure 1 Power Status Check	7
	Procedure 2 Connection Check.....	9
	Procedure 3 Charging Check	9
	Procedure 4 Replacement Check	11
2.4	System Board Troubleshooting.....	12
	Procedure 1 Message Check	13
	Procedure 2 Diagnostic Test Program Execution Check	14
	Procedure 3 Replacement Check	14
2.5	SATA HDD/SSD Troubleshooting.....	15
	Procedure 1 Partition Check.....	15
	Procedure 2 Message Check	16
	Procedure 3 Format Check.....	17
	Procedure 4 Diagnostic Test Program Execution Check	18
	Procedure 5 Connector Check and Replacement Check.....	19
2.6	Keyboard Troubleshooting	20
	Procedure 1 Diagnostic Test Program Execution Check	20
	Procedure 2 Connector Check and Replacement Check.....	21
2.7	Touch pad Troubleshooting	22
	Procedure 1 Diagnostic Test Program Execution Check	22
	Procedure 2 Connector Check and Replacement Check.....	23

2.8	Display Troubleshooting.....	24
	Procedure 1 External Monitor Check.....	24
	Procedure 2 Diagnostic Test Program Execution Check	24
	Procedure 3 Connector and Cable Check	25
	Procedure 4 Replacement Check	26
2.9	LAN Troubleshooting.....	27
	Procedure 1 Diagnostic Test Program Execution Check	27
	Procedure 2 Connector Check and Replacement Check.....	27
2.10	Wireless LAN Troubleshooting	28
	Procedure 1 Transmitting-Receiving Check	28
	Procedure 2 Antennas' Connection Check	29
	Procedure 3 Replacement Check	30
2.11	Sound Troubleshooting.....	31
	Procedure 1 Connector Check.....	31
	Procedure 2 Replacement Check	32
2.12	Bluetooth Troubleshooting	33
	Procedure 1 Connector Check and Replacement Check.....	33
2.13	HDMI Troubleshooting	34
	Procedure 1 Connector Check and Replacement Check.....	34
	Procedure 2 External Monitor Check.....	34
	Procedure 3 Connector and Cable Check.....	35
	Procedure 4 Replacement Check.....	36
2.14	Memory Troubleshooting	37
	Procedure 1 Diagnostic Test Program Execution Check	37
	Procedure 2 Connect Check and Replacement Check.....	37
2.15	3G Troubleshooting	38
	Procedure 1 Connector Check and Replacement Check.....	38
2.16	Camera Troubleshooting.....	39
	Procedure 1 Camera Execution Check.....	39
	Procedure 2 Connect Check and Replacement Check.....	39
2.17	Microphone Troubleshooting	40

	Procedure 1	Sound Recorder Execution Check	40
	Procedure 2	Connect Check and Replacement Check.....	40
2.18	CRT Troubleshooting		41
	Procedure 1	External Monitor Check.....	41
	Procedure 2	Connector and Cable Check.....	41
2.19	USB Troubleshooting		43
	Procedure 1	Diagnostic Test Program Execution Check	43
	Procedure 2	Connect Check and Replacement Check.....	43
2.20	LED Troubleshooting		44
	Procedure 1	Each function Execution Check.....	44
	Procedure 2	Connect Check and Replacement Check.....	44
2.21	Optical Disk Drive Troubleshooting.....		45
	Procedure 1	Diagnostic Test Program Execution Check	45
	Procedure 2	Connector Check and Replacement Check.....	45
2.22	Modem Troubleshooting.....		47
	Procedure 1	Diagnostic Test Program Execution Check	47
	Procedure 2	Connector Check and Replacement Check.....	47
2.23	3 in 1 Card Reader Troubleshooting.....		49
	Procedure 1	Media Card Check	49
	Procedure 2	Connector Check and Replacement Check.....	49

Chapter 3 Diagnostic Programs

3.1	Tests and Diagnostics Software Overview	2
3.2	Executing the Diagnostic Test	3
3.3	Subtest names.....	7
3.4	System Test.....	10
3.5	Memory Test.....	17
3.6	Keyboard Test.....	21
3.7	Display Test	24
3.8	Hard Disk Test	39
3.9	Real Time Clock Test	42
3.10	Cache Memory Test.....	44
3.11	High Resolution Display Test.....	46
3.12	Multimedia Test	52
3.13	MEMORY2 Test.....	53
3.14	Error Codes and Error Status Names	55
3.15	Running Test.....	57
3.16	DMI INFOEMATION	58
3.17	Log Utilities	60
3.18	System Configuration	62
3.19	Running Test Edit Item.....	63
3.20	Common Tests and Operation	65

Chapter 4 Replacement Procedures

4.1	Overview.....	1
	Safety Precautions.....	2
	Before You Begin	3
	Disassembly Procedure.....	4
	Assembly Procedure	5
	Tools and Equipment	5
	Screw Tightening Torque	6
	Grip Color	6
	Screw Notation.....	7
4.2	Battery pack	8
4.3	HDD.....	11
4.4	Memory Module	14
4.5	Keyboard.....	17
4.6	Wireless LAN card and BT Module	20
4.7	3G Module	23
4.8	Display Assembly	26
4.9	Top Cover Assembly	33
4.10	Touch pad.....	36
4.11	I/O board	39
4.12	System Board	41
4.13	CPU Heat Sink.....	46
4.14	LCD unit	48
4.15	Web Camera Module	52
4.16	Application for Thermal pad and grease on CPU, NB, V-ram and chock.....	55
4.17	Speaker Box.....	57
4.18	ODD Bezel.....	60

Appendices

Appendix A	Handling the LCD Module	1
Appendix B	Board Layout	1
Appendix C	Pin Assignments.....	1
Appendix D	Keyboard Scan/Character Codes	1
Appendix E	Key Layout.....	1
Appendix F	Wiring Diagrams.....	1

Chapter 1

Hardware Overview

Chapter 1 Contents

1.1	Features	1
1.2	System Block Diagram	7
1.3	2.5-inch Hard Disk Drive.....	11
1.4	Keyboard.....	14
1.5	TFT Color Display	15
1.6	Power Rails	17
1.7	Batteries	18
1.8	AC Adapter	21
1.9	ODD	22

Figures

Figure 1-1-1	Left of the computer.....	5
Figure 1-1-2	Right of the computer	6
Figure 1-2-1	System block diagram for AMD platform	8
Figure 1-3-1	2.5-inch Hard Disk Drive.....	11
Figure 1-4-1	Keyboard for US Style.....	14
Figure 1-5-1	AUO LCD Function Block Diagram.....	15
Figure 1-9-1	DVD Super Muti drive.....	22

Tables

Table 1-3-2	2.5-inch HDD dimensions	12
Table 1-3-3	2.5-inch HDD specifications.....	13
Table 1-5-2	LCD module specifications.....	15
Table 1-6-1	Danube Power supply output rating.....	17
Table 1-7-1	Battery specifications.....	18
Table 1-7-2	Time required for charges of main battery	19
Table 1-7-3	Data retaining time.....	19
Table 1-7-4	Time required for charge of RTC battery	20
Table 1-8-1	AC adapter specifications	21
Table 1-9-2	DVD Super Multi drive outline dimensions	22
Table 1-9-3	DVD Super Multi drive specifications	24
Table 1-9-4	Blue ray ODD dimensions	25
Table 1-9-5	Blue ray ODD specifications	26

Features

1.1 Features

The Satellite L600D/L640D/L645D, Satellite Pro L600D/Pro L640D/Pro L645D (AMD Platform) features are listed below.

Microprocessor

Microprocessor that is used will be different by the model.

It supports processors as follows:

-AMD Phenom2 Quad Core N930/ Quad Core P920

-AMD Phenom2 Dual Core N620/ Triple Core N830/P820

-AMD Turion Dual Core N530/ P520

-AMD Athlon Dual Core N330/ P320

-AMD Sempron V120

Memory

Two DDR3 SO-DIMM (DDR3-1066 or compatible) used and be up to 8GB which can be upgraded through Memory Module Slot. Maximum upgradeable system memory may depend on the model

VRAM

- Shared with System RAM for AMD RS880M UMA SKU

- Discreet VRAM Memory that is used will be different by the model,

which support as:

512MB, 1GB,

HDD

5400rpm: 250GB, 320GB, 400GB, 500GB, 640GB internal drives. 2.5 inch x 9.5mm height.

- SSD
 - 64GB, 128GB, 256GB, 512GB. 2.5 inch x 9.5mm height.

- ODD
 - 12.7mm integrated ODD
 - Support: DVD Super Multi (+-R Double Layer) & Blue Ray ODD.

- Display
 - LCD
 - 14.1-inch, 1366x768(16:9), LED-backlight.
 - External monitor
 - Supported via RGB and HDMI connectors.

- Keyboard
 - Keyboard module has 88-89 keys. It supports Windows key and Application key.

- Camera
 - CMOS,0.3M,VGA/CMOS,1.3M,SXGA/0.3M,VGA/1.3M,SXGA/CMOS,0.3M/CMOS,1.3M

- Microphone
 - Ext. MIC port

- Headphones Line out Jack
 - Earphone port

Modem

Connectors for Modem is separately mounted

Battery

The RTC battery is equipped inside the computer.

The main battery is a detachable lithium ion battery.

- 3 cell 10.8V/2250mAh

- 6 cell 10.8V/4400mAh/4500mAh/5600mAh

- 12cell 10.8V/9000mAh

USB (Universal Serial Bus)

2 standard USB ports and 1 integrated in E-SATA connector USB port are provided. The ports comply with the USB2.0 standard.

Sound system

Internal stereo speaker, Internal MIC (Option), external monaural microphone connector, stereo headphone connector. The computer will support Dolby to decrease the noise.

Wireless LAN

Some computers in this series are equipped with a Wireless LAN card. There are two types: WLAN combo Wimax module and WLAN combo + BT combo module.

LAN

The computer has built-in support for Ethernet LAN (10 megabits per second, 10BASE-T), Fast Ethernet LAN (100 megabits per second, 100 BASE-TX) and Extra Ethernet LAN (1000 megabits per second, 1000 BASE-TX) (Option)

Bridge Media Slot

SD/MS/MS pro/MMC are supported.

Bluetooth

Some computers in this series offer Bluetooth wireless communication functionality with Broadcom 802.11(b/g/n) BCM94313-HMC w/ BT V3.0+HS Combo module.

3G

Support TD-SCDMA, W-CDMA

Security

Kensington Lock,

Hard Disk Drive Password

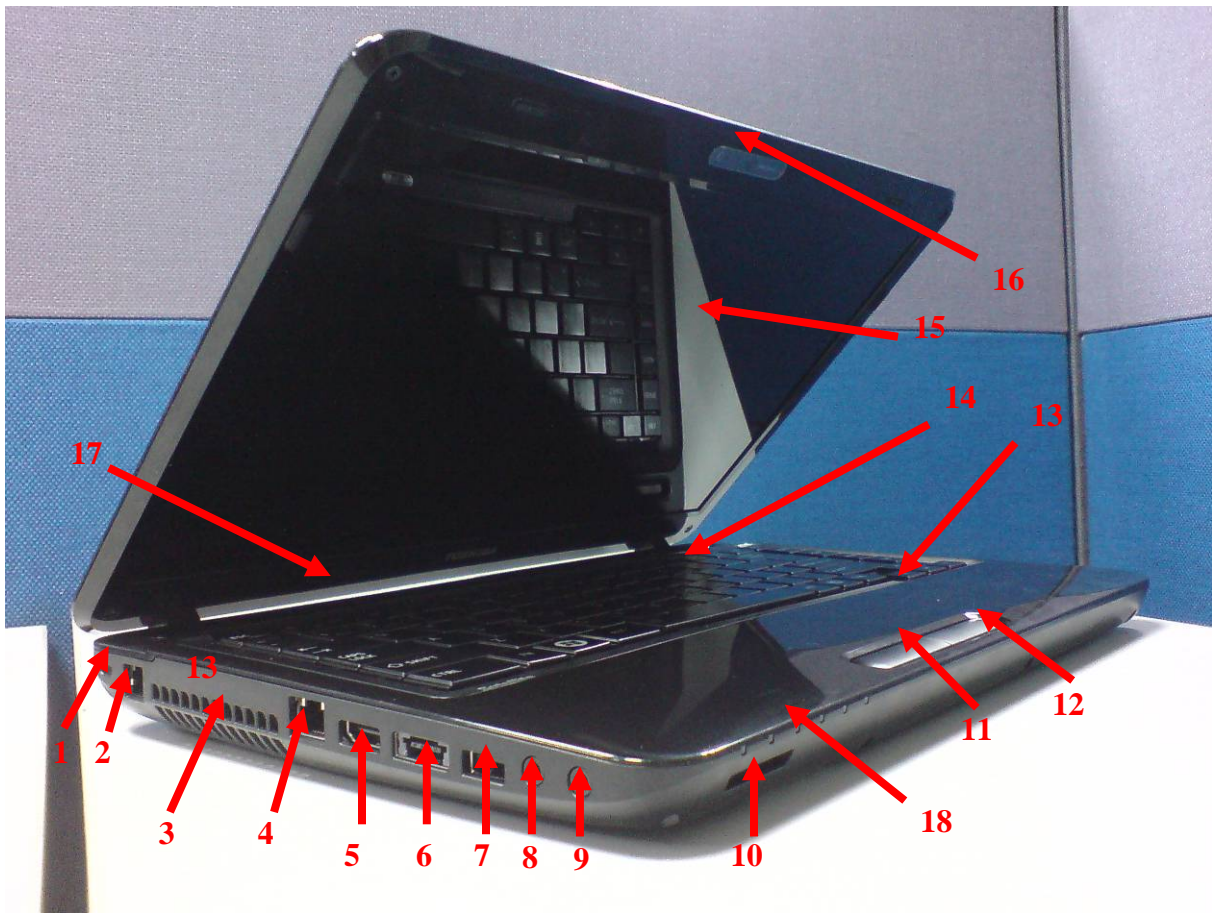

Figure 1-1-1 left of the computer

- | | |
|--|------------------|
| 1. Security Lock Hole | 13. Touch Pad |
| 2. RJ11 Port | 14. Keyboard |
| 3. FAN Hole | 15. LCD Panel |
| 4. RL45 Port | 16. Web camera |
| 5. HDMI Port | 17. Power Button |
| 6. E-SATA Port (integrated a USB Port) | 18. Hall-sensor |
| 7. USB Port | |
| 8. Ext. MIC Port | |
| 9. Earphone Port | |
| 10. Card Reader Port | |
| 11. Touch Pad Control Left Button | |
| 12. Touch Pad Control Right Button | |

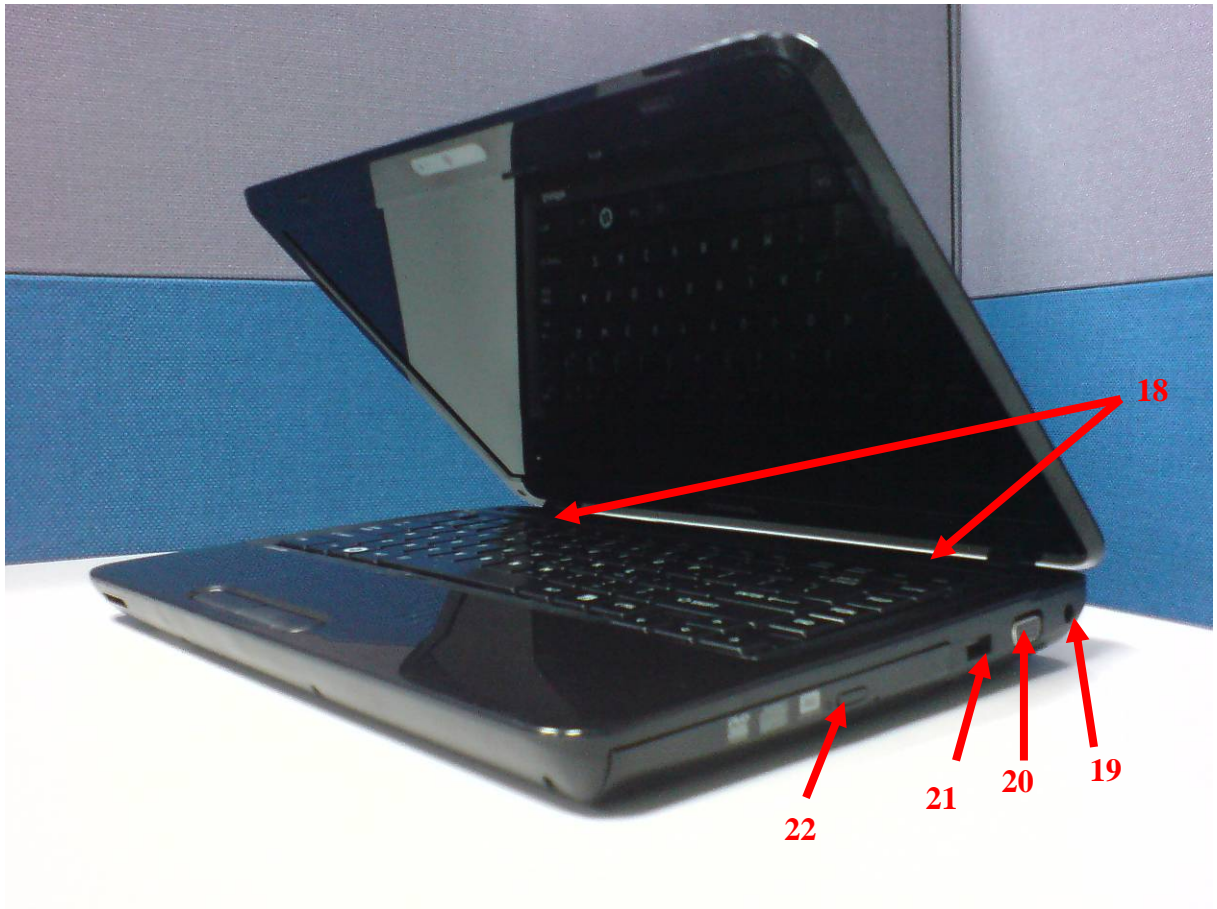
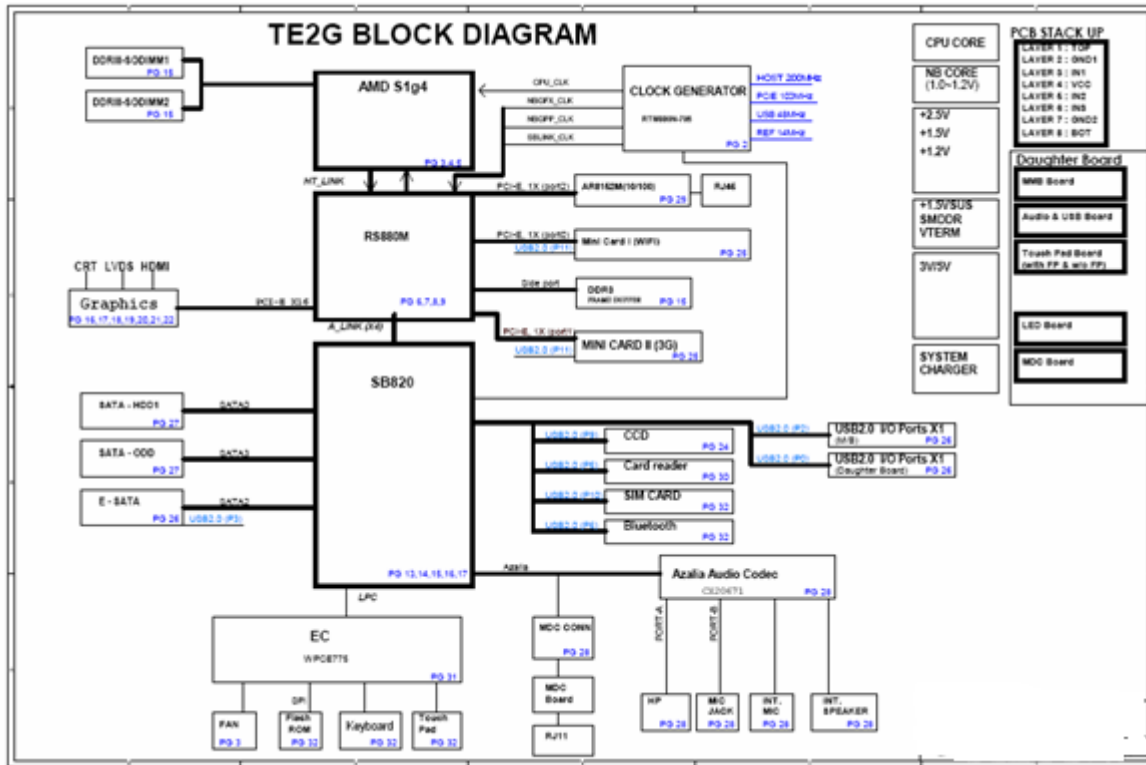

Figure 1-1-2 right of the computer

- 18. Speaker
- 19. DC-IN Jack
- 20. CRT Port
- 21. USB Port
- 22. ODD

1.2 System Block Diagram

Figure 1-2-1 shows the system block diagram.



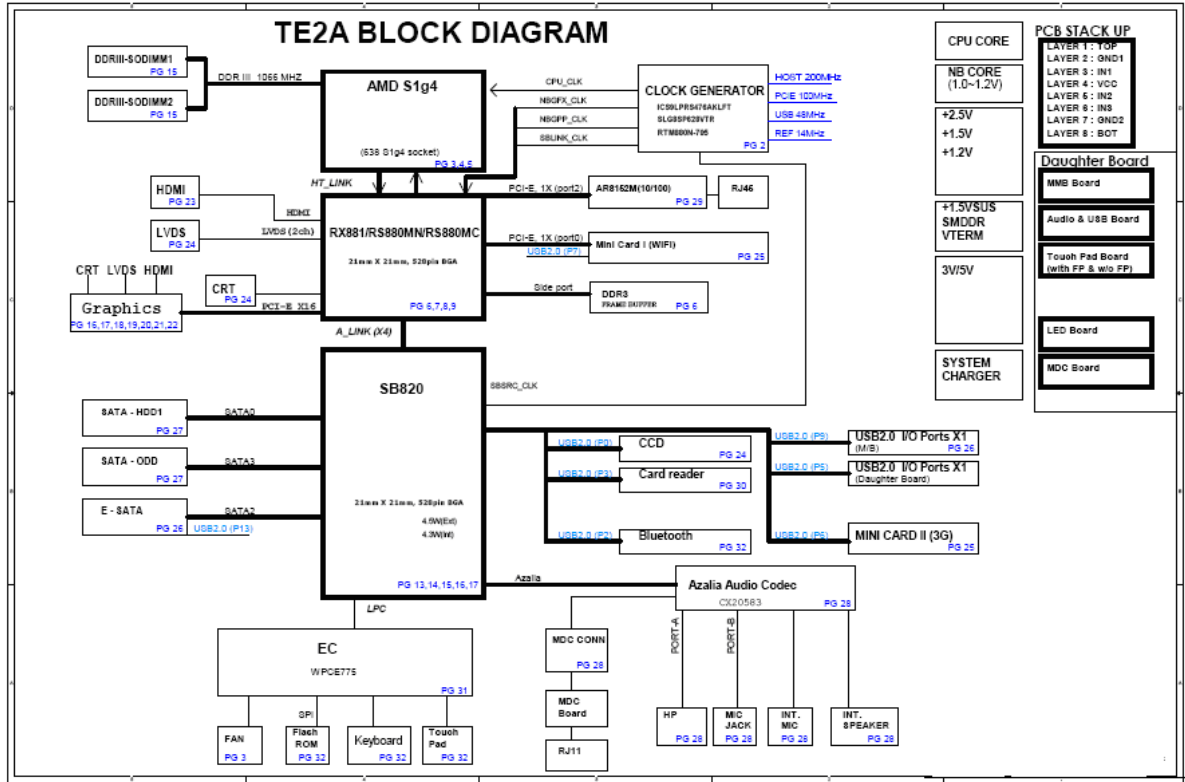

Figure 1-1-1 System block diagram for AMD Platform

The PC contains the following components.

CPU

- AMD Phenom2 Quad Core N930/ Quad Core P920
- AMD Phenom2 Dual Core N620/ Triple Core N830/P820
- AMD Turion Dual Core N530/ P520
- AMD Athlon Dual Core N330/ P320
- AMD Sempron V120

Memory

Two memory slots capable of accepting DDR3-SDRAM 512MB, 1GB, 2GB, 4GB memory modules for a maximum of 8GB.

- 208-pin SO-DIMM
- 1.5V operation voltage

ME+BIOS ROM (Flash memory)

- 32Mbit

Chipset

- IBEX PEAK-M (AMD North Bridge RS880M, South Bridge SB820M)
 - Supports FDI BUS for video out
 - Supports PCI-E Gen2 (version 2.0)
 - 1071 FCBGA package, 24.6mmx26.5mm.

VGA Card

- AMD-ATI (Park-XT, M92XTX)

- Supports ATI HyperMemory*
 - Supports PCI-E Gen2 (version 2.0)

- Other main system chips

- Clock Generator (Congo Platform: SLG8SP595VTR)
 - EC (WO/CIR WPCE775CA0DG)
 - HD Audio (CONEXANT CX20583-10Z)
 - Card Reader controller (REALTEAK RTS5159)
 - 10/100 LAN controller (Atheros AR8152M)
 - 10/100/1000 LAN controller (Atheros AR8151M)

- Mini Card
 - Wireless LAN (BTO)
 - IEEE802.11b/g or IEEE802.11b/g/n

- 3G communication (option)
 - TD-SCDMA, WCDMA

- Wireless WAN (BTO)
 - HSPA

- Bluetooth
 - Bluetooth V2.1+EDR and Combo module. (BTO)

1.3 2.5-inch Hard Disk Drive

A compact, high-capacity HDD with a height of 9.5mm. Contains a 2.5-inch magnetic disk and magnetic heads.

Figure 1-3-1 shows a view of the 2.5-inch HDD and Tables 1-3-2 and 1-3-3 list the specifications.

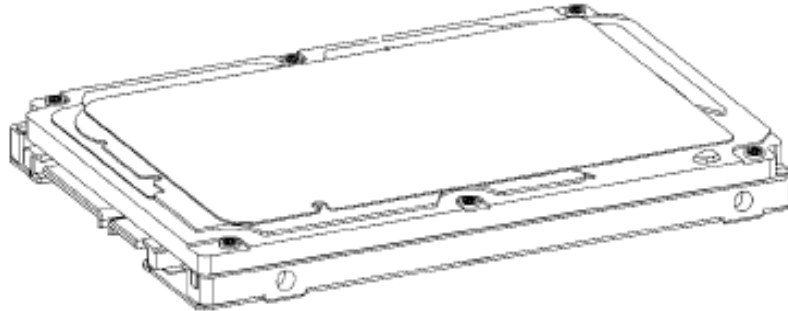

Figure 1-3-1 2.5-inch HDD

Parameter		Standard value				
		Toshiba MK1665GSX	Toshiba MK2565GSX	Toshiba MK3265GSX	Toshiba MK5065GSX	Toshiba MK6465GSX
Outline	Width (mm)	69.85 +/- 0.25				
dimensions	Height (mm)	9.5				
Depth (mm)		100.2 +/- 0.25				
Weight (g)		97/98	97/98	97/98	101/102	101/102
Parameter		Standard value				
		HITACHI HTS545016B9A300	HITACHI HTS545025B9A300	HITACHI HTS545032B9A300	HITACHI HTS545050B9A300	
Outline	Width (mm)	69.85 +/- 0.25				
dimensions	Height (mm)	9.5				
Depth (mm)		100.2 +/- 0.25				
Weight (g)		95(Max)	95(Max)	102(Max)	102(Max)	

Chapter 1 Hardware Overview

Parameter		Standard value				
		WD1600BEVT	WD2500BEVT	WD3200BEVT	WD6400BEVT	WD5000BEVT
Outline	Width (mm)	69.85 +/- 0.25				
dimensions	Height (mm)	9.5				
Depth (mm)		100.2 +/- 0.25				
Weight (g)		97/98	97/98	97/98	97/98	97/98
Parameter		Standard value				
		ST9160314AS	ST9250315AS	ST9320325AS	ST9500325AS	
Outline	Width (mm)	69.85 +/- 0.25				
dimensions	Height (mm)	9.5+/-0.2				
Depth (mm)		100.35 +/- 0.25				
Weight (g)		93.5	93.5	98.8	98.8	

Table 1-3-2 2.5-inch HDD dimensions

Parameter	Specification				
	Toshiba MK1665GSX	Toshiba MK2565GSX	Toshiba MK3265GSX	Toshiba MK5065GSX	Toshiba MK6465GSX
Storage size (formatted)	160G	250G	320G	500G	640G
Speed (RPM)	5,400				
Data transfer Rate - To/From Media - T0/From Host	464~1164 typical/3GBytes				
bus transfer rate (MB/s)	3Gbps				
Average random seek time(read)(ms)	12				
Power-on-to-ready (sec)	3.5(type)/9.5(max)				
Parameter	Specification				
	HITACHI HTS545016B9A300	HITACHI HTS545025B9A300	HITACHI HTS545032B9A300	HITACHI HTS545050B9A300	
Storage size (formatted)	160G	250G	320G	500G	
Speed (RPM)	5,400				
Data transfer Rate - To/From Media - T0/From Host	845/3GBytes		875/3GBytes		
bus transfer rate (MB/s)	3Gbps				

Average random seek time(read)(ms)	12				
Power-on-to-ready (sec)	3.5				
Parameter	Specification				
	WD1600BEVT	WD2500BEVT	WD3200BEVT	WD6400BEVT	WD5000BEVT
Storage size (formatted)	160G	250G	320G	640G	500G
Speed (RPM)	5,400				
Data transfer Rate - To/From Media - T0/From Host	106/3GBytes				
bus transfer rate (MB/s)	3Gbps				
Average random seek time(read)(ms)	12				
Power-on-to-ready (sec)	4.0				
Parameter	Specification				
	ST9160314AS	ST9250315AS	ST9320325AS	ST9500325AS	
Storage size (formatted)	160G	250G	320G	500G	
Speed (RPM)	5,400				
Data transfer Rate - To/From Media - T0/From Host	300/3GBytes				
bus transfer rate (MB/s)	3Gbps				
Average random seek time(read)(ms)	14				
Power-on-to-ready (sec)	3.6(typical)3.8(max)				

Table 1-3-3 2.5-inch HDD specifications

1.4 Keyboard

The Rostock 10ADG keyboard has two different kinds of placement, here is US style Keyboard for your reference.

Figure 1-4-1 is a view of the keyboard for US style

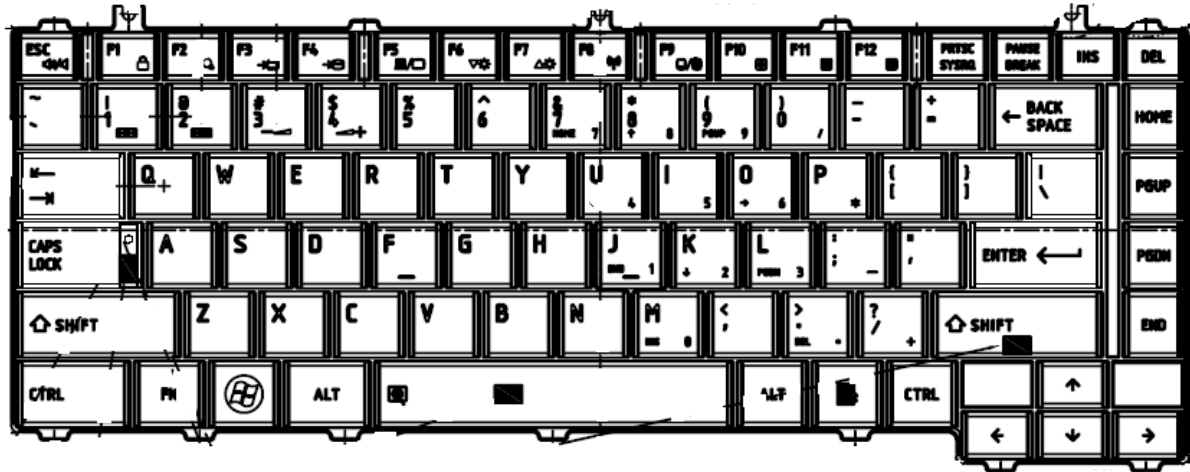

Figure 1-4-1 Keyboard for US style

See Appendix E for details of the keyboard layout

1.5 TFT Color Display

The Satellite L645D, Satellite L645D use LED to control backlight.

1.5.1 LCD Function Block

Figure 1-5-1 shows a view of the LCD Function Block and Table 1-5-2 lists the specifications.

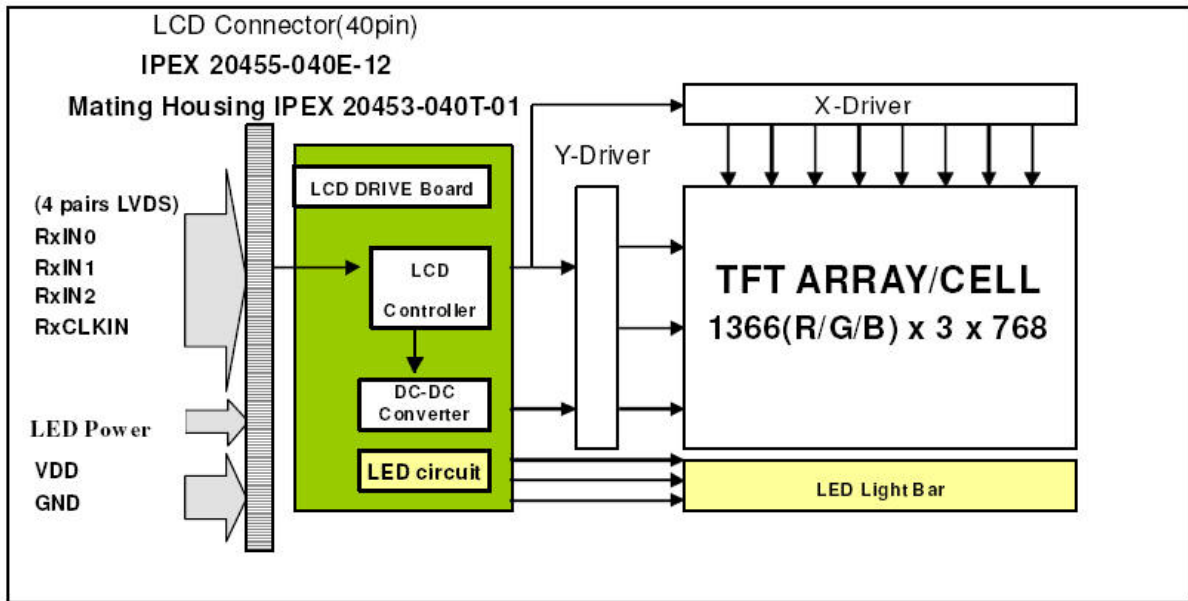
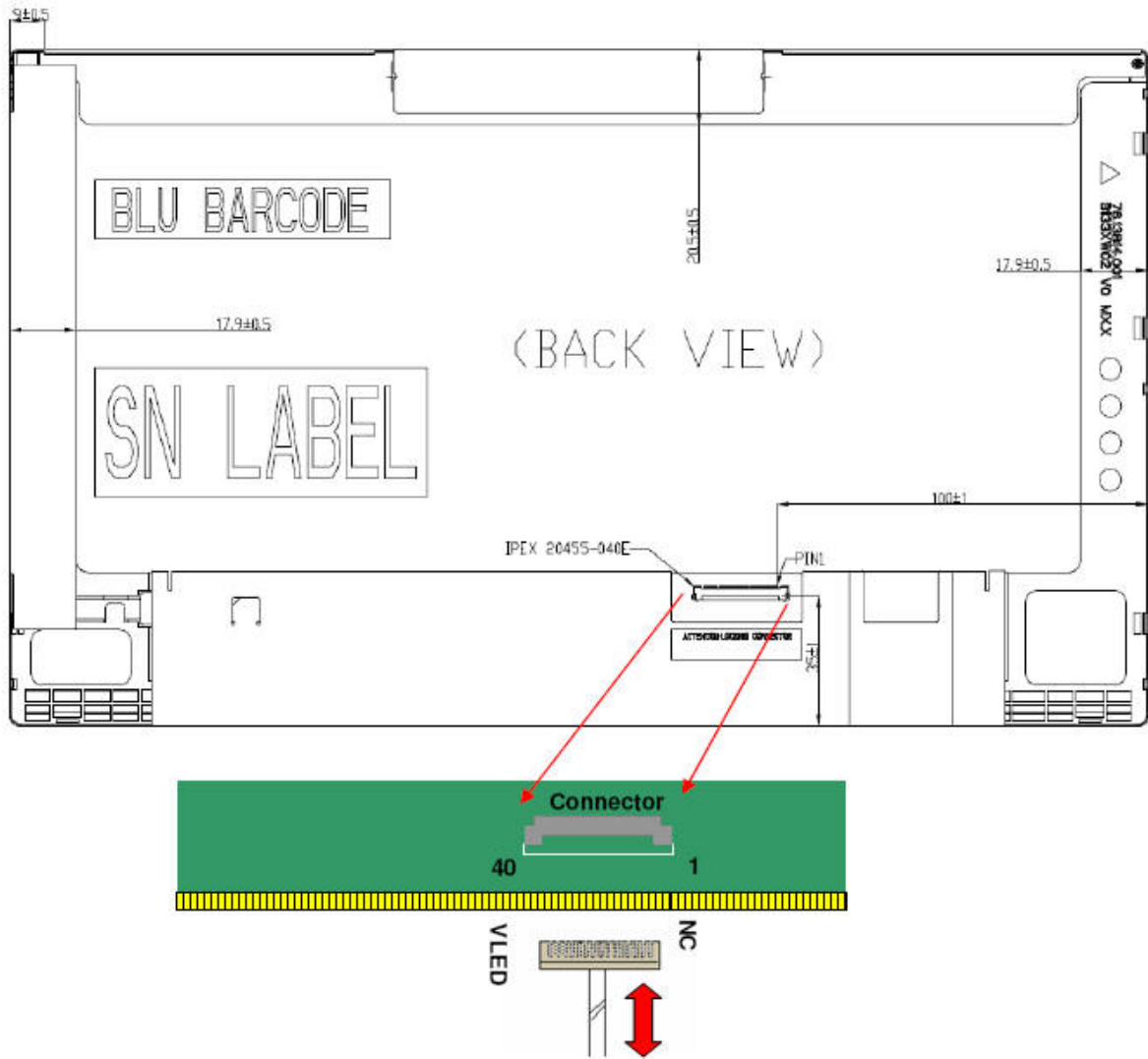

Figure 1-5-1 AUO LCD Function Block Diagram

Item	Specifications(WXGA+)			
	AUO B140XW01 V6	Samsung LTN140AT07-T01	CMO N140B6-L02	LG Display LP140WH1-TLA1
Number of Dots	1366x3(RGB) x 768	1366x3(RGB) x 768	1366x3(RGB) x 768	1366x3(RGB) x 768
Dot spacing (mm)	0.2148(H)X0.2148(V)	0.2148(H)X0.2148(V)	0.2148(H)X0.2148(V)	0.2148(H)X0.2148(V)
Display Colors	6-bit, 262,144 colors	6-bit, 262,144 colors	6-bit, 262,144 colors	6-bit, 262,144 colors

Table 1-5-2 LCD module specifications

1.5.2 LCD Module



1.6 Power Rails

Table 1-6-1 lists the power rail output specifications of Danube platform.

Name	Power supply (Yes/No)			
	Voltage [V]	Power OFF Suspend mode	Power OFF Boot mode	No Main Battery(with RTC battery)
+5VPCU	5	Yes	Yes	No
+5V	5	No	No	No
+3VPCU	3.3	Yes	Yes	No
+3V_S5	3.3	Yes	No	No
+3VSUS	3.3	Yes	No	No
+3V	3.3	No	No	No
+1.5VSUS	1.5	Yes	No	No
+SMDDR_VTERM	0.75	Yes	No	No
+SMDDR_VREF	0.75	Yes	No	No
+1.8V	1.8	No	No	No
+1.5V	1.5	No	No	No
+1.2V	1.25	No	No	No
+1.05v	1.05	No	No	No
+VTT	1.05-1.1	No	No	No
+GPU_CORE	0.9~1.12	No	No	No
+VCC_CORE	0~1.5	No	No	No
+VCCRTC	3.266	Yes	Yes	Yes

Table 1-6-1 Danube Power supply output rating

1.7 Batteries

The PC has the following two batteries.

- Main battery
- Real time clock (RTC) battery

Table 1-7-1 lists the specifications for these two batteries.

Battery Name	Battery Element	Output Voltage	Capacity	
Main Battery	3 Cell	Li-ion	10.8v	2250mAh
	6 Cell	Li-ion	10.8v	4400mAh/4500mAh/5600mAh
	12Cell	Li-ion	10.8v	9000mAh
RTC Battery	Coin type	Li-ion	3.0v	14mAh

Table 1-7-1 Battery specifications

1.7.1 Main Battery

The main battery is the primary power supply for the computer when the AC adapter is not connected.

1.7.2 Battery Charging Control

Battery charging is controlled by a power supply microprocessor. The power supply microprocessor controls power supply and detects a full charge when the AC adaptor and battery are connected to the computer.

- Battery Charge

When the AC adapter is connected, normal charging is used while the system is turned on and quick charge is used while the system is turned off. Refer to the following Table 1-7-2.

System On	Charge time
Pana 3cell 2250mAh	3hr can charge to full
Sony 6cell 4400mAh	
SDI 6cell 4400mAh	

LGC 6cell 4400mAh	
Sanyo 6cell 4500mAh	3hr can charge to full
Pana 6cell 4500mAh	
Sanyo 6cell 5600mAh	4hr can charge to full
Pana 6cell 5600mAh	
Sanyo 12cell 9000mAh	5hr can charge to full

Table 1-7-2 Time required for charges of main battery

Charge is stopped in the following cases.

1. The main battery is fully charged
 2. The main battery is removed
 3. Main battery or AC adapter voltage is abnormal
 4. Charging current is abnormal
- Data retaining time

When turning off the power in being charged fully, the retaining time is as following Table 1-7-3.

Retaining data Time with power off (days)

Sleep	Shut down
About 3 days	About 30 days
About 5 days	About 50 days

Table 1-7-3 Data retaining time

1.7.3 RTC Battery

The RTC battery provides the power supply to maintain the date, time, and other system information in memory.

Table 1-7-4 lists the Time required for charges of RTC battery and data retaining time.

Condition	Time
Charging time	About 24 hours
Data retaining time	About 30days

Table 1-7-4 Time required for charges of RTC battery

1.8 AC Adapter

The AC adapter is used to charge the battery.

Table 1-8-1 lists the AC adapter specifications.

Parameter	Specification		
With Led	DELTA/ LITE-ON	DELTA/ LITE-ON	DELTA/ LITE-ON
Power	65W	75W	90W
Input voltage	AC 100V/240V		
Input frequency	50Hz/60Hz		
Input current	$\leq 1.5A$		
Output voltage	DC 19V		
Output current	3.42A	3.95A	4.74A

Table 1-8-1 AC adapter specifications

1.9 ODD

1.9.1 DVD Super Multi drive

The DVD Super Multi drive accommodates either 12 cm (4.72-inch) or 8 cm (3.15-inch) CD/DVD-ROM, CD-R/RW, DVD±R/±RW and DVD-RAM. It is a high-performance drive that reads DVD-ROM at maximum 8-speed and CD at maximum 24-speed. Write speed of DVD±R/±RW and DVD-RAM is different depending on the drive.

The DVD Super Multi drive is shown in Figure 1-9-1. The dimensions and specifications of the DVD Super Multi drive are described in Table 1-9-2, Table 1-9-3.

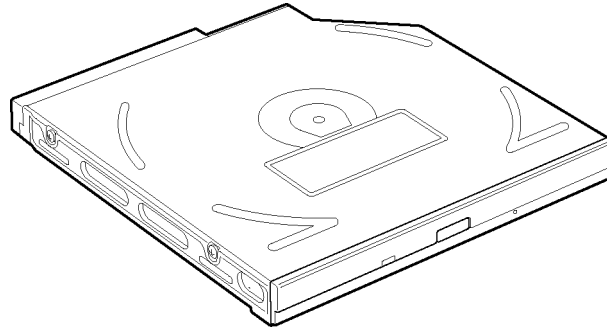

Figure 1-9-1 DVD super multi drive

Parameter		Standard Value			
		TST	TST	Panasonic	Panasonic
Outline dimension	Maker	TS-L633C	TS-L633Y	UJ890ADTJR-A	UJ890EDTJR-A
	Width (mm)	128	128	128	128
	Height (mm)	12.7	12.7	12.7	12.7
	Depth (mm)	127	127	129	134
	Mass (g)	165	165	170+/-10	176.2

Table 1-9-2 DVD super multi drive outline dimensions

Parameter		Drive Specification	
		TST	TST
		TS-L633C	TS-L633Y
Data transfer speed	Read (KB/s)	CD-ROM Max. 24X (3,600 KB/sec)	CD-ROM Max. 24X (3,600 KB/sec)
		CD-R Max. 24X (3,600 KB/sec)	CD-R Max. 24X (3,600 KB/sec)
		CD-RW Max. 24X (3,600 KB/sec)	CD-RW Max. 24X (3,600 KB/sec)
		DVD-ROM 5 Max 8X (10,800 KB/sec)	DVD-ROM 5 Max 8X (10,800 KB/sec)
		DVD-ROM 9 Max 8X (10,800 KB/sec)	DVD-ROM 9 Max 8X (10,800 KB/sec)
		DVD±R DUAL Max 8X (10,800 KB/sec)	DVD±R DUAL Max 8X (10,800 KB/sec)
		DVD-RAM Max 5X (6,750 KB/sec)	DVD-RAM Max 5X (6,750 KB/sec)
	Write	CD-R Max. 24X (3,600 KB/sec)	CD-R Max. 24X (3,600 KB/sec) P-CAV
		MS CD-RW Max. 4X (600 KB/sec)	MS CD-RW Max. 4X (600 KB/sec)
		HS CD-RW Max. 10X (1,500 KB/sec)	HS CD-RW Max. 10X (1,500 KB/sec)
		US CD-RW Max. 24X (3,600 KB/sec)	US CD-RW Max. 24X (3,600 KB/sec)
		US+ CD-RW Not Support	US+ CD-RW Not Support
		DVD+R Max 8X (10,800 KB/sec)	DVD+R Max 8X (10,800 KB/sec)
		DVD-R Max 8X (10,800 KB/sec)	DVD-R Max 8X (10,800 KB/sec)
DVD+RW Max 8X (10,800 KB/sec)		DVD+RW Max 8X (10,800 KB/sec)	
ATAPI interface (MB/s)		MAX 33.2MB/s	MAX 33.2MB/s
Access time (ms) (Random)	CD-ROM	130 ms	130 ms
	DVD-ROM	150 ms	150 ms
Buffer memory		2 M	2 M
Supported disk format	CD	650 MB CD-ROM (Read Only)	650 MB CD-ROM (Read Only)
		80mm CD (Horizontal Mount Only)	80mm CD (Horizontal Mount Only)
		800/700/650/ CD-Recordable (Read & Write)	800/700/650/ CD-Recordable (Read & Write)
		700/650MB CD-Rewritable (Read & Write)	700/650MB CD-Rewritable (Read & Write)
		700/650MB High Speed CD-Rewritable (Read & Write)	700/650MB High Speed CD-Rewritable (Read & Write)
		700/650MB High Speed CD-Rewritable (Read & Write)	700/650MB Ultra & Ultra+ Speed CD-Rewritable (Read only)
		700/650MB Ultra & Ultra+ Speed CD-Rewritable (Read only)	
	DVD	5/9/10/18 G DVD-Single / Dual (PTP, OTP) (Read Only)	5/9/10/18 G DVD-Single / Dual (PTP, OTP) (Read Only)
		4.7G DVD±R/RW (Read & Write)	4.7G DVD±R/RW (Read & Write)

		DVD±R Dual (Read & Write)	DVD±R Dual (Read & Write)
		DVD-RAM (Read & Write)	DVD-RAM (Read & Write)
		80mm DVD	80mm DVD
Parameter		Drive Specification	
		Panasonic	Panasonic
		UJ890ADTJR-A	UJ890EDTJR-A
Data transfer speed	Read (KB/s)	DVD-ROM :Max 8X CAV	DVD-ROM :Max 8X CAV
		CD-ROM :Max 24X CAV	CD-ROM :Max 24X CAV
	Write	CD-R :Max24X CAV	CD-R :Max24X CAV
		CD-RW :4X CLV	CD-RW :4X CLV
		High Speed CD-RW :10XCLV	High Speed CD-RW :10XCLV
		Ultra Speed CD-RW :Max 24X Zone CLV	Ultra Speed CD-RW :Max 24X Zone CLV
		DVD-R :Max.8X CAV	DVD-R :Max.8X CAV
		DVD-R DL :Max.6X Zone CLV	DVD-R DL :Max.6X Zone CLV
		DVD-RW :Max.6X Zone CLV	DVD-RW :Max.6X Zone CLV
		DVD+R :Max.8X CAV	DVD+R :Max.8X CAV
		DVD+R DL :Max.6X Zone CLV	DVD+R DL :Max.6X Zone CLV
		DVD+RW :Max.8X Zone CLV	DVD+RW :Max.8X Zone CLV
		DVD-RAM :Max.3-5X PCAV (4.7GB)	DVD-RAM :Max.3-5X PCAV (4.7GB)
ATAPI interface (MB/s)	None	None	
Access time (ms) (Random)	CD-ROM	150ms	150ms
	DVD-ROM	180ms	180ms
Buffer memory		1M	1M
Supported disk format	CD	CD-DA,CD-ROM,CD-ROM XA	CD-DA,CD-ROM,CD-ROM XA
		PhotoCD(muiltiSession)	PhotoCD(muiltiSession)
		Video CD,Cd-Extra(CD+),CD-text	Video CD,Cd-Extra(CD+),CD-text
	DVD	DVD-VIDEO, DVD-ROM,	DVD (DVD-5; Single layer, Single side 4.7Gbytes)
		DVD-R(4.7GB), DVD-R DL	DVD-VIDEO, DVD-ROM,
		DVD-RW(Ver.1.1/1.2)	DVD-R(4.7GB), DVD-R DL
		DVD+R, DVD+R DL, DVD+RW	DVD-RW(Ver.1.1/1.2)
		DVD-RAM(4.7GB)	DVD+R, DVD+R DL, DVD+RW
	DVD-RAM(4.7GB)		

Table 1-9-3 DVD super multi drive specifications

1.9.2 Blue Ray ODD

The dimensions and specifications of the DVD Super Multi drive are described in Table 1-9-4, Table 1-9-5

Parameter		Standard Value	
Outline dimension	Maker	Panasonic	Panasonic
		UJ240EBTJR-A	UJ141EBTJR-A
	Width (mm)	128	128
	Height (mm)	12.7	12.7
	Depth (mm)	129	129
	Mass (g)	185+/-10	185+/-10

Table 1-9-4 Blue ray ODD dimensions

Parameter		Drive Specification	
		Panasonic	Panasonic
		UJ240EBTJR-A	UJ141EBTJR-A
Data transfer speed	Read (KB/s)	DVD-ROM :Max 8X CAV	DVD-ROM :Max 8X CAV
		CD-ROM :Max 24X CAV	CD-ROM :Max 24X CAV
		BD-ROM :1.6x CLV(for Video)/Max 6X CAV(for Data)	BD-ROM :1.6x CLV(for Video)/Max 6X CAV(for Data)
	Write	CD-R :Max.24X Zone CLV	CD-R :Max.24X Zone CLV
		CD-RW :4X CLV	CD-RW :4X CLV
		High Speed CD-RW :10XCLV	High Speed CD-RW :10XCLV
		Ultra Speed CD-RW :Max 16X Zone CLV	Ultra Speed CD-RW :Max 16X Zone CLV
		Ultra Speed CD-RW	Ultra Speed CD-RW
		:NoSupport	:No Support
		DVD-R :Max.8X CAV	DVD-R :Max.8X CAV
DVD-R DL :Max.4X Zone CLV	DVD-R DL :Max.4X Zone CLV		
DVD-RW :Max.6X Zone CLV	DVD-RW :Max.6X Zone CLV		

		DVD+R :Max.8X CAV	DVD+R :Max.8X CAV
		DVD+R DL :Max.4X Zone CLV	DVD+R DL :Max.4X Zone CLV
		DVD+RW :Max.8X Zone CLV	DVD+RW :Max.8X Zone CLV
		DVD-RAM :3X-5X PCAV (4.7GB)	DVD-RAM :3X-5X PCAV (4.7GB)
		BD-R :6X CAV (SL), 4XPCAV (DL)	
		BD-RE :2X CLV (SL), 2XCLV (DL)	
	ATAPI interface (MB/s)	150 Mbyte/s	150 Mbyte/s
Access time (ms) (Random)	CD-ROM	180ms	180ms
	DVD-ROM	190ms	190ms
Buffer memory		2M	2M
Supported disk format	CD	CD-DA,CD-ROM,CD-ROM XA	CD-DA,CD-ROM,CD-ROM XA
		PhotoCD(multiSession)	PhotoCD(multiSession)
		Video CD,CD-Extra(CD+),CD-text	Video CD,CD-Extra(CD+),CD-text
		Hybrid SACD	Hybrid SACD
	DVD	DVD-VIDEO, DVD-ROM,	DVD-VIDEO, DVD-ROM,
		DVD-R(4.7GB),	DVD-R(4.7GB),
		DVD-RW(Ver.1.1/1.2) , DVD-RAM	DVD-RW(Ver.1.1/1.2) , DVD-RAM
DVD+R, DVD+R DL, DVD+RW		DVD+R, DVD+R DL, DVD+RW	
	DVD-R DL	DVD-R DL	

Table 1-9-5 Blue ray ODD specifications

2.1 Troubleshooting

Chapter 2 describes how to determine which Field Replaceable Unit (FRU) in the computer is causing the computer to malfunction.

The FRUs covered are:

- | | | |
|------------------------|-----------------|------------------------|
| 1. Power supply | 7. LAN | 13. 3G |
| 2. System Board | 8. Wireless LAN | 14. Camera |
| 3. SATA HDD/SSD | 9. Sound | 15. Microphone |
| 4. Keyboard | 10. Bluetooth | 16. Ext CRT |
| 5. Touch pad | 11. HDMI | 17. USB Board |
| 6. Display | 12. Memory | 18. LED |
| 19. Optical Disk Drive | 20. Modem | 21. 3 in 1 Card Reader |

The Test Program operations are described in Chapter 3. Detailed replacement procedures are described in Chapter 4.

NOTE: *After replacing the system board or CPU, it is necessary to execute the subtest 01 initial configuration of the 3.3 setting of the hardware configuration in Chapter 3.*

The implement for the Diagnostics procedures is referred to Chapter 3. Also, following implements are necessary:

1. Phillips screwdrivers (For replacement procedures)
2. Implements for debugging port check
 - Toshiba Free-DOS system FD

2.2 Troubleshooting Flowchart

Use the flowchart in Figure 2-2-1 as a guide for determining which troubleshooting procedures to execute. Before going through the flowchart steps, verify the following:

- Ask him or her to enter the password if a password is registered.
- Verify with the customer that Toshiba Windows is installed on the hard disk. Non-Windows operating systems can cause the computer to malfunction.
- Make sure all optional equipment is removed from the computer.

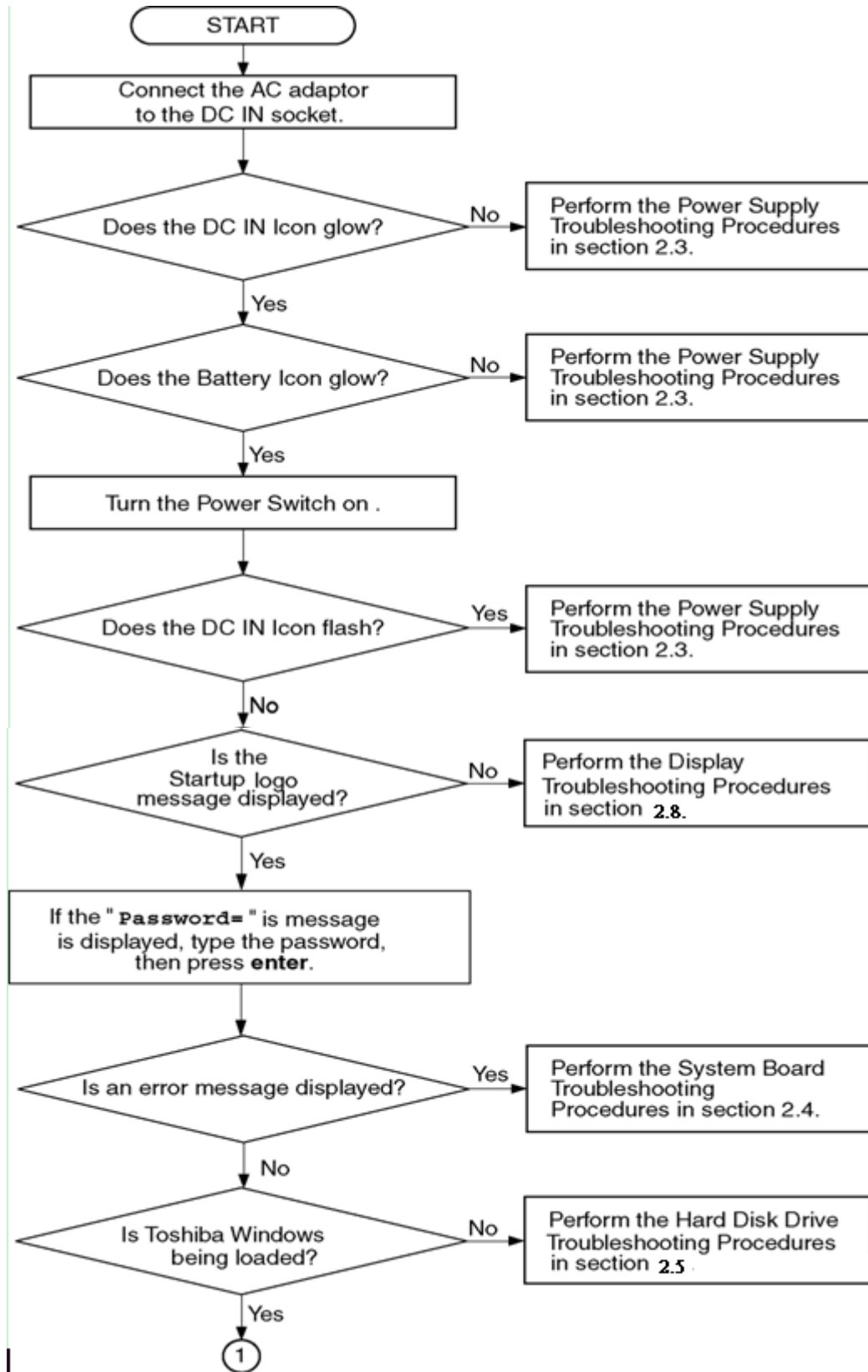

Figure 2-2-1 Troubleshooting flowchart (1/2)

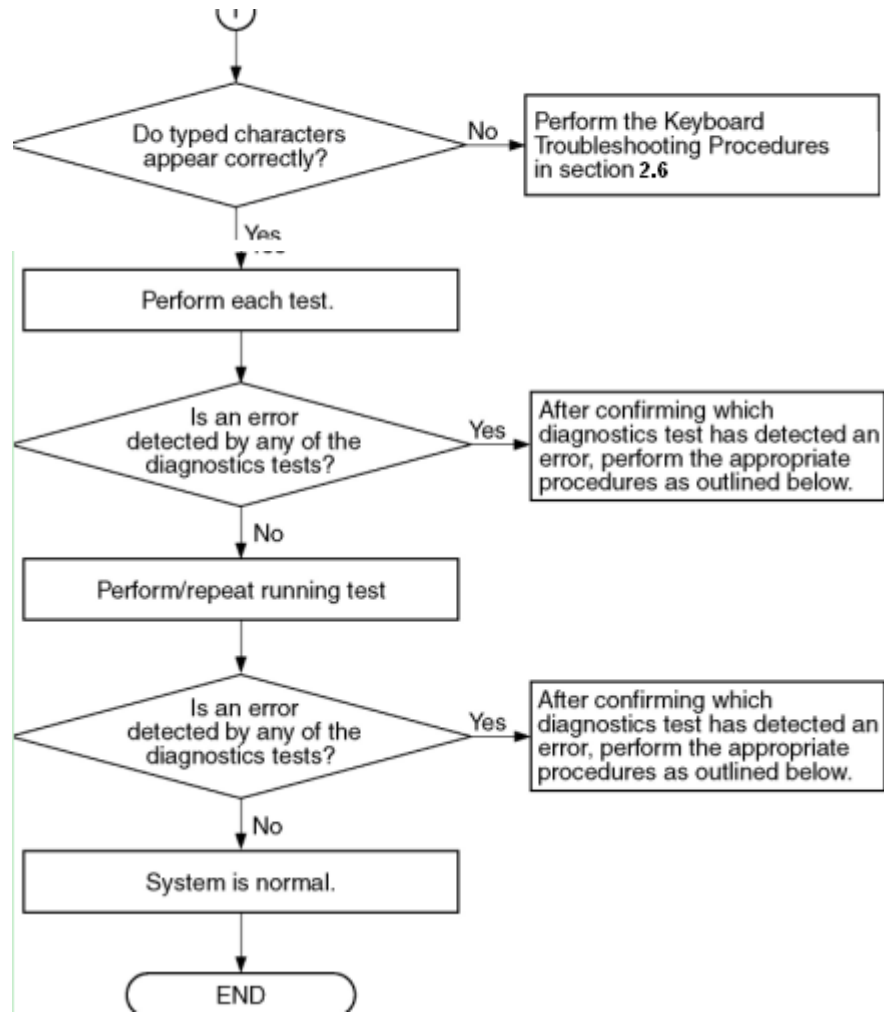

Figure 2-2-1 Troubleshooting flowchart (2/2)

If the diagnostics program cannot detect an error, the problem may be intermittent. The Test program should be executed several times to isolate the problem. Check the Log Utilities function to confirm which diagnostic test detected an error(s), and then perform the appropriate troubleshooting procedures as follows:

1. If an error is detected on the system test, memory test, display test, CD-ROM/DVD-ROM test, expansion test, real timer test, sound test or LAN/Bluetooth test, perform the System Board Troubleshooting Procedures in Section 2.4.
2. If an error is detected on the hard disk test, perform the HDD/SSD/SSD Troubleshooting Procedures in Section 2.5.
3. If an error is found on the keyboard test (DIAGNOSTICS TEST) and pressed key display test, perform the Keyboard Troubleshooting Procedures in Section 2.6.

4. If an error is found on the touch pad test, perform the Touch pad Troubleshooting Procedures in Section 2.7.
5. If an error is detected on the display test, perform the Display Troubleshooting Procedures in Section 2.8.
6. If an error is detected on the LAN test, perform the LAN Troubleshooting Procedures in Section 2.9.
7. If an error is detected on the Wireless LAN test, perform the Wireless LAN Troubleshooting Procedures in Section 2.10.
8. If an error is detected on the sound test, perform the Sound Troubleshooting Procedures in Section 2.11.
9. If an error is detected on the Bluetooth test, perform the Bluetooth Troubleshooting Procedures in Section 2.12.
10. If an error is detected on the HDMI test, perform the HDMI Troubleshooting Procedures in Section 2.13.
11. If an error is detected on the CD-ROM/DVD-ROM test, perform the Optical Disk Drive Troubleshooting Procedures in Section 2.21.
12. If an error is detected on the modem test, perform the Modem Troubleshooting Procedures in Section 2.22.

2.3 Power Supply Troubleshooting

The power supply controller controls many functions and components. To determine if the power supply is functioning properly, start with Procedure 1 and continue with the other Procedures as instructed. The procedures described in this section are:

Procedure 1: Power Status Check

Procedure 2: Connection Check

Procedure 3: Charging Check

Procedure 4: Replacement Check

Procedure 1 Power Status Check

The following LED indicates the power supply status:

Battery LED

DC IN LED

The Power Supply control displays the power supply status with the Battery LED and the DC IN LED as listed in the tables below.

Battery icon	Power supply status
Lights orange	Battery is charged and the external DC is input. It has no relation with ON/OFF of the system power.
Lights blue	Battery is fully charged and the external DC is input. It has no relation with ON/OFF of the system power.
Blinks orange (even intervals)	The battery level is low while the system power is ON.
Blinks orange once (at being switched on)	The system is driven by only a battery and the battery level is low.
Doesn't light	Any condition other than those above.

Table 2-3-1 Battery icon

DC IN icon	Power supply status
Lights blue	DC power is being supplied from the AC adapter.
Blinks orange	Power supply malfunction**1
Doesn't light	Any condition other than those above.

Table 2-3-2 DC IN icon

*1 When the power supply controller detects a malfunction, the DC IN icon blinks orange and perform the following procedure.

When the icon is blinking, perform the following procedure.

1. Remove the battery pack and the AC adapter.
2. Re-attach the battery pack and the AC adapter.

If the icon is still blinking after the operation above, check the followings:

Check 1 If the DC IN icon blinks orange, go to Procedure 2.

Check 2 If the DC IN icon does not light, go to Procedure 3.

Check 3 If the battery icon does not light orange or green, go to Procedure 4.

NOTE: Use a supplied AC adapter.

Procedure 2 Connection Check

The wiring diagram related to the power supply is shown below:

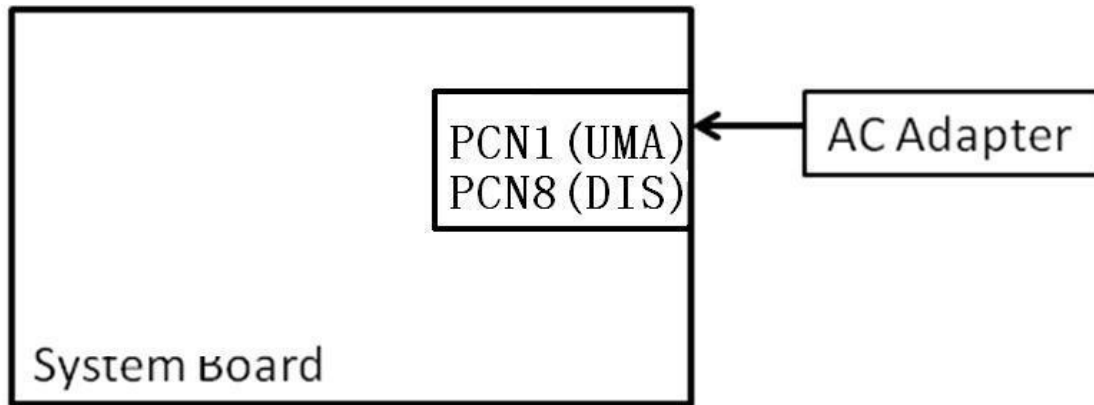

Any of the connectors may be disconnected. Perform Check 1.

Check 1 Make sure the AC adapter and the AC power cord is firmly plugged into the DC IN connector PCN1/PCN8 (System Board) and wall outlet. If these cables are connected firmly, go to Check 2.

Check 2 Replace the AC adapter and the AC power cord with new ones.

- If the DC IN icon does not light, go to Procedure 4.
- If the battery icon does not light, go to Check 3.

Check 3 Make sure the battery pack is installed in the computer correctly. If the battery is properly installed and the battery icon still does not light, go to Procedure 4.

Procedure 3 Charging Check

Check if the power supply controller charges the battery pack properly. Perform the following procedures:

Check 1 Make sure the AC adapter is firmly plugged into the DC IN socket.

Check 2 Make sure the battery pack is properly installed. If it is properly installed, go to Check 3.

Chapter 2 Troubleshooting Procedures

- Check 3 The battery pack may be completely discharged. Wait a few minutes to charge the battery pack while connecting the battery pack and the AC adapter. If the battery pack is still not charged, go to Check 4.
- Check 4 The battery's temperature is too high or low. Leave the battery for a while to adjust it in the right temperature. If the battery pack is still not charged, go to Check 5.
- Check 5 Replace the battery pack with a new one. If the battery pack is still not charged, go to Procedure 4.

Procedure 4 Replacement Check

The power is supplied to the system board by the AC adapter. If either the AC adapter or the system board was damaged, perform the following Checks.

To disassemble the computer, follow the steps described in Chapter 4, *Replacement Procedures*.

When AC adapter is connected;

Check 1 AC adapter may be faulty. Replace the AC adapter with a new one. If the problem still occurs, perform Check 2.

Check 2 System board may be faulty. Replace the system board with a new one.

When AC adapter is not connected ;
(When driving with battery pack)

Check 1 Battery pack may be faulty. Replace it with a new one. If the problem still occurs, perform Check 2.

Check 2 System board may be faulty. Replace it with a new one.

2.4 System Board Troubleshooting

This section describes how to determine if the system board is malfunctioning or not. Start with Procedure 1 and continue with the other procedures as instructed. The procedures described in this section are:

Procedure 1: Message Check

Procedure 2: Diagnostic Test Program Execution Check

Procedure 3: Replacement Check

Procedure 1 Message Check

When the power is turned on, the system performs the Power on Self Test (POST) installed in the BIOS ROM. The POST tests each IC on the system board and initializes it.

- If an error message is shown on the display, perform Check 1.
- If there is no error message, go to Procedure 2.
- If Free-DOS or Windows XP is properly loaded, go to Procedure 4.

Check 1 If one of the following error messages is displayed on the screen, press the **F2** key as the message instructs. These errors occur when the system configuration preserved in the RTC memory (CMOS type memory) is not the same as the actual configuration or when the data is lost.

If you press the **F2** key as the message instructs, the SETUP screen appears to set the system configuration.

Procedure 2 Diagnostic Test Program Execution Check

Execute the following tests from the Diagnostic Test Menu. These tests check the system board. Refer to Chapter 3, *Tests and Diagnostic*, for more information on how to perform these tests.

1. System test
2. Memory test
3. Keyboard test
4. Display test
5. Hard Disk test
6. CPU Temperature test
7. Main Battery test
8. BIOS test
9. CD-ROM/DVD-ROM test
10. System Status LED test
11. Wireless LAN test
12. LAN/Modem/Sound test
13. UUID test-DMI Information (Write DMI)

If an error is detected during these tests, go to Procedure 4.

Procedure 3 Replacement Check

System board may be faulty. Disassemble the computer following the steps described in Chapter 4, *Replacement Procedures* and replace system board with a new one.

2.5 SATA HDD/SSD Troubleshooting

To check if 2.5" HDD/SSD is malfunctioning or not, follow the troubleshooting procedures below as instructed.

Procedure 1: Partition Check

Procedure 2: Message Check

Procedure 3: Format Check

Procedure 4: Diagnostic Test Program Execution Check

Procedure 5: Connector Check and Replacement Check

CAUTION: *The contents of the hard disk will be erased when the 2.5" HDD/SSD troubleshooting procedures are executed. Transfer the contents of the hard disk to floppy disks or other storage drive(s). For the backup, refer to the User's Manual.*

Procedure 1 Partition Check

Insert the Toshiba Free-DOS system disk and start the computer. Perform the following checks:

- Check 1 Input **C:** and press **Enter**. If you cannot change to drive C, go to Check 2. If you can change to drive C, go to Procedure 2.
- Check 2 Input **FDISK** and press **Enter**. Choose Display Partition Information from the FDISK menu. If drive C is listed in the Display Partition Information, go to Check 3. If drive C is not listed, return to the FDISK menu and choose the option to create a DOS partition or a logical DOS drive on drive C. If the problem still occurs, go to Procedure 2.
- Check 3 If drive C is listed as active in the FDISK menu, go to Check 4. If drive C is not listed as active, return to the FDISK menu and choose the option to set the active partition for drive C. Then go to Procedure 2.
- Check 4 Remove the system disk from the FDD and reboot the computer. If the problem still occurs, go to Procedure 2. Otherwise, the 2.5" HDD/SSD is operating normally.

Procedure 2 Message Check

When the power is turned on, the system performs the Initial Reliability Test (IRT) installed in the BIOS ROM. When the test detects an error, an error message is displayed on the screen.

Make sure no floppy disk is in the FDD. Turn on the computer and check the message on the screen. When an OS starts from the 2.5" HDD/SSD, go to Procedure 3. Otherwise, start with Check 1 below and perform the other checks as instructed.

Check 1 If either of the following messages appears, go to Check 2. If the following messages do not appear, perform Check 3.

```
Insert system disk in drive  
Press any key when ready .....
```

or

```
Non-System disk or disk error  
Replace and press any key when ready
```

Check 2 Using the SYS command of the Free-DOS, transfer the system to the 2.5" HDD/SSD/SSD. If the system is not transferred, go to Procedure 3. Refer to the Free-DOS Manual for detailed operation.

If the following message appears on the display, the system program has been transferred to the HDD/SSD/SSD.

```
System Transferred
```

If an error message appears on the display, perform Check 3.

Check 3 2.5" HDD/SSD (s) and the connector(s) of system board may be defective (Refer to the steps described in Chapter 4, *Replacement Procedures* for disassembling.). Insert HDD/SSD (s) to the connector(s) firmly. If it is (or they are) firmly connected, go to Procedure 3.

Procedure 3 Format Check

The computer's HDD/SSD is formatted using the Free-DOS FORMAT program or the physical format program of the test program. To format the HDD/SSD, start with Check 1 below and perform the other steps as required.

Refer to the Free-DOS Manual for the operation of Free-DOS. For the format by the test program, refer to the Chapter 3.

Check 1 Format an 2.5" HDD/SSD using Free-DOS FORMAT command. Type as **FORMAT C:/S/U**.

 If 2.5" HDD/SSD can not be formatted, perform Check 2.

Check 2 Using the Free-DOS FDISK command, set the 2.5" HDD/SSD partition. If the partition is not set, go to Check 3. If it is set, format 2.5" HDD/SSD using Free-DOS FORMAT command.

Check 3 Using the Diagnostic Disk, format 2.5" HDD/SSD with a format option (physical format). If HDD/SSD is formatted, set the 2.5" HDD/SSD partition using Free-DOS FDISK command.

 If you cannot format 2.5" HDD/SSD using the Tests and Diagnostic program, go to Procedure 4.

Procedure 4 Diagnostic Test Program Execution Check

The HDD/SSD test program is stored in the Diagnostics Disk. Perform all of the HDD/SSD tests in the Hard Disk Drive Test. Refer to Chapter 3, *Tests and Diagnostics*, for more information about the HDD/SSD test program.

If an error is detected during the HDD/SSD test, an error code and status will be displayed. The error codes and statuses are described in Table 2-5-1. If an error code is not displayed but the problem still occurs, go to Procedure 5.

Code	Status
01	Bad Command Error
02	Bad Address Mark Error
04	Record Not Found
05	HDC Not Reset Error
07	Drive Not Initialized
09	DMA Boundary Error
0A	Bad Sector
0B	Bad Track Error
10	ECC Error
11	ECC Recover Enabled
20	HDC Error
40	Seek Error
80	Time Out Error
AA	Drive Not Ready
BB	Undefined Error
CC	Write Fault
E0	Status Error
F0	No Sense Error
??	Other Error

Table 2-5-1 HDD/SSD error code & status

Procedure 5 Connector Check and Replacement Check

HDD/SSD(s) is/are connected to the connector(s) on the system board. The connection of HDD/SSD(s) and board may be defective. Otherwise, they may be faulty. Disassemble the computer following instructions in Chapter 4, *Replacement Procedures* and perform the following checks.

Check 1 Make sure HDD/SSD(s) is/are firmly connected to the connector(s) on the system board.

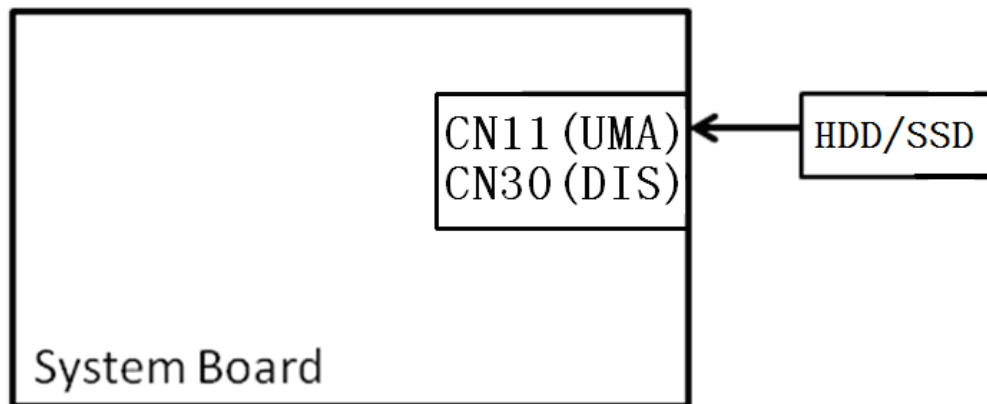

If any of the connections are loose, reconnect firmly and repeat Procedure 1. If the problem still occurs, go to Check 2.

Check 2 (One of) HDD/SSD(s) may be faulty. Replace it with a new one following the instructions in Chapter 4, *Replacement Procedures* and check the operation. If the problem still occurs, perform Check 3.

Check 3 System board may be faulty. Replace it with a new one following the instructions in Chapter 4, *Replacement Procedures*.

2.6 Keyboard Troubleshooting

To check if the computer's keyboard is malfunctioning or not, follow the troubleshooting procedures below as instructed.

Procedure 1: Diagnostic Test Program Execution Check

Procedure 2: Connector and Replacement Check

Procedure 1 Diagnostic Test Program Execution Check

Execute the Keyboard Test (DIAGNOSTIC TEST) and Pressed key display test in the Diagnostic Program. Refer to Chapter 3, *Tests and Diagnostics*, for more information on how to perform the test program.

If an error occurs, go to Procedure 2. If an error does not occur, keyboard is functioning properly.

Procedure 2 Connector and Replacement Check

The connection of cable and board may be defective. Otherwise, they may be faulty. Disassemble the computer following the steps described in Chapter 4, *Replacement Procedures*, and perform the following checks:

Check 1 Make sure keyboard cable is firmly connected to system board.

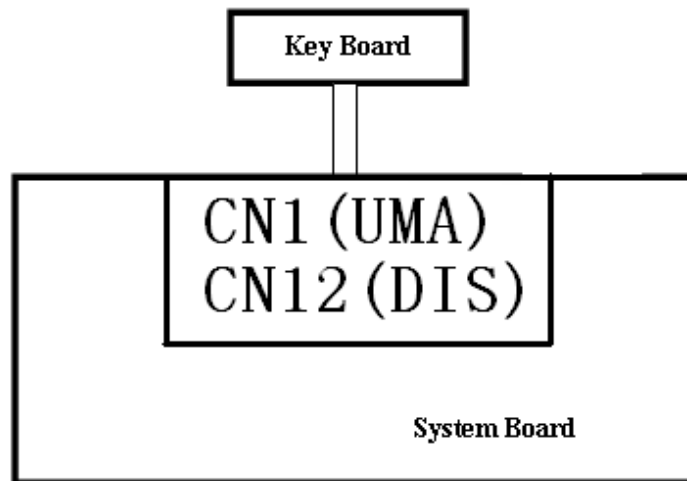

If the connection is loose, reconnect firmly and repeat Procedure 1. If the problem still occurs, go to Check 2.

Check 2 Keyboard may be faulty. Replace it with a new one following the instructions in Chapter 4, *Replacement Procedures*. If the problem still occurs, perform Check 3.

Check 3 System board may be faulty. Replace it with a new one following the instructions in Chapter 4, *Replacement Procedures*.

2.7 Touch pad Troubleshooting

To check if the computer's touch pad is malfunctioning or not, follow the troubleshooting procedures below as instructed.

Procedure 1: Diagnostic Test Program Execution Check

Procedure 2: Connector and Replacement Check

Procedure 1 Diagnostic Test Program Execution Check

Execute the Touch pad test in the Diagnostic Program. Refer to Chapter 3, *Tests and Diagnostics*, for more information on how to perform the test program.

If an error occurs, go to Procedure 2. If an error does not occur, Touch pad is functioning properly.

Procedure 2 Connector and Replacement Check

The connection of cable and board may be defective. Otherwise, they may be faulty. Disassemble the computer following the steps described in Chapter 4, *Replacement Procedures*, and perform the following checks:

Check 1 Make sure the cable is firmly connected to system board.

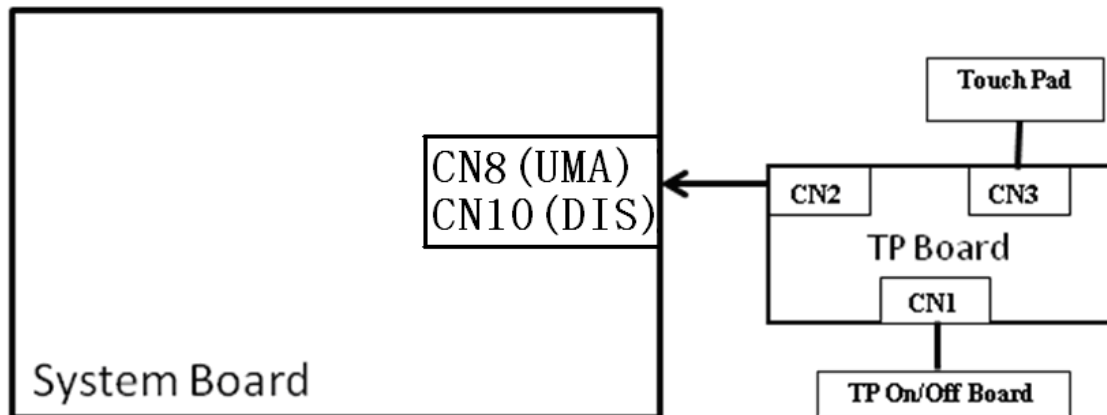

If the connection is loose, reconnect firmly and repeat Procedure 1. If the problem still occurs, go to Check 2.

Check 2 Touch Pad or the cable may be faulty. Replace it with a new one following the instructions in Chapter 4, *Replacement Procedures*. If the problem still occurs, perform Check 3.

Check 3 System board may be faulty. Replace it with a new one following the instructions in Chapter 4, *Replacement Procedures*

2.8 Display Troubleshooting

To check if the computer's display is malfunctioning or not, follow the troubleshooting procedures below as instructed.

Procedure 1: External Monitor Check

Procedure 2: Diagnostic Test Program Execution Check

Procedure 3: Connector and Cable Check

Procedure 4: Replacement Check

Procedure 1 External Monitor Check

Connect an external monitor to the computer's external monitor port, then boot the computer. The computer automatically detects the external monitor.

When "Power on Display" setting is "Auto-Selected" (Default) in BIOS Setup Menu. If this setting is "System LCD only", external monitor cannot be displayed. The computer automatically detects the external monitor.

If the external monitor works correctly, the internal LCD may be faulty. Go to Procedure 3.

If the external monitor appears to have the same problem as the internal monitor, system board may be faulty. Go to Procedure 2.

Procedure 2 Diagnostic Test Program Execution Check

The Display Test program is stored in Diagnostics disk. This program checks the display controller on system board. Insert the Diagnostics disk, turn on the computer and run the test. Refer to Chapter 3, *Tests and Diagnostics* for details. If an error is detected, go to Procedure 3.

Procedure 3 Connector and Cable Check

LCD Module is connected to system board by an LCD. Their cables may be disconnected from system board. Disassemble the computer following the steps described in Chapter 4, *Replacement Procedures*.

If the connection is loose, reconnect firmly and restart the computer. If the problem still occurs, go to Procedure 4.

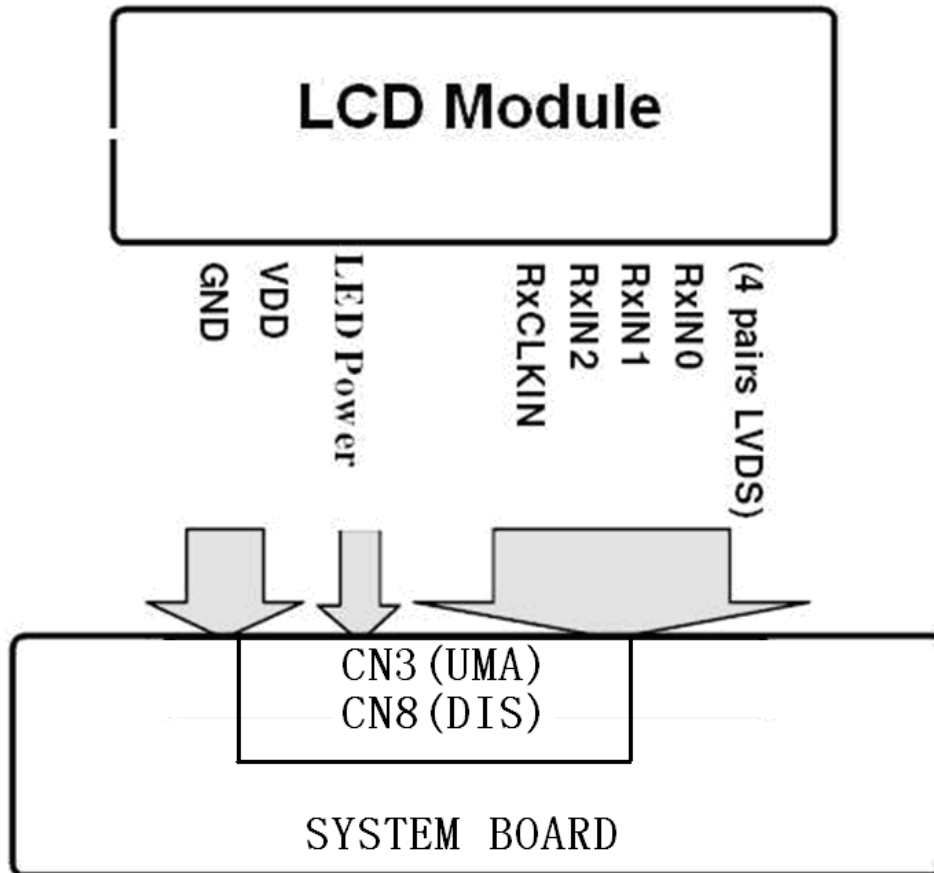

Procedure 4 Replacement Check

LCD module, LCD cable are connected to display circuits. Any of these components may be faulty. Refer to Chapter 4, *Replacement Procedures*, for instructions on how to disassemble the computer and then perform the following checks:

If characters or graphics on the internal display are not displayed clearly, perform Check 1.

If some screen functions do not operate properly, perform Check 2.

If LED backlight remains lit when the display is closed, perform Check 3.

- Check 1 LCD cable may be faulty. Replace LCD cable with a new one following the instructions in Chapter 4, *Replacement Procedure* and test the display again. If the problem still occurs, perform Check 2.
- Check 2 LCD module may be faulty. Replace LCD module with a new one following the instructions in Chapter 4, *Replacement Procedure* and test the display again. If the problem still occurs, perform Check 3.
- Check 3 System board may be faulty. Replace it with a new one following the instructions in Chapter 4, *Replacement Procedure*.

2.9 LAN Troubleshooting

To check if the computer's LAN is malfunctioning or not, follow the troubleshooting procedures below as instructed.

Procedure 1: Diagnostic Test Program Execution Check

Procedure 2: Connector Check and Replacement Check

Procedure 1 Diagnostic Test Program Execution Check

Execute LAN test in the LAN test program. Refer to Chapter 3, *Tests and Diagnostics* for more information on how to perform the test program.

If any error is detected by the test, go to Procedure 2.

Procedure 2 Connector Check and Replacement Check

The LAN function is embedded on system board. If LAN malfunctions, its connection is defective or LAN cable and system board may be faulty.

Check 1 Make sure LAN cable is firmly connected to the connector CN12. If the problem still occurs, perform Check 2.

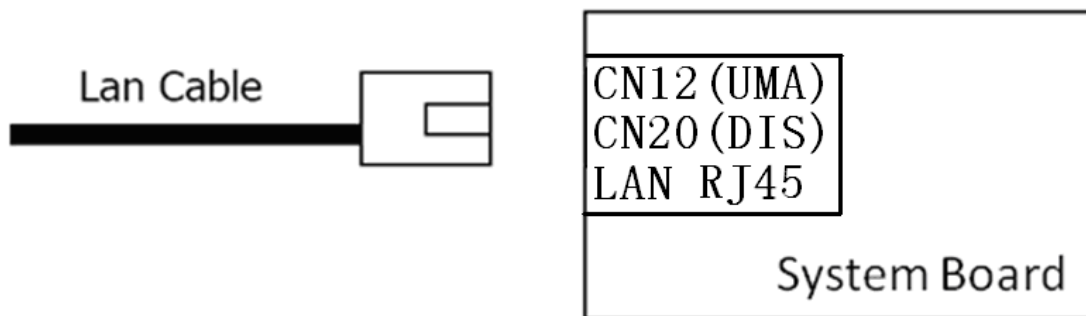

No Separated LAN BOARD , it's assembled.

Check 2 LAN cable may be faulty. Replace it with a new one. If the problem still occurs, perform Check 3.

Check 3 System board may be faulty. Replace it with a new one following the instruction in Chapter 4.

2.10 Wireless LAN Troubleshooting

To check if the computer's Wireless LAN is malfunctioning or not, follow the troubleshooting procedures below as instructed.

Procedure 1: Transmitting-Receiving Check

Procedure 2: Antennas' Connection Check

Procedure 3: Replacement Check

Procedure 1 Transmitting-Receiving Check

Before starting the test, make sure the wireless communication switch is set in the ON position.

Check 1 Execute Wireless LAN test program to check the transmitting-receiving function of wireless LAN. You will need a second computer that can communicate by wireless LAN. Perform the test following the instructions described in Chapter 3.

If the computer passes the test, the function is correctly working. If the computer does not pass the test, perform Procedure 2.

Procedure 2 Antennas' Connection Check

The wireless LAN function-wiring diagram is shown below:

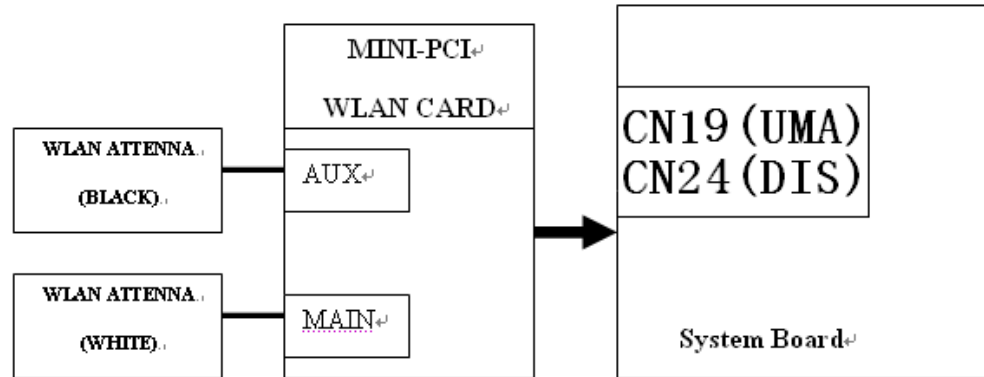

Any of the connections may be defective. Disassemble the computer following the steps described in Chapter 4, *Replacement Procedures*, and perform the following checks:

- Check 1 Make sure the wireless communication switch is “On”.
 If the switch is “Off”, turn it “On”. If the problem still occurs, perform Check 2.
- Check 2 Make sure wireless LAN card (Mini-PCI) is firmly connected to the CN16 on system board. If the connector is defective, connect it firmly and perform Procedure 1. If the problem still occurs, perform Check 3.
- Check 3 Make sure that wireless LAN antenna cables (black and white) are firmly connected to the connectors on Wireless LAN card. If wireless LAN antenna cables are not connected properly, connect them firmly and perform Procedure 1. If the problem still occurs, go to the procedure 3.

Procedure 3 Replacement Check

Wireless LAN card, wireless LAN antenna or system board may be faulty. Refer to Chapter 4, *Replacement Procedures*, for instructions on how to disassemble the computer and then perform the following checks:

- Check 1 Wireless LAN antenna may be faulty. Replace it with a new one following the instructions in Chapter 4, *Replacement Procedures*. If the problem still occurs, perform Check 2.

- Check 2 Wireless LAN card may be faulty. Replace it with a new one following the instructions in Chapter 4, *Replacement Procedures*. If the problem still occurs, perform Check 3.

- Check3 System board may be faulty. Replace it with a new one following the instructions in Chapter 4, *Replacement Procedures*.

2.11 Sound Troubleshooting

To check if the sound function is malfunctioning or not, follow the troubleshooting procedures below as instructed.

Procedure 1: Connector Check

Procedure 2: Replacement Check

Procedure 1 Connector Check

The connection of sound system is shown in the following figure.

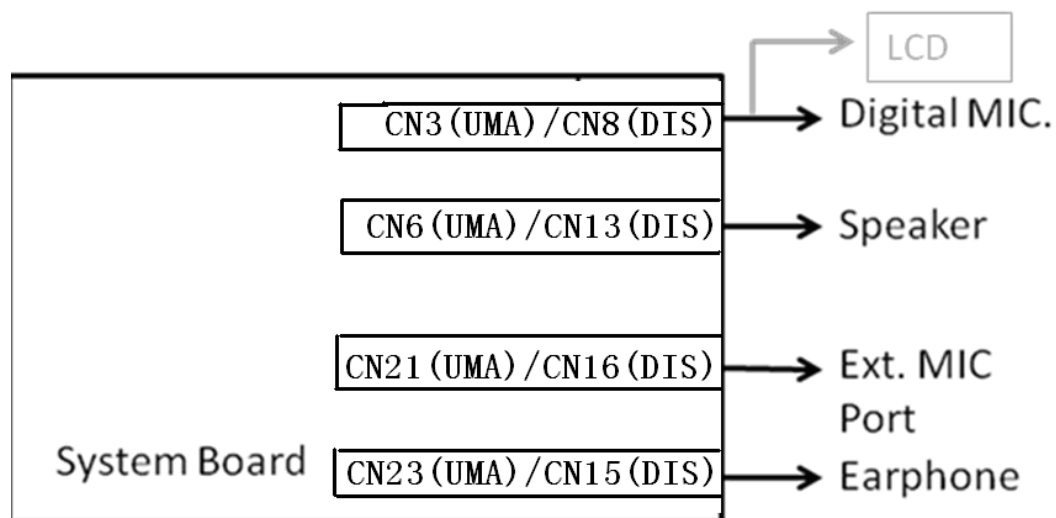

As the connection may be defective, disassemble the PC and check each connection.

If the problem still occurs, go to Procedure 2.

Procedure 2 Replacement Check

- If External microphone/Headphone does not work properly, perform check 1.
- If internal microphone /Speaker do not work properly, perform check 2.
- If HP out does not work properly, perform check 3.
- If Volume control does not work properly, perform check 4.

Check 1 External microphone/Headphone may be faulty. Replace it with a new one following the steps in Chapter 4. If the problem still occurs, perform Check 5.

Check 2 Internal microphone /Speaker may be faulty. Replace it with a new one following the steps in Chapter 4. If the problem still occurs, perform Check 5.

Check 3 HP out may be faulty. Replace it with a new one following the steps in Chapter 4. If the problem still occurs, perform Check 5.

Check 4 Volume control may be faulty. Replace it with a new one following the steps in Chapter 4.

Check 5 Flat cables between LCD and system board may be faulty. Replace it with new cable following the instructions in Chapter 4.

2.12 Bluetooth Troubleshooting

To check if the computer's Bluetooth is malfunctioning or not, follow the troubleshooting procedure below as instructed.

Procedure 1: Connector Check and Replacement Check

Procedure 1 Connector Check and Replacement Check

The Bluetooth module is connected to system board. If Bluetooth malfunctions, its connection is defective or Bluetooth cable and system board may be faulty.

Check 1 Make sure Bluetooth cable is firmly connected to the connector CN7/CN11 (system board). If the problem still occurs, perform Check 2.

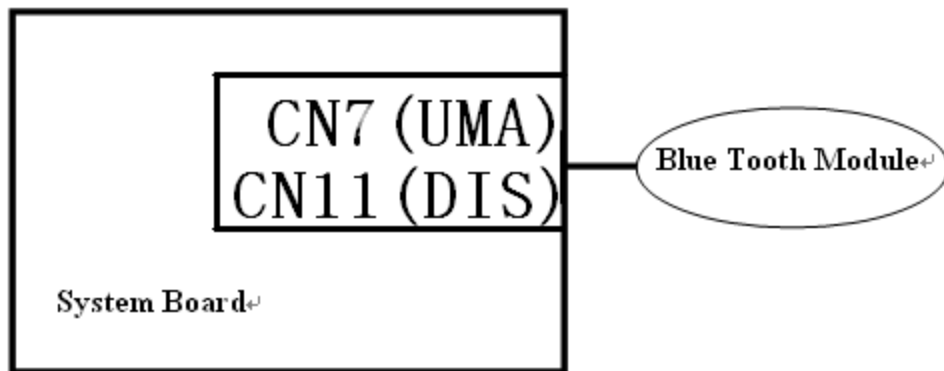

Check 2 Bluetooth cable may be faulty. Replace it with a new one. If the problem still occurs, perform Check 3.

Check 3 Bluetooth module may be faulty. Replace it with a new one following the steps in Chapter 4. If the problem still occurs, perform Check 4.

Check 4 System board may be faulty. Replace it with a new one following the instruction in Chapter 4.

2.13 HDMI Troubleshooting

To check if the computer's HDMI is malfunctioning or not, follow the troubleshooting procedures below as instructed.

Procedure 1: External HDMI Monitor Check

Procedure 2: Connector and Cable Check

Procedure 3: Replacement Check

Procedure 1 Connector Check and Replacement Check

The HDMI port is connected to system board. If HDMI malfunctions, its connection is defective and system board may be faulty.

Check 1 Make sure HDMI cable is firmly connected to the connector CN15/CN17 (system board). If the problem still occurs, perform Procedure 2.

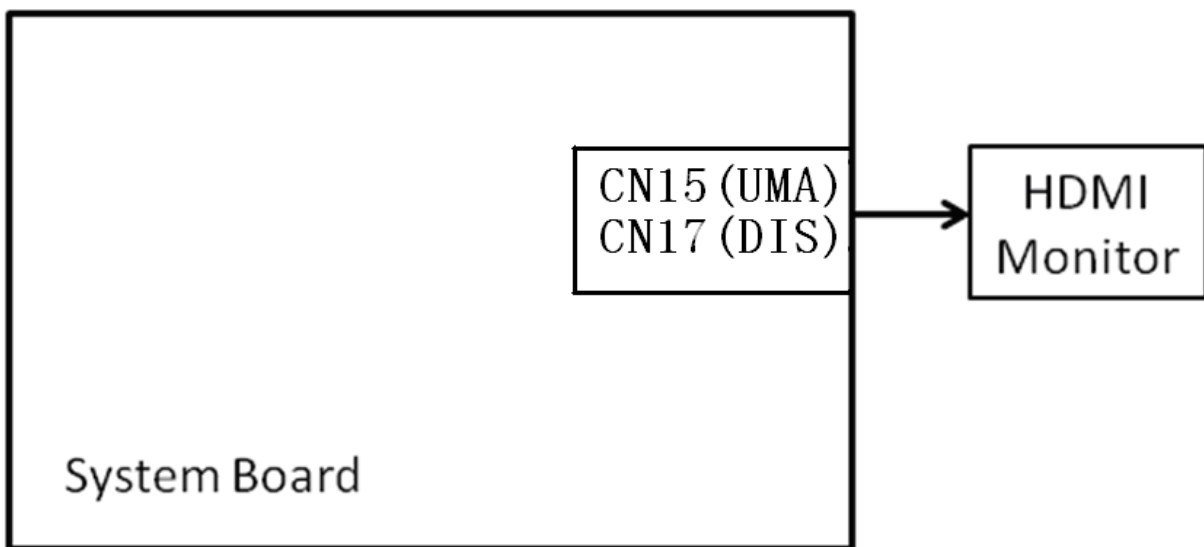

Procedure 2 External Monitor Check

Connect an external monitor to the computer's HDMI port, and then boot the computer. The computer automatically detects the external monitor.

If the external monitor works correctly, the internal LCD may be faulty. Go to Procedure 3.

If the external monitor appears to have the same problem as the internal monitor, system board may be faulty. Go to Procedure 2.

Procedure 3 Connector and Cable Check

HDMI monitor connected to System board by an HDMI cable.

If the connection is loose, reconnect firmly and restart the computer. If the problem still occurs, go to Procedure 4.

Procedure 4 Replacement Check

HDMI signals are connected to display circuits via HDMI cable and HDMI&USB board. Any of these components may be faulty. Refer to Chapter 4, *Replacement Procedures*, for instructions on how to disassemble the computer and then perform the following checks:

If characters or graphics on the internal display are not displayed clearly, perform Check 1.

If some screen functions do not operate properly, perform Check 4.

- Check 1 HDMI cable may be faulty. Replace HDMI cable with a new one following the instructions in Chapter 1, *Replacement Procedure* and test the display again. If the problem still occurs, perform Check 2.
- Check 2 HDMI monitor may be faulty. Replace HDMI monitor with a new one following the instructions in Chapter 2, *Replacement Procedure* and test the display again. If the problem still occurs, perform Check 3
- Check 3 HDMI&USB board may be faulty. Replace it with a new one following the instructions in Chapter 3, *Replacement Procedure*.
- Check 4 System board may be faulty. Replace it with a new one following the instructions in Chapter 4, *Replacement Procedure*.

2.14 Memory Troubleshooting

Memory troubleshooting can following below procedures as instructed.

Procedure 1: Diagnostic Test Program Execution Check

Procedure 2: Connect Check and Replacement Check

Procedure 1 Diagnostic Test Program Execution Check

Execute Memory test in the Memory test program. Refer to Chapter 3, *Tests and Diagnostics* for more information on how to perform the test program.

If any error is detected by the test, go to Procedure 2.

Procedure 2 Connect Check and Replacement Check

Memory function abnormal always accompany CPU run abnormal, the RAM may be not insert correctly or slot is defective or RAM and system board may be faulty.

Check 1 Make sure RAM is correctly and firmly inserted to the slots. If the problem still occurs, perform Check 2.

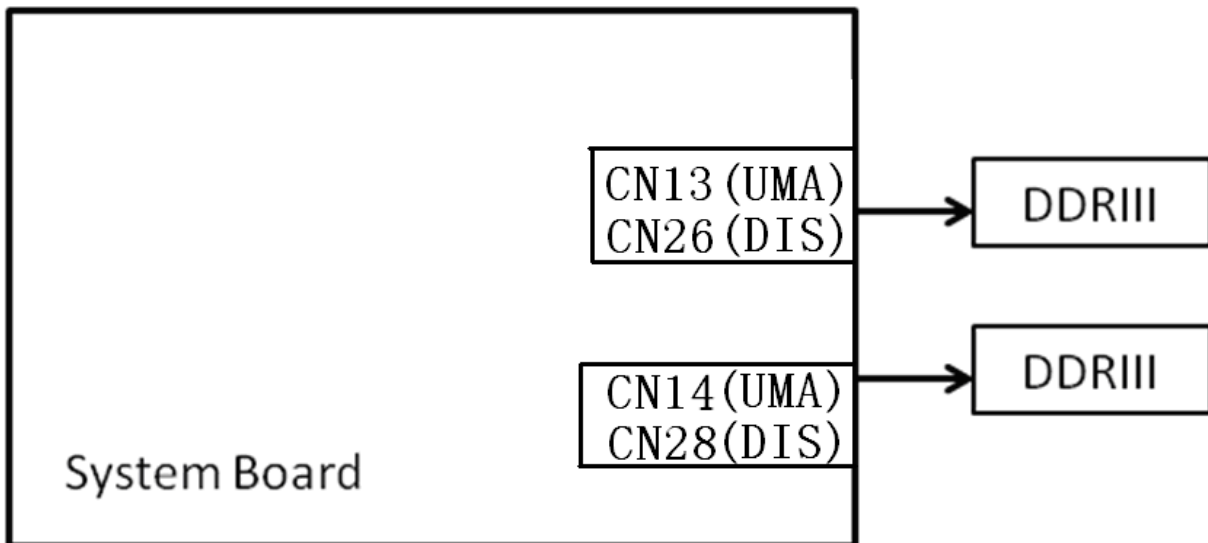

Check 2 RAM may be faulty. Replace it with a new one. If the problem still occurs, perform Check 3.

Check 3 The slot and MB may be faulty. Replace it with a new one following the instruction in Chapter 4.

2.15 3G Troubleshooting

To check if the computer's 3G is malfunctioning or not, follow the troubleshooting procedure below as instructed.

Procedure 1 Connector Check and Replacement Check

The 3G module is connected to system board. If 3G malfunctions, its connection is defective or Antenna and system board may be faulty.

Check 1 Make sure 3G is firmly connected to the connector CN20/CN25 (system board). If the problem still occurs, perform Check 2.

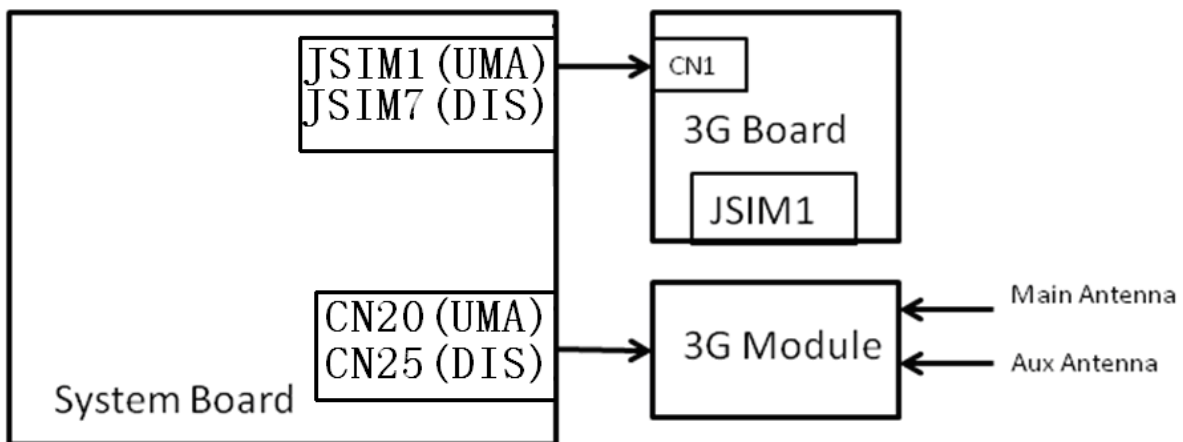

Check 2 Antenna may be faulty. Replace it with new one. If the problem still occurs, perform Check 3.

Check 3 3G card may be faulty. Replace it with a new one following the steps in Chapter 4. If the problem still occurs, perform Check 4.

Check 4 System board may be faulty. Replace it with a new one following the instruction in Chapter 4.

2.16 Camera Troubleshooting

To check if the computer's Camera is malfunctioning or not, follow the troubleshooting procedure below as instructed.

Procedure 1: Camera Execution Check

Procedure 2: Connect Check and Replacement Check

Procedure 1 Camera Execution Check

Open photo/video tool to look if there is an image. If not, go to Procedure 2.

Procedure 2 Connect Check and Replacement Check

The CCD cable is connected to system board integrated with LCD cable. If camera malfunctions, its connection may be defective or LCD/CCD cable and system board may be faulty.

Check 1 Make sure the other side of CCD cable is correctly and firmly inserted to the CN3/CN8 in MB. If the problem still occurs, perform Check 2.

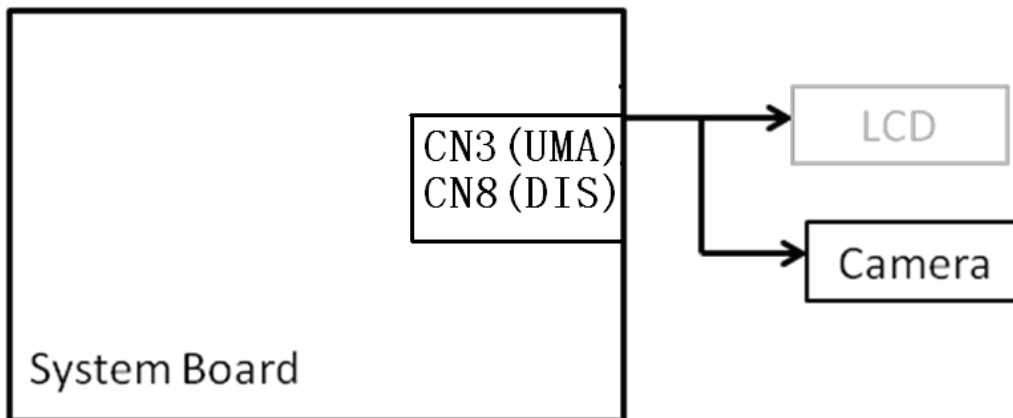

Check 2 CCD cable may be faulty. Replace it with a new one. If the problem still occurs, perform Check 3.

Check 3 Camera may be faulty. Replace it with a new one following the instruction in Chapter 4.

Check 4 System board may be faulty. Replace it with a new one following the instruction in Chapter 4.

2.17 Microphone Troubleshooting

Microphone troubleshooting can following below procedures as instructed.

Procedure 1: Sound Recorder Execution Check

Procedure 2: Connect Check and Replacement Check

Procedure 1 Sound Recorder Execution Check

Open accessory to find sound recorder tool, try to record a length of sound, and then replay it to see if microphone is working normal. If not, go to Procedure 2.

Procedure 2 Connect Check and Replacement Check

The Microphone is combined with CCD cable which is connected to system board. If microphone malfunctions, its connection may be defective or CCD cable and system board may be faulty.

Check 1 Make sure the other side of CCD cable is correctly and firmly inserted to the CN1 in MB. If the problem still occurs, perform Check 2.

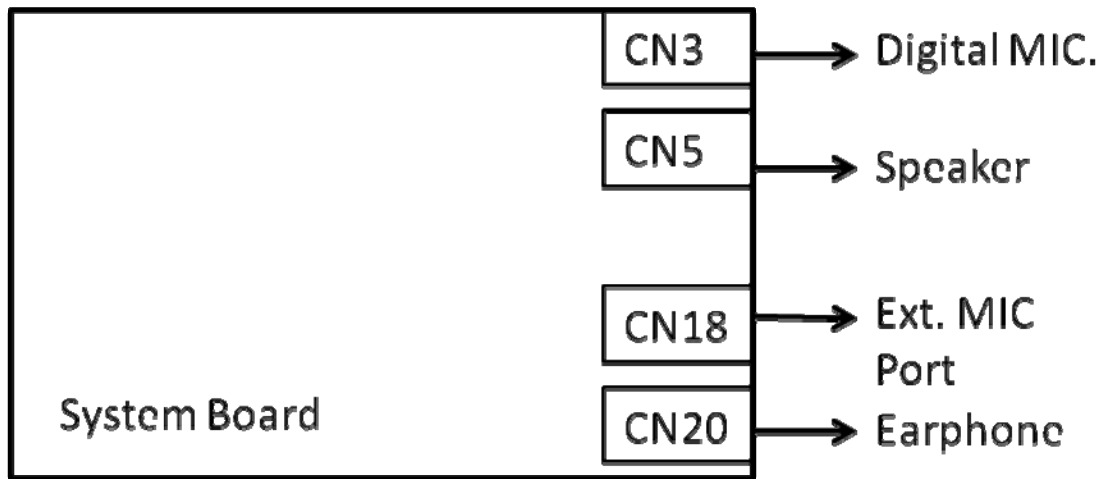

Check 2 CCD cable or Microphone may be faulty. Replace it with a new one. If the problem still occurs, perform Check 3.

Check 3 System board may be faulty. Replace it with a new one following the instruction in Chapter 4.

2.18 CRT Troubleshooting

To check if the computer's CRT is malfunctioning or not, follow the troubleshooting procedures below as instructed.

Procedure 1: External Monitor Check

Procedure 2: Connector and Cable Check

Procedure 3: Replacement Check

Procedure 1 External Monitor Check

Connect an external monitor to the computer's external CRT port, and then to see if you can transfer video image to external monitor. If not, go procedure2.

Procedure 2 Connector and Cable Check

CRT board is connected to system board by a CRT cable. Their cables may be disconnected from system board. Disassemble the computer following the steps described in Chapter 4, *Replacement Procedures*.

If the connection is loose, reconnect firmly and restart the computer. If the problem still occurs, go to Procedure 3.

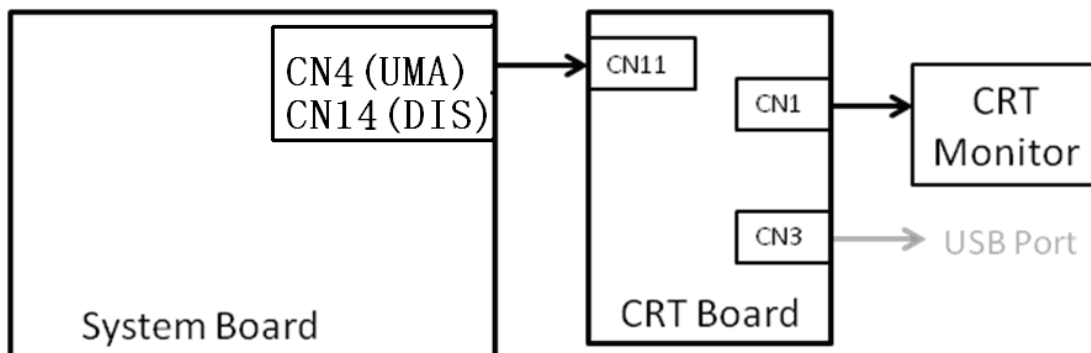

Procedure 3 Replacement Check

- Check 1 CRT cable may be faulty. Replace CRT cable with a new one following the instructions in Chapter 4--*Replacement Procedure*, and then test again. If the problem still occurs, perform Check 2.
- Check 2 CRT board may be faulty. Replace CRT board with a new one following the instructions in Chapter 4, *Replacement Procedure*, and then test again. If the problem still occurs, perform Check 3.
- Check 3 System board may be faulty. Replace it with a new one following the instructions in Chapter 4, *Replacement Procedure*.

2.19 USB Board Troubleshooting

Flatiron carries 3 USB port. To check if the computer's USB port is malfunctioning or not, follow the troubleshooting procedures below as instructed.

Procedure 1: Diagnostic Test Program Execution Check

Procedure 2: Connect Check and Replacement Check

Procedure 1 Diagnostic Test Program Execution Check

Execute USB test in the USB test program.

If any error is detected by the test, go to Procedure 2.

Procedure 2 Connect Check and Replacement Check

Right side USB port is connected to system board with CRT Board by CRT cable. This cable may be disconnected from system board. Disassemble the computer following the steps described in Chapter 4, *Replacement Procedures*.

Check 1 Make sure CRT cable is correctly and firmly inserted. If the problem still occurs, perform Check 2.

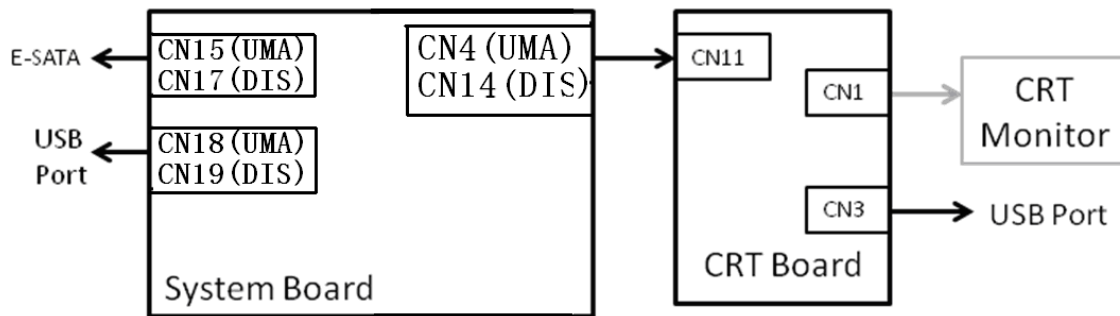

Check 2 CRT/B may be faulty. Replace it with a new one. If the problem still occurs, perform Check 3.

Check 3 The system board may be faulty. Replace it with a new one following the instruction in Chapter 4.

2.20 LED Troubleshooting

These are 6 LED lights at Top assy. From left to right, the Open statuses of them represent functions as below.

1. AC-IN
2. Power
3. Battery
4. HDD/SSD
5. Card Reader
6. W-Lan

To check if the computer's LED is malfunctioning or not, follow the troubleshooting procedures below as instructed.

Procedure 1: Each function Execution Check

Procedure 2: Connect Check and Replacement Check

Procedure 1 Each function Execution Check

In this procedure, you must first make sure all components except LED are working right. Then you can execute the related function to check if the corresponding LED is on or not. If not, please go to Procedure2.

Procedure 2 Connect Check and Replacement Check

LED light is built on system board; the system board may be faulty. Disassemble the computer following the steps described in Chapter 4, *Replacement Procedures*.

Check 1 The system board may be faulty. Replace it with a new one following the instruction in Chapter 4.

2.22 Optical Disk Drive Troubleshooting

To check if optical disk drive is malfunctioning or not, follow the troubleshooting procedures below as instructed.

Procedure 1: Diagnostic Test Program Execution Check

Procedure 2: Connector Check and Replacement Check

Procedure 1 Diagnostic Test Program Execution Check

Execute the CD-ROM/DVD-ROM Test in the Diagnostic Program. Refer to Chapter 3, *Tests and Diagnostics* for more information on how to perform the test program.

Prepare the tools before the test.

If any error is detected by the test, go to Procedure 2.

Procedure 2 Connector Check and Replacement Check

The connection of optical disk drive and system board may be defective. Otherwise, they may be faulty. Disassemble the computer following the steps described in Chapter 4 and perform the following checks:

Check 1 Make sure optical disk drive is firmly connected to the connector on system board.

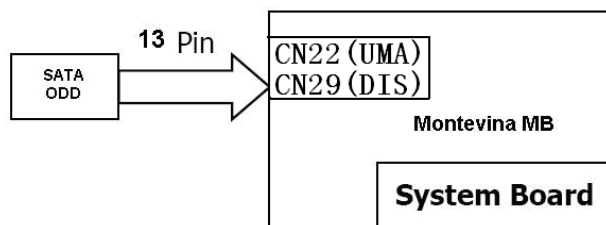

If the connection is loose, reconnect it firmly and return to Procedure 2. If the problem still occurs, perform Check 2.

Check 2 Optical disk drive may be faulty. Replace it with a new one following the steps in Chapter 4. If the problem still occurs, perform Check 3.

Chapter 2 Troubleshooting Procedures

Check 3 System board may be faulty. Replace it with new one following the instructions in Chapter 4.

2.22 Modem Troubleshooting

To check if modem is malfunctioning or not, follow the troubleshooting procedures below as instructed.

Procedure 1: Diagnostic Test Program Execution Check

Procedure 2: Connector Check and Replacement Check

Procedure 1 Diagnostic Test Program Execution Check

Execute Modem test in the LAN/Modem/Bluetooth/IEEE1394 test program. Refer to Chapter 3, *Tests and Diagnostics* for more information on how to perform the test program.

If any error is detected, perform Procedure 2.

Procedure 2 Connector Check and Replacement Check

MDC (Modem Daughter Card) is used as the modem for this computer. MDC is connected to system board by connector CN10/CN27. If modem malfunctions, the connection of cable, board and module may be defective. Otherwise, they may be faulty.

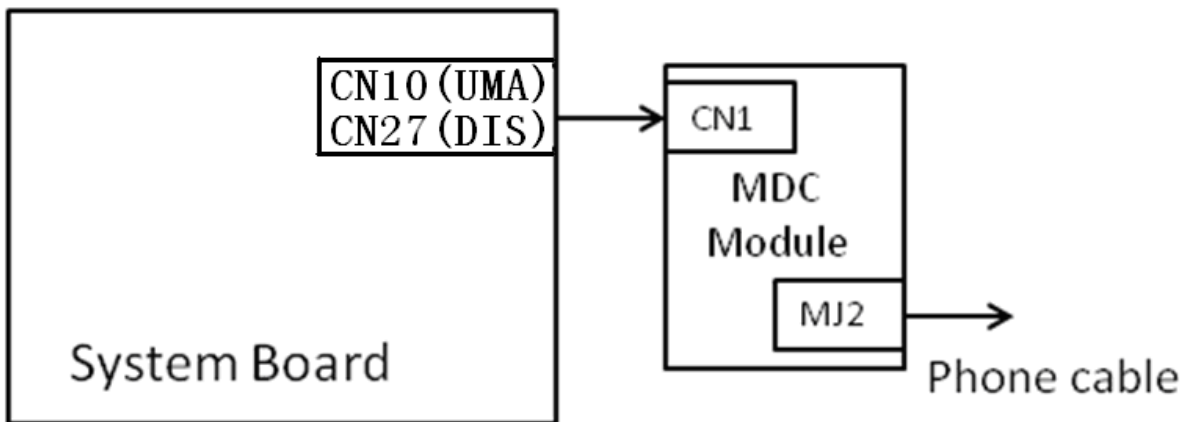

Disassemble the computer following the steps described in Chapter 4 and perform the following checks:

Check 1 Make sure the following connections are firmly connected.

If any connector is disconnected, connect it firmly and return to Procedure 1. If the problem still occurs, perform Check 2.

Chapter 2 Troubleshooting Procedures

- Check 2 Modem cable may be faulty. Replace it with a new one. If the problem still occurs, perform Check 3.
- Check 3 MDC may be faulty. Replace it with a new one following the steps in Chapter 4. If the problem still occurs, perform Check 4.
- Check 4 Cable between MDC and system board may be faulty. Replace it with a new one following the instructions in Chapter 4. If the problem still occurs, perform Check 5.
- Check 6 System board may be faulty. Replace it with a new one following the instruction in Chapter 4.

2.23 3 in 1 Card Reader Troubleshooting

To check if the computer's 3 In 1 Card Reader is malfunctioning or not, follows the troubleshooting procedures below as instructed.

Procedure 1: Media Card Check

Procedure 2: Connector Check and Replacement Check

Procedure 1 Media Card Check

The media Card maybe fault, so please change a new media card and re-test the 3 in 1 card reader to check if the card reader is malfunctioning or not.

If any error is detected, perform Procedure 2.

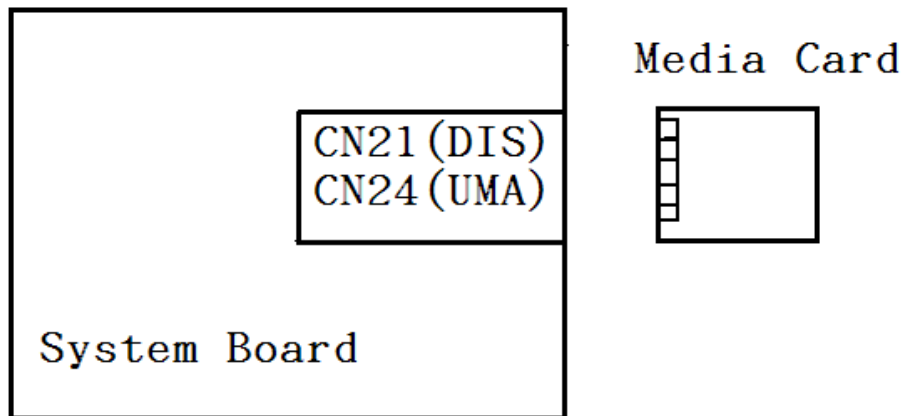

Procedure 2 Connector Check and Replacement Check

The 3 in 1 card reader function is embedded on system board. If card reader malfunctions, its connection is defective or media card and system board may be faulty.

Check 1 make sure push the media card into card reader absolute. If the problem still occurs, perform Check2

Check 2 System board may be faulty. Replace it with a new one following the instruction in Chapter 4.

Chapter 2

Troubleshooting Procedures

Chapter 2 Contents

2.1	Troubleshooting	1
2.2	Troubleshooting Flowchart.....	2
2.3	Power Supply Troubleshooting.....	7
	Procedure 1 Power Status Check	7
	Procedure 2 Connection Check.....	9
	Procedure 3 Charging Check	9
	Procedure 4 Replacement Check	11
2.4	System Board Troubleshooting.....	12
	Procedure 1 Message Check	13
	Procedure 2 Diagnostic Test Program Execution Check	14
	Procedure 3 Replacement Check	14
2.5	SATA HDD/SSD Troubleshooting.....	15
	Procedure 1 Partition Check.....	15
	Procedure 2 Message Check	16
	Procedure 3 Format Check.....	17
	Procedure 4 Diagnostic Test Program Execution Check	18
	Procedure 5 Connector Check and Replacement Check.....	19
2.6	Keyboard Troubleshooting	20
	Procedure 1 Diagnostic Test Program Execution Check	20
	Procedure 2 Connector Check and Replacement Check.....	21
2.7	Touch pad Troubleshooting	22
	Procedure 1 Diagnostic Test Program Execution Check	22
	Procedure 2 Connector Check and Replacement Check.....	23

Chapter 2 Troubleshooting Procedures

2.8	Display Troubleshooting.....	24
	Procedure 1 External Monitor Check.....	24
	Procedure 2 Diagnostic Test Program Execution Check	24
	Procedure 3 Connector and Cable Check.....	25
	Procedure 4 Replacement Check	26
2.9	LAN Troubleshooting.....	27
	Procedure 1 Diagnostic Test Program Execution Check	27
	Procedure 2 Connector Check and Replacement Check.....	27
2.10	Wireless LAN Troubleshooting.....	28
	Procedure 1 Transmitting-Receiving Check	28
	Procedure 2 Antennas' Connection Check	29
	Procedure 3 Replacement Check	30
2.11	Sound Troubleshooting.....	31
	Procedure 1 Connector Check.....	31
	Procedure 2 Replacement Check	32
2.12	Bluetooth Troubleshooting	33
	Procedure 1 Connector Check and Replacement Check.....	33
2.13	HDMI Troubleshooting	34
	Procedure 1 Connector Check and Replacement Check.....	34
	Procedure 2 External Monitor Check.....	34
	Procedure 3 Connector and Cable Check.....	35
	Procedure 4 Replacement Check.....	36
2.14	Memory Troubleshooting	37
	Procedure 1 Diagnostic Test Program Execution Check	37
	Procedure 2 Connect Check and Replacement Check.....	37
2.15	3G Troubleshooting	38
	Procedure 1 Connector Check and Replacement Check.....	38
2.16	Camera Troubleshooting.....	39
	Procedure 1 Camera Execution Check.....	39
	Procedure 2 Connect Check and Replacement Check.....	39

Chapter 2 Troubleshooting Procedures

2.17	Microphone Troubleshooting.....	40
	Procedure 1 Sound Recorder Execution Check	40
	Procedure 2 Connect Check and Replacement Check.....	40
2.18	CRT Troubleshooting	41
	Procedure 1 External Monitor Check.....	41
	Procedure 2 Connector and Cable Check.....	41
2.19	USB Troubleshooting	43
	Procedure 1 Diagnostic Test Program Execution Check	43
	Procedure 2 Connect Check and Replacement Check.....	43
2.20	LED Troubleshooting	44
	Procedure 1 Each function Execution Check.....	44
	Procedure 2 Connect Check and Replacement Check.....	44
2.21	Optical Disk Drive Troubleshooting.....	45
	Procedure 1 Diagnostic Test Program Execution Check	45
	Procedure 2 Connector Check and Replacement Check.....	45
2.22	Modem Troubleshooting.....	47
	Procedure 1 Diagnostic Test Program Execution Check	47
	Procedure 2 Connector Check and Replacement Check.....	47
2.23	3 in 1 Card Reader Troubleshooting.....	49
	Procedure 1 Media Card Check	49
	Procedure 2 Connector Check and Replacement Check.....	49

Chapter 3

Diagnostic Programs

Chapter 3 Contents

3.1	Tests and Diagnostics Software Overview	3-3
3.2	Executing the Diagnostic Test	3-4
3.3	Subtest names.....	3-8
3.4	System Test.....	3-11
3.5	Memory Test.....	3-13
3.6	Keyboard Test.....	3-17
3.7	Display Test	3-19
3.8	Floppy Disk Test.....	3-34
3.9	Hard Disk Test	3-36
3.10	Real Time Clock Test	3-39
3.11	Cache Memory Test.....	3-41
3.12	High Resolution Display Test.....	3-43
3.13	Multimedia Test.....	3-49
3.14	MEMORY2 Test.....	3-50
3.15	Error Codes and Error Status Names	3-52
3.16	Running Test.....	3-54
3.17	DMI INFOEMATION	3-55
3.17.1	Check DMI Information	3-55
3.17.2	Write DMI Information.....	3-55
3.18	Log Utilities	3-58
3.18.1	Operations	3-58
3.19	System Configuration	3-60
3.20	OPTION.....	3-61
3.20.1	Function Description.....	3-61
3.20.2	Operation Description.....	3-61
3.21	Common Tests and Operation	3-63
3.21.1	How to operate a window	3-63
3.21.2	How to Stop the Test Program.....	3-63
3.21.3	Test Status Screen.....	3-63
3.21.4	Test Stop Display	3-65
3.21.5	How to enter data.....	3-65

3.1 Tests and Diagnostics Software Overview

This chapter explains how to use the Tests and Diagnostics Software for the Satellite L640 computer systems.

NOTES: *Before starting the Tests and Diagnostics software:*

1. *Check all cables for loose connections.*
2. *Exit any application and close Windows.*

The Diagnostics Menu consists of the following options:

- Diagnostic Test
- Running Test
- DMI Information
- Log Utilities
- System Configuration
- Option

The Diagnostic Test Menu consists of the following functional tests:

- System Test
- Memory Test
- Keyboard Test
- Display Test
- Floppy Disk Test
- Hard Disk Test
- Real Time Clock Test
- Cache Memory Test
- High Resolution Display Test
- Multimedia Test
- Memory2 Test
- FDD & HDD Error Retry Count Set

The following equipment is required to perform some of the diagnostic test programs:

- The Diagnostics Disk (all tests)
- A formatted working disk for the floppy disk drive test (all tests)
- A CD test media (Toshiba Backup CD ROM for the CD-ROM test)

The following sections detail the tests contained within the Diagnostic Test Menu. Refer to Sections 3.18, 3.19, 3.20 and, 3.21 for detailed information on the remaining functions of the Tests and Diagnostics software.

3.2 Executing the Diagnostic Test

Free-DOS is required to run the Diagnostics Program. To start the programs follow these steps:

1. Create a Free-DOS bootable disk and copy all the files from the Tests and Diagnostics software to the disk.
2. Insert the boot disk into the computer's floppy disk drive and turn on the computer.

NOTES: *If error message display "Sorry. This Model Type Not Match This Machine":*

Please Check:

1. *You test disk is match this model, ex. disk is 14" but machine is 13" .*
2. *The M/B EEPROM project type is math your test disk, if not , please use WDMI3.EXE to modify with right LCD size .*

The following screen displays:

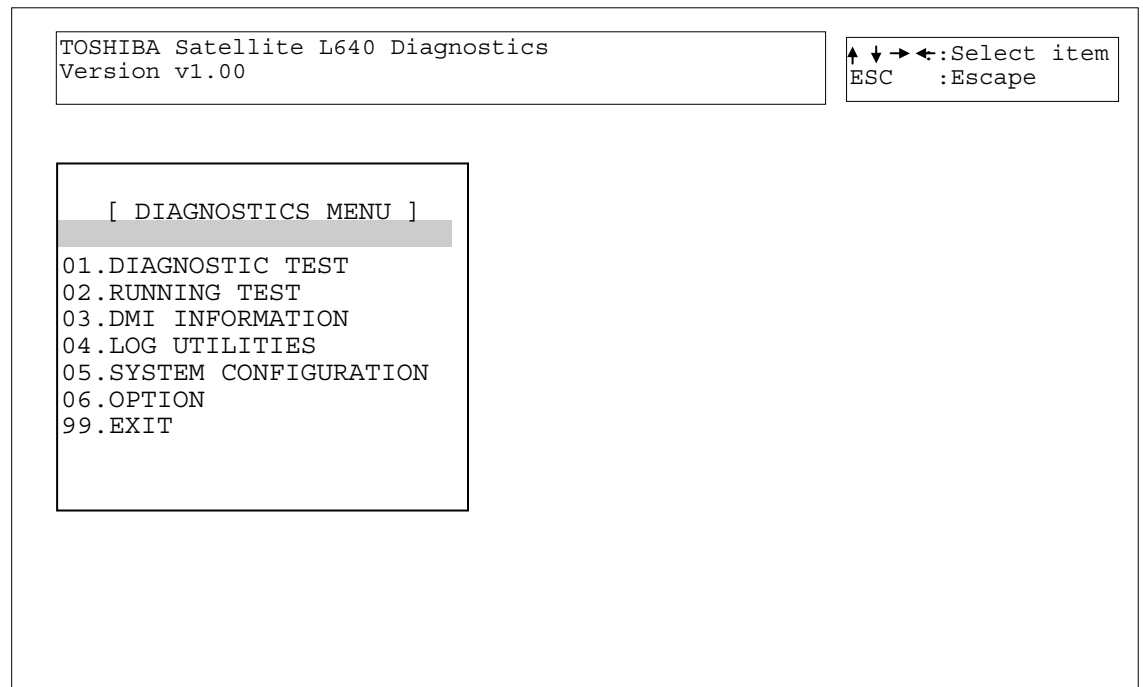

3. To select the Diagnostic Test from the Diagnostics Menu use the arrow keys to set the highlight bar to **01** and press **Enter**.

Test Program for Field.

The following menu displays:

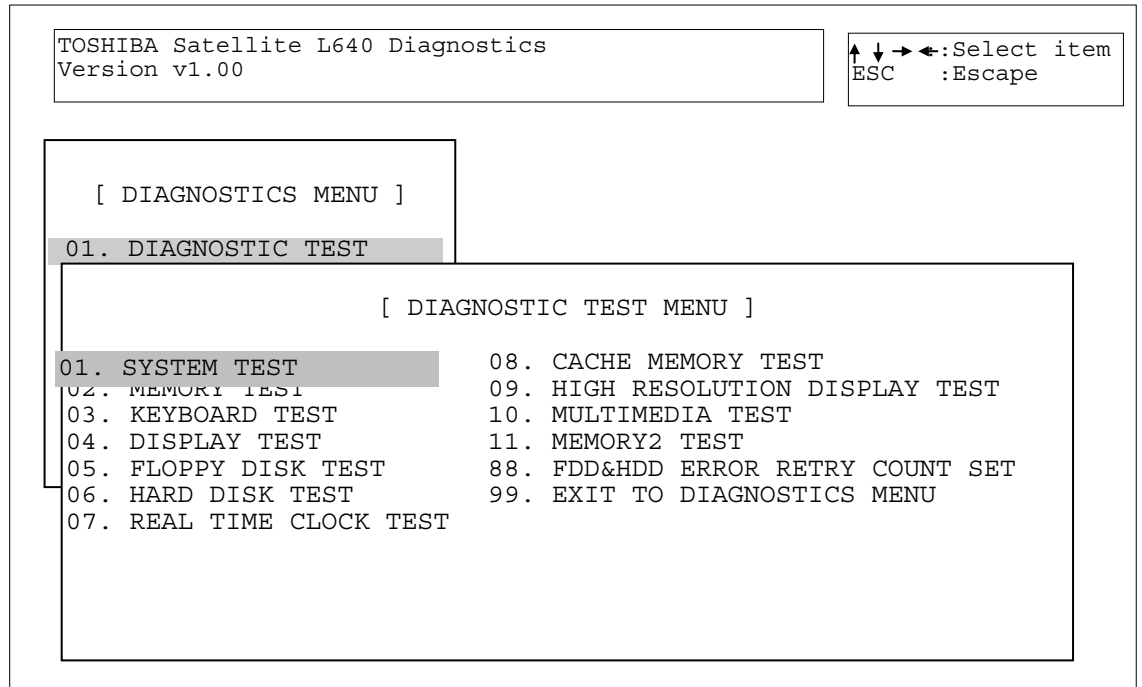

Refer to Sections 3.4 through 3.14 for detailed descriptions of Diagnostics Tests 1 through 11. Item 88 sets the floppy disk drive and hard disk drive error retry count. Item 99 exits the submenu of the Diagnostic Test and returns to the Diagnostics Menu.

4. Select the subtest you want to execute and press **Enter**. The following menu displays:

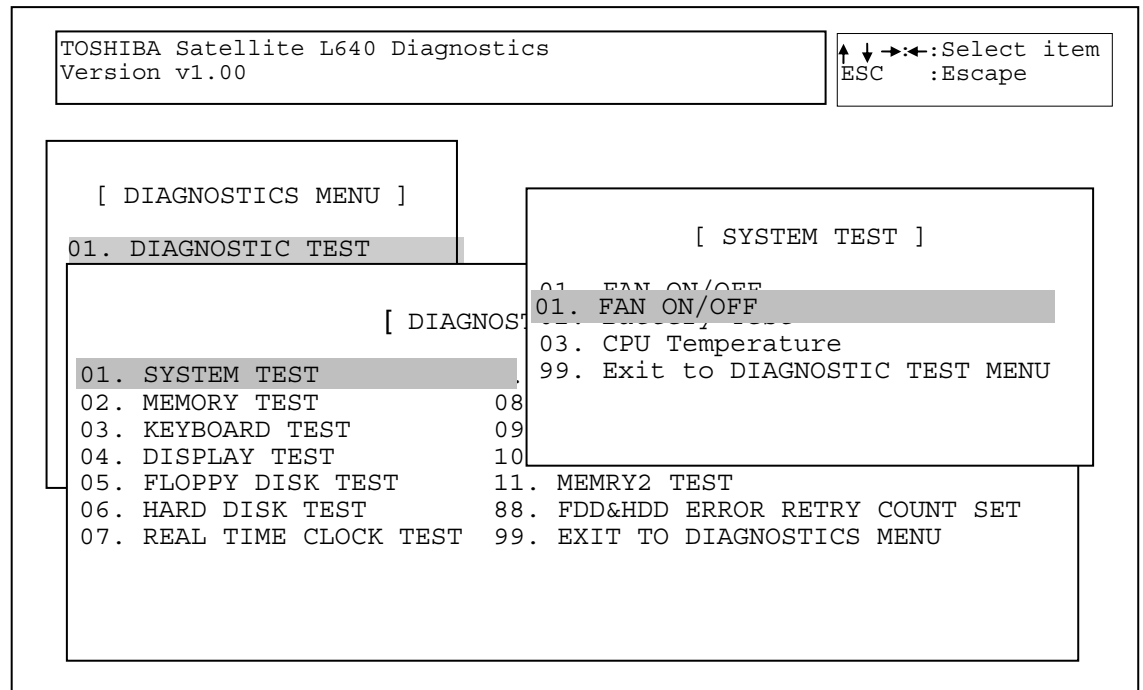

5. Select the desired test from the subtest menu and press **Enter**. The following Test Parameter menu displays:

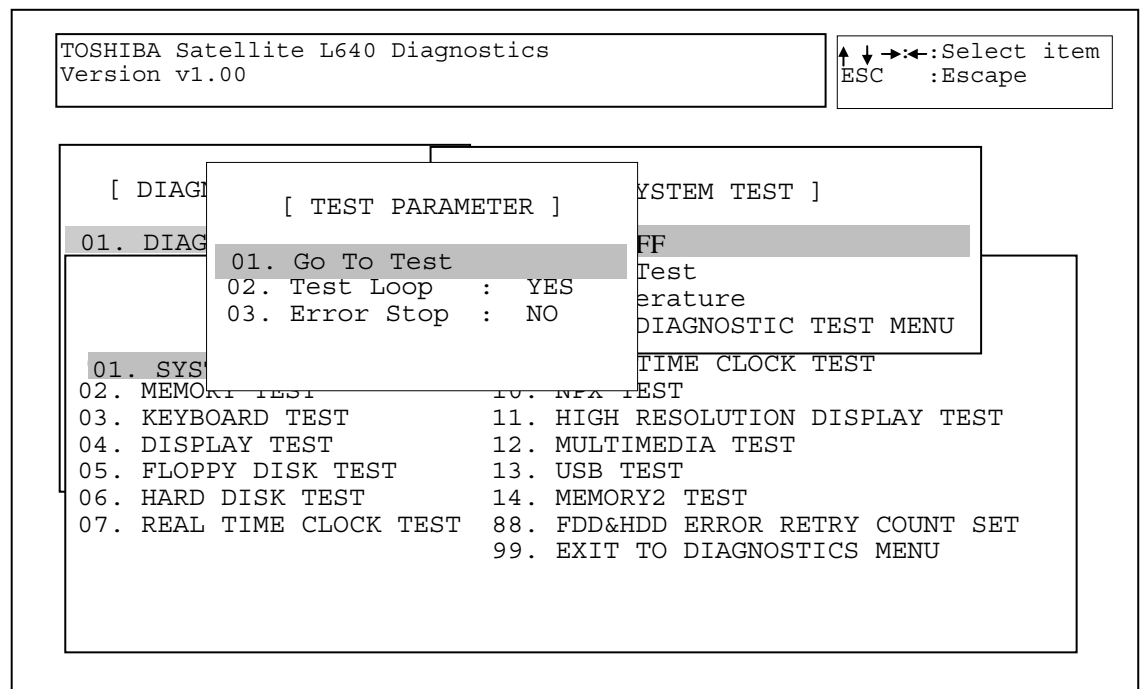

Use the arrow keys to highlight the desired option and press **Enter**.

NOTES: *The Item2 and 3 of Test Parameter are not used by some tests.*

Go To Test

Move the highlight bar to *Go To Test* and press **Enter** to start executing the test.

Test Loop

Select **NO** to return the screen to the subtest menu after the test is complete.

Select **YES** to set the test to run continuously until it is halted by the user.

Error Stop

Select **NO** to keep the test running even if an error is found.

Select **YES** to stop the test program when an error is found and display the HALT OPERATION screen as shown below:

```
[ [ HALT OPERATION ] ]  
1: Test end  
2: Continue  
3: Retry
```

These three selections have the following functions:

- 1: Terminates the test program and exits to the subtest menu.
- 2: Continues the test from the error.
- 3: Restarts the test from the beginning.

Use the arrow keys to move the cursor to the desired option and press **Enter**.

Table 3-1 in Section 3.3 lists the function of each test on the subtest menu. Table 3-2 in Section 3.15 lists the error codes and error status for each error.

3.3 Subtest names

Table 3-1 lists the subtest names for each test program in the Diagnostic Test menu.

Table 3-1 Subtest Names(1/3)

No.	Test Name	No.	Subtest Name
01	SYSTEM TEST	01	FAN ON/OFF check
		02	Battery TEST
		03	CPU Temperature
02	MEMORY TEST	01	Conventional Memory
		02	Protected Mode
		03	Protected Mode (32MB-MAX)
		04	RAM Refresh
		05	Stress Test
03	KEYBOARD TEST	01	Pressed Key Display [JP KBD]
		02	Pressed Key Display [UK KBD]
		03	Pressed Key Display [US KBD]
		04	PS/2 Mouse (Pointing 2Button)
04	DISPLAY TEST	01	Character Attributes
		02	Character Set
		03	80* 25 Character Display
		04	320* 200 Graphics Display
		05	640* 200 Graphics Display
		06	640* 480 Graphics Display
		07	Display Page
		08	"H" Pattern Display
		09	Video DAC Register W/R/C
		10	Color Graphics Display
		11	Color Attributes Display
		12	Color Tiling

Table 3-1 Subtest Names(2/3)

No.	Test Name	No.	Subtest Name
05	FLOPPY DISK TEST	01	Sequential Read
		02	Sequential W/R/C
		03	Random Address/Data
		04	Write Specified Address
		05	Read Specified Address
06	HARD DISK TEST	01	Sequential Read
		02	Address Uniqueness
		03	Random Address Data
		04	Cross Talk and Peek Shift
		05	Write Specified Address
		06	Read Specified Address
		07	Sequential Write
		08	W-R-C Specified Address
07	REAL TIME CLOCK TEST	01	Real Time Test
		02	Backup Memory Test
		03	Real Time Carry Test
08	CACHE MEMORY TEST	01	Constant Data Test
		02	Address Pattern Test
		03	Increment/Decrement Test
		04	Bit Shift Pattern Test
		05	*Write Disturb Test
		06	Checker Board Test
		07	Marching Test
		08	Working Data Test
09	HIGH RESOLUTION DISPLAY TEST	01	VRAM W/R/C Test
		02	640* 480 Mode Display
		03	800* 600 Mode Display
		04	1024* 768 Mode Display
		05	"H" Pattern Display
		06	Focus Test ("E" Pattern)

Table 3-1 Subtest Names(3/3)

No.	Test Name	No.	Subtest Name
10	MULTIMEDIA TEST	01	Sequential Read Test
		02	Random Read Test
		03	Read Specified Address Test
		04	1 point W/R/C Test
11	MEMORY2	01	All one/zero Test
		02	Walking 1/Walking 0 Test(Left)
		03	Walking 1/Walking 0 Test(Right)
		04	Walking 1/Walking 0 Test(Left /Right)

**This test cannot support.*

3.4 System Test

To execute the System Test select **01** from the Diagnostic Test Menu, press **Enter** and follow the directions on the screen. The System Test contains three subtests. Move the highlight bar to the subtest you want to execute and press **Enter**.

Subtest 01 FAN ON/OFF Checking

Select 1,2,3 to control FAN on/off , 1=Fan on , 2=Fan off , 3=Exit .

[BOIFAN2.EXE] Program Version : 1.0

1: Fan On 2: Fan Off 3: Exit

Fan1 Status On Fan1RPM : 5000 or Fan1 Status OFF Fan1RPM : 0

Fan2 Status On Fan2RPM : 2500 or Fan2 Status OFF Fan2RPM : 0

Subtest 02 Battery Test

This will display battery information for check , press [ESC] to exit .

[BOIPCU.EXE] Program Version : 1.1 03-20-2010

voltage	: 12522 mV	Remaining capacity alarm	: 440 mAh
temperature	: 24.4 °C	Remaining time alarm	: 10 min
current	: 1330 mA	Battery mode	: 0
average current	: 1327 mA	AtRate	: 0 mA
relative state of charge	: 93 %	At rate time to full	: 65535 min
absolute state of charge	: 89 %	At rate time to empty	: 65535 min
remaining capacity	: 3546 mAh	At rate O. K.	: FFFF
full charge capacity	: 3800 mAh	Maximun error	: 2 %
run time to empty	: -1 min.	Charging current	: 3000 mA
average time to empty	: -1 min.	Charging voltage	: 12600 mA
average time to full	: 101 min.	Manufacturer name	: LGC
cycle count	: 10 times	Device name	: NS2P3SZMP4WR
design capacity	: 4400 mAh	Device chemistry	: LION
design voltage	: 10800 mV	Manufacturer data	: 0
specification information	: 3.1	Manufacture date	: 1/6/2010
serial no.	: 32009		
STATUS	: INIT		

Press [ESC] KEY to exit

Subtest 03 CPU Temperature

This will display CPU Temperature for check , press [ESC] to exit .

[CPU_TEMP.EXE] Program Version : 1.3 03-09-2009

CPU Temperature : XX

GPU Temperature : XX

NOTES: *If no external Graphics , GPU not report temperature . when read data is 255 mean no external Graphics .*

3.5 Memory Test

To execute the Memory Test select **02** from the Diagnostic Test Menu, press **Enter** and follow the directions on the screen. The Memory Test contains five subtests that test the computer's memory. Move the highlight bar to the subtest you want to execute and press **Enter**.

***NOTE:** If **NO** is selected for Test Loop on the Test Parameter menu, the Test Status screen displays while the test is executing. When the test is complete the Memory Test menu displays.*

*If **YES** is selected for Test Loop on the Test Parameter menu, the Test Status screen displays while the test is executing. Press **Ctrl + break** to return to the Memory Test menu.*

Subtest 01 Conventional Memory

This subtest first writes test data patterns to conventional memory (0 to 640 KB), then reads the new data and compares the result with the original data patterns.

If a compare error occurs, the write data, read data, and test address display on the screen. Addresses are displayed in 4KB increments during the test.

Test Process:

1. Byte Enable Test
"One bit write/ 8 bit read" is executed and the new data is compared with the original data.
Test data = CCAA5533H, 80000000H
2. Byte Enable Test
"One bit write/16 bit read" is executed and the new data is compared with the original data.
Test data = CCAA5533H, 80000000H
3. Data bus test
"One bit write/16 bit read" is executed and the new data is compared with the original data.
Test data = 1H, 2H, 4H, 8H, 10H, through 80000000H.
4. Fixed data test
"16 bit write/ 16 bit read" is executed and the new data is compared to the original data.
Test data = FFFFFFFFH, 00000000H, 80018001H

5. Address pattern test
“16 bit write and 16 bit read” of address pattern data is executed and the new data is compared with the original data.
Test data = 0000H, 0004H, 0008H, 000CH,...8000H, 8004H, through FFECH

Subtest 02 Protected Mode

This subtest first writes data patterns and address data from 1 to 32 MB, then reads the new data and compares the result with the original data patterns. Addresses are displayed in 64KB increments during the test.

Test Process:

1. Byte Enable Test
“One bit write/ 8 bit read” is executed and the new data is compared with the original data.
Test data = CCAA5533H, 80000000H
2. Byte Enable Test
“One bit write/16 bit read” is executed and the new data is compared with the original data.
Test data = CCAA5533H, 80000000H
3. Data bus test
“One bit write/16 bit read” is executed and the new data is compared with the original data.
Test data = 1H, 2H, 4H, 8H, 10H, through 80000000H.
4. Fixed data test
“16 bit write/ 16 bit read” is executed and the new data is compared to the original data.
Test data = FFFFFFFFH, 00000000H, 80018001H
5. Address pattern test
“16 bit write and 16 bit read” of address pattern data is executed and the new data is compared with the original data.
Test data = 0000H, 0004H, 0008H, 000CH,...8000H, 8004H, through FFECH

Subtest 03 Protected Mode [32MB - MAX]

This subtest first writes data patterns and address data from 32MB to the maximum installed memory, reads the new data, and then compares the result

with the original data patterns. Addresses are displayed in 64KB increments during the test.

Test Process:

1. Byte Enable Test
“One bit write/ 8 bit read” is executed and the new data is compared with the original data.
Test data = CCAA5533H, 80000000H
2. Byte Enable Test
“One bit write/16 bit read” is executed and the new data is compared with the original data.
Test data = CCAA5533H, 80000000H
3. Data bus test
“One bit write/16 bit read” is executed and the new data is compared with the original data.
Test data = 1H, 2H, 4H, 8H, 10H, through 80000000H.
4. Fixed data test
“16 bit write/ 16 bit read” is executed and the new data is compared to the original data.
Test data = FFFFFFFFH, 00000000H, 80018001H
5. Address pattern test
“16 bit write and 16 bit read” of address pattern data is executed and the new data is compared with the original data.
Test data = 0000H, 0004H, 0008H, 000CH,...8000H, 8004H, through FFECH

Subtest 04 RAM Refresh

This subtest writes a data pattern (CCAA5533H) in 4KB from 0 to the maximum installed memory, then waits for a memory refresh cycle (16 ms or more), reads the new data, and compares the result with the original data pattern.

Test Process:

1. Checks the memory size to determine the maximum size of installed memory.
2. Tests memory addresses 0 to the maximum installed.
3. Writes, reads, and compares test data after a memory refresh cycle (16ms or more).

***NOTE:** There may be a short delay between write and read operations, depending on the memory size.*

Subtest 05 Stress Test

This subtest writes the following 16KB data patterns to the Write/Read Buffer in conventional memory.

```
data:  FFFFFFFFFFFFFFFFFF0000000000000000
       5555555555555555AAAAAAAAAAAAAAAA
       CCCCCCCCCCCCCCCC3333333333333333
       0000000000000000FFFFFFFFFFFFFFFF
       AAAAAAAAAAAAAAAAAA55555555555555
       3333333333333333CCCCCCCCCCCCCCCC
       FFFFFFFFFFFFFFFFFF0000000000000000
       0000000000000000FFFFFFFFFFFFFFFF
       5555555555555555AAAAAAAAAAAAAAAA
       AAAAAAAAAAAAAAAAAA55555555555555
       CCCCCCCCCCCCCCCC3333333333333333
       3333333333333333CCCCCCCCCCCCCCCC
```

3.6 Keyboard Test

To execute the Keyboard Test select **03** from the Diagnostic Test Menu, press **Enter** and follow the directions on the screen. The Keyboard Test contains four subtests that test the computer's keyboard and mouse actions. Move the highlight bar to the subtest you want to execute and press **Enter**.

***NOTE:** The Test Loop and Error Stop parameters are not enabled for the Keyboard test. When test Fn key need press "Fn + *", " *" is the same "P" key .*

Subtest 01 Pressed Key Display [JP Keyboard] for Japan Keyboard

When you execute this subtest, the keyboard layout is drawn on the display. When any key is pressed, the corresponding key on the screen changes from light to dark. Holding a key down enables the auto-repeat function which causes the key's display character to blink .

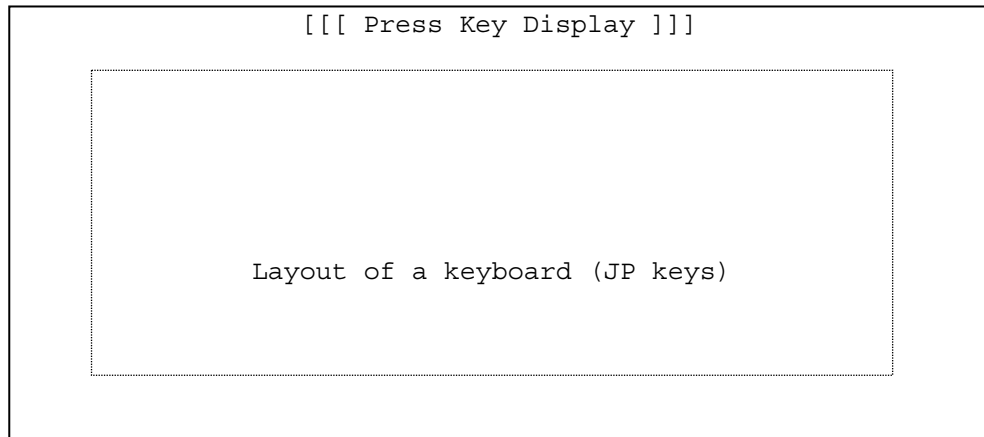

Subtest 02 Pressed Key Display [UK Keyboard] for UK Keyboard

This subtest is used for the UK keyboard and functions the same as Subtest 1.

Subtest 03 Pressed Key Display [US Keyboard] for US Keyboard

This subtest is used for the US keyboard and functions the same as Subtest 1.

Subtest 04 PS/2 Mouse (Pointing)

This subtest checks the function of mouse as shown below.

- A) Pointing device (mouse)
- B) Mouse buttons

Please move cursor to upper left and press left button , screen will display <PRESS> in left rectangle , move cursor to lower right and press right button , screen will display <PRESS> in right rectangle , the program exit .

If left and right button short , screen will display <Left and Right Button maybe short > , the program exit .

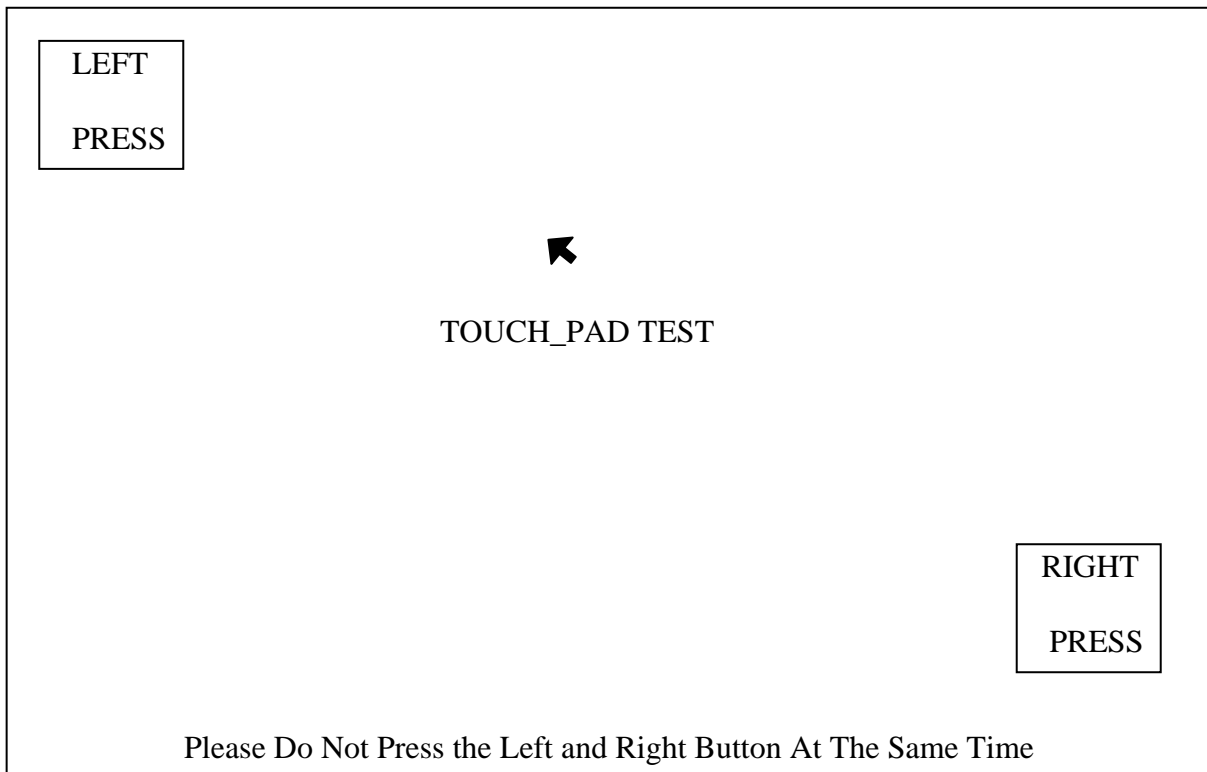

Test Program for Field.

Subtest 03 80 * 25 Character Display

This subtest uses 80*25 video resolution to display character codes 20H - 7EH using Mode 03H (80*25). The data displayed is shifted 1 byte to the left for each line as shown below.

```
80*25 CHARACTER DISPLAY
0123456789012345678901234567890123456789012345678901234567890123456789
!"#$%&'()*+,-./0123456789:;<=>?@ABCDEFGHIJKLMN OPQRSTUVWXYZ[\]^_`abcdefghijklmnop
!"#$%&'()*+,-./0123456789:;<=>?@ABCDEFGHIJKLMN OPQRSTUVWXYZ[\]^_`abcdefghijklmnop
!"#$%&'()*+,-./0123456789:;<=>?@ABCDEFGHIJKLMN OPQRSTUVWXYZ[\]^_`abcdefghijklmnop
!"#$%&'()*+,-./0123456789:;<=>?@ABCDEFGHIJKLMN OPQRSTUVWXYZ[\]^_`abcdefghijklmnopqr
!"#$%&'()*+,-./0123456789:;<=>?@ABCDEFGHIJKLMN OPQRSTUVWXYZ[\]^_`abcdefghijklmnopqrs
!"#$%&'()*+,-./0123456789:;<=>?@ABCDEFGHIJKLMN OPQRSTUVWXYZ[\]^_`abcdefghijklmnopqrst
!"#$%&'()*+,-./0123456789:;<=>?@ABCDEFGHIJKLMN OPQRSTUVWXYZ[\]^_`abcdefghijklmnopqrstu
!"#$%&'()*+,-./0123456789:;<=>?@ABCDEFGHIJKLMN OPQRSTUVWXYZ[\]^_`abcdefghijklmnopqrstuv
```

Shifted to the left one letter by one letter.

```
23456789:;<=>?@ABCDEFGHIJKLMN OPQRSTUVWXYZ[\]^_`abcdefghijklmnop gh I j k l mnopqrst
3456789:;<=>?@ABCDEFGHIJKLMN OPQRSTUVWXYZ[\]^_`abcdefghijklmnop gh I j k l mnopqrst
456789:;<=>?@ABCDEFGHIJKLMN OPQRSTUVWXYZ[\]^_`abcdefghijklmnop gh I j k l mnopqrst
```

Press [Enter] KEY

To exit this subtest and return to the Display Test menu:

Press **Enter** if **NO** was selected for *Test Loop* on the Test Parameter Menu.
Press **Ctrl + break** if **YES** was selected for *Test Loop* on the Test Parameter Menu.

Subtest 04 320 * 200 Character Display

This subtest uses 320*200 video resolution to display green, red and yellow followed by cyan, magenta, and white. The screen below shows the displays when this subtest is executed.

320 * 200 GRAPHICS DISPLAY

COLOR SET 0 : [4]

GREEN
CYAN

RED
MAGENTA

YELLOW
WHITE

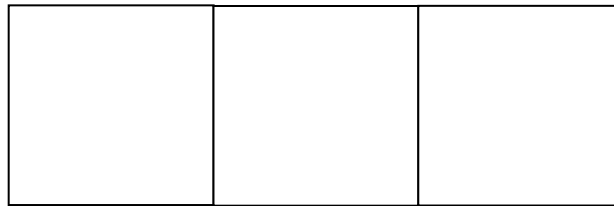

Press **ENTER** to display the following sixteen colors: black, blue, green, cyan, red, magenta, brown, white, dark gray, light blue, light green, light cyan, light red, light magenta, yellow, and intensified white.

Test Program for Field.

320*200 GRAPHICS DISPLAY : [D]

BLACK	<input type="text"/>	<input type="text"/>	D	GRAY
BLUE	<input type="text"/>	<input type="text"/>	L	BLUE
GREEN	<input type="text"/>	<input type="text"/>	L	GREEN
CYAN	<input type="text"/>	<input type="text"/>	L	CYAN
RED	<input type="text"/>	<input type="text"/>	L	RED
MAGENTA	<input type="text"/>	<input type="text"/>	L	MAGENTA
BROWN	<input type="text"/>	<input type="text"/>		YELLOW
WHITE	<input type="text"/>	<input type="text"/>	I	WHITE

Press [Enter] KEY

<input type="text"/>	<input type="text"/>
----------------------	----------------------

Press **ENTER** to display 64 gradations of red, green, blue and white on the screen

320*200 GRAPHICS DISPLAY : [13]

64 gradations of red are displayed.
64 gradations of green are displayed.
64 gradations of blue are displayed.
64 gradations of white are displayed.

Press [Enter] KEY

To exit this subtest and return to the Display Test menu:

Press **Enter** if **NO** was selected for *Test Loop* on the Test Parameter Menu.
Press **Ctrl + break** if **YES** was selected for *Test Loop* on the Test Parameter Menu.

Subtest 05 640 * 200 Character Display

This subtest uses 640*200 video resolution to display three windows, each window drives a different set of dots: even dots, odd dots and all dots. The screen below displays when this subtest is executed.

640 * 200 GRAPHICS DISPLAY : [6]

EVEN DOTS DRIVEN	ODD DOTS DRIVEN	ALL DOTS DRIVEN

Press **ENTER** to display the following 16 colors: black, blue, green, cyan, red, magenta, brown, white, dark gray, light blue, light green, light cyan, light red, light magenta, yellow, and intensified white.

640*200 GRAPHICS DISPLAY : [E]

BLACK	<input type="text"/>	<input type="text"/>	DARK GRAY
BLUE	<input type="text"/>	<input type="text"/>	LIGHT BLUE
GREEN	<input type="text"/>	<input type="text"/>	LIGHT GREEN
CYAN	<input type="text"/>	<input type="text"/>	LIGHT CYAN
RED	<input type="text"/>	<input type="text"/>	LIGHT RED
MAGENTA	<input type="text"/>	<input type="text"/>	LIGHT MAGENTA
BROWN	<input type="text"/>	<input type="text"/>	YELLOW
WHITE	<input type="text"/>	<input type="text"/>	INTENSIFIED WHITE
	<input type="text"/>	<input type="text"/>	

Press [Enter] KEY

To exit this subtest and return to the Display Test menu:

Press **Enter** if **NO** was selected for *Test Loop* on the Test Parameter Menu.
Press **Ctrl + break** if **YES** was selected for *Test Loop* on the Test Parameter Menu.

Test Program for Field.

Subtest 06 640 * 480 Character Display

This subtest uses 640*350 video resolution to display 16 colors: black, blue, green, cyan, red, magenta, brown, white, dark gray, light blue, light green, light cyan, light red, light magenta, yellow, and intensified white. The screen below displays when this subtest is executed.

640*350 GRAPHICS DISPLAY : [10]

BLACK	<input type="text"/>	<input type="text"/>	DARK GRAY
BLUE	<input type="text"/>	<input type="text"/>	LIGHT BLUE
GREEN	<input type="text"/>	<input type="text"/>	LIGHT GREEN
CYAN	<input type="text"/>	<input type="text"/>	LIGHT CYAN
RED	<input type="text"/>	<input type="text"/>	LIGHT RED
MAGENTA	<input type="text"/>	<input type="text"/>	LIGHT MAGENTA
BROWN	<input type="text"/>	<input type="text"/>	YELLOW
WHITE	<input type="text"/>	<input type="text"/>	INTENSIFIED WHITE
Press [Enter]	<input type="text"/>	<input type="text"/>	

Press **ENTER** to display the following 16 colors: black, blue, green, cyan, red, magenta, brown, white, dark gray, light blue, light green, light cyan, light red, light magenta, yellow, and intensified white using 640*480 video resolution.

640*480 GRAPHICS DISPLAY : [12]

BLACK	<input type="text"/>	<input type="text"/>	DARK GRAY
BLUE	<input type="text"/>	<input type="text"/>	LIGHT BLUE
GREEN	<input type="text"/>	<input type="text"/>	LIGHT GREEN
CYAN	<input type="text"/>	<input type="text"/>	LIGHT CYAN
RED	<input type="text"/>	<input type="text"/>	LIGHT RED
MAGENTA	<input type="text"/>	<input type="text"/>	LIGHT MAGENTA
BROWN	<input type="text"/>	<input type="text"/>	YELLOW
WHITE	<input type="text"/>	<input type="text"/>	INTENSIFIED WHITE
	<input type="text"/>	<input type="text"/>	

Press [Enter] ~~RET~~

To exit this subtest and return to the Display Test menu:

Press **Enter** if **NO** was selected for *Test Loop* on the Test Parameter Menu.
Press **Ctrl + break** if **YES** was selected for *Test Loop* on the Test Parameter Menu.

Test Program for Field.

Subtest 10 Color Graphics Display

This subtest displays three colors, cyan, white and yellow on the screen as shown below.

640 * 480 GRAPHICS DISPLAY

CYAN

WHITE

YELLOW

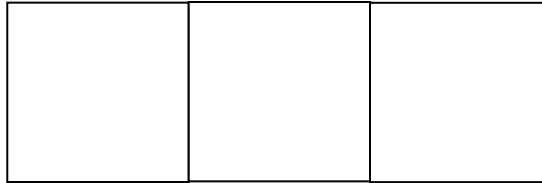

To exit this subtest and return to the Display Test menu:

Press **Enter** if **NO** was selected for *Test Loop* on the Test Parameter Menu.
Press **Ctrl + break** if **YES** was selected for *Test Loop* on the Test Parameter Menu.

Subtest 11 Color Attributes Display

This subtest displays 16 colors: black, blue, green, cyan, red, magenta, brown, white, dark gray, light blue, light green, light cyan, light red, light magenta, yellow, and intensified white. The screen below displays when this subtest is executed.

640*480 COLOR ATTRIBUTE DISPLAY

0	1	2	3	4	5	6	7	8	9	A	B	C	D	E	F
---	---	---	---	---	---	---	---	---	---	---	---	---	---	---	---

Press [Enter] Key

Pressing **Enter** executes VRAM mapping test which indicates vertical lines

Press **Enter** to execute the VRAM mapping test which displays a horizontal line at one dot intervals using Mode 12.

NOTE: *The following screen does not display correctly. It will be amended in the next version.*



Press **Enter** to execute the VRAM mapping test which displays a vertical line at four dot intervals using Mode 12.

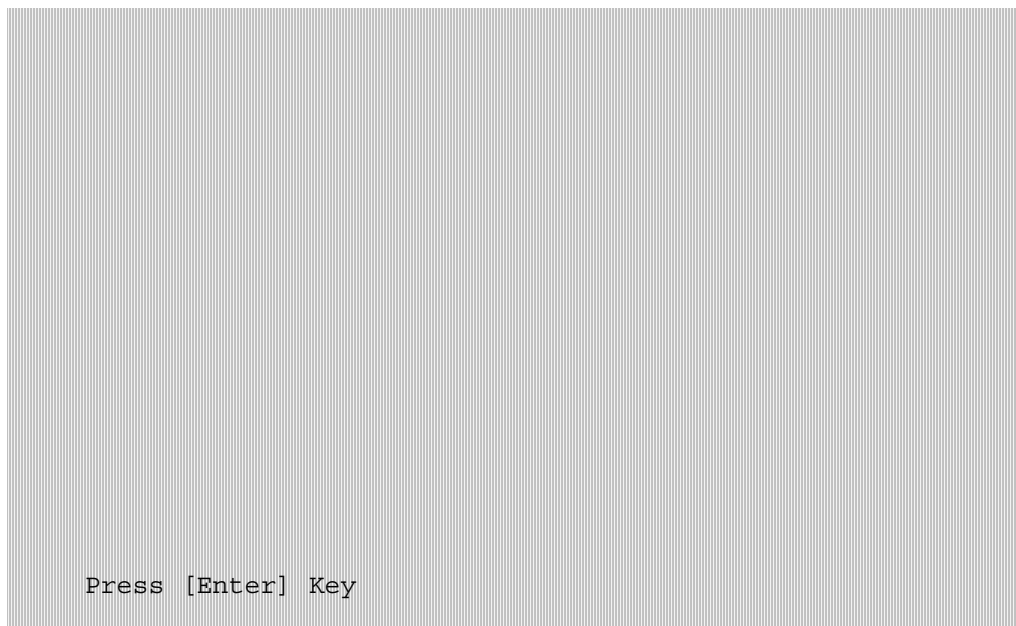

Press **Enter** to display VRAM mapping test using the all dots Mode.

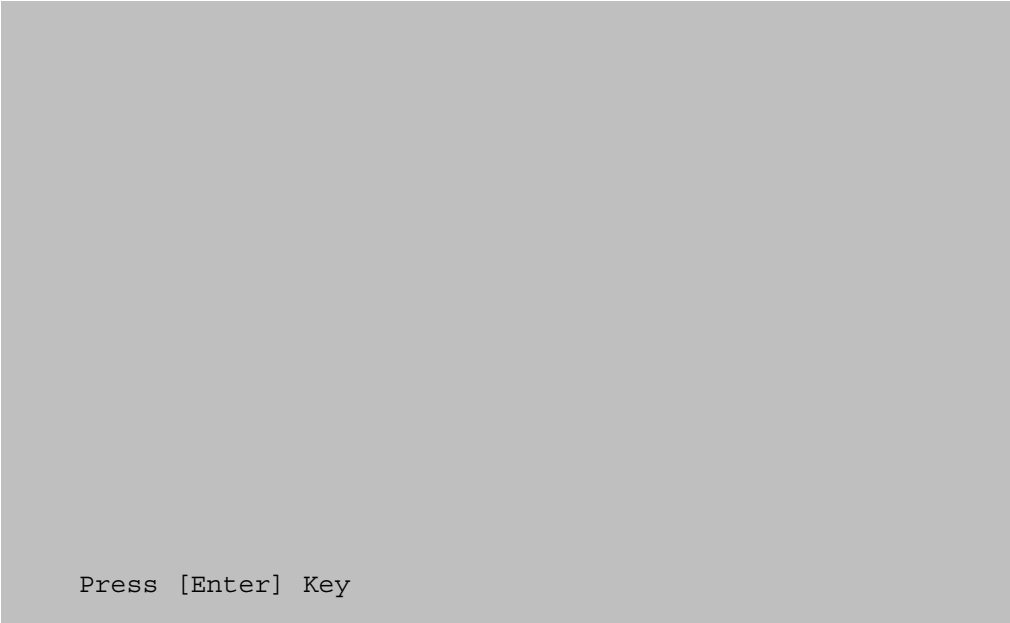

Press [Enter] Key

To exit this subtest and return to the Display Test menu:

Press **Enter** if **NO** was selected for *Test Loop* on the Test Parameter Menu.
Press **Ctrl + break** if **YES** was selected for *Test Loop* on the Test Parameter Menu.

Test Program for Field.

Subtest 12 Color Tiling

This subtest displays black, gray, white, and 3 gradations of red, green, and blue as shown in the following display.

Black	Red	Green	Blue
Gray	Red Gradation	Green Gradation	Blue Gradation
White	Red Gradation	Green Gradation	Blue Gradation

To exit this subtest and return to the Display Test menu:

Press **Enter** if **NO** was selected for *Test Loop* on the Test Parameter Menu.
Press **Ctrl + break** if **YES** was selected for *Test Loop* on the Test Parameter Menu.

3.8 Floppy Disk Test

CAUTION: Before running the floppy disk test, prepare a formatted work disk. Remove the diagnostics disk and insert the work disk into the FDD. The contents of the floppy disk will be erased.

To execute the Floppy Disk Test select **05** from the Diagnostic Test Menu, press **Enter** and follow the directions on the screen. The Floppy Disk Test contains five subtests that test the FDD. Move the highlight bar to the subtest you want to execute and press **Enter**.

Subtest 01 Sequential Read

This subtest sequentially reads all the tracks (Tracks 0 to 79) on the floppy disk.

Subtest 02 Sequential W/R/C

This subtest continuously writes the data pattern B5ADADh to all the specified tracks selected in Subtest 01. The data pattern is then read and compared to the original data.

Subtest 03 Random Address/Data

This subtest writes random data to random addresses on all tracks defined in Subtest 01. The data is then read and compared to the original data.

Subtest 04 Write Specified Address

NOTE: The first two digits of the ADDRESS indicate which track is being tested, the next two digits indicates the head, and the last two digits indicate the sector.

This subtest allows you to verify the errors from Subtest 02. It writes specified data to a specified track and head. Use the Log Utilities (see Section 3.21) to specify the track number and head number where the error(s) occurred during Subtest 02. The following message displays on the screen to enter the test data, track number, and head number.

```
TEST DATA ??  
TRACK NO (00~79) ??  
HEAD NO (0~1) ?
```

Subtest 05 Read Specified Address

This subtest reads data from a specified track and head.

The following message displays on the screen to enter the test track number and head number.

```
TRACK NO (00~79) ??  
HEAD NO (0~1) ?
```

3.9 Hard Disk Test

To execute the Hard Disk Test select **06** from the Diagnostic Test Menu, press **Enter** and follow the directions on the screen. The Hard Disk Test contains eight subtests that test the functions of the hard disk drive. Move the highlight bar to the subtest you want to execute and press **Enter**.

NOTES:** The contents of the hard disk will be erased when subtest 02, 03, 04, 05, 07 or 08 is executed. Before running the test, transfer the contents of the hard disk to other disk. A password is necessary to execute the Hard Disk Test. The password is: **hard disk

Subtest 01 Sequential Read

This subtest sequentially reads all the tracks on the HDD starting at track 0. When all tracks have been read, the test starts at the maximum track and reads sequentially back to track 0.

Subtest 02 Address Uniqueness (This subtest need very long time)

This subtest writes unique address data to each sector of the HDD track-by-track. The data written to each sector is then read and compared with the original data. There are three ways the HDD can be read:

- Forward sequential
- Reverse sequential
- Random

Subtest 03 Random Address Data

This subtest writes random data to 1000 different random addresses on the HDD. This data is then read and compared to the original data.

Subtest 04 Cross Talk and Peak Shift

This subtest writes eight of the most likely to fail data patterns (shown below) to a cylinder on the HDD, then reads the data while moving from cylinder to cylinder.

Data Pattern

B5ADADH
4A5252H
EB6DB6H
149249H
63B63BH
9C49C4H
2DB6DBH
D24924H

Subtest 05 Write Specified Address

NOTE: This subtest is designed to run with the Test Loop set to **NO**. This subtest is a debug tool and the operator should enter the Test Parameters each time.

This subtest allows you to verify the errors from Subtest 01. It writes specified data to a specified LBA. Use the Log Utilities (see Section 3.18) to specify the LBA number where the error(s) occurred during Subtest 01. The following message displays on the screen to enter the test data, and Sector count.

```
TEST DATA          ??  
SECTOR COUNT (01~39) ??  
START ADDRESS (00000000~MAX Address) ?
```

Subtest 06 Read Specified Address

NOTE: This subtest is designed to run with the Test Loop set to **NO**. This subtest is a debug tool and the operator should enter the Test Parameters each time.

This subtest allows you to verify the errors from Subtest 01. It reads specified data (Subtest 06) from a specified LBA. Use the Log Utilities (see Section 3.18) to specify the LBA number where the error(s) occurred during Subtest 01. The following message displays on the screen to enter the test sector count.

```
SECTOR COUNT (01~39) ??  
START ADDRESS (00000000~MAX Address) ?
```

Subtest 07 Sequential Write

This subtest writes specified data to all cylinders on the HDD. The following message displays on the screen to enter the test data.

TEST DATA ????? (=37b3H)

Subtest 08 W-R-C Specified Address

This subtest writes specified data to a specified sector count, then reads and compares the result. The following message displays on the screen to enter the test data, sector count.

TEST DATA ????? (=37b3H)
SECTOR COUNT (01~39) ??
START ADDRESS (00000000~Max Address) ?

3.10 Real Time Clock Test

To execute the Real Time Clock Test select **07** from the Diagnostic Test Menu, press **Enter** and follow the directions on the screen. The Real Time Clock Test contains three subtests that test the computer's real time functions. Move the highlight bar to the subtest you want to execute and press **Enter**.

Subtest 01 Real Time

This subtest allows you to change the date and time. To execute the Real Time Subtest, follow these steps:

1. Select Subtest **01** and the following displays:

```
[ REAL TIME TEST ]  
  
Current date : mm-dd-yyyy  
Current time : hh:mm:ss  
  
Enter new date : mm-dd-yyyy  
Enter new time : hh:mm:ss
```

Press [Enter] key to exit test

2. If the current date is not correct, enter the correct date at the "Enter new date" prompt and press **Enter**. The following prompt displays:

```
Enter new time :
```
3. If the current time is not correct, enter the correct time using a 24-hour format and press **Enter**.

NOTE: If **NO** is selected for Test Loop on the Test Parameter menu, the Real Time Clock Test menu displays.
If **YES** is selected for Test Loop on the Test Parameter menu, the screen above displays and the test is executed again. Press **Ctrl + break** to return to the Real Time Clock Test menu.

Subtest 02 Backup Memory

This subtest writes 50 bytes of test data (FFH, AAH, 55H, and 00H) to the CMOS 14th address, then reads the new data and compares it to the original data.

Subtest 03 Real Time Carry

<p>CAUTION: <i>When this subtest is executed, the current date and time are reset.</i></p>

This subtest checks the clock's carry function.

```
                [ REAL TIME CARRY TEST ]  
  
Current date : 12-31-1999  
Current time : 23:59:55  
  
Press [Enter] key to exit test
```

The following is the display after the date carry function is executed.

```
                [ REAL TIME CARRY TEST ]  
  
Current date : 01-01-2000  
Current time : 00:00:01  
  
Press [Enter] key to exit test
```

To exit this subtest and return to the Real Time Clock menu:

Press **Enter** if **NO** was selected for *Test Loop* on the Test Parameter Menu.
Press **Ctrl + break** if **YES** was selected for *Test Loop* on the Test Parameter Menu.

3.11 Cache Memory Test

To execute the Cache Memory Test select **08** from the Diagnostic Test Menu, press **Enter** and follow the directions on the screen. The Cache Memory Test contains eight subtests that test the computer's cache memory. Move the highlight bar to the subtest you want to execute and press **Enter**.

***NOTE:** If **NO** is selected for Test Loop on the Test Parameter menu, the screen will remain blank while the subtest is executing. When the test is complete the Cache Memory Test menu displays.*

*If **YES** is selected for Test Loop on the Test Parameter menu, the Test Status screen displays while the subtest is executing. Press **Ctrl + break** to return to the Cache Memory Test menu.*

Subtest 01 Constant Data Test

This subtest reads the contents of cache memory and saves it into RAM. The subtest then writes constant data (FFFFH, AAAAH, 5555H, 0101H, 0000H), reads the new data and compares the result with the original data pattern. The original cache memory content is then restored to the cache memory.

Subtest 02 Address Pattern Test

This subtest reads the contents of cache memory and saves it into RAM. The subtest then writes address data patterns (0000H, 0001H, 0002H, through 3FFDH, 3FFEH, 3FFFH), reads the new data and compares the result with the original data. The original cache memory content is then restored to the cache memory.

Subtest 03 Increment/Decrement Test

This subtest reads the contents of cache memory and saves it into RAM. The subtest then writes the increment data (00H, 01H, 02H, through FDH, FEH, FFH), reads the new data and compares the result with the original data. After comparing the incremental data, decrement data (FFH, FEH, FEH, through 02H, 01H, 00H) is written and the new data is read and compared with the original data. The original cache memory content is then restored to the cache memory.

Subtest 04 Bit Shift Pattern Test

This subtest reads the contents of cache memory and saves it into RAM. The subtest then writes the bit shift data patterns (1 bit shifted every 4 bytes), reads the new data and compares the result with the original data. The original cache memory content is then restored to the cache memory.

Subtest 05 Write Disturb Test (We can't support this time)

This subtest reads the contents of cache memory and saves it into RAM. The subtest then writes the "write disturb data," reads the new data and compares the result with the original data. The original cache memory content is then restored to the cache memory.

Subtest 06 Checker Board Test

This subtest reads the contents of cache memory and saves it into RAM. The subtest then writes the "checker board data," (data which is inverted front/back and left/right) reads the new data and compares the result with the original data. The original cache memory content is then restored to the cache memory.

Subtest 07 Marching Test

This subtest reads the contents of cache memory and saves it into RAM. The subtest then writes the "marching data," (00H through 01H and 01H through 00H) reads the new data and compares the result with the original data. The original cache memory content is then restored to the cache memory.

Subtest 08 Working Data Test

This subtest reads the contents of cache memory and saves it into RAM. The subtest then writes the "working data," reads the new data and compares the result with the original data. The original cache memory content is then restored to the cache memory.

3.12 High Resolution Display Test

To execute the High Resolution Display Test select **09** from the Diagnostic Test Menu, press **Enter** and follow the directions on the screen. The High Resolution Display Test contains six subtests that test the computer's high resolution video display. Move the highlight bar to the subtest you want to execute and press **Enter**.

Subtest 01 VRAM W/R/C Test

This subtest writes address and data patterns to Video RAM, then reads the values from the Video RAM and compares them to the original test patterns. During the execution of this test 13 different color screens display: black, green, green, blue, blue, red, red, red, black, white, pink, cyan, and black.

Test Process:

1. Sets the video display to 1024*768 mode
2. Bank change test
Writes 1 byte data in order 0, 1, through Fh, and compares the result, at every bank, to the original data patterns.
3. Bit shift data test
Writes 01h data into addresses A000:0000h through A000:FFFFh for each bank, reads the new data and, then compares the results with the original data. Data is then shifted 1 bit to the left, and all bits (01h, 02h, 04h, 08h, through 80h) are tested again.
4. Fixed data test
Writes test data (in order FFh, AAh, 55h, 00h) into addresses A000:0000h through A000:FFFFh for each bank by, reads the new data and, then compares the results with the original data. Data is then shifted 1 bit to the left, and all bits are tested again

NOTE: *If **NO** is selected for Test Loop on the Test Parameter menu, the screen displays the colors listed above and then the High Resolution Display Test menu displays.*

*If **YES** is selected for Test Loop on the Test Parameter menu, the screen displays the colors listed above. Press **Ctrl + break** to return to the High Resolution Display Test menu.*

Subtest 02 640*480 Mode Display

This subtest uses 640*480 video resolution to display a high resolution white frame, 256 letter types (8*16 pixels) and 64 gradations of white, red, green, and blue as shown below.

[640*480 256]

Press [Enter] key

256 letter types indication

WHITE	0-----1-----2-----3-----4-----5-----6-----	64 gradations
RED		64 gradations
GREEN		64 gradations
BLUE		64 gradations

To exit this subtest and return to the High Resolution Display Test menu:

Press **Enter** if **NO** was selected for *Test Loop* on the Test Parameter Menu.
 Press **Ctrl + break** if **YES** was selected for *Test Loop* on the Test Parameter Menu.

Test Program for Field.

Subtest 03 800 * 600 Mode Display

This subtest uses 800*600 video resolution to display a high resolution white frame, 256 letter types (8*16 pixels) and 256 gradations of white, red, green, and blue as shown below.

[800*600 256]

Press [Enter] key

256 letter types indication

WHITE	0-----1-----2-----3-----4-----5-----6----- 64 gradations
RED	64 gradations
GREEN	64 gradations
BLUE	64 gradations

To exit this subtest and return to the High Resolution Display Test menu:

Press **Enter** if **NO** was selected for *Test Loop* on the Test Parameter Menu.
 Press **Ctrl + break** if **YES** was selected for *Test Loop* on the Test Parameter Menu

Subtest 04 1024* 768 Mode Display

This subtest uses 1024*768 video resolution to display a high resolution white frame, 256 letter types (8*16 pixels) and 64 gradations of white, red, green, and blue as shown below.

[1024*768 256]

Press [Enter] key

256 letter types indication

WHITE	0-----1-----2-----3-----4-----5-----6----- 64 gradations
RED	64 gradations
GREEN	64 gradations
BLUE	64 gradations

To exit this subtest and return to the High Resolution Display Test menu:

Press **Enter** if **NO** was selected for *Test Loop* on the Test Parameter Menu.
 Press **Ctrl + break** if **YES** was selected for *Test Loop* on the Test Parameter Menu.

Subtest 06 Focus Test (“E” Pattern)

This subtest sets the 1024*768 Mode and displays “E” patterns (18*18 dot fonts), at 56 letters *42 lines surrounded by a high resolution white frame.

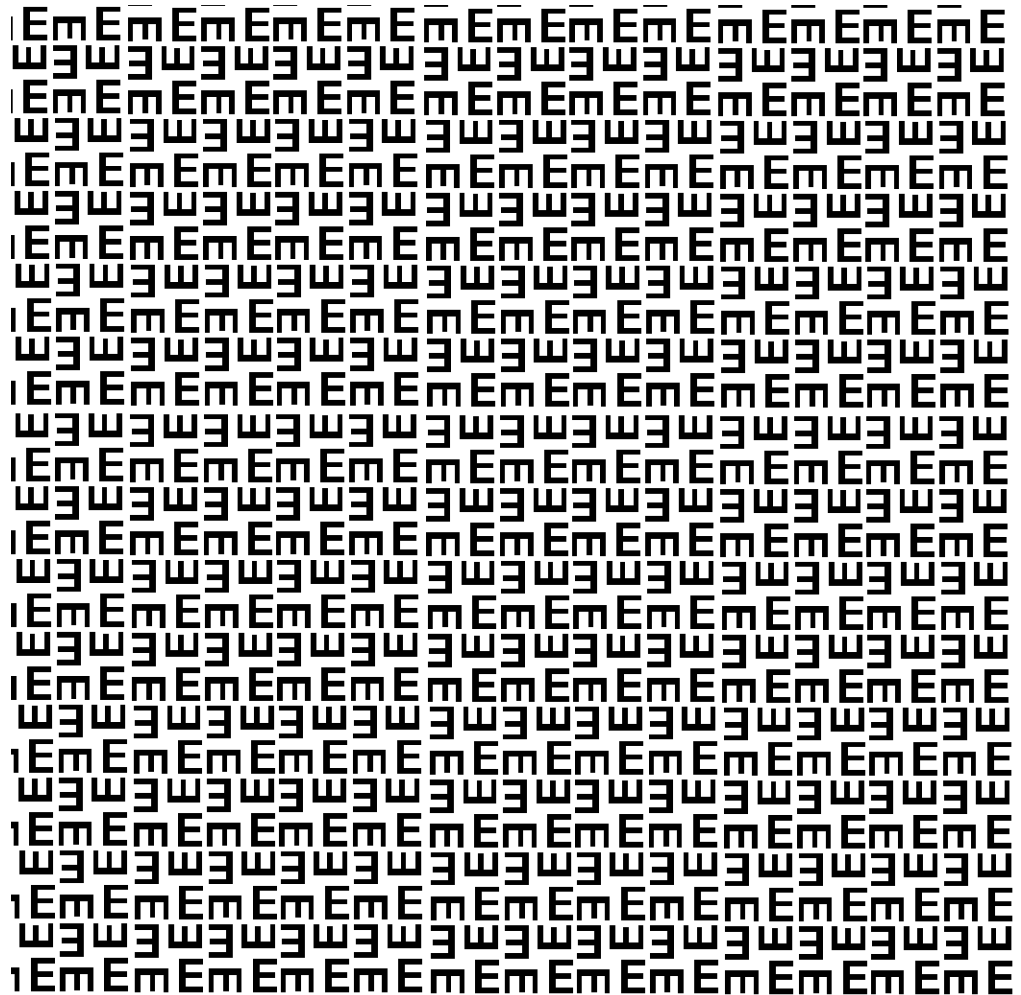

To exit this subtest and return to the High Resolution Display Test menu:

Press **Enter** if **NO** was selected for *Test Loop* on the Test Parameter Menu.
Press **Ctrl + break** if **YES** was selected for *Test Loop* on the Test Parameter Menu.

3.13 Multimedia Test

To execute the Multimedia Test select **10** from the Diagnostic Test Menu, press **Enter** and follow the directions on the screen. The Multimedia Test contains four subtests that test the computer's multimedia functions. Move the highlight bar to the subtest you want to execute and press **Enter**.

***NOTE:** Use the Toshiba Backup CD-ROM for Subtests 01, 02, and 03.
Because CDRom driver issue , the Multimedia function can't test , this is limitation .*

Subtest 01 Sequential Read Test

This subtest sequentially reads one block unit (2K bytes) of all logical addresses from the test CD.

***NOTE:** If **NO** is selected for Test Loop on the Test Parameter Menu, the screen will remain blank while the subtest is executing. When the test is complete the Multimedia Test menu displays.
If **YES** is selected for Test Loop on the Test Parameter Menu, the Test Status screen displays while the subtest is executing. Press **Ctrl + break** to return to the Multimedia Test menu.*

Subtest 02 Random Read Test

This subtest randomly reads all addresses.

Subtest 03 Read Specified Address Test

This subtest reads data from a specified block of addresses.

The following message displays on the screen to enter the start and end block addresses:

```
START BLOCK ADDRESS ?  
END BLOCK ADDRESS  ?
```

Subtest 04 1 Point W/R/C (R/RW Media)

***NOTE:** Use CD-R or CD-RW, the CD-ROM and DVD cannot be used for this subtest, and some DVD-dual can't support this test.*

This subtest writes specified data to a specified block count, then reads and compares the result.

3.14 MEMORY2 Test

To execute the Expansion Test select **11** from the Diagnostic Test Menu, press **Enter** and follow the directions on the screen. The MEMORY2 Test contains four subtests that test the computer's. Move the highlight bar to the subtest you want to execute and press **Enter**.

NOTE: If NO is selected for Test Loop on the Test Parameter menu, the Test Status screen displays while the test is executing. When the test is complete the Memory Test menu displays.

*If YES is selected for Test Loop on the Test Parameter menu, the Test Status screen displays while the test is executing. Press **Ctrl + break** to return to the Memory Test menu*

Memory Test2 is using burst transfer mode by cache memory .

Subtest 01 All one/All zero test

This subtest performs pseudorandom data read/write. The data consists of “all ones”/”all zero” patterns produced by pseudorandom sequence generator. The test checks address error.

```
FFFFFFFFFFFFFFFF0000000000000000  
0000000000000000FFFFFFFFFFFFFFFF
```

Subtest 02 Walking 1/Walking 0 test (Left)

This subtest uses “running one”/”running zero” patterns. This test sequence allows also to checking system bus in maximum noise conditions. The following test sequence is written.

```
7FFF7FFF7FFF7FFF8000800080008000  
BFFFBFFFBFFFBFFF4000400040004000
```

After all the memory being tested is filled with the pattern, it is read in descending direction and compared with reference data. As the memory is read, the data is replaced with inverse test pattern. After all the memory is read and replaced with inverted pattern, it is read in descending direction and compare with new reference data. As the memory is read, the data is replaced with next pattern, which is like first one shifted to right.

Subtest 03 Walking 1/Walking 0 test (Right)

The test method is the same as Subtest2. However, the data to be used differs.

```
80008000800080007FFF7FFF7FFF7FFF  
4000400040004000BFFFBFFFBFFFBFFF
```

Test Program for Field.

Subtest 04 Walking 1/Walking 0 test (Left/ Right)

Tee test method is the same as Subtest2. However, the data to be used differs.

```
7FFF7FFF7FFF7FFF8000800080008000
BBBBBBBBBBBBBBBB4000400040004000
DDDDDDDDDDDDDDDD2000200020002000
```

```
FFFBFFFBFFFBFFFB0004000400040004
FFFDFFFDFFFDFFFD0002000200020002
FFFFFFFFFFFFFFFFE0001000100010001
80008000800080007FFF7FFF7FFF7FFF
4000400040004000BBBBBBBBBBBBBBBB
```

```
0004000400040004FFFBFFFBFFFBFFFB
0002000200020002FFFDFFFDFFFDFFFD
0001000100010001FFFFFFFFFFFFFFFFE
```

3.15 Error Codes and Error Status Names

The following table lists the error codes and error status names for the Diagnostic Tests.

Table 3-2 Error codes and error status names (1/2)

Device Name	Error Code	Error Status Name
(Common)	FF	Data Compare Error
Memory	02	Protected Mode Not Changed
	??	Other Error
FDD	01	Bad Command Error
	02	Address Mark Not Found
	03	Write Protected
	04	Record Not Found
	06	Media Change Line Error
	08	DMA Overrun Error
		DMA Boundary Error
	09	
	0C	Select Media Error
	10	CRC Error
	20	FDC Error
	40	Seek Error
80	Time Out Error	
	??	Other Error
HDD	01	Bad Command Error
	02	Bad Address Mark Error
	04	Record Not Found
	05	HDC Not Reset Error
	07	Drive Not Initialized
	09	DMA Boundary Error
	0A	Bad Sector
	0B	Bad Track Error
	10	ECC Error
	11	ECC Recover Enabled
	20	HDC Error
	40	Seek Error
	80	Time Out Error
	AA	Drive Not Ready

Table 3-2 Error codes and error status names (2/2)

Device Name	Error Code	Error Status Name
HDD	BB	Undefined Error
	CC	Write Fault
	E0	Status Error
	F0	No Sense Error
	??	Other Error
Cache Memory	02	Protect Mode Error
	03	Caching Error
	??	Other Error
Multimedia	01	Write Error
	0F	Invalid Drive
	15	Drive Not Ready
	??	Other Error

NOTE: If error status name is **Other Error**, please reference the **Error Code** for error information

3.16 Running Test

NOTES:

1. *You may add or delete subtests using the Running Test Edit Item function, see Section 3.20.*
2. *Do not forget to insert a work disk in the FDD. If a work disk is not inserted an error will be generated during the Floppy Disk Test.*
3. *If the test completes successfully an “PASS” sign with blue letters displays on the screen.*
4. *If the test fails or is interrupted before completion an “FAIL” sign with red letters displays on the screen.*
5. *If running item not select an “NOITEM” sign with green letters display on the screen.*
6. *All errors which occur during execution of the Running Test are logged in the Log File.*
7. *This program is executed according to the Count Loop number selected in the Running Test Edit Item, see Section 3.20. To terminate the program, press **Ctrl + Break**.*

3.17 DMI INFOEMATION

Select **03** from the Diagnostics Menu and press **Enter** to Check or Write DMI Information Data:

3.17.1 Check DMI Information

The Check DMI Configuration program contains the following configuration information for the computer:

***NOTE:** Please set the media of DVD before starting a test.*

AHCI cannot control under the DOS, Please change SATA Controller Mode to "Compatibility" Mode .

System information (Type 1)

1. Manufacture : TOSHIBA
2. Product Name : Satellite L640
3. Version : PSL40U-123456 (TOSHIBA Part Number)
4. Serial Number : 12345678W (Serial Number)
5. UUID Number: 000B5F7142CADE11B11200238BF9F8FD

OEM Strings (Type 11)

1. OEM String : PSL40U-123456,S123456789,11V

On Board LAN MAC

1. MAC ADR : 001E4C123456

DVD Region Code

1. User Change Time : 5
2. Region Code : 0

3.17.2 Write DMI Information

The Write DMI Information program contains the following information for the computer :

1. Manufacture Name (TOSHIBA)
2. Product Name (Satellite P500)
3. Part Number (PSP50U-123456)
4. Serial Number (12345678W)
5. OEM String (PSP50U-123456,S123456789,11V)
7. Write UUID (000B5F7142CADE11B11200238BF9F8FD)
8. Brightness Write (1A344C769EC5EDFF)
- a. SLP2.0 Build Sig [1]Non OS [2]OS

- b. Wireless LAN ID (001E4C123456)
- c. AC Adapter Select [1]65W [2]75W [3]90W [4]120W [5]180W

Select 1 ~ c to keyin new data , select 0 to exit program , program will compare input data length with the max length , if over will retry keyin

Note : Please Check New DMI Information After System Restart !!

V3.5

- 1. **** Manufacture Name (TOSHIBA) - (32)
- 2. **** Product Name (Satellite P500) - (32)
- 3. **** Part Number (PSP50U-123456) - (26)
- 4. **** Serial Number (12345678W) - (32)
- 5. **** OEM String (PSP50U-123456,S123456789,11V) - (64)
- 7. **** Write UUID (000B5F7142CADE11B11200238BF9F8FD) – (16)
- 8. **** Brightness Write (1A344C769EC5EDFF) – (8)
 - a. **** SLP2.0 Build Sig [1]Non OS [2]OS-(2)
 - b. **** Wireless LAN ID (001E4C123456) –(12)
 - c. **** AC Adapter Select [1]65W [2]75W [3]90W [4]120W [5]180W –(1)
- 0. **** Exit

Please Select (1 ~ c) To Modify DMI String :

Current Data of EEPROM : Toshiba

1. Enter the Manufacture Name : TOSHIBA

Your Keyin is : TOSHIBA This is your keyin data

EEPROM return : TOSHIBA This is read from eeprom back

Press any key to continue

Note : Please Check New DMI Information After System Restart !!

If Keyin length too long will retry :

Current Data of EEPROM : 12345678WU

4. Enter the Serial Number : 12345678901234

Your Keyin String Length Not Correct 14 > 10 !!!

Current Data of EEPROM : 12345678WU

4. Enter the Serial Number :

NOTE: The SLP2.0 is Microsoft SPEC , call “System Locked Pre-Installation” or ”SLP”, It is for OEM pre install Windows and no need to Active , If you select Non OS , then you need to Active your OS before you use .

Function Detail :

7. UUID :

Total is 16 byte data , Front 10 byte is time random data , last 6 byte is LAN MAC .

8. Brightness Table :

It depend on LCD EDID to set different brightness data .

a. SLP2.0 Build Sig :

[1]Non OS : EEPROM fill "MS" for non Microsoft OS , BIOS not load SLP OPROM function .

[2]OS : EEPROM fill Others for Microsoft OS , BIOS load SLP OPROM function .

b. Wireless LAN ID :

If change M/B , but wireless/B not change , need fill wireless MAC into new change M/B .

c. AC Adapter Select :

[1]65W : Machine need 65W AC Adapter .

[2]75W : Machine need 75W AC Adapter .

[3]90W : Machine need 90W AC Adapter .

[4]120W : Machine need 120W AC Adapter .

[5]180W : Machine need 180W AC Adapter .

The AC Adapter request is base on machine power request , some high performance need 120W Adapter , low cost machine maybe only 75W can meet request .

Because AC Adapter do not had HWID for detect , so need key in data by menu .

(1) If machine setting 75W , AC Adapter use 120W , it's OK .

(2) If machine setting 120W , AC Adapter use 75W , because Adapter can't support enough power , it can't charge well .

(3) If machine setting 90W , AC adapter use 90W , Adapter Select 90 W , it's OK .

(4) If machine setting 90W , AC adapter use 90W , Adapter Select 120W , "PHM" and "ECO" utility will display wrong data , power consumption display double data more the machine actual use .

Test Program for Field.

2. Error information displayed on the screen can be manipulated with the following number keys:

The **1** key scrolls the display to the next page.

The **2** key scrolls the display to the previous page.

The **3** key returns to the Diagnostics Menu.

The **4** key erases all error log information in RAM.

The **5** key reads the log information from a floppy disk.

The **6** key writes the log information to a floppy disk.

The **7** key save the log information to a floppy disk.

The following are the test abbreviations for each Diagnostics Test.

Test Name	Test Abbreviations
System Test	ROM
Memory Test	RAM
Keyboard Test	KBD
Display Test	CRT
Floppy Disk Test	FDD
Hard Disk Test	HDD
Real Time Clock Test	RTM
Cache Memory Test	CAH
Height Resolution Display Test	KIF
Multimedia Test	MLT
Memory2 Test	RAM

3.19 System Configuration

Select **05** from the Diagnostics Menu and press **Enter** to display the following system configuration:

```
SYSTEM CONFIGURATION :

* - BIOS VER = VX.XX  KBC VER = XXXX
* - MAC ADDRESS : XXXXXXXXXXXXX
* - 0 ASYNC ADAPTER
* - 1 HDD DRIVE(S):XXXXXXXXXXXXXXXXXXXXXXXXXXXX
      FW Rev.:XXXXXXXX
      CUR LBA:XXXXXXXX  ORG LBA:XXXXXXXX
* - BATTERY TYPE:XXXXXXXX
* - XXXMB MEMORY SIZE
* - XXX CPU
* - 1 Vedio Chip XXXXXXXXXXXXXXX
* - 1 ODD DRIVE(S):XXXXXXXX
      FW Rev.:XXXX
```

Press **Enter** to return to the Diagnostics Menu.

3.20 OPTION

3.20.1 Function Description

Function description lets you add or delete the subtests used to execute the Running Test. The following screen displays after pressing the **Tab** key to edit an item in the Running Test.

KEY OPERATION

↓	Cursor Down
↑	Cursor Up
PgDn	Page Down
PgUp	Page Up
Home	Top of ITEM
End	End of ITEM
Ins	Insert ITEM
Del	Delete ITEM
Enter	End

3.20.2 Operation Description

Select **05** from the Diagnostics Menu and press **Enter** to display the following:

```

                                Test Item Editor                                [RUNNING TEST]
Loop Count (1-65535, 0 = infinity)  Error Stop 
T-No      Test Name                S-No      Subtest Name
01        System Test              Subtest 01 ROM Checksum
02        Memory Test              Subtest 01 Conventional Memory
02        Memory Test              Subtest 02 Protect Mode
02        Memory Test              Subtest 03 Protect Mode (32MB Max)
02        Memory Test              Subtest 04 RAM Refresh
04        Display Test             Subtest 01 VRAM W/R/C
04        Display Test             Subtest 02 Character Attribute Set
04        Display Test             Subtest 03 Character Set
04        Display Test             Subtest 04 80 * 25 Character Display
04        Display Test             Subtest 05 320 * 200 Graphics Display
04        Display Test             Subtest 06 640 * 200 Graphics Display
04        Display Test             Subtest 07 640 * 480 Graphics Display
04        Display Test             Subtest 08 Display Page
05        Floppy Disk Test         Subtest 02 Sequential W/R/C
08        Hard Disk Test           Subtest 01 Sequential Read
08        Real Time Clock Test     Subtest 02 Backup Memory Test
```

Tab: HELP (Key Operation)

1. Enter a **number** or **0** for **Loop Count** and press **Enter**.

Select a number from 1 to 65535 to define the number of times the Running Test executes.

Select 0 to run the test continuously until halted by the user.

2. Select the **NO** or **YES** for **Error Stop** and press **Enter**.

Select **NO** to keep the test running even if an error is found.

Select **YES** to stop the test program when an error is found.

***NOTE:** All errors which occur during execution of the Running Test are logged in the Log File.*

3. Press **Insert** to add a subtest.
4. Press **Delete** to remove the selected subtest.
5. Press **Enter** when you have finished editing the Running Test list.
6. The following message displays:

Do you want to save the data?

Save to disk
Do not save

7. Select the option and press **Enter**.
8. Select **03** from the Diagnostics Menu and press **Enter** to execute the Running Test.

***NOTE:** If press **Ctrl+break** in the runin process, please press more one any key to exit.*

3.21 Common Tests and Operation

3.21.1 How to operate a window

To input parameters, or open a window use the following keys.

- ↑ ↓ → ← key : to move a highlight bar
- [Enter] key : to select an item at the highlight bar
- [Esc] key : to close the current window and go back to the previous window

3.21.2 How to Stop the Test Program

To stop a test:

[Ctrl]+[Break] Press the Ctrl key and the Break key simultaneously.

3.21.3 Test Status Screen

NOTE: The Test Status Screen does not display during all the tests. See the specific test description Sections 3.4 through 3.14.

The following Test Status screen displays during most tests. See the description of each test Sections 3.4 through 3.14 for specific screen information.

Test Name			
Sub Test	:0101		
Pass Count	:00000	Error Count	:00000
Write Data	:00	Read Data	:00
Address	:00000000	Status	:00

Test Name Displays the name of the test being executed.

Subtest No. Displays the Subtest number in the following format:

ffgg

ff = Subtest No.

gg = Step Number (Will be blank if the test does not have a Step Number.)

Pass Count	Displays the number of times the test has been executed.
Error Count	Displays the number of errors which have occurred during the test.
Write Data	Displays only the test data that has failed to compare during the test while being written during the test.
Read Data	Displays test data that has failed to compare during the test while being read during the test.
Test Address	Displays the Test Address. (The format differs for each test.)
Error Status	Displays the error status.
Error Name	Displays the name of the error.

3.21.4 Test Stop Display

If an error occurs during a Subtest and YES is selected for Error Stop, the following message displays:

```
[HALT OPERATION]

  1. Test end
  2. Continue
  3. Retry
```

* Select 1, 2, or 3

The three selections have the following functions:

- 1: Terminates the test program and exits to the subtest menu.
- 2: Continues the test from the error.
- 3: Restarts the test from the beginning.

Use the arrow keys to move the cursor to the desired option and press Enter.

3.21.5 How to enter data

Letters which must be entered are always shown in []. Simultaneous entries are displayed by a “+” mark. For example:

[a] [Enter]

Press the “a” key, then press the [Enter] key.

[Ctrl] + [c]

Press the [Ctrl] key and the “c” key simultaneously.

Chapter 4

Replacement Procedures

Chapter 4 Contents

4.1	Overview.....	1
	Safety Precautions.....	2
	Before You Begin	3
	Disassembly Procedure.....	4
	Assembly Procedure	5
	Tools and Equipment	5
	Screw Tightening Torque	6
	Grip Color	6
	Screw Notation.....	7
4.2	Battery pack	8
4.3	HDD/SSD	11
4.4	Memory Module	14
4.5	Keyboard.....	17
4.6	Wireless LAN Card.....	20
4.7	3G Module Card	23
4.8	Display Assembly	26
4.9	Top Cover Assembly	33
4.10	Touch pad.....	36
4.11	I/O board	39
4.12	Mother Board	41
4.13	CPU Heat Sink	46
4.14	LCD unit	48
4.15	Web Camera Module	52
4.16	Application for Thermal pad and grease on CPU, NB, V-ram, Chock and VGA.....	55
4.17	Speaker Box.....	57
4.18	Optical Disc Drive and ODD Bezel.....	60
4.19	BT Module.....	64
4.20	Modem.....	66

4.21	Power Board.....	68
4.22	SIM Board.....	70

Figures

Figure 4-2-1	Remove the battery pack.....	8
Figure 4-2-2	Install the battery pack.....	10
Figure 4-3-1	Turn the computer upside down	11
Figure 4-3-2	Remove HDD/SSD assembly	12
Figure 4-3-3	Remove HDD/SSD.....	13
Figure 4-4-1	Remove memory slot cover	15
Figure 4-4-2	Remove a memory module.....	15
Figure 4-4-3	Insert a memory module	16
Figure 4-5-1	Remove 2 screws for KB Holder	18
Figure 4-5-2	Remove 3 screws for Keyboard.....	18
Figure 4-6-1	Wireless LAN card	20
Figure 4-6-2	Remove a wireless LAN card	21
Figure 4-7-1	3G module card.....	23
Figure 4-7-2	Remove a 3G module card.....	24
Figure 4-7-3	Installing a 3G module card.....	25
Figure 4-8-1	Remove the screw on ODD Bezel and ODD.....	26
Figure 4-8-2	Remove the screws(from bottom side)	27
Figure 4-8-3	Remove the screws(from top side)	27
Figure 4-8-4	Remove the Wireless Antenna.....	28
Figure 4-8-5	Remove the LCD cable from mother board.....	29
Figure 4-8-6	Remove the LCD cable from LCD panel	29
Figure 4-8-7	Remove the hinge screws	29
Figure 4-8-8	Securing the hinge screws.....	31
Figure 4-8-9	Connecting LCD harness to the mother board.....	32
Figure 4-8-10	Arrange and connect Wireless LAN antenna	32
Figure 4-9-1	Remove the screws (back)	33

Chapter 4 Replacement Procedures

Figure 4-9-2	Remove the screws (front) and Top cover assembly	34
Figure 4-9-3	Disconnect the touch pad cable/BT cable/speaker cable/power cable	34
Figure 4-10-1	Remove the touch pad FFC cable.....	36
Figure 4-10-2	Loose the screws.....	37
Figure 4-10-3	Remove the touchpad and touchpad board.....	37
Figure 4-11-1	Remove the I/O Board	39
Figure 4-12-1	Remove the mother board.....	41
Figure 4-12-2	Remove RTC battery-step_1	43
Figure 4-12-3	Remove RTC battery-step_2	44
Figure 4-12-4	Install the RTC Battery	45
Figure 4-13-1	Remove the CPU heat sink.....	46
Figure 4-14-1	Remove the display mask	48
Figure 4-14-2	Remove the LCD unit	49
Figure 4-14-3	Remove the LCD hinge	50
Figure 4-15-1	Remove the connector of Web Camera module.....	52
Figure 4-15-2	Peel off the glue of Web Camera module.....	53
Figure 4-16-1	Intel &AMD Thermal pad and grease on CPU, NB, V-ram, chock and VGA.....	55
Figure 4-17-1	Removing the securing screws at left side.....	57
Figure 4-17-2	Removing the securing screws at right side.....	58
Figure 4-17-3	Removing the Speaker Box.....	58
Figure 4-18-1	Remove memory slot cover.....	60
Figure 4-18-2	Remove the Screw on ODD Bezel and ODD.....	60
Figure 4-18-3	Remove the ODD.....	61
Figure 4-18-4	Remove the ODD Bezel.....	61
Figure 4-18-5	Installing the ODD Bezel.....	62
Figure 4-18-6	Installing the ODD.....	62
Figure 4-18-7	Securing screw on ODD Bezel.....	63
Figure 4-18-8	Securing the screws on RAM Door.....	63
Figure 4-19-1	Remove the Bluetooth cable.....	64
Figure 4-19-2	Remove the Bluetooth module.....	64
Figure 4-20-1	Remove the modem.....	66

Figure 4-21-1 Remove power board.....68
Figure 4-22-1 Remove SIM Board.....70

4.1 Overview

This chapter describes the procedure for removing and replacing the field replaceable units (FRUs) in the PC. It may not be necessary to remove all the FRUs in order to replace one. The chart below provides a guide as to which other FRUs must be removed before a particular FRU can be removed. The numbers in the chart indicate the relevant section numbers in this manual.

In all cases when removing an FRU, the battery pack must also be removed. When repairing an FRU that is the potential cause of a computer fault, use the chart to determine the order in which FRUs need to be removed.

The tilt stand, if it is installed, can be removed without any other FRUs removed.

4.2 Battery Pack									
4.3 HDD/SSD									
4.4 Memory Module									
4.5 Key board									
4.9 TOP Cover Assembly									
4.18 Optical Disc Drive and ODD Bezel	4.22 SIM Board	4.10 Touch pad	4.17 Speaker Box	4.12 Mother Board		4.8 Display Assembly	4.19 BT Module	4.11 I/O Board	4.21 Power Board
		4.20 Modem	4.6 Wireless LAN Card	4.13 CPU Heat Sink	4.7 3G Module Card	4.14 LCD Unit			
				4.16 Application for Thermal pad and grease on CPU, North Bridge, V-ram, Chock and VGA		4.15 WEB Camera Module			

- Chart Notation

The chart shows the case for the following example:

- Removing a LCD unit

All FRUs down to the “4.2 Battery pack” to “4.5 Keyboard” and “4.9 Top Cover Assembly” and “4.8 Display Assembly” above LCD unit must be removed.

Safety Precautions

Please read the following safety instructions before disassembling the computer and always follow the instructions while working on the computer.

- DANGER:**
- 1. In the case of the battery, always use authentic parts or equivalent parts approved by Toshiba. Other batteries may have different specifications that are incompatible with the computer and may result in fire or explosion.
Due to the risk of alkali fluid leaks, never attempt to heat or disassemble the battery. Similarly, due to the risk of explosion, never expose the battery to flame.*
 - 2. Some parts including the power supply and FL inverter generate high voltages. If you need to turn on the power while disassembling the computer, do not touch any connectors or other components due to the risk of electric shock. Also, do not disassemble individual parts when performing routine maintenance.*

- WARNING:**
- 1. To prevent electric shock, turn off the power unplug the AC adapter from the power source.*
 - 2. As the battery installed to the computer is typically already charged, the risk of electric shock remains even when the AC adapter is unplugged from the socket. To prevent electric shock, always take off any metal jewelry or accessories such as necklaces, bracelets or rings before working on the computer. Never work with wet or moist hands.*
 - 3. Take care not to injury yourself on any edges or corners.*

- CAUTION:**
- 1. Confirm that replacement parts have compatible specifications before replacing on the computer. Never use incorrect parts as these may cause faults on the computer.*
 - 2. To prevent internal damage such as short circuits or burning, do not allow any screws, paper clips, or other metal objects to fall into the computer. When removing screws, always replace with the same size screws. Ensure that all screws are fully tightened. Loose screws may result in short circuits leading to overheating, smoke or flame.*
 - 3. To prevent electric shock, check that you have disconnected all cables from a part before removing the part.*
 - 4. When connecting to the AC power supply, use only an AC adapter and cable approved by Toshiba.*
 - 5. To prevent electric shock, ensure that all replacement parts are compatible with the computer and that all cables and connectors are securely connected.*

Before You Begin

Take note of the following points before starting work. Always remove the AC adapter and battery pack before commencing any of the procedures. The procedure for removing the battery pack is described in section “4.2 Battery Pack”.

1. Do not disassemble the computer unless it is operating abnormally.
2. Use the designated tools.
3. Ensure that the environment for working on and storing parts does not contain any of the following.
 - Dust or dirt
 - Static electricity
 - Extremely hot, cold or humid conditions
4. Perform the diagnostic tests described in Chapter 2 to determine which FRU is the cause of the fault.
5. Do not perform any unnecessary work. Always work in accordance with the disassembly and reassembly procedures in this manual.
6. Keep parts removed from the computer in a safe place away from the computer where they will not be damaged or interfere with your work.
7. Disassembling requires the removal of a large number of screws. Keep removed screws in a safe place such that you can determine which screws belong to which part.
8. When reassembling, ensure that you use the correct screws and fit parts in the correct position. Screw sizes are noted in the text and figures.
9. As all parts have sharp edges and corners, take care not to cut yourself.
10. After replacing an FRU, check that the computer and replaced part operate correctly.

Disassembly Procedure

Three main types of cable connector are used.

- Pressure plate connector
- Spring connector
- Normal pin connector

When disconnecting a pressure plate connector, lift up the tag on one side of the plastic pressure plate on the connector and pull the cable out from the connector. When reconnecting a cable to a pressure plate connector, lift up the pressure plate to a suitable height and insert the cable into the connector. Press down on both sides of the pressure plate such that both sides of the plate and connector are at the same height and that the cable is fixed in the correct position. Pull the cable to ensure that it is securely connected. If the cable is disconnected from the connector, reconnect it making sure that you lift the pressure plate high enough to insert fully the cable.

For spring connectors, lifting up the stopper frees the cable and allows it to be pulled out. To reconnect, hold the stopper in the up position and insert the cable, then lower the stopper to secure the cable.

Normal pin connectors are used for all other cables. Simply pull out or push in these connectors to disconnect or reconnect.

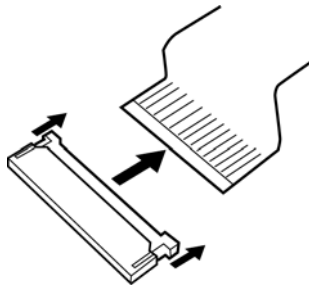

Pressure plate connector

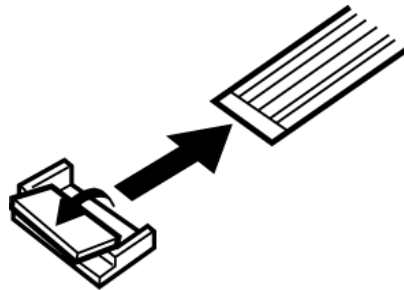

Spring connector

Assembly Procedure

After the computer has been disassembled and the part that caused the fault has been repaired or replaced, the computer must be reassembled.

Take note of the following general points when assembling the computer.

- Take your time and follow the instructions carefully. Hurrying the assembly work will only introduce new problems.
- Check that all cables and connectors are securely connected;
- Before fastening FRUs or other parts in place, ensure that no cables are caught on screws or the FRU.
- Check that all latches are securely closed.
- Ensure that you have installed all FRUs correctly and do not have any screws left over. Using an incorrect screw may damage the thread or screw head and result in the FRU not being securely fastened in place.

After installing FRUs, check that the computer operates correctly.

Tools and Equipment

For your safety and the safety of the people around you, it is important that you use Electrostatic Discharge (ESD) equipment. Correctly utilizing of the equipment increases the percentage of successful repairs and saves on the cost of damaged or destroyed parts. The following equipment is required for disassembly and assembly.

- One Philips screwdriver with type 0 bit (for THIN HEAD screws)
- One Philips screwdriver with type 1 bit (for screws other than above)
- Tweezers (for lifting screws)
- ESD mats (lay on work table or floor)
- An ESD wrist strap and heel grounder
- Anti-static carpet or flooring

Screw Tightening Torque

Use the following torque when tightening screws.

CAUTION: *Overtightening may damage screws or parts. Undertightening may allow screws to loosen (and possibly fall out) causing a short circuit or other damage.*

NOTE: *To tighten screws quickly and accurately, an electric screwdriver is recommended.*

- M2 (2mm) 0.167 N· m (1.7 kgf· cm)
- M2.5 (2.5mm) 0.392 N· m(4.0 kgf· cm) for Hinge support

NOTE: *To prevent damage to THIN HEAD screws, press along the axis of the screwdriver while turning the screw. This is because the contact area between the screw and driver is less than for a pan head screw (standard pan-shaped screw head).*

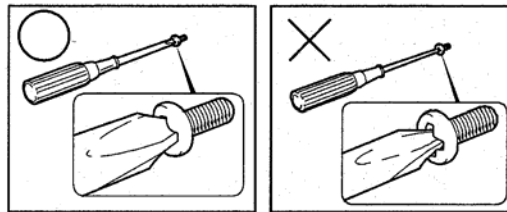

Grip Color

Some screws have a colored grip area to help you determine the length of the screw.

- Even numbered length screws: Brown
- Odd numbered length screws: White
- Special length screw: Blue



“Special length screw” means screws whose length is indicated in an integral number to the first decimal places such as 2.5 mm, 2.8 mm and so on.

Screw Notation

To make maintenance of the computer easier, markings of the kinds of the screws including the types and lengths are indicated on the computer body.

Format:

Screw shape + Screw length (mm)

Screw shape

B: Bind screw

F: Thin head screw

S: Super thin head screw

T: Tapping screw

U: Other screws (Unique screws: pan head, stud, etc.)

Example: B6 ... 6mm bind screw

4.2 Battery Pack

Removing the battery pack

The following describes the procedure for removing the battery pack (See Figure 4-2-1).

CAUTION: Take care not to short circuit the terminals when removing the battery pack. Similarly, do not drop, knock, scratch, disassemble, twist, or bend the battery pack.

1. Turn off the power of the computer.
2. Disconnect the AC adapter and all external devices from the computer.
3. Turn the computer upside down.
4. Slide and hold the battery release latch (2) to free the battery pack after moving the battery release latch (1) into its unlock position – pick the battery pack out of the computer from the filler.

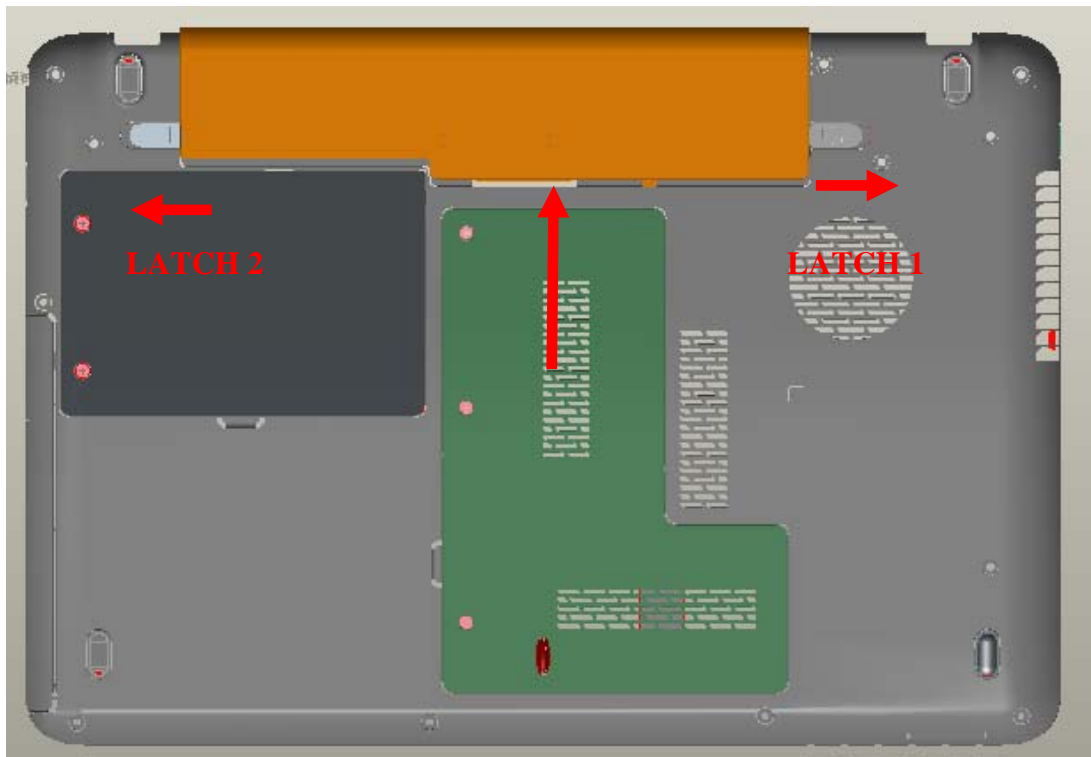

Figure 4-2-1 Remove the battery pack

NOTE: *Dispose of the used battery pack in accordance with the laws and ordinances of your local authority.*

Installing the battery pack

The following describes the procedure for installing the battery pack (See Figure 4-2-2).

CAUTION: *There is a danger that the lithium ion battery pack may explode if not fitted, operated, handled, or disposed correctly. Dispose always the used battery pack in accordance with the laws and ordinances of your local authority. Use only the batteries approved by Toshiba.*

NOTE: *Check visually the battery terminals and clean off any dirt with a dry cloth.*

1. Turn off the power of the computer.
2. Disconnect the AC adapter and all external devices from the computer.
3. Attach the **battery cover** to the **battery pack**.
4. Insert the battery pack
5. Ensure the battery release latch (2) is moved into its locked position

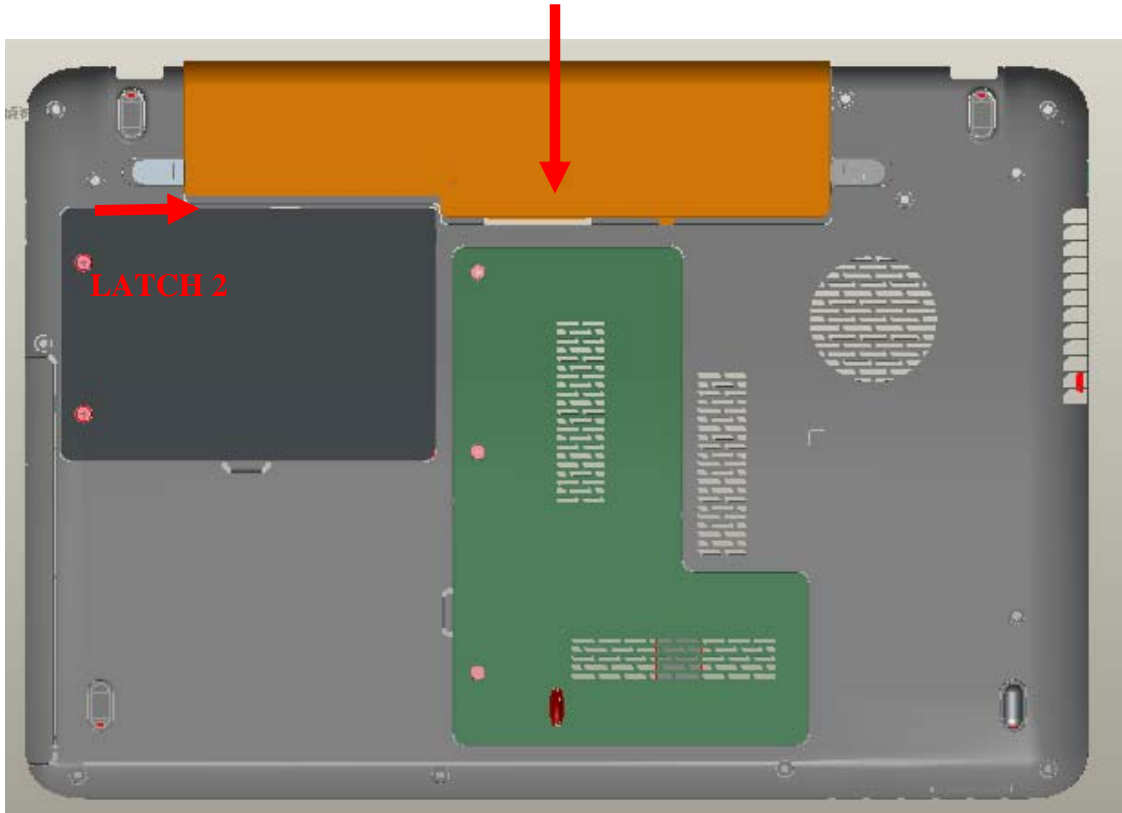

Figure 4-2-2 Install the battery pack

4.3 HDD/SSD

Removing a HDD/SSD-H9.5mm

The following describes the procedure for removing the HDD/SSD (See Figure 4-3-1 to 4-3-3).

CAUTION: Take care not to press on the top or bottom of a HDD/SSD. Pressure may cause data loss or damage to the device.

1. Turn the computer upside down.
2. Remove the following **screws** securing a HDD/SSD slot cover
M2.0×4.0B BIND screw x2
3. Remove the following **screws** securing the **HDD/SSD assembly**.
 - M3.0×3.0B FLAT BIND screw x2
4. Disconnect the **HDD/SSD assembly** from the connector on the mother board.

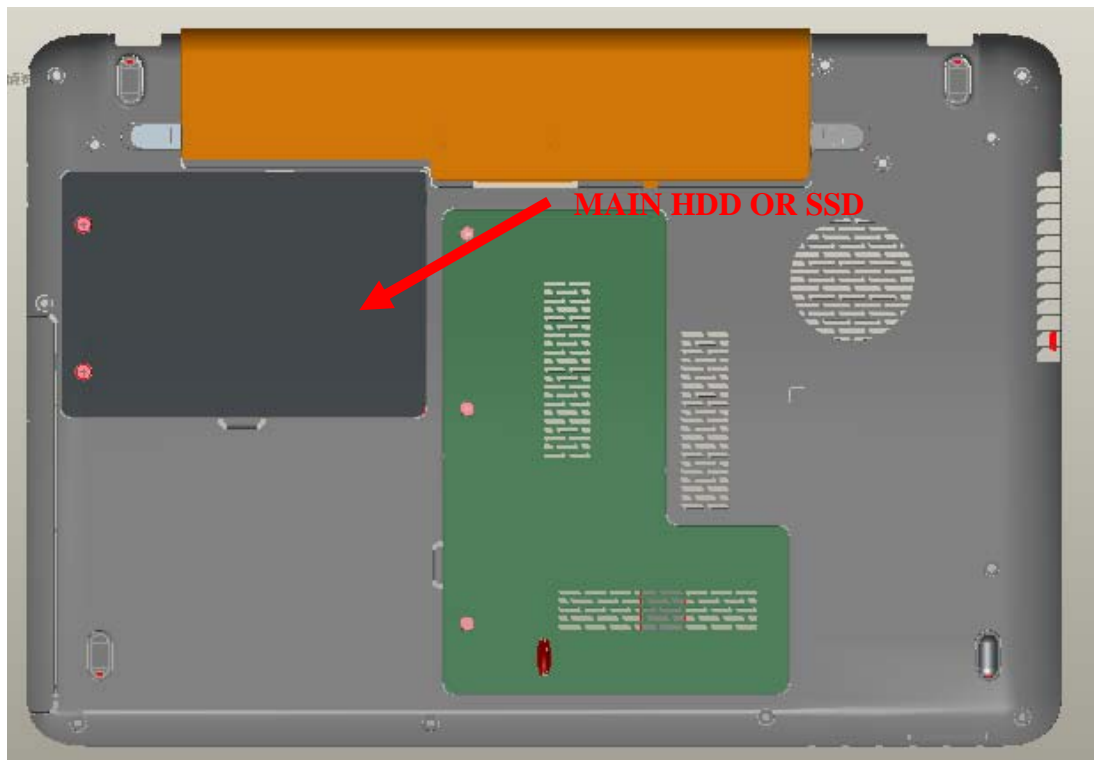

Figure 4-3-1 Turn the computer upside down

CAUTION: When a HDD/SSD is installed, they are installed in the position as the following figure.

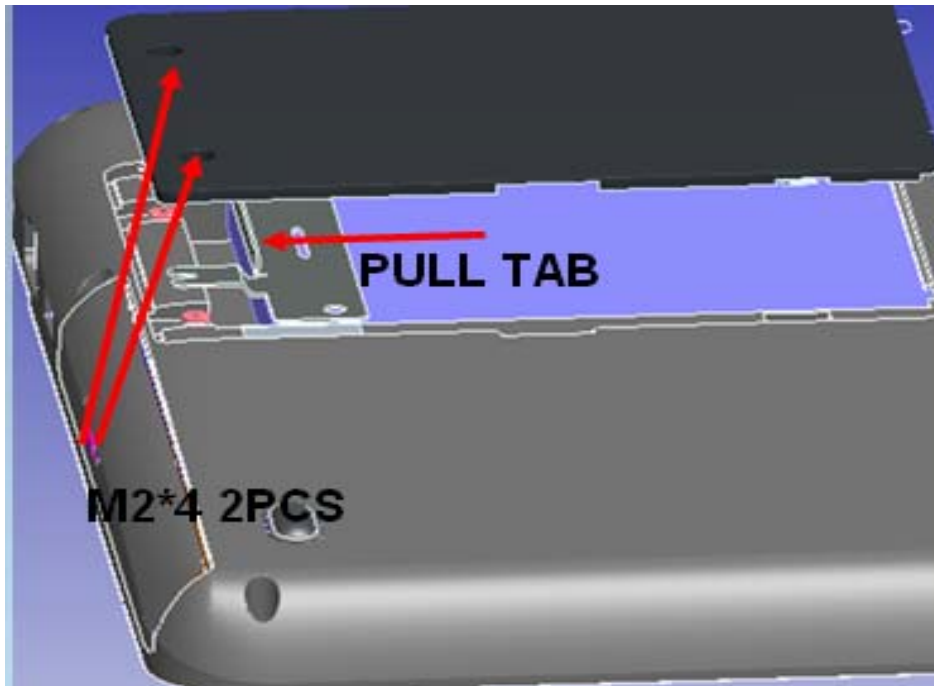

Figure 4-3-2 Remove HDD/SSD assembly

5. Remove the following **screws** securing the HDD/SSD holder and remove the **HDD/SSD holder**.

- M3.0×3.0B FLAT BIND screw x2

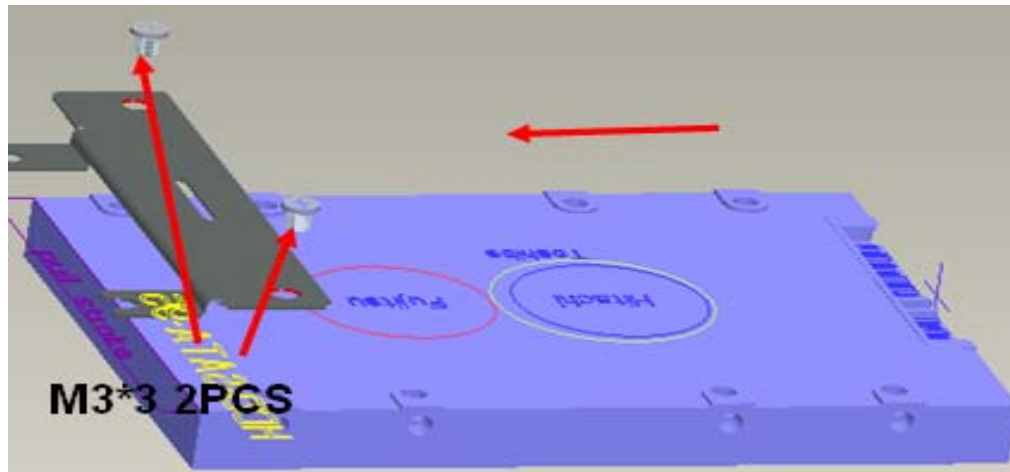

Figure 4-3-3 Remove HDD/SSD

Installing HDD/SSD-H9.5mm

The following describes the procedure for installing the main HDD/SSD.

1. Install a HDD/SSD to the **HDD/SSD holder** and secure it with the following **screws**.

- M3.0×3.0F FLAT BIND screw x2

NOTE: Although they are 3mm head screws, screw torque must be set in 2.5kg-cm for four screws securing the HDD/SSD holder.

2. Insert the **HDD/SSD assembly** into the HDD/SSD slot and connect it carefully to the **MAIN HDD/SSD** on the mother board.

3. Secure the **HDD/SSD assembly** with the following **screw**.

- M2.0×4.0B BIND screw x2

4.4 Memory Module

CAUTION: *The power of the computer must be turned off when you remove a memory module. Remove a memory module with the power on risks damaging the module or the computer itself.*

Do not touch memory module terminals. Any dirt on the terminals may cause memory access problems.

Never press hard or bend a memory module.

Removing a memory module

To remove a memory module, confirm that the computer is in boot mode. Then perform the following procedure (See Figure 4-4-1 to 4-4-2).

1. Loosen the **screw** securing the **memory slot cover**.
2. Remove the **memory slot cover**.
3. Open the left and right **latches** and remove a **memory module**.

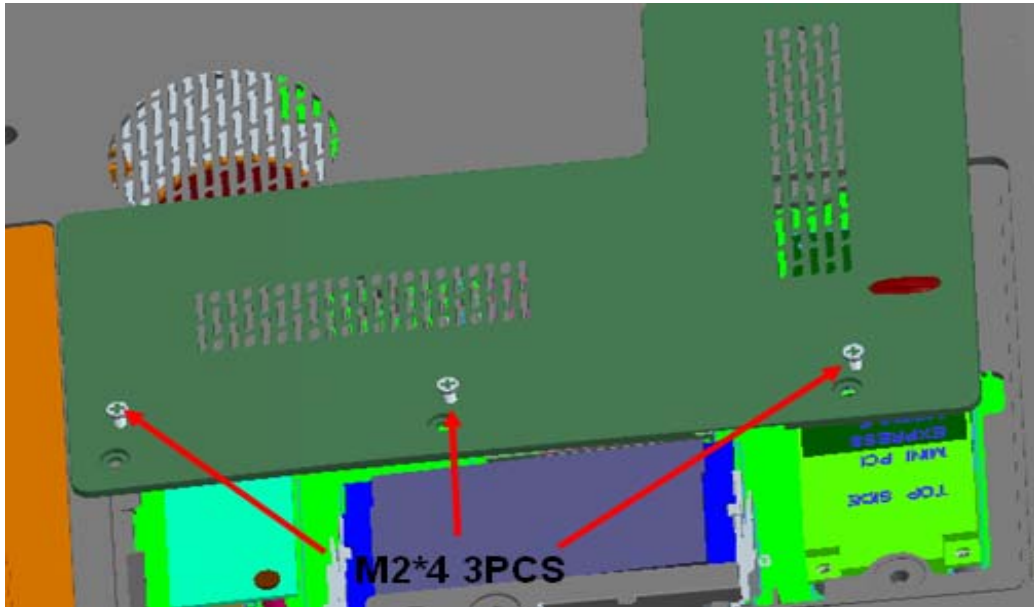

Figure 4-4-1 Remove memory slot cover

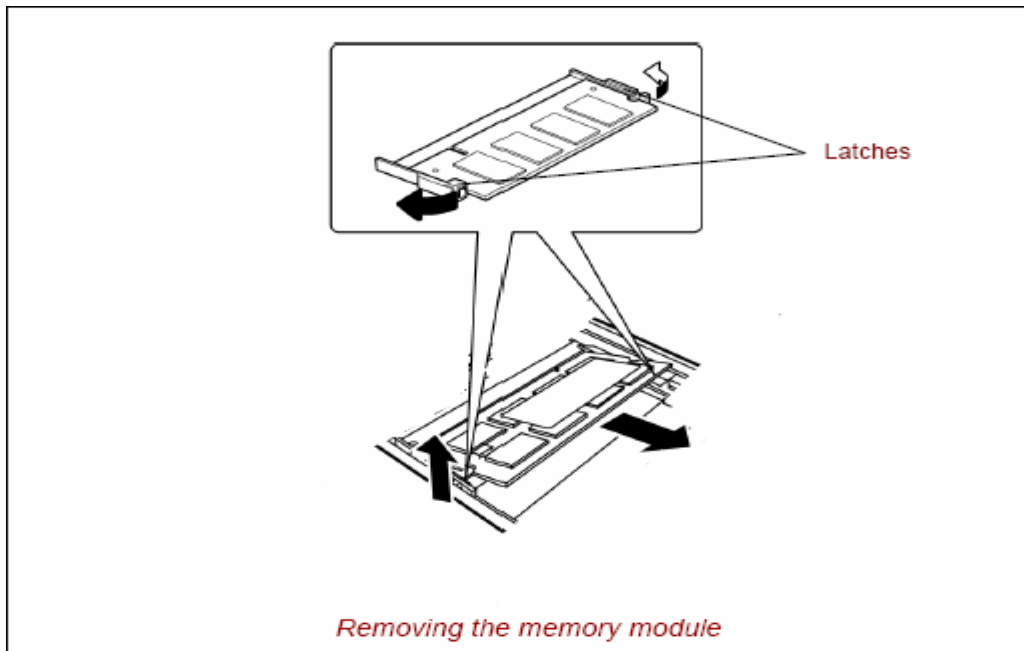

Figure 4-4-2 Remove a memory module

Installing a memory module

To install a memory module, confirm that the computer is in boot mode. Then perform the following procedure (See Figure 4-4-3).

1. Insert a **memory module** into the connector of the computer slantwise (terminal side first) and press it to connect firmly.

CAUTION: *The power must be turned off when you insert a memory module. Inserting a memory module with the power on might damage the module or the computer itself.*

Never press hard or bend a memory module.

2. Install the **memory slot cover** and secure it with the **screw**.
3. When the power of the computer is turned on, the computer checks automatically the memory size. Confirm that the new memory is detected correctly.
4. If the memory is not detected, check that it is connected correctly.

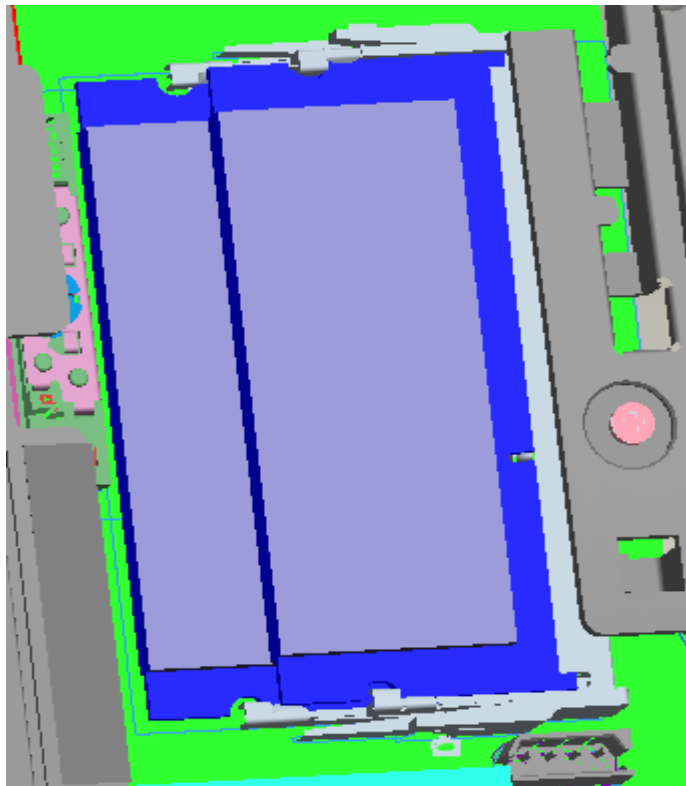

Figure 4-4-3 Insert a memory module

4.5 Keyboard

Removing the keyboard

The following describes the procedure for removing the keyboard (See Figure 4-5-1 to 4-5-2).

CAUTION: *As the keycap may fall out, when handling the keyboard always hold it by the frame and do not touch the keycap.*

1. Upside down the computer and remove the battery.
2. Loose the screws on KB holder.
M2.0x3.0B BIND screws x2
3. Open the display.
4. Insert your finger into the slot between the KB holder and the keyboard. Then, lift up the **keyboard holder** to remove it.
5. Loose the **screw** securing Keyboard.
M2.0x3.0B BIND screws x3
6. Insert your finger into the slot between keyboard and Top cover Assembly. Then lift up the **keyboard** to remove it.
7. Disconnect keyboard cable.

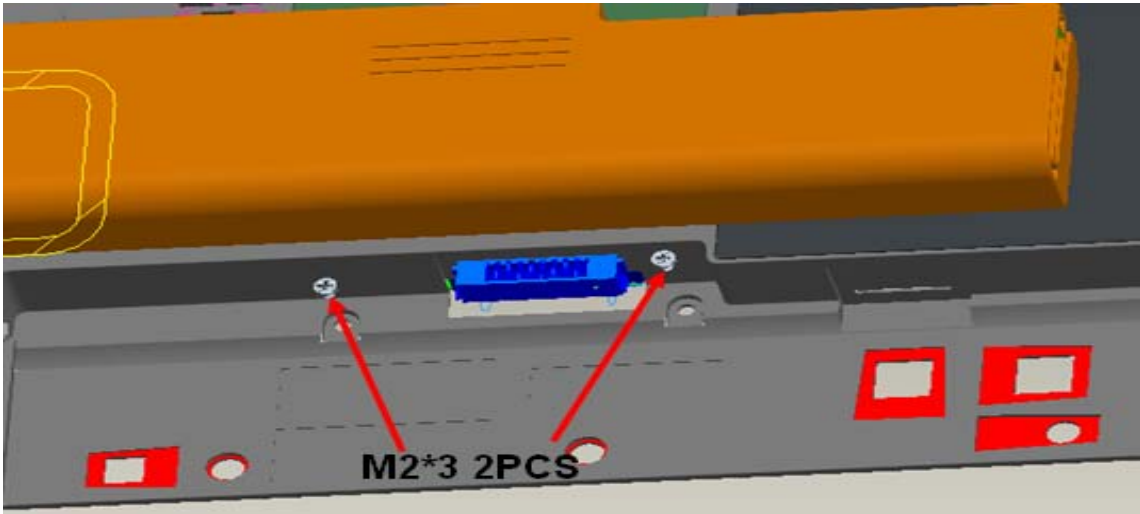

Figure 4-5-1 Remove 2 screws for KB Holder

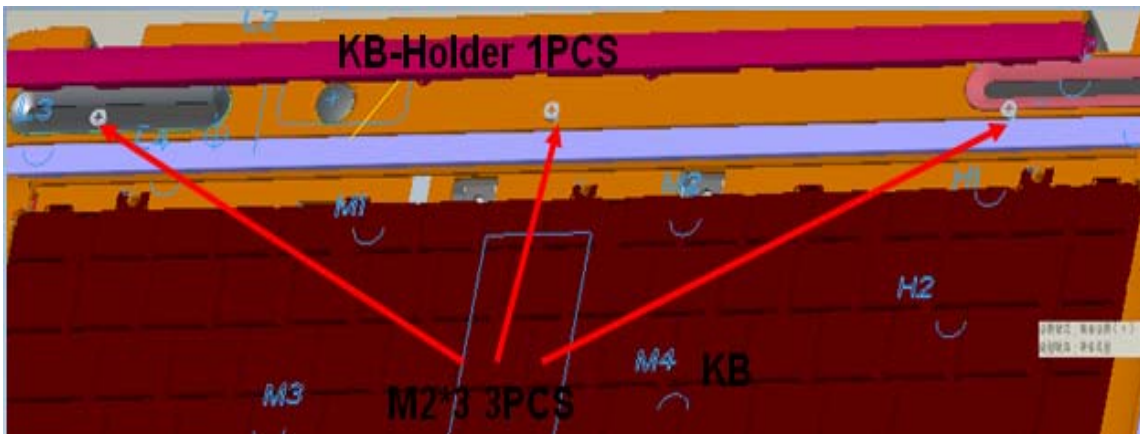

Figure 4-5-2 Remove 3 screws for Keyboard

Installing the keyboard

The following describes the procedure for installing the keyboard.

1. Connect the **keyboard flexible cable** to the connector on the mother board.
2. Slide and set the **keyboard** then secure it with the following **screw**.
 - M2.0×3.0B BIND screw x3
3. Install the **K/B holder** by pressing it from the topside.
4. Upside down the computer and secure the **KB holder** with the following screw.
 - M2.0×2.0B BIND screw x2

4.6 Wireless LAN Card

Removing a Wireless LAN card

The following describes the procedure for removing a Wireless LAN card (See Figure 4-6-1 to 4-6-2).

1. Remove the screw of **wireless LAN card**.
 - M2x 5.0B BIND screw x2
2. Disconnect the **wireless LAN antenna cable** from the connectors on a wireless LAN card.
3. Remove a **wireless LAN card** from the **connector** on the mother board.

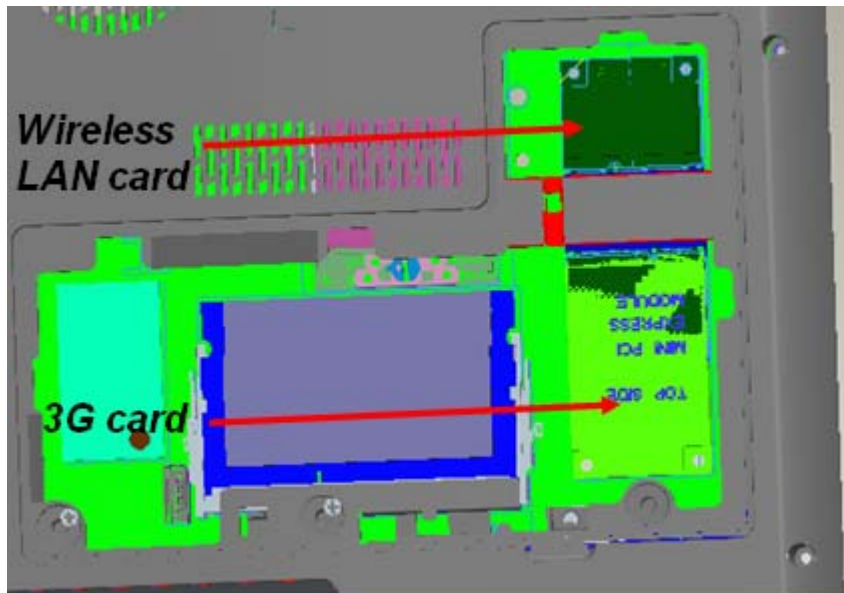

Figure 4-6-1 Wireless LAN card

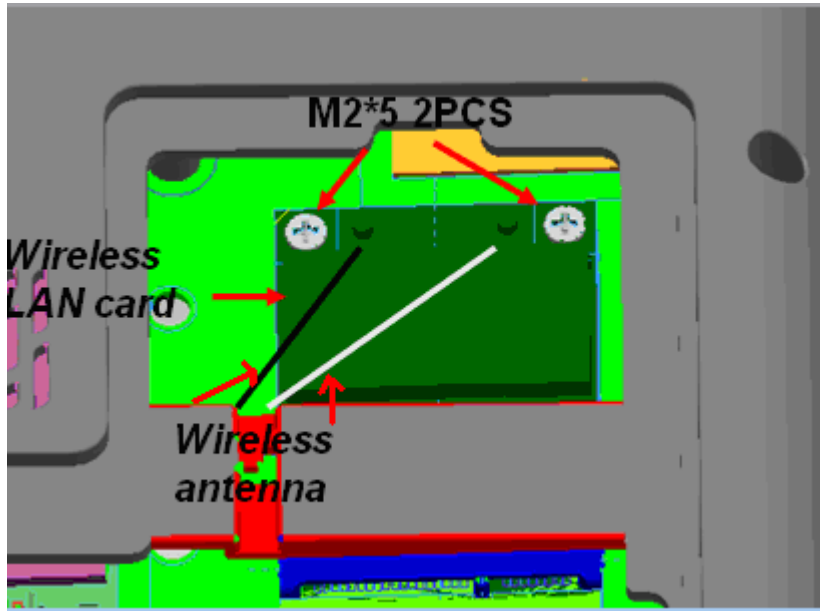

Figure 4-6-2 Remove a wireless LAN card

Installing a Wireless LAN card

The following describes the procedure for installing a Wireless LAN card.

1. Insert a **wireless LAN card** terminals slantwise into the connector on the computer and press a wireless LAN card and lock the secure screws.
2. Connect the **wireless LAN antenna cable** to the terminals on a wireless LAN card.
3. Put the **wireless LAN antenna cable** on the right location from the guide.

4.7 3G Module Card

Removing 3G module card

The following describes the procedure for removing a 3G module card (See Figure 4-7-1 to 4-7-2).

1. Remove screws of 3G module card.
 - M2x 5 BIND screw x2
2. Disconnect the **3G module antenna cable** from the connectors on a 3G module card
3. Remove a **3G module card** from the **connector** on the mother board.

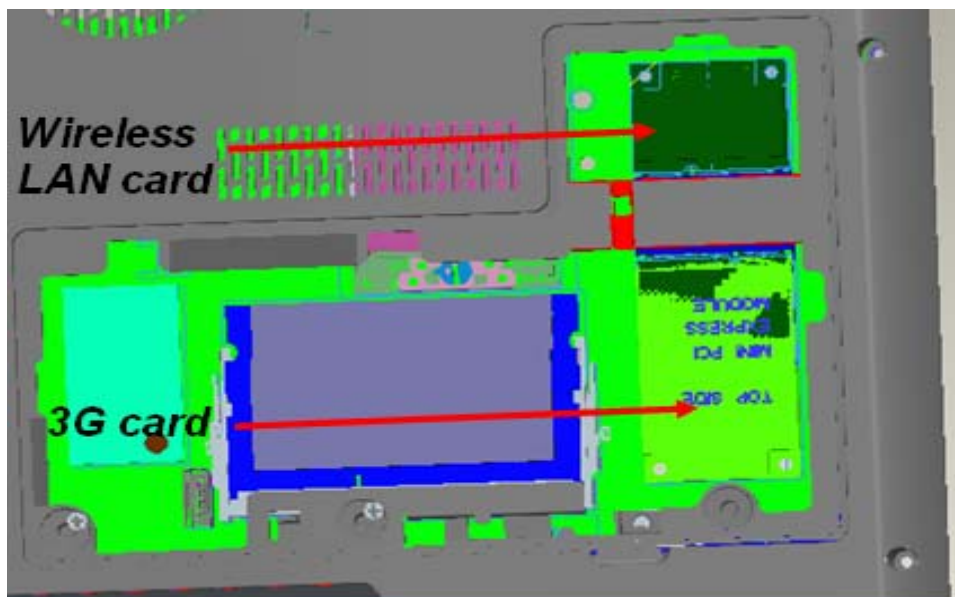

Figure 4-7-1 3G module card

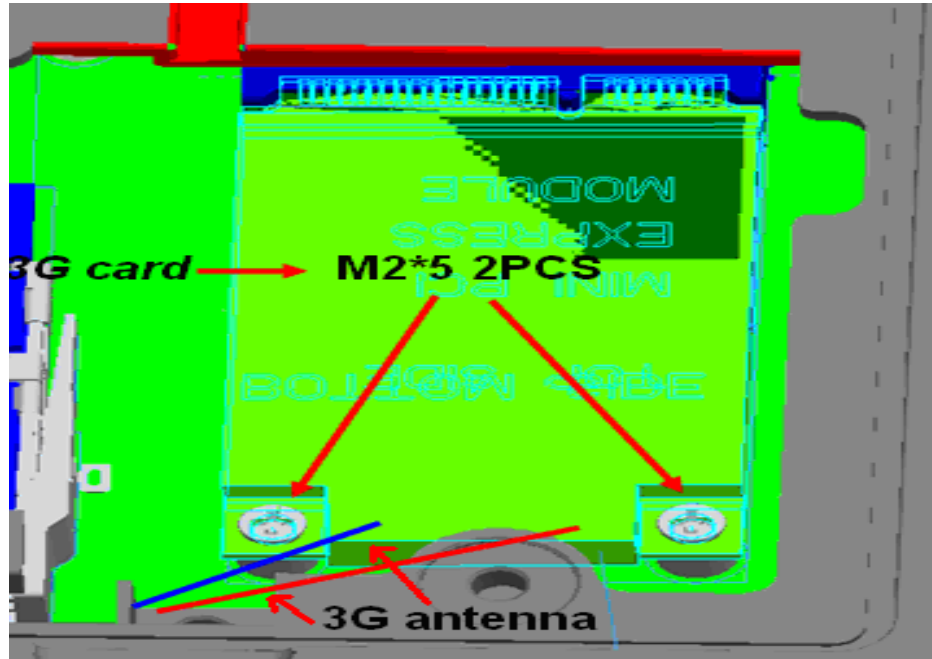

Figure 4-7-2 Remove a 3G module card

Installing a 3G module card

The following describes the procedure for installing a 3G module card. (See Figure 4-7-3)

1. Insert a **3G module card** terminals slantwise into the connector on the mother board and press a **3G module card** and lock the secure screws.
2. Connect the **3G module antenna cable** to the terminals on a 3G module card.
3. Put the **3G module antenna cable** on the bottom location from the guide.

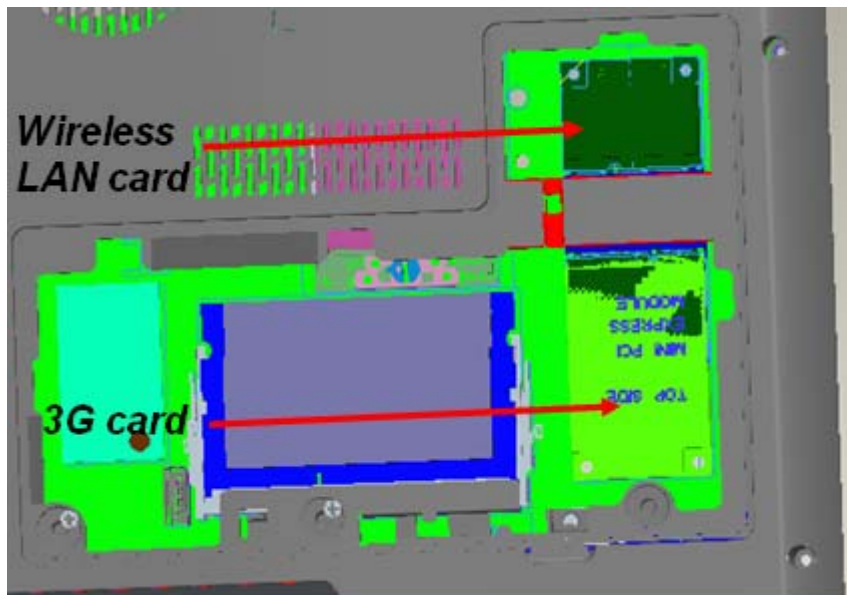

Figure 4-7-3 Installing a 3G module card

4.8 Display Assembly

Removing the display assembly

The following describes the procedure for removing the display assembly (See Figure 4-8-1 to 4-8-7).

1. Close the display and turn the computer upside down.
2. Remove the battery pack (See Figure 4-2-1)
3. Open RAM Door and remove memory slot cover (See Figure 4-4-1)
4. .Remove the screws of the ODD and ODD Bezel.

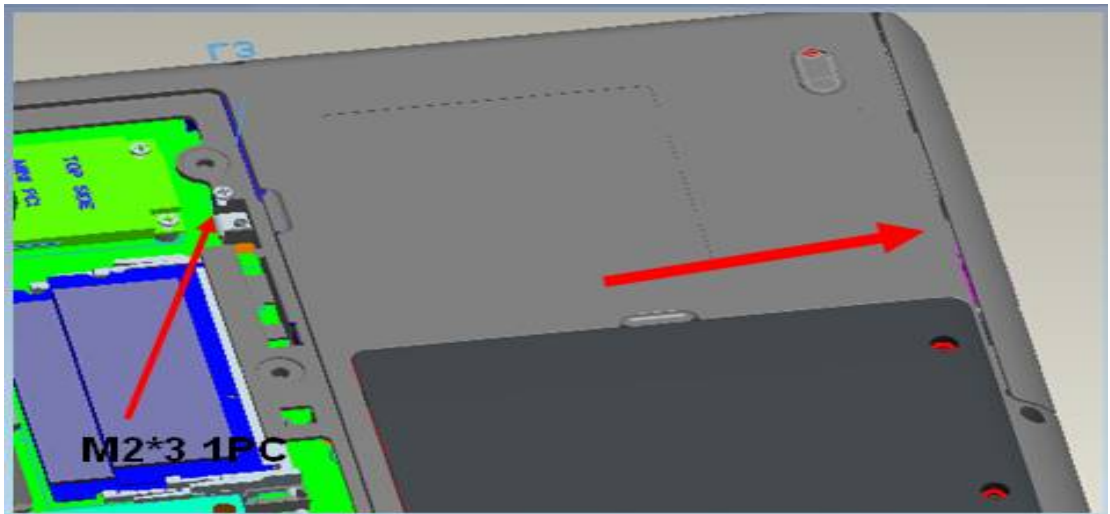

Figure 4-8-1 Remove the screw on ODD Bezel and ODD

5. Remove the screws from the bottom side.

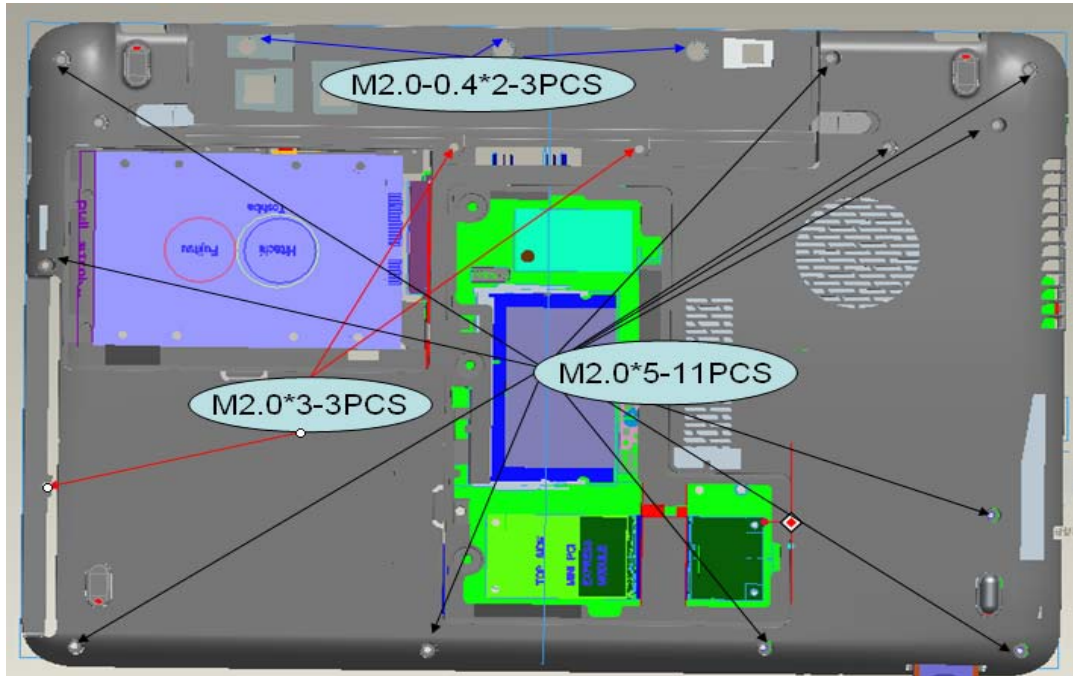

Figure 4-8-2 Remove the screws (from bottom side)

5. Disassemble **KB Holder** and **KB** screws (See Figure 4-5-1)
6. Remove the screws from the top side and remove the cover.

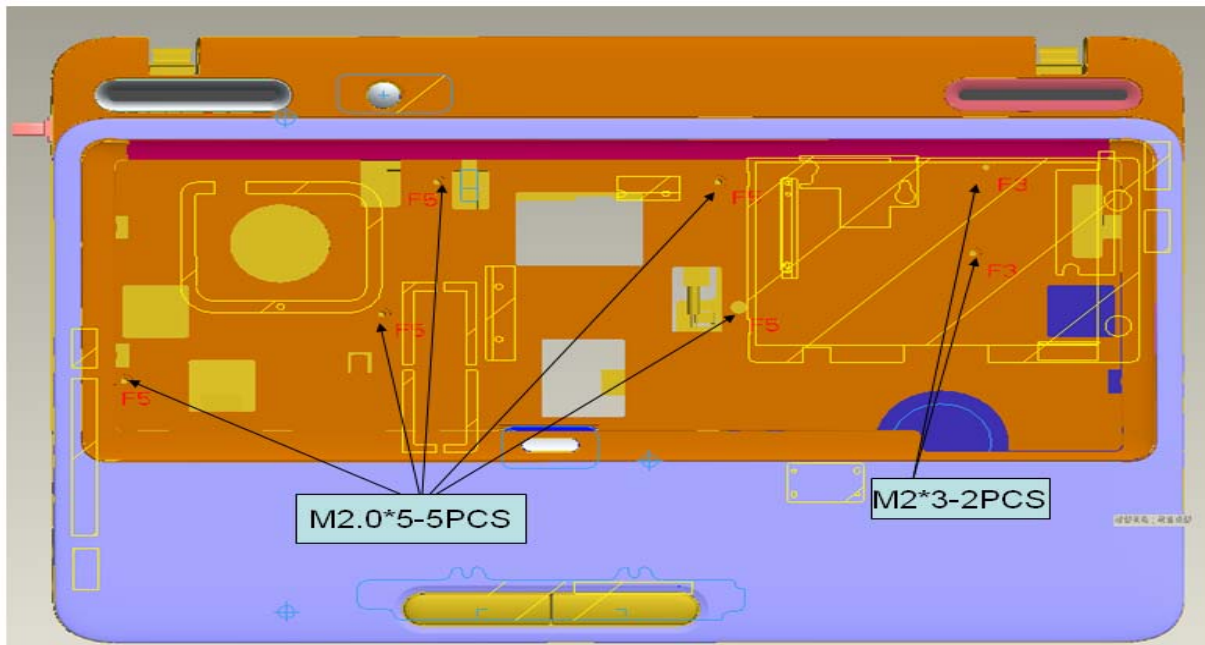

Figure 4-8-3 Remove the screws (from top side)

7. Disconnect the FFC and cables.
8. Disassembly TOP cover assembly
9. Pull out the **wireless LAN antenna** from the guide with two hands.

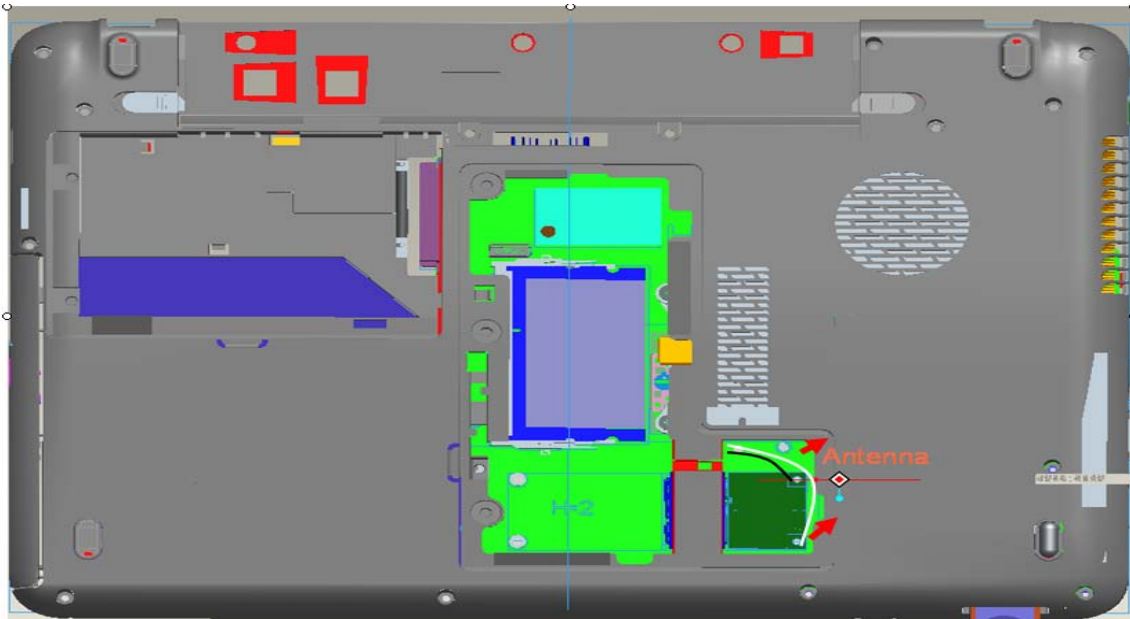

Figure 4-8-4 Remove the Wireless Antenna

10. Pull out the **LCD cables** from the guide of mother board.

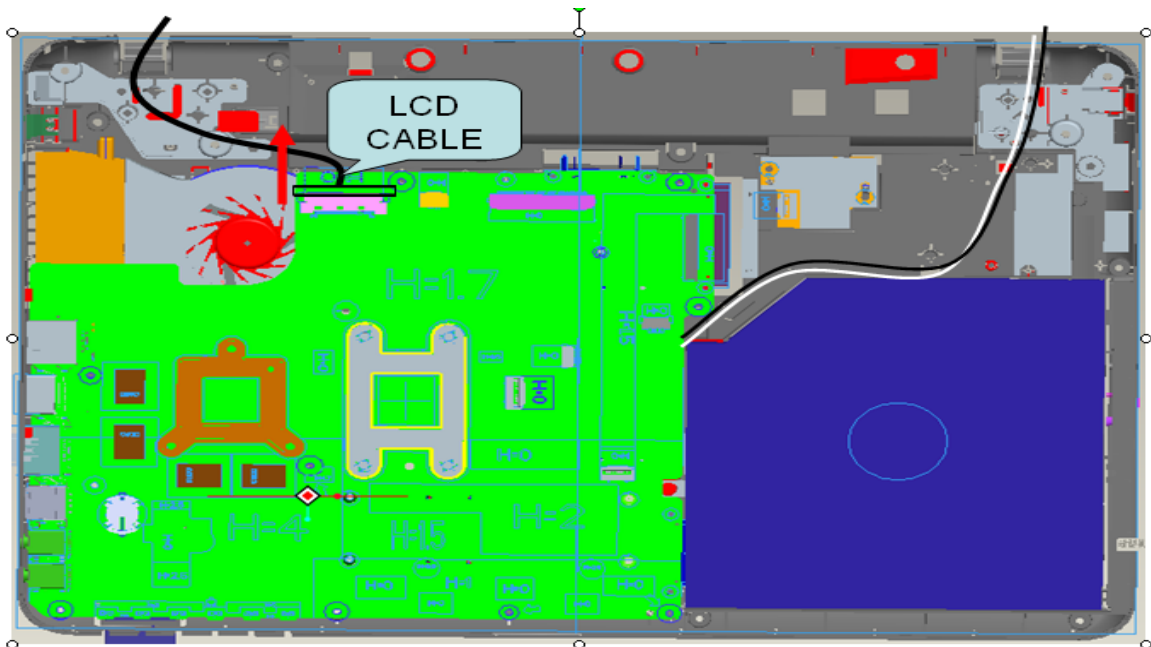

Figure 4-8-5 Remove the LCD cable from mother board

11. Pull out the **LCD cables** from the guide of LCD panel.



Figure 4-8-6 Remove the LCD cable from LCD panel

Opening the display to 135degree, keeping display side by hand and remove the hinge screw.

- M2.5×5 FLAT BIND screw x4(Lock tight)

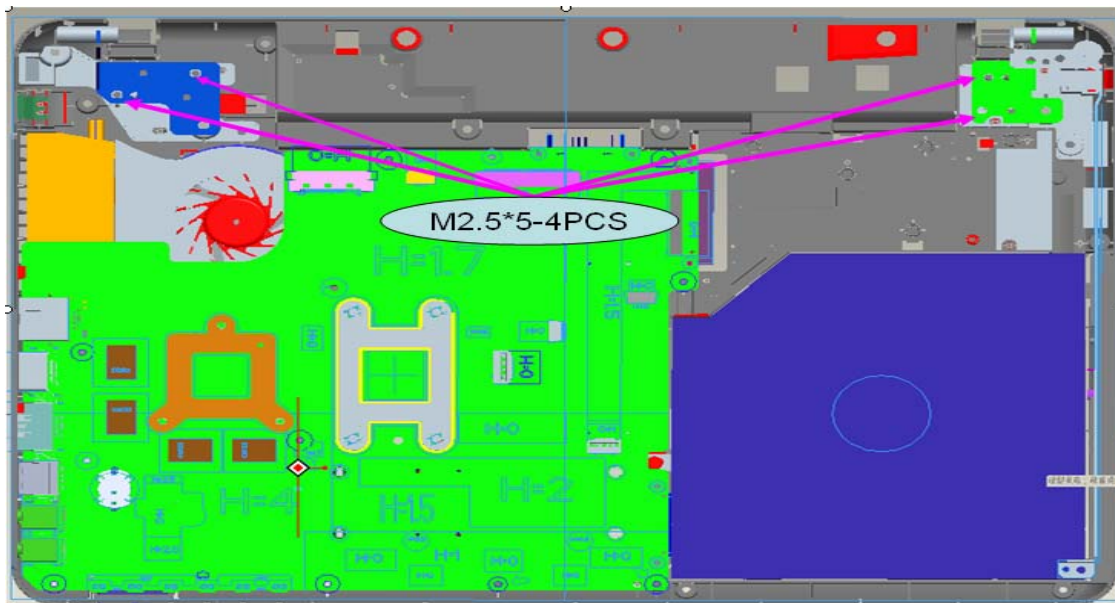

Figure 4-8-7 Remove the hinge screws

12. Remove the **display assembly** with two hands holding from the BASE cover assembly.

Installing the display assembly

The following describes the procedure for installing the display assembly. (See from Figure 4-8-8 to 4-8-10)

1. Inserting the **pole of hinge** to the **hole** of hinge assembly, set the **display assembly** with hands on the base assembly.
2. Secure the **hinges** with the following **screws** secure the **display mask** with the following **screws** and stick the **mask seal** on them.

- M2.5×5 FLAT BIND screw x4(Lock tight)

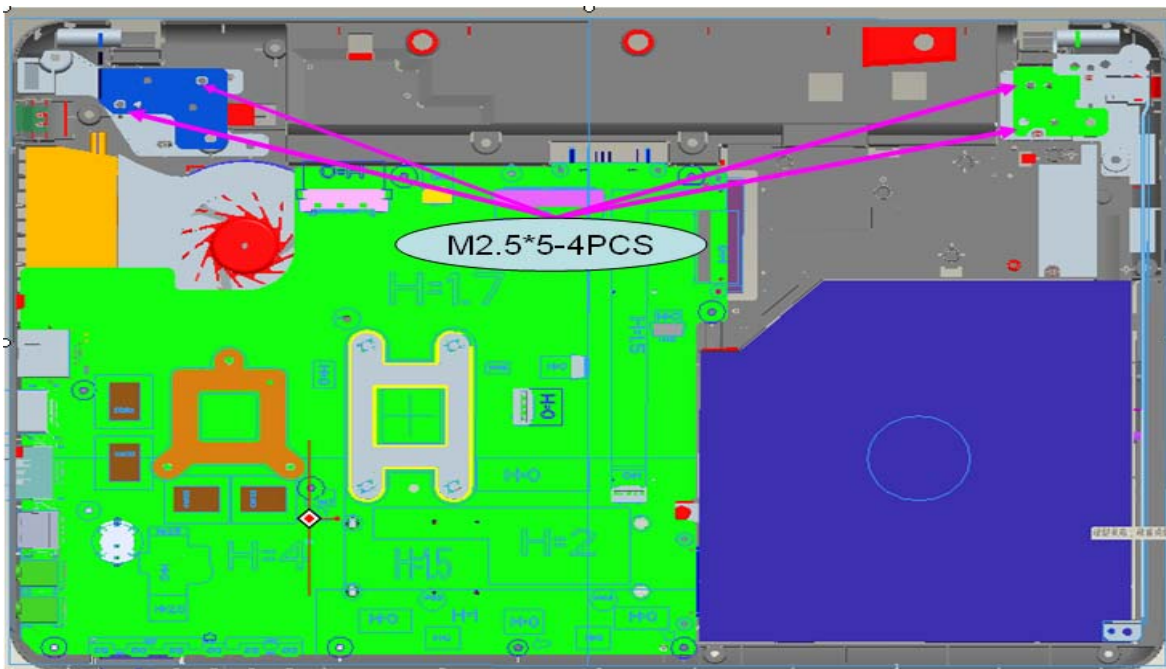

Figure 4-8-8 Securing the hinge screws

NOTE: Be sure to apply the locktight to the screws instructed in the figure above.

3. Connect the **LCD harness** to the connector on the mother board.



Figure 4-8-9 Connecting LCD harness to the mother board

4. Arrange the wireless antenna cables along the guide (front) and secure them with guide.
5. Pass the cables to the back of computer through the slot.
6. Arrange the **Wireless LAN antenna** along the guide and contact with the connector with hands.

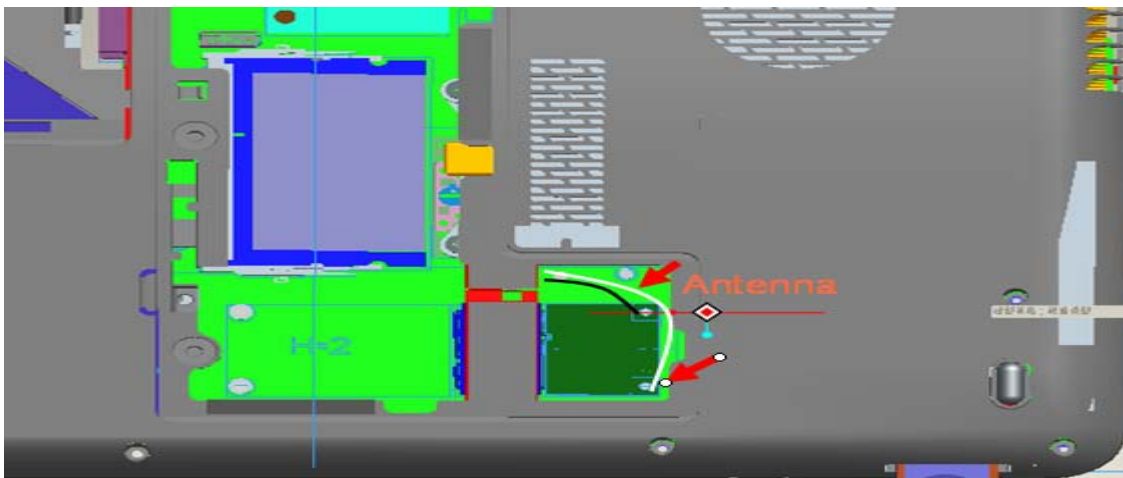

Figure 4-8-10 Arranged and connect Wireless LAN antenna

7. Install the LAN board and Top cover assembly of the system.

NOTE: If Fingerprint or Dust left on LCD screen during disassembly and assembly LCD units, please follow Appendix A to clean it.

4.9 Top Cover Assembly

Removing the Top cover assembly

The following describes the procedure for removing the Top cover assembly (See Figure 4-9-1 to 4-9-5).

1. Turn over the computer and open the door.
2. Remove memory slot cover. (See Figure 4-4-1).
3. Remove the screws of the ODD and ODD Bezel. (See Figure 4-8-1)
4. Remove the following **screws** securing the Top cover assembly from the back and bottom of computer.
 - M2-0.4×2 FLAT BIND screw Back x3
 - M2.0×3 FLAT BIND screw Back x3
 - M2.0×5.0 FLAT BIND screw Back x11

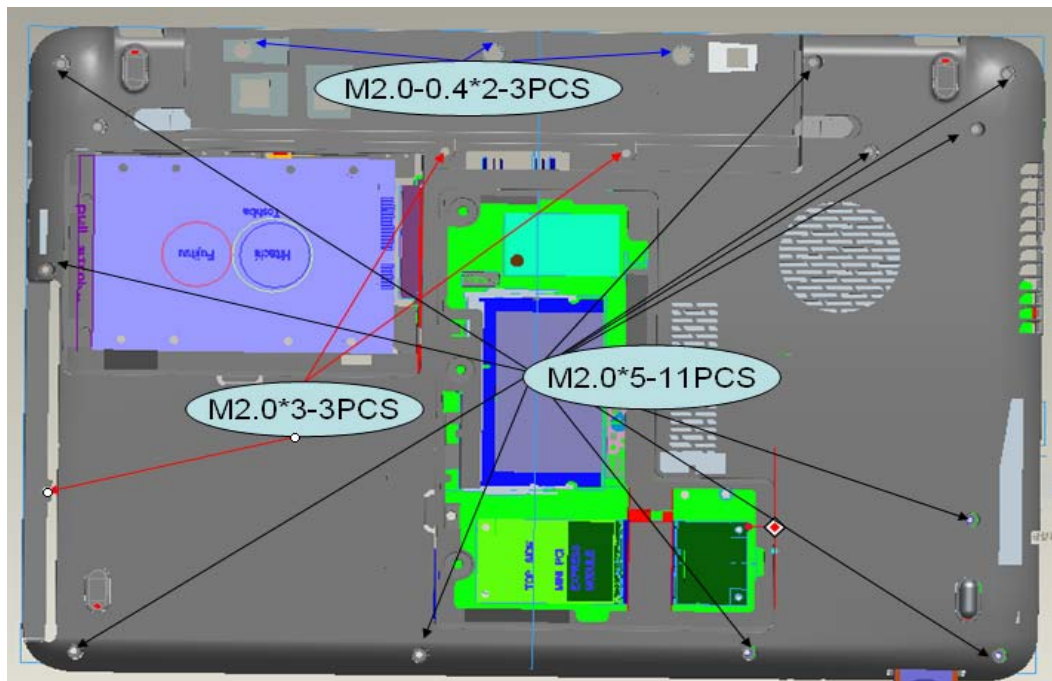

Figure 4-9-1 Remove the screws (back)

- Remove the following **screws** securing the Top cover assembly from the front of computer. Pull up and remove the **Top cover assembly** from the **Base cover assembly**.

M2.0×5.0 FLAT BIND screw Back x5

M2.0X3.0 FLAT BIND screw Back x2

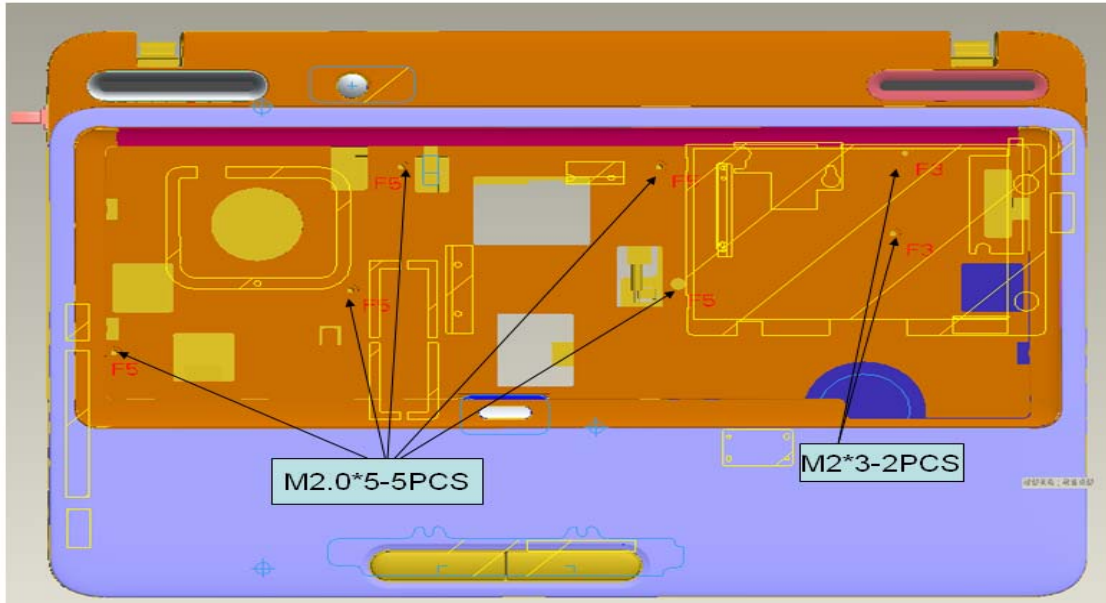

Figure 4-9-2 Remove the screws (front) and Top cover assembly

- Disconnect the **touch pad cable/BT cable/Speaker cable/ power cable** from the connector on the mother board.

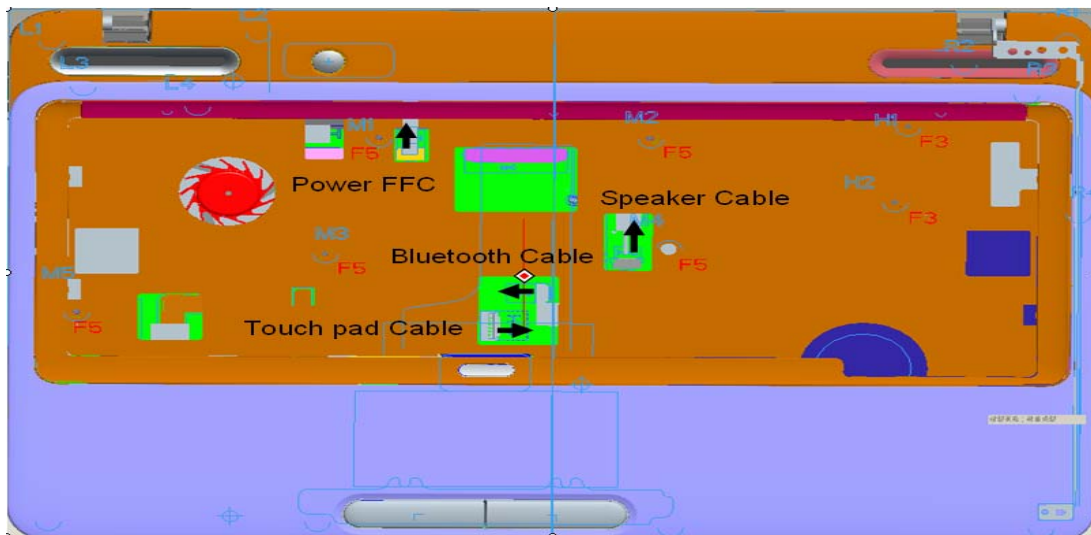

Figure 4-9-3 Disconnect the touch pad cable/BT cable/speaker cable/power cable

Installing the Top cover assembly

The following describes the procedure for installing the Top cover assembly.

1. Install the **Top cover assembly** to the Base cover assembly.

<p>NOTE: <i>Be careful not to catch the cables between Top cover assembly and Base assembly.</i></p>

2. Connect the **touch pad cable/BT cable/Speaker cable/ power cable** to the connector on the mother board.
3. Secure the Top cover assembly with the following **screws** from the back and bottom of computer.

M2.0×5.0	FLAT BIND screw	Back	x5
M2.0X3.0	FLAT BIND screw	Back	x2
M2-0.4×2	FLAT BIND screw	Back	x3
M2.0×3	FLAT BIND screw	Back	x3
M2.0×5.0	FLAT BIND screw	Back	x11

4. Free the cable from cable-drain when through the antenna cable to PCB hole.
5. Installing ODD and securing the screws on ODD Bezel and memory slot cover.

4.10 Touch Pad

Removing the touch pad

The following describes the procedure for removing the touch pad (See Figure 4-10-1 to 4-10-3).

1. Peel off the **glass tape** and disconnect the **touch pad cable, touch pad board cable** from the connector on the touch pad.
2. Remove the following **screws** securing the Touch pad plate.
 - M2-0.4x2 SUPER THIN HEAD screw x2
 - M2.0x3.0 SUPER THIN HEAD screw x4
3. Remove the **touch pad board** and **touch pad plate** and **touch pad lock**.
4. Peel off and remove the **touch pad** from the **Top cover assembly**.

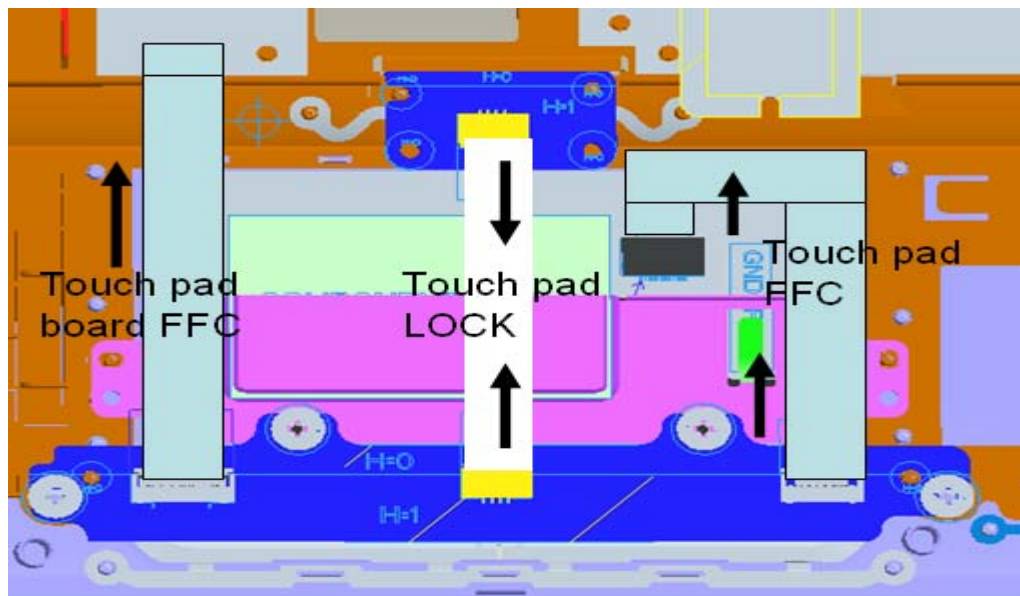

Figure 4-10-1 Remove the touch pad FFC cable

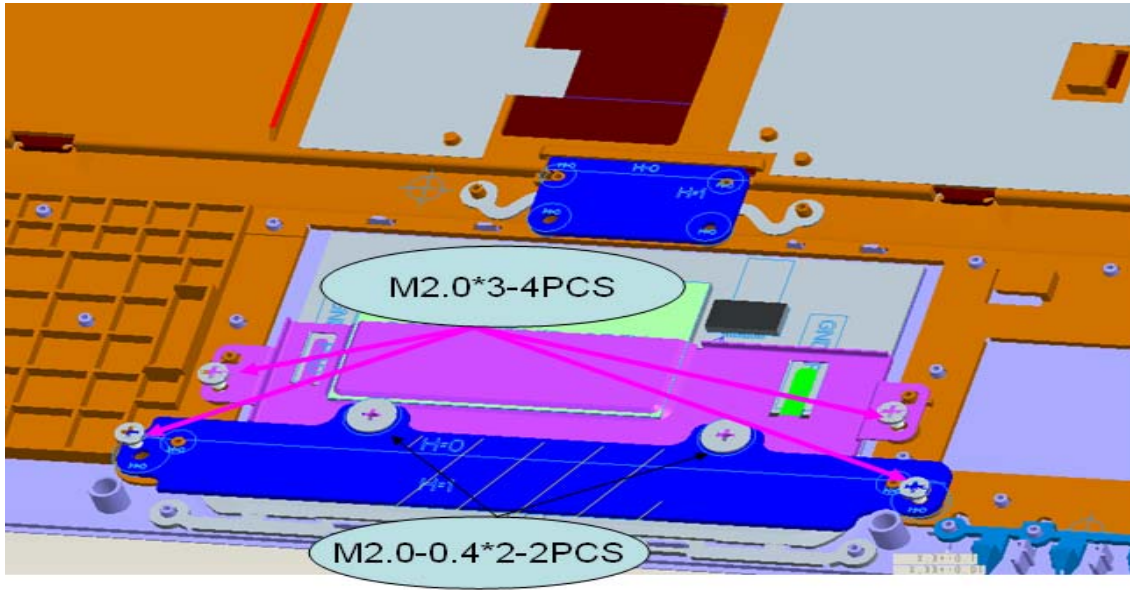

Figure 4-10-2 Loose the screws

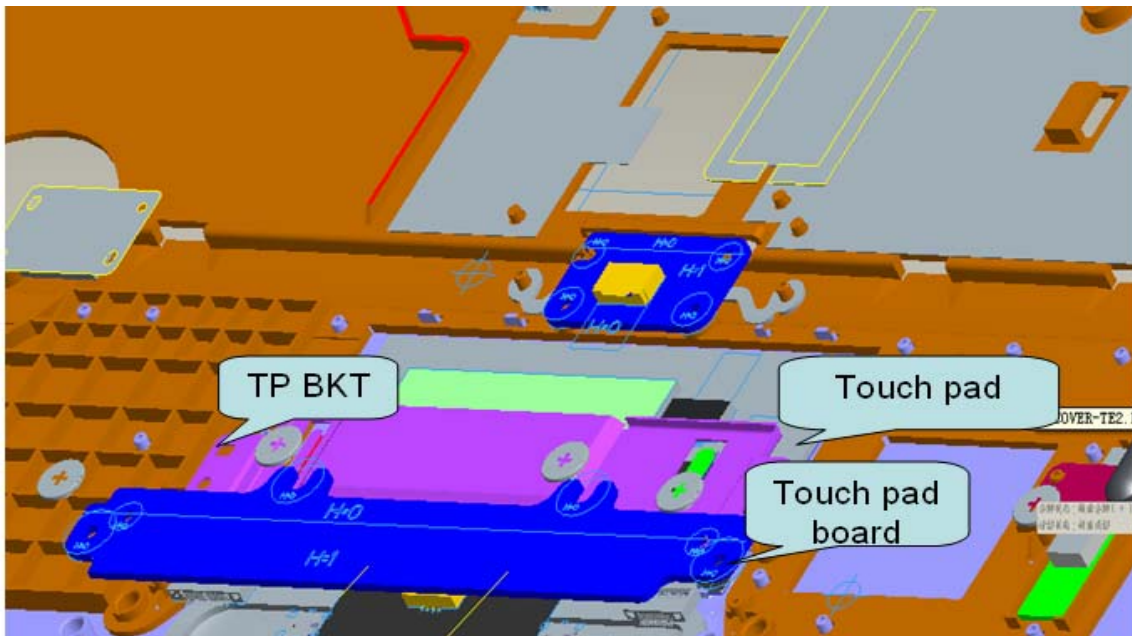

Figure 4-10-3 Remove the touchpad and touchpad board

Installing the touch pad

The following describes the procedure for installing the touch pad.

1. Peel off the separator covering on the sensor portion of a new touch pad.

NOTE: *Do not reuse the touch pad so that it can not be used after peeling off from the computer. Be sure to stick a new touch pad.*

When sticking the touch pad, be careful not to get the bubbles under the touch pad.

2. Stick and install the **touch pad** on the Top cover assembly.
3. Install the **touch pad plate** and secure it with the following **screws**.
 - M2-0.4x2 SUPER THIN HEAD screw x2
 - M2.0x3.0 SUPER THIN HEAD screw x4
4. Stick the **insulator** on the touch pad plate.
5. Connect the **touch pad flat cable** to the connector on the touch pad and stick the **glass tape** on the connector.

4.11 I/O Board

The following describes for removing the I/O Board (See Figure 4-11-1).

Removing the I/O Board

1. Pull out the **I/O Board FFC** from I/O board connector.
2. Loose the below **screws** and then incline pull out **I/O Board**.

- M2.0x3.0 FLAT BIND screw x1

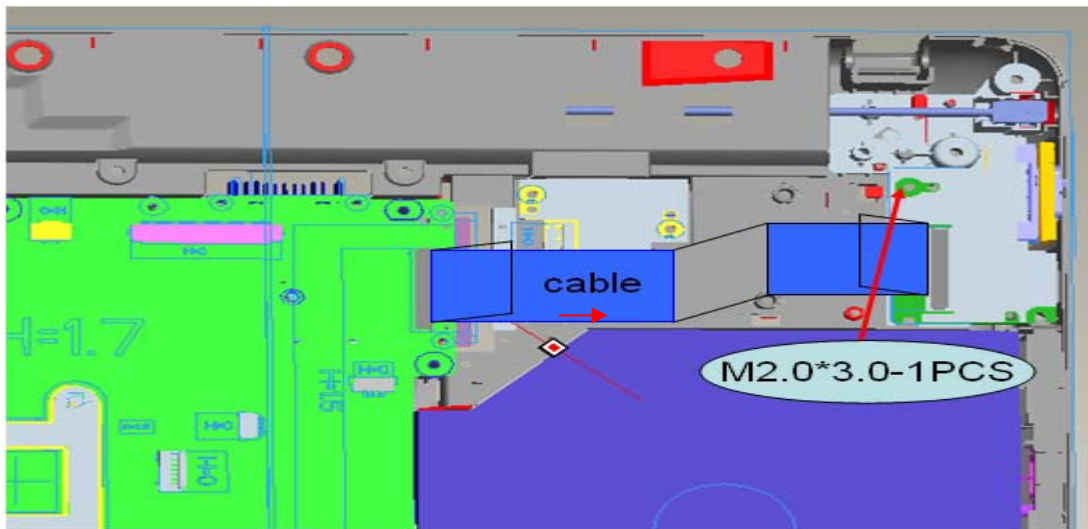

Figure 4-11-1 Remove the I/O Board

Installing the I/O Board

The following describes for installing the I/O Board

1. Fix the below **screws** then incline insert in **I/O Board**

M2.0x3.0 FLAT BIND screw x1

2. Insert the **I/O Board FFC** into base case and connect I/O board cable and speaker cable

NOTE: *Be careful not to catch the cables between Top cover assembly and base cover assembly.*

4.12 Mother Board

CAUTION: 1. when handling the mother board, always hold by the edges. Do not touch the printed circuit face.
2. If replacing with a new mother board then should use T&D software which is describing in the Chapter3.

Removing the mother board

The following describes the procedure for removing the mother board (See Figure 4-12-1).

1. Disconnect the **LCD cable, Antenna, I/O board FFC, BT wire, SIM FFC, TP board FFC, Power board FFC, DC-IN cable** from the connector on the mother board.
2. Remove the following **screws** securing the mother board and remove the **mother board**.

M2.0×5.0 screw x3

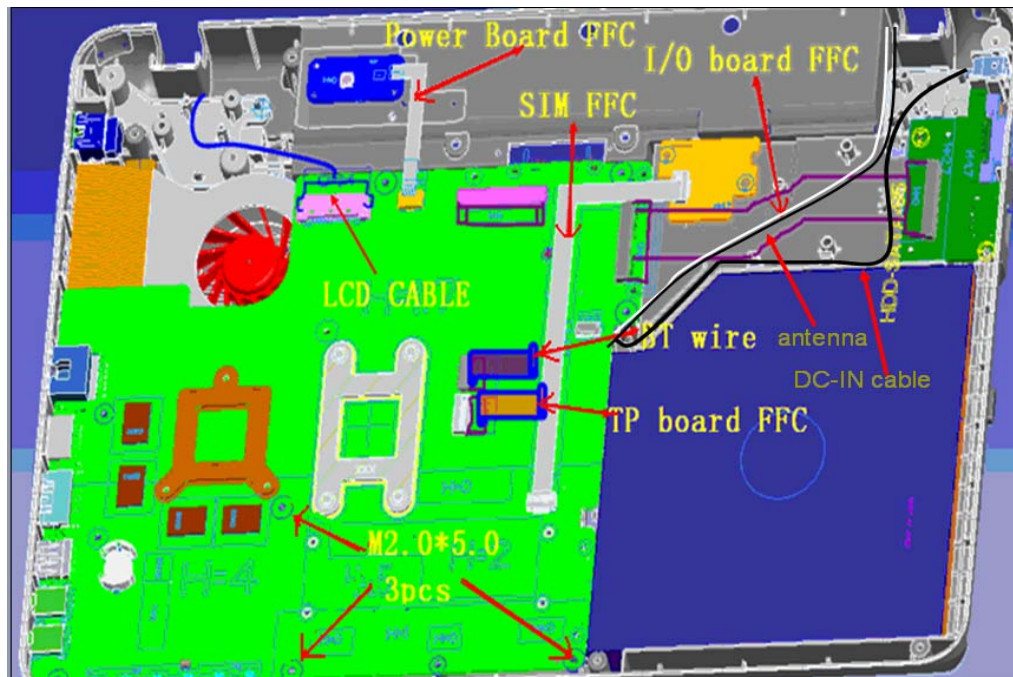

Figure 4-12-1 Remove the mother board

Installing the mother board

The following describes the procedure for installing the mother board.

1. Secure the mother board with the following **screws**.

M2.0×5.0 screw x3

2. Connect the **LCD cable, Antenna, I/O board FFC, BT wire, SIM FFC, TP board FFC, Power board FFC, DC-IN cable** to the connector on the mother board.
3. Connect the power cable to the connector on the mother board.

Removing RTC battery

The following describes the procedure for removing the RTC battery unit (See Figure 4-12-2 to 4-12-3).

1. Pull the away the socket of RTC battery and use a clamp to hold RTC battery tightly.
2. Rotate battery through the way then remove it.

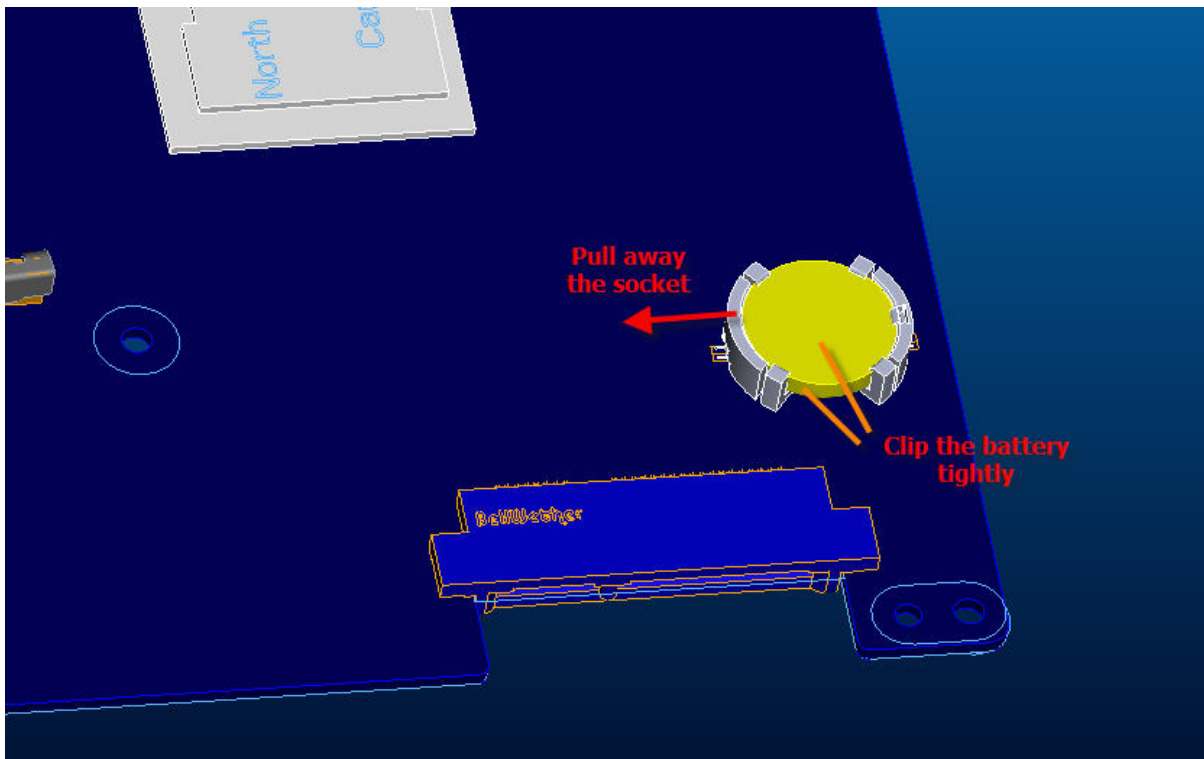

Figure 4-12-2 Remove the RTC battery-step_1

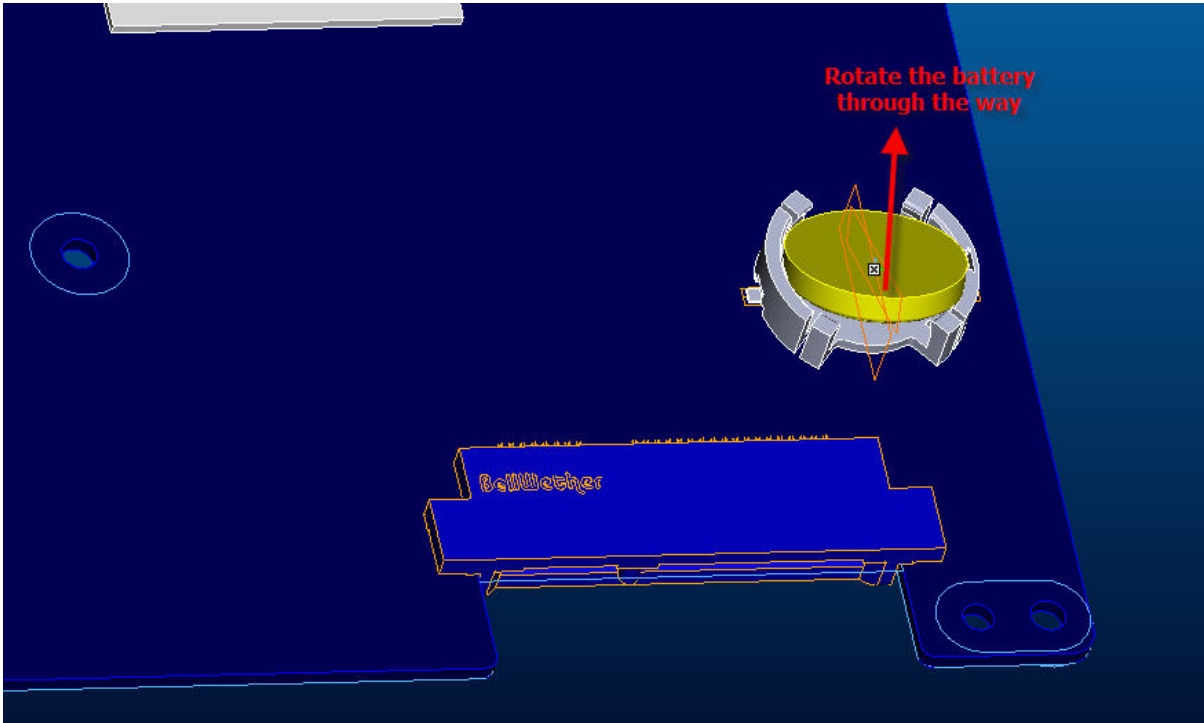

Figure 4-12-3 Remove the RTC battery-step_2

Installing RTC battery

The following describes the procedure for installing the RTC battery unit

(See Figure 4-12-4).

1. Press the force vertically then lock the RTC battery tightly.

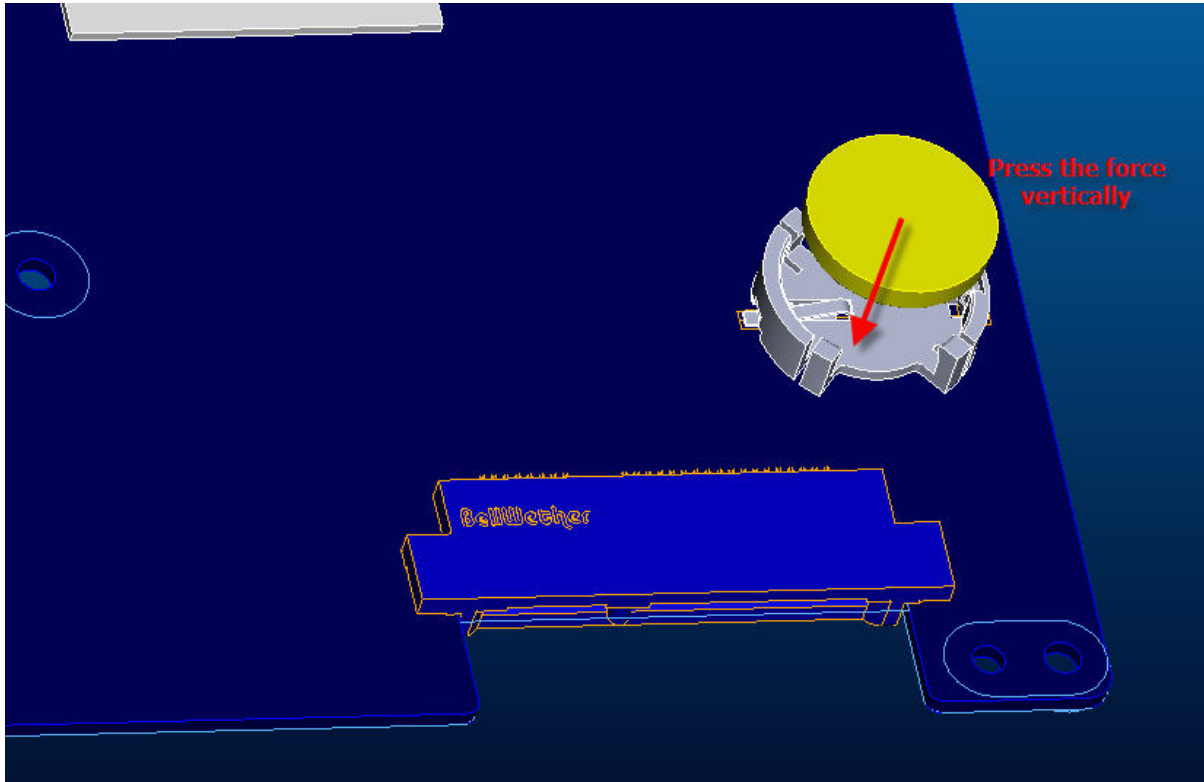

Figure 4-12-4 Install the RTC battery

4.13 CPU Heat Sink

Removing the CPU heat sink

The following describes the procedure for removing the CPU heat sink (See Figure 4-13-1).

1. Disconnect the **Heat sink cable** from the connector on the motherboard
2. Remove the following **screws** securing the heat sink holder along 1 to 3.
 - M2.0×2.5 screw x3

NOTE: When removing the heat sink holder, be sure to remove the screws in the reverse order of the number marked on the holder.

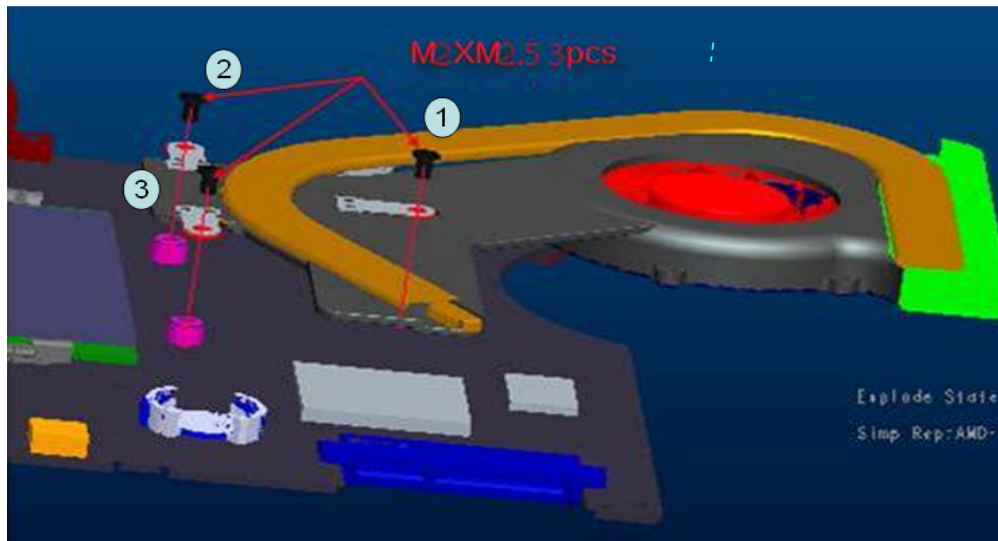

Figure 4-13-1 Remove the CPU heat sink

Installing the CPU heat sink

The following describes the procedure for installing the CPU heat sink

1. Secure the following **screws** securing the heat sink holder along 1 to 3.
 - M2.0×2.5 screw x3
2. Connect the **Heat sink cable** from the connector on the mother board

4.14 LCD unit

Removing the LCD unit

The following describes the procedure for removing the LCD unit (See Figure 4-14-1 to 4-14-3).

1. Remove Screw Mylar cover
2. Remove the following **screws** securing the display mask

M 2.5×5.0 screw x4

3. Insert your finger between the edge of the display mask and the LCD, and remove the display mask while releasing the latches of display mask. (Note: when removing the display mask, please first remove from top side to the bottom in order to lessen the degree of breaking.

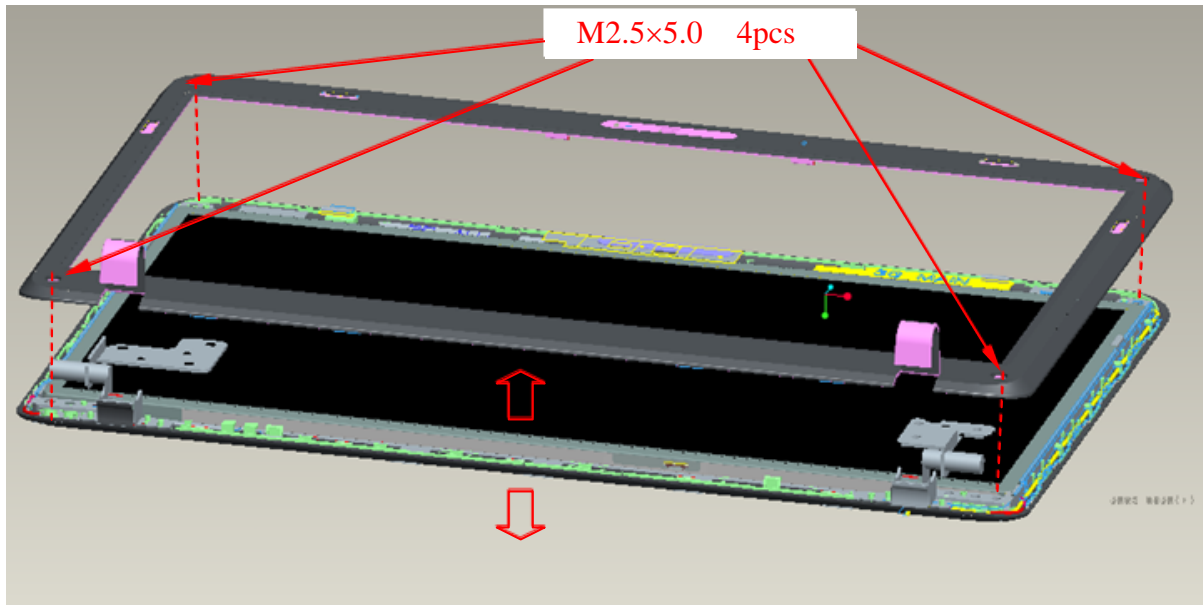

Figure 4-14-1 Remove the display mask

4. Remove the following **screws** securing the LCD unit.
 - M2.5x5.0 screw x4
5. With the bottom edge of the LCD unit on the display cover, lift only the top edge of the LCD unit. After peeling off the kapton **tape**, disconnect the LCD harness from the connector on the back of the LCD.
6. Remove the **LCD unit**.



Figure 4-14-2 Remove the LCD unit

7. Remove the following **screws** securing the LCD support (LCD unit side) and remove the **hinge** from the LCD unit.

- M2.0x3 BINK screw x4

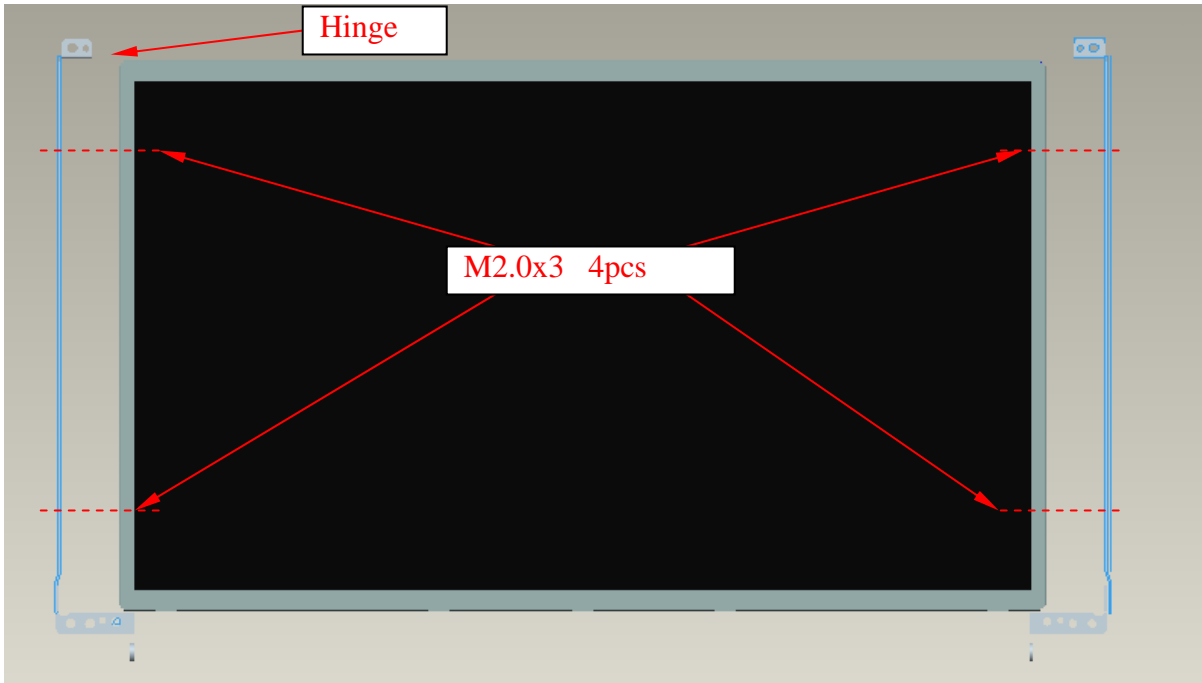

Figure 4-14-3 Remove the LCD hinge

Installing the LCD unit

The following describes the procedure for installing the LCD unit.

Install the LCD supports (LCD unit side) and hinge to the LCD and secure them with the following **screws**.

- M2.0×3.0 BINK screw x4

1. Stand the **LCD unit** on the display cover and connect the **LCD harness** to the connector on the back of LCD.
2. Stick the kapton **tape** on the connector of LCD harness.
3. Secure the LCD unit with the following **screws**.

- M2.5x5.0 screw x4

4. Secure the display mask with following **screws**

- M2. 5×5.0 screw x4

5. Cover screws with Screw Mylar cover

NOTE: *When installing the display mask, make sure there is no gap between the display mask and the display cover.*

4.15 Web Camera module

Removing Web Camera module

The following describes the procedure for removing the Web Camera module.

(See Figure 4-15-1 to 4-15-2).

1. Pull off the connector of Web Camera module.
2. Peel off the glue of Web Camera module.

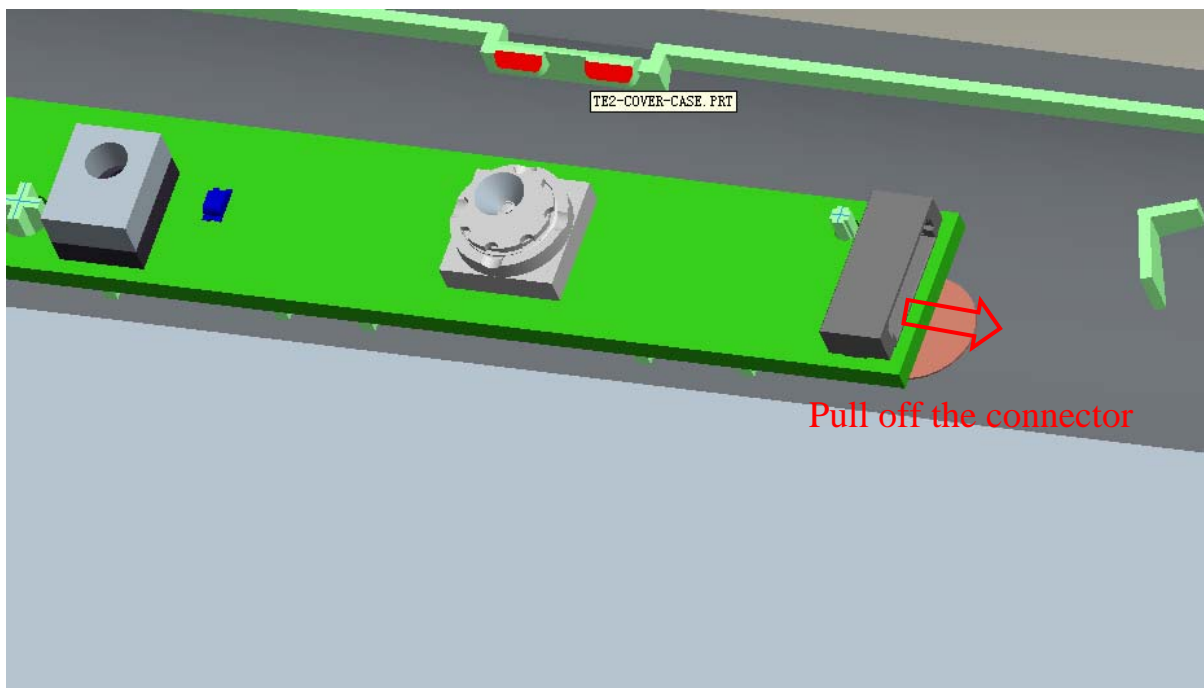

Figure 4-15-1 Remove the connector of Web Camera module

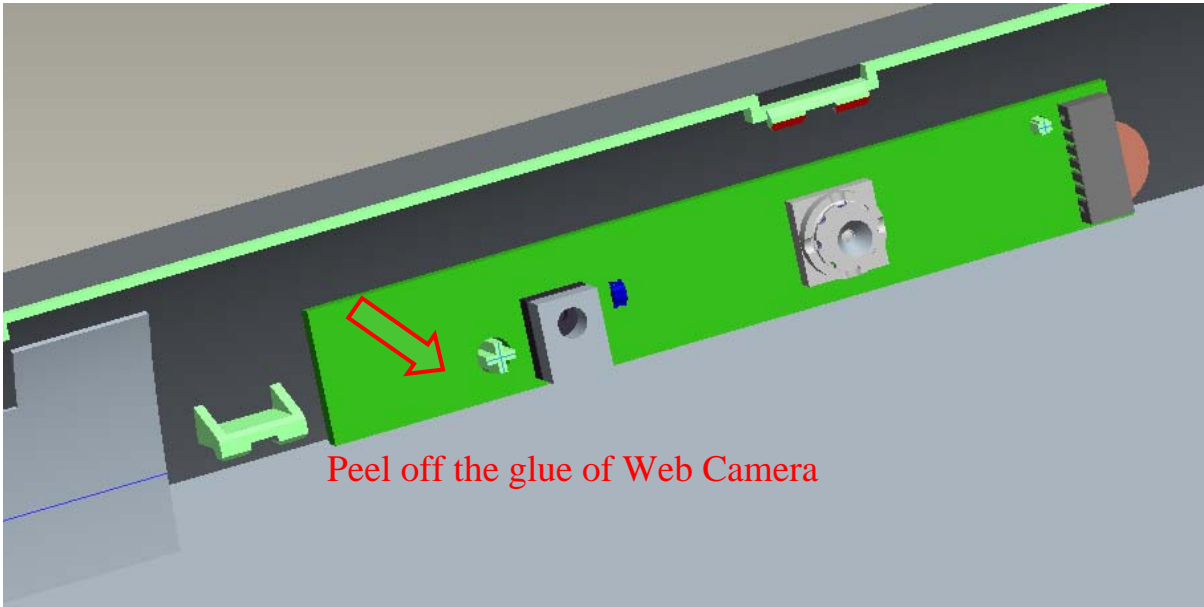

Figure 4-15-2 Peel off the glue of Web Camera module

Installing Web Camera module

The following describes the procedure for installing the Web Camera module.

1. Pull in the glue of Web Camera Module.
2. Connect the connector of Web Camera module.

4.16 Application for Thermal pad and grease on CPU, North Bridge, V-ram, chock and VGA (See Figure 4-16-1)

I .The thermal pad and grease on CPU, North Bridge, V-ram, chock and VGA

For Intel platform

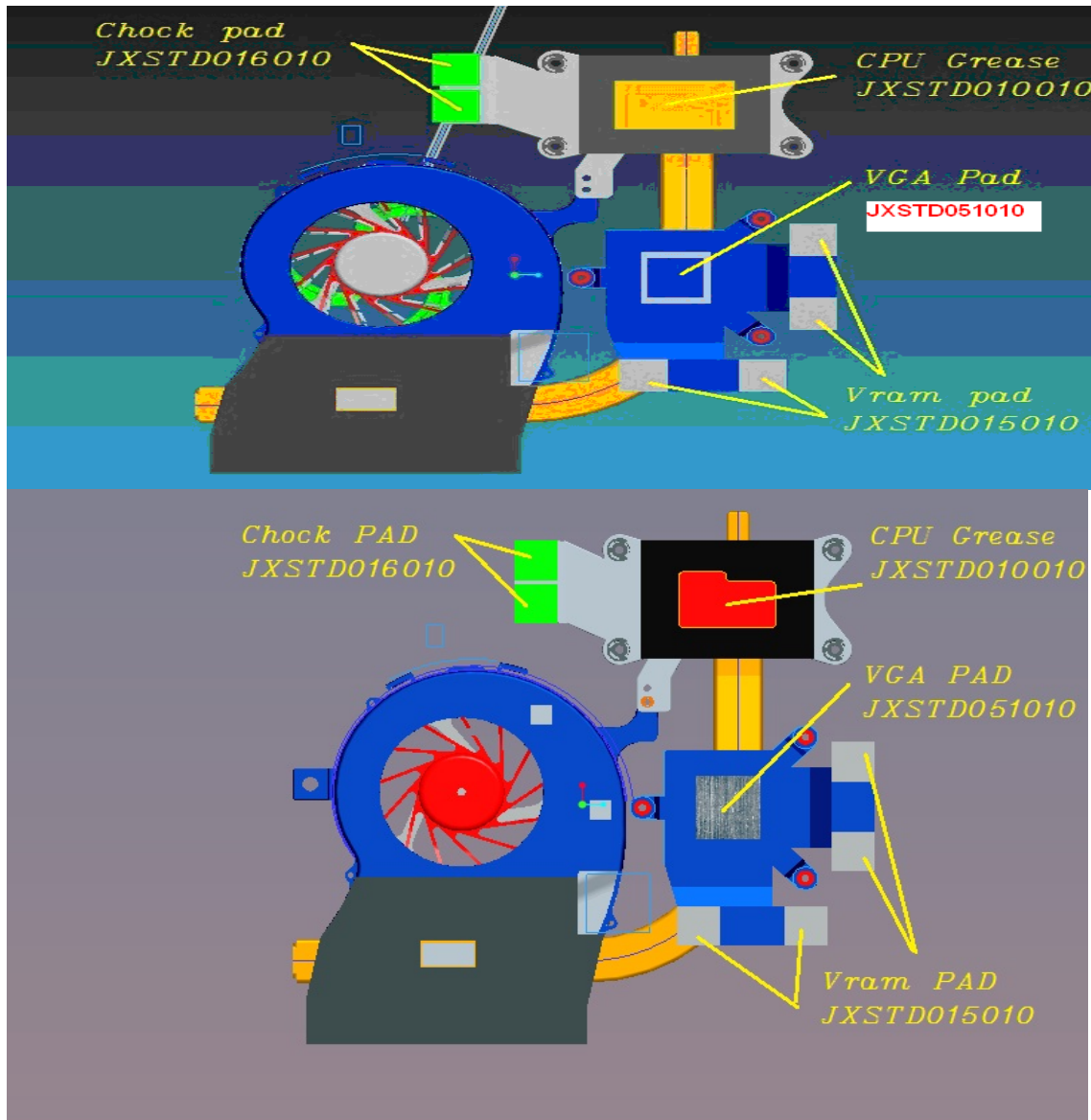

For AMD platform

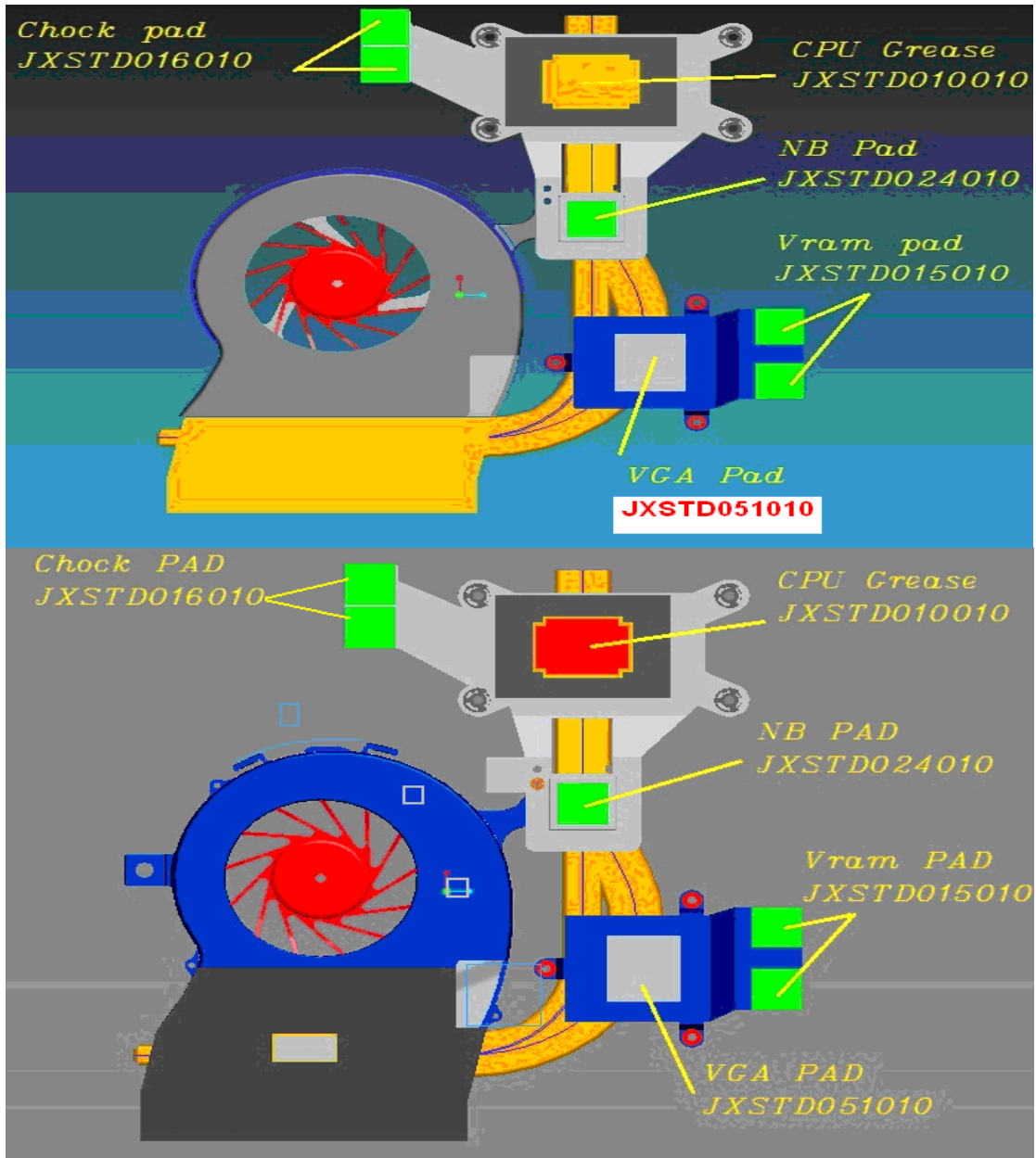

Figure 4-16-1 Intel & AMD thermal pad and grease on CPU, North Bridge, V-ram, chock and VGA

A000070000	JXSTD010010	CPU TIM 7762 16*26*(JXSTD010.,3A)
A000070010	JXSTD015010	CHOCK TIM XR-HL 10*10*0.8 (JXSTD015.,3A)
A000070020	JXSTD016010	CHOCK TIM XR-HL 10*10*1.0 (JXSTD016.,3A)
A000070030	JXSTD024010	PCHNB TIM FSL-B 11*11*1.0(JXSTD024,3A)
A000073290	JXSTD051010	VGA TIM T-F-7 12*12*0.75(JXSTD051,3A)

4.17 Speaker Box

Removing Speaker Box

The following describes the procedure for removing Speaker Box. (See Figure 4-17-1 to 4-17-3).

1. Remove the following **screws** securing Speaker Box.

- M2.0×3.0 screw x 4

2. Removing the Speaker Box.

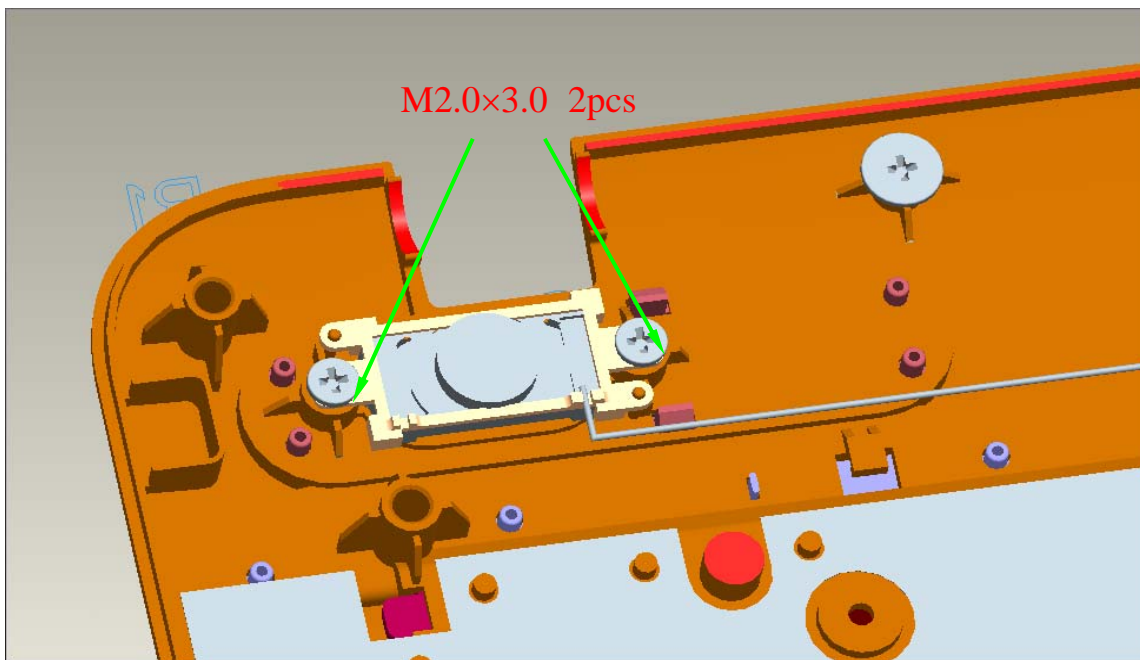

Figure 4-17-1 Removing the securing screws at left side.

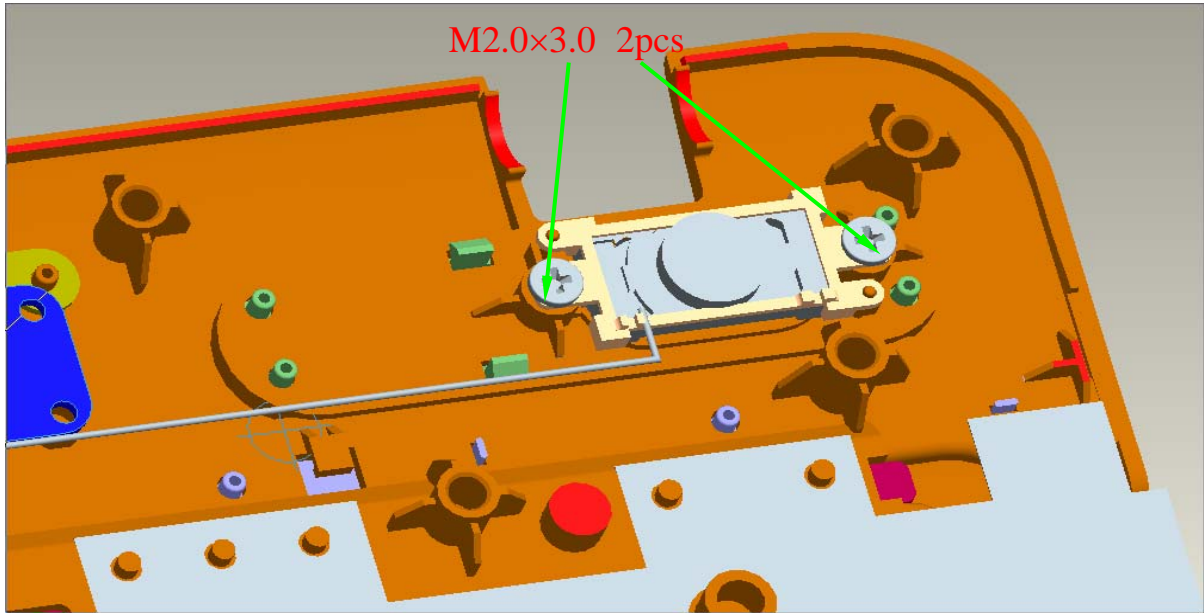

Figure 4-17-2 Removing the securing screws at right side

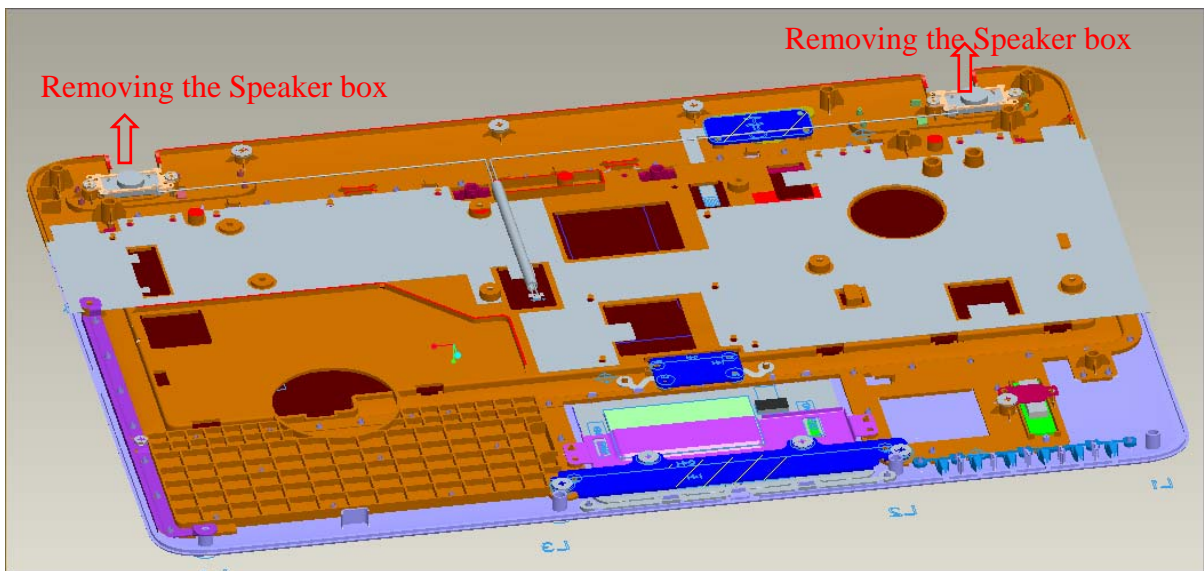

Figure 4-17-3 Removing the Speaker Box

Installing Speaker Box

The following describes the procedure for installing Speaker Box.

1. Installing the Speaker Box.
2. Securing Speaker Box of following **screws**.
 - M2.0×3.0 screw x 4

4.18 Optical Disc Drive and ODD Bezel

The following describes for removing the Optical Disc Drive and ODD Bezel (See Figure 4-18-1 to Figure 4-18-4).

Removing the Optical Disc Drive and ODD Bezel

1. Open RAM Door and remove memory slot cover

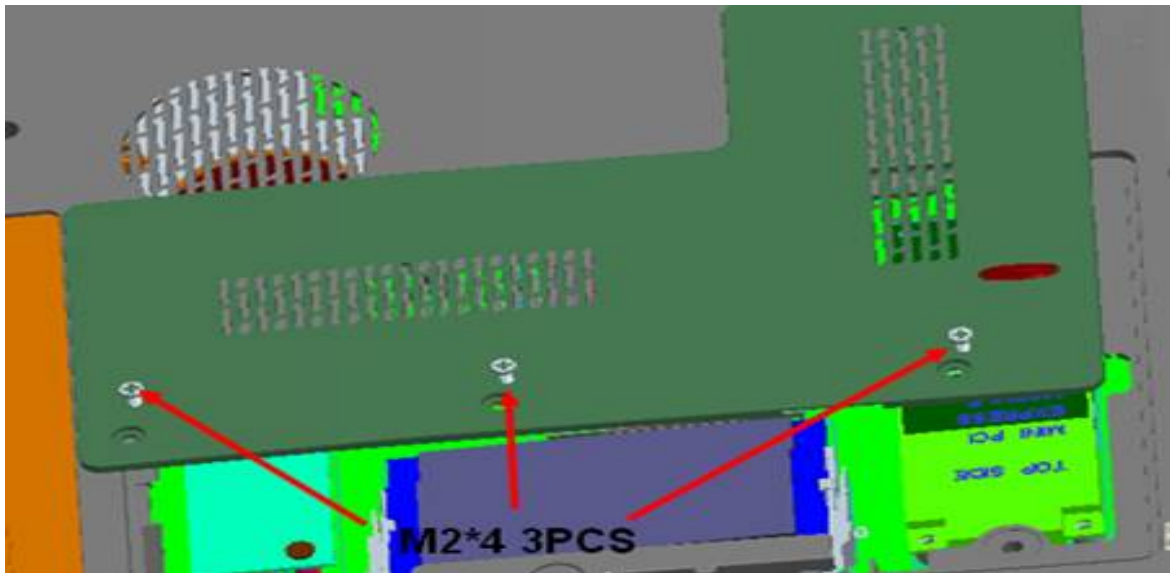

Figure 4-18-1 Remove memory slot cover

2. Remove the screws of the ODD Bezel

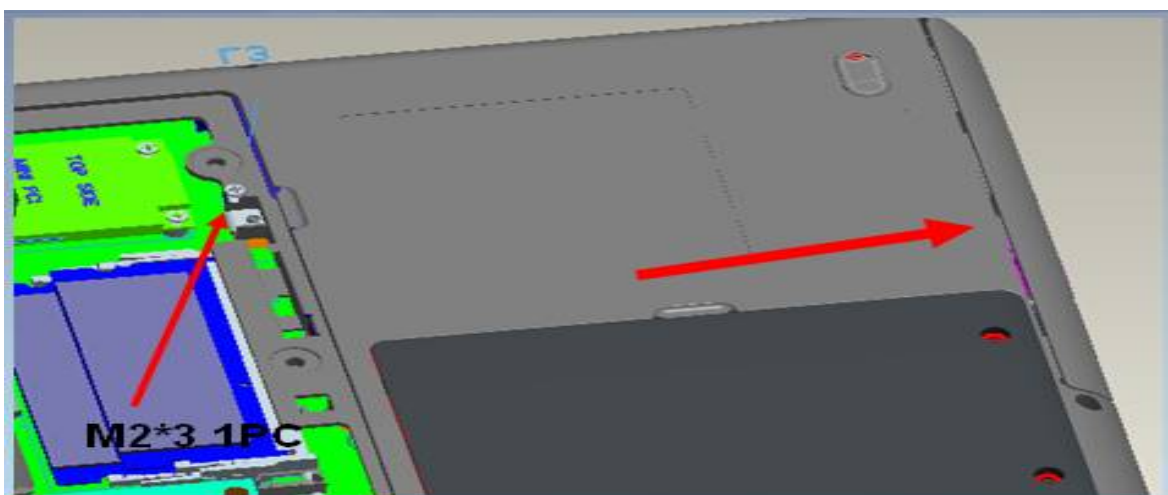

Figure 4-18-2 Remove the screw on ODD Bezel and ODD

3. Pull out ODD of the BASE cover assembly

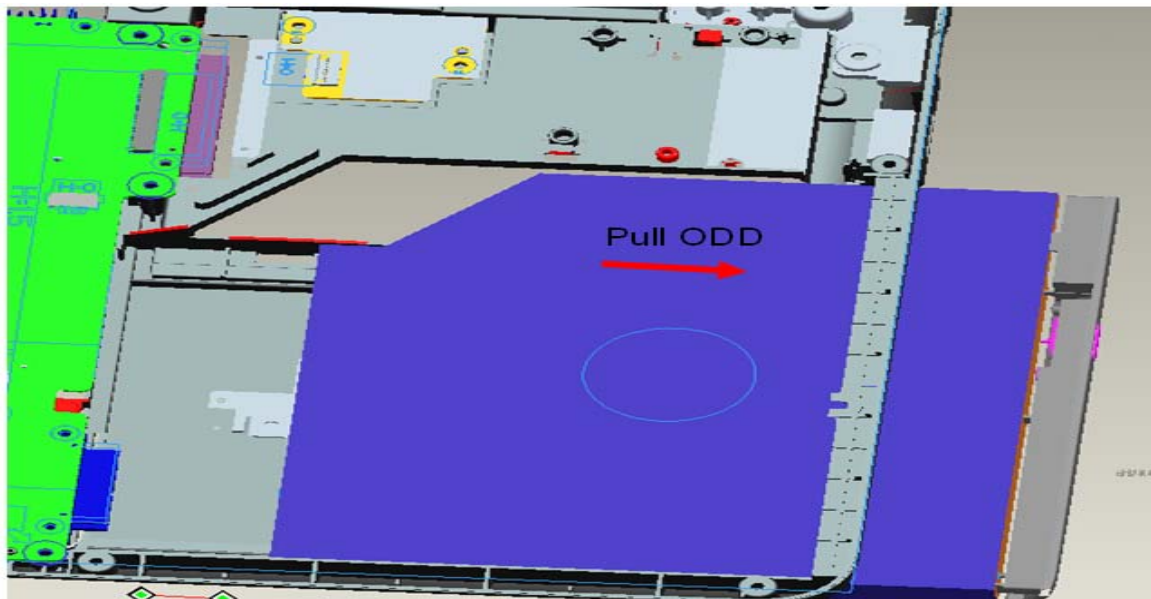

Figure 4-18-3 Remove the ODD

4. First pull out the ODD Bezel at the top side and then pull out ODD Bezel at the bottom side.

NOTE: When removing the ODD Bezel, make sure do not broken ODD Bezel.

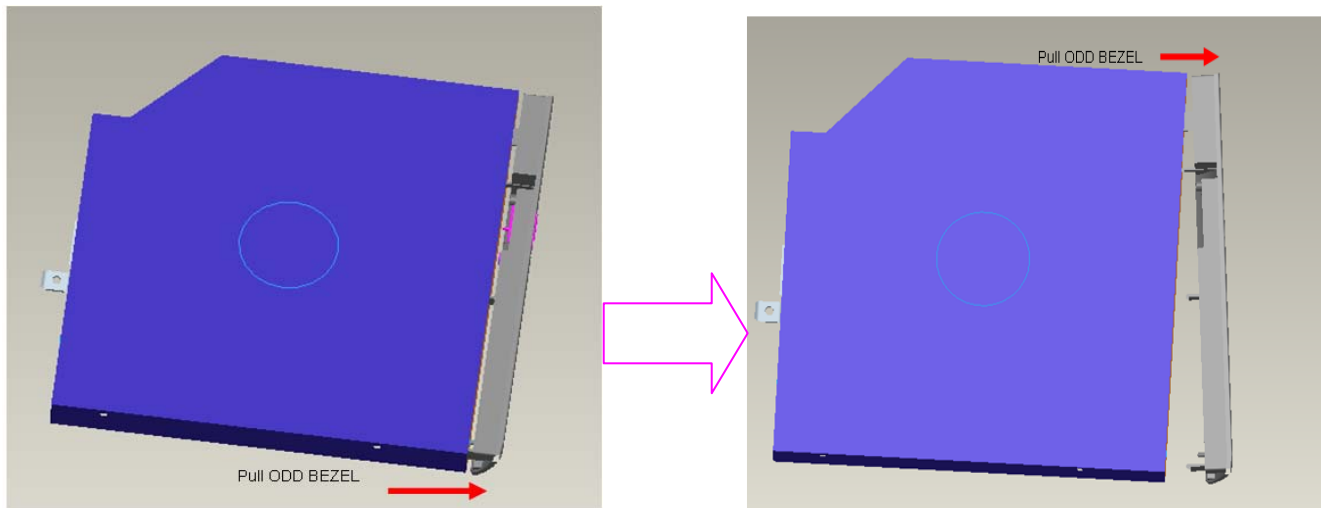

Figure 4-18-4 Remove the ODD Bezel

Installing the Optical Disc Drive and ODD Bezel

The following describes for installing the Optical Disc Drive and ODD Bezel (See Figure 4-18-5 to Figure 4-18-8).

1. Install the ODD Bezel.

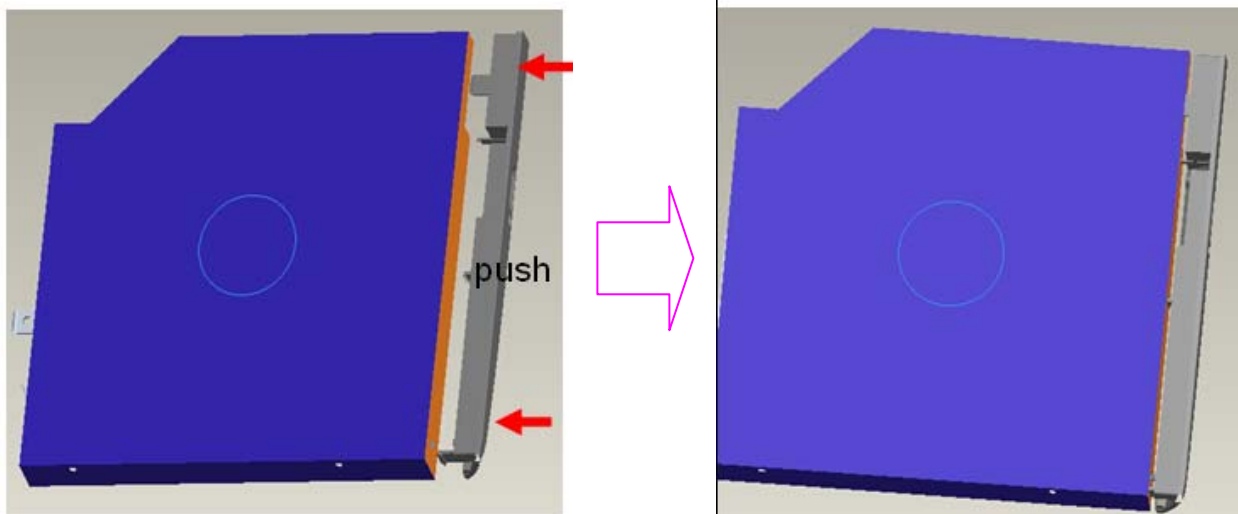

Figure 4-18-5 Installing the ODD Bezel

2. Install the ODD in the BASE cover assembly

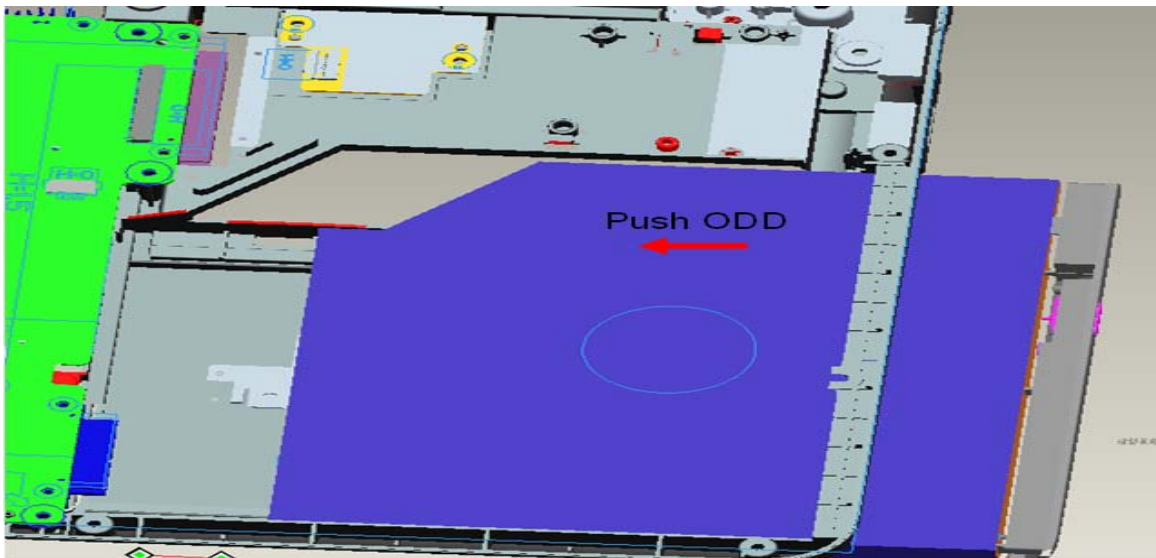

Figure 4-18-6 Installing the ODD

3. Fix **screws** on ODD Bezel then insert **ODD**

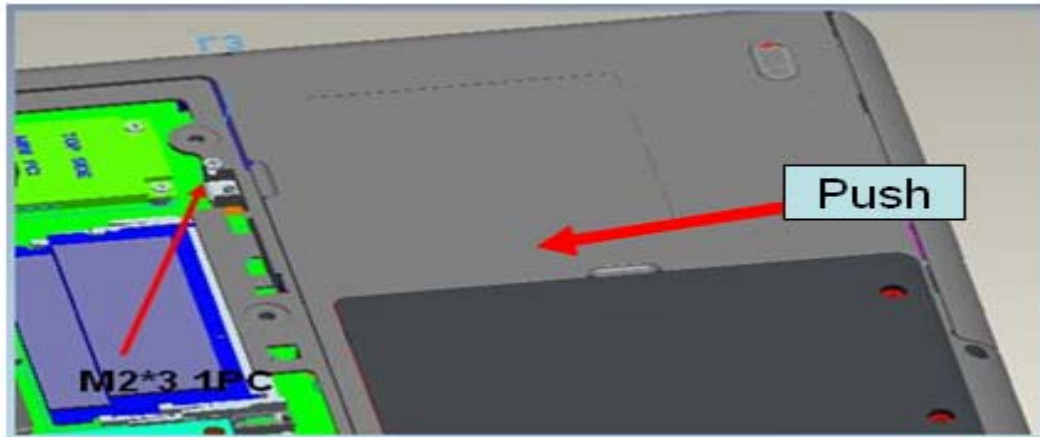

Figure 4-18-7 Securing screw on ODD Bezel

4. Fix screws then insert RAM DOOR.

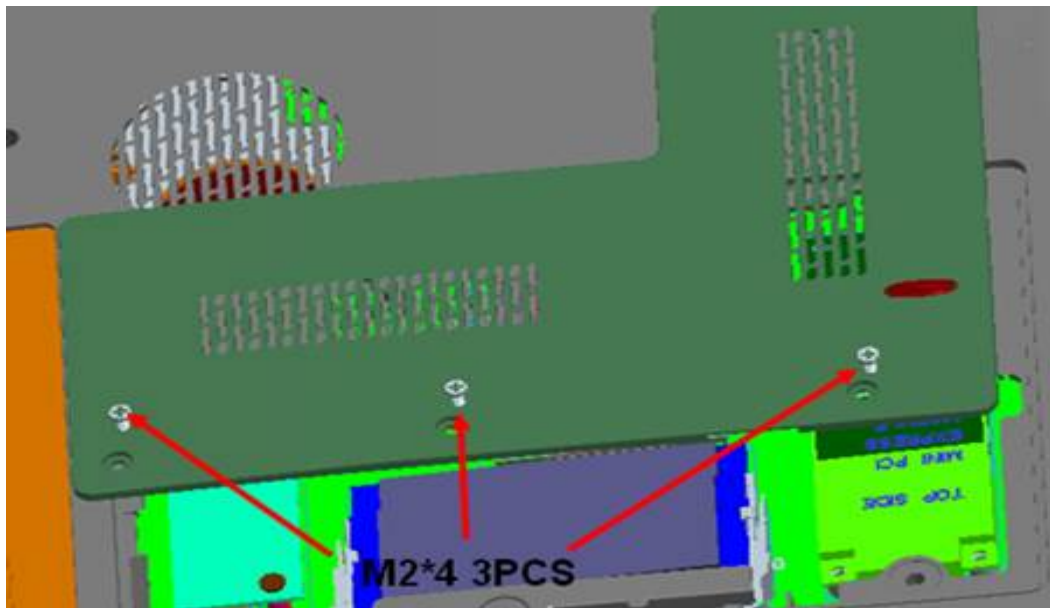

Figure 4-18-8 Securing the screws on RAM Door

4.19 BT Module

Removing Bluetooth module

The following describes the procedure for removing a BT module (See Figure 4-19-1 to 4-19-2).

1. Disconnect the **BT cable** from the connectors on mother board.
2. .Remove Bluetooth module from the TOP cover assembly.



Figure 4-19-1 Remove the Bluetooth cable

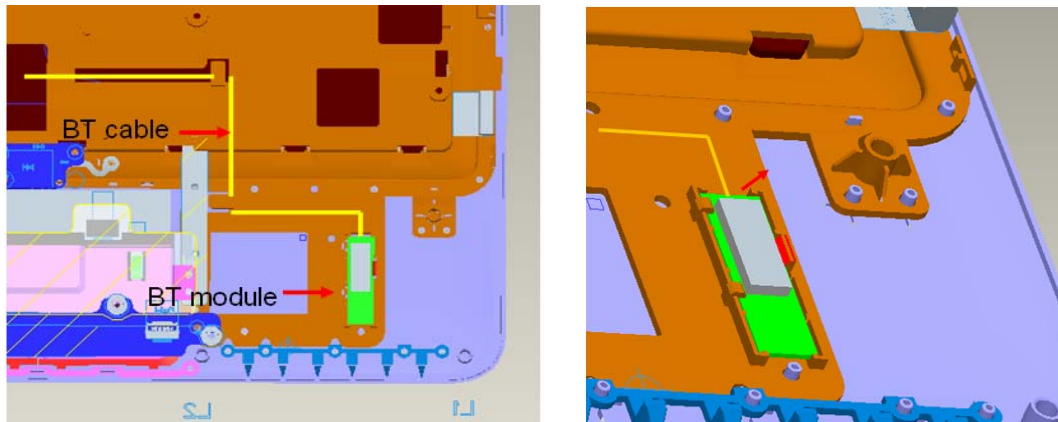

Figure 4-19-2 Remove the Bluetooth module

Installing Bluetooth module

The following describes the procedure for installing a Bluetooth module.

1. Insert Bluetooth module terminals into the connector on mother board.
2. Installing Bluetooth module on the TOP cover assembly.

4.20 Modem

Removing Modem

The following describes the procedure for removing Modem (See Figure 4-20-1).

1. Disconnect the **Modem cable** from the Modem.
2. Remove the screw of **Modem**.

M2.0x 3.0 screw x1

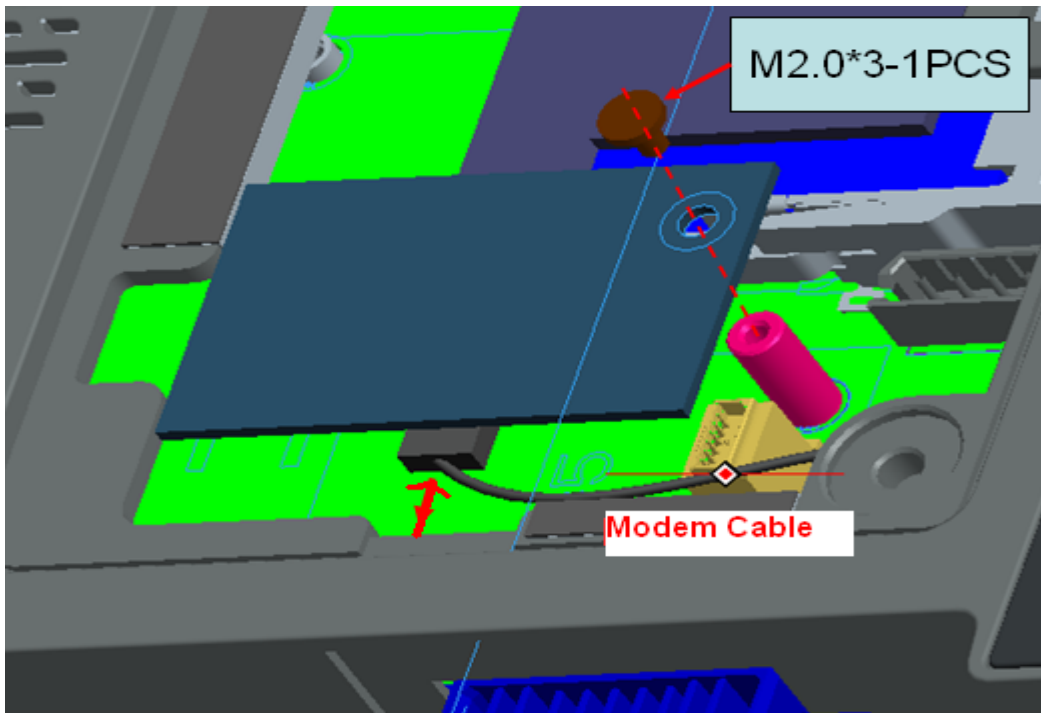

Figure 4-20-1 Remove the Modem

Installing Modem

The following describes the procedure for installing Modem.

1. Lock the Modem secure screws on the mother board.
2. Insert **Modem cable** terminals slantwise into the connector on Modem.

4.21 Power Board

Removing Power Board

The following describes the procedure for removing Power Board (See Figure 4-21-1).

1. Disconnect the **Power Board** from the connectors on mother board.
1. Remove Power Board from the **connector** on the Base cover assembly.

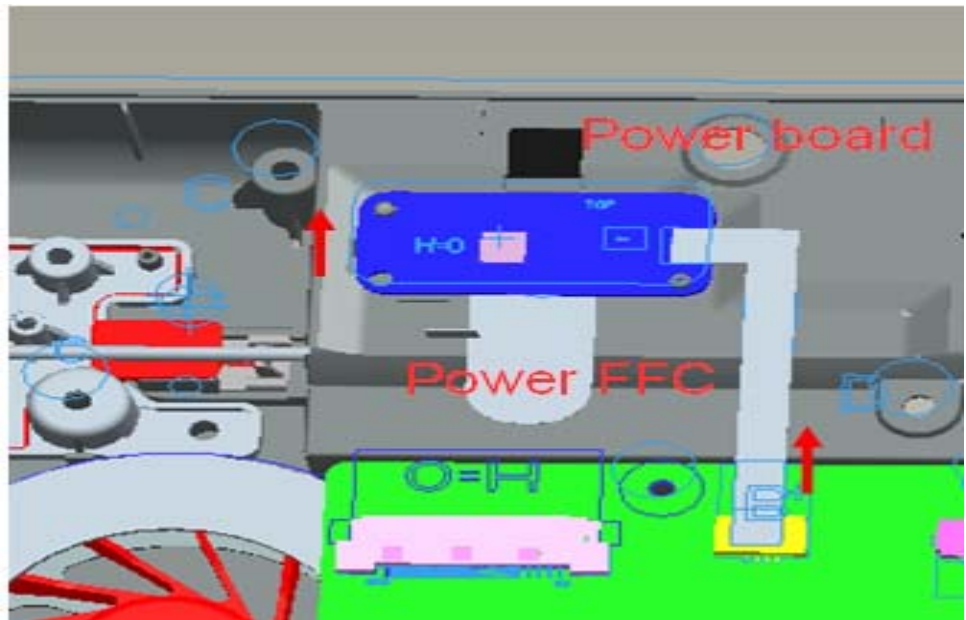

Figure 4-21-1 Remove power board

Installing Power Board

The following describes the procedure for installing Power Board.

1. Insert **Power cable** terminals into the connector on mother board.
2. To glue the Power card on the Base.

4.22 SIM Board

Removing SIM Board

The following describes the procedure for removing SIM Board (See Figure 4-22-1).

1. Disconnect the **SIM Board FFC** from the connectors on mother board.
2. Remove the screws of **SIM Board**.

- M2.0x 3.0 screw x2

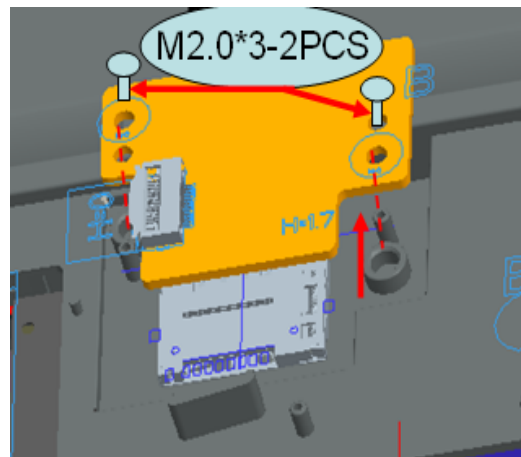
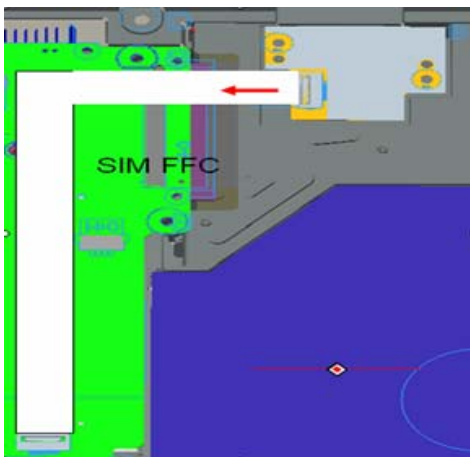

Figure 4-22-1 Remove SIM Board

Installing SIM Board

The following describes the procedure for installing SIM Board.

1. Insert **SIM Board FFC** terminals into the connector on mother board.
2. Lock the SIM Board screw on the Base.

Appendices

Appendix Contents

Appendix A	Handling the LCD Module.....	1
Appendix B	Board Layout.....	1
B.1	System Board.....	1
B.2	Touch Pad Board.....	5
B.3	TP ON-OFF Board.....	6
B.4	CRT/USB Board.....	7
B.5	SIM(3G) Board.....	9
B.6	Modem Board.....	10
Appendix C	Pin Assignment.....	1
C.1	CN8 LCD Panel Connector.....	1
C.2	CN9 Power/B Connector.....	1
C.3	CN10 Touch Pad Board Connector.....	2
C.4	CN11 Bluetooth Connector.....	2
C.5	CN12 Keyboard Connector.....	2
C.6	CN13 Speaker Connector.....	3
C.7	CN14 CRT Connector.....	3
C.8	CN15 Earphone Connector.....	3
C.9	CN16 External MIC Connector.....	4
C.10	CN17 HDMI Connector.....	4
C.11	CN18 E-SATA Connector.....	5
C.12	CN19 USB Connector.....	5
C.13	CN20 LAN RJ45 Connector.....	5
C.14	CN21 3in1 Card Reader Connector.....	6
C.15	CN22 RTC Battery Connector.....	6
C.16	CN23 FAN Connector.....	6
C.17	CN24 MINI Card Slot#1 (Wi-Fi) Connector.....	6
C.18	CN25 MINI Card Slot#2 3G Connector.....	8

C.19	CN26 DDRIII Connector	9
C.20	CN27 Modem Connector	13
C.21	CN28 DDRIII Connector	13
C.22	CN29 SATA ODD Connector	17
C.23	CN30 SATA HDD Connector	18
C.24	PCN7 Battery Connector	18
C.25	PCN8 DC-IN Connector	19
C.26	JSIM7 3G/B Connector.....	19
Appendix D Display Codes		1
D.1	Display Codes	1
Appendix E Keyboard Layout		1
E.1	United States (US) Keyboard.....	1
E.2	United Kingdom (UK) Keyboard	1
E.3	Japan Keyboard.....	2
Appendix F Wiring Diagrams.....		1
F.1	RGB Monitor ID Wraparound Connector	1
F.2	LAN Loopbak Connector	1

Appendix A Handling the LCD Module

Precautions for handling the LCD module

The LCD module can be easily damaged during assembly or disassembly. Observe the following precautions when handling the LCD module:

1. When installing the LCD module in the LCD cover, be sure to seat it so that it is properly aligned and maximum visibility of the display is maintained.

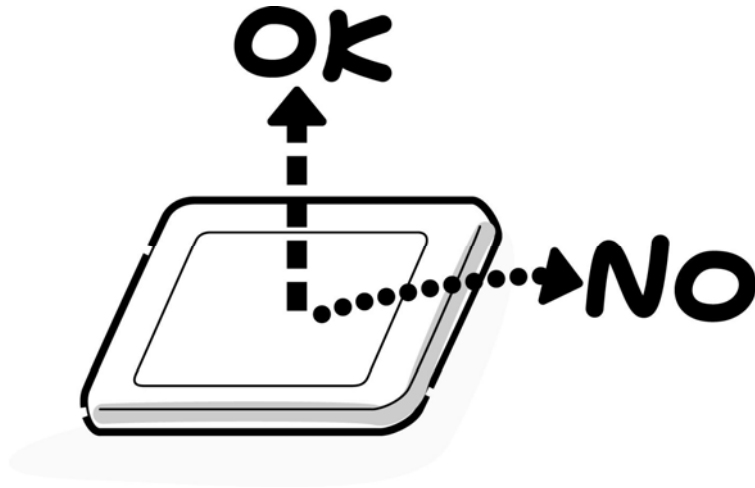

2. Be careful to align the holes at the four corners of the LCD module with the corresponding holes in the LCD cover before securing the module with screws. Do not force the module into place, because stress can affect its performance.

Also, the panel's polarized surface is easily scarred, so be careful when handling it.



Handling the LCD Module

3. If the panel's surface gets fingerprint or dust, put on gloves and wipe it with static electricity cloth. If it is still dirty, drop some cleaning alcohol on the surface and wipe it again.

If the surface is much more fingerprint or dust, we recommend a CRT cleaning agent. Apply the agent to a cloth and then wipe the panel's surface. Do not apply cleanser directly to the panel.

If dust still exists, please use ionic FAN which can avoid static electricity to deal with it.



4. If water or other liquid is left on the panel's surface for a long period, it can change the screen's tint or stain it. Be sure to quickly wipe off any liquid with cloth or ionic FAN



5. Glass is used in the panel, so be careful not to drop it or let it strike a hard object, which could cause breakage or cracks.



6. CMOS-LSI circuits are used in the module, so guard against damage from electrostatic discharge. Be sure to wear a wrist or ankle ground when handling the module.

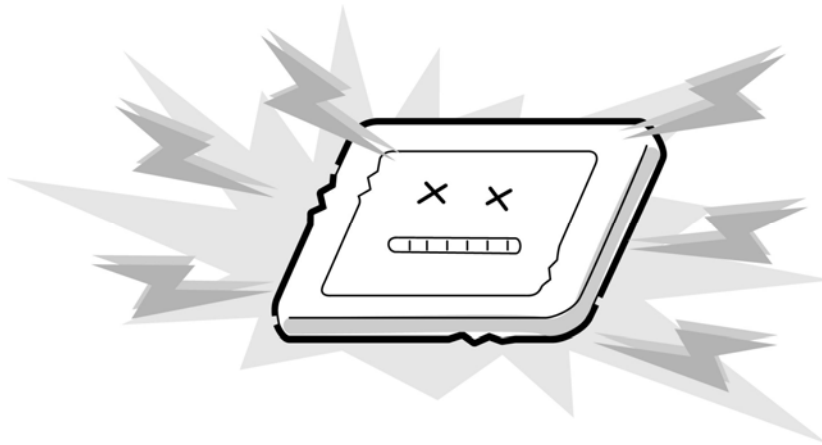

Handling the LCD Module

7. Do not expose the module to direct sunlight or strong ultraviolet rays for long periods.

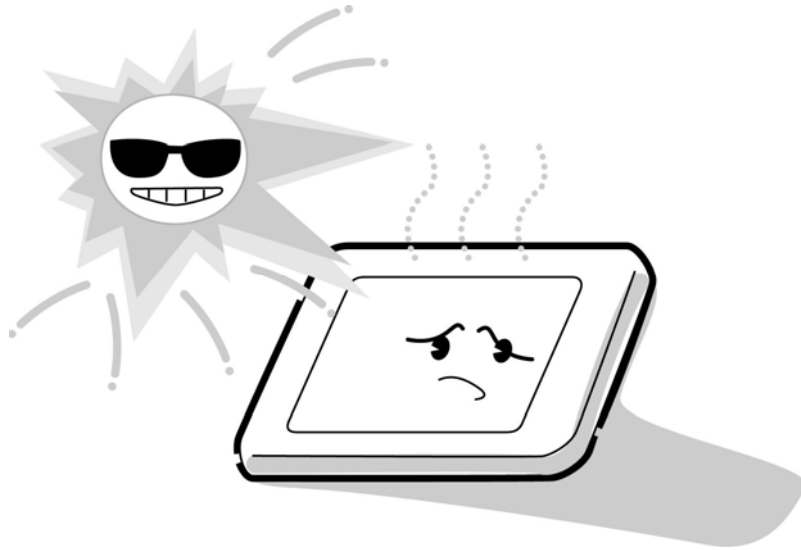

8. Do not store the module at temperatures below specifications. Cold can cause the liquid crystals to freeze, lose their elasticity or otherwise suffer damage.

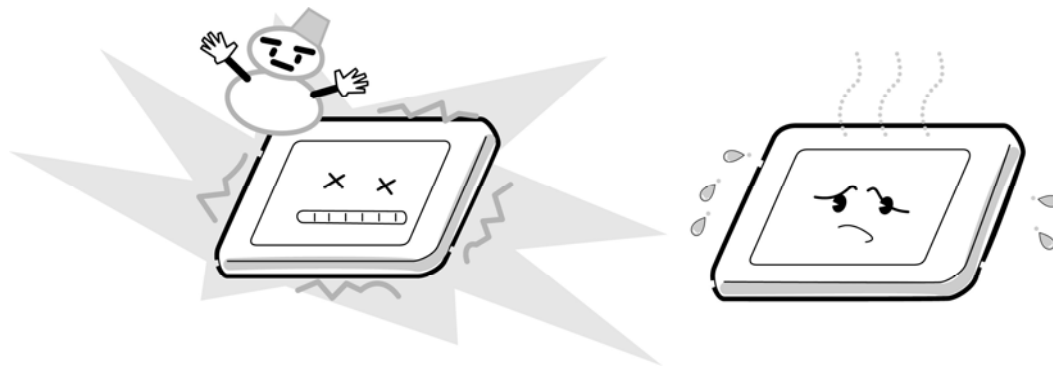

9. Do not disassemble the LCD module. Disassembly can cause malfunctions.

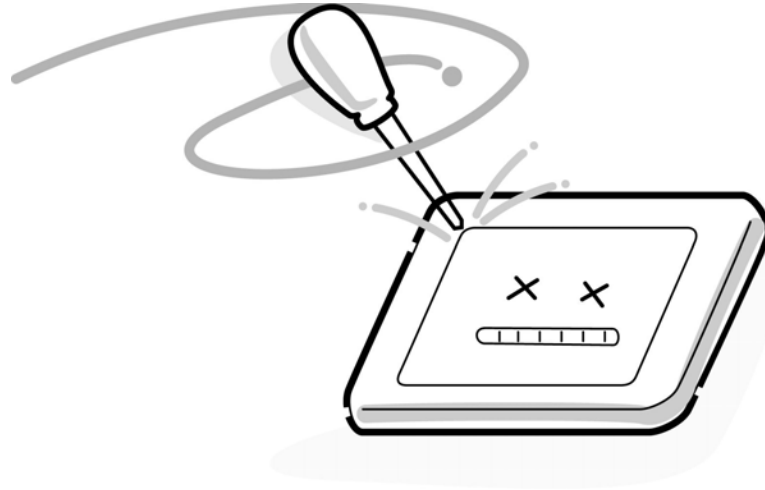

10. If you transport the module, do not use packing material that contains epoxy resin (amine) or silicon glue (alcohol or oxide). These materials can release gas that can damage the panel's polarization.

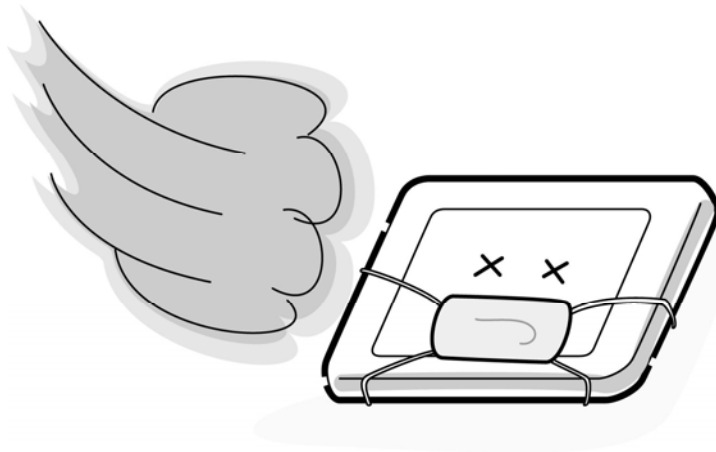

Appendix B Board Layout

B.1 System Board

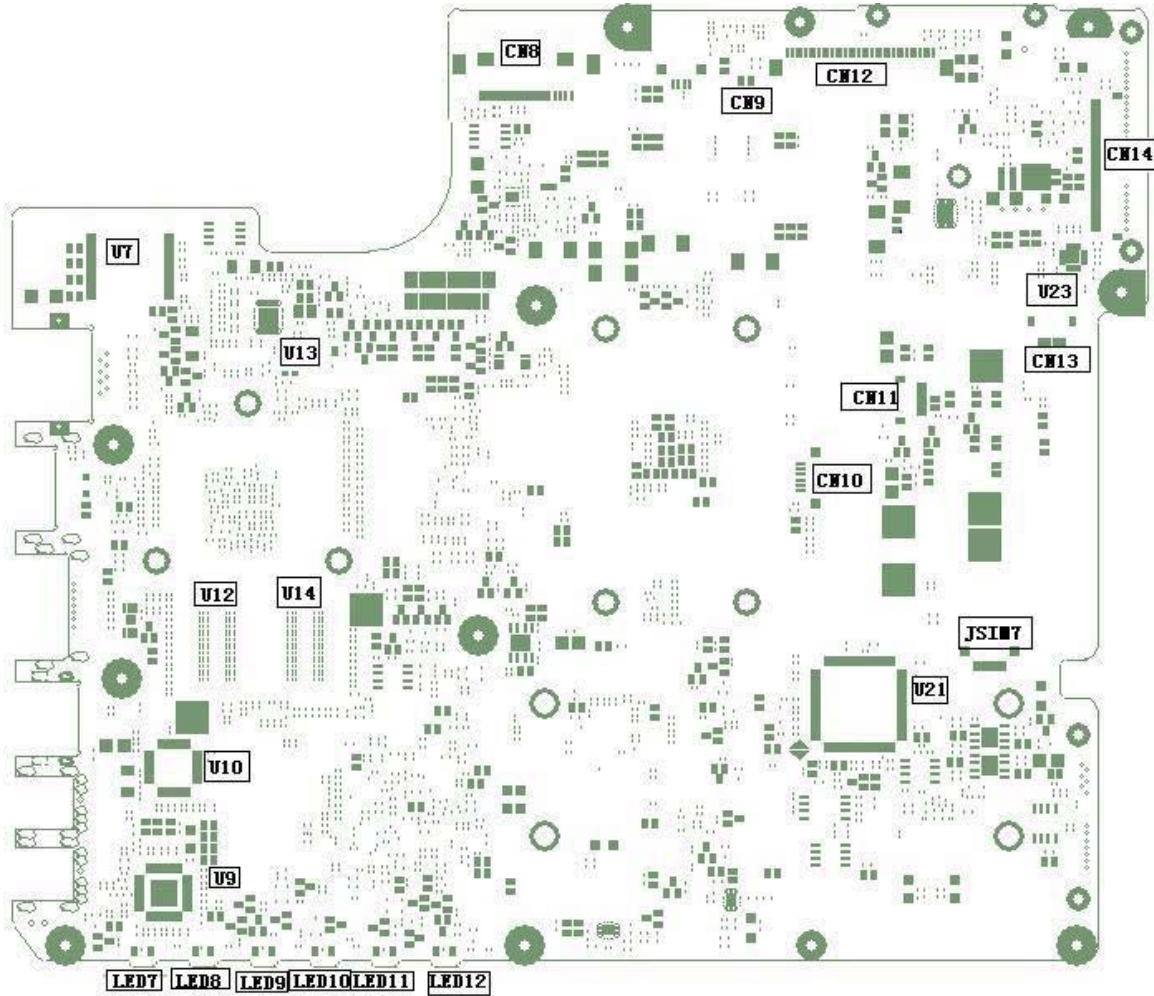

Figure B-1-1 System board layout (front)

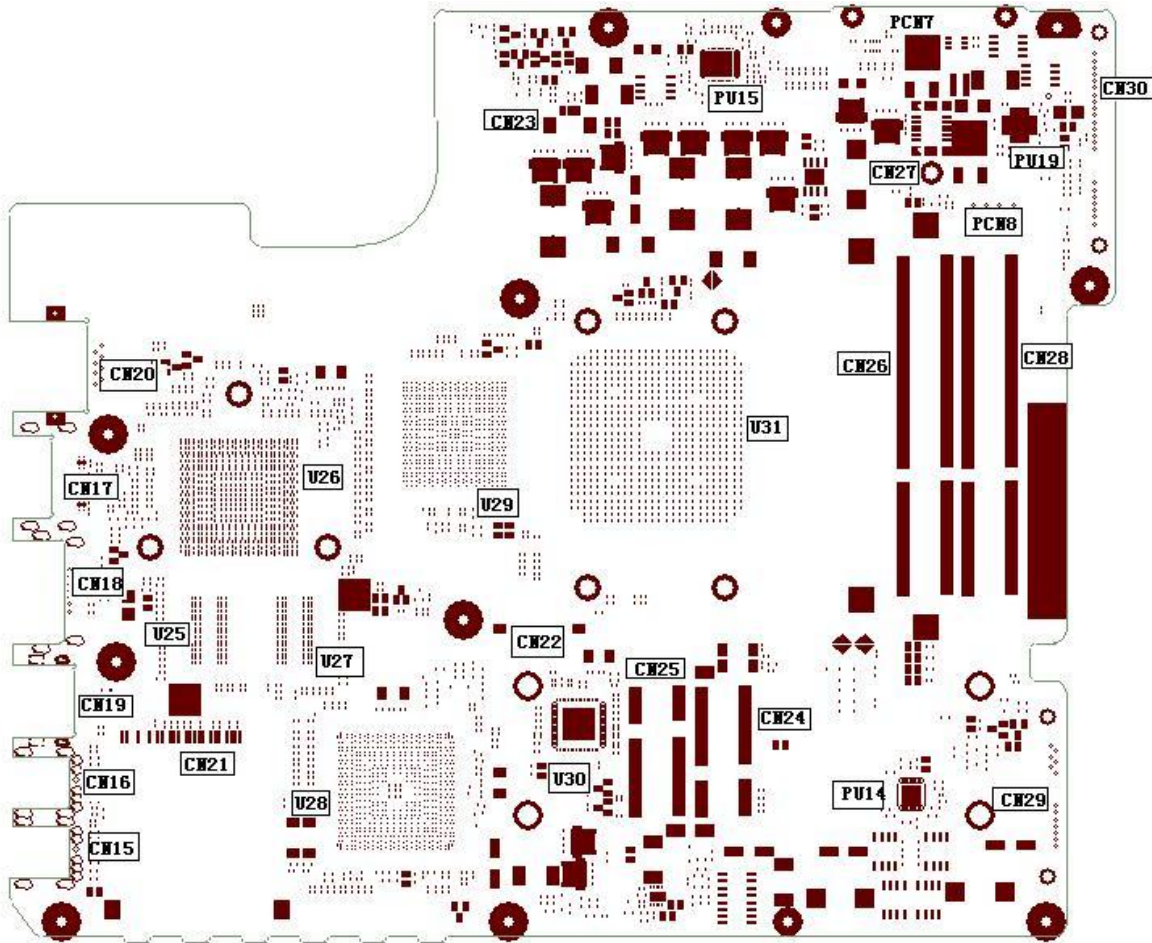

Figure B-1-2 System board layout (Back)

NUM	Location	Function
(01)	CN8	LCD CONN

Board Layout

(02)	CN9	Power/B CONN
(03)	CN10	TOUCHPAD/B CONN
(04)	CN11	BLUETOOTH CONN
(05)	CN12	KEYBOARD CONN
(06)	CN13	SPEAKER CONN
(07)	CN14	CRT/B CONN
(08)	CN15	EARPHONE CONN
(09)	CN16	EXTERNAL MIC CONN
(10)	CN17	HDMI CONN
(11)	CN18	E-SATA CONN
(12)	CN19	USB CONN
(13)	CN20	LAN CONN
(14)	CN21	CARD READER CONN
(15)	CN22	CMOS BAT CONN
(16)	CN23	FAN CONN
(17)	CN24	MINI Card Slot#2 (3G) CONN
(18)	CN25	MINI Card Slot#1 (WiFi) CONN
(19)	CN26	DDRIII CONN
(20)	CN27	MODEM/B CONN
(21)	CN28	DDRIII CONN
(22)	CN29	ODD CONN
(23)	CN30	HDD CONN
(24)	JSIM7	SIM/B CONN
(25)	PCN7	BAT CONN

Board Layout

(26)	PCN8	POWER CABLE CONN
(27)	U7	LAN TRANSFORMER
(28)	U19	CPU THERMAL SENSOR
(29)	U10	Card-Reader Controller IC
(30)	U12	Video RAM
(31)	U14	Video RAM
(32)	U21	Embedded Controller IC
(33)	U23	SATA HDD IC
(34)	U25	Video RAM
(35)	U26	Video CONTROLLER IC
(36)	U27	Video RAM
(37)	U28	SOUTHBRIDGE
(38)	U29	NORTH BRIDGE
(39)	U30	Clock generator
(40)	U31	CPU Socket
(41)	PU14	SUPPLY +1.8V
(42)	PU15	SUPPY CPU CORE
(43)	PU19	BATTER CONTROLLOER IC
(44)	LED7	AC-IN LED
(45)	LED8	POWER LED
(46)	LED9	BATT LED
(47)	LED10	HDD LED
(48)	LED11	Wi-Fi/3G LED
(49)	LED12	Card Reader LED

B.2 Touch Pad Board

<Front layout>

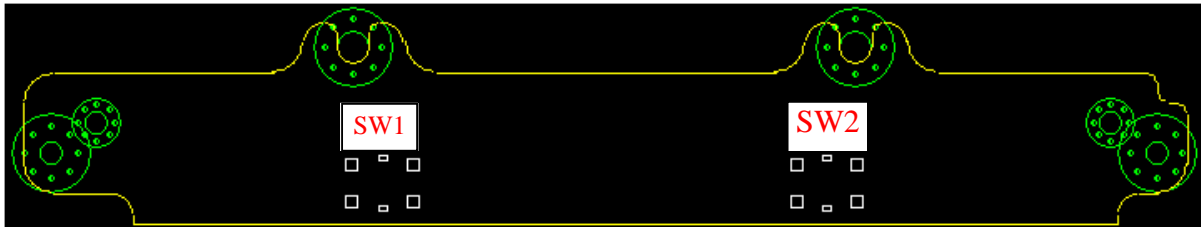

Figure B-2-1 Touch Pad board layout (Front)

NUM	Location	Function
(01)	SW1	Mouse Button Left key
(02)	SW2	Mouse Button Right key

Table B-2-2 Touch Pad board Switches

<Back layout>

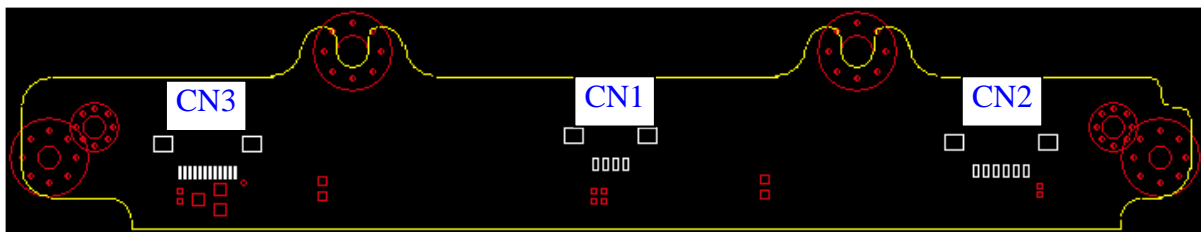

Figure B-2-3 Touch Pad board layout (Back)

NUM	Location	Function
(01)	CN1	TP Board to TP ON-OFF Board CONN
(02)	CN2	TP Board to M/B CONN
(03)	CN3	TP Board to Touch Pad module CONN

Table B-2-4 Touch Pad board connectors

B.3 TP ON-OFF Board

<Front layout>

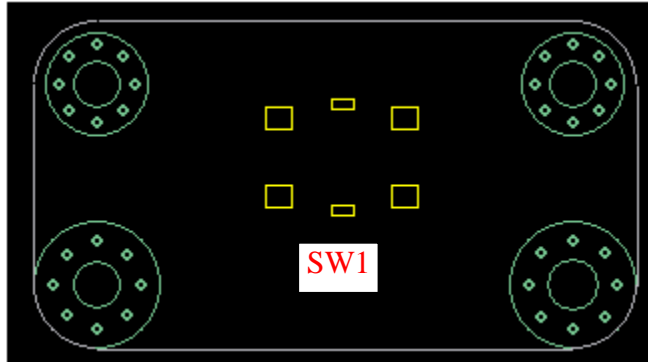

Figure B-3-1 TP ON-OFF Board layout (Front)

NUM	Location	Function
(01)	SW1	TP ON-OFF Switch

Table B-3-2 TP ON-OFF Board switch

<Back layout>

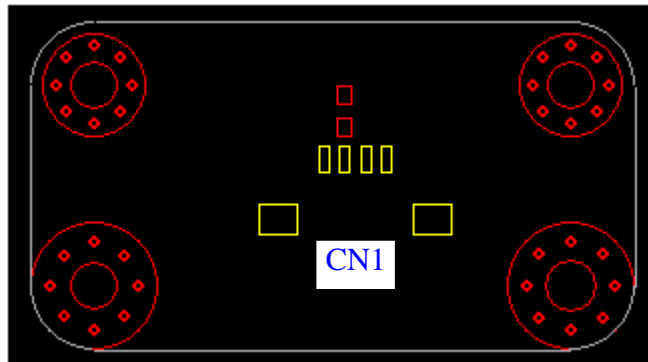

Figure B-3-3 TP ON-OFF Board layout (Back)

NUM	Location	Function
(01)	CN1	TP ON-OFF Board to Touch Pad Board CONN

Table B-3-4 Finger Print Board connectors

B.4 CRT/USB Board

<Front layout>

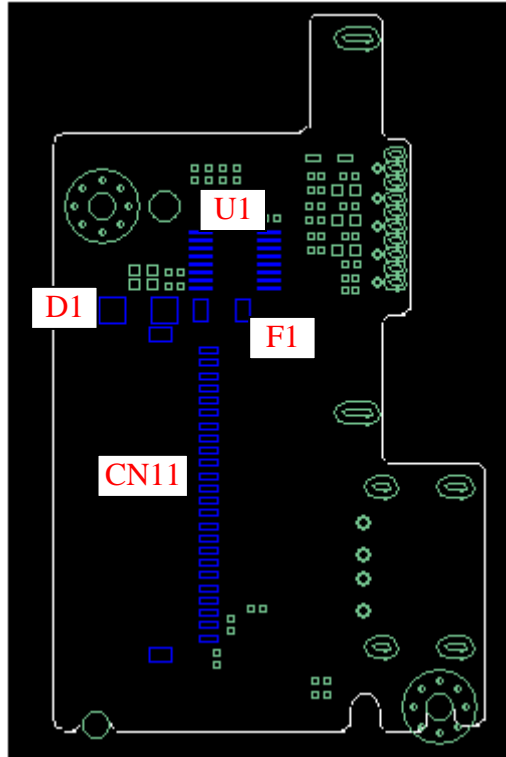

Figure B-4-1 CRT/USB Board layout (Front)

NUM	Location	Function
(01)	CN11	CRT to M/B CONN
(02)	D1	CRT Port Current Opposite Protect Diode
(03)	F1	CRT Fuse
(04)	U1	CRT DDC Level Shift IC

Table B-4-2 CRT/USB Board components

<Back layout>

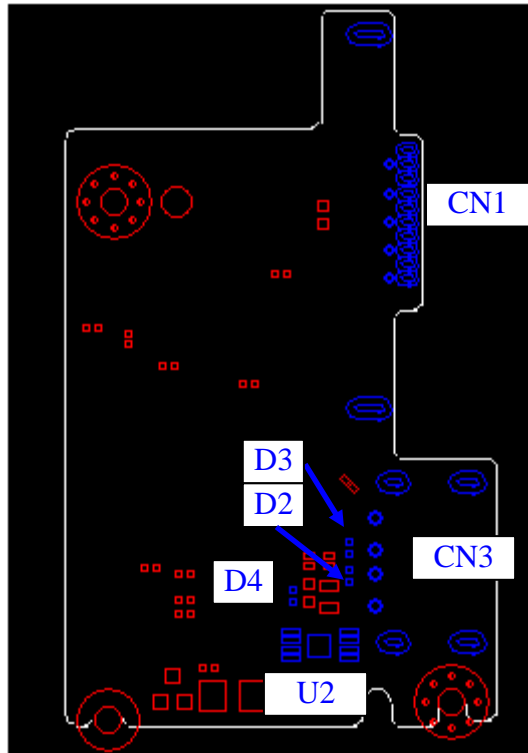

Figure B-4-3 CRT/USB Board layout (Back)

NUM	Location	Function
(01)	CN1	CRT CONN
(02)	CN3	USB CONN
(03)	U2	USB Power IC
(04)	D2	USB DATA- ESD Diode
(05)	D3	USB DATA+ ESD Diode
(06)	D4	USB Power ESD Diode

Table B-4-4 CRT/USB Board components

B.5 SIM (3G) Board

<Front layout>

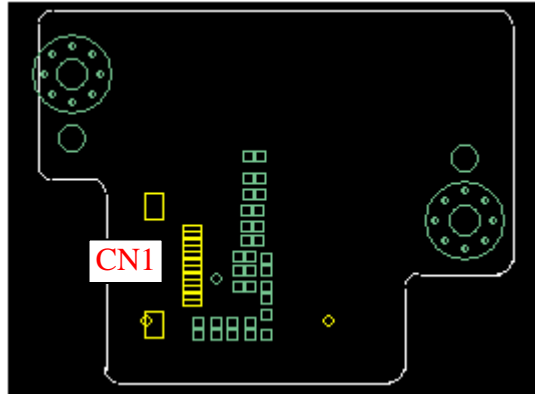

Figure B-5-1 SIM (3G) Board layout (Front)

NUM	Location	Function
(01)	CN1	SIM(3G)/B to M/B CONN

Table B-5-2 SIM (3G) Board connector

<Back layout>

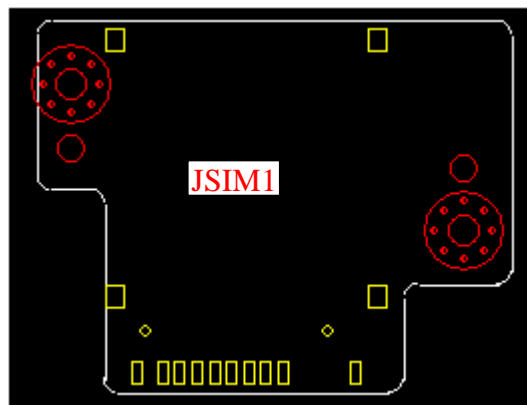

Figure B-5-3 SIM (3G) Board layout (Back)

NUM	Location	Function
(01)	JSIM1	SIM Card CONN

Table B-5-4 SIM (3G) Board connector

B.6 Modem Board

<Front layout>

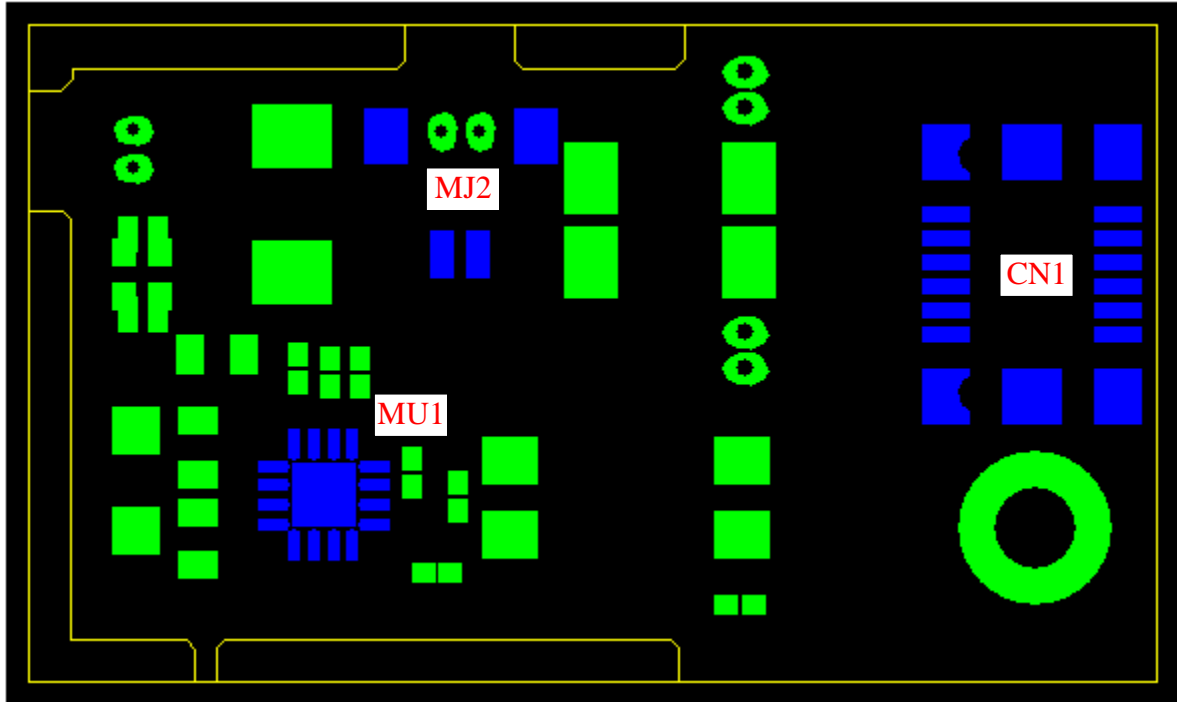

Figure B-5-1 Modem Board layout (Front)

NUM	Location	Function
(01)	CN1	Modem Board to M/B CONN
(02)	MJ2	Modem Board to RJ11 CONN
(03)	MU1	Modem IC

Table B-5-2 SIM (3G) Board components

Appendix C Pin Assignment

CN8 LCD Panel Connector

PIN No.	Signal name	I/O	PIN No.	Signal name	I/O
1	LCDVCC	---	2	LCDVCC	---
3	+3V	---	4	LCD_EDIDCLK	O
5	LCD_EDIDDATA	I/O	6	GND	---
7	LCD_TXLOUT0-	O	8	LCD_TXLOUT0+	O
9	GND	---	10	LCD_TXLOUT1-	O
11	LCD_TXLOUT1+	O	12	GND	---
13	LCD_TXLOUT2-	O	14	LCD_TXLOUT2+	O
15	GND	---	16	LCD_TXLCLKOUT-	O
17	LCD_TXLCLKOUT+	O	18	GND	---
19	LVDS_VADJ	O	20	DISPON	O
21	N106571630	---	22	VIN	---
23	VIN	---	24	NC	---
25	USBP0+_LCD	I/O	26	USBP0-_LCD	I/O
27	CCD_POWER	---	28	N101737963	O
29	N101737965	I	30	GND	---

CN9 Power/B Connector

PIN No.	Signal name	I/O	PIN No.	Signal name	I/O
1	NC	---	2	NBSWON#	I
3	NC	---	4	GND	---

CN10 Touch Pad Board Connector

PIN No.	Signal name	I/O	PIN No.	Signal name	I/O
----------------	--------------------	------------	----------------	--------------------	------------

Pin Assignment

1	+5V_TP	---	2	TPCLK_L	O
3	TPDATA_L	I/O	4	GND	---
5	TP_ON_OFF	I	6	GND	---

CN11 Bluetooth Connector

PIN No.	Signal name	I/O	PIN No.	Signal name	I/O
1	BT_POWER	---	2	BT_RESET	O
3	USBP2+	I/O	4	USBP2-	I/O
5	BT_Detect#	I	6	GND	---

CN12 Keyboard Connector

PIN No.	Signal name	I/O	PIN No.	Signal name	I/O
1	K_LED_P	---	2	MY16	O
3	NC	---	4	MY17	O
5	NC	---	6	K_LED_P	---
7	MY2	O	8	MY1	O
9	MY0	O	10	MY4	O
11	MY3	O	12	MY5	O
13	MY14	O	14	MY6	O
15	MY7	O	16	MY13	O
17	MY8	O	18	MY9	O
19	MY10	O	20	MY11	O
21	MY12	O	22	MY15	O
23	MX7	O	24	MX2	O
25	MX3	O	26	MX4	O
27	MX0	O	28	MX5	O
29	MX6	O	30	MX1	O

Pin Assignment

31	K_LED_P	---	32	CAPSLED	O
33	NC	---	34	NUMLED	O

CN13 Speaker Connector

PIN No.	Signal name	I/O	PIN No.	Signal name	I/O
1	INSPKL+N	O	2	INSPKL-N	O
3	INSPKR-N	O	4	INSPKR+N	O
5	NC	---	6	GND	---

CN14 CRT Connector

PIN No.	Signal name	I/O	PIN No.	Signal name	I/O
1	+5V	---	2	CRT_DDCCLK	O
3	CRT_DDCDAT	I/O	4	+3V	---
5	CRT_VSYNC	O	6	CRT_HSYNC	O
7	GND	---	8	RED_L	O
9	GND	---	10	GREEN_L	O
11	GND	---	12	BULE_L	O
13	GND	---	14	CRT_SENSE#	I
15	GND	---	16	USBP10+	I/O
17	USBP10-	I/O	18	GND	---
19	USBOC#8_9	I	20	USB_EN1#	O
21	+5VPCU	---	22	+5VPCU	---
23	+5VPCU	---	24	+5VPCU	---

CN15 Earphone Connector

PIN No.	Signal name	I/O	PIN No.	Signal name	I/O
1	GND	---	2	HPOUT-L3	O

Pin Assignment

3	HPOUT-R3	O	4	GND	---
5	Port_A#	I	6	NC	---
7	GND	---	8	GND	---
9	GND	---	10	GND	---

CN16 External MIC Connector

PIN No.	Signal name	I/O	PIN No.	Signal name	I/O
1	GND	---	2	MIC1_L3	I
3	MIC1_R3	I	4	GND	---
5	Port_B#	I	6	NC	---
7	GND	---	8	NC	---
9	GND	---	10	NC	---

CN17 HDMI Connector

PIN No.	Signal name	I/O	PIN No.	Signal name	I/O
1	HDMITX2P	O	2	GND	---
3	HDMITX2N	O	4	HDMITX1P	O
5	GND	---	6	HDMITX1N	O
7	HDMITX0P	O	8	GND	---
9	HDMITX0N	O	10	HDMICLK+	O
11	GND	---	12	HDMICLK-	O
13	NC	---	14	NC	---
15	HDMI_DDCCK	O	16	HDM_DDCDAT	I/O
17	GND	---	18	DDC5V	---
19	HDMI_CON_HP	I	20	GND	---
21	GND	---	22	GND	---
23	GND	---			

Pin Assignment

CN18 E-SATA Connector

PIN No.	Signal name	I/O	PIN No.	Signal name	I/O
1	USBPWR1	---	2	R_BUSBP13-	I/O
3	R_BUSBP13+	I/O	4	GND	---
5	GND	---	6	SATA_TXP2_C	O
7	SATA_TXN2_C	O	8	GND	---
9	SATA_RXN2_C	I	10	SATA_RXP2_C	I
11	GND	---	12	GND	---
13	GND	---	14	GND	---
15	GND	---			

CN19 USB Connector

PIN No.	Signal name	I/O	PIN No.	Signal name	I/O
1	USBPWR1	---	2	USBP9-_C	I/O
3	USBP9+_C	I/O	4	GND	---
5	GND	---	6	GND	---
7	GND	---	8	GND	---

CN20 LAN RJ45 Connector

PIN No.	Signal name	I/O	PIN No.	Signal name	I/O
1	X-TX0P	I/O	2	X-TX0N	I/O
3	X-TX1P	I/O	4	X-TX2P	I/O
5	X-TX2N	I/O	6	X-TX1N	I/O
7	X-TX3P	I/O	8	X-TX3N	I/O
9	LAN_VCC4	O	10	LAN_LINKLED#_R	O

Pin Assignment

CN21 3in1 Card Reader Connector

PIN No.	Signal name	I/O	PIN No.	Signal name	I/O
1	SD_DAT2/XD_RE#_R	I	2	GND	---
3	SD_DAT3/XD_WE#_R	I	4	VCC_XD	---
5	SD_MS_CLK_RMS	O	6	SD_CMD_R	I/O
7	XD_D7/MS_D3	I/O	8	MS_INS#	I
9	GND	---	10	XD_D2/MS_D2	I/O
11	VCC_XD	---	12	SD_DAT0/XD_D6/MS_D0	I/O
13	XD_D3/MS_D1	I/O	14	SD_MS_CLK_R	O
15	XD_D5/MS_BS	I/O	16	GND	---
17	GND	---	18	SD_DAT0/XD_D6/MS_D0_R	I/O
19	XD_D4/SD_D1_R	I/O	20	SD_WP_R	I
21	SD_CD#_R	I	22	GND	O
23	GND	I	24	NC	

CN22 RTC Battery Connector

PIN No.	Signal name	I/O	PIN No.	Signal name	I/O
1	GND	---	2	N86171025	I

CN23 FAN Connector

PIN No.	Signal name	I/O	PIN No.	Signal name	I/O
1	TH_FAN_POWER_C	---	2	GND	---
3	FANSIG1	I			

CN24 MINI Card Slot#1 (Wi-Fi) Connector

PIN No.	Signal name	I/O	PIN No.	Signal name	I/O
1	WLAN_WAKE#	O	2	WIMAX_P	---

Pin Assignment

3	NC	---	4	GND	---
5	BT_EN#	---	6	+1.5V	---
7	PCIE_CLK_RQ5#	I	8	LAD0_PCIE	I/O
9	GND	---	10	LAD1_PCIE	I/O
11	CLK_PCIE_WLANN	O	12	LAD2_PCIE	I/O
13	CLK_PCIE_WLANP	O	14	LAD3_PCIE	I/O
15	GND	---	16	LFRAME#_PCIE	I/O
17	NC	---	18	GND	---
19	NC	---	20	RF_EN	O
21	GND	---	22	PLTRST#	O
23	PCIE_RXN0	I	24	+3V_S5	---
25	PCIE_RXP0	I	26	GND	---
27	GND	---	28	+1.5V	---
29	GND	---	30	WL_SMCLK	O
31	PCIE_TXN0	O	32	WL_SMDATA	I/O
33	PCIE_TXP0	O	34	GND	---
35	GND	---	36	USBP5-	I/O
37	GND	---	38	USBP5+	I/O
39	WIMAX_P	---	40	GND	---
41	WIMAX_P	---	42	NC	---
43	GND	---	44	NC	---
45	CL_CLK1_WLAN	I/O	46	NC	---
47	PLTRST#_PCIE	O	48	+1.5V	---
49	CL_RST#1_WLAN	I	50	GND	---
51	SERIRQ_debug	I/O	52	WIMAX_P	---
53	NC		54	NC	
55	NC		56	NC	

Pin Assignment

CN25 MINI Card Slot#2 3G Connector

PIN No.	Signal name	I/O	PIN No.	Signal name	I/O
1	3G_WAKE#	O	2	+3V_3G	---
3	NC	---	4	GND	---
5	NC	---	6	+1.5V_3G	---
7	PCIE_CLK_REQ4#	I	8	UIM_PWR	---
9	GND	---	10	UIM_DATA	I/O
11	CLK_PCIE_3G#	O	12	UIM_CLK	O
13	CLK_PCIE_3G	O	14	UIM_RST	O
15	GND	---	16	UIM_VPP	---
17	NC	---	18	GND	---
19	NC	---	20	3G_EN	O
21	GND	---	22	PLTRST#	O
23	PCIE_RXN1	I	24	+3V_3G	---
25	PCIE_RXP1	I	26	GND	---
27	GND	---	28	+1.5V_3G	---
29	GND	---	30	NC	---
31	PCIE_TXN1	O	32	NC	---
33	PCIE_TXP1	O	34	GND	---
35	GND	---	36	USBP8-	I/O
37	NC	---	38	USBP8+	I/O
39	+3V_3G	---	40	CPUSB#	I
41	+3V_3G	---	42	NC	---
43	GND	---	44	NC	---
45	NC	---	46	NC	---
47	NC	---	48	+1.5V_3G	---
49	NC	---	50	GND	---

Pin Assignment

51	NC	---	52	+3V_3G	---
53	GND		54	GND	
55	NC		56	NC	

CN26 DDRIII Connector

PIN No.	Signal name	I/O	PIN No.	Signal name	I/O
1	SMDDR_VREF_DIMM	O	2	GND	---
3	GND	---	4	M_B_DQ4	I/O
5	M_B_DQ0	I/O	6	M_B_DQ5	I/O
7	M_B_DQ1	I/O	8	GND	---
9	GND	---	10	M_B_DQSN0	I/O
11	M_B_DM0	O	12	M_B_DQSP0	I/O
13	GND	---	14	GND	---
15	M_B_DQ7	I/O	16	M_B_DQ3	I/O
17	M_B_DQ6	I/O	18	M_B_DQ2	I/O
19	GND	---	20	GND	---
21	M_B_DQ13	I/O	22	M_B_DQ12	I/O
23	M_B_DQ9	I/O	24	M_B_DQ8	I/O
25	GND	---	26	GND	---
27	M_B_DQSN1	I/O	28	M_B_DM1	O
29	M_B_DQSP1	I/O	30	M_B_RST#	O
31	GND	I/O	32	GND	I/O
33	M_B_DQ11	---	34	M_B_DQ14	---
35	M_B_DQ10	I/O	36	M_B_DQ15	I/O
37	GND	I/O	38	GND	I/O
39	M_B_DQ16	---	40	M_B_DQ20	---
41	M_B_DQ21	---	42	M_B_DQ17	---

Pin Assignment

43	GND	I/O	44	GND	I/O
45	M_B_DQSN2	I/O	46	M_B_DM2	I/O
47	M_B_DQSP2	---	48	GND	---
49	GND	I/O	50	M_B_DQ18	O
51	M_B_DQ22	I/O	52	M_B_DQ23	I/O
53	M_B_DQ19	---	54	GND	---
55	GND	I/O	56	M_B_DQ28	I/O
57	M_B_DQ24	I/O	58	M_B_DQ25	I/O
59	M_B_DQ29	---	60	GND	---
61	GND	I/O	62	M_B_DQSN3	I/O
63	M_B_DM3	I/O	64	M_B_DQSP3	I/O
65	GND	---	66	GND	---
67	M_B_DQ26	I/O	68	M_B_DQ30	I/O
69	M_B_DQ27	I/O	70	M_B_DQ31	I/O
71	GND	---	72	GND	---
73	M_B_CKE0	O	74	M_B_CKE1	O
75	+1.5VSUS	---	76	+1.5VSUS	---
77	NC	---	78	M_B_A15	O
79	M_B_BANK2	O	80	M_B_A14	O
81	+1.5VSUS	---	82	+1.5VSUS	---
83	M_B_A12	O	84	M_B_A11	O
85	M_B_A9	O	86	M_B_A7	O
87	+1.5VSUS	---	88	+1.5VSUS	---
89	M_B_A8	O	90	M_B_A6	O
91	M_B_A5	O	92	M_B_A4	O
93	+1.5VSUS	---	94	+1.5VSUS	---
95	M_B_A3	O	96	M_B_A2	O

Pin Assignment

97	M_B_A1	O	98	M_B_A0	O
99	+1.5VSUS	---	100	+1.5VSUS	---
101	M_B_CLKP1	O	102	M_B_CLKP2	O
103	M_B_CLKN1	O	104	M_B_CLKN2	O
105	+1.5VSUS	---	106	+1.5VSUS	---
107	M_B_A10	O	108	M_B_BANK1	O
109	M_B_BANK0	O	110	M_B_RAS#	O
111	+1.5VSUS	---	112	+1.5VSUS	---
113	M_B_WE#	O	114	M_B_CS#0	O
115	M_B_CAS#	O	116	M_B_ODT0	O
117	+1.5VSUS	---	118	+1.5VSUS	---
119	M_B_A13	O	120	M_B_ODT1	O
121	M_B_CS#1	O	122	NC	---
123	+1.5VSUS	---	124	+1.5VSUS	---
125	NC	---	126	SMDDR_VREF_DIMM	---
127	GND	---	128	GND	---
129	M_B_DQ32	I/O	130	M_B_DQ36	I/O
131	M_B_DQ37	I/O	132	M_B_DQ33	I/O
133	GND	---	134	GND	I/O
135	M_B_DQSN4	I/O	136	M_B_DM4	I/O
137	M_B_DQSP4	I/O	138	GND	---
139	GND	---	140	M_B_DQ38	I/O
141	M_B_DQ34	I/O	142	M_B_DQ39	I/O
143	M_B_DQ35	I/O	144	GND	---
145	GND	---	146	M_B_DQ44	I/O
147	M_B_DQ41	I/O	148	M_B_DQ45	I/O
149	M_B_DQ40	I/O	150	GND	---

Pin Assignment

151	GND	---	152	M_B_DQSN5	I/O
153	M_B_DM5	I/O	154	M_B_DQSP5	I/O
155	GND	---	156	GND	---
157	M_B_DQ43	I/O	158	M_B_DQ46	I/O
159	M_B_DQ47	I/O	160	M_B_DQ42	I/O
161	GND	---	162	GND	---
163	M_B_DQ53	I/O	164	M_B_DQ50	I/O
165	M_B_DQ52	I/O	166	M_B_DQ48	I/O
167	GND	---	168	GND	---
169	M_B_DQSN6	I/O	170	M_B_DM6	O
171	M_B_DQSP6	I/O	172	GND	---
173	GND	---	174	M_B_DQ54	I/O
175	M_B_DQ51	I/O	176	M_B_DQ55	I/O
177	M_B_DQ49	I/O	178	GND	---
179	GND	---	180	M_B_DQ59	I/O
181	M_B_DQ56	I/O	182	M_B_DQ61	I/O
183	M_B_DQ57	I/O	184	GND	---
185	GND	---	186	M_B_DQSN7	I/O
187	M_B_DM7	O	188	M_B_DQSP7	I/O
189	GND	---	190	GND	---
191	M_B_DQ60	I/O	192	M_B_DQ58	I/O
193	M_B_DQ62	I/O	194	M_B_DQ63	I/O
195	GND	---	196	GND	---
197	N110983606	---	198	NC	I
199	+3V	---	200	PDAT_SMB	I/O
201	N110983570	---	202	PCLK_SMB	O
203	+SMDDR_VTERM	---	204	+SMDDR_VTERM	---

Pin Assignment

205	NC	---	206	NC	---
207	NC	---	208	NC	---

CN27 Modem Connector

PIN No.	Signal name	I/O	PIN No.	Signal name	I/O
1	GND	---	2	GND	---
3	GND	---	4	GND	---
5	GND	---	6	GND	---
7	DIB_P	I/O	8	GND	---
9	DIB_N	I/O	10	GND	---
11	GND	---	12	GND	---

CN28 DDRIII Connector

PIN No.	Signal name	I/O	PIN No.	Signal name	I/O
1	SMDDR_VREF_DIMM	O	2	GND	---
3	GND	---	4	M_A_DQ4	I/O
5	M_A_DQ0	I/O	6	M_A_DQ7	I/O
7	M_A_DQ5	I/O	8	GND	---
9	GND	---	10	M_A_DQSN0	I/O
11	M_A_DM0	O	12	M_A_DQSP0	I/O
13	GND	---	14	GND	---
15	M_A_DQ3	I/O	16	M_A_DQ1	I/O
17	M_A_DQ6	I/O	18	M_A_DQ2	I/O
19	GND	---	20	GND	---
21	M_A_DQ10	I/O	22	M_A_DQ15	I/O

Pin Assignment

23	M_A_DQ8	I/O	24	M_A_DQ13	I/O
25	GND	---	26	GND	---
27	M_A_DQSN1	I/O	28	M_A_DM1	O
29	M_A_DQSP1	I/O	30	M_A_RST#	O
31	GND	I/O	32	GND	I/O
33	M_A_DQ9	---	34	M_A_DQ14	---
35	M_A_DQ12	I/O	36	M_A_DQ11	I/O
37	GND	I/O	38	GND	I/O
39	M_A_DQ23	---	40	M_A_DQ17	---
41	M_A_DQ18	---	42	M_A_DQ21	---
43	GND	I/O	44	GND	I/O
45	M_A_DQSN2	I/O	46	M_A_DM2	I/O
47	M_A_DQSP2	---	48	GND	---
49	GND	I/O	50	M_A_DQ20	O
51	M_A_DQ22	I/O	52	M_A_DQ19	I/O
53	M_A_DQ16	---	54	GND	---
55	GND	I/O	56	M_A_DQ26	I/O
57	M_A_DQ24	I/O	58	M_A_DQ29	I/O
59	M_A_DQ31	---	60	GND	---
61	GND	I/O	62	M_A_DQSN3	I/O
63	M_B_DM3	I/O	64	M_A_DQSP3	I/O
65	GND	---	66	GND	---
67	M_A_DQ28	I/O	68	M_A_DQ27	I/O
69	M_A_DQ25	I/O	70	M_A_DQ30	I/O
71	GND	---	72	GND	---
73	M_A_CKE0	O	74	M_A_CKE1	O
75	+1.5VSUS	---	76	+1.5VSUS	---

Pin Assignment

77	NC	---	78	M_A_A15	O
79	M_A_BANK2	O	80	M_A_A14	O
81	+1.5VSUS	---	82	+1.5VSUS	---
83	M_A_A12	O	84	M_A_A11	O
85	M_A_A9	O	86	M_A_A7	O
87	+1.5VSUS	---	88	+1.5VSUS	---
89	M_A_A8	O	90	M_A_A6	O
91	M_A_A5	O	92	M_A_A4	O
93	+1.5VSUS	---	94	+1.5VSUS	---
95	M_A_A3	O	96	M_A_A2	O
97	M_A_A1	O	98	M_A_A0	O
99	+1.5VSUS	---	100	+1.5VSUS	---
101	M_A_CLKP1	O	102	M_A_CLKP2	O
103	M_A_CLKN1	O	104	M_A_CLKN2	O
105	+1.5VSUS	---	106	+1.5VSUS	---
107	M_A_A10	O	108	M_A_BANK1	O
109	M_A_BANK0	O	110	M_A_RAS#	O
111	+1.5VSUS	---	112	+1.5VSUS	---
113	M_A_WE#	O	114	M_A_CS#0	O
115	M_A_CAS#	O	116	M_A_ODT0	O
117	+1.5VSUS	---	118	+1.5VSUS	---
119	M_A_A13	O	120	M_A_ODT1	O
121	M_A_CS#1	O	122	NC	---
123	+1.5VSUS	---	124	+1.5VSUS	---
125	NC	---	126	SMDDR_VREF_DIMM	---
127	GND	---	128	GND	---
129	M_A_DQ32	I/O	130	M_A_DQ34	I/O

Pin Assignment

131	M_A_DQ37	I/O	132	M_A_DQ39	I/O
133	GND	---	134	GND	I/O
135	M_A_DQSN4	I/O	136	M_A_DM4	I/O
137	M_A_DQSP4	I/O	138	GND	---
139	GND	---	140	M_A_DQ33	I/O
141	M_A_DQ36	I/O	142	M_A_DQ38	I/O
143	M_A_DQ35	I/O	144	GND	---
145	GND	---	146	M_A_DQ47	I/O
147	M_A_DQ41	I/O	148	M_A_DQ45	I/O
149	M_A_DQ40	I/O	150	GND	---
151	GND	---	152	M_A_DQSN5	I/O
153	M_A_DM5	I/O	154	M_A_DQSP5	I/O
155	GND	---	156	GND	---
157	M_A_DQ42	I/O	158	M_A_DQ44	I/O
159	M_A_DQ43	I/O	160	M_A_DQ46	I/O
161	GND	---	162	GND	---
163	M_A_DQ49	I/O	164	M_A_DQ50	I/O
165	M_A_DQ55	I/O	166	M_A_DQ53	I/O
167	GND	---	168	GND	---
169	M_A_DQSN6	I/O	170	M_A_DM6	O
171	M_A_DQSP6	I/O	172	GND	---
173	GND	---	174	M_A_DQ48	I/O
175	M_A_DQ51	I/O	176	M_A_DQ52	I/O
177	M_A_DQ54	I/O	178	GND	---
179	GND	---	180	M_A_DQ57	I/O
181	M_A_DQ63	I/O	182	M_A_DQ60	I/O
183	M_A_DQ56	I/O	184	GND	---

Pin Assignment

185	GND	---	186	M_A_DQSN7	I/O
187	M_A_DM7	O	188	M_A_DQSP7	I/O
189	GND	---	190	GND	---
191	M_A_DQ59	I/O	192	M_A_DQ62	I/O
193	M_A_DQ61	I/O	194	M_A_DQ58	I/O
195	GND	---	196	GND	---
197	N110990353	O	198	NC	I
199	+3V	---	200	PDAT_SMB	I/O
201	N110990351	--	202	CGCLK_SMB	O
203	+SMDDR_VTERM	---	204	+SMDDR_VTERM	---
205	NC	---	206	NC	---
207	NC	---	208	NC	---

CN29 SATA ODD Connector

PIN No.	Signal name	I/O	PIN No.	Signal name	I/O
1	GND	---	2	SATA_TXP1	O
3	SATA_TXN1	O	4	GND	---
5	SATA_RXN1_C	I	6	SATA_RXP1_C	I
7	GND	---	8	DP-pin (pull low 1 Kohm to GND)	---
9	+5V_ODD	---	10	+5V_ODD	---
11	NC	---	12	GND	---
13	GND	---	14	GND	---
15	GND	---	16	NC	
17	NC				

Pin Assignment

CN30 SATA HDD Connector

PIN No.	Signal name	I/O	PIN No.	Signal name	I/O
1	GND	---	2	BSATA_TXP0	O
3	BSATA_TXN0	O	4	GND	---
5	BSATA_RXN0	I	6	BSATA_RXP0	I
7	GND	---	8	NC	---
9	NC	---	10	NC	---
11	GND	---	12	GND	---
13	GND	---	14	+5V_HDD1	---
15	+5V_HDD1	---	16	+5V_HDD1	---
17	GND	---	18	NC	---
19	GND	---	20	NC	---
21	NC	---	22	NC	---
23	GND	---	24	GND	---
11	LAN_ACTLED_P	O	12	LAN_ACTLED_N	O
13	GND		14	GND	

PCN7 Battery Connector

PIN No.	Signal name	I/O	PIN No.	Signal name	I/O
1	GND	---	2	GND	---
3	M-CLOCK	O	4	M-DATA	I/O
5	TEMP_MBAT	I	6	N80262138	---
7	ID	I	8	MBAT+	---
9	MBAT+	---	10	GND	---
11	GND	---			

Pin Assignment

PCN8 DC-IN Connector

PIN No.	Signal name	I/O	PIN No.	Signal name	I/O
1	GND	---	2	GND	---
3	DC_JACK	---	4	DC_JACK	---

JSIM7 3G/B Connector

PIN No.	Signal name	I/O	PIN No.	Signal name	I/O
1	GND	---	2	UIM_CLK	O
3	GND	---	4	UIM_DATA	I/O
5	GND	---	6	UIM_RST	O
7	UIM_VPP	---	8	UIM_PWR	---
9	NC	---	10	USBP11+	I/O
11	USBP11-	I/O	12	GND	---
13	GND	---	14	GND	---

Appendix D Display Codes

D.1 Display Codes

Cap No.	Keytop	Code set 1		Code set 2			Note
		Make	Break	Make	Break		
01	' ~	29	A9	0E	F0	0E	
02	1 !	02	82	16	F0	16	
03	2 @	03	83	1E	F0	1E	
04	3 #	04	84	26	F0	26	
05	4 \$	05	85	25	F0	25	
06	5 %	06	86	2E	F0	2E	
07	6 ^	07	87	36	F0	36	
08	7 &	08	88	3D	F0	3D	*2
09	8 *	09	89	3E	F0	3E	*2
10	9 (0A	8A	46	F0	46	*2
11	0)	0B	8B	45	F0	45	
12	- _	0C	8C	4E	F0	4E	
13	= +	0D	8D	55	F0	55	
15	BkSp	0E	8E	66	F0	66	
16	Tab	0F	8F	0D	F0	0D	
17	Q	10	90	15	F0	15	
18	W	11	91	1D	F0	1D	
19	E	12	92	24	F0	24	
20	R	13	93	2D	F0	2D	
21	T	14	94	2C	F0	2C	
22	Y	15	95	35	F0	35	
23	U	16	96	3C	F0	3C	*2
24	I	17	97	43	F0	43	*2
25	O	13	98	44	F0	44	*2
26	P	19	99	4D	F0	4D	*2
27	[{	1A	9A	54	F0	54	
28] }	1B	9B	5B	F0	5B	

Table D-1-1 Scan codes (set 1 and set 2) (1/4)

Display Codes

Cap No.	Keytop	Code set 1		Code set 2		Note	
		Make	Break	Make	Break		
29	\	2B	AB	5D	F0	5D	*5
30	Caps Lock	3A	BA	58	F0	58	
31	A	1E	9E	1C	F0	1C	
32	S	1F	9F	1B	F0	1B	
33	D	20	A0	23	F0	23	
34	F	21	A1	2B	F0	2B	
35	G	22	A2	34	F0	34	
36	H	23	A3	33	F0	33	
37	J	24	A4	3B	F0	3B	*2
38	K	25	A5	42	F0	42	*2
39	L	26	A6	4B	F0	4B	*2
40	; :	27	A7	4C	F0	4C	*2
41	' "	28	A8	52	F0	52	
43	Enter	1C	9C	5A	F0	5A	*3
44	Shift (L)	2A	AA	12	F0	12	
45	No.102 key	56	D6	61	F0	61	
46	Z	2C	AC	1A	F0	1A	
47	X	2D	AD	22	F0	22	
48	C	2E	AE	21	F0	21	
49	V	2F	AF	2A	F0	2A	
50	B	30	B0	32	F0	32	
51	N	31	B1	31	F0	31	
52	M	32	B2	3A	F0	3A	*2
53	, <	33	B3	41	F0	41	*2
54	. >	34	B4	49	F0	49	*2
55	/ ?	35	B5	4A	F0	4A	*2
57	Shift (R)	36	B6	59	F0	59	

Table D-1-1 Scan codes (set 1 and set 2) (2/4)

Display Codes

Cap No.	Keytop	Code set 1				Code set 2				Note
		Make		Break		Make		Break		
58	Ctrl	1D		9D		14		F0 14		*3
60	Alt (L)	38		B8		11		F0 11		*3
61	Space	39		B9		29		F0 29		
62	ALT (R)	E0	38	E0	B8	E0	11	E0	F0 11	
75	Ins	E0	52	E0	D2	E0	70	E0	F0 70	*1
76	Del	E0	53	E0	D3	E0	71	E0	F0 71	*1
79	←	E0	4B	E0	CB	E0	6B	E0	F0 6B	*1
80	Home	E0	47	E0	C7	E0	6C	E0	F0 6C	*1
81	End	E0	4F	E0	CF	E0	69	E0	F0 69	*1
83	↑	E0	48	E0	C8	E0	75	E0	F0 75	*1
84	↓	E0	50	E0	D0	E0	72	E0	F0 72	*1
85	PgUp	E0	49	E0	C9	E0	7D	E0	F0 7D	*1
86	PgDn	E0	51	E0	D1	E0	7A	E0	F0 7A	*1
89	→	E0	4D	E0	CD	E0	74	E0	F0 74	*1
110	Esc	01		81		76		F0 76		
112	F1	3B		BB		05		F0 05		
113	F2	3C		BC		06		F0 06		
114	F3	3D		BD		04		F0 04		
115	F4	3E		BE		0C		F0 0C		
116	F5	3F		BF		03		F0 03		
117	F6	40		C0		0B		F0 0B		
118	F7	41		C1		83		F0 83		
119	F8	42		C2		0A		F0 0A		
120	F9	43		C3		01		F0 01		
121	F10	44		C4		09		F0 09		*3

Table D-1-1 Scan codes (set 1 and set 2) (3/4)

Cap No.	Keytop	Code set 1				Code set 2				Note
		Make		Break		Make		Break		
122	F11	57	D7	78	F0	78			*3	
123	F12	58	D8	07	F0	07			*3	
124	PrintSc	*6	*6	*6	*6				*6	
126	Pause	*7	*7	*7	*7				*7	
202	Fn	—	—	—	—				*4	
203	Win	E0	5B	E0	DB	E0	1F	E0	F0	1F
204	App	E0	5D	E0	DD	E0	2F	E0	F0	2F

Table D-1-1 Scan codes (set 1 and set 2) (4/4)

Notes:

1. * Scan codes differ by mode.
2. * Scan codes differ by overlay function.
3. * Combined with the **Fn** key makes different codes.
4. * **Fn** key does not generate a code by itself.
5. * This key corresponds to key No. 42 in a 102-key model.
6. * Refer to Table D-6, No. 124 key scan code.
7. * Refer to Table D-7, No. 126 key scan code.

Display Codes

Cap No.	Key top	Code set 1				Code set 2			
		Make		Break		Make		Break	
55	/	E0 AA E0 35	E0 B5 E0 2A	E0 F0 12 E0 4A	E0 F0 4A E0 12				
75	INS	E0 AA E0 52	E0 D2 E0 2A	E0 F0 12 E0 70	E0 F0 70 E0 12				
76	DEL	E0 AA E0 53	E0 D3 E0 2A	E0 F0 12 E0 71	E0 F0 71 E0 12				
79	←	E0 AA E0 4B	E0 CB E0 2A	E0 F0 12 E0 6B	E0 F0 6B E0 12				
80	Home	E0 AA E0 47	E0 C7 E0 2A	E0 F0 12 E0 6C	E0 F0 6C E0 12				
81	End	E0 AA E0 4F	E0 CF E0 2A	E0 F0 12 E0 69	E0 F0 69 E0 12				
83	↑	E0 AA E0 48	E0 C8 E0 2A	E0 F0 12 E0 75	E0 F0 75 E0 12				
84	↓	E0 AA E0 50	E0 D0 E0 2A	E0 F0 12 E0 72	E0 F0 72 E0 12				
85	PgUp	E0 AA E0 49	E0 C9 E0 2A	E0 F0 12 E0 7D	E0 F0 7D E0 12				
86	PgDn	E0 AA E0 51	E0 D1 E0 2A	E0 F0 12 E0 7A	E0 F0 7A E0 12				
89	→	E0 AA E0 4D	E0 CD E0 2A	E0 F0 12 E0 74	E0 F0 74 E0 12				
203	Win	E0 AA E0 5B	E0 DB E0 2A	E0 F0 12 E0 1F	E0 F0 1F E0 12				
204	App	E0 AA E0 5D	E0 DD E0 2A	E0 F0 12 E0 2F	E0 F0 2F E0 12				

Table D-1-2 Scan codes with left Shift key

Note: The table above shows scan codes with the left **Shift** key. In combination with the right **Shift** key, scan codes are changed as listed below:

	With left Shift	With right Shift
Set 1	E0 AA _____	E0 B6
	E0 2A _____	E0 36
Set 2	E0 F0 12 _____	E0 F0 59
	E0 12 _____	E0 59

Display Codes

Cap No.	Key top	Code set 1				Code set 2			
		Make		Break		Make		Break	
75	INS	E0 2A	E0 52	E0 D2	E0 AA	E0 12	E0 70	E0 F0	70 E0 F0 12
76	DEL	E0 2A	E0 53	E0 D3	E0 AA	E0 12	E0 71	E0 F0	71 E0 F0 12
79	←	E0 2A	E0 4B	E0 CB	E0 AA	E0 12	E0 6B	E0 F0	6B E0 F0 12
80	Home	E0 2A	E0 47	E0 C7	E0 AA	E0 12	E0 6C	E0 F0	6C E0 F0 12
81	End	E0 2A	E0 4F	E0 CF	E0 AA	E0 12	E0 69	E0 F0	69 E0 F0 12
83	↑	E0 2A	E0 48	E0 C8	E0 AA	E0 12	E0 75	E0 F0	75 E0 F0 12
84	↓	E0 2A	E0 50	E0 D0	E0 AA	E0 12	E0 72	E0 F0	72 E0 F0 12
85	PgUp	E0 2A	E0 49	E0 C9	E0 AA	E0 12	E0 7D	E0 F0	7D E0 F0 12
86	PgDn	E0 2A	E0 51	E0 D1	E0 AA	E0 12	E0 7A	E0 F0	7A E0 F0 12
89	→	E0 2A	E0 4D	E0 CD	E0 AA	E0 12	E0 74	E0 F0	74 E0 F0 12
203	Win	E0 2A	E0 5B	E0 DB	E0 AA	E0 12	E0 1F	E0 F0	1F E0 F0 12
204	App	E0 2A	E0 5D	E0 DD	E0 AA	E0 12	E0 2F	E0 F0	2F E0 F0 12

Table D-1-3 Scan codes in Numlock mode

Cap No.	Keytop	Code set 1		Code set 2	
		Make	Break	Make	Break
43	ENT	E0 1C	E0 9C	E0 5A	E0 F0 5A
58	CTRL	E0 1D	E0 9D	E0 14	E0 F0 14
60	LALT	E0 38	E0 B8	E0 11	E0 F0 11
121	ARROW	45	C5	77	F0 77
122	NUMERIC	45	C5	77	F0 77
123	ScrI	46	C5	7E	F0 7E

Table D-1-4 Scan codes with Fn key

Display Codes

Cap No.	Keytop		Code set 1				Code set 2			
			Make		Break		Make		Break	
09	8	(8)	48		C8			75	F0	75
10	9	(9)	49		C9			7D	F0	7D
11	0	(*)	37		B7			7C	F0	7C
23	U	(4)	4B		CB			6B	F0	6B
24	I	(5)	4C		CC			73	F0	73
25	O	(6)	4D		CD			74	F0	74
26	P	(-)	4A		CA			7B	F0	7B
37	J	(1)	4F		CF			69	F0	69
38	K	(2)	50		D0			72	F0	72
39	L	(3)	51		D1			7A	F0	7A
40	;	(+)	4E		CE			79	F0	79
52	M	(0)	52		D2			70	F0	70
54	.	(.)	53		D3			71	F0	71
55	/	(/)	E0 35		E0 B5			40 4A	E0 F0	4A

Table D-1-5 Scan codes in overlay mode

Key top	Shift	Code set 1				Code set 2			
		Make		Break		Make		Break	
Prt Sc	Common	E0 2A	E0 37	E0 B7	E0 AA	E0 12	E0 7C	E0 F0	7C E0 F0 12
	Ctrl +	E0 37		E0 B7		E0 7C		E0 F0	7C
	Shift +	E0 37		E0 B7		E0 7C		E0 F0	7C
	Alt +		54	D4		84		F0 B4	

Table D-1-6 No.124 key scan code

Display Codes

Key top	Shift	Code set 1						Code set 2							
		Make						Make							
Pause	Common*	E1	1D	45	E1	9D	C5	E1	14	77	E1	F0	14	F0	77
	Ctrl*	E0	46	E0	C6			E0	7E	E0	F0	7E			

Table D-1-7 No.126 key scan code

**: This key generates only make codes.*

Appendix E Keyboard Layout

1. United States (US) Keyboard

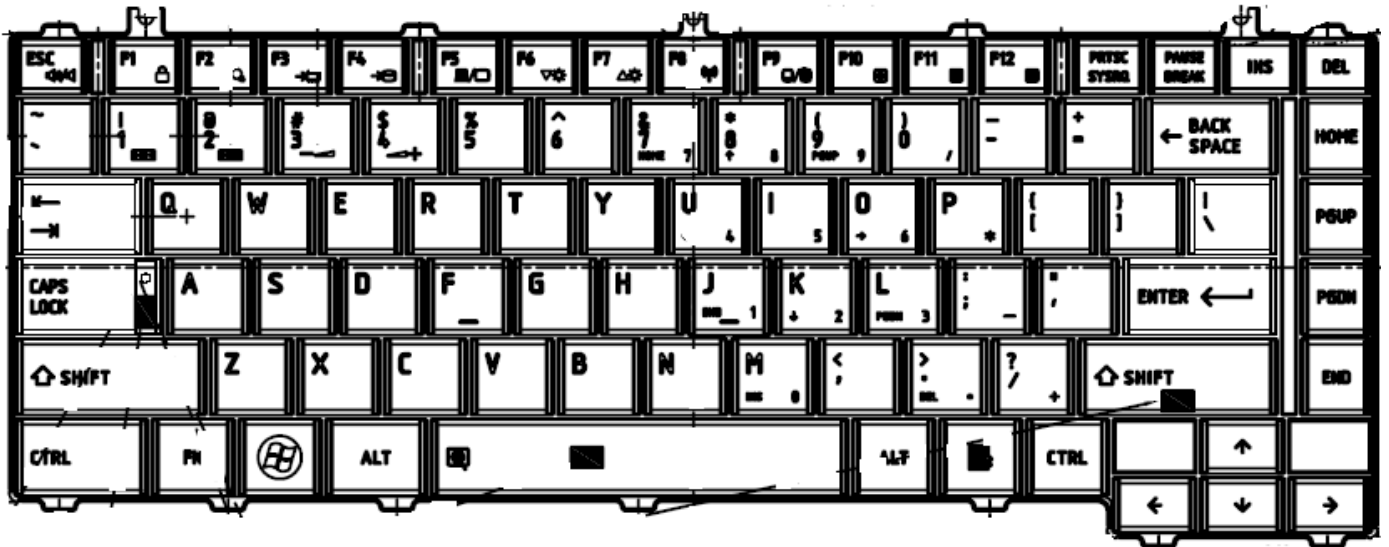

Figure E-1-1 US keyboard

2. United Kingdom (UK) Keyboard

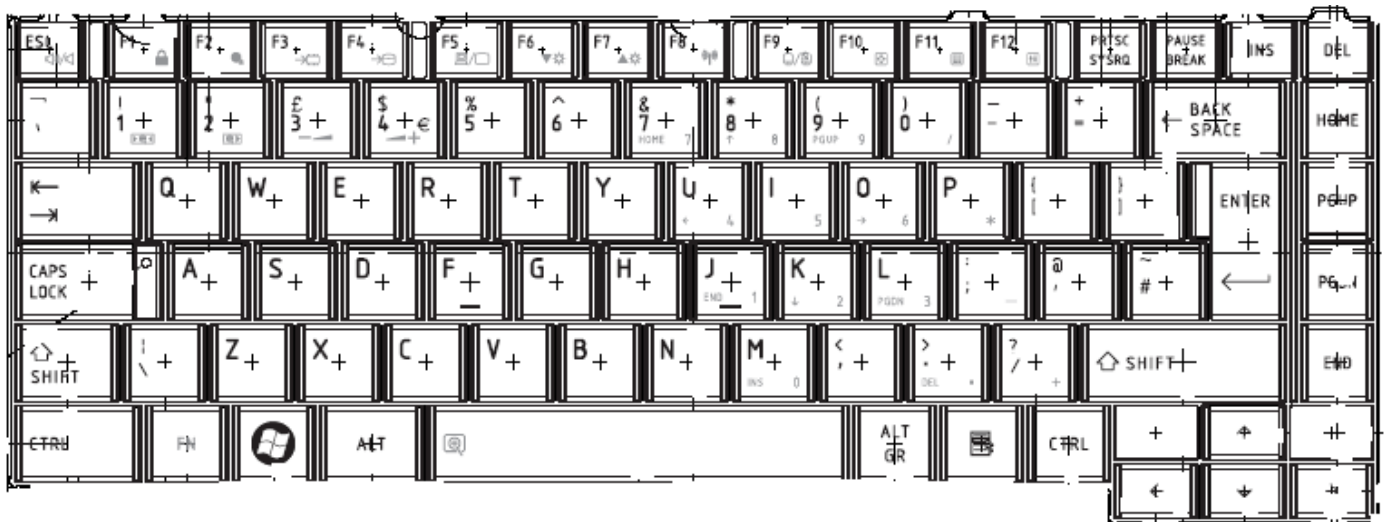

Figure E-2-1 UK keyboard

3. Japan Keyboard

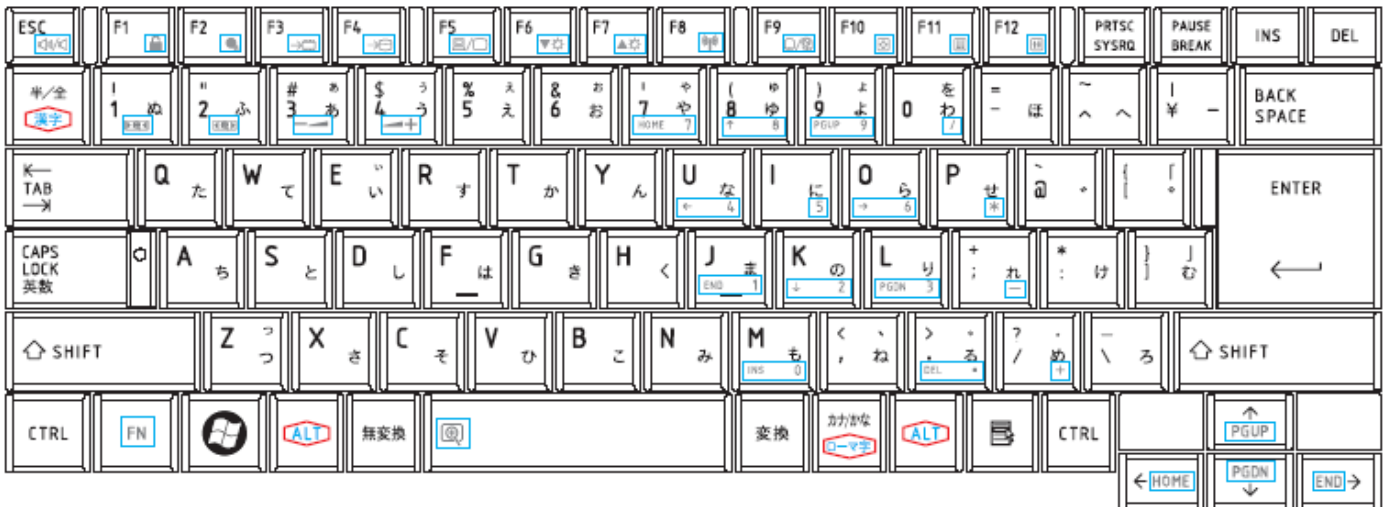

Figure E-3-1 Japan keyboard

Appendix F Wiring Diagrams

F.1 RGB Monitor ID Wraparound connector

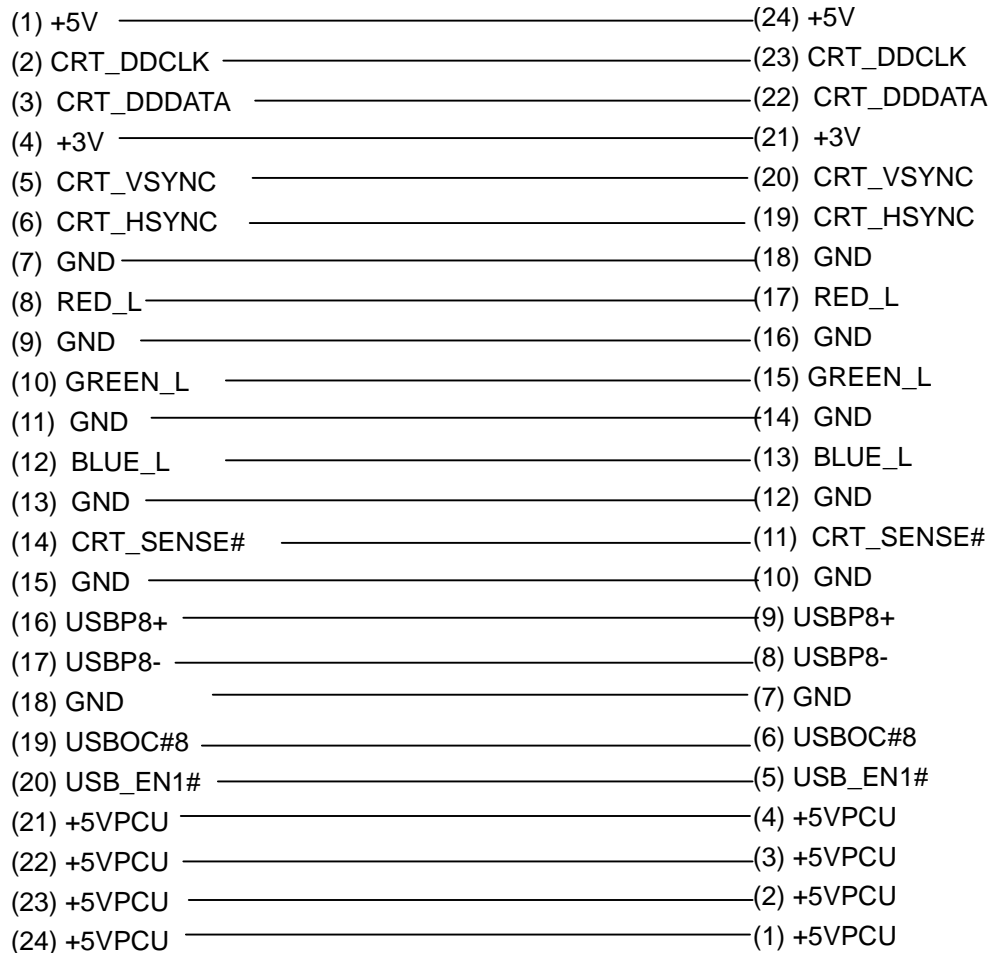

Figure F-1-1 RGB Monitor ID Wraparound connector (24PIN to 24PIN)

F.2 LAN Loopback Connector

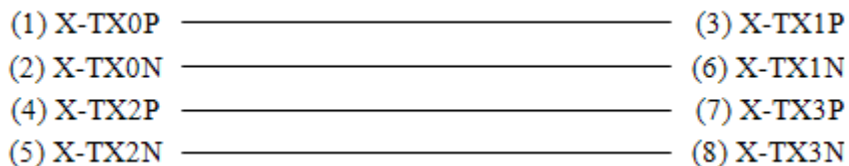

Figure F-2-1 LAN loopback connector

Free Manuals Download Website

<http://myh66.com>

<http://usermanuals.us>

<http://www.somanuals.com>

<http://www.4manuals.cc>

<http://www.manual-lib.com>

<http://www.404manual.com>

<http://www.luxmanual.com>

<http://aubethermostatmanual.com>

Golf course search by state

<http://golfingnear.com>

Email search by domain

<http://emailbydomain.com>

Auto manuals search

<http://auto.somanuals.com>

TV manuals search

<http://tv.somanuals.com>