

**Toshiba Personal Computer
Satellite X200/ X205
Maintenance Manual**

TOSHIBA CORPORATION

[CONFIDENTIAL]

Copyright

© 2007 by Toshiba Corporation. All rights reserved. Under the copyright laws, this manual cannot be reproduced in any form without the prior written permission of Toshiba. No patent liability is assumed with respect to the use of the information contained herein.

Toshiba Personal Computer Satellite X200/ X205 Maintenance Manual

First edition Mar. 2007

Disclaimer

The information presented in this manual has been reviewed and validated for accuracy. The included set of instructions and descriptions are accurate for the M100 Series at the time of this manual's production. However, succeeding computers and manuals are subject to change without notice. Therefore, Toshiba assumes no liability for damages incurred directly or indirectly from errors, omissions, or discrepancies between any succeeding product and this manual.

Trademarks

IBM is a registered trademark, and OS/2 and PS/2 are trademarks of IBM Corporation. Microsoft, MS-DOS, Windows, DirectSound and DirectMusic are registered trademarks of Microsoft Corporation.

Intel and Pentium are registered trademarks, and SpeedStep is a trademark of Intel Corporation. Sound Blaster is a registered trademark of Creative Technology Ltd.

Centronics is a registered trademark of Centronics Data Computer Corporation.

Photo CD is a trademark of Eastman Kodak.

All other properties are trademarks or registered trademarks of their respective holders.

Preface

This maintenance manual describes how to perform hardware service maintenance for the Toshiba Personal Computer Satellite X200/ X205, referred to as the M100 Series in this manual.

The procedures described in this manual are intended to help service technicians isolate faulty Field Replaceable Units (FRUs) and replace them in the field.

SAFETY PRECAUTIONS

Four types of messages are used in this manual to bring important information to your attention. Each of these messages will be italicized and identified as shown below.

DANGER: “Danger” indicates the existence of a hazard that could result in death or serious bodily injury if the safety instruction is not observed.

WARNING: “Warning” indicates the existence of a hazard that could result in bodily injury if the safety instruction is not observed.

CAUTION: “Caution” indicates the existence of a hazard that could result in property damage if the safety instruction is not observed.

NOTE: “Note” contains general information that relates to your safe maintenance service.

Improper repair of the computer may result in safety hazards. Toshiba requires service technicians and authorized dealers or service providers to ensure the following safety precautions are adhered to strictly.

- Be sure to fasten screws securely with the right screwdriver. If a screw is not fully fastened, it could come loose, creating a danger of a short circuit, which could cause overheating, smoke or fire.
- If you replace the battery pack or RTC battery, be sure to use only the same model battery or an equivalent battery recommended by Toshiba. Installation of the wrong battery can cause the battery to explode.

The manual is divided into the following parts:

- Chapter 1 Hardware Overview describes the M100 Series system unit and each FRU.
- Chapter 2 Troubleshooting Procedures explains how to diagnose and resolve FRU problems.
- Chapter 3 Test and Diagnostics describes how to perform test and diagnostic operations for maintenance service.
- Chapter 4 Replacement Procedures describes the removal and replacement of the FRUs.
- Appendices The appendices describe the following:

- Handling the LCD module
- Board layout
- Pin assignments
- Keyboard scan/character codes
- Key layout
- Screw torque list
- Reliability

Conventions

This manual uses the following formats to describe, identify, and highlight terms and operating procedures.

Acronyms

On the first appearance and whenever necessary for clarification, acronyms are enclosed in parentheses following their definition. For example:

Read Only Memory (ROM)

Keys

Keys are used in the text to describe many operations. The key top symbol as it appears on the keyboard is printed in **boldface** type.

Key operation

Some operations require you to simultaneously use two or more keys. We identify such operations by the key top symbols separated by a plus (+) sign. For example, **Ctrl + Pause (Break)** means you must hold down **Ctrl** and at the same time press **Pause (Break)**. If three keys are used, hold down the first two and at the same time press the third.

User input

Text that you are instructed to type in is shown in the boldface type below:

DISKCOPY A: B:

The display

Text generated by the computer that appears on its display is presented in the typeface below:

```
Format complete  
System transferred
```

Table of Contents

Chapter 1 Hardware Overview

1.1	Features	1-1
1.2	System Unit	1-5
1.3	2.5-inch Hard Disk Drive	1-6
1.4	DVD Super Multi Double Layer	1-8
1.5	HD DVD Drive	1-9
1.5.1	HD DVD-ROM	1-9
1.5.2	HD DVD-R	1-10
1.6	Power Supply	1-11
1.7	Batteries	1-13
1.7.1	Main Battery	1-14
1.7.2	RTC battery	1-15

Chapter 2 Troubleshooting Procedures

2.1	Troubleshooting Introduction	2-3
2.2	Troubleshooting Flowchart	2-4
2.3	Power Supply Troubleshooting	2-9
2.4	Display Troubleshooting	2-14
2.5	Keyboard Troubleshooting	2-17
2.6	External USB Devices Troubleshooting	2-19
2.7	TV-Out Failure Troubleshooting	2-21
2.8	TouchPad Troubleshooting	2-23
2.9	Speaker Troubleshooting	2-25
2.10	Optical drive troubleshooting	2-27
2.11	Modem Troubleshooting	2-30
2.12	Express card Troubleshooting	2-32
2.13	IEEE 1394 Troubleshooting	2-34
2.14	Wireless LAN Troubleshooting	2-36

2.15	Camera troubleshooting.....	2-38
2.16	Bluetooth Troubleshooting.....	2-40
2.17	4 in 1 card Troubleshooting.....	2-42
	HDD Troubleshooting.....	2-44
	CRT failure Troubleshooting	2-46
	HDMI Troubleshooting	2-48
	Robson Troubleshooting	2-50
	MIC Troubleshooting	2-52
	Finger Troubleshooting	2-54

Chapter 3 Tests and Diagnostics

3.1	The Diagnostic Test.....	3-3
3.2	Executing the Diagnostic Test	3-4
3.3	Display Configuration	3-8
3.4	Speaker Audio Test.....	3-9
3.5	Fan ON/OFF Test	3-10
3.6	Main Battery Charge Test.....	3-11
3.7	FDD Test.....	3-12
3.8	ODD Test.....	3-13
3.9	Keyboard Test.....	3-14
3.10	Mouse (Pad) Test	3-15
3.11	LCD Pixels Mode Test	3-18
3.12	Magnetic switch Test	3-19
3.13	LAN Test	3-20
3.14	RTC Test.....	3-23
3.15	Read 1394 GUID	3-24
3.16	Speaker EQ Check.....	3-25
3.17	Button Test	3-26
3.18	Fingerprint DOS Test	3-27
3.19	Clear Fingerprint Registered.....	3-29
3.20	1st HDD Test	3-30
3.21	2nd HDD Test.....	3-33

3.22	Front Edge Logo check	3-36
3.23	Write DMI	3-37
3.24	Read DMI	3-39

Chapter 4 Replacement Procedures

4.1	General	4-1
4.2	Battery	4-7
4.3	PC Card	4-9
4.4	Memory Card	4-11
4.5	HDD.....	4-13
4.6	Expansion Memory	4-18
4.7	Modem.....	4-21
4.8	Optical Drive Module.....	4-23
4.9	Optical Drive	4-25
4.10	Keyboard	4-27
4.11	Display Assembly.....	4-30
4.12	Function Button Board	4-34
4.13	Wireless LAN Unit.....	4-36
4.14	Bluetooth	4-38
4.15	Top Cover.....	4-39
4.16	Touch Pad.....	4-42
4.17	Fingerprint Module	4-44
4.18	Subwoofer Unit and USB Board.....	4-46
4.19	System Board	4-48
4.20	System Fan	4-51
4.21	VGA PCB.....	4-53
4.22	VGA Board.....	4-55
4.23	Fan and CPU	4-57

4.24	Display Mask	4-59
4.25	FL Inverter Board	4-63
4.26	LCD Module	4-65
4.27	Camera and Microphone	4-67

Appendices

Appendix A	Handling the LCD Module.....	A-1
Appendix B	Board Layout.....	B-1
Appendix C	Pin Assignments	C-1
Appendix D	Keyboard Scan/Character Codes.....	D-1
Appendix E	Key Layout	E-1
Appendix F	Series Screw Torque List.....	F-1
Appendix G	Reliability	G-1

Chapter 1

Hardware Overview

Chapter 1 Contents

1.1	Features	1-1
1.2	System Unit.....	1-5
1.3	2.5-inch Hard Disk Drive.....	1-6
1.4	DVD Super Multi Double Layer.....	1-8
1.5	HD DVD Drive.....	1-9
1.5.1	HD DVD-ROM	1-9
1.5.2	HD DVD-R	1-10
1.6	Power Supply	1-11
1.7	Batteries	1-13
1.7.1	Main Battery.....	1-14
1.7.2	RTC battery	1-15

Figures

Figure 1-1 2.5-inch HDD 1-6

Tables

Table 1-1 2.5-inch HDD specifications 1-6
Table 1-2 DVD Super Multi Double Layer drive specifications..... 1-8
Table 1-3 HD DVD-ROM drive specifications 1-9
Table 1-4 HD DVD-R drive specifications 1-10
Table 1-5 Battery specifications 1-13

1.1 Features

The Satellite X200/ X205 Series Personal Computer uses extensive Large Scale Integration (LSI), and Complementary Metal-Oxide Semiconductor (CMOS) technology extensively to provide compact size, minimum weight and high reliability. This computer incorporates the following features and benefits:

- ❑ CPU
 - Intel® Core™ 2 Duo Processor
 - Intel® Celeron® Processor
- ❑ Chipset
 - Mobile Intel® PM965 Express Chipset
- ❑ Memory
 - No on board memory
 - Support DDR-II 667MHz
 - Support Dual channel
 - Two SODIMM with 512MB/ 1GB/ 2GB module Max. 4GB
 - 8GB design ready waiting Intel validation
- ❑ BIOS
 - Phoenix TrustedCore(TM) NB
 - 1024KB Flash BIOS ROM
 - Suspend to RAM/Disk
 - ACPI compliant BIOS
 - SMBIOS V2.4
 - Security:
 - Power-On Password, Supervisor Password,
 - HDD password for WW and JP
 - USB memory Boot support .
 - USB Super Fetch support.
 - SD Super Fetch support.
 - No SD card boot.
 - Intel Dorrington support(Intel Media share)
- ❑ Power
 - Universal AC adapter, 90~264VAC, 47~63Hz.
 - 180W with 19V DC for Orlando 10H SKU
 - 9-cell Lithium Ion smart battery pack with 10.8V*6000mAh
 - Approximately 12 hours or longer charging time to 100% battery capacity with system switched on

- Approximately 4 hours charge time to 100% battery capacity with system switched off or suspend
- Approximately 1.5 days discharging time in Standby Mode for the 9-cell battery.
- Discharge time in shutdown mode is approximately 1 month
- ❑ HDD
 - 9.5mm/12.5mm, 2.5" HDD support
 - Serial ATA interface
 - Single or Dual HDD support
 - Up to 300GB per drive
- ❑ VGA
 - NB8E-SE
- ❑ Fixed Optical drives
 - 12.7mm height, DVD Super Multi device
 - 12.7mm height, DVD Super Multi device with Label Flash
 - 12.7mm height, HD DVD-ROM device
 - 12.7mm height, HD DVD-R device
- ❑ Optional devices
 - Build-in antenna for wireless LAN module
 - Build-in antenna for Bluetooth module
 - MDC module
- ❑ Keyboard
 - The computer's keyboard has 104 US keys. There are five types of keys: typewriter keys, keypad overlay, function keys, soft keys, and cursor control keys.
- ❑ Touch Pad with Two Buttons
 - Left button
 - Right button
- ❑ I/O Ports
 - Bridge media slot
 - USB (V2.0, horizontal type) x 6
 - HDMI
 - S/PDIF
 - Line-in
 - CIR (BTO)
 - Internal Microphone with Camera(BTO)
 - S-video
 - Fingerprint Authentication (BTO)

- 1394
- RJ11
- DC-in
- RGB, one DDC2b compliant VGA port 15pins
- Microphone-in jack
- Headphone-out jack
- Digital/Rotary volume control
- Wireless Communication Switch(BTO)
- Kensington lock
- Express Card Slot
 - TI 8402 card bus controller for the model with Bridge media slot
 - With Shutter door
 - No ZV-Port support
- Wireless LAN module
 - Dual-band built-in antenna for wireless LAN communication
 - 802.11g: Atheros(XB61L or XB63L) or Intel (WM3945ABG BGX), 802.11a/g: Atheros (XB62L) or Intel (WM3945ABG), 802.11a/g/n: Intel (4965AGN) or Atheros (XB72)
- Excellent Power Management Function
 - Standby mode, Suspend to RAM or Suspend to disk mode, using time out or hot key
 - HDD local standby mode by time out
 - LCD local standby mode by time out
 - Low battery alarm by beep
 - Auto-backlight off when LCD cover closed
 - Full ACPI 2.0 supported
 - LCD auto-dim mode by time out
- Switches
 - Power button
 - Two programmable launch buttons
 - Four control buttons for CD playing
 - Wireless communication switch
 - Media Play Switch
- Security
 - Fingerprint authentication
- AC Adapter
 - Universal AC adapter module

- Delta 180W adapters
- Output voltage: 19Vdc
- Input Voltage/Frequency range: 90-264Vac, 47-63Hz
- ❑ Display
 - 17" (16:10) TFT screen with a resolution of 1440 horizontal x 900 vertical pixels, CSV VA, high brightness approximately 200nits, WXGA+
 - 17" (16:10) TFT screen with a resolution of 1680 horizontal x 1050 vertical pixels, CSV, brightness approx 150nits, WSXGA+
- ❑ Multiple digital media card slot
 - Supports xD, SD, miniSD, MS, MS Pro, and MMC
- ❑ Universal Serial Bus (USB)

The computer has three Universal Serial Bus (USB) ports that comply with the USB 2.0 standard, which enable data transfer speeds more than 40 times faster than USB 1.1 (which this computer also supports.) The USB drives may be used to transfer data at Low, Full, and high speeds.
- ❑ Bluetooth module

Some computers in this series are equipped with Bluetooth functionality (Version 2.0 + EDR) with antenna. Bluetooth is a short-range wireless technology used to create PANs (Personal Area Networks) among your devices, and with other nearby devices like mobile computers, mobile phones, and digital cameras.
- ❑ OS
 - Windows Vista Home Basic/ Home Premium (32/64 bit support)
 - Windows Vista Business (32/64 support)
 - Vista Premium Logo

1.2 System Unit

The system unit is composed of the following major components:

- ❑ Processor (depending on the model you purchased)
 - Intel® Core™ 2 Duo Processor T7800/T7700/T7500/T7300 /T7250 /T7100/T5450
 - Intel® Celeron® Processor 550/540/530/520
- ❑ System logic
 - Mobile Intel® PM965 with ICH8M Chipset
- ❑ Memory
 - Two DDR-II 533/667MHz SO-DIMM
 - Supports Dual channel
 - Up to 4GB with 2GB module for Intel PM965 Chipset
- ❑ Video RAM (Depending on the model you purchased)
 - GDDR3 for nVidia NB8E-SE→VRAM 256M or 512M(16Mx32)
- ❑ Audio subsystem
 - Realtek High Definition Audio Codec ALC268
 - Microphone-in ,Line-In and headphone-out
 - Volume control: Digital control, rotary type, without mute function
 - Supports Microsoft Outlook Express audio
 - S/PDIF Out

1.3 2.5-inch Hard Disk Drive

The internal HDD is a random access non-volatile storage device. It has a non-removable 2.5-inch magnetic disk and mini-Winchester type magnetic heads. This computer supports: 9.5mm, 2.5" SATA HDD with 200GB capacity, 4200rpm.

9.5mm, 2.5" SATA HDD with 60/80/100/120/160GB capacity, 5400rpm.

9.5mm, 2.5" SATA HDD support with 80/100/120GB capacity, 7200rpm. (120GB Design Ready)

12.5mm, 2.5" SATA HDD support with 160/200GB capacity, 4200rpm

12.5mm, 2.5" SATA HDD support with 250/300GB capacity, 4200rpm. (250GB Design Ready)

The HDD is shown in Figure 1-1. Specifications are listed in Table 1-1.

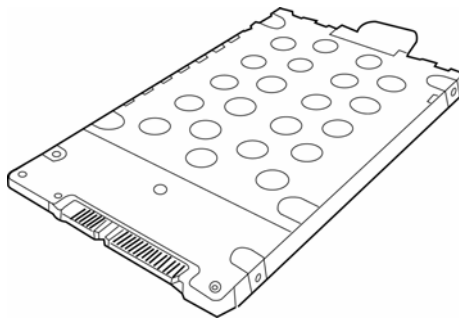

Figure 1-1 2.5-inch HDD

Items	60GB	80GB	100GB	120GB
Formatted capacity (GB)	55.89	74.52	93.15	111.8
Logical Blocks (LBA)	117,210,240	156,301,488	195,371,568	234,441,648
Rotational speed (rpm)	5400	5400	5400	5400
Toshiba HDD Buffer (MB)	8	8	8	8
Hitachi HDD Buffer (MB)	8	8	8	8
Fujitsu HDD Buffer (MB)	8	8	8	8
Bytes per sector	512	512	512	512

Table 1-1 2.5-inch HDD specifications

Items	160GB	200GB	250GB	300GB
Formatted capacity (GB)	149.05	186.31	232.89	279.46
Logical Blocks (LBA)	312,581,808	390,720,968	488,397,168	586,072,368
Rotational speed (rpm)	5400/4200	4200	4200	4200
Toshiba HDD Buffer (MB)	8	8	N/A	N/A
Hitachi HDD Buffer (MB)	8	N/A	N/A	N/A
Fujitsu HDD Buffer (MB)	8	8	8	8
Bytes per sector	512	512	512	512

Table 1-1 2.5-inch HDD specifications (Continued)

1.4 DVD Super Multi Double Layer

The DVD Super Multi drive accepts 12-cm (4.72-inch) and 8-cm (3.15-inch) discs. At maximum, the drive can play back a DVD at 8x speed, read CD-ROM at 24x speed, write CD-R at 24x speed and CD-RW at 4x speed, US CD-RW at 16x speed, High Speed CD-RW at 10x speed, DVD-R at 8x speed, DVD-RW at 6x speed, DVD+R at 8x speed, DVD+R (Double Layer) at 4x speed, DVD-R (Double Layer) at 4x speed, DVD+RW at 8x speed and DVD-RAM at 5x speed.

The specifications of the DVD Super Multi Double Layer drive are listed in Table 1-3.

Item	DVD-ROM mode	CD-ROM mode
Data transfer rate (Mbytes/s)	33.3 (U-DMA transfer mode 2) 16.6 (PIO mode 4, Multiword DMA mode 2)	
Access time (ms) Average random access	130	130
Data buffer size (Mbytes)	2MB	
Formats supported	DVD: DVD-VIDEO, DVD-ROM, DVD-R, DVD-RW, DVD-RAM, DVD+R, DVD+RW, DVD+R DL, DVD-R DL CD: CD-DA, CD-ROM, CD-R, CD-RW, CD-ROMXA, Photo CD (single/multi-session), CD-EXTRA, CD-Text	

Table 1-2 DVD Super Multi Double Layer drive specifications

1.5 HD DVD Drive

1.5.1 HD DVD-ROM

The HD DVD drive accepts 12-cm (4.72-inch) and 8-cm (3.15-inch) discs. At maximum, HD DVD-ROM reads HD DVD-ROMs at maximum 1x speed DVD-ROMs at maximum 8x speed and CD-ROMs at maximum 24x speed. It writes CD-R at up to 16x speed, CD-RW at up to 10x speed, DVD-R at maximum 4x speed, DVD-RW at maximum 6x speed, DVD+RW at maximum 4x speed, DVD+R at maximum 4x speed, DVD+R (double layer) at maximum 2.4x speed, DVD-R (dual layer) at maximum 2x speed and DVD-RAM at maximum 3x speed.

The specifications of the HD DVD-ROM drive are listed in Table 1-3.

Item	HD DVD-ROM mode	DVD-ROM mode	CD-ROM mode
Data transfer rate (Mbytes/s)	33.3 (U-DMA transfer mode 2) 16.6 (PIO mode 4, Multiword DMA mode 2)		
Access time (ms) Average random access	330	160	150
Data buffer size (Mbytes)	8MB		
Formats supported	HD DVD: HD DVD-ROM DVD: DVD-VIDEO, DVD-ROM, DVD-R, DVD-RW, DVD-RAM, DVD+R, DVD+RW, DVD+R DL, DVD-R DL CD: CD-DA, CD-ROM, CD-R, CD-RW, CD-ROMXA, Photo CD (single/multi-session), CD-EXTRA, CD-Text		

Table 1-3 HD DVD-ROM drive specifications

1.5.2 HD DVD-R

The HD DVD drive accepts 12-cm (4.72-inch) and 8-cm (3.15-inch) discs. At maximum, HD DVD-R reads HD DVD-ROMs at maximum 1x speed DVD-ROMs at maximum 8x speed and CD-ROMs at maximum 24x speed. It writes CD-R at up to 16x speed, CD-RW at up to 10x speed, DVD-R at maximum 4x speed, DVD-RW at maximum 4x speed, DVD+RW at maximum 4x speed, DVD+R at maximum 4x speed, DVD+R (double layer) at maximum 2.4x speed, DVD-R (dual layer) at maximum 2x speed DVD-RAM at maximum 3x speed and HD DVD-R at maximum 1x speed.

The specifications of the HD DVD-R drive are listed in Table 1-4.

Item	HD DVD-ROM mode	DVD-ROM mode	CD-ROM mode
Data transfer rate (Mbytes/s)	33.3 (U-DMA transfer mode 2) 16.6 (PIO mode 4, Multiword DMA mode 2)		
Access time (ms) Average random access	330	180	190
Data buffer size (Mbytes)	8MB		
Formats supported	HD DVD: HD DVD-ROM, HD DVD-R DVD: DVD-VIDEO, DVD-ROM, DVD-R, DVD-RW, DVD-RAM, DVD+R, DVD+RW, DVD+R DL, DVD-R DL CD: CD-DA, CD-ROM, CD-R, CD-RW, CD-ROMXA, Photo CD (single/multi-session), CD-EXTRA, CD-Text		

Table 1-4 HD DVD-R drive specifications

1.6 Power Supply

This specification defines the performance and characteristic of 180W AC adapter power supply. It supplies a constant voltage 19V output source for Satellite X200/ X205 Series Personal Computer.

- ❑ A/D conversion
 - The EC uses 10-bit sampling for A/D conversion to determine the following values:
 - Battery and temperature
- ❑ AC adaptor and battery check
 - The EC checks the following by A/D converted values:
 - Battery installed
 - The EC checks the following by GPIO values:
 - AC adaptor connected
- ❑ Abnormal check
 - The EC determines whether the condition is abnormal, and if so, stores an error code into the error register.
- ❑ Input port management
 - The EC monitors the following input signal status:
 - System power ON/OFF status
 - Direct CD power ON/OFF status
- ❑ Beep and LED control
 - Beep is caused by the low battery status.
 - The EC controls the following two kinds of LED
 - DC IN LED (one color: red)
 - Red: indicates AC adaptor is connected
 - Battery LED (two colors: orange and red)
 - Red solid: The battery is fully charged.
 - Orange: The computer is quick-charging the battery / The battery is low.
- ❑ Power ON/OFF sequence
 - When power is turned on or off, the EC starts the power on or off sequence.
 - SQ0-4 = power ON sequence
 - SQ5-B = power OFF sequence

- ❑ Battery charging control
 - The EC controls the following.
 - The quick charging ON/OFF
 - The detection of full charge

- ❑ Detection of the low battery
 - The EC detects the low battery point by the gas gauge.
 - LB10M: The system will be driven by the battery for 12 more minutes.
 - LB0: The battery won't be able to drive the system after 3 minutes.
 - LB1: The battery can drive the system only during the suspend process.
 - LB2: The battery cannot drive the system.

- ❑ New battery installation
 - When a new battery is installed, the EC communicates with the E²PROM in the battery to read information of the newly installed battery.

- ❑ Battery capacity calculation
 - The EC reads battery remaining and percentage capacity from the battery through SMBus.

1.7 Batteries

The computer has two types of battery:

- Main battery pack (18650 size)
- RTC battery

The removable main battery pack is the computer's main power source when the AC adaptor is not attached.

The battery specifications are listed in the table below.

Battery name	Material	Output voltage	Capacity
Main battery (9 cells)	Lithium-Ion	10.8V	6000mAh
RTC battery (Maxell ML1220T10)	Lithium-Ion	3.0V	14 mAh
RTC battery (Maxell ML1220HT10)	Lithium-Ion	3.0V	18 mAh
RTC battery (Sanyo ML1220T28)	Lithium-Ion	3.0V	15 mAh
RTC battery (Panasonic ML1220/B)	Lithium-Ion	3.0V	17 mAh

Table 1-5 Battery specifications

1.7.1 Main Battery

Battery charging is controlled by a power supply microprocessor that is mounted on the system board. The power supply microprocessor controls whether the charge is on or off and detects a full charge when the AC adaptor and battery are attached to the computer. The system charges the battery using quick charge or trickle charge.

Quick battery charge

When the AC adaptor is attached, there are two types of quick charge: quick charge when the system is powered off and normal charge when the system is powered on.

The times required for charges are listed in the table below.

Status	Charging time
Normal charge (power on)	12 hours or longer
Quick charge (power off)	About 4 hours or longer

NOTES

1. *The time required for normal charge is affected by the amount of power the system is consuming. Use of the fluorescent lamp and frequent disk access diverts power and lengthens the charge time.*
2. *Using quick charge, the power supply microprocessor automatically stops the charge after eight hours regardless of the condition of the battery. Overcharging could cause the battery to explode.*

If any of the following occurs, the battery quick charge process stops.

1. The battery becomes fully charged.
2. The AC adaptor or battery is removed.
3. The battery or output voltage is abnormal.
4. The battery temperature is abnormal.
5. The battery SMBus communication fails.
6. The battery cell is bad.

Detection of full charge

A full charge is detected from the battery pack through SMBus when the battery is charging.

1.7.2 RTC battery

The RTC battery provides power to keep the current date, time and other setup information in memory while the computer is turned off. The table below lists the charging time and data preservation period of the RTC battery. The RTC battery is charged by the adaptor or main battery, while the computer is powered on.

Status	Time
Charging Time (power on)	About 24 hours
Data preservation period (full charge)	1 month

Chapter 2

Troubleshooting Procedures

Chapter 2 Contents

2.1	Troubleshooting Introduction	3
2.2	Troubleshooting Flowchart.....	4
2.3	Power Supply Troubleshooting.....	9
2.4	Display Troubleshooting.....	14
2.5	Keyboard Troubleshooting	17
2.6	External USB Devices Troubleshooting.....	19
2.7	TV-Out Failure Troubleshooting	21
2.8	TouchPad Troubleshooting.....	23
2.9	Speaker Troubleshooting	25
2.10	Optical drive troubleshooting	27
2.11	Modem Troubleshooting	30
2.12	Express card Troubleshooting.....	32
2.13	IEEE 1394 Troubleshooting	34
2.14	Wireless LAN Troubleshooting.....	36
2.15	Camera troubleshooting	38
2.16	Bluetooth Troubleshooting.....	40
2.17	4 in 1 card Troubleshooting.....	42
2.18	HDD Troubleshooting.....	44
2.19	CRT failure Troubleshooting	46
2.20	HDMI Troubleshooting	48
2.21	Robson Troubleshooting	50
2.22	MIC Troubleshooting	52
2.23	Finger Troubleshooting	54

Figures

Figure 2-1	Troubleshooting flowchart (1/2)	5
Figure 2-1	Troubleshooting flowchart (2/2)	6
Figure 2-2	Power Supply Troubleshooting Process	9
Figure 2-3	Display troubleshooting process	14
Figure 2-4	Keyboard troubleshooting process	17
Figure 2-5	External USB device troubleshooting process	19
Figure 2-6	TV-out troubleshooting process	21
Figure 2-7	TouchPad troubleshooting process.....	23
Figure 2-8	Speaker troubleshooting process	25
Figure 2-9	Optical drive troubleshooting process	27
Figure 2-10	Modem troubleshooting process	30
Figure 2-11	Express card troubleshooting process	32
Figure 2-12	IEEE 1394 troubleshooting process	34
Figure 2-13	Wireless LAN troubleshooting process.....	36
Figure 2-14	Camera troubleshooting process	38
Figure 2-15	Bluetooth troubleshooting process.....	40
Figure 2-16	4 in 1 card troubleshooting process.....	42
Figure 2-17	HDD troubleshooting process.....	44
Figure 2-18	CRT failure troubleshooting process	46
Figure 2-19	HDMI Troubleshooting process	48
Figure 2-20	Robson troubleshooting process	50
Figure 2-21	MIC troubleshooting process	52
Figure 2-22	Finger printer troubleshooting process	54

Tables

Table 2-1	Battery LED	10
Table 2-2	DC-IN LED	11

2.1 Troubleshooting Introduction

Chapter 2 describes how to determine if a Field Replaceable Unit (FRU) in the computer is causing the computer to malfunction. The FRUs covered are:

- | | | |
|----------------------------|--------------------------------|------------------------|
| <u>1. Display</u> | <u>7. Speaker</u> | <u>13. Camera</u> |
| <u>2. USB Floppy Drive</u> | <u>8. Optical drive</u> | <u>14. Bluetooth</u> |
| <u>3. Keyboard</u> | <u>9. Modem</u> | <u>15. HDMI</u> |
| <u>4. USB ports</u> | <u>10. Express card unit</u> | <u>16. Robson card</u> |
| <u>5. TV-out port</u> | <u>11. IEEE 1394 port</u> | <u>17. MIC</u> |
| <u>6. TouchPad</u> | <u>12. Wireless LAN system</u> | <u>18. Finger</u> |

The Diagnostics Disk operations are described in Chapter 3. Detailed replacement procedures are given in Chapter 4.

The following tools are necessary for implementing the troubleshooting procedures:

1. Diagnostics Disk (Repair and Sound Repair)
2. Phillips screwdriver (2 mm)
3. 6mm nut driver (for the helix screw nuts on the rear ports for CPU door)
4. 2DD or 2HD formatted work disk for floppy disk drive testing
5. Sycard (EXPRESS CARD test card)
6. Cleaning kit for floppy disk drive troubleshooting
7. Cleaning kit for optical drive troubleshooting
8. Multimeter
9. External monitor
10. USB compatible keyboard
11. Multimedia sound system with line-in and line-out ports
12. Headphones
13. USB test module and USB cable
14. Music CD
15. MIC module and MIC line
16. Robson card
17. Finger print module

2.2 Troubleshooting Flowchart

If you know the location of the malfunction, turn directly to the appropriate section of this chapter. If the problem is unspecified, use the flowchart in Figure 2-1 as a guide for determining which troubleshooting procedures to execute. Before performing any troubleshooting procedures, verify the following:

- Ask the user if a password is registered and, if it is, ask him or her to enter the password.
- Verify with the customer that Toshiba Windows Vista is installed on the hard disk. Operating systems that were not preinstalled by Toshiba can cause the computer to malfunction.
- Make sure all optional equipment is removed from the computer.
- Make sure the floppy disk drive, if installed, is empty. If no FDD module is installed, you should use an external FDD to run the diagnostics tests

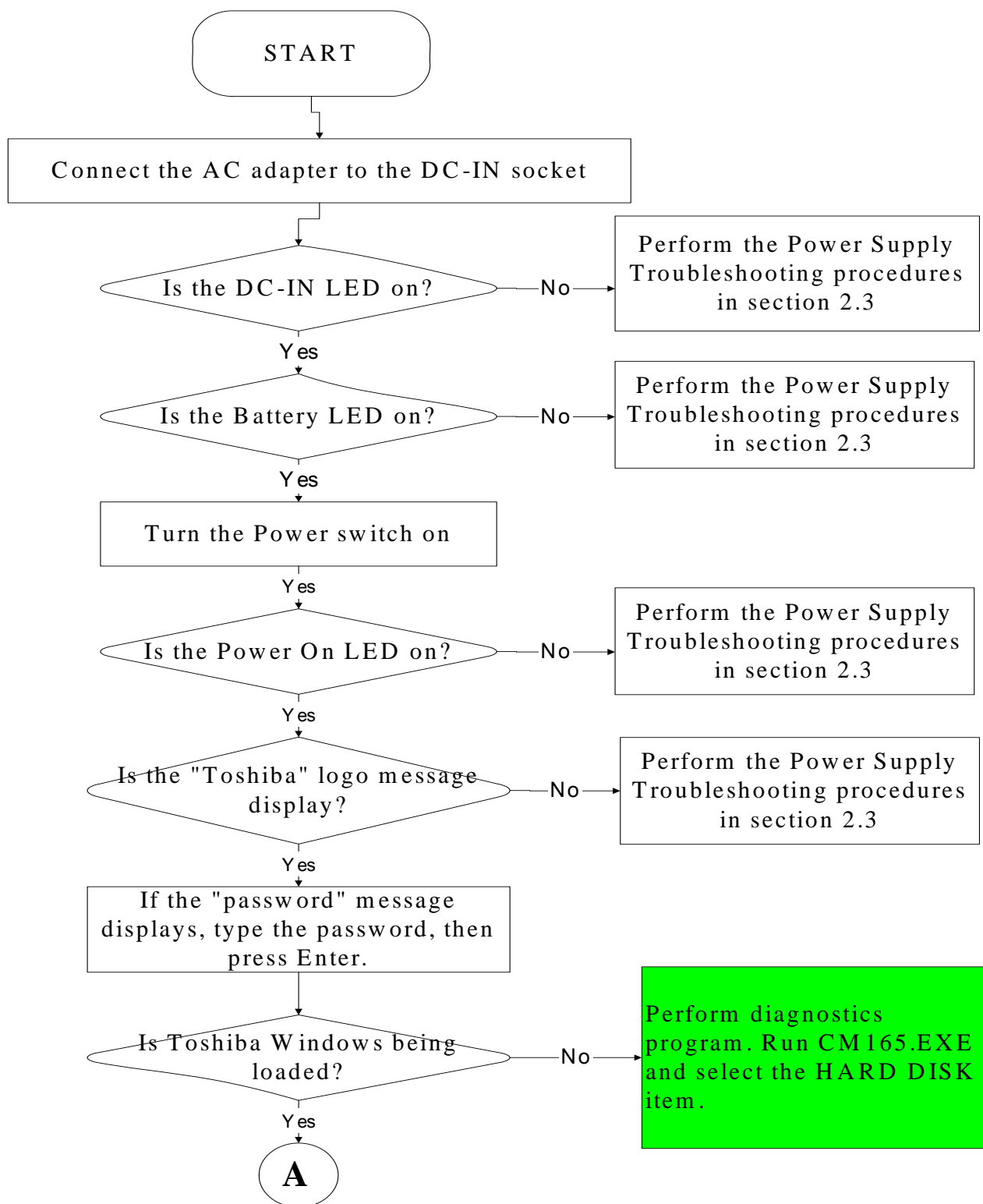

Figure 2-1 Troubleshooting flowchart (1/2)

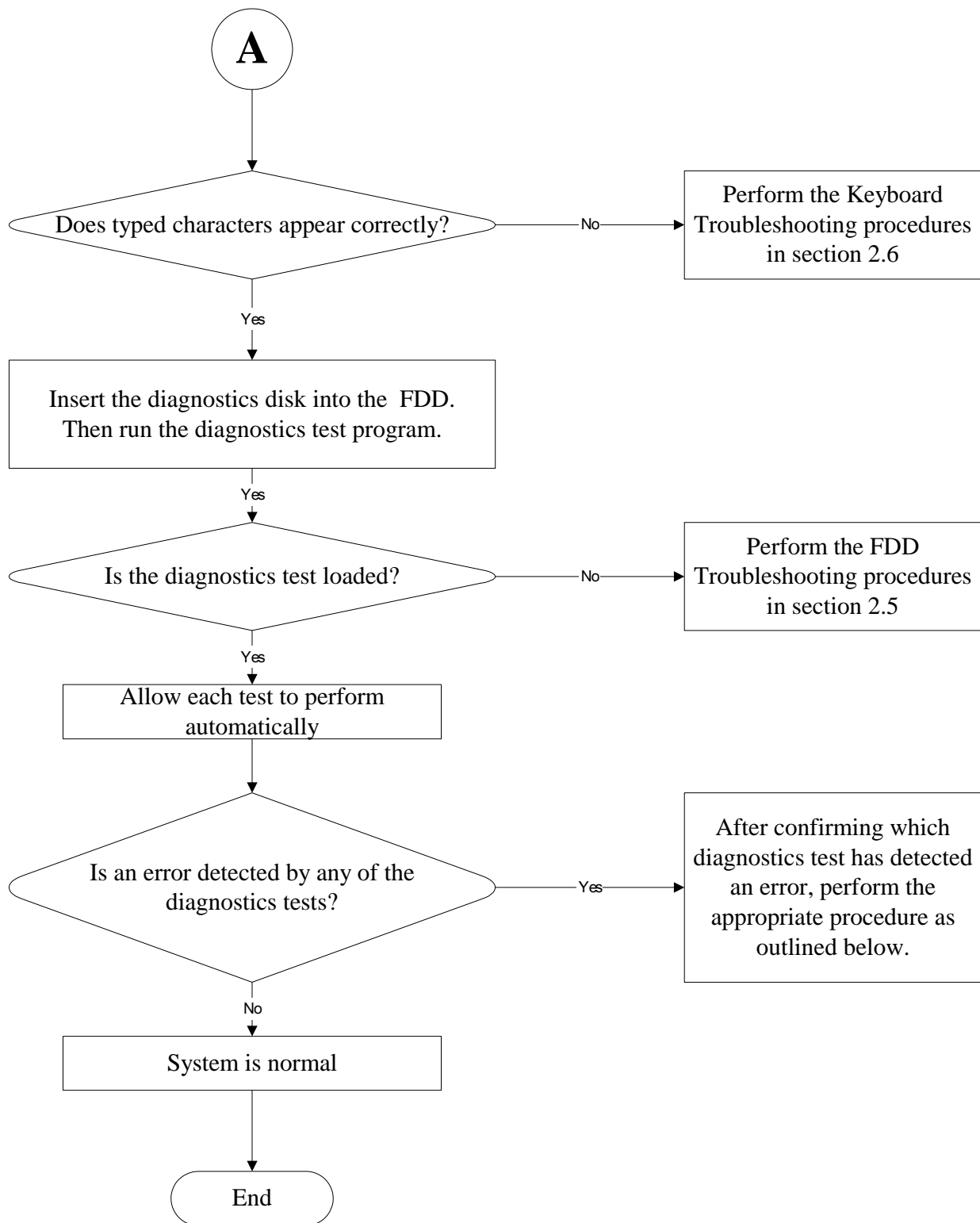

Figure 2-1 Troubleshooting flowchart (2/2)

If the diagnostics program cannot detect an error, the problem may be intermittent. The test program should be executed several times to isolate the problem. When a problem has been located, perform the appropriate troubleshooting procedures as follows:

1. If an error is detected by the battery test, perform the Power Supply Troubleshooting procedures in Section 2.3.
2. If an error is detected by the display test, perform the Display Troubleshooting procedures in Section 2.4.
3. If an error is detected by the keyboard test, perform the Keyboard Troubleshooting procedures in Section 2.5.
4. If an error is detected by the TouchPad test, perform the TouchPad Troubleshooting procedures in Section 2.8.
5. If an error is detected by the audio test, perform the Speaker Troubleshooting procedures in Section 2.9 and the Optical Drive Troubleshooting Procedures in Section 2.10.
6. If an error is detected by the modem test, perform the Modem Troubleshooting Procedures in Section 2.11.

Other problems that are not covered by the diagnostics program may be discovered by a user.

1. If an error is detected when using an external USB device, perform the External USB Devices Troubleshooting procedures in Section 2.6.
2. If an error is detected when using the TV-out connection, perform the TV-Out Failure Troubleshooting procedures in Section 2.7.
3. If an error is detected when using the speakers, perform the Speaker Troubleshooting procedures in Section 2.10.
4. If an error is detected when using the modem, perform the Modem Troubleshooting procedures in Section 2.11.
5. If an error is detected when using the EXPRESS CARD unit, perform the EXPRESS CARD Troubleshooting procedures in Section 2.12.
6. If an error is detected when using the IEEE1394 device, perform the IEEE1394 device Troubleshooting procedures in Section 2.13.
7. If an error is detected when using the Wireless LAN, perform the Wireless LAN Troubleshooting procedures in Section 2.14.

2.3 Power Supply Troubleshooting

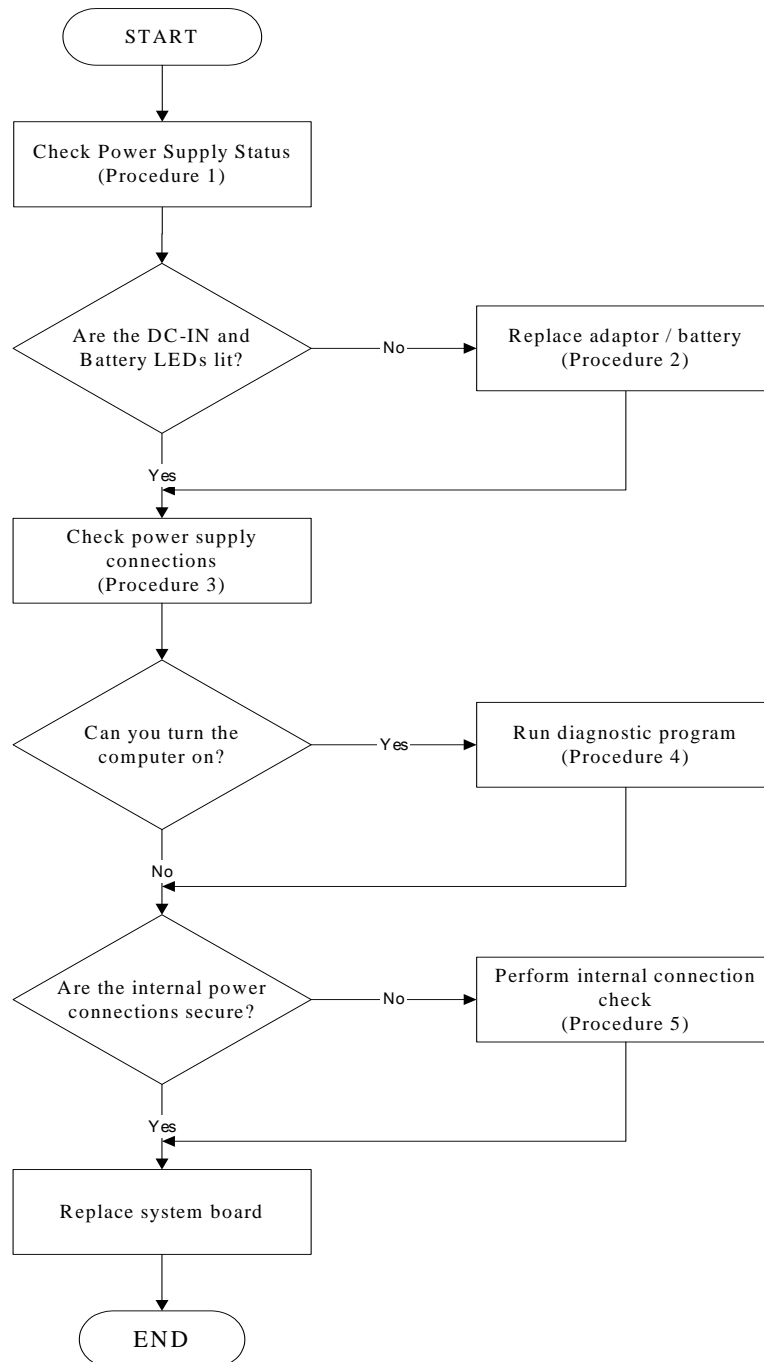

Figure 2-2 Power Supply Troubleshooting Process

The power supply controls many functions and components. To determine if the power supply is functioning properly, start with Procedure 1 and continue with the other Procedures as instructed. The flowchart in Figure 2-2 gives a summary of the process. The procedures described in this section are:

- Procedure 1: Power status check
- Procedure 2: Adaptor / battery replacement
- Procedure 3: Power supply connection check
- Procedure 4: Diagnostic check
- Procedure 5: Internal connection check

Procedure 1 Power Status Check

The following LEDs indicate the power supply status:

 Battery LED

 DC-IN LED

The power supply controller displays the power supply status through the Battery and the DC-IN LEDs as listed in the tables below.

Table 2-1 Battery LED

Battery State	LED colors	Definition
Charging	Amber, solid on	Battery charging with AC.
	Blue, solid on	Battery fully charged by AC
	Blue color off	Battery abnormal stop charging with AC (Bad cell/ Overheated)
Discharging	Amber, blinking (LED on for 1 second every 4 seconds)	Battery within low state: 12 minutes remaining
	Amber, blinking (LED on for 1 second every 2 seconds)	Battery within critical low state: 3 minutes remaining. The system is protected and cannot be re-powered on without the AC power connected.
	Amber color off	Battery not in low or critical low state; It's in discharging state

Table 2-2 DC-IN LED

AC-IN LED	Power supply status
Solid on	AC power exists (LED is solid Blue).
Off	No AC power exists.

To check the power supply status, install a battery pack and connect an AC adaptor to the DC-IN port on the computer and to a power supply.

If the DC-IN LED or Battery LED is not lit, go to Procedure 2.

Procedure 2 Adaptor / battery replacement

A faulty adaptor may not supply power or may not charge the battery. Perform Check 1.

Check 1 Connect a new AC adaptor. If the problem is not resolved, go to Check 2.

Check 2 Insert a new battery. If the problem is still not resolved, go to Procedure 3.

Procedure 3 Power supply connection check

The power supply wiring diagram is shown below:

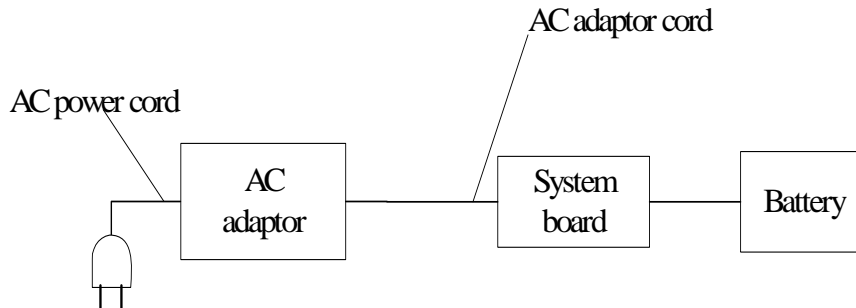

Any of the connectors may be disconnected. Perform Check 1.

- Check 1 Disconnect the AC power cord from wall outlet. Check the power cable for breaks. If the power cord is damaged, connect a new AC power cord. If there is no damage, go to Check 2.
- Check 2 Make sure the AC adaptor cord and AC power cord are firmly plugged into the DC-IN socket, AC adaptor inlet and wall outlet. If these cables are connected correctly, go to Check 3.
- Check 3 Make sure that the DC-IN input port socket is firmly secured to the system board of the computer.
- If the DC-IN input socket is loose, go to Procedure 5.
 - If it is not loose, go to Check 4.
- Check 4 Use a multi-meter to make sure that the AC adaptor output voltage is close to 19 V. If the output is several percent lower than 19 V, go to Check 5. If the output is close to 19 V, go to Check 6.
- Check 5 Connect a new AC adaptor or AC power cord.
- If the DC-IN LED does not light, go to Procedure 4.
 - If the battery LED does not light, go to Check 6.
- Check 6 Make sure the battery pack is installed in the computer correctly. If the battery is properly installed and the battery LED still does not light, go to Procedure 4.

Procedure 4 Diagnostic check

The power supply may not charge the battery pack. Perform the following procedures:

1. Reinstall the battery pack.
2. Attach the AC adaptor and turn on the power. If you cannot turn on the power, go to Procedure 5.
3. Run the Diagnostic test following the procedures described in Chapter 3, Tests and Diagnostics. If no problem is detected, the battery is functioning normally.

Procedure 5 Replacement check

The system board may be disconnected or damaged. Disassemble the computer following the steps described in Chapter 4, *Replacement Procedures*. Check the connection between the AC adaptor and the system board. After checking the connection, perform Check 1:

- Check 1 Use a multi-meter to make sure that the fuses on the system board are not blown. If a fuse is not blown, go to Check 2. If a fuse is blown, go to Check 3.
- Check 2 Make sure that the battery cable is firmly connected to the system board. If it is connected firmly, go to Check 3.
- Check 3 The system board may be damaged. Replace it with a new one following the instructions in Chapter 4.

2.4 Display Troubleshooting

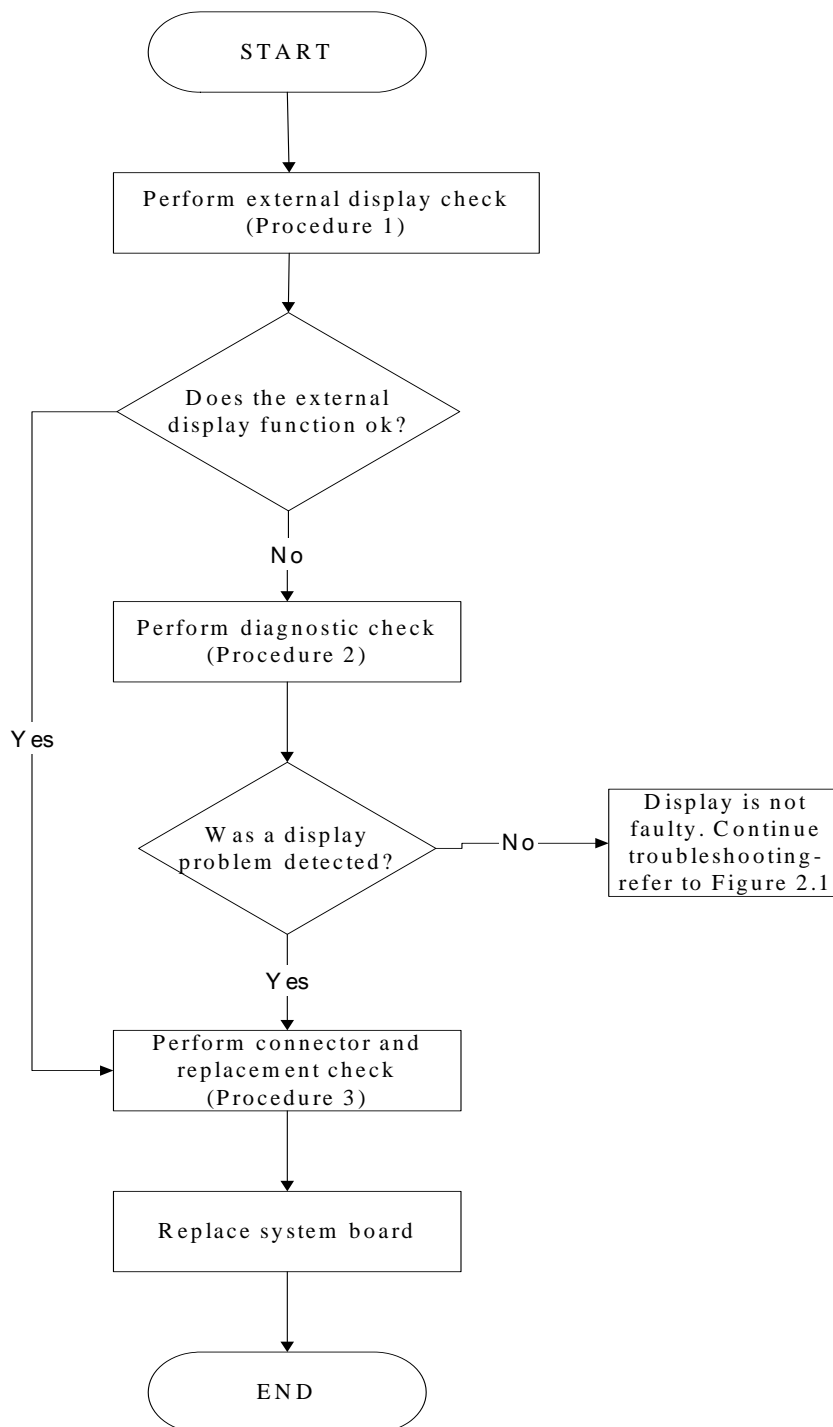

Figure 2-3 Display troubleshooting process

This section describes how to determine if the computer's display is functioning properly. The process is outlined in Figure 2-3. Start with Procedure 1 and continue with the other procedures as instructed.

Procedure 1: External display check

Procedure 2: Diagnostic check

Procedure 3: Connector and replacement check

Procedure 1 External display check

Connect an external display to the computer's external monitor port, and then boot the computer. The computer automatically detects the external display.

If the external display works correctly, the internal LCD may be damaged. Go to Procedure 3.

If the external monitor appears to have the same problem as the internal monitor, the system board may be damaged. Go to Procedure 2.

Procedure 2 Diagnostic check

The Display Test program is stored on the computer's Diagnostics disk. This program checks the display controller on the system board. Insert the Diagnostics disk in the computer's floppy disk drive, turn on the computer and run the test. Refer to Chapter 3, *Tests and Diagnostics* for details.

If an error is detected, go to Procedure 3. If an error is not detected, the display is functioning properly.

Procedure 3 Connector and replacement check

The FL inverter board, LCD module, and system board are connected to the display circuits. Any of these components may be damaged. Refer to Chapter 4, *Replacement Procedures*, for instructions on how to disassemble the computer and then perform the following checks:

- Check 1 Make sure the DDR RAM module is seated properly. Test display again. If the problem still exists, replace the DDR RAM module. If the problem still exists, perform Check 2.
- Check 2 Replace the FL inverter board with a new one and test display again. If the problem still exists, perform Check 3.
- Check 3 Replace the LCD module with a new one and test display again. If the problem still exists, perform Check 4.
- Check 4 Replace the LCD/FL cable with a new one and test display again. If the problem still exists, perform Check 5.
- Check 5 Replace the CPU with another of the same specifications. If the problem still exists, perform Check 6.
- Check 6 The system board may be damaged. Replace it with a new one.

2.5 Keyboard Troubleshooting

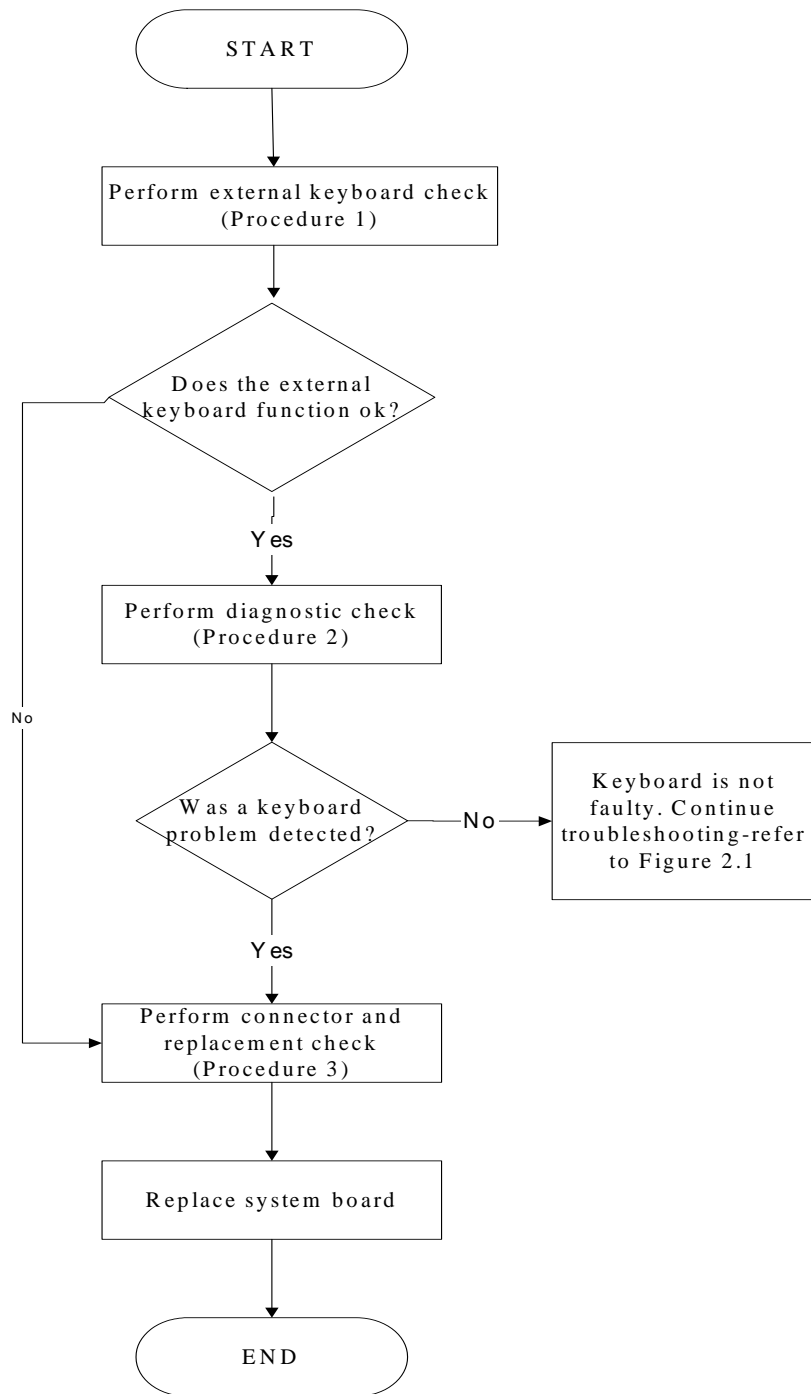

Figure 2-4 Keyboard troubleshooting process

To determine if the computer's keyboard is functioning properly, perform the following procedures. Figure 2-5 outlines the process. Start with Procedure 1 and continue with the other procedures as instructed.

Procedure 1: External keyboard check

Procedure 2: Diagnostic check

Procedure 3: Connector and replacement check

Procedure 1 External keyboard check

Connect a USB keyboard to one of the computer's USB ports, and then boot the computer. The computer automatically detects the external keyboard.

If the external keyboard works correctly, the internal keyboard or its connections may be faulty. Go to Procedure 2.

If the external keyboard appears to have the same problem as the internal keyboard, the system board may be having some problem. Replace it with a new one and following the instructions in Chapter 4.

Procedure 2 Diagnostic check

Run the test and Diagnostics Program, which will automatically execute the Keyboard Test. Refer to Chapter 3, *Tests and Diagnostics* for more information on how to run the program.

If an error is located, go to Procedure 3. If an error does not occur, the keyboard is functioning ok.

Procedure 3 Connector and replacement check

The keyboard and/or system board may be disconnected or damaged. Disassemble the computer following the steps described in Chapter 4, *Replacement Procedures* and perform the following checks.

Check 1 Make sure the keyboard cable is firmly connected to the system board.

If the connection is loose, reconnect firmly and repeat Procedure 2. If there is still an error, go to Check 2.

Check 2 The keyboard may be damaged. Replace it with a new one following the instructions in Chapter 4.

If the problem still exists, perform Check 3.

Check 3 The system board may be damaged. Replace it with a new one following the instructions in Chapter 4.

2.6 External USB Devices Troubleshooting

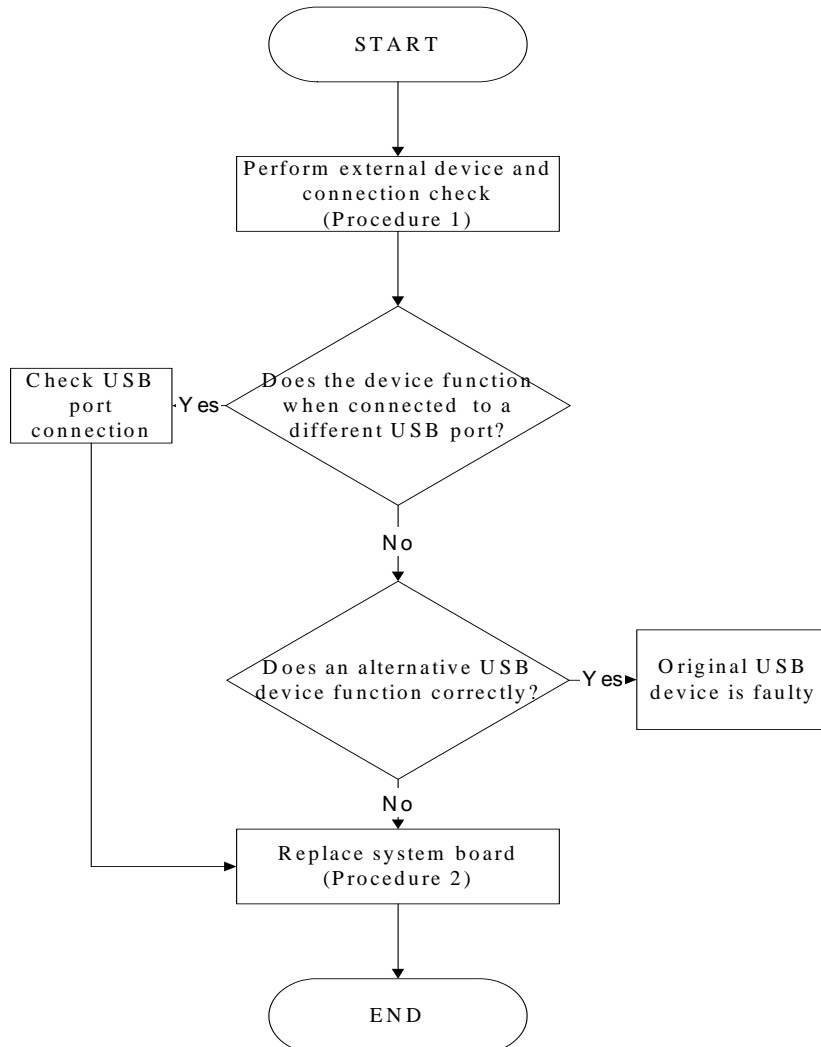

Figure 2-5 External USB device troubleshooting process

To determine if the computer's external USB devices are functioning properly, perform the following procedures. Figure 2-6 outlines the process. Start with Procedure 1 and continue as instructed.

Procedure 1: External device and connection check

Procedure 2: Replace system board

Procedure 1 External device and connection check

The USB device may be damaged or the connection may be faulty. Perform Check 1.

Check 1 Make sure USB device cable is firmly plugged into one of the USB sockets. If the cable is connected correctly, go to Check 2.

Check 2 Plug the USB device into another USB socket (there are three in all). If the USB device still does not work, go to Check 4.

If the device functions correctly when connected to another USB port, go to Check 3.

Check 3 Make sure that the USB socket is firmly secured to the system board of the computer. If the malfunction remains, the system board may be damaged. Go to Procedure 2.

Check 4 Connect an alternative USB device to one of the computer's USB ports, and then boot the computer. The computer automatically detects the external device.

If the alternative USB device works correctly, the original device may be damaged and should be replaced.

If the alternative USB device appears to have the same problem as the original device, the system board may be damaged. Go to Procedure 2.

Procedure 2 Replace system board

If the error persists, the system board may be damaged. Replace it with a new one following the instructions in Chapter 4.

2.7 TV-Out Failure Troubleshooting

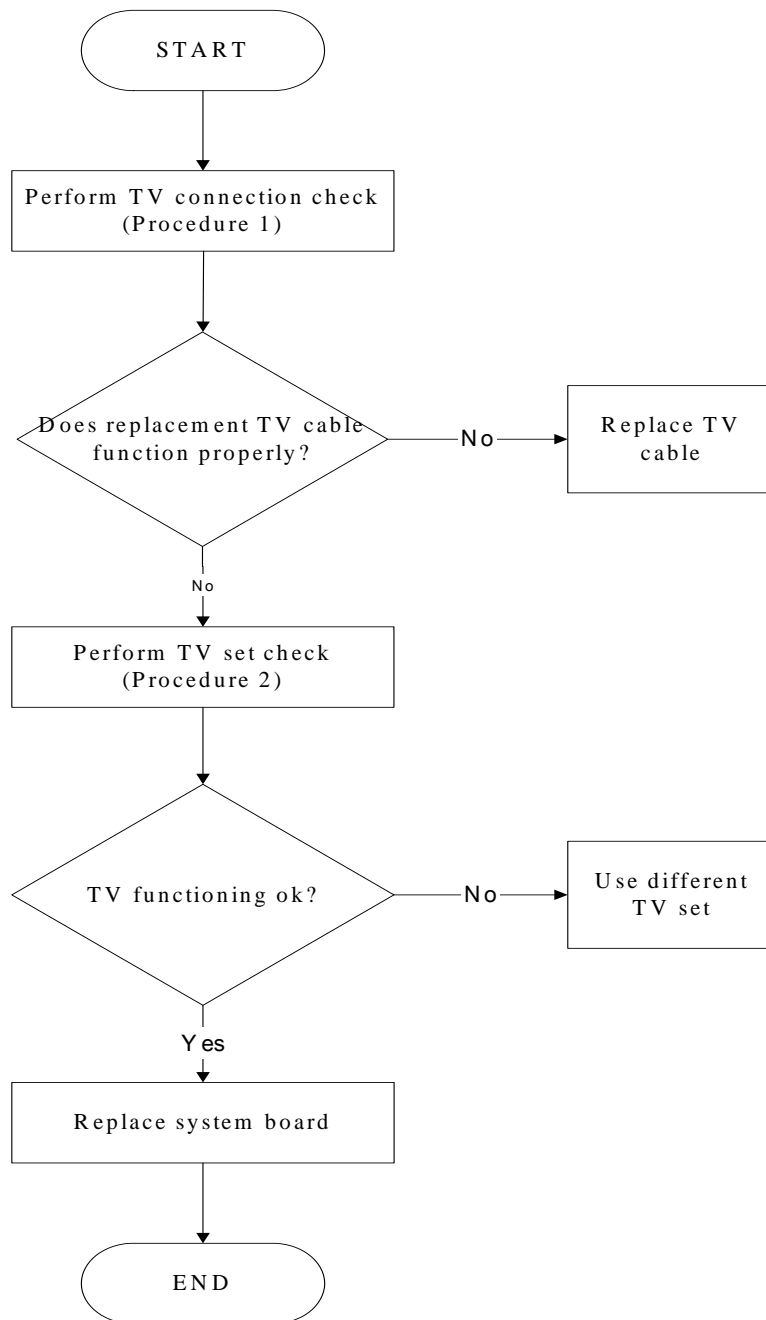

Figure 2-6 TV-out troubleshooting process

To determine if the computer's TV-out port is functioning properly, perform the following procedures. Figure 2-7 outlines the process. Start with Procedure 1 and continue as instructed.

Procedure 1: TV connection check

Procedure 2: TV set check

Procedure 1 TV connection check

The TV cable may be damaged or the connections may be loose. Perform Check 1:

- Check 1 Make sure TV cable is firmly plugged into both the TV set and the TV-out port of the computer. If the cable is connected correctly, go to Check 2.
- Check 2 Make sure the TV-out port is firmly secured to the system board of the computer. If the malfunction remains, go to Check 3.
- Check 3 The TV cable may be damaged. Replace with a good cable. If the malfunction remains, go to Procedure 2.

Procedure 2 TV set check

The TV set may be faulty. Perform Check 1:

- Check 1 Try using the set for television reception. If it does not work, the set may be damaged. If the set does work, perform Check 2.
- Check 2 Try connecting a different television to the computer. If the replacement television works, the original set may be damaged. If the replacement set does not work the system board may be damaged. Replace it with a new one following the instructions in Chapter 4.

2.8 TouchPad Troubleshooting

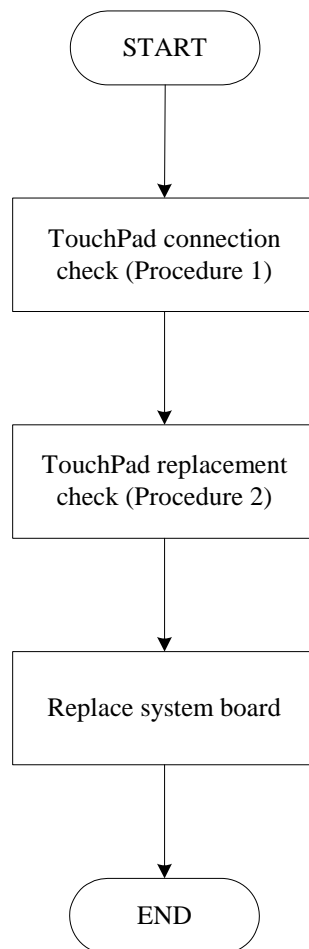

Figure 2-7 Touchpad troubleshooting process

To determine if the computer's built-in TouchPad is functioning properly, perform the following procedures. Figure 2-9 outlines the process. Start with Procedure 1 and continue as instructed.

Procedure 1: TouchPad connection check

Procedure 2: TouchPad replacement check

Procedure 1 TouchPad connection check

The TouchPad is connected via the TouchPad FPC to the system board. Make sure the TouchPad FPC cable is firmly connected to the TouchPad and system board. Refer to Chapter 4, *Replacement Procedures*, for instructions on how to disassemble the computer and then perform the following checks.

If any of the connections are loose, reconnect firmly. If any of the connections is damaged, or there is still an error, go to Procedure 2.

Procedure 2 TouchPad replacement check

The TouchPad unit or FPC may be defective or damaged. Replace each with a new one following the steps in Chapter 4. If the FDD is still not functioning properly, replace the system board with a new one following the steps in Chapter 4.

2.9 Speaker Troubleshooting

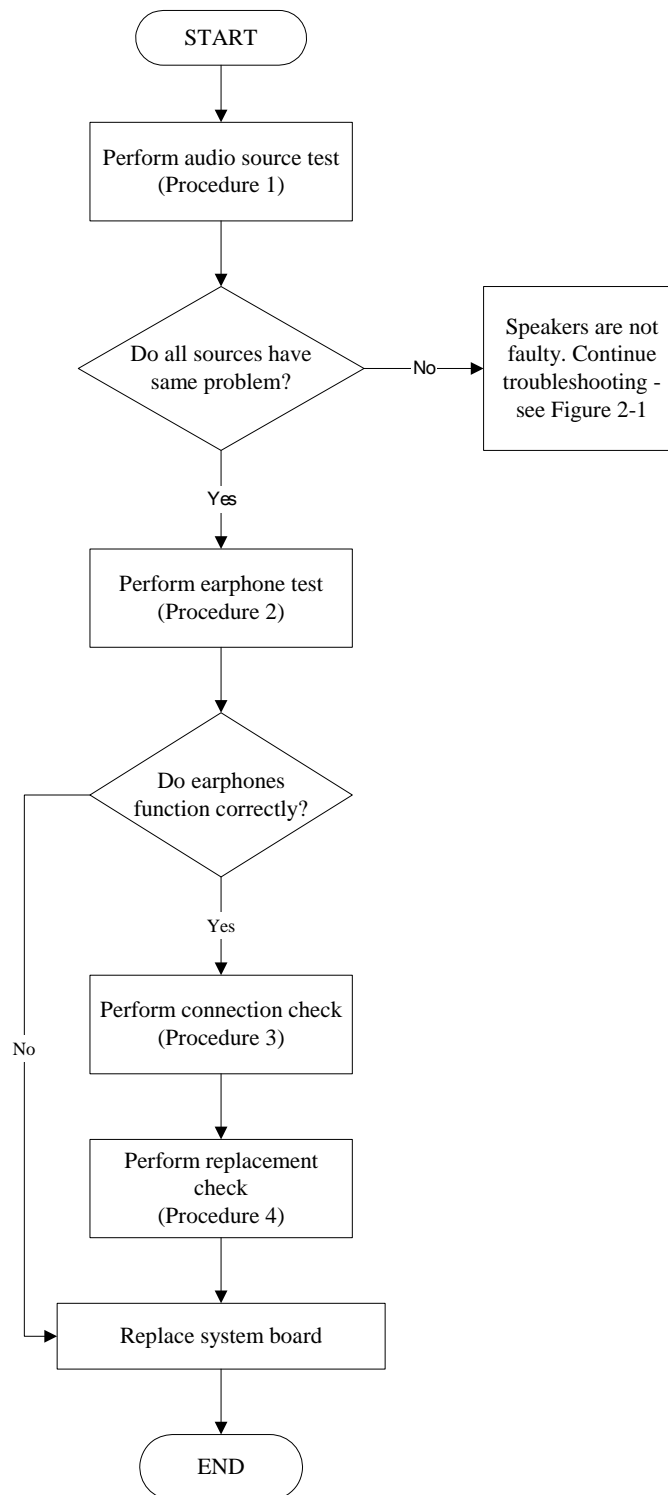

Figure 2-8 Speaker troubleshooting process

To determine if the computer's built-in speakers are functioning properly, perform the following procedures. Figure 2-10 outlines the process. First adjust the speaker volume to an appropriate level. Start with Procedure 1 and continue as instructed.

Procedure 1: Audio source test

Procedure 2: Earphone test

Procedure 3: Connection check

Procedure 4: Replacement check

Procedure 1 Audio source test

Try different audio sources (e.g. an audio CD and digital music file) to determine whether the fault is in the speaker system or not. If not all sources have sound problem, the problem is in the source devices. If all have the same problem, continue with Procedure 2.

Procedure 2 Earphone test

Connect a set of earphones or external speakers. If these function correctly, go to Procedure 3. If they do not function correctly, the system board may be defective or damaged. Replace it with a new one.

Procedure 3 Connection check

Disassemble the computer following the steps described in Chapter 4, *Replacement Procedures* and make sure the speaker cable is firmly connected to the audio board. If the stereo speakers are still not functioning properly, go to Procedure 4.

Procedure 4 Replacement check

If the stereo speakers don't sound properly, the stereo speakers may be defective or damaged. Replace them with new ones. If the stereo speakers still do not work properly, try replacing in turn the audio board and system board.

2.10 Optical Drive Troubleshooting

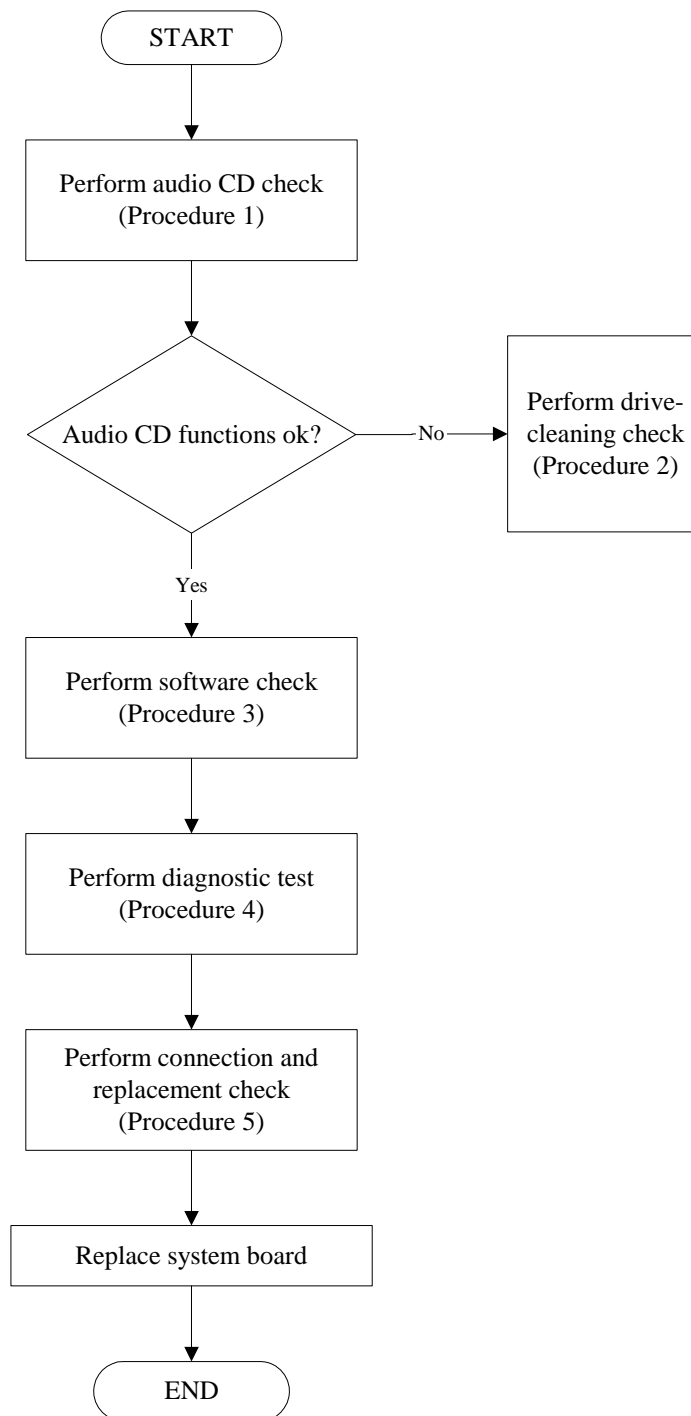

Figure 2-9 Optical drive troubleshooting process

This section describes how to determine if the computer's internal optical drive is functioning properly. The Satellite X200 / X205 / Satellite Pro X200 / EQUIUM X200 / SATEGO X200 Series Maintenance Manual module bays can accommodate the following optical drives:

DVD SuperMulti supporting +-R Double Rayer

Figure 2-11 outlines the process. Perform the steps below starting with Procedure 1 and continue with the other procedures as required.

Procedure 1: Audio CD test

Procedure 2: Drive cleaning check

Procedure 3: Software check

Procedure 4: Diagnostic test

Procedure 5: Connection and replacement check

Procedure 1 Audio CD check

First, insert an audio CD into the CD/DVD drive. If it works, the problem is not with the drive. Go to Procedure 3. If the audio CD does not work, go to Procedure 2. If the CD/DVD LED on the front panel does not light when the disc is played and the drive gives no response, go straight to Procedure 3.

Procedure 2 Drive cleaning check

Insert a CD/DVD drive-cleaning disk into the drive clean according to the drive-cleaning product instructions. If the problem persists, go to Procedure 3.

Procedure 3 Software check

Ensure that the appropriate driver has been installed on the computer for the CD/DVD drive.

Procedure 4 Diagnostic test

The audio test program stored in the Diagnostics Disk will test the drive's ability to play an audio CD. See Chapter 3 for details.

If any errors occur while executing the diagnostic program, go to Procedure 5.

Procedure 5 Connection check and replacement check

The optical drive connects to the system board. The drive may be disconnected, or the drive or system board may be damaged. Disassemble the computer following the steps described in Chapter 4, *Replacement Procedures*, and perform the following checks:

- Check 1 Make sure the drive is firmly connected to the system board. If the connection is good and there is still an error, go to Check 2.
- Check 2 The drive or drive cable may be defective or damaged. Replace each with a new one following the steps in Chapter 4, *Replacement Procedures*. If the drive is still not functioning properly, perform Check 3.
- Check 3 The system board may be damaged. Replace it with new one following the instructions in Chapter 4, *Replacement Procedures*.

2.11 Modem Troubleshooting

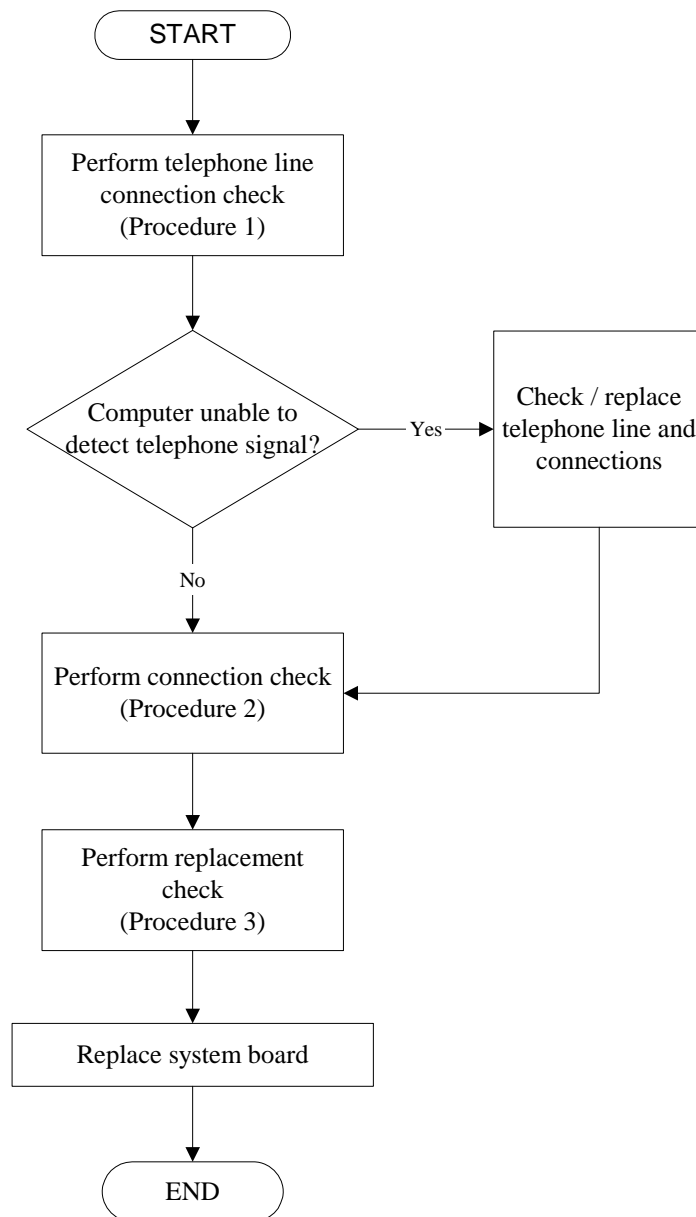

Figure 2-10 Modem troubleshooting process

This section describes how to determine if the computer's modem is functioning properly. Figure 2-12 outlines the process. Perform the steps below starting with Procedure 1 and continuing with the other procedures as required.

Procedure 1: Telephone line connection check

Procedure 2: Modem card connection check

Procedure 3: Modem card replacement check

Procedure 1 Telephone line connection check

The telephone cable may be damaged or the connections may be loose. Attempt to connect the computer to a network through using the modem. If the modem does not function at all, go to Procedure 3. If the attempt fails because the computer detects no telephone signal, the fault may be in the telephone cable, the wall socket or the modem port. Perform Check 1:

Check 1 Make sure telephone cable is firmly plugged into both the telephone wall socket and the modem port of the computer. If the cable is connected correctly, go to Check 2.

Check 2 Make sure the modem port is firmly secured to the system board of the computer. If the malfunction remains, go to Check 3.

Check 3 The telephone cable may be damaged. Replace with a good cable. If the malfunction remains, go to Procedure 2.

Procedure 2 Modem card connection check

Disassemble the computer following the steps described in Chapter 4, *Replacement Procedures* and ensure that the modem card is well connected to the system board. If the problem persists, perform Procedure 3.

Procedure 3 Modem replacement check

The modem card or RJ-11 jack may be faulty. Try replacing them. If the problem persists, the system board may be defective or damaged. Replace the System Board with a new one following the steps in Chapter 4, *Replacement Procedures*.

2.12 Express card Troubleshooting

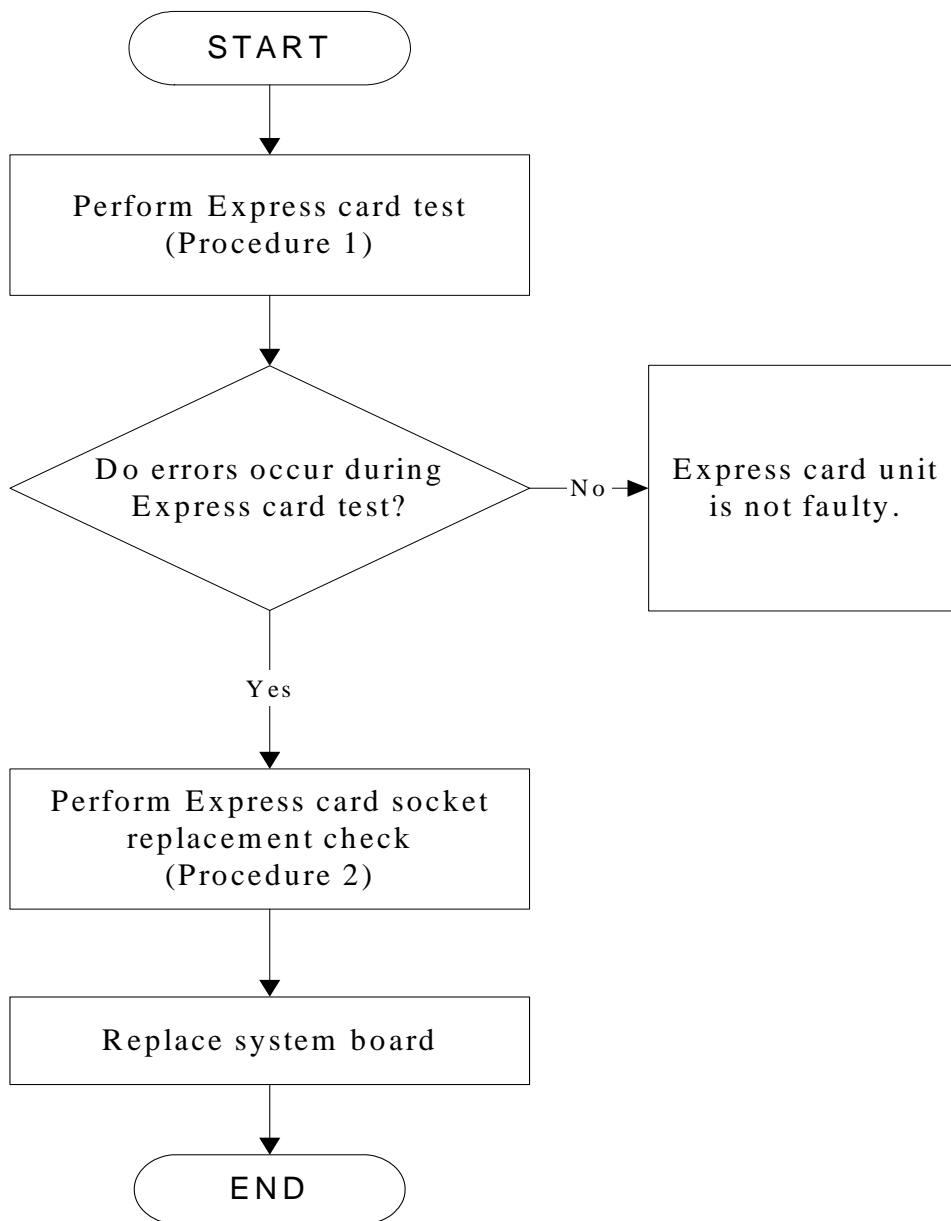

Figure 2-11 Express card troubleshooting process

This section describes how to determine if the Express card player is functioning properly. The process is summarized in Figure 2-13. Perform the steps below starting with Procedure 1 and continuing with the other procedures as required.

Procedure 1: Express card test

Procedure 2: Express card socket replacement check

Procedure 1 Express card test

The Express test card contains a Express test program. Ensure the card is fully inserted into the socket before running the program.

If an error occurs during the Express card test, perform Procedure 2. If no error occurs, it is likely that the original PC card was faulty.

Procedure 2 Express card socket replacement check

The Express card socket may be damaged or defective, for instance the socket pins can be bent. Disassemble the computer following the steps described in Chapter 4, Replacement Procedures and replace the socket. If the problem persists, the system board may be defective or damaged. Replace the system board with a new one following the steps in Chapter 4.

2.13 IEEE 1394 Troubleshooting

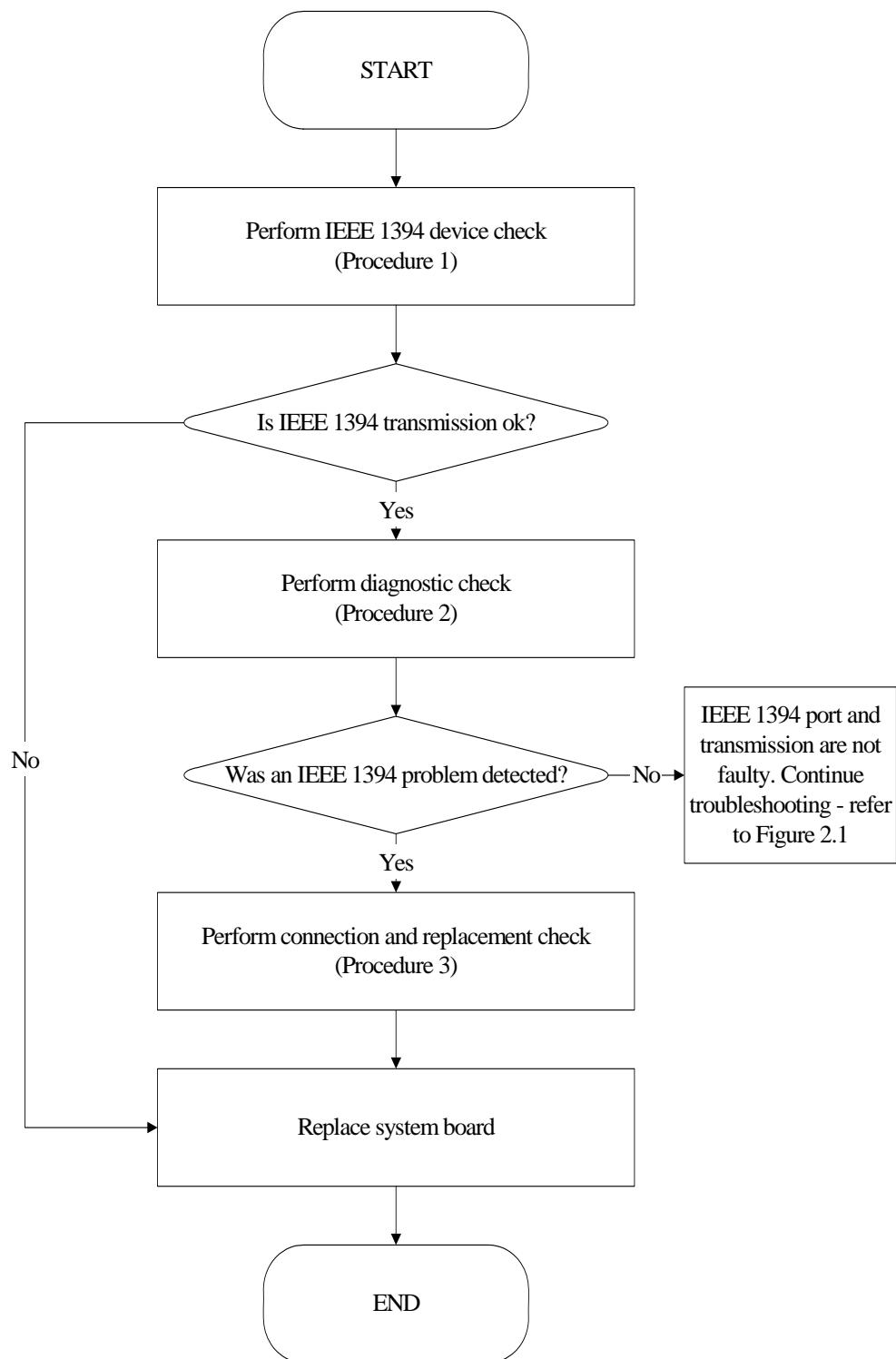

Figure 2-12 IEEE 1394 troubleshooting process

To determine if the computer's IEEE 1394 system is functioning properly, perform the following procedures. Figure 2-14 outlines the process. Start with Procedure 1 and continue with the other procedures as instructed.

Procedure 1: IEEE 1394 device check

Procedure 2: Diagnostic check

Procedure 3: Connection and replacement check

Procedure 1 IEEE 1394 device check

Connect an IEEE 1394 device to the computer's IEEE 1394 port, then boot the computer for Windows Vista. The computer should automatically detect the 1394 device. Check whether the device can transmit data to the computer.

If the device is able to communicate with the computer, the problem may be intermittent or connections may be faulty. Go to Procedure 2.

If communication is impaired, there may be a faulty connection. Go to Procedure 3.

Procedure 2 Diagnostic check

Run the Diagnostic Program, which will automatically execute the IEEE 1394 port test for transmission. Refer to Chapter 3, Tests and Diagnostics for more information on how to run the program.

If an error is located, go to Procedure 3. If an error does not occur, the 1394 port is functioning properly.

Procedure 3 Connection and replacement check

The transmission cable may be damaged or the connections may be loose. Perform Check 1:

Check 1 Make sure the transmission cable is firmly plugged into both the IEEE 1394-compatible device and the IEEE 1394 port of the computer. If the cable is connected correctly, go to Check 2.

Check 2 Make sure the IEEE 1394 port is firmly secured to the system board of the computer. If the malfunction persists, go to Check 3.

Check 3 The transmission cable may be damaged. Replace with a good cable. If the malfunction persists, go to Check 4

Check 4 The system board may be damaged. Replace it with a new one following the instructions in Chapter 4.

2.14 Wireless LAN Troubleshooting

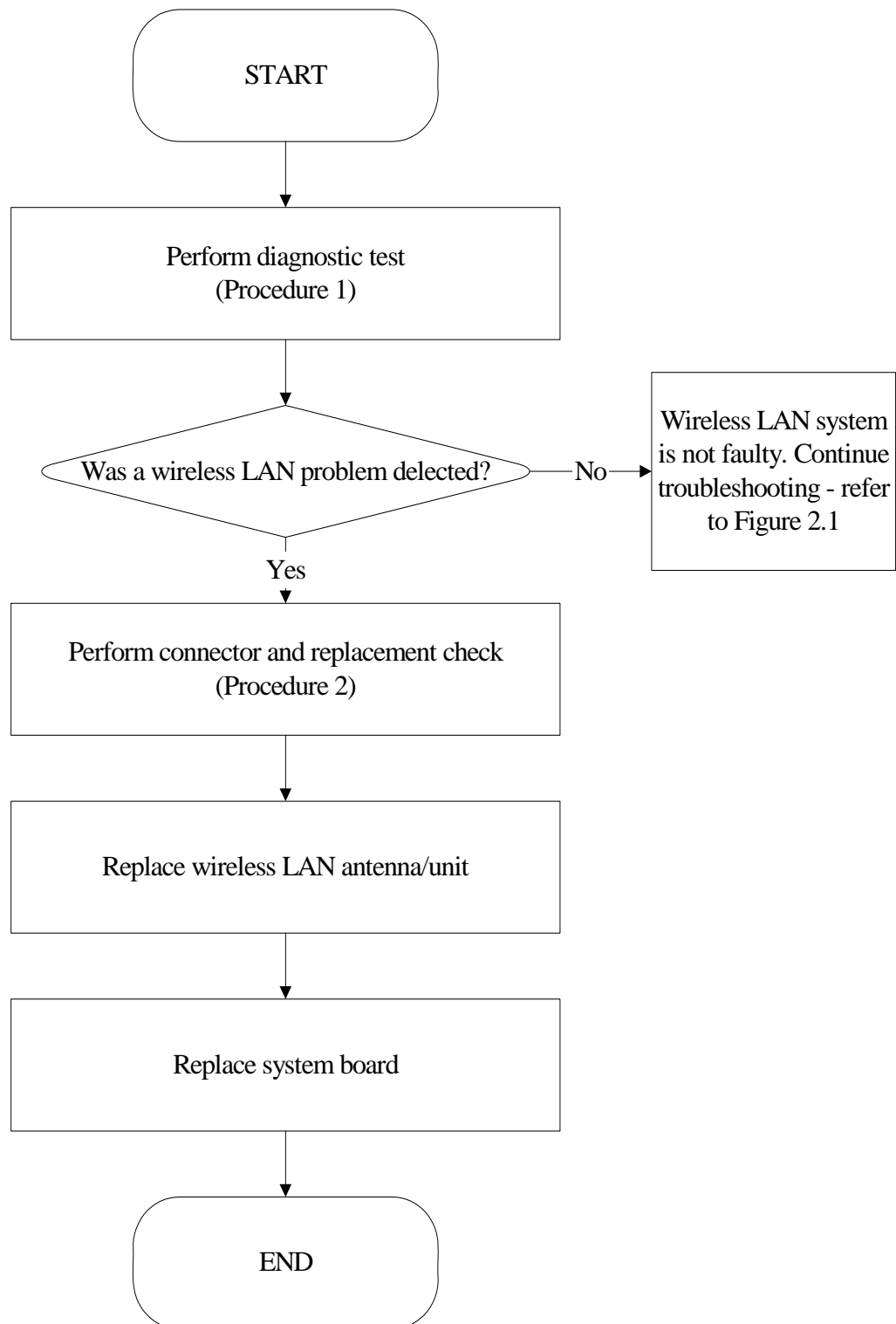

Figure 2-13 Wireless LAN troubleshooting process

The wireless LAN antenna wire, wireless LAN unit or system board may each be the source of a wireless LAN fault. Any of these components may be damaged. To determine if the

computer's wireless LAN system is functioning properly, perform the following procedures.

Figure 2-15 outlines the process. Start with Procedure 1 and continue with the other procedures as instructed.

Procedure 1: Diagnostic test

Procedure 2: Connector and replacement check

Procedure 1 Diagnostic test

Run the Diagnostic Program, which will automatically execute the wireless LAN test. Refer to Chapter 3, Tests and Diagnostics for more information on the program.

If an error is located, go to Procedure 2. If an error is not located, the wireless LAN system is functioning properly.

Procedure 2 Connector and replacement check

The wireless LAN antenna, wireless LAN unit or system board may be disconnected or damaged. Disassemble the computer following the steps described in Chapter 4, *Replacement Procedures*, and perform the following checks.

- Check 1 Make sure that the wireless LAN antenna is firmly connected to the wireless LAN unit (refer to Chapter 4 for instructions) and that the wireless LAN unit is securely slotted into the system board. If the problem persists, go to Check 2.
- Check 2 Check that the wireless communication switch is turned to "On", and then make sure that the wireless communication LED on the front panel is lit. If the LED is lit but the wireless LAN function is still faulty, the antenna may be damaged. Replace with a new antenna following the steps in Chapter 4, *Replacement Procedures*. If the problem persists, or if the wireless LAN LED is not lit when the wireless communication switch is turned to "On", go to Check 3.
- Check 3 The wireless LAN unit may be damaged. Replace it with a new one following the instructions in Chapter 4. If the problem still exists, perform Check 4.
- Check 4 The system board may be damaged. Replace it with a new one following the instructions in Chapter 4.

2.15 Camera Troubleshooting

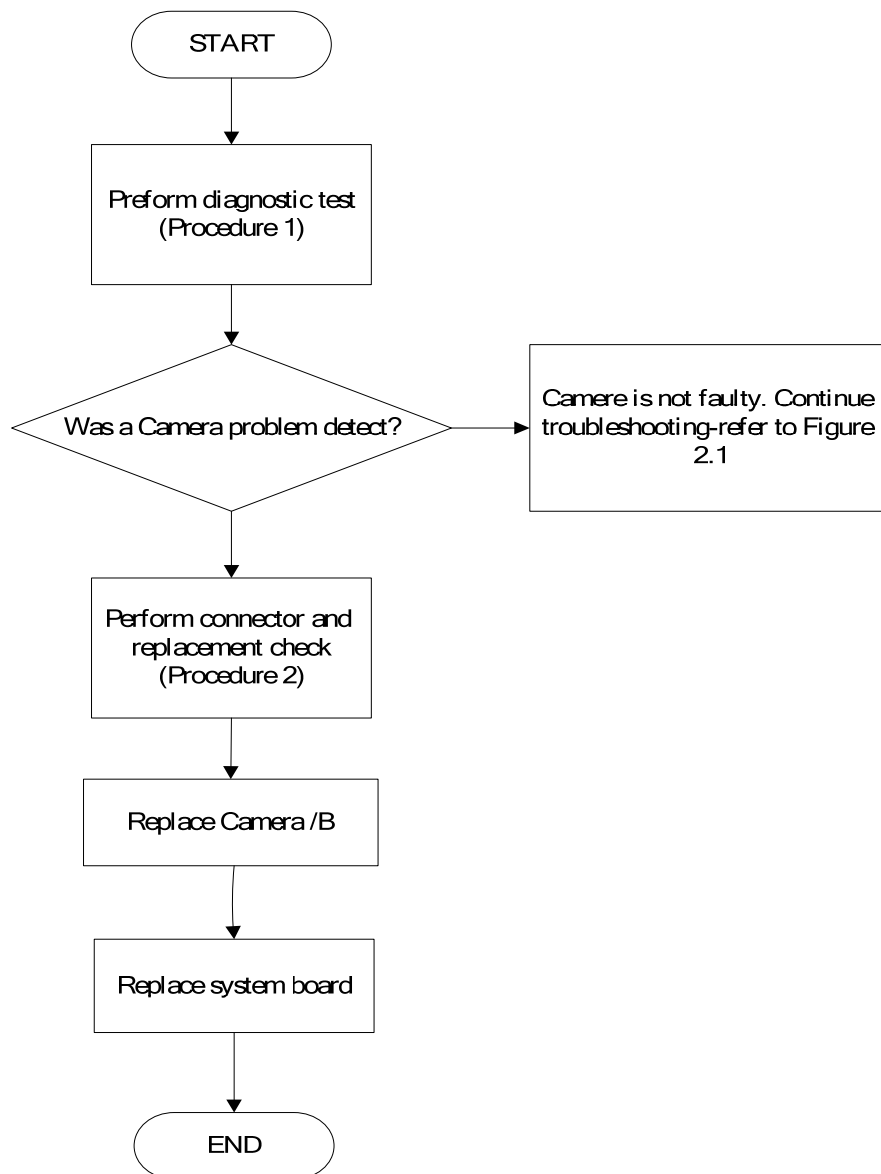

Figure 2-14 Camera troubleshooting process

The Camera board or system board may be the reason of a Camera fault. Either of these two components may be damaged. To determine if the computer's Camera is functioning

properly, perform the following procedures. Figure 2-14 outlines the process. Start with Procedure 1 and continue with the other procedures as instructed.

Procedure 1: Diagnostic test

Procedure 2: Connector and replacement check

Procedure 1 Diagnostic test

Run the functioning Program in windows, which will display the Camera test result.

If tests and diagnostics result abnormal go to Procedure 2. If an error is not located, the Camera system is functioning properly.

Procedure 2 Connector and replacement check

The Camera board or system board may be disconnected or damaged. Disassemble the computer following the steps described in Chapter 4, *Replacement Procedures*, and perform the following checks.

- Check 1 Make sure that the Camera board FFC is securely slotted into the system board. If the problem persists, go to Check 2.
- Check 2 The Camera board may be damaged. Replace it with a new one following the instructions in Chapter 4. If the problem still exists, perform Check 3.
- Check 3 The system board may be damaged. Replace it with a new one following the instructions in Chapter 4.

2.16 Bluetooth Troubleshooting

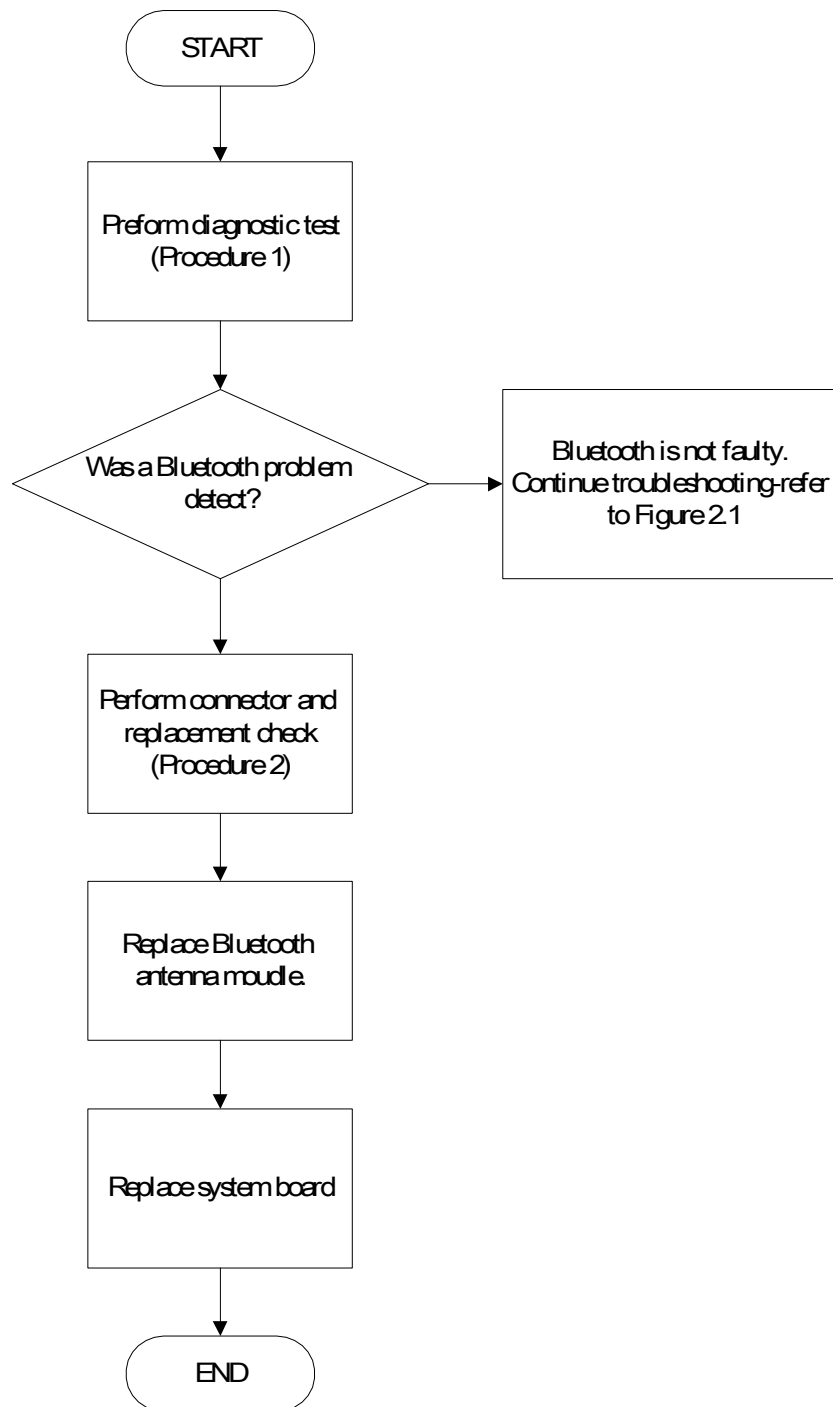

Figure 2-15 Bluetooth troubleshooting process

The Bluetooth antenna wire, Bluetooth module or system board may be the reason of a Bluetooth fault. Any of these components may be damaged. To determine if the computer's Bluetooth is functioning properly, perform the following procedures. Figure 2-16 outlines the process. Start with Procedure 1 and continue with the other procedures as instructed.

Procedure 1: Diagnostic test

Procedure 2: Connector and replacement check

Procedure 1 Diagnostic test

Run the Diagnostic Program, which will automatically execute the Bluetooth test. Refer to Chapter 3, Tests and Diagnostics for more information on the program.

If an error is located, go to Procedure 2. If an error is not located, the Bluetooth system is functioning properly.

Procedure 2 Connector and replacement check

The Bluetooth, antenna module or system board may be disconnected or damaged. Disassemble the computer following the steps described in Chapter 4, *Replacement Procedures*, and perform the following checks.

- Check 1 Make sure that the Bluetooth antenna is firmly connected to the Bluetooth module (refer to Chapter 4 for instructions) and that the Bluetooth FFC is securely slotted into the system board. If the problem persists, go to Check 2.
- Check 2 Check that the Bluetooth communication switch is turned to "On", then make sure that the communication LED on the left panel is lit. If the LED is lit but the Bluetooth function is still faulty, the antenna module may be damaged. Replace with a new antenna following the steps in Chapter 4, *Replacement Procedures*. If the problem persists, or if the Bluetooth communication LED is not lit when the Bluetooth communication switch is turned to "On", go to Check 3.
- Check 3 The Bluetooth module may be damaged. Replace it with a new one following the instructions in Chapter 4. If the problem still exists, perform Check 4.
- Check 4 The system board may be damaged. Replace it with a new one following the instructions in Chapter 4.

2.17 4in 1 card Troubleshooting

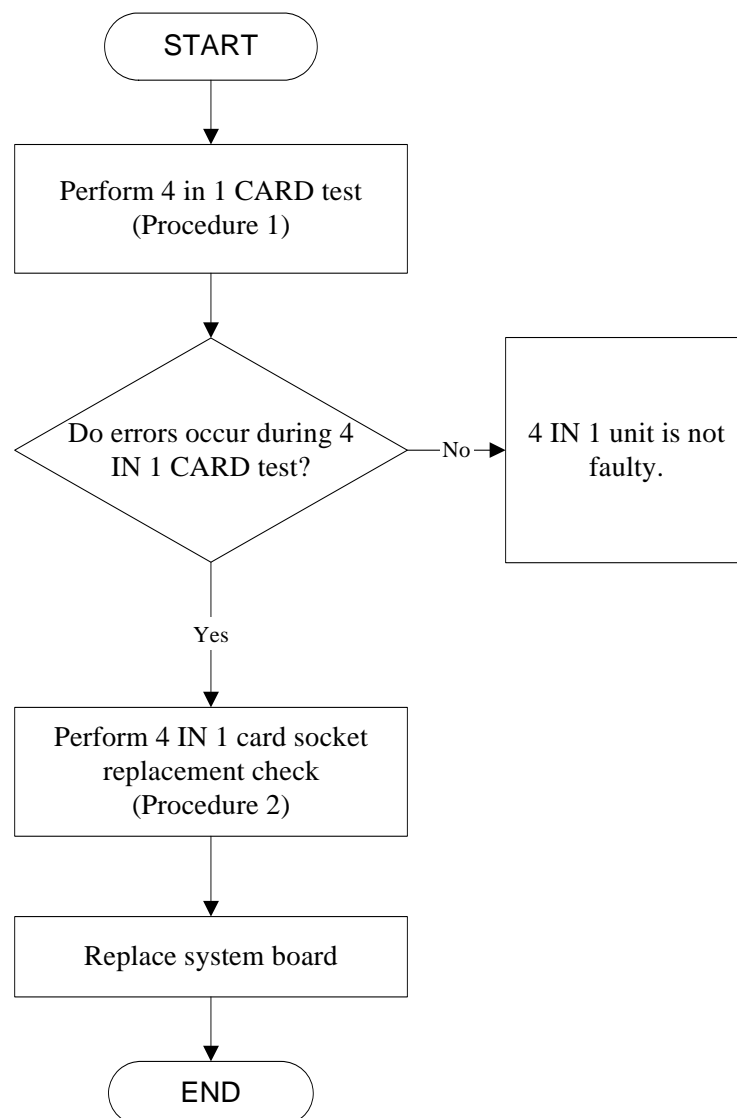

Figure 2-16 4 in 1 card troubleshooting process

This section describes how to determine if the 4 IN 1 Card player is functioning properly. The process is summarized in Figure 2-16. Perform the steps below starting with Procedure 1 and continuing with the other procedures as required.

Procedure 1: 5 in 1 card test

Procedure 2: Express socket replacement check

Procedure 1 4 in 1 card test

The 4 in 1 Card test card contains a 4 in 1 card test program. Ensure the card is fully inserted into the socket before running the program.

If an error occurs during the 4 in 1 card test, perform Procedure 2. If no error occurs, it is likely that the original 4 in 1 card was faulty.

Procedure 2 4 in 1 Card socket replacement check

The 4 in 1 Card socket may be damaged or defective, for instance the socket pins can be bent. Disassemble the computer following the steps described in Chapter 4, Replacement Procedures and replace the socket. If the problem persists, the system board may be defective or damaged. Replace the system board with a new one following the steps in Chapter 4.

2.18 HDD Troubleshooting

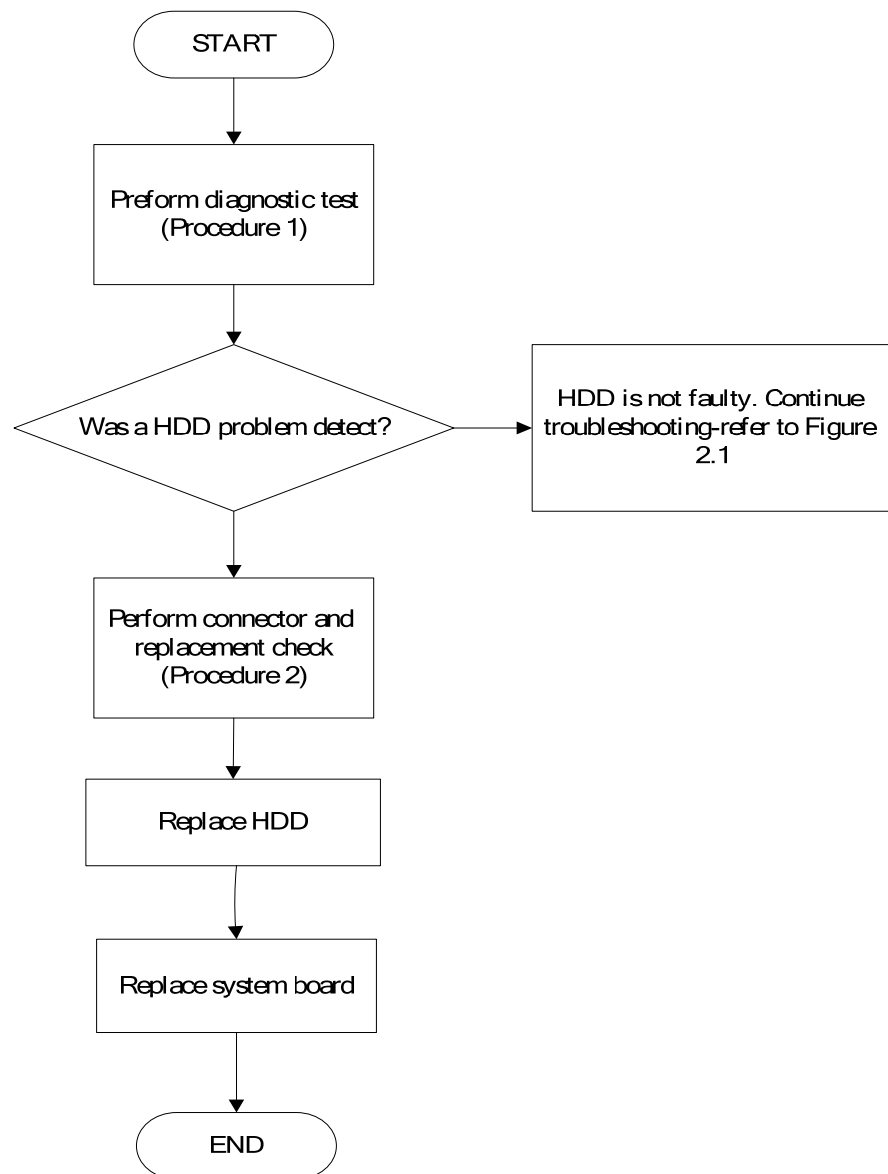

Figure 2-17 HDD troubleshooting process

The HDD or system board may be the reason of a HDD fault. Either of these two components may be damaged. To determine if the computer's HDD is functioning properly, perform the following procedures. Figure 2-15 outlines the process. Start with Procedure 1 and continue with the other procedures as instructed.

Procedure 1: Diagnostic test

Procedure 2: Connector and replacement check

Procedure 1 Diagnostic test

Run the Diagnostic Program, which will automatically execute the HDD R/W test. Refer to Chapter 3, Tests and Diagnostics for more information on the program.

If an error is located, go to Procedure 2. If an error is not located, the HDD function is functioning properly.

Procedure 2 Connector and replacement check

The HDD module or system board may be disconnected or damaged. Disassemble the computer following the steps described in Chapter 4, *Replacement Procedures*, and perform the following checks.

- Check 1 Make sure that the HDD module is securely slotted into the system board. If the problem persists, go to Check 2.
- Check 2 The HDD module may be damaged. Replace it with a new one following the instructions in Chapter 4. If the problem still exists, perform Check 3.
- Check 3 The system board may be damaged. Replace it with a new one following the instructions in Chapter 4.

2.19 CRT Troubleshooting

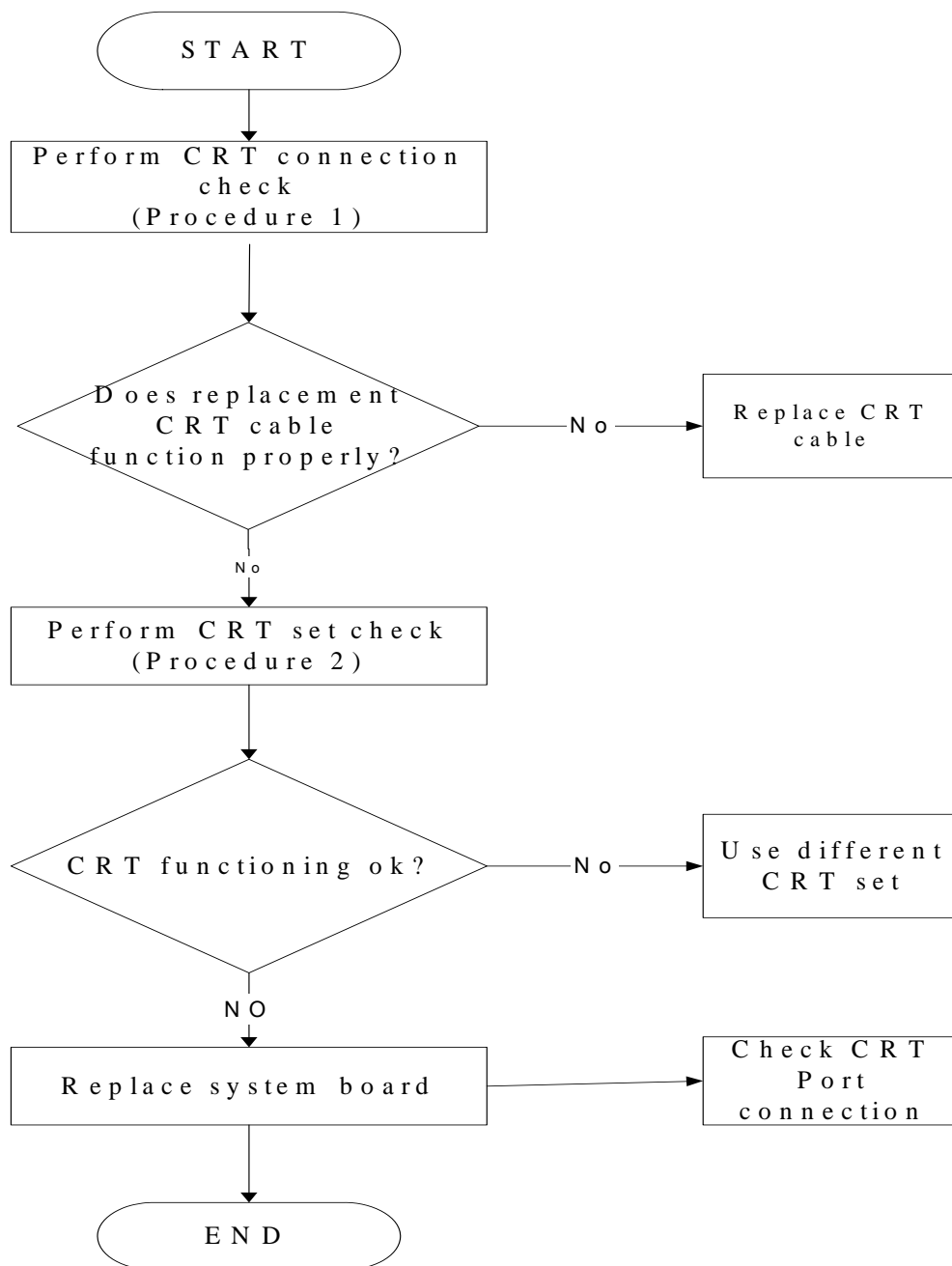

Figure 2-18 HDD troubleshooting process

To determine if the computer's CRT port is functioning properly, perform the following procedures. Figure 2-7 outlines the process. Start with Procedure 1 and continue as instructed.

Procedure 1: CRT connection check

Procedure 2: CRT set check

Procedure 1 CRT connection check

The CRT cable may be damaged or the connections may be loose. Perform Check 1:

- Check 1 Make sure CRT cable is firmly plugged into both the CRT set and the CRT port of the computer. If the cable is connected correctly, go to Check 2.
- Check 2 Make sure the CRT port is firmly secured to the system board of the computer. If the malfunction remains, go to Check 3.
- Check 3 The CRT cable may be damaged. Replace with a good cable. If the malfunction remains, go to Procedure 2.

Procedure 2 CRT set check

The CRT set may be faulty. Perform Check 1:

- Check 1 Try using the set for CRT reception. If it does not work, the set may be damaged. If the set does work, perform Check 2.
- Check 2 Try connecting a different CRT to the computer. If the replacement CRT works, the original set may be damaged. If the replacement set does not work the system board may be damaged. Replace it with a new one following the instructions in Chapter 4.

2.20 HDMI Troubleshooting

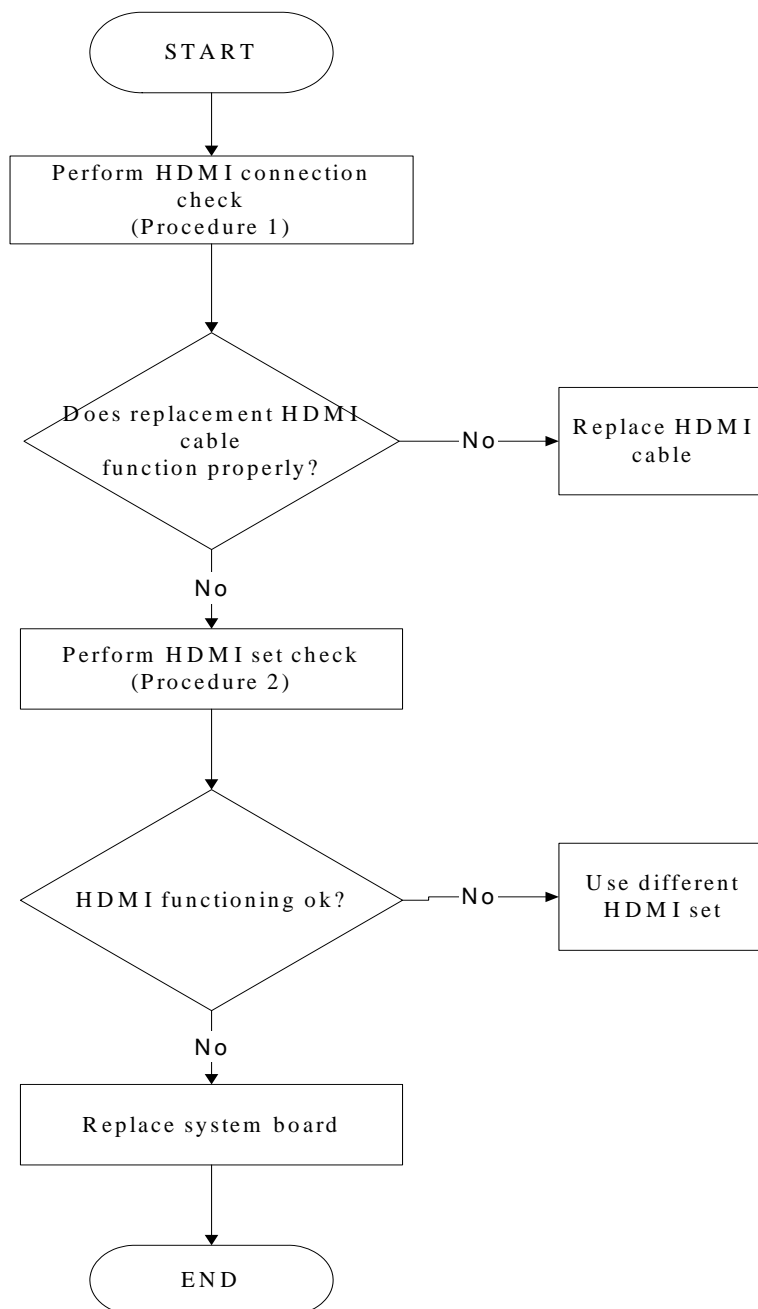

Figure 2-19 HDMI troubleshooting process

To determine if the computer's HDMI port is functioning properly, perform the following procedures. Figure 2-7 outlines the process. Start with Procedure 1 and continue as instructed.

Procedure 1: HDMI connection check

Procedure 2: HDMI set check

Procedure 1 HDMI connection check

The CRT cable may be damaged or the connections may be loose. Perform Check 1:

Check 1 Make sure HDMI cable is firmly plugged into both the CRT set and the CRT port of the computer. If the cable is connected correctly, go to Check 2.

Check 2 Make sure the HDMI port is firmly secured to the system board of the computer. If the malfunction remains, go to Check 3.

Check 3 The HDMI cable may be damaged. Replace with a good cable. If the malfunction remains, go to Procedure 2.

Procedure 2 HDMI set check

The TV set may be faulty. Perform Check 1:

Check 1 Try using the set for television reception. If it does not work, the set may be damaged. If the set does work, perform Check 2.

Check 2 Try connecting a different television to the computer. If the replacement television works, the original set may be damaged. If the replacement set does not work the system board may be damaged. Replace it with a new one following the instructions in Chapter 4.

2.21 Robson troubleshooting

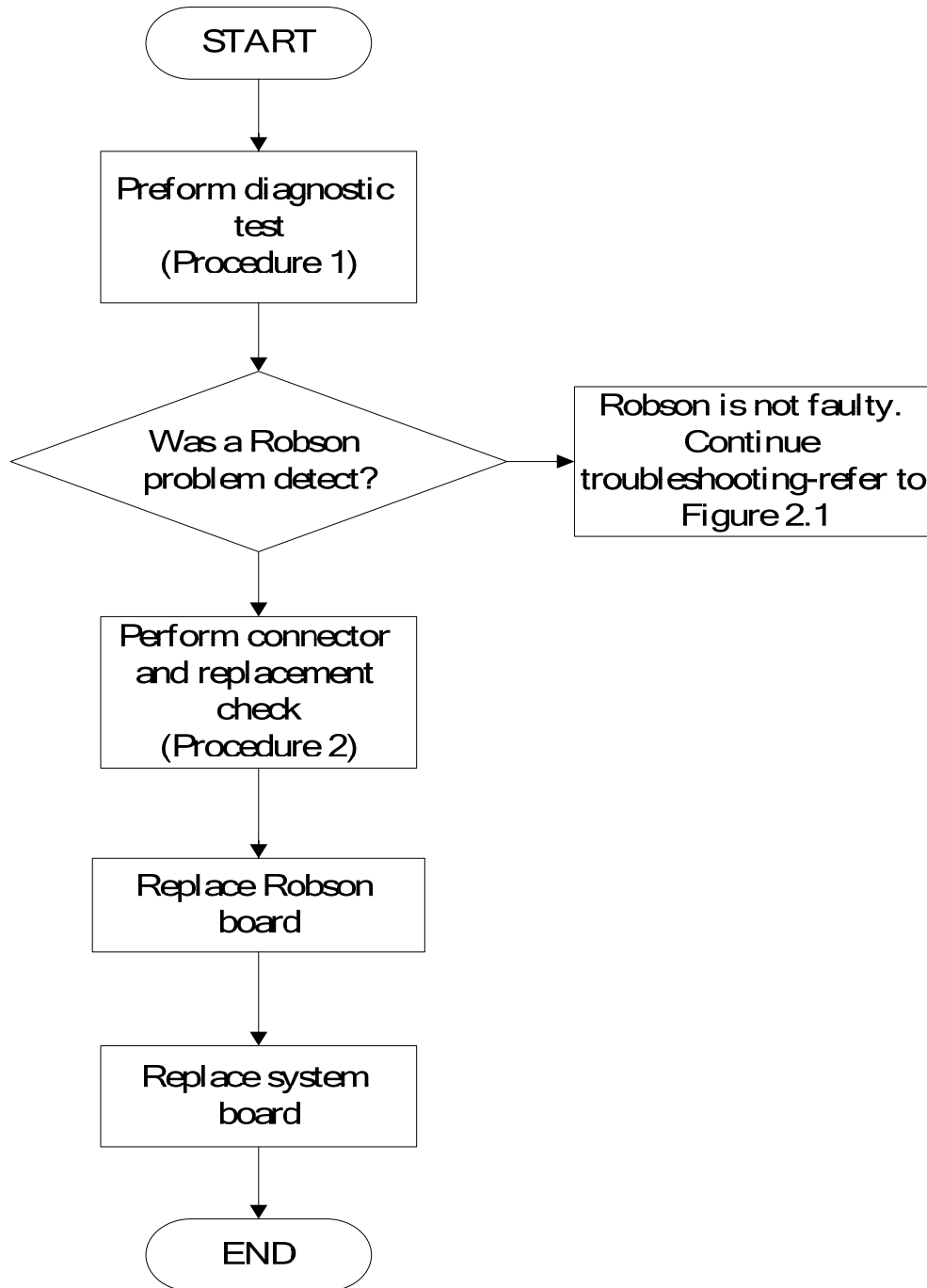

Figure 2-20 Robson troubleshooting process

The Robson board or system board may be the reason of a Robson fault. Either of these two components may be damaged. To determine if the computer's Robson is functioning properly, perform the following procedures. Figure 2-14 outlines the process. Start with Procedure 1 and continue with the other procedures as instructed.

Procedure 1: Diagnostic test

Procedure 2: Connector and replacement check

Procedure 1 Diagnostic test

Run the functioning Program on DOS model, which will display the Robson test result.

If tests and diagnostics result abnormal go to Procedure 2. If an error is not located, the Robson board is functioning properly.

Procedure 2 Connector and replacement check

The Robson board or system board may be disconnected or damaged. Disassemble the computer following the steps described in Chapter 4, Replacement Procedures, and perform the following checks.

- Check 1 Make sure that the Robson board is securely slotted into the system board. If the problem remains, go to Check 2.
- Check 2 The Robson board may be damaged. Replace it with a new one following the instructions in Chapter 4. If the problem still exists, perform Check 3.
- Check 3 The system board may be damaged. Replace it with a new one following the instructions in Chapter 4.

2.22 MIC Troubleshooting

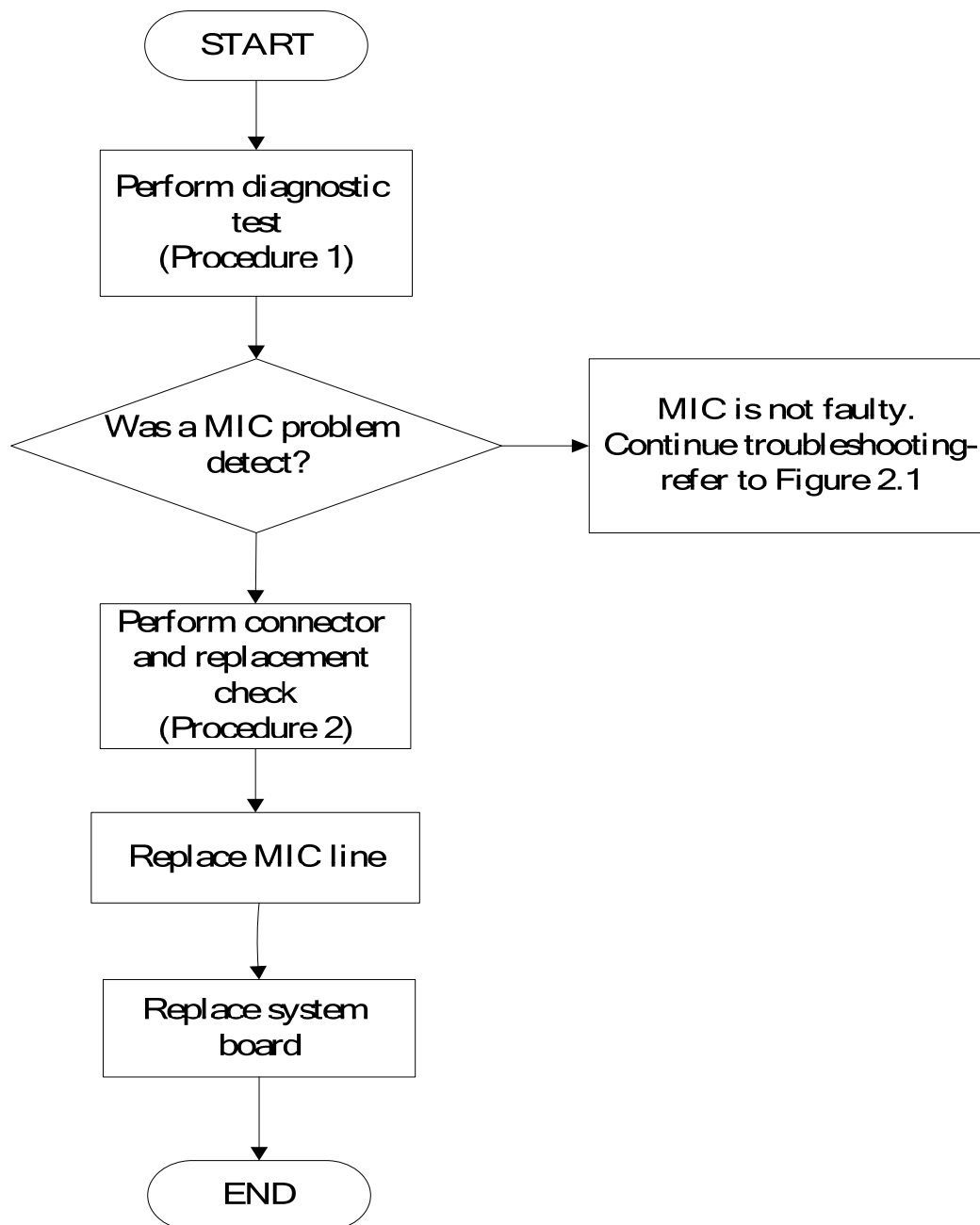

Figure 2.21. MIC troubleshooting process

The MIC line or system board may be the reason of a MIC fault. Either of these two components may be damaged. To determine if the computer's MIC is functioning properly, perform the following procedures. Figure 2-14 outlines the process. Start with Procedure 1 and continue with the other procedures as instructed.

Procedure 1: Diagnostic test

Procedure 2: Connector and replacement check

Procedure 1 Diagnostic test

Run the functioning Program on Windows model, which will display the MIC test result.

If tests and diagnostics result abnormal go to Procedure 2. If an error is not located, the MIC module functioning is properly.

Procedure 2 Connector and replacement check

The MIC line or system board may be disconnected or damaged. Disassemble the computer following the steps described in Chapter 4, *Replacement Procedures*, and perform the following checks.

- Check 1 Make sure that the MIC line is securely slotted into the system board. If the problem remains, go to Check 2.
- Check 2 The MIC line may be damaged. Replace it with a new one following the instructions in Chapter 4. If the problem still exists, perform Check 3.
- Check 3 The system board may be damaged. Replace it with a new one following the instructions in Chapter 4.

2.23 Finger printer troubleshooting

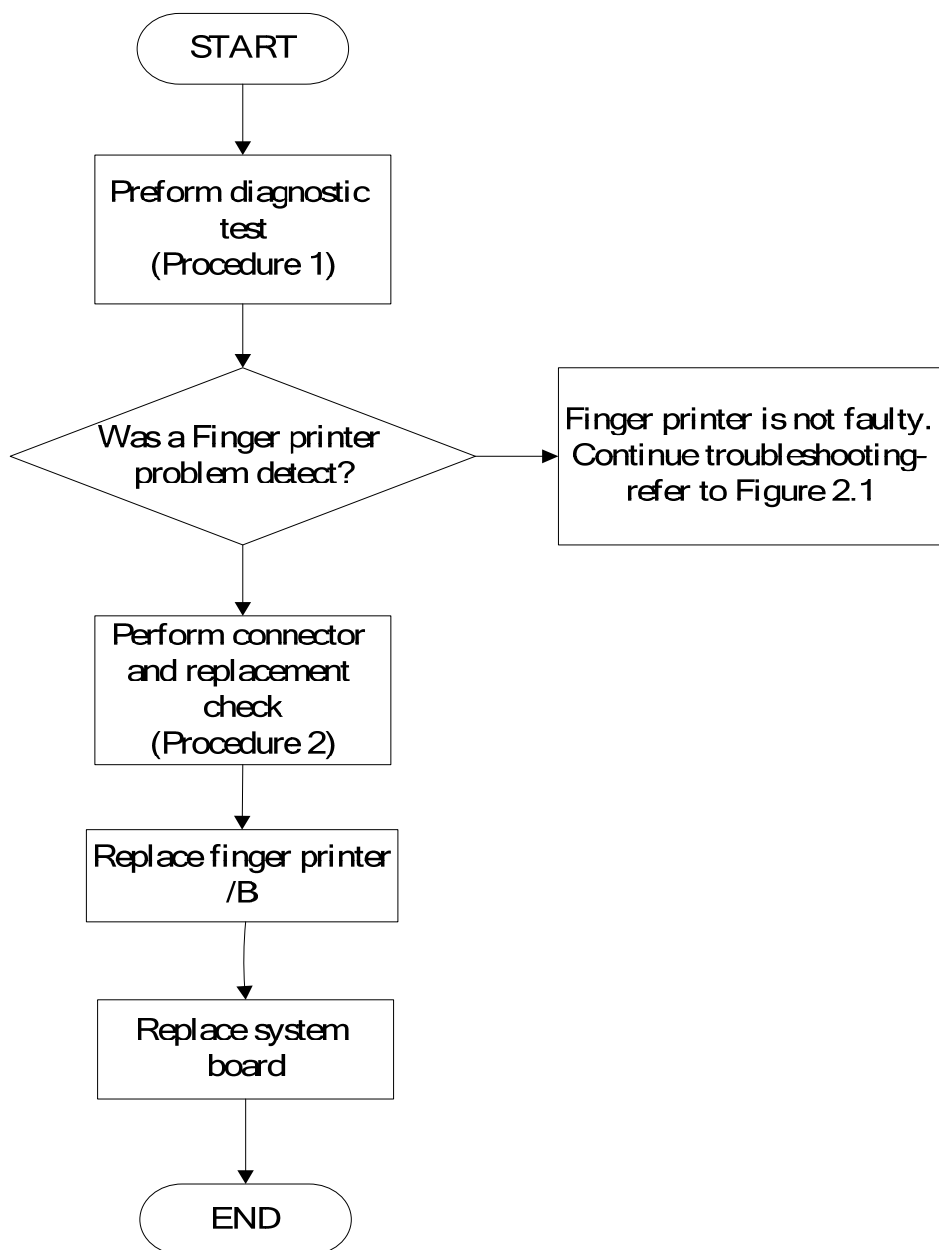

Figure 2-22 Finger printer troubleshooting process

The Finger printer board or system board may be the reason of a finger printer fault. Either of these two components may be damaged. To determine if the computer's Finger printer is functioning properly, perform the following procedures. Figure 2-14 outlines the process. Start with Procedure 1 and continue with the other procedures as instructed.

Procedure 1: Diagnostic test

Procedure 2: Connector and replacement check

Procedure 1 Diagnostic test

Run the Diagnostic Program, which will automatically execute the Finger printer test. Refer to Chapter 3, Tests and Diagnostics for more information on the program.

If an error is located, go to Procedure 2. If an error is not located, the Finger printer system is functioning properly.

Procedure 2 Connector and replacement check

The Finger printer board or system board may be disconnected or damaged. Disassemble the computer following the steps described in Chapter 4, *Replacement Procedures*, and perform the following checks.

- Check 1 Make sure that the Finger printer board FFC is securely slotted into the system board. If the problem persists, go to Check 2.
- Check 2 The Finger printer board may be damaged. Replace it with a new one following the instructions in Chapter 4. If the problem still exists, perform Check 3.
- Check 3 The system board may be damaged. Replace it with a new one following the instructions in Chapter 4.

Chapter 3

Tests and Diagnostics

Contents

3.1	The Diagnostic Test	3-3
3.2	Executing the Diagnostic Test.....	3-5
3.3	Display Configuration	3-9
3.4	Speaker Audio Test	3-10
3.5	Fan ON/OFF Test.....	3-11
3.6	Main Battery Charge Test	3-12
3.7	FDD Test	3-13
3.8	ODD Test	3-14
3.9	Keyboard Test	3-15
3.10	Mouse (Pad) Test	3-17
3.11	LCD Pixels Mode Test.....	3-19
3.12	Magnetic switch Test	3-20
3.13	LAN Test.....	3-22
3.14	RTC Test	3-23
3.15	Read 1394 GUID.....	3-24
3.16	Speaker EQ Check.....	3-25
3.17	Button Test	3-26
3.18	Fingerprint DOS Test	3-27
3.19	Clear Fingerprint Registered.....	3-29
3.20	1 st HDD Test.....	3-30
3.21	2 nd HDD Test.....	3-33
3.22	Front Edge Logo check	3-36
3.23	Write DMI	3-37
3.24	Read DMI	3-39

3.1 The Diagnostic Test

This chapter explains how to use the Test & Diagnostic program to test the functions of the **(Base on Orlando10&10G&10H T&D version 1.1)** hardware modules. The Test & Diagnostic Program is stored on the T&D diskettes. The program consists of a series of tests that run automatically when the Diagnostics Program items are selected and executed.

NOTES: *To start the diagnostics, follow these steps*

1. *Check all cables for loose connections.*
2. *Exit this program when you are at Main Menu.*

The TEST & DIAGNOSTIC PROGRAM contains the following functional tests:

- CONFIG CHECK TEST
- SPEAKER AUDIO TEST
- FAN ON/OFF TEST
- MAIN BATTERY CHARGE TEST
- FDD TEST
- ODD TEST
- KEYBOARD TEST
- MOUSE(PAD) TEST
- LCD PIXELS MODE TEST
- MAGNETIC SWITCH TEST
- 1st HDD R/W TEST
- 2nd HDD R/W TEST
- LAN TEST
- RTC TEST
- IEEE1394 CODE TEST
- Speaker EQ Check&Rewrite
- Button Test
- Fingerprint DOS Test
- Clear FP(Fingerprint) Registered
- Front Edge Logo check
- Write DMI
- Read DMI

You will need the following equipment to perform some of the Diagnostic test programs.

- The diagnostics diskette (2 pcs)
- A formatted working diskette for the floppy disk drive test (Floppy Disk Drive Test)
- A data CD disc (ODD Test)
- A LAN loopback

The following sections explain how to execute the Test & Diagnostic Program and detail the tests within the program.

3.1 Executing the Diagnostic Test

DOS is required to run the DIAGNOSTICS PROGRAM. To start the DIAGNOSTIC PROGRAM, follow these steps:

1. Insert the diagnostics diskette #1 in the floppy disk drive and turn on the computer. (The diagnostics diskette contains the DOS boot files.) And then follow the instructions to swap with the diagnostics diskette #2 for T&D program installed in RAM driver.

NOTE: To execute the CD test, make sure the CD is installed in the ODD drive.

The T&D Program can run by single test item when you press corresponsive English letter of test item, or run two or more test items what you like if you choose them by “Arrow cursors” and “Space Bar” – the wonderful thing is you can setup test loop by “Enter” button. And it also asks you if you like to copy test log file to diskette as reference at the end of test(s).

The test list is as the following:

- A. CONFIG CHECK TEST
- B. SPEAKER AUDIO TEST
- C. FAN ON/OFF TEST
- D. MAIN BATTERY TEST
- E. FDD TEST
- F. ODD TEST
- G. KEYBOARD TEST
- H. MOUSE (PAD) TEST
- I. LCD PIXELS MODE TEST
- J. MAGNETIC TEST
- K. LAN TEST
- L. RTC TEST
- M. IEEE1394 CODE TEST
- N. SPEAKER EQ CHECK TEST
- O. BUTTON TEST
- P. FINGERPRINT TEST
- Q. CLEAR FP REGISTERED
- R. 1st HDD TEST
- S. 2nd HDD TEST
- T. Front Edge logo
- U. Write DMI
- V. Read DMI
- Z. Save LOG to floppy
- X: Exit

3. Tests and Diagnostics

The below display will show up at the beginning of T&D program

Orlando10/10C/10H (ISRAA) DOS MODE Function T&D DISKETTE MENU		
A.CONFIG CHECK TEST	J.Magnetic Switch	S.2nd HDD TEST
B.SPEAKER AUDIO TEST	K.LAN TEST	T.Front Edge logo
C.FAN ON/OFF TEST	L.RIC TEST	U.Write DMI
D.MAIN BATTERY TEST	M.IEEE1394 CODE CHECK	V.Read DMI
E.FDD TEST	N.Speaker EQ Check	W.NA
F.ODD TEST	O.BUTTON TEST	
G.KEYBOARD TEST	P.Fingerprint TEST	
H.MOUSE (PAD) TEST	Q.Clear FP Redistered	Z.Save LOG to Floppy
I.LCD PIXELS TEST	R.1st HDD TEST	X.EXIT
ISRAA T&D Function test --Ver:1.1(2007.06.06)		
Please select a test item		

If the test result passes, the following display will show up:



If an error is detected and a test fails, the following message displays:



Then press any key for next actions – the below display presented if copying test log file onto diskette is necessary. This action will be executed when “Y” key pressed.

Orlando10/10G/10H (ISRAA) DOS MODE Function T&D DISKETTE MENU		
A.CONFIG CHECK TEST	J.Magnetic Switch	S.2nd HDD TEST
B.SPEAKER AUDIO TEST	K.LAN TEST	T.Front Edge logo
C.FAN ON/OFF TEST	L.RTC TEST	U.Write DMI
D.MAIN BATTERY TEST	M.IEEE1394 CODE CHECK	V.Read DMI
E.FDD TEST	N.Speaker EQ Check	W.NA
F.ODD TEST	O.BUTTON TEST	
G.KEYBOARD TEST	P.Fingerprint TEST	
H.MOUSE (PAD) TEST	Q.Clear FP Redistered	Z.Save LOG to Floppy
I.LCD PIXELS TEST	R.1st HDD TEST	X.EXIT
ISRAA T&D Function test --Ver:1.1(2007.06.06)		
Please select a test item		

It will skip this process if “N” key pressed.

3. Tests and Diagnostics

And then it will check if it's necessary to leave this program. Program will quit when "Y" key pressed and it will go back main menu for next test if "N" key pressed.

Orlando10/10G/10H (ISRAA) DOS MODE Function T&D DISKETTE MENU		
A.CONFIG CHECK TEST	J.Magnetic Switch	S.2nd HDD TEST
B.SPEAKER AUDIO TEST	K.LAN TEST	T.Front Edge logo
C.FAN ON/OFF TEST	L.RTC TEST	U.Write DMI
D.MAIN BATTERY TEST	M.IEEE1394 CODE CHECK	V.Read DMI
E.FDD TEST	N.Speaker EQ Check	W.NA
F.ODD TEST	O.BUTTON TEST	
G.KEYBOARD TEST	P.Fingerprint TEST	
H.MOUSE (PAD) TEST	Q.Clear FP Redistered	Z.Save LOG to Floppy
I.LCD PIXELS TEST	R.1st HDD TEST	X.EXIT
ISRAA T&D Function test --Ver:1.1(2007.06.06)		
Please select a test item		

3.3 Display Configuration

This Item will show the unit configuration. It includes:

- ◆ CPU type (Single/Dual Yunah; Cache ; CPU speed ;CPU FSB)
- ◆ DDRAM SIZE
- ◆ ODD TYPE ((DVD-SuperMulti; COMBO; ...)
- ◆ Panel ID
- ◆ HDD type & capacity (Vendor ID. Model .Firmware)
- ◆ VRAM size / VGA CHIP TYPE
- ◆ Battery cell (6cell;9cell;12cell)
- ◆ Wireless type
- ◆ LAN Type
- ◆ 1394
- ◆ Bluetooth
- ◆ SKU ID
- ◆ Robson size

The screen should display as below:

```

=====
===== Configuration as Below =====
=====
CPUType=Merom-T7300
CPUCache=4096
CPUSpeed=2.00GHZ
CPUFSB=800MHZ
DDRAMSIZE=1024MBRAM
ODDTYPE=DVD-RW+2Q60
PanelID=SAMSUNG17.0WXGA+
HDD1=FUJITSU_MHW2120BH0000012
HDD2=TOSHIBA_MK1237GSXDL130M
VRAMSIZE&VGATYPE=965GM
BATT=6cell
WirelessType=Foxconn06C00
LANType=8111B
1394=YES
Bluetooth=YES
SKUID=0A
robsonsize=0512MB

ARE YOU TEST OK?[Y,N]?

```

3.4 Speaker Audio Test

The speaker audio test allows the user to aurally confirm the speaker functions. And check both speakers if they are OK within 3 times “Beep” sound generated.

NOTE: Remember to tune up the volume as “**Maximum**” before this test starts.

The screen should display as below, indicating whether the test is passed or failed after the question.

```
=====Speaker audio Test=====
1.Please adjust volume to max level.
2.Please listen to both of speaker will send out Beep sound
  (3 times).

Press any key to continue . . .
```

3.5 Fan ON/OFF Test

The fan test allows the user to test aurally whether the fan is working. And follow the below procedures for this test:

- ◆ The computer will let the fan be “ON” after any key pressed. Feel the wind or listen the rotating sound to check whether the fan is working or not.

NOTE: Remember to approach fan outlet that is near right side of unit whether fan is “ON”.

- ◆ The computer will stop the fan working after any key pressed. Feel the wind or listen the sound to check if the fan is “OFF”.

The screen should display as below, indicating whether the test is passed or failed after the question.

```
===== FAN TEST =====  
  
Please approach FAN outlet to listen to FAN rotating sound.  
  
Press any key to continue . . .
```

3.6 Main Battery Charge Test

NOTE: The AC adaptor (90W, 19V) should be connected to successfully run this test.

This test shows and measures the main battery:

- ◆ Battery type (Lion)
 - ◆ Manufacturer (Sanyo/Panasonic/Sony)
 - ◆ Remain charge capacity (0 ~ 100%)
 - ◆ Charge function (PASS/FAIL)
- “Battery Is Full” showed when “remain charge capacities” is 100%

The screen should display as below, if the charge function is OK, will show:.

```
ONLY FOR 87591 T&D Series Battery Test Program.[591] V1.0 2002/07/23
MAIN Battery

Battery Type: Lion
Manufacturer: Sony
Remain charge capacity : 80.0%

Charge Test-> [ PASS ]

Press any key to continue . . .
```

If the charge function is NG, the screen will display as:

```
ONLY FOR 87591 T&D Series Battery Test Program.[591] V1.0 2002/07/23
MAIN Battery

Battery Type: Lion
Manufacturer: Sony
Remain charge capacity : 86.5%

Charge Test-> [ FAIL ]

Press any key to continue . . .
```

3. 7 FDD Test

NOTE: Before running the FDD test, prepare a formatted work diskette (1.44 MB). Remove the diagnostics diskette and insert the work diskette into the FDD. The contents of the floppy diskette maybe erased.

The Floppy Disk Test includes three subtests of the:

1. Sequential seek/verify function (Range: Track 0 ~ 79)
2. Funnel code seek/verify function (Range: Track 0 ~ 79)
3. Write/Read/Compare pattern function (Range: Track 75 ~ 79)

NOTE: The write-protected device of this formatted diskette should be “Disable”.

The subtests run automatically.

NOTE: Press “Esc” key can skip the current subtest.

The screen should display as below, indicating whether the subtests pass or fail when finished.

```
***** Fdd Test Program V1.3 *****  
Testing Driver A: [1.44 MByte (Cyl:80, Head:2, Sec:18)]...  
Testing Seq. seek/verify... Head: 01, Track: 79... [ PASS ]  
Testing Fun. seek/verify... Head: 01, Track: 06...
```

3. 8 ODD Test

The ODD test allows a user to aurally confirm the ODD functions.

NOTE: *A CD disc (including data file) must be inserted into the ODD drive then must wait ODD drive initial OK (ODD LED stop flashing) before this test starts.*

The ODD test includes two subtests of the:

1. Random read/partial sequential read function
2. Eject ODD door

The screen should display as below, indicating whether the subtests pass or fail when finished.

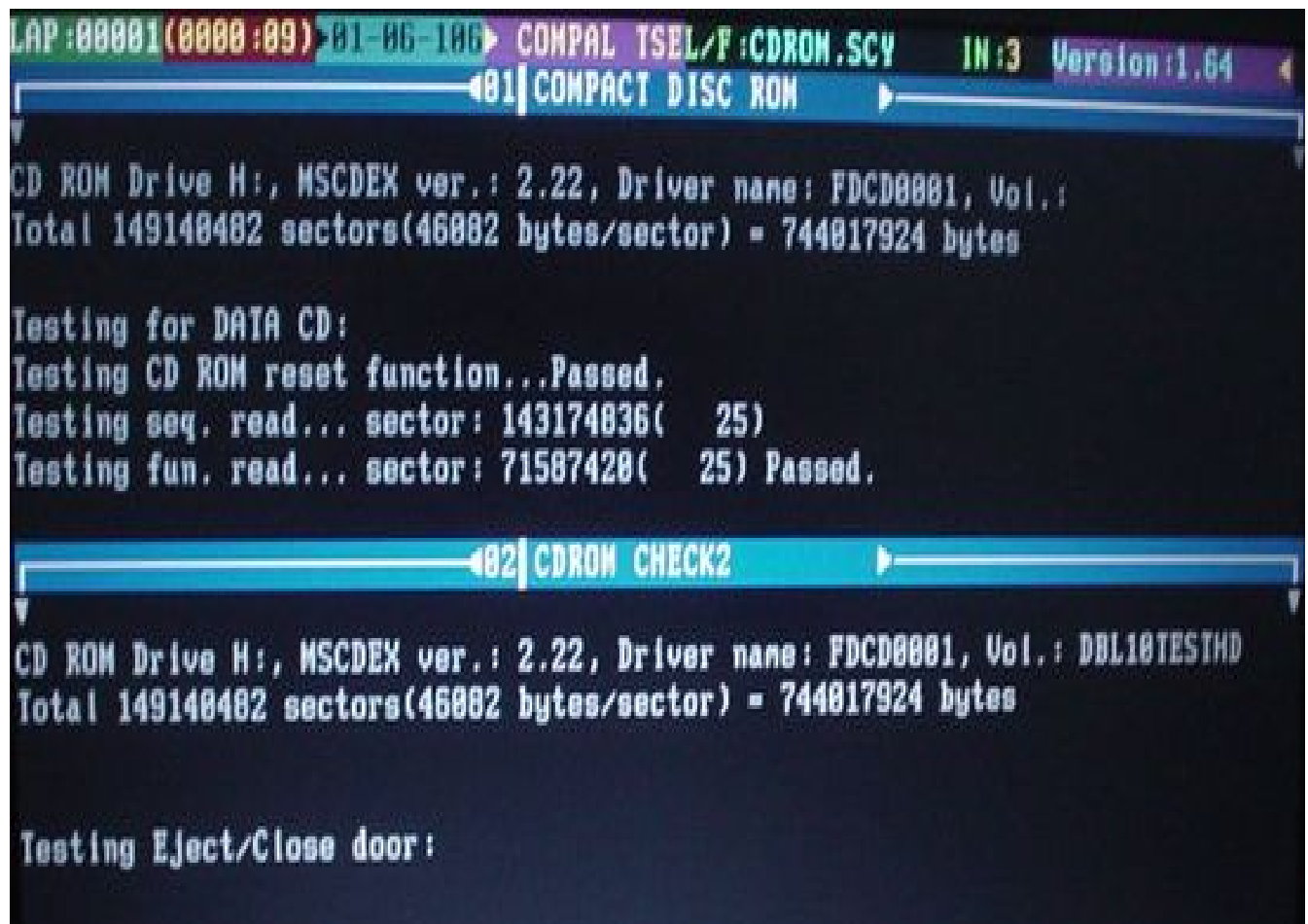

3. 9 Keyboard Test

The keyboard test checks the all keys function.

NOTE: The **Num Lock** and the **Overlay** mode must be off to execute the keyboard test.

Before keyboard test starts, the keyboard matrix code should be chosen as below display:

1. **K** (UK, for Europe)
2. **S** (US, for America)
3. **J** (Japan, for Japan)

When you execute this test, the keyboard layout is drawn on the display. When any key is pressed, the corresponding key on the screen changes to black as shown below.

It will indicate whether the subtest is passed or failed after the question.

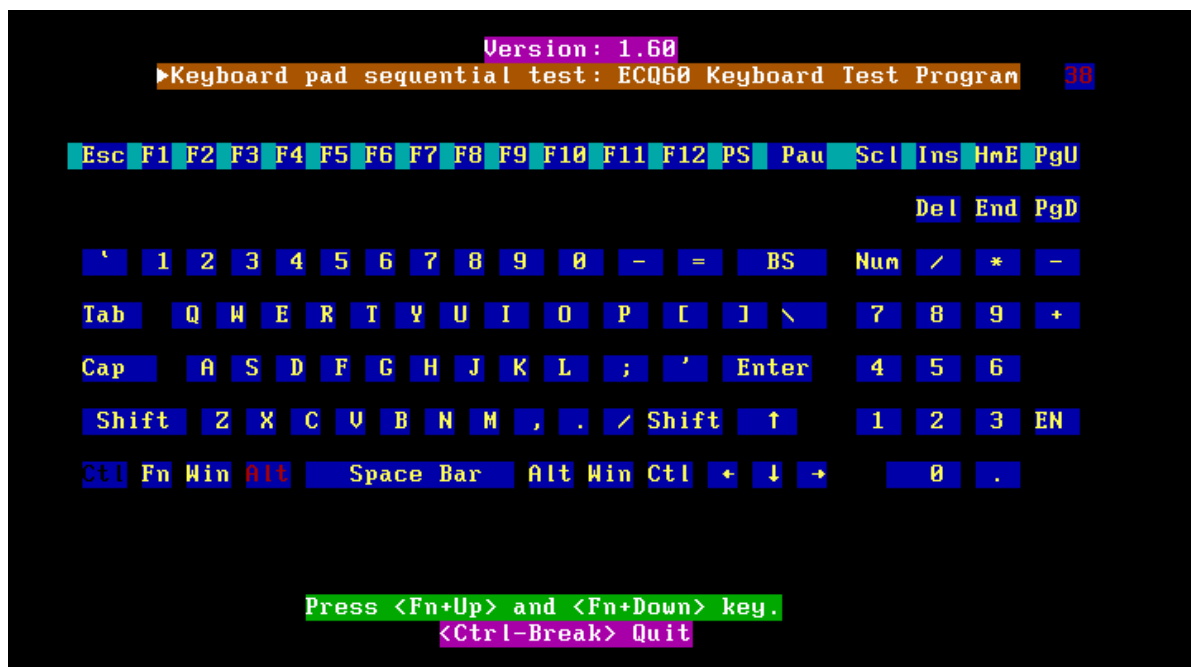

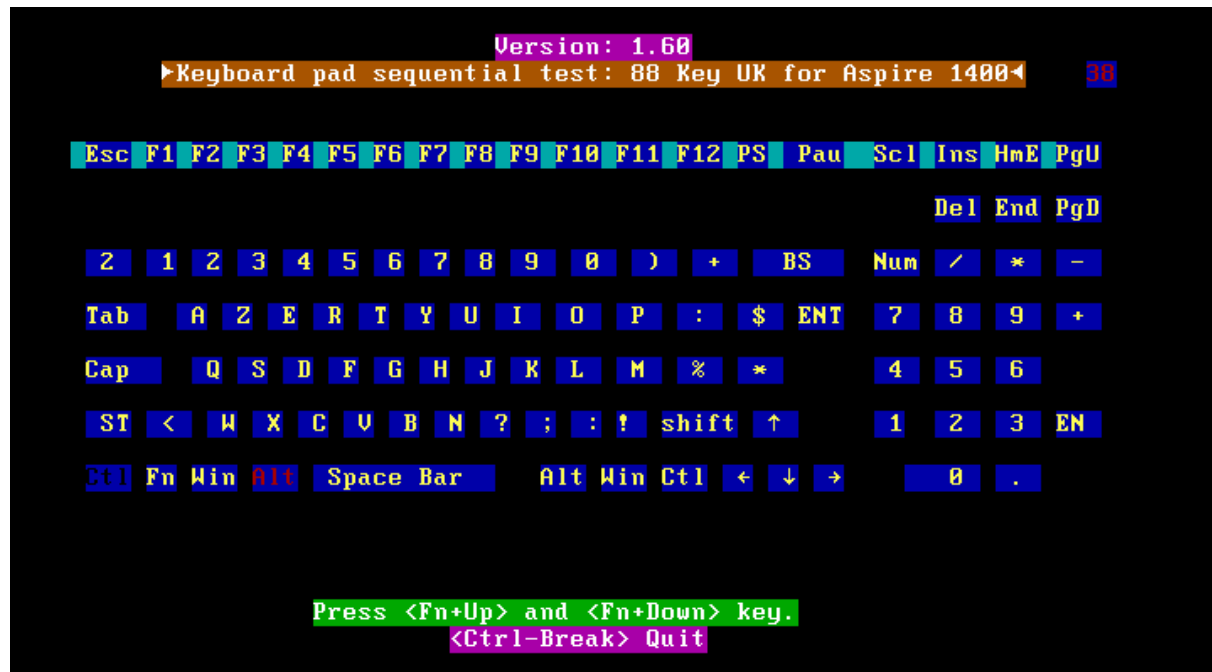

NOTE: The “Fn” key cannot be tested in the keyboard test. To determine whether the “Fn” key is working correctly, press “Fn+F6” or “Fn+F7” keys to check if LCD display brightness change gradually.

3.10 Mouse (Pad) Test

The Mouse test allows the user to select and assign values to the following, using the Touch Pad or “**Tab**” key to move between selections:

1. Mouse Speed (on a scale from slow to fast)
2. Acceleration (Off, Low, Medium, High)
3. Button Assignments (Left + Right / Right button, either Unassigned or Drag Lock)
4. Swap Buttons (Left /Right)

NOTE: The Touch Pad test cannot be used to test an external USB mouse.

The Touch Pad button subtest allows users to test their Touch Pad buttons. If the buttons are clicked, the cursors should appear in the corresponding box of the button figure that is displayed on the screen as below.



3. Tests and Diagnostics

After checking T/Pad buttons and cursor's function, use "Tab" key or use T/Pad cursor to click the "OK" column will end this test.

It will indicate whether the subtests pass or fail after three questions.

NOTE: *The above figure has three compartments although the Touch Pad installed may only have two buttons. In this case, the central compartment in the figure does not correspond to any button.*

3. 11 LCD Pixels Mode Test

This LCD pixels mode test checks whether video display is fine.

This test includes two modes of the test:

1. Text Mode
 - including 40*25 (16 colors) and 80*25 (2/16colors).
2. VGA Mode
 - including 320*200 (4/16/256 colors), 640*200 (2/16 colors), 640*350 (2/16 colors), 640*480 (2/16/256 colors), 800*600 (256 colors) and 1024*768 (256 colors).

The screen should display as below, indicating whether the test is passed or failed after the question.

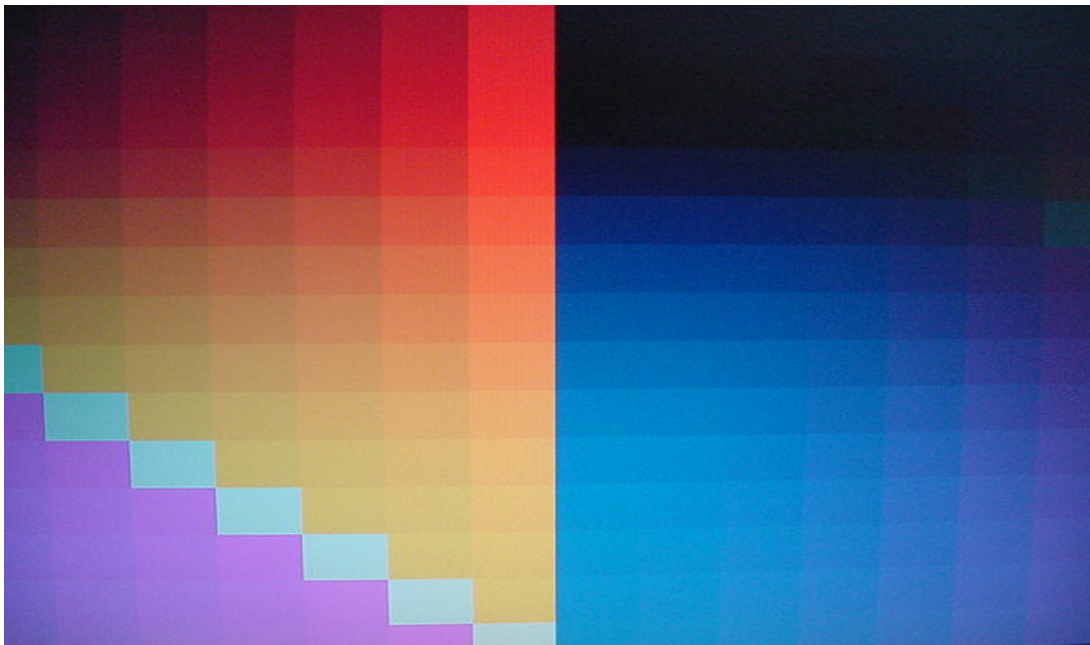

3.12 Magnetic Switch Test

The lid switch test checks the lid function of the unit. When LCD cover closed, the lid should enable to turn off the display.

Follow below steps to run this test:

1. Close the LCD cover.
2. open the LCD cover, if the lid switch test fail, it will stop below display:

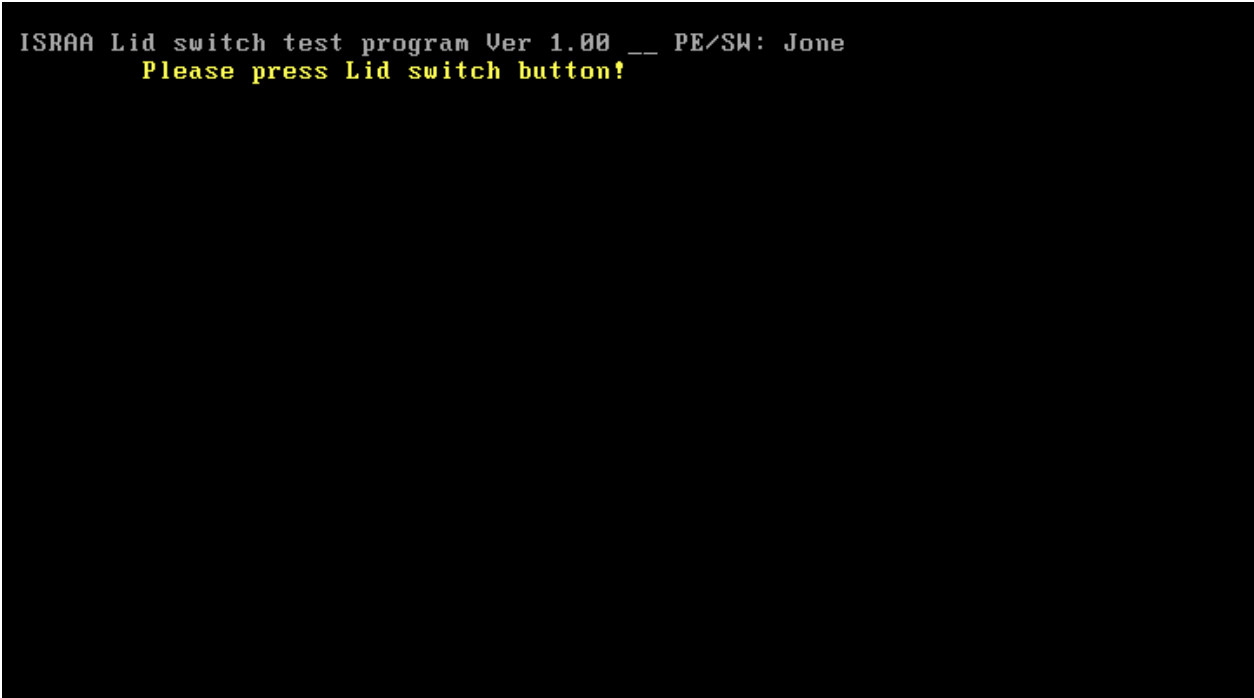
A screenshot of a terminal window with a black background and white text. The text reads: "ISRAA Lid switch test program Ver 1.00 __ PE/SW: Jone" followed by "Please press Lid switch button!" in yellow text.

```
ISRAA Lid switch test program Ver 1.00 __ PE/SW: Jone
Please press Lid switch button!
```

3. If the Lid switch tests pass, it will show below display:

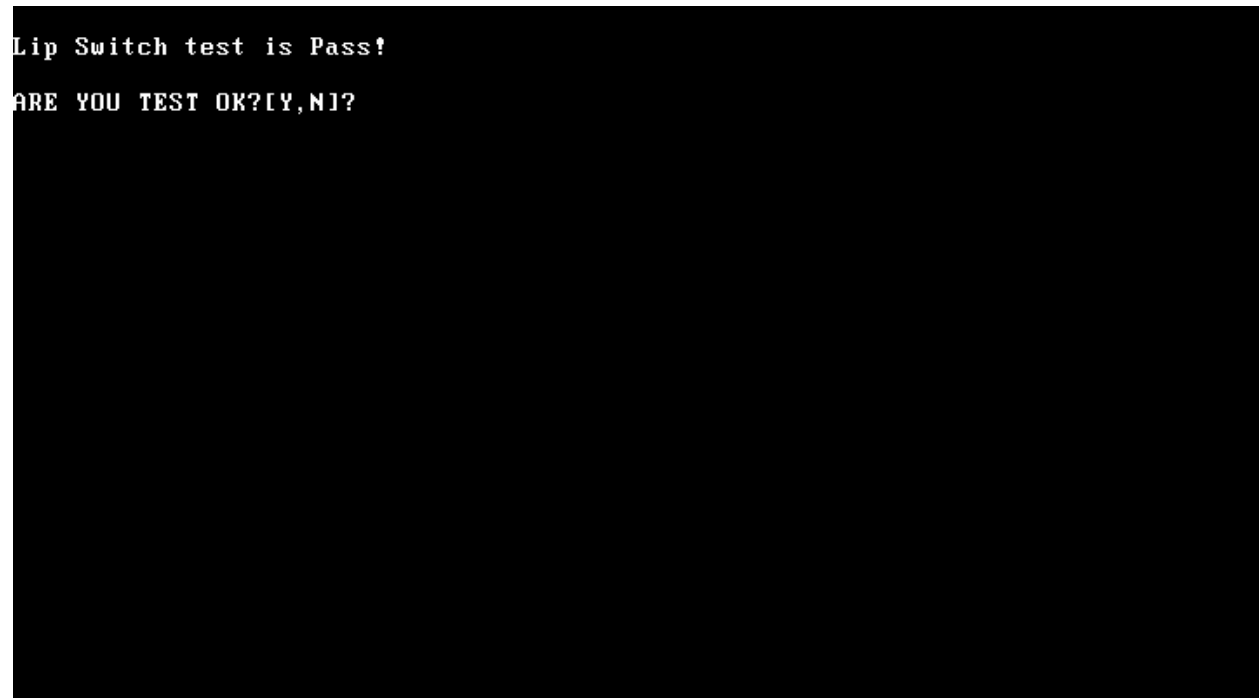

```
Lid Switch test is Pass!  
ARE YOU TEST OK?[Y,N]?
```

3.13 LAN Test

The LAN test checks the LAN full-duplex environment.

NOTE: LAN loopback needs to plug in before test begins.

And LAN information will show on the test screen:

- ◆ IO Base – Port: A000H
- ◆ IRQ – BH, it's "IRQ 10".
- ◆ Node – it is "MAC Address".
- ◆ Line Frame – 1514 Bytes.
- ◆ Line Speed – 100Mbps or 10 Mbps.
- ◆ Bus ID – it's "4".

The LAN test includes three subtests of the:

1. Speed1000
2. Speed100
3. Speed10

The subtests run automatically.

```
==== LAN TEST ====

1.Please plug-in the Loopback into LAN port.
2.Please see test result in middle of display.
  (Pass: 000 , Fail: xxx )

Press any key to continue . . .
```

The screen should display as below, indicating whether the subtests pass or fail when finished.

```
Test PCI-E Family LAN product Tools / Client 1.00 Test Version
IOBASE = 4000H IRQ = B H Node:0016D4123456      100M: 3K 10M: 1K
VID =10ECH SID =8136H      SVID =1179H SSID =FF00H

Open Your PCIE.CFG in this machine!
Test Item      Result(Pass/Fail)      Return code

1.PG8136=false      none
2.Reg_R/W=true      Pass
3.Speed1000=true      none
4.Speed100=true      testing
5.Speed10=true      testing
6.Debug=false
7.LoopCount= 1

Press 'ESC' key to exit .....
```

If an error is detected and a test fails, the following message displays:



3.14 RTC Test

Checks the computer's RTC (Real Time Clock) and calendar functions by comparing the DOS and CMOS values.

The test runs automatically.

The screen should display as below, indicating whether the test is passed or failed when finished.

```
====RTC TEST====

Please Check the result after test.

Press any key to continue . . .

Wait for zero counter...
Testing...
DOS TIME = 22:33:48.04(8122804), CMOS TIME = 22:33:48(8122800)
DOS DATE: 09/19/2002, CMOS DATE: 09/19/2002
DATE & TIME test [ PASS ]

Press any key to continue . . .
```

3.15 Read 1394 GUID

This test will check if the computer's EEPROM 1394GUID code is correct.

NOTE: Must open the RAM Door to see RAM connector GUID bar code before test item begins.

The figure below will be displayed:

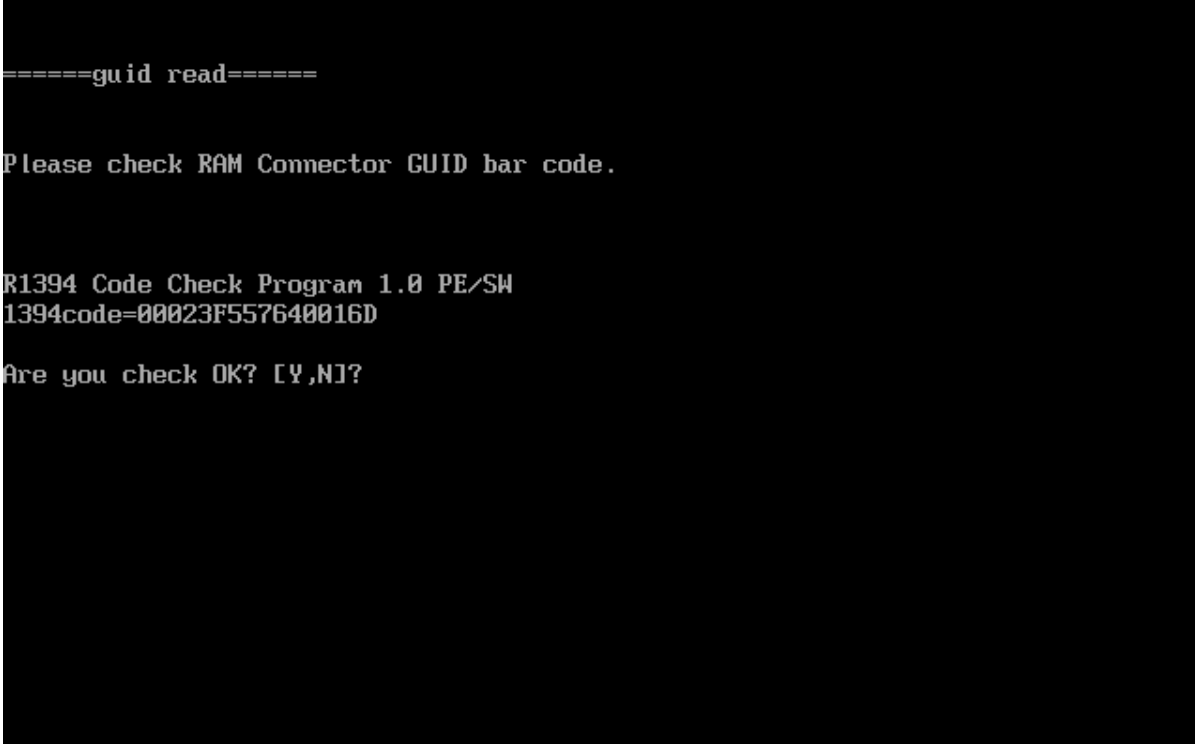

```
====guid read====  
  
Please check RAM Connector GUID bar code.  
  
R1394 Code Check Program 1.0 PE/SW  
1394code=00023F557640016D  
  
Are you check OK? [Y,N]?
```

3.16 Speaker EQ Type Check&Re-Write

This test will check if the computer's EEPROM EQ type is correct.

The EQ Type test includes two subtests of the:

1. Check EQ Type from EEPROM
2. Re-Write EQ Type to EEPROM

NOTE: To execute this test, you must select speaker type (Harman or No brand) and Harman speaker number (2speaker or 3speaker or 5speaker).

The figure below will be displayed, please select write or read speaker EQ:

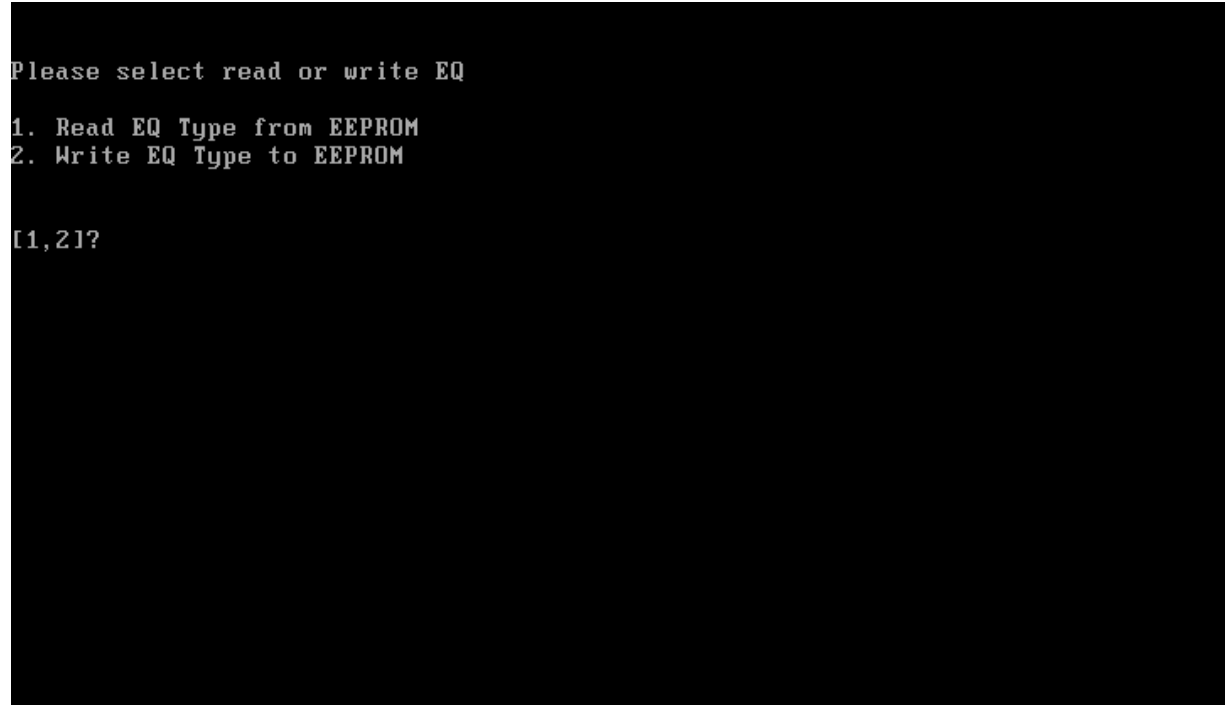

```
Please select read or write EQ
1. Read EQ Type from EEPROM
2. Write EQ Type to EEPROM

[1,2]?
```

3. Tests and Diagnostics

If you select read speaker EQ, the figure will be displayed below, please select your machine speaker type and number:

```
Please select read or write EQ
1. Read EQ Type from EEPROM
2. Write EQ Type to EEPROM

[1,2]?1

=====EQ CHECK TEST=====

Please check Logic up left side mark then Select Speaker type
1: Harman 2speaker
2: Harman 3speaker
3: harman 5speaker
4: No brand speaker
[1,2,3,4]?
```

If you select write speaker EQ, the figure will be displayed below, please select your machine speaker type and number:

```
Please select read or write EQ
1. Read EQ Type from EEPROM
2. Write EQ Type to EEPROM

[1,2]?2

=====Write EQ to EEPROM =====

Please Select Speaker type
1: harman 2speaker
2: harman 3speaker
3: harman 5speaker
4: no brand speaker
[1,2,3,4]?
```

3.17 Button Test

The control button test allows the user to manually test each of the five CD control buttons.

Key "WWW" need to press first. One will hear one "bi" sound when press "WWW" or "Audio" Sound and continuously "bi" sound for another key test.

The figure below will be displayed:



Press each of the buttons on the front panel in turn. A yellow bar will appear on the relevant section of the figure if the button passes the test.

Press **Ctrl +C** to quit the test.

3.18 Fingerprint DOS Test

This test will check if the computer's Fingerprint function is OK.

NOTE: Execution of this test destroys fingerprint data

The subtests run step by step: (As below)

Step1. Need you swipe your finger to enroll



Step2. Need you swipe your finger 2nd time to enroll.

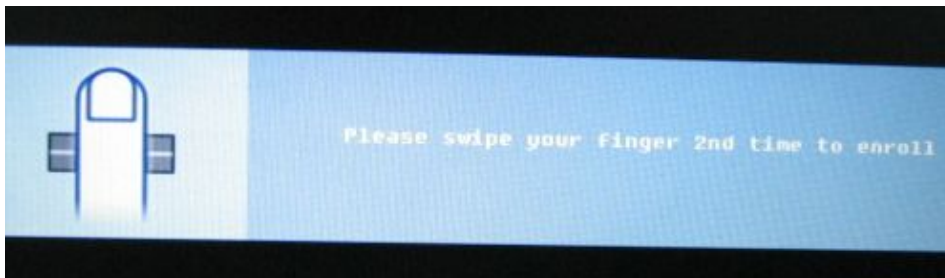

Step3. Need you swipe your finger 3rd time to enroll.

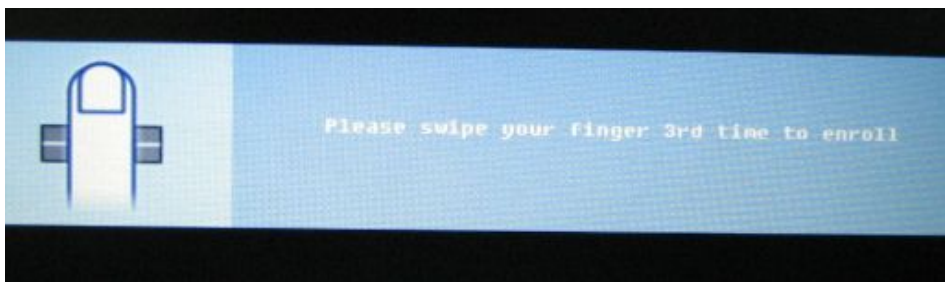

Step4. The test program auto compare 1st, 2nd and 3rd finger then to enroll.



Step5. Need you swipe your finger then test program will verify it.



Step6. Verify pass,

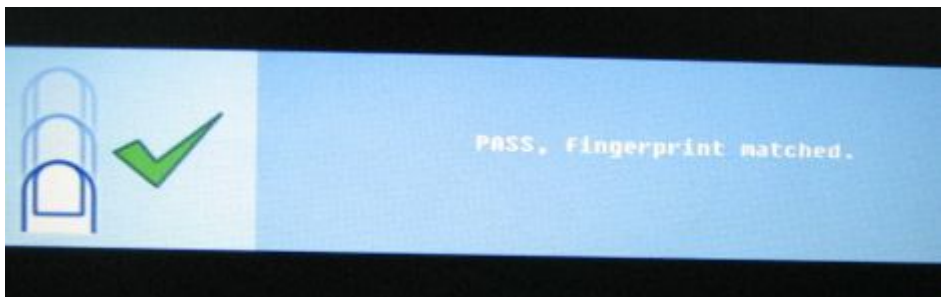

Step7. Need you select your test result to show "PASS" or "Fail".

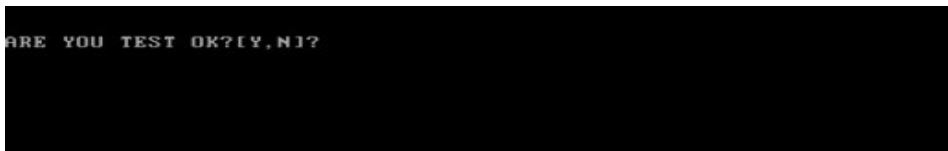

3.19 Clear Fingerprint Registered

NOTE: Execution of this test destroys fingerprint data

Working Instruction:

Run command - "HWTEST 0 29 3 1 -C" to clear all information in TBX module

The subtests run step by step: (As below)

Step1:

```
=====Clear Fingerprint Registered =====  
  
Are YOU Clear Fingerprint Registered?[Y,N]?
```

Step2: Display **Notice** for clear registered.

```
1. RUN This tools at first.  
2. Reboot system to enter Windows mode.  
3. Remove "Protector Suite QL"(include user data), If you had installed.  
4. Clear Fingerprint Registered completely.  
  
Press any key to continue . . .
```

Step3: below information was the utility auto run.

```
C:\>hwtest 0 29 3 1  
Bus 0 Device 29 function 3 port 1  
Sensor Info:  
  FwVersion: 0x04020016.  
  FwMinNextVersion: 0x04020016.  
  FwVariant: 0x200000003.  
  FwFunctionality: 0x0003006F.  
  FwConfig: 0x00030018.  
  Id: 0x00000000.  
  AuthenticateID: 0x00000005.  
  CompanionVendorCode: 0x00020001.  
  SystemID: 0x00030003.  
  SystemName: Toshiba C&D.  
  
main return: 0
```

Step4: Must to reboot system to make the setting effective.

```
**** You must reboot system to make the setting effective ****
**** You must remove FDD before the system reboot ****
ARE YOU reboot system?[Y,N]?
```

Step5: If you choice “Y”, the system will reboot.

If you choice “N”, the system will show Notice again (see be photo). You can press any key to go back test MEMU list.

```
**** You must reboot system to make the setting effective ****
**** You must inset T&D disk1 to FDD before the system reboot ****
Press any key to continue . . .
```

3.20 1st HDD Test

The HDD test allows the user to verify the 1st HDD ok or not. First, please select HDD test method, Screen would display as below:

```
===== HDD TEST =====  
1.HDD W/R test(all surface)  
2.Partial W/R + Random W/R  
[1,2]?
```

After you select the method, then input password: “hard disk”, if input password is Right, the screen would display as below:

```
Input password is Right  
Press any key to Test HDD function  
  
Press any key to continue . . .
```

If input password is wrong, the screen would display as below:

```
Input Password is wrong
ARE YOU INPUT PASSWORD AGAIN?[Y,N]?
```

The screen will display as below picture to show the subtest is passed or failed when finished:

If it is show the picture as below, it means HDD function is OK

```
*** Hard disk test tools V1.50 Compal TTF ***
      HDD  Type = TOSHIBA MK1637GSX
      Serial No. = 57B0FWAS
      Firmware Ver. = DL030M
      Controller Type = 0000

CHR Mode Cylinders=16383
CHR Mode Head=16
CHR Mode Sectors=63
CHR Mode Sizes=8455 MB

LBA Mode Sectors=312581808
LBA Mode Sizes =160042 MB

HDD Random R/W ..... PASS !
HDD Sequential R/W ... PASS !

LBA Verify Sectors: 312581808, C/H/S = 19457 / 255 / 63
LBA Sectors Verify ... PASS!

ARE YOU TEST OK?[Y,N]?
```

If the picture shows as below, it means the HDD function is NG

```
*** Hard disk test tools V1.50 Compal TTF ***
HDD idle fail! --- 10

    HDD Type =
    Serial No. =
    Firmware Ver. =
    Controller Type = 0087

Error ! Can't use Enhanced Disk Drive Support Function
ARE YOU TEST OK?[Y,N]?
```

3.21 2nd HDD Test

The HDD test allows the user to verify the 2nd HDD ok or not. Please select HDD test method, Choice HDD test method, Screen would display as below:

```
===== HDD TEST =====  
1.HDD W/R test(all surface)  
2.Partial W/R + Random W/R  
[1,2]?
```

After you select the method, then input password: “hard disk”, if input password is Right, the screen would display as below:

```
Input password is Right  
Press any key to Test HDD function  
  
Press any key to continue . . .
```

If input password is wrong, the screen would display as below:

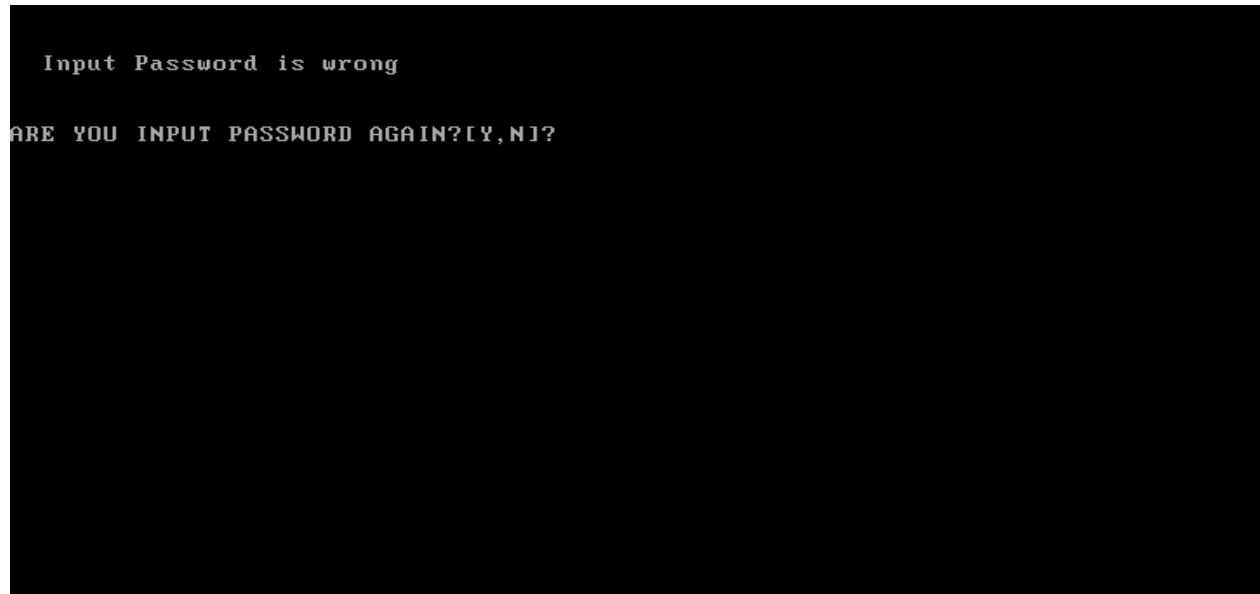

The screen will display as below picture to show the subtest is passed or failed when finished:

If it is show the picture as below, it means HDD function is OK

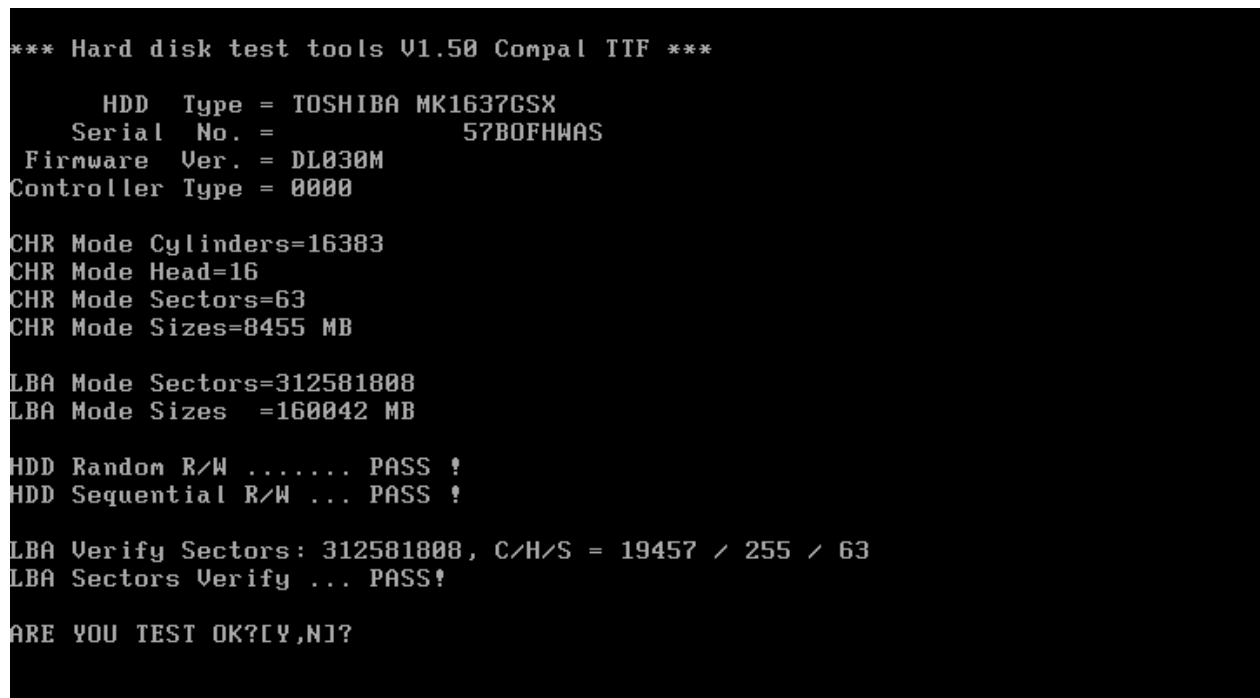

If the picture shows as below, it means he HDD function is NG

```
*** Hard disk test tools V1.50 Compal TTF ***
HDD idle fail! --- 10

    HDD Type =
    Serial No. =
    Firmware Ver. =
Controller Type = 0087

Error ! Can't use Enhanced Disk Drive Support Function
ARE YOU TEST OK?[Y,N]?
```

3.22 Front Edge Logo

Because this Model have Front Edge Logo, must set the Front Edge Logo if the unit has this logo, if you select this item, the figure below will be displayed:

```
=====ISRAE Front Edge Logo led enable/disable TEST=====

please check Front Edge Logo led:

if have,please select enable(1)
if not have,please select disable(2)

1.Enable Front Edge Logo LED
2.Disable Front Edge Logo LED

[1,2]?
```

Please check the units whether have the Front Edge Logo:

If have the logo, please key 1 to set the Front Edge Logo.

If not have the logo, please key 2 to disable the Front Edge Logo.

Please read the notice to check the function is enabling or be disable in BIOS setup menu.

Restart the computer after you change BIOS setting of this function every time.

Notice: Check logo LED on/off function.

1. If we select “2” to disable the Front Edge logo function by program, there haven’t the item of Front Edge Logo in BIOS Menu, the picture likes below.

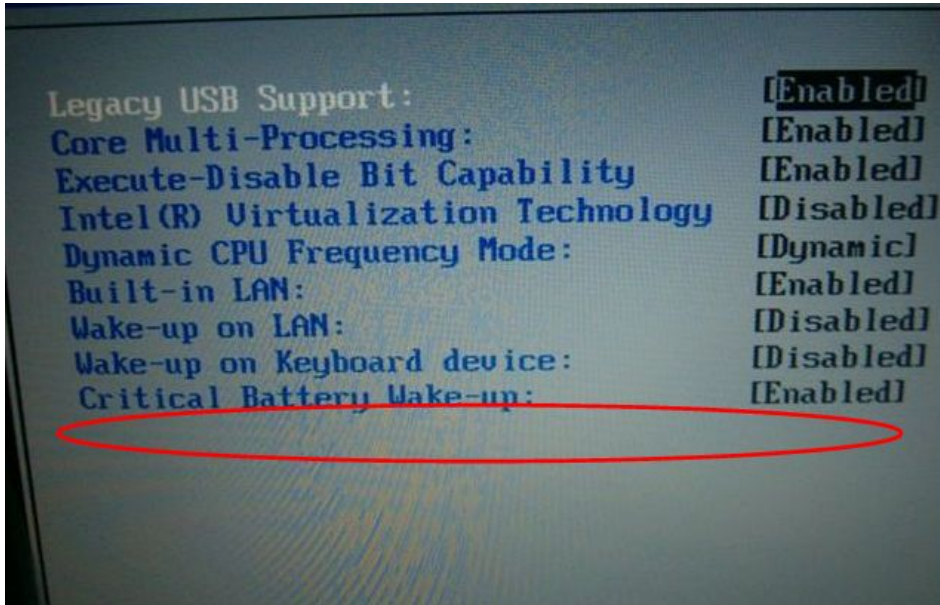

2. If we select “1” to enable the Front Edge logo function by program, There have the item of Front Edge Logo in BIOS Menu.

2.1 Select enable to let the Front Edge logo item in enable mode (show as below picture), and then restart the machine, the Front Edge Logo Led will be light.

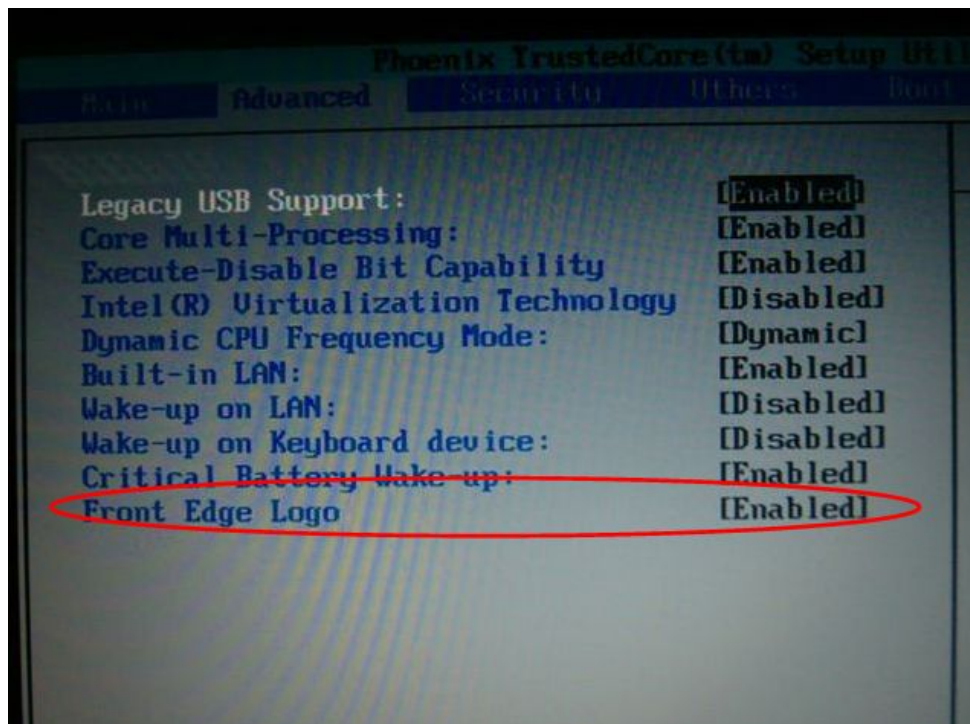

3.23 Write DMI

When you want to write DMI data, please select which data you want to write, the figure below will be displayed:

1. Write OME string
2. Write Version
3. Write Serial
4. Write Product

```
please choice the item
1: Write OEM String
2: Write Version
3: Write Serial
4: Write Product
please enter the num you choose:
```

After write OK, you should reboot the system that can make the setting effective, or you can write next data before reboot system, the figure below will displayed:

```
please choice the item
 1: Write OEM String
 2: Write Version
 3: Write Serial
 4: Write Product
please enter the num you choose: 1
please enter the OEM String: psmadk-011002

Modify OEM String to psmadk-011002

Jump to EEPROM Bank : 0

Erase EEPROM Start Offset : a0 End Offset:dd Size:62
.....
Jump to EEPROM Bank : 0

Flash EEPROM Start Offset : a0
.....
Confirm the data ?
.....
Modify EM String success!

*****Please reboot the system.To make the setting effective
*****Do you want to modify other dmi ? *****
Press Y for Yes or N for No:
```

NOTE: should input correct DMI data, and should reboot the system that can make the setting effective.

3.24 Read DMI

If you want to double check the DMI data, please select Read DMI item, the figure below will be displayed:

```
Manufacturer : TOSHIBA
Product_Name : israa
Serial_Number : *
Version      : 0.2
Asset_Number : *
UUID        : DC11D419D8C111DB9E270016D4346784
OEM_Strings : 1
Are the DMI data is OK? [Y,N]?
```

Chapter 4

Replacement Procedures

Chapter 4 Contents

4.1	General.....	4-1
4.2	Battery.....	4-7
4.3	PC Card.....	4-9
4.4	Memory Card.....	4-11
4.5	HDD.....	4-13
4.6	Expansion Memory.....	4-18
4.7	Modem.....	4-21
4.8	Optical Drive Module.....	4-23
4.9	Optical Drive.....	4-25
4.10	Keyboard.....	4-27
4.11	Display Assembly.....	4-30
4.12	Function Button Board.....	4-34
4.13	Wireless LAN Unit.....	4-36
4.14	Bluetooth.....	4-38
4.15	Top Cover.....	4-39
4.16	Touch Pad.....	4-42
4.17	Fingerprint Module.....	4-44
4.18	Subwoofer Unit and USB Board.....	Error! Bookmark not defined.
4.19	System Board.....	4-46
4.20	System Fan.....	4-49
4.21	VGA PCB.....	4-53
4.22	VGA Board.....	4-49
4.23	Fan and CPU.....	4-55
4.24	Display Mask.....	4-57
4.25	FL Inverter Board.....	4-61
4.26	LCD Module.....	4-iii
4.27	Camera and Microphone.....	4-65

Figures

Figure 4-1	Unlocking the battery lock	4-7
Figure 4-2	Unlocking the battery lock	4-7
Figure 4-3	Removing the PC card.....	4-9
Figure 4-4	Installing the PC card	4-10
Figure 4-5	Pressing the memory card	4-11
Figure 4-6	Removing the memory card	4-11
Figure 4-7	Installing the memory card.....	4-12
Figure 4-8	HDD	4-13
Figure 4-9	Releasing the main HDD door screw	4-13
Figure 4-10	Removing the main HDD door	4-14
Figure 4-11	Removing the main HDD.....	4-14
Figure 4-12	Removing the HDD screws from brackets.....	4-15
Figure 4-13	Releasing the secondary HDD door screw.....	4-16
Figure 4-14	Removing the secondary HDD door	4-16
Figure 4-15	Removing the secondary HDD.....	4-17
Figure 4-16	Releasing the cover screw	4-18
Figure 4-17	Removing the expansion memory module cover.....	4-18
Figure 4-18	Releasing the expansion memory module.....	4-19
Figure 4-19	Removing the expansion memory module.....	4-19
Figure 4-20	Removing the modem module screws.....	4-21
Figure 4-21	Removing the modem connector.....	4-21
Figure 4-22	Removing the modem module	4-22
Figure 4-23	Removing the optical drive screw	4-23
Figure 4-24	Removing the optical drive	4-23
Figure 4-25	Removing the optical drive bracket.....	4-25
Figure 4-26	Removing the keyboard cover.....	4-27
Figure 4-27	Removing the keyboard cover.....	4-27
Figure 4-28	Removing the keyboard screws.....	4-28
Figure 4-29	Disconnecting the keyboard cable.....	4-28
Figure 4-30	Disconnecting cables.....	4-30
Figure 4-31	Removing the strip cover	4-31

Figure 4-32	Removing the rear screws	4-31
Figure 4-33	Removing the front screws	4-32
Figure 4-34	Removing the display assembly.....	4-32
Figure 4-35	Removing the function button board screw	4-34
Figure 4-36	Sliding out the function button board	4-34
Figure 4-37	Removing the function button board	4-34
Figure 4-38	Removing the wireless LAN unit screws.....	4-36
Figure 4-39	Removing the wireless LAN card.....	4-36
Figure 4-40	Disconnecting the Bluetooth cable	4-38
Figure 4-41	Removing the Bluetooth module	4-38
Figure 4-42	Removing the top cover (back panel screws)	4-39
Figure 4-43	Removing the cables	4-40
Figure 4-44	Removing the top cover (front panel screws).....	4-40
Figure 4-45	Removing the top cover	4-40
Figure 4-46	Removing the touch pad screw	4-42
Figure 4-47	Disconnecting the touch pad FFC cable	4-42
Figure 4-48	Removing the Touch Pad.....	4-43
Figure 4-49	Removing the fingerprint module bracket screws	4-44
Figure 4-50	Removing the fingerprint module bracket	4-44
Figure 4-51	Removing the fingerprint module	4-45
Figure 4-52	Removing the subwoofer screws	4-v
Figure 4-53	Disconnecting the USB board cable and subwoofer cable	4-v
Figure 4-54	Removing the subwoofer unit.....	4-v
Figure 4-55	Removing the USB board screw	4-v
Figure 4-56	Removing the USB board	4-v
Figure 4-57	Removing the fan screws	4-v
Figure 4-58	Removing the fan.....	4-v
Figure 4-59	Removing the VGA PCB FFC cable	4-v
Figure 4-60	Removing the VGA PCB screw and the hexagonal screws	4-v
Figure 4-61	Removing the VGA PCB.....	4-v
Figure 4-62	Removing the system board screws.....	4-v
Figure 4-63	Removing the DC power cable	4-v

Figure 4-64	Removing the system board	4-vi
Figure 4-65	Removing the VGA board screws.....	4-vi
Figure 4-66	Removing the VGA board.....	4-vi
Figure 4-67	Removing the VGA heat sink	4-vi
Figure 4-68	Removing the heat sink screws	4-vi
Figure 4-69	Removing the heat sink	4-vi
Figure 4-70	Removing the fan connector and screws.....	4-vi
Figure 4-71	Removing the fan	4-vi
Figure 4-72	Turning the CPU cam.....	4-vi
Figure 4-73	Removing the CPU.....	4-vi
Figure 4-74	Removing the display mask screws.....	4-vi
Figure 4-75	Removing the display mask screws.....	4-vi
Figure 4-76	Removing the FL inverter board screws	4-vi
Figure 4-77	Removing the connectors	4-vi
Figure 4-78	Removing the FL inverter board	4-vi
Figure 4-79	Removing the LCD module screws.....	4-vi
Figure 4-80	Removing the LCD Module	4-vi
Figure 4-81	Removing the bracket screws.....	4-vi
Figure 4-82	Removing the LVDS cable.....	4-vi
Figure 4-83	Removing the CMOS cable.....	4-vi
Figure 4-84	Removing the camera module.....	4-vi
Figure 4-85	Removing the microphone	4-vi

4.1 General

This chapter explains how to disassemble the computer and replace Field Replaceable Units (FRUs). It may not be necessary to remove all the FRUs in order to replace one. The chart below is a guide to which FRUs need to be removed in order to remove others. Always start by removing the battery pack, next, optional items such as the optional PC Card or memory card, and then follow the chart downward removing only those FRUs necessary to reach the one you think is causing the computer to operate abnormally. Refer to the example on the following page.

Battery pack					
HDD	Expansion Memory Module	Keyboard			Modem
ODD		Function Button Board	Bluetooth Module	Display Assembly	
Top Cover				Display Mask	
Touch Pad	Fingerprint Module	Speakers	Wireless LAN Module	FL Inverter Board	
Subwoofer	USB Board	System Fan	System Board	Camera and Microphone	LCD Module
VGA Board		Heat Sink			
Fan		CPU			

The example below shows FRUs to be removed before the CPU can be removed. The CPU is located on the system board. The system board itself is located under the top cover. The keyboard is on top of the top cover, along with the Bluetooth module, and the strip cover and must be removed. The HDD, expansion memory module, ODD, modem, and display assembly in turn need to be removed. Always start the disassembly process by removing the battery pack and optional devices and then move downwards through the table to access the required component.

Battery pack					
HDD	Expansion Memory Module	Keyboard			Modem
ODD		Function Button Board	Bluetooth Module	Display Assembly	
Top Cover				Display Mask	
Touch Pad	Fingerprint Module	Speakers	Wireless LAN Module	FL Inverter Board	
Subwoofer	USB Board	System Fan	System Board	Camera and Microphone	LCD Module
VGA Board		Heat Sink			
Fan		CPU			

Safety Precautions

Before you begin disassembly, read the following safety precautions and observe them carefully as you work.

DANGER:

1. *Always use the lithium ion battery pack or backup battery that is authorized by Toshiba or compatible with the unit. Since other battery packs have different specifications, they may be incompatible with the unit, and may burst or explode. Heating or disassembling the battery pack could cause leakage of alkaline solution. Throwing the battery pack into a fire could cause the battery pack to explode.*
2. *The power supply, FL inverter, and other components carry high voltages. To avoid the risk of electric shock when you need to turn on the power of a partially disassembled computer to check its operation, be very careful not to touch connectors or components. Also, do not disassemble individual components in first-level maintenance.*

WARNING: To avoid the risk of electric shock or other injury

1. *Always turn the power off and disconnect the AC adaptor from the power source.*
2. *Remove any metal jewelry or accessories such as necklaces, bracelets, or rings. Batteries in the computer retain an electrical charge so there is danger of electrical shock even when the computer is disconnected from an AC power source.*
3. *Never work with wet or damp hands.*
4. *The computer contains sharp edges and corners: be careful not to injure yourself.*
5. *Make sure that all replacement components meet the specifications for the computer and that all cables and connectors are securely fastened.*

CAUTION: To avoid damage to the computer

1. *When you change a component, be sure the replacement component meets the required specifications. Never use foreign parts.*
2. *Metal objects such as screws or paper clips which fall into the unit can cause a short-circuit, fire, or other internal damage.*
3. *When assembling the computer, make sure you use the correct screws to secure the various pieces in place. Screw sizes are listed in their corresponding figure. Make sure all screws are securely fastened. Loose screws can cause short circuits, resulting in heat, smoke, or fire.*
4. *Before removing an FRU or other component, make sure all cables to the component have been disconnected.*
5. *If you use AC power, be sure to use the cable that came with the computer or one recommended by Toshiba.*

Before You Begin

Look over the procedures in this section before you begin disassembling the computer. Familiarize yourself with the disassembly and reassembly steps. Begin each procedure by removing the AC adaptor and the battery pack as instructed in section 4.2.

1. Do not disassemble the computer unless it is operating abnormally.
2. Use only the correct and approved tools.
3. Make sure the working environment is free from the following elements whether you are using or storing the computer.
 - Dust and contaminants
 - Static electricity
 - Extreme heat, cold, and humidity
4. Make sure the FRU you are replacing is causing the abnormal operation by performing the necessary troubleshooting and diagnostics tests described in chapters 2 and 3 of this manual.
5. Do not perform any operations that are not necessary and use only the described procedures for disassembling and installing FRUs in the computer.
6. After removing parts from the computer, place them in a safe place away from the computer so they will not be damaged and will not interfere with your work.
7. You will remove and replace many screws when you disassemble the computer. When you remove screws, make sure they are placed in a safe place and identified with the correct parts.
8. When assembling the computer, make sure you use the correct screws to secure the various pieces. Screw sizes are listed in their corresponding figures.
9. The computer contains many sharp edges and corners, so be careful not to injure yourself.
10. After you have replaced an FRU, make sure the computer is functioning properly by performing the appropriate test on the FRU you have fixed or replaced.

Disassembly Procedures

The computer has two basic types of cable connectors:

- Pressure Plate connectors
- Standard Pin connectors

To disconnect a Pressure Plate connector, lift up the tabs on either side of the connector's plastic pressure plate and slide the cable out of the connector. To connect the cable to a Pressure Plate connector, make sure the pressure plate is fully lifted and slide the cable into the connector. Secure the cable in place by pushing the sides of the pressure plate down so the plate is flush with the sides of the connector. Gently pull on the cable to make sure the cable is secure. If you pull out the connector, connect it again making sure the connector's pressure plate is fully lifted when you insert the cable.

Standard pin connectors are used with all other cables. These connectors can be connected and disconnected by simply pulling them apart or pushing them together.

Assembly Procedures

After you have disassembled the computer and fixed or repaired the problem that was causing the computer to operate abnormally, you will need to reassemble the computer.

Install all the removed FRUs following the steps described in the corresponding sections in this chapter.

While assembling the computer, remember the following general points:

- Take your time, making sure you follow the instructions closely. Most problems arise when you are assembling the computer in a hurry.
- Make sure all cables and connectors are securely fastened.
- Before securing the FRU or other parts, make sure that no cables are pinched by screws or the FRUs.
- Check that all latches are closed securely.
- Make sure all the correct screws are used to secure all FRUs. Using the wrong screw can either damage the threads on the screw or the head of the screw and may prevent proper seating of an FRU.

After installing an FRU in the computer, confirm that the FRU and the computer are functioning properly.

Tools and Equipment

The use of Electrostatic Discharge (ESD) equipment is very important for your safety and the safety of those around you. Proper use of these devices will increase the success rate of your repairs and lower the cost for damaged or destroyed parts. The following equipment is necessary to disassemble and reassemble the computer:

- One M2 Phillips screwdriver to remove and replace screws.
- One T8 security screwdriver.
- Tweezers, to lift out screws that you cannot grasp with your fingers.
- ESD mats for the floor and the table you are working on.
- ESD wrist strap or heel grounder.
- Anti-static carpeting or flooring.
- Air-ionizers in highly static sensitive areas.

4.2 Battery

Removing the Battery Pack

To remove the battery pack from the battery bay, follow these steps:

1. Turn the computer upside down.
2. Unlock the battery compartment lock.

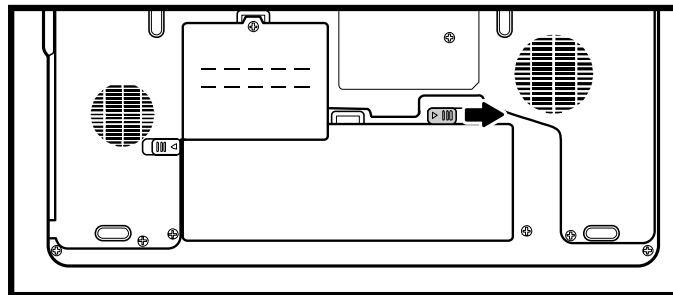

Figure 4-1 Unlocking the battery lock

3. Slide the battery bay latch to release the battery pack and then remove the battery pack from the bay.

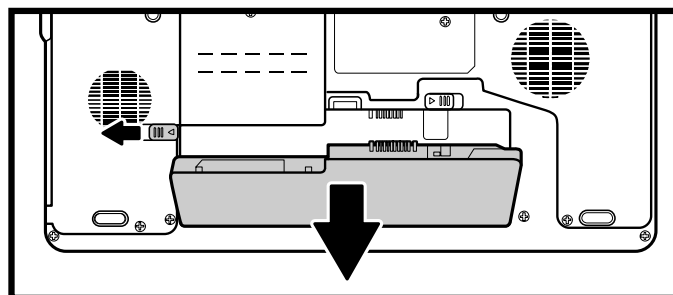

Figure 4-2 Unlocking the battery lock

NOTE: For environmental reasons, do not throw away a spent battery pack. Please return spent battery packs to Toshiba.

Installing the Battery Pack

To install the battery pack in the battery bay, follow the steps below and refer to the figures in the preceding section.

WARNING: *The battery is a lithium ion battery and can explode if not properly replaced, used, handled or disposed of. Use only batteries recommended by Toshiba as replacements.*

1. Slide the battery pack into the battery bay. The battery bay latch clicks into place automatically.
2. Lock the battery double lock to secure the battery pack in position.

4.3 PC Card

Removing a PC Card

To remove a PC Card, follow the steps below:

1. Click the Safely Remove Hardware icon on the Task Bar.
2. Click the PC Card you want to remove.
3. Push the PC card's eject button. The button pops out when you release it.
4. Push the eject button again to pop the PC card out slightly.
5. Grasp the PC card and pull it out from the slot.

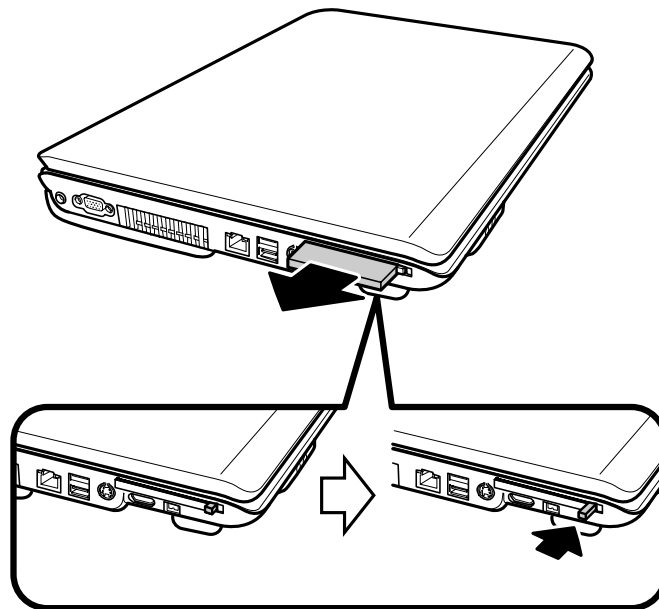

Figure 4-3 Removing the PC card

6. Press the eject button back into place, if necessary.

Installing the PC Card

To insert a PC card, follow the steps below:

1. Make sure the eject button does not stick out. Push it back into place if required.
2. Insert the PC card in the slot and gently press to ensure a firm connection.

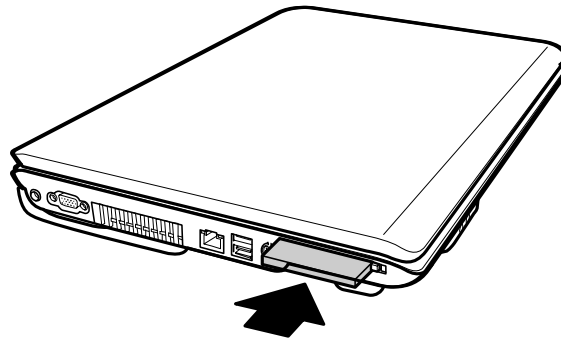

Figure 4-4 Installing the PC card

4.4 Memory Card

Removing a Memory Card

To remove a memory card, follow the steps below:

1. Press the memory card gently into the socket until it pops out.

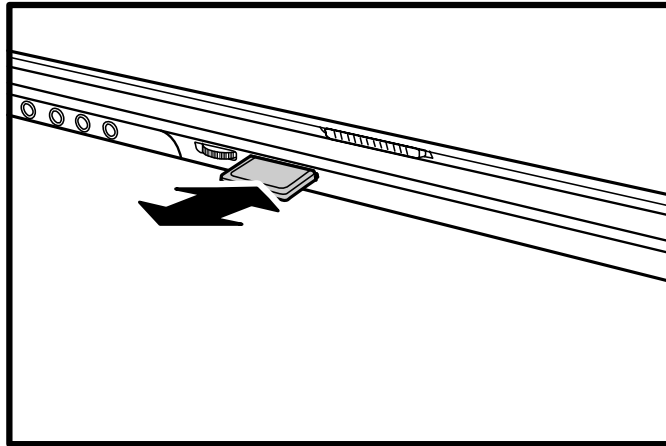

Figure 4-5 Pressing the memory card

2. Grasp the memory card and remove it.

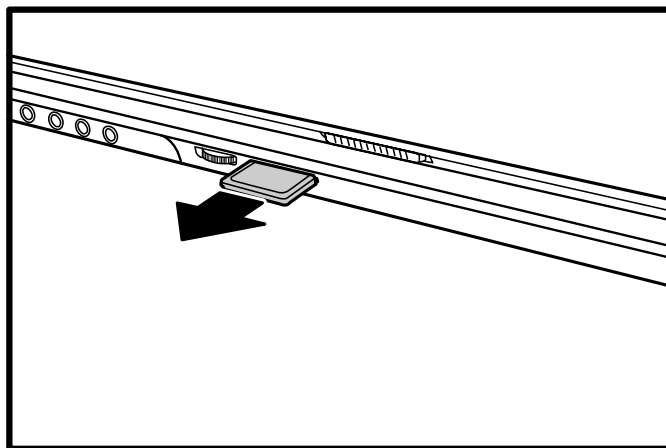

Figure 4-6 Removing the memory card

Inserting the Memory Card

To insert the memory card, follow the steps below:

1. Insert the memory card in the slot and gently press to ensure a firm connection.

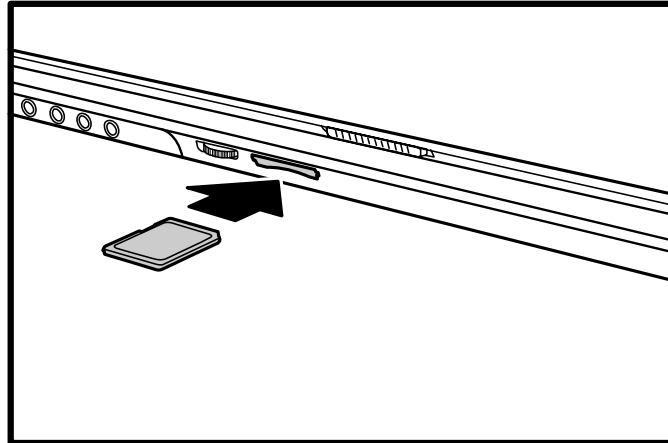

Figure 4-7 Installing the memory card

4.5 HDD

CAUTION: When handling the HDD, do not press the top surface. Hold the disk by the sides to prevent damage and loss of data.

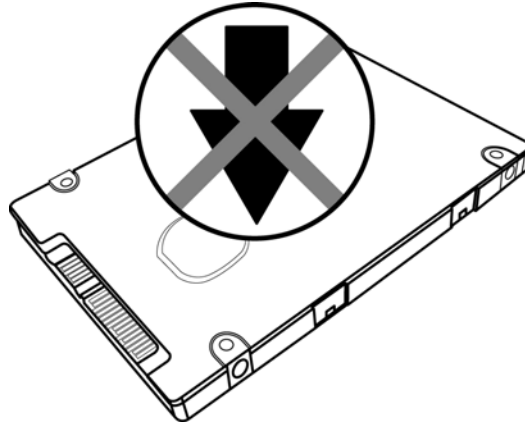

Figure 4-8 HDD

Removing the Main HDD

The Dual HDD feature makes it easy to handle demanding applications while running background applications such as system backup and virus scans.

Follow the steps below to remove the main HDD module:

1. Turn the computer upside down.
2. Remove the black M2.5x4 screw to release the main HDD door.

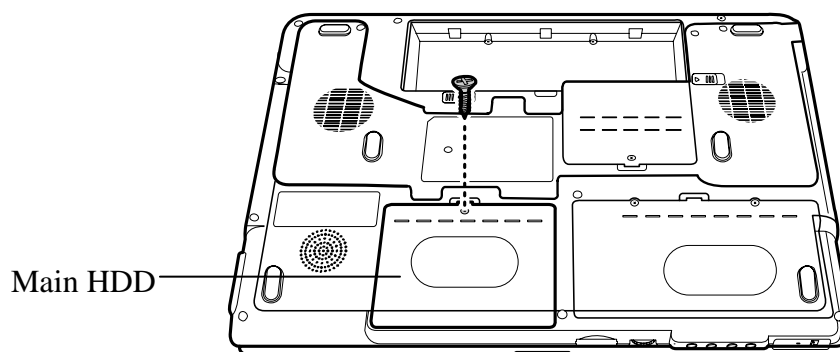

Figure 4-9 Releasing the main HDD door screw

3. Pull up and lift the HDD door to remove it.

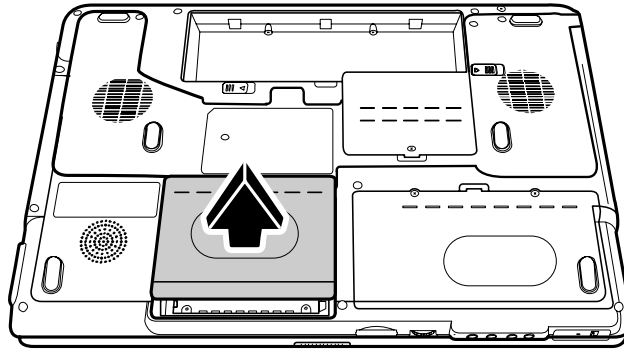

Figure 4-10 Removing the main HDD door

4. Pull out the black Mylar tab to remove the HDD unit.

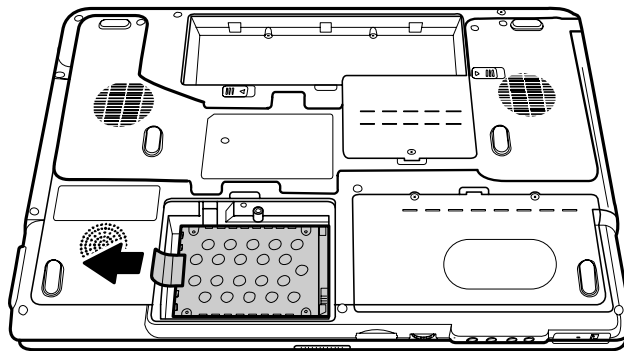

Figure 4-11 Removing the main HDD

5. Pull the HDD outwards and remove the four silver M3x3 screws that secure the HDD case and brackets to the HDD.

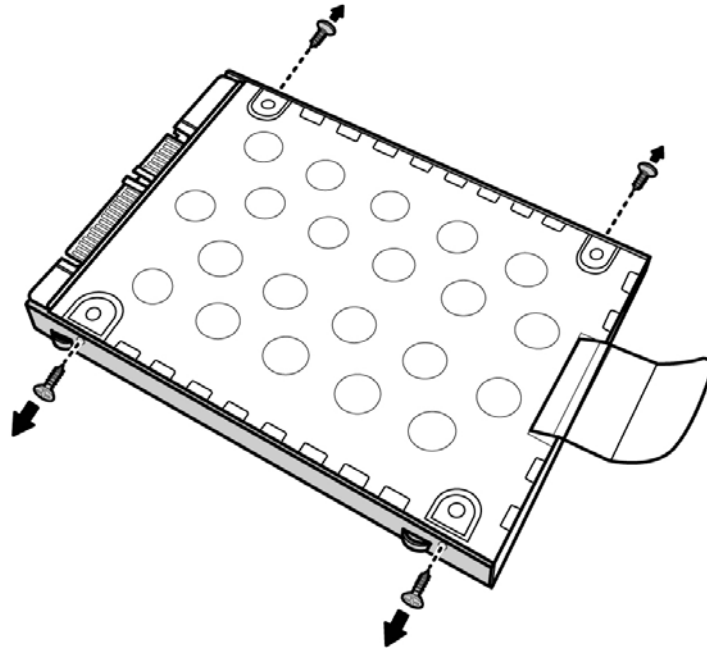

Figure 4-12 Removing the HDD screws from brackets

6. Remove the HDD from the HDD case.

Removing the Secondary HDD

Follow the steps below to remove the second HDD module:

1. Turn the computer upside down.
2. Release the two black M2.5x4 screws to release the secondary HDD door.

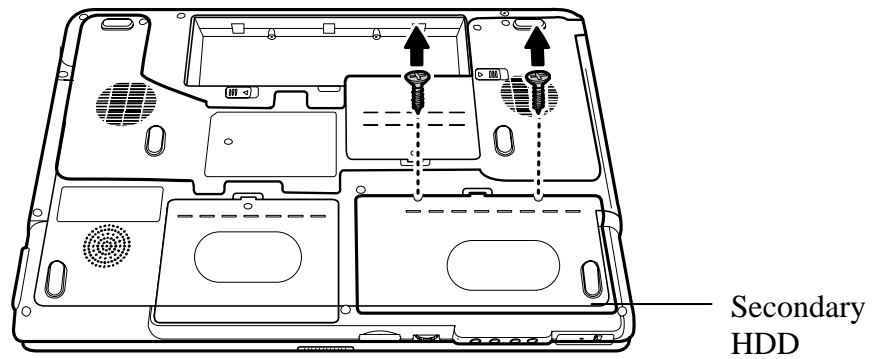

Figure 4-13 Releasing the secondary HDD door screw

3. Pull up and lift the HDD door to remove it.

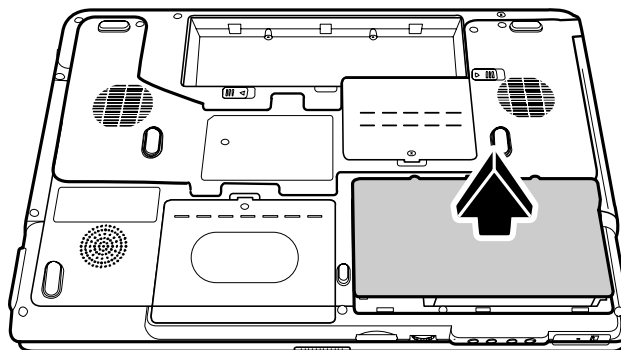

Figure 4-14 Removing the secondary HDD door

4. Pull out the black Mylar tab to remove the HDD unit.

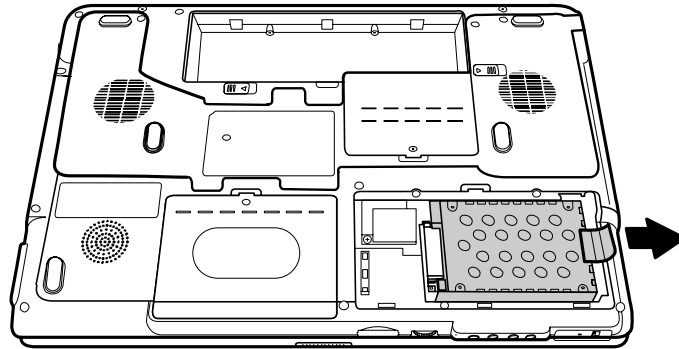

Figure 4-15 Removing the secondary HDD

5. Pull the HDD outwards and remove the four silver M3x3 screws that secure the HDD case and brackets to the HDD.
6. Remove the HDD from the HDD case.

Installing the Main HDD

To install the main HDD, follow these steps and refer to the figures in the preceding section.

1. Seat the main HDD in the HDD case and brackets, and secure it with four silver M3x3 screws.
2. Insert the main HDD unit into the HDD slot on the left.
3. Secure the HDD door with one black M2.5x4 screw.

Installing the Secondary HDD

To install the secondary HDD, follow these steps and refer to the figures in the preceding section.

1. Seat the secondary HDD in the HDD case and brackets, and secure it with four silver M3x3 screws.
2. Insert the secondary HDD unit into the HDD slot on the right.
3. Secure the HDD door with two black M2.5x4 screws.

4.6 Expansion Memory

Removing the Expansion Memory Module

To remove the memory module, make sure the computer is in boot mode. Remove the battery pack, cables and any optional devices before you start and then follow these steps:

1. Release the black non-separate screw M2.5x6.5 screw securing the memory module socket cover.

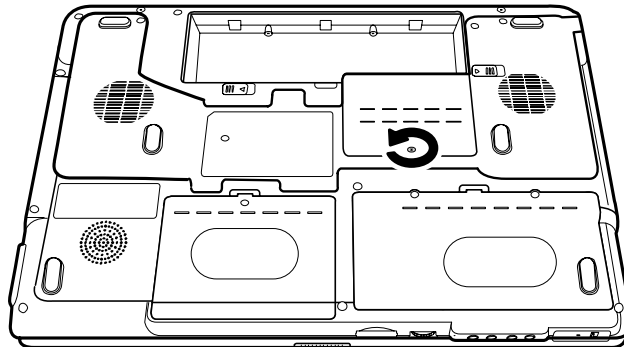

Figure 4-16 Releasing the cover screw

2. Slide your fingernail or a thin object under the cover and lift it off.

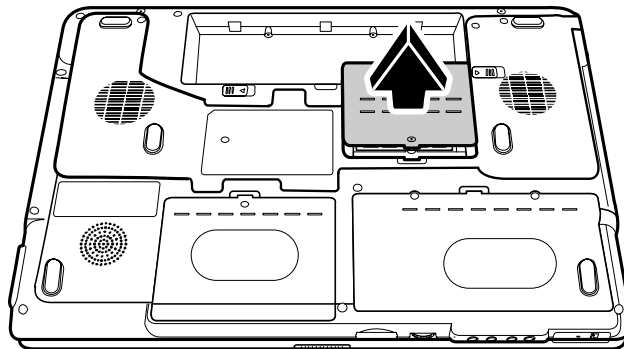

Figure 4-17 Removing the expansion memory module cover

3. Push the latches to release the memory module. A spring will force one end of the module up.

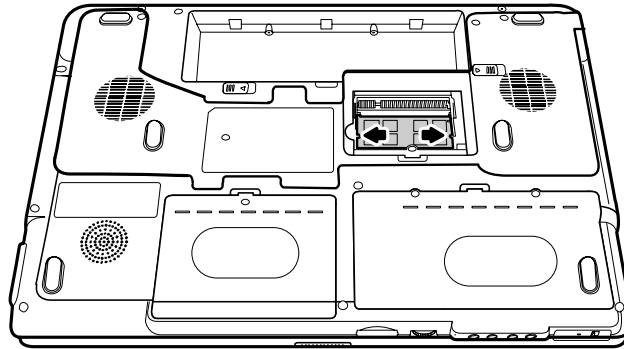

Figure 4-18 Releasing the expansion memory module

4. Grasp the module and pull it out.

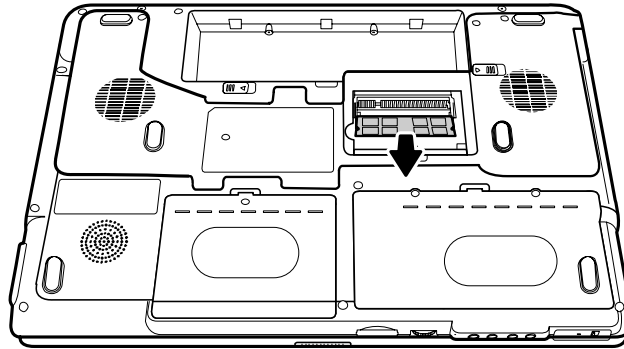

Figure 4-19 Removing the expansion memory module

5. Repeat steps 3 and 4 to remove the second memory expansion module in the same way.

CAUTION: Do not touch the connectors on the expansion memory module or on the computer. Debris on the connectors may cause memory access problems.

Installing the Expansion Memory

CAUTION: Do not touch the connectors on the expansion memory module or on the computer. Debris on the connectors may cause memory access problems.

To install a memory module, follow these steps and refer to the figures in the preceding section.

1. Set the computer to boot mode and turn off the power.
2. Remove the black non-separate screw with RAM door M2.5x6.5 screw securing the memory module socket cover.
3. Slide your fingernail or a thin object under the cover and lift it off.
4. Fit the module's connectors into the computer's connectors at about a 45-degree angle and press the module carefully to ensure a firm connection.
5. Push the module down so it lies flat. The latches on either side will click into place to secure the module.
6. Seat the cover and secure its screw.

CAUTION: The Slot A is reserved for main memory, the upper slot. Use the slot B for expanded memory, the bottom slot. If only one card is installed, use the slot A.

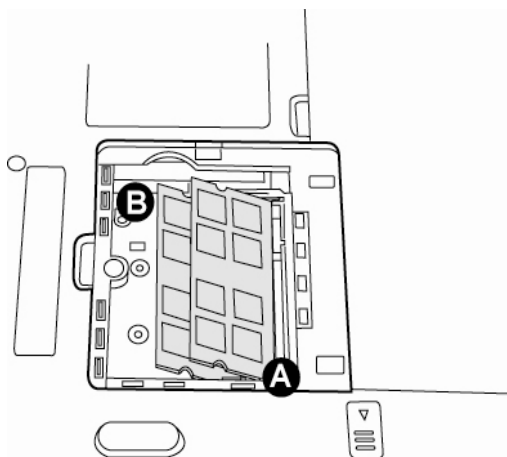

4.7 Modem

Removing the Modem

Remove the battery and any optional devices before removing the modem as described in the following instructions:

1. Remove the secondary HDD door.
2. Remove the two black M2.5x3 screws securing the modem to the chassis.

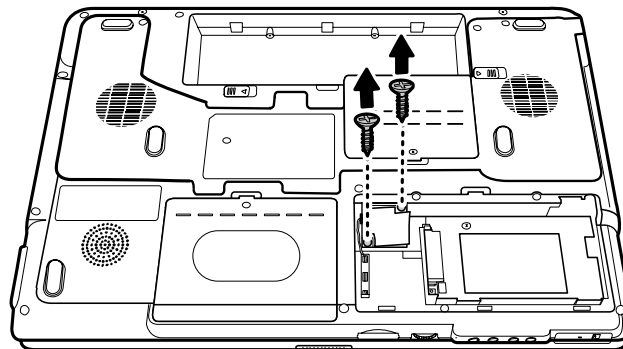

Figure 4-20 Removing the modem module screws

3. Disconnect the modem connector from the modem module.

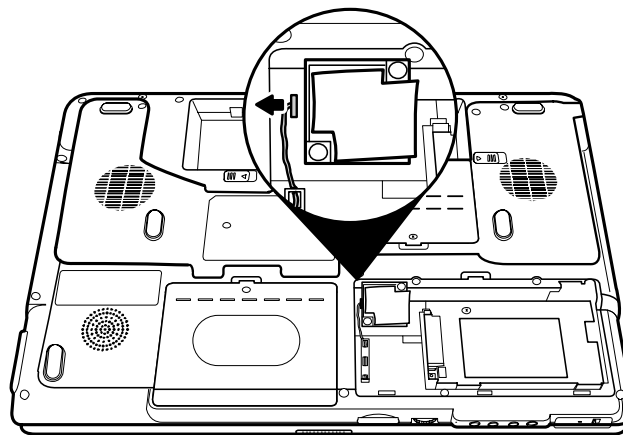

Figure 4-21 Removing the modem connector

4. Carefully lift the unit from its connector.

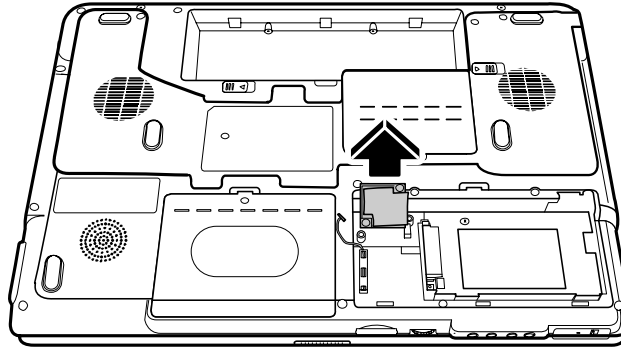

Figure 4-22 Removing the modem module

Installing the Modem

To install a modem, follow the steps below and refer to the figures in the preceding section.

1. Connect the modem connector on the system board to the modem module.
2. Fit the modem onto its connector and secure it with two black M2.5x3 screws.
3. Replace the M2.5x4 screw to fix the secondary HDD cover.

4.8 Optical Drive Module

Removing the Optical Drive Module

To remove the optical drive module, you need to remove the secondary HDD cover first as described in the previous section. Follow the steps below:

1. Turn the computer upside down.
2. Remove the battery and the secondary HDD cover.
3. Remove the black M2.5x8 screw securing the optical drive module.

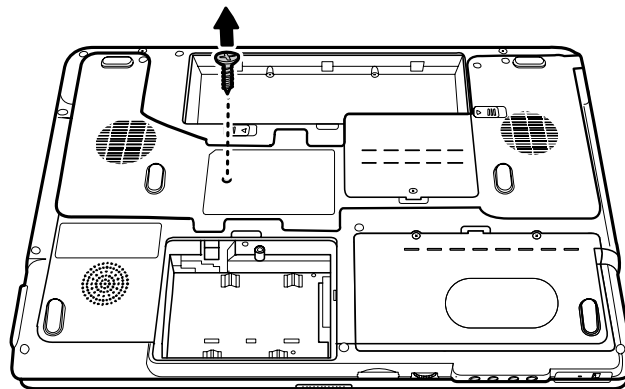

Figure 4-23 Removing the optical drive screw

4. Use your hand to push the module bracket and then slide the module from the bay.

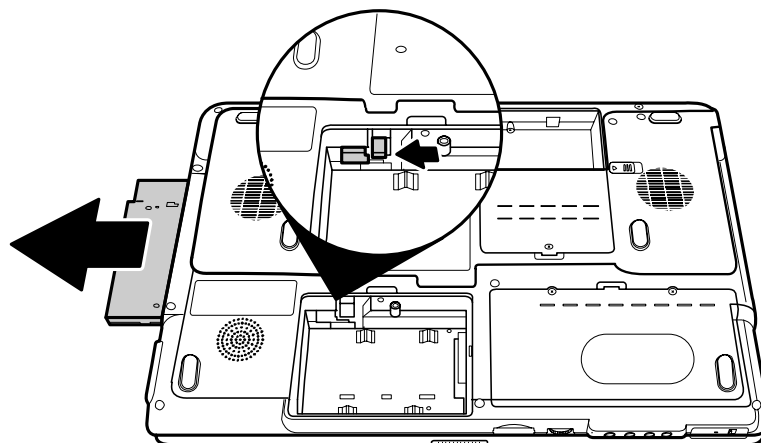

Figure 4-24 Removing the optical drive

Installing the Optical Drive Module

To install a device in the optical drive module bay, follow the steps below and refer to the figure in the preceding section.

1. Slide the device into the optical drive module bay.
2. Use the black M2.5x8 screw to secure the optical drive module.

4.9 Optical Drive

This computer may be fitted with a:

- DVD-ROM device
- CD-RW/DVD-ROM combo device
- DVD Super Multi device

Disassembling the Optical Drive

To disassemble the optical drive, first remove the drive from its module bay as described in the previous section.

Next, release the two M2x2.5 screws from the bracket plate and remove the bracket plate.

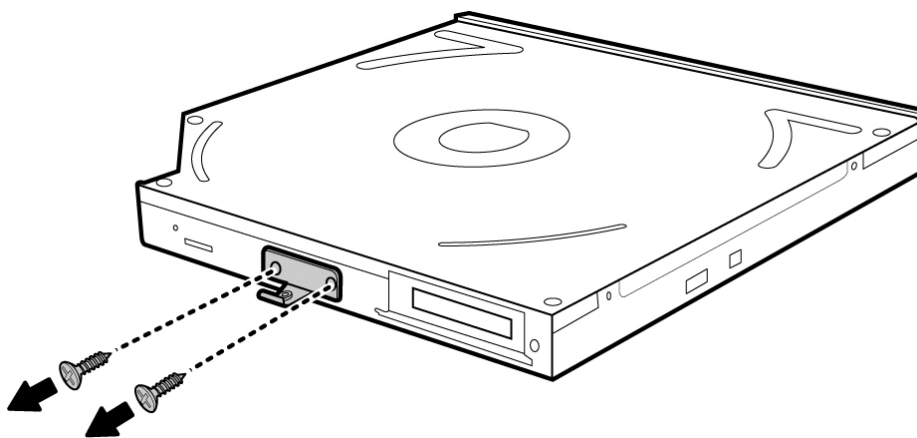

Figure 4-25 Removing the optical drive bracket

NOTE: The small arrow shown on the metal bracket indicates the top side of the optical bracket. Keep this in mind when removing or installing the drive.

Reassembling the Optical Drive

NOTE: *The small arrow shown on the metal bracket indicates the top side of the optical bracket. Keep this in mind when removing or installing the drive.*

To reassemble an optical drive, follow the steps below and refer to the figure in the preceding section.

1. Position the optical drive bracket plate so that it is aligned with the rear panel of optical drive.
2. Secure the optical drive bracket plate with two M2x2.5 screws.
3. Install the optical drive module into the bay as described in the preceding section.

4.10 Keyboard

Removing the Keyboard

Follow the steps below to remove the keyboard:

1. Open the display panel.
2. Insert a thin tool into the gap between the keyboard cover and keyboard to lever the keyboard cover up.

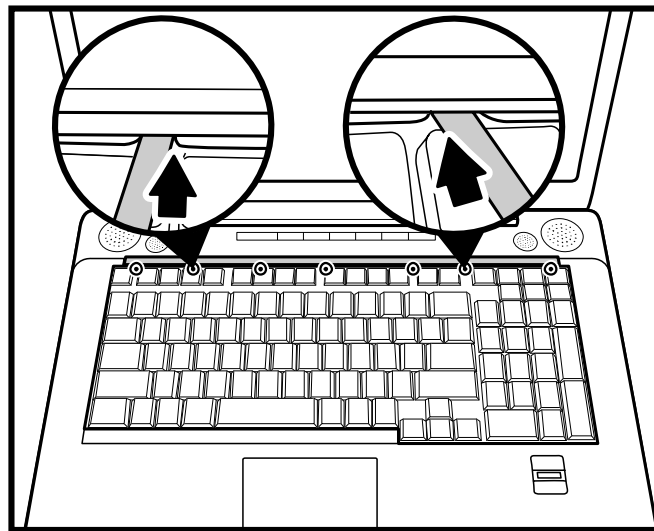

Figure 4-26 Removing the keyboard cover

3. Remove the keyboard cover.

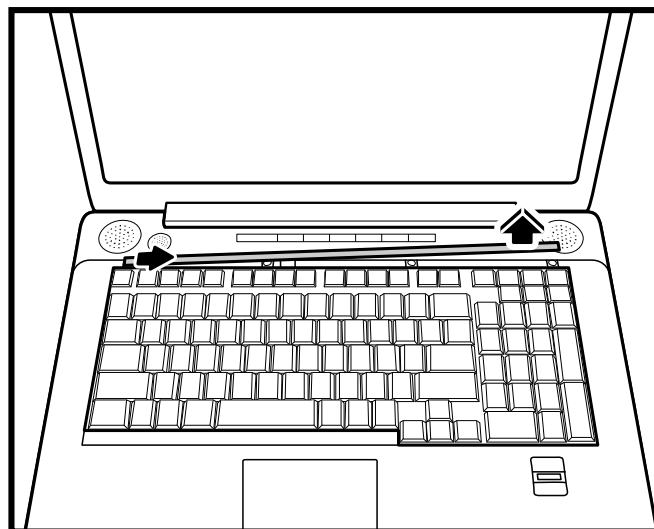

Figure 4-27 Removing the keyboard cover

4. Remove four black M2x4 screws securing the keyboard.

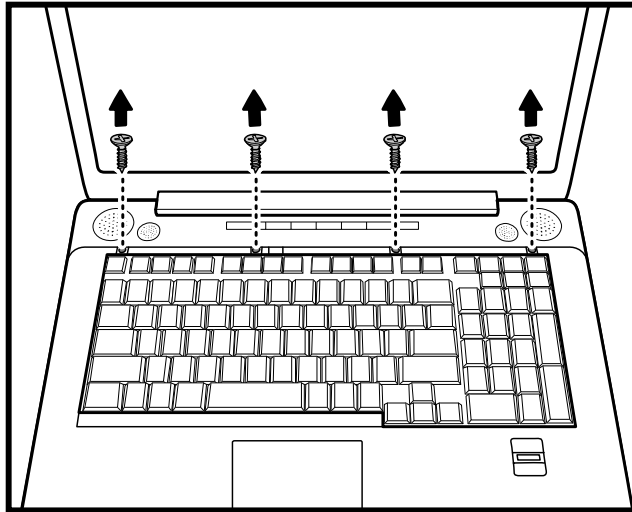

Figure 4-28 Removing the keyboard screws

5. Slide the keyboard forward to lift it out, revealing the keyboard cable underneath. Disconnect the keyboard cable and remove the keyboard.

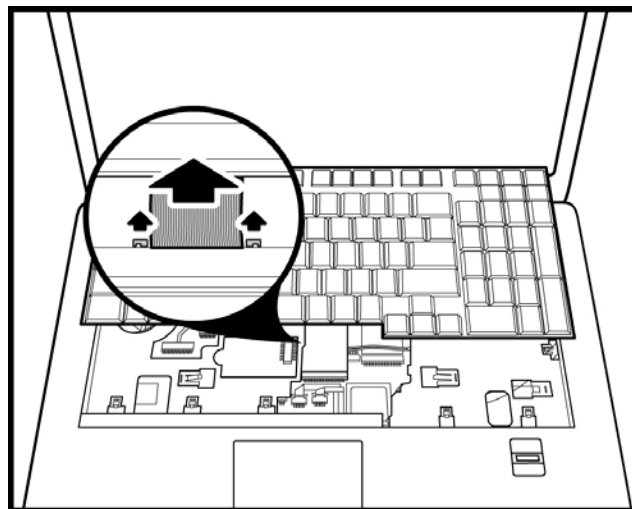

Figure 4-29 Disconnecting the keyboard cable

Installing the Keyboard

To install the keyboard, follow the steps below and refer to the figures in the preceding section.

1. Connect the keyboard cable to the system board.
2. Set the keyboard in place and secure it with four black M2x4 screws.
3. Set the keyboard cover in place and press down to secure the keyboard cover until the latches engage.

4.11 Display Assembly

Removing the Display Assembly

To remove the display assembly, first remove the battery, keyboard, and any optional devices. Then follow the steps below:

1. Disconnect the LVDS cable, function button board cable, wireless LAN antennas, CMOS cable, and microphone cable from the system board.

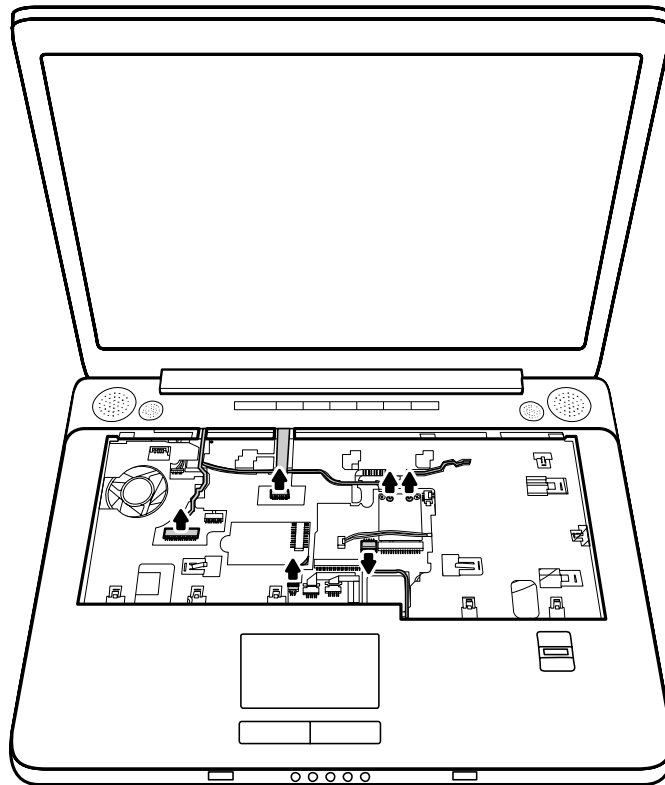

Figure 4-30 Disconnecting cables

2. Remove the strip cover from the computer chassis.

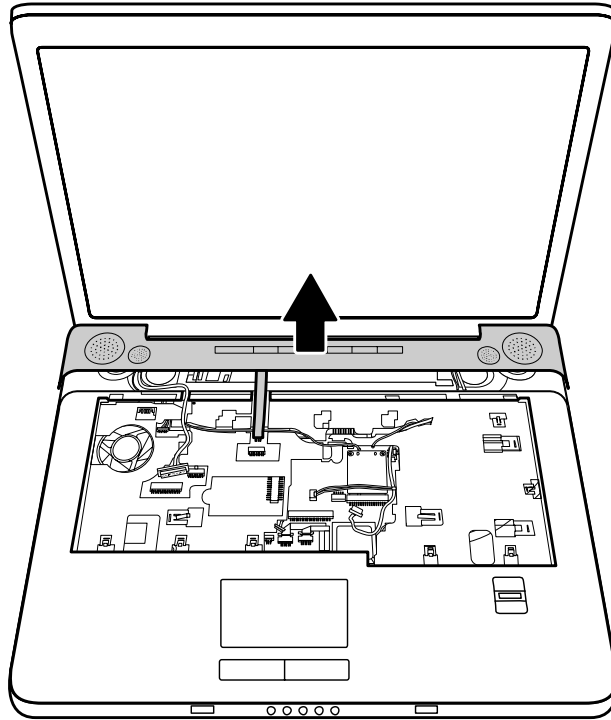

Figure 4-31 Removing the strip cover

3. Remove two M2.5x8 black screws securing the LCD assembly from the rear side.

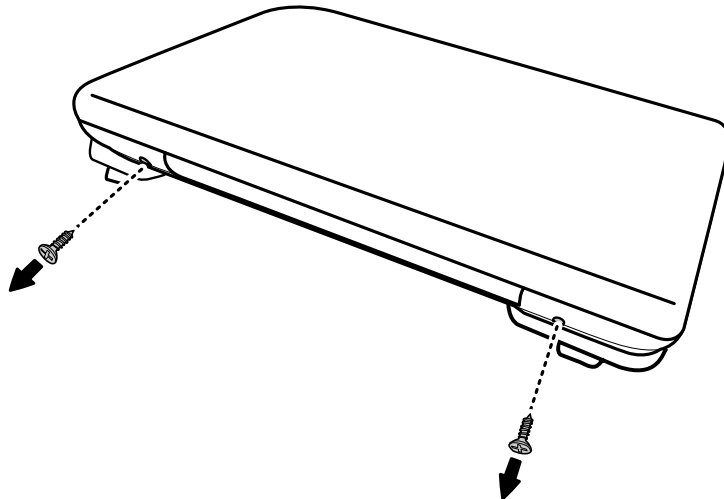

Figure 4-32 Removing the rear screws

4. Remove two M2.5x8 screws securing the LCD assembly to the top cover.

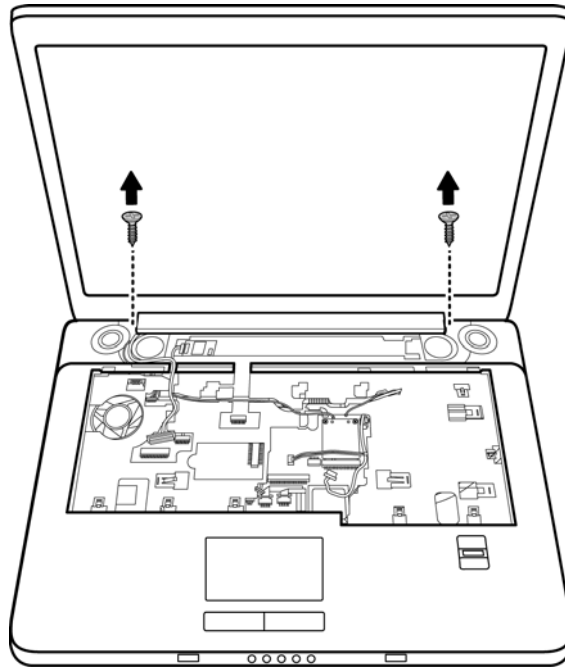

Figure 4-33 Removing the front screws

5. Remove the LCD assembly.

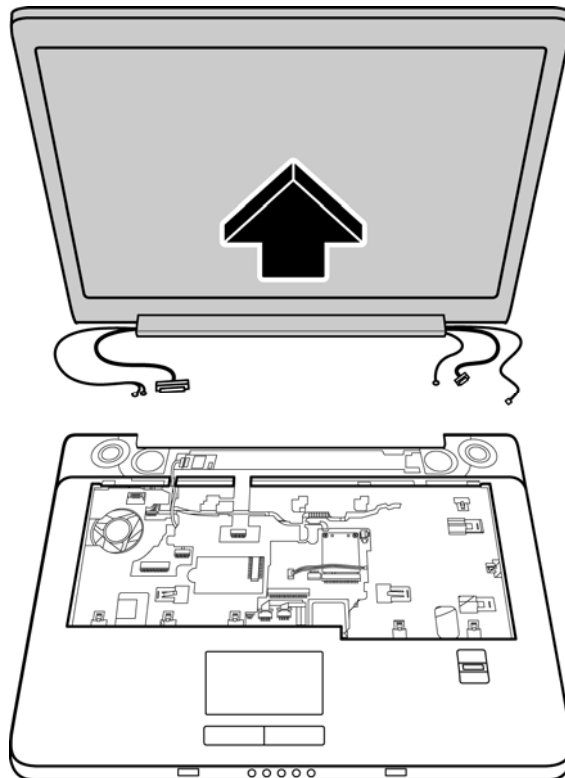

Figure 4-34 Removing the display assembly

Installing the Display Assembly

To install the display assembly, follow the steps below and refer to the figures in the preceding section.

1. Seat the display assembly, taking care not to crush to the LVDS cable or wireless LAN antenna connectors.
2. Secure two M2.5x8 black screws to each hinge to connect the assembly on the top cover.
3. Secure two M2.5x8 black screws to the computer's rear side. They hold the display assembly in place.
4. Replace the strip cover.
5. Connect the LVDS cable, function button board cable, wireless LAN antennas, CMOS cable, and microphone cable to their respective sockets on the system board.

4.12 Function Button Board

Removing the Function Button Board

The function button board is located on the back side of the strip cover. First remove the button panel from the top chassis as described in the previous section. Then follow the steps below:

1. Turn the strip cover over.
2. Remove the M2.5x4 screw securing the function button board to the panel.

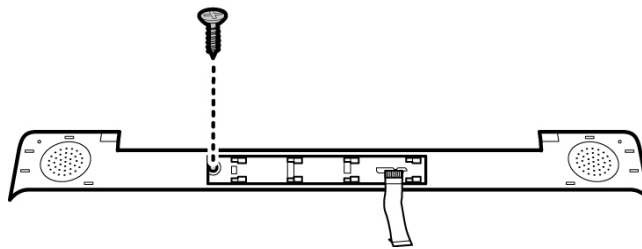

Figure 4-35 Removing the function button board screw

3. Slide out the function button board in direction of the arrow.

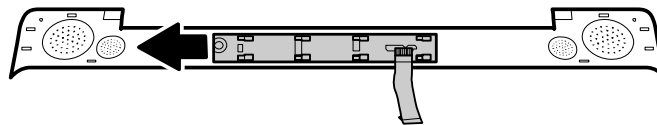

Figure 4-36 Sliding out the function button board

4. Lift the function button board up.

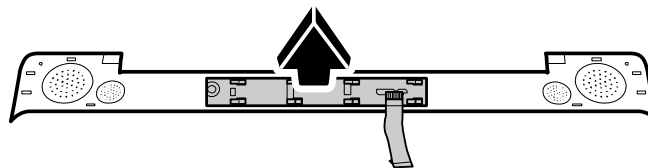

Figure 4-37 Removing the function button board

Installing the Function Button Board

To install the function button board, follow the steps below and refer to the figures in the preceding section.

1. Set the function button board in place.
2. Secure the board with one M2.5x4 screw.
3. Turn the strip cover over and replace it on the top chassis.
4. Connect the other end of the FCC cable to the connector on the system board.

4.13 Wireless LAN Unit

Removing the Wireless LAN Unit

To remove wireless LAN unit, first remove the keyboard and the wireless LAN antennas as described in the previous section. Then follow the steps below:

1. Remove the two M2x2.5 screws securing the wireless LAN module. The LAN unit will pop up.

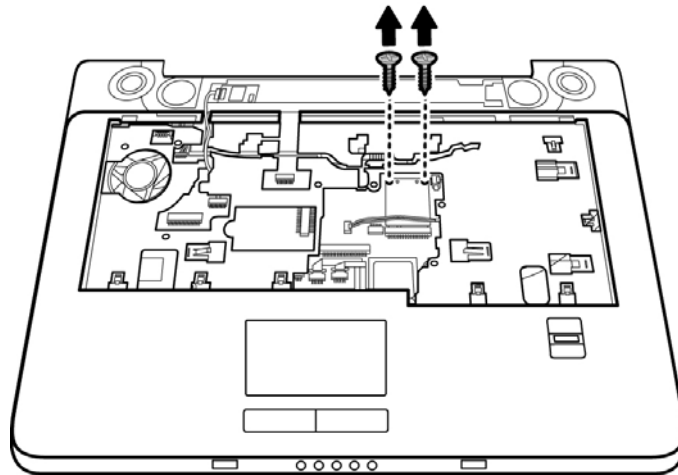

Figure 4-38 Removing the wireless LAN unit screws

2. Grasp the wireless LAN unit and pull it out.

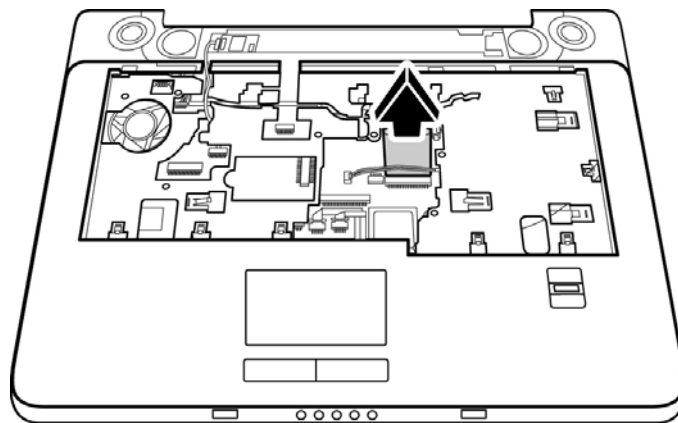

Figure 4-39 Removing the wireless LAN card

CAUTION: Do not touch the connectors on the wireless LAN unit or on the computer. Debris on the connectors may cause malfunction.

Installing the Wireless LAN Unit

To install the wireless LAN unit, follow the steps below and refer to the figures in the preceding section.

1. Fit the wireless LAN unit into its connector on the system board and gently press down.

CAUTION: *Do not touch the connectors on the wireless LAN unit or on the computer. Debris on the connectors may cause malfunction.*

2. Secure the wireless LAN unit to the system board with two M2x2.5 screws.
3. Attach the white antenna to the Main connector, and the black antenna to the Aux connector.

4.14 Bluetooth

Removing the Bluetooth module

To remove the Bluetooth module, first remove the keyboard and the strip cover as described in the preceding section and then follow the steps below:

1. Disconnect the Bluetooth cable from the Bluetooth module.

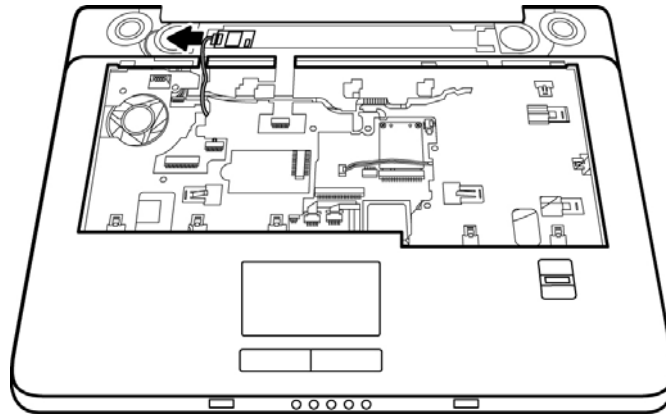

Figure 4-40 Disconnecting the Bluetooth cable

2. Slide out the Bluetooth module in direction of the arrow.

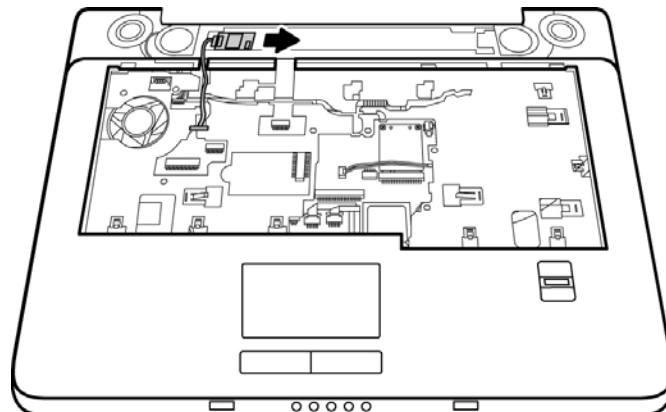

Figure 4-41 Removing the Bluetooth module

Installing the Bluetooth module

To install the Bluetooth module, follow the steps below and refer to the figures in the preceding section.

1. Seat the Bluetooth module on the top chassis in place.
2. Connect the Bluetooth cable to the module.

4.15 Top Cover

Removing the Cover

To remove the top cover, first remove the battery pack, HDD, expansion memory module, ODD, modem, wireless LAN unit, keyboard, strip cover, and display assembly, as described in the preceding sections. Follow the steps below to remove the top cover.

1. Turn the computer upside down and remove the following 19 screws from the rear panel:
 - M2.5x4: four screws
 - M2.5x8: fourteen screws
 - M2.5x3: one screw

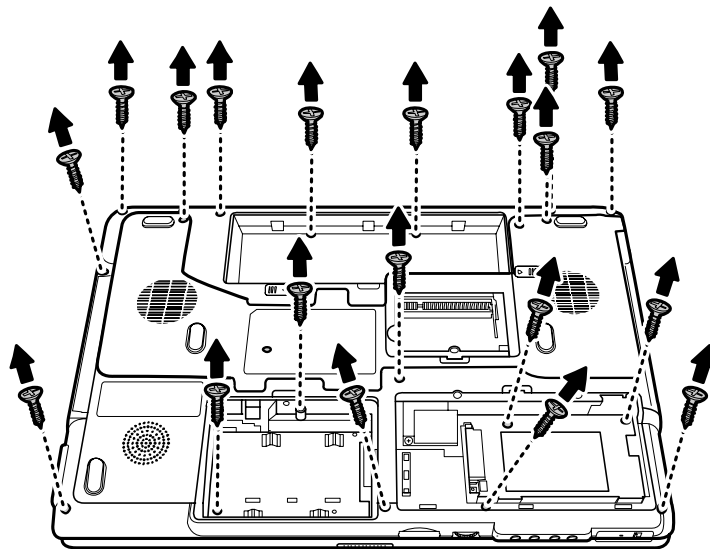

Figure 4-42 Removing the top cover (back panel screws)

2. Turn the computer over again and detach the two speaker cables, system fan cable, touch pad FFC cable, fingerprint unit FFC cable, and the Bluetooth cable from the top cover.

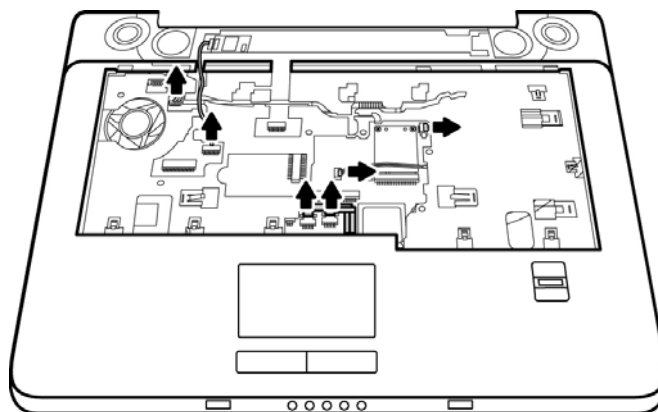
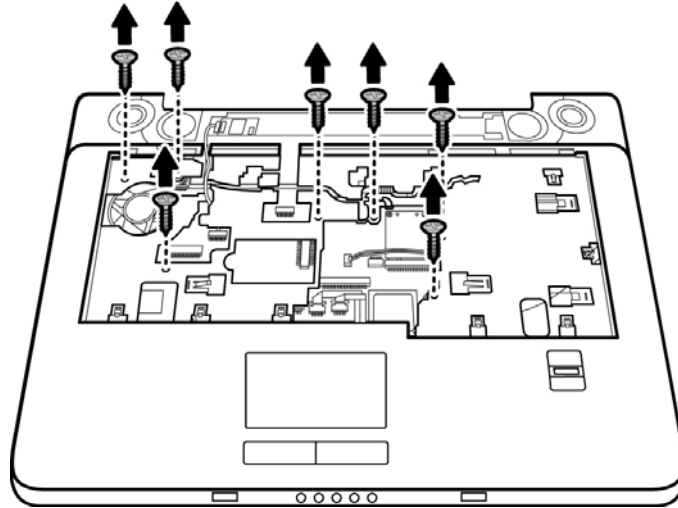
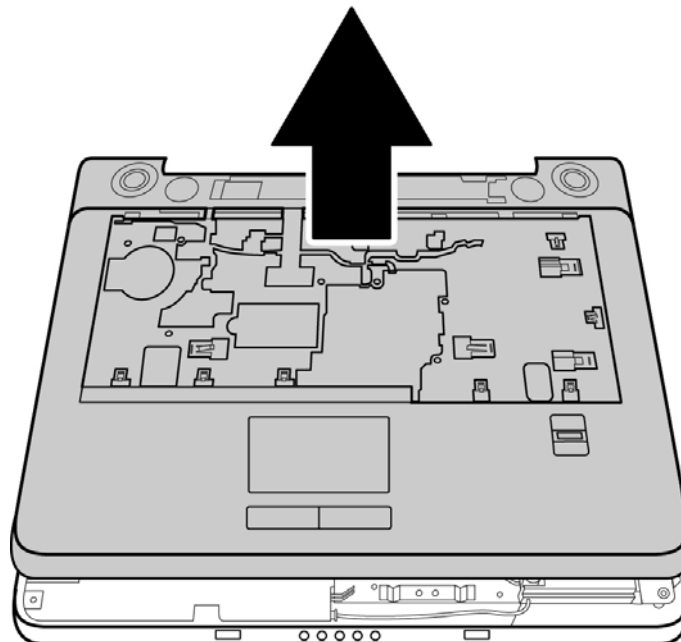

Figure 4-43 Removing the cables

3. Remove the following screws securing the top cover.
 - M2.5x8: four screws
 - M2.5x6: two screws
 - M2.5x20: one screw

*Figure 4-44 Removing the top cover (front panel screws)*

4. Lift off the top cover.

*Figure 4-45 Removing the top cover*

Installing the Top Cover

To install the top cover, follow the steps below and refer to the figures in the preceding section.

1. Seat the top cover, and secure the speaker cables, Bluetooth cable, fingerprint unit FFC cable, and touch pad unit FFC cable to the system board.
2. Secure the top cover with two M2.5x6 screws, four M2.5x8 screws, and one M2.5x20 screw.
3. Turn the computer upside down and secure fourteen M2.5x8 screws, four M2.5x4 screws, and one M2.5x3 screw.

4.16 Touch Pad

Removing the Touch Pad

To remove the Touch Pad, first remove the battery pack, keyboard, and top cover, and then follow the steps below:

1. Remove five M2.5x3 screws securing the Touch Pad bracket to the rear side of the top cover.

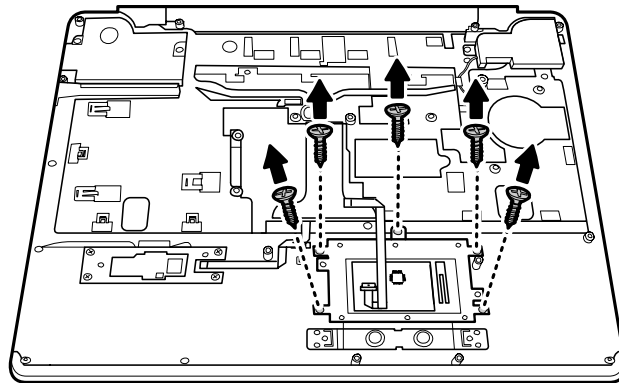

Figure 4-46 Removing the touch pad screw

2. Disconnect the Touch Pad FFC cable from the Touch Pad.

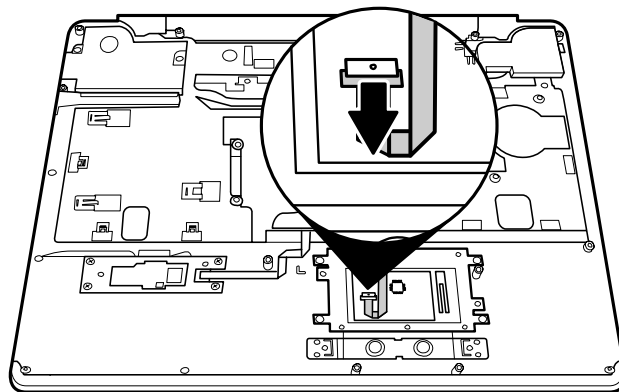

Figure 4-47 Disconnecting the touch pad FFC cable

3. Remove the Touch Pad with the bracket and by lifting it gently.

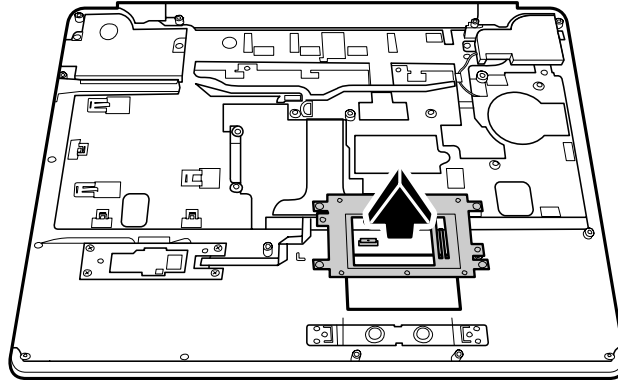

Figure 4-48 Removing the Touch Pad

Installing the Touch Pad

To install the Touch Pad, follow the steps below and refer to the figures in the preceding section:

1. With the top cover upside down, place the Touch Pad and the Track Pad bracket in position.
2. Secure the Touch Pad bracket with five M2.5x3 screws.
3. Connect the Touch Pad FFC cable to the Touch Pad.

4.17 Fingerprint Module

Removing the Fingerprint Module

To remove the Fingerprint Module, first remove the battery pack, keyboard, and top cover, and then follow the steps below:

1. Remove four M2.5x3 screws securing the Fingerprint Module Bracket to the rear side of the top cover.

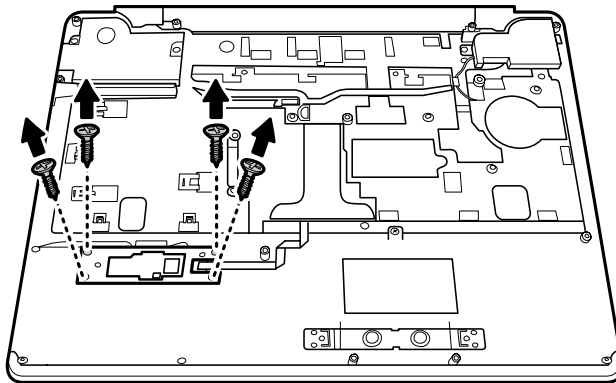

Figure 4-49 Removing the fingerprint module bracket screws

2. Remove the bracket.

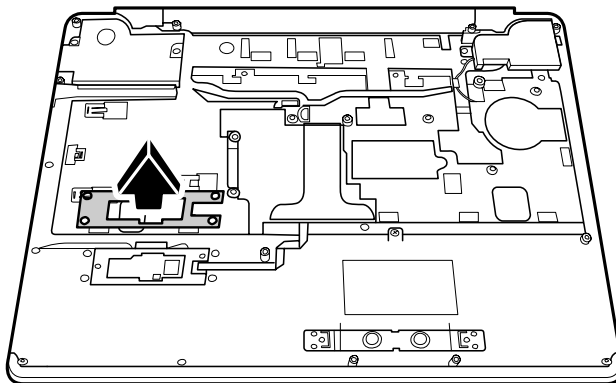

Figure 4-50 Removing the fingerprint module bracket

3. Remove the Fingerprint module by lifting it gently.

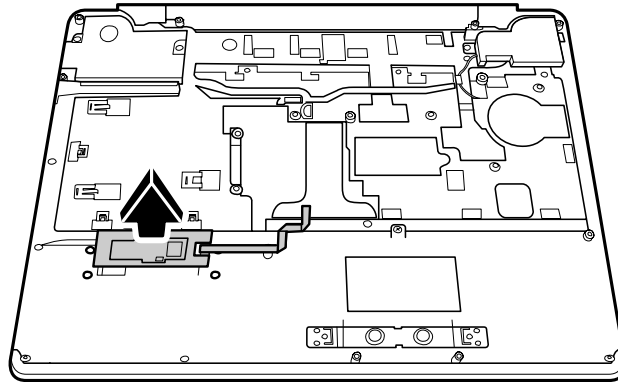

Figure 4-51 Removing the fingerprint module

Installing the Fingerprint Module

To install the Fingerprint Module, follow the steps below and refer to the figures in the preceding section:

1. Turn the top cover upside down and place the Fingerprint Module and the Fingerprint Module Bracket in position on top.
2. Secure the Fingerprint Module bracket with four M2.5x3 screw.

4.18 Subwoofer Unit and USB Board

Removing the Subwoofer Unit and USB Board

To remove the subwoofer unit and USB board, first remove the battery pack, keyboard, and top cover, and then follow the steps below:

1. Remove the two screws securing the subwoofer unit to the chassis.

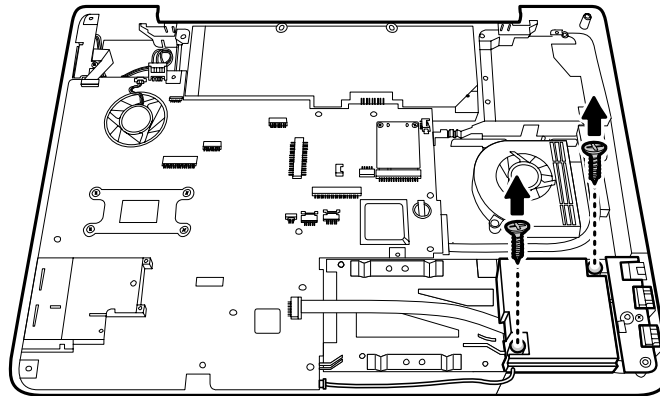

Figure 4-52 Removing the subwoofer screws

2. Remove the USB board cable and subwoofer cable.

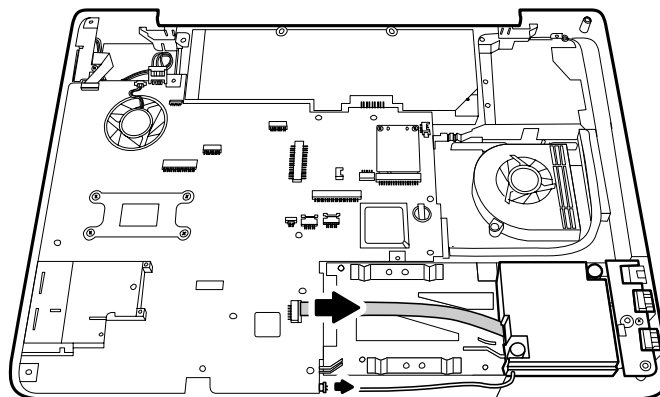

Figure 4-53 Disconnecting the USB board cable and subwoofer cable

3. Remove the subwoofer unit.

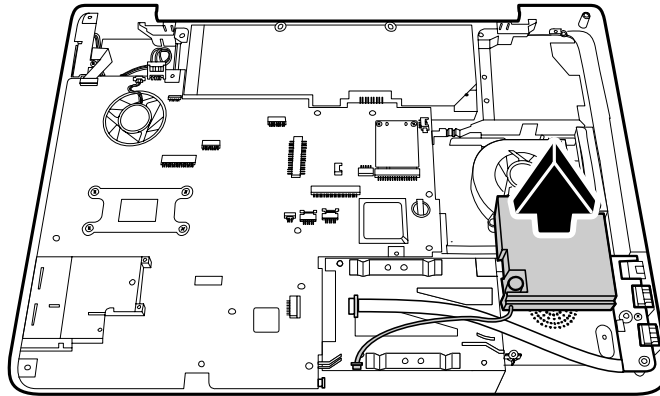

Figure 4-54 Removing the subwoofer unit

4. Remove the M2.5x4 screw securing the USB board to the chassis.

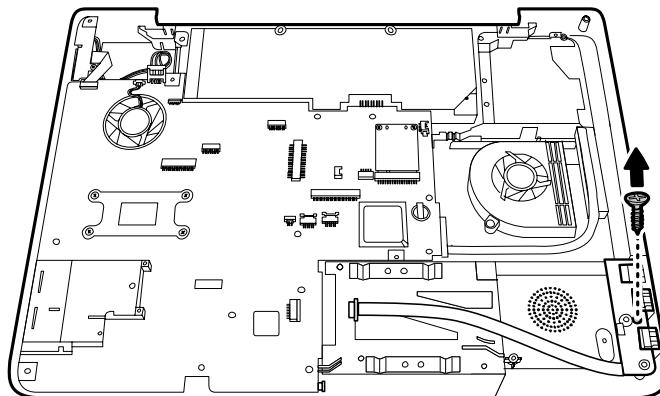

Figure 4-55 Removing the USB board screw

5. Remove the USB board.

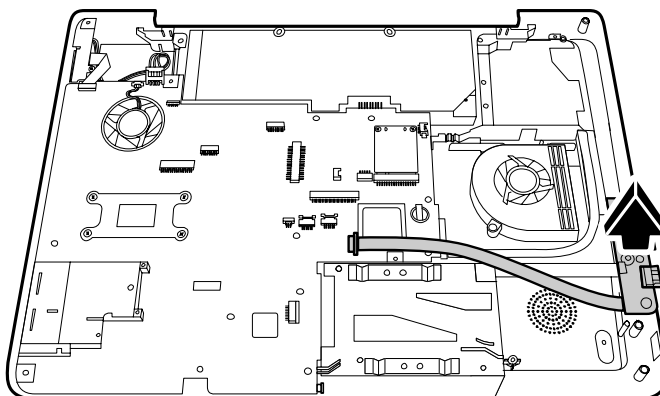

Figure 4-56 Removing the USB board

Installing the Subwoofer Unit and USB Board

To install the subwoofer unit and USB board, follow the steps below and refer to the figures in the preceding section:

1. Place the USB board in position.
2. Connect the USB board cable to the system board.
3. Secure the USB board with one M2.5x4 screw.
4. Seat the subwoofer unit in place.
5. Connect the subwoofer cable to the system board.
6. Secure the subwoofer unit with four screws.

4.19 System Board

Removing the System Board

To remove the system board, first remove the battery pack, keyboard, display assembly, top cover, and VGA PCB, then follow the steps below:

1. Remove the two M2.5x4 screws securing the system board.

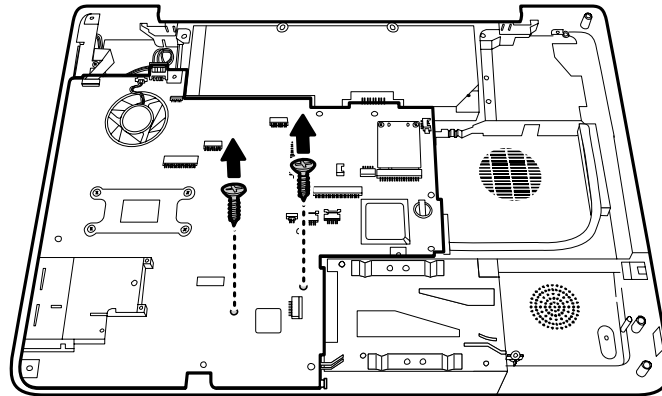

Figure 4-57 Removing the system board screws

2. Remove the DC in jack, speaker, VGA fan connects from its socket.

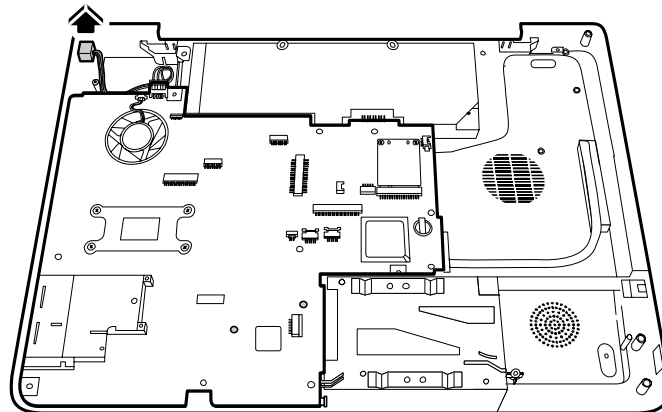

Figure 4-58 Removing the DC power cable

3. Remove the system board after making sure that all connectors are removed from their respective sockets.

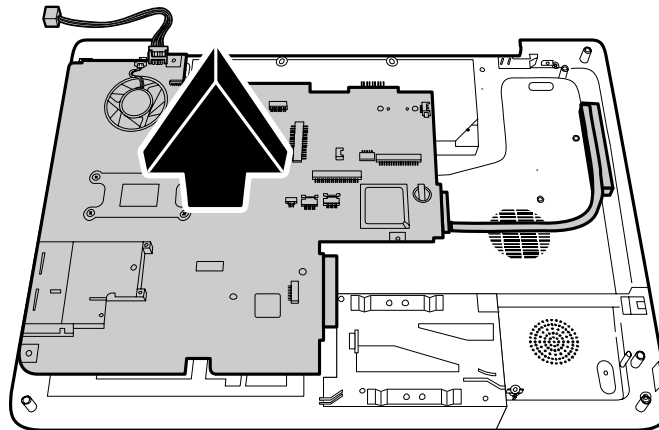

Figure 4-59 Removing the system board

Installing the System Board

To install the system board, follow the steps below and refer to the figures in the preceding section.

1. Seat the system board in the chassis. Take care to align all the ports and connectors in their respective openings on the chassis.
2. Replace the two M2.5x4 screws to secure the system board.
3. Connect the DC power cable, speaker, VGA fan, VGA FFC cable to the socket on the system board.

4.20 System Fan

Removing the System Fan

To remove the system fan, first remove the battery pack, keyboard, and top cover, and then follow the steps below:

1. Remove the three M2.5x4 screws securing the system fan to the chassis.

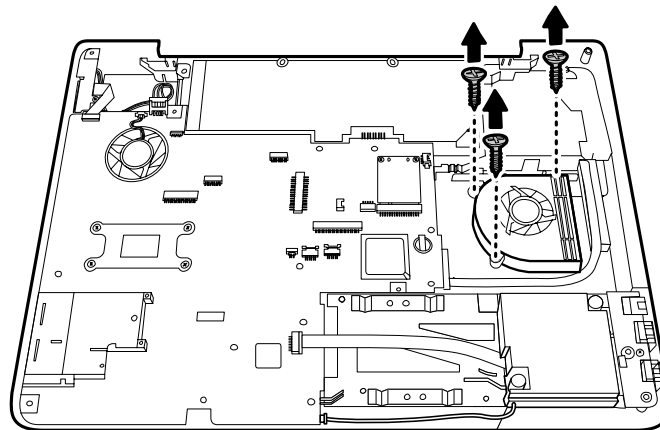

Figure 4-60 Removing the fan screws

2. Lift out the fan.

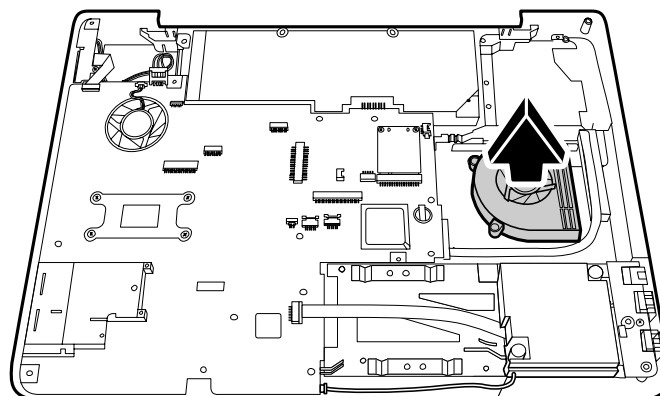

Figure 4-61 Removing the fan

Installing the System Fan

To install the system fan, follow the steps below and refer to the figures in the preceding section.

1. Seat the system fan in the chassis.
2. Secure the fan with three M2.5x4 screws.

4.21 VGA PCB

Removing the VGA PCB

To remove the VGA PCB, first remove the battery pack, keyboard, display assembly, and top cover, then follow the steps below:

1. Disconnect the VGA PCB wire cable from the system board.

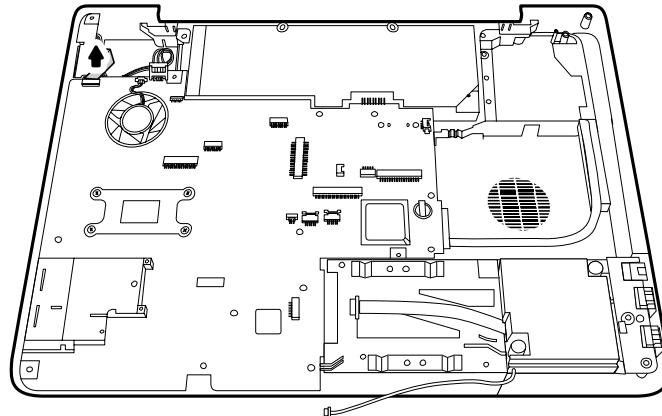

Figure 4-62 Removing the VGA PCB FFC cable

2. Remove the M2x6 screw securing the VGA PCB. Then remove the two hexagonal VGA screws from the left side of the computer.

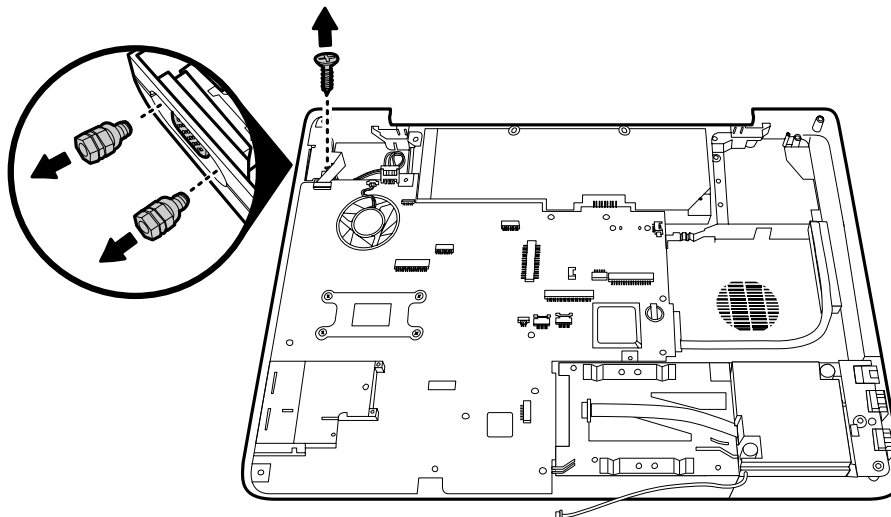

Figure 4-63 Removing the VGA PCB screw and the hexagonal screws

3. Gently pulling it out away from the VGA port and lift it out from the chassis.

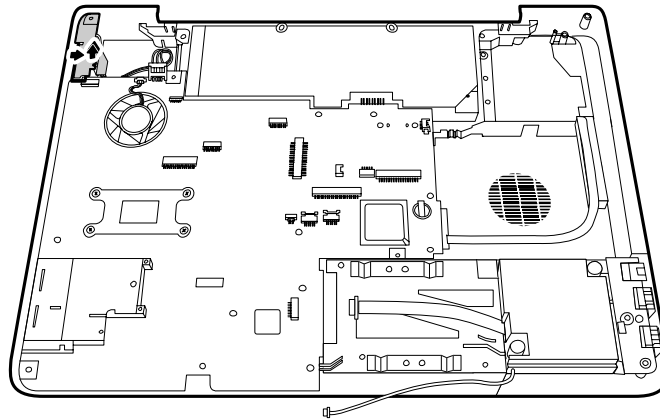

Figure 4-64 Removing the VGA PCB

Installing the VGA PCB

To install the VGA PCB, follow the steps below and refer to the figures in the preceding section.

1. Seat the VGA PCB in the chassis.
2. Replace the M2x6 screw to secure the VGA PCB.
3. Replace the two hexagonal screws to secure the VGA port.

4.22 VGA Board

Removing the VGA Board

To remove the VGA board, you have to first remove the battery pack, keyboard, top cover, and system board. Then follow the steps below:

1. Turn the system board over and remove the three M2.5x4 screws securing the VGA board.

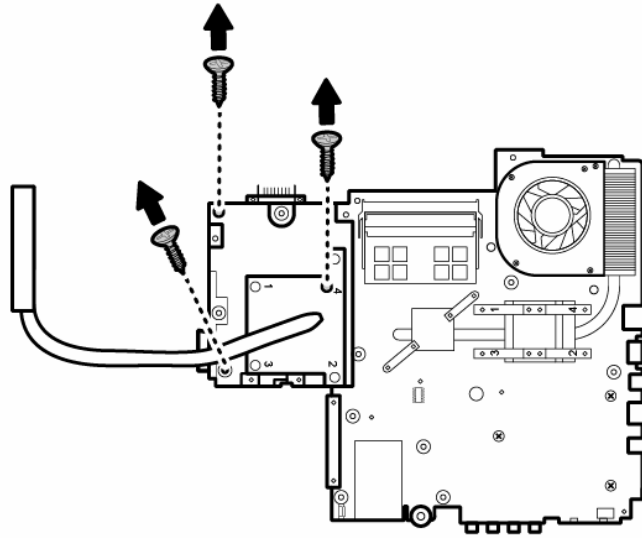

Figure 4-65 Removing the VGA board screws

2. Remove the VGA board from the system board.

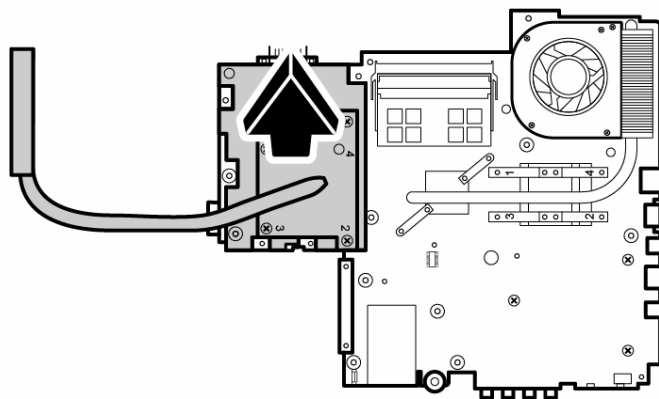

Figure 4-66 Removing the VGA board

3. Remove the heat sink from the VGA board by removing the four screws. Follow the order indicated by the numbers on the heat sink in reverse to remove the screws.

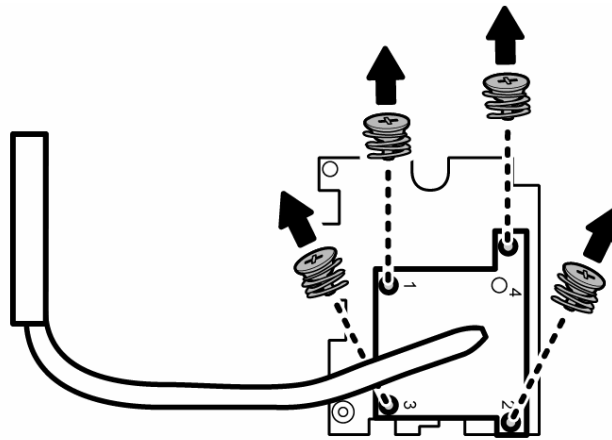

Figure 4-67 Removing the VGA heat sink

Installing the VGA Board

To install the VGA board, follow the steps below and refer to the figure in the preceding section:

CAUTION: If you remove the heat sink, use the grease tool to remove the grease on the VGA board and heat sink. Reapply fresh grease before installing the heat sink.

1. Connect the heat sink to the VGA board by securing it with four screws. Follow the order indicated by the numbers on the heat sink to tighten the screws.
2. Seat the VGA board and secure it by placing the three M2.5x4 screws and tightening them.

4.23 Fan and CPU

Removing the Fan and CPU

To remove the fan, heat sink, and CPU, you must first remove the display assembly, keyboard, top cover and system board, and then follow the steps below:

1. Turn the system board upside down. Remove the six M2.5x3 screws from the heat sink. Follow the order indicated by the numbers on the heat sink in reverse to remove the screws.

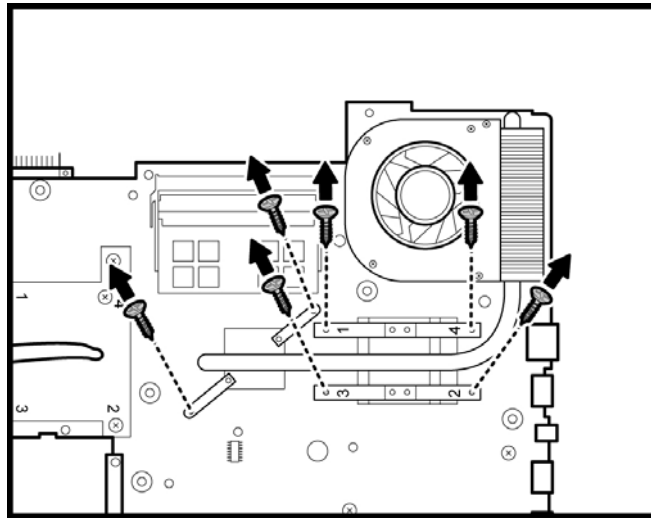

Figure 4-68 Removing the heat sink screws

2. Lift and remove the heat sink from the system board.

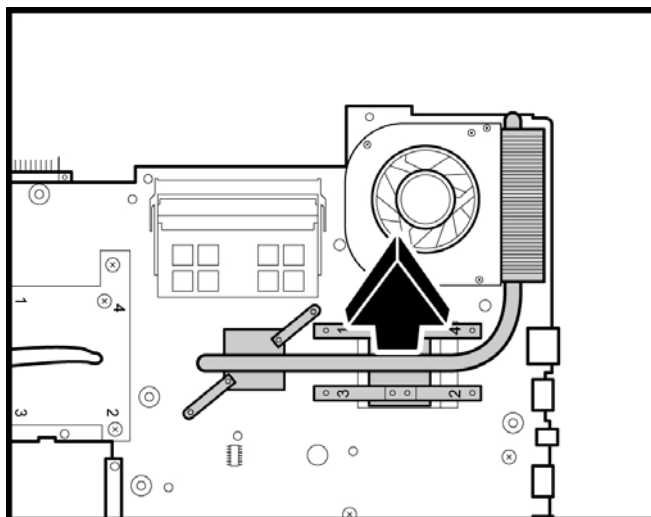

Figure 4-69 Removing the heat sink

3. Turn over and remove the fan connector and two M2.5x3 screws from the system board.

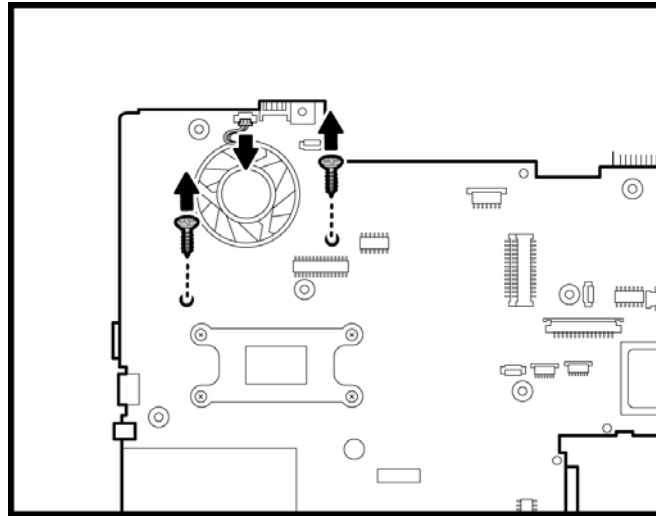

Figure 4-70 Removing the fan connector and screws

4. Remove the fan module.

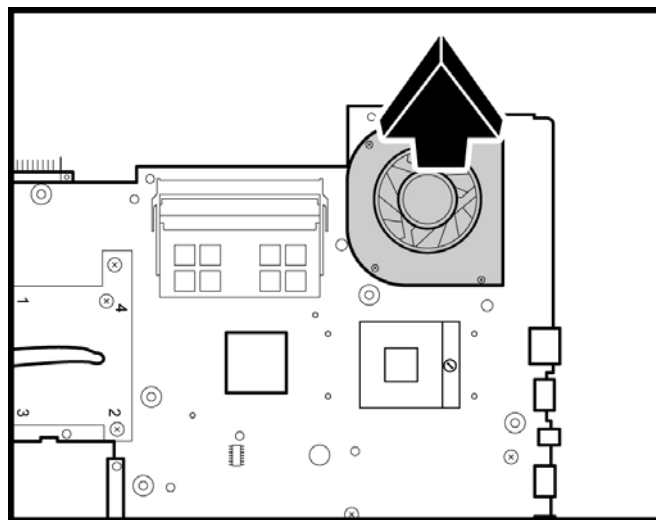

Figure 4-71 Removing the fan

5. Turn the cam on the CPU socket with a flat-blade screwdriver so that the notch on the cam is aligned with the *open* side of the CPU socket to unlock the CPU.

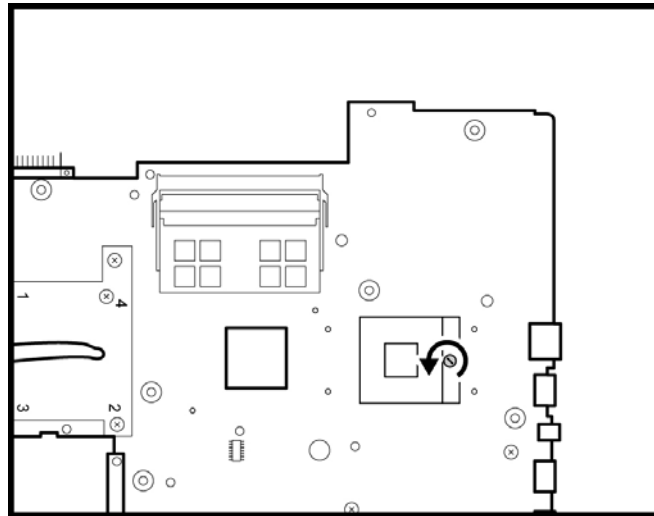

Figure 4-72 Turning the CPU cam

6. Gently lift out the CPU.

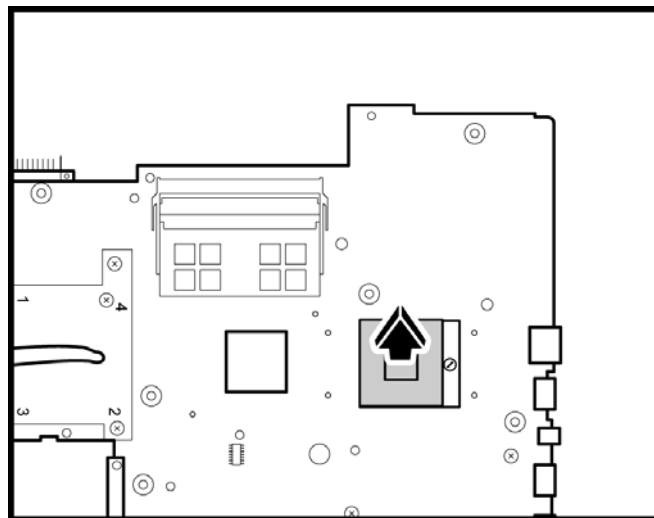

Figure 4-73 Removing the CPU

Installing the Fan and CPU

To install the fan and CPU, follow the steps below and refer to the figures in the preceding section.

CAUTION: *If you remove the heat sink, use the CPU grease tool to remove the grease on the CPU and heat sink. Reapply fresh grease before installing the heat sink.*

1. Make sure that the notch on the cam is aligned with the *open* position of the CPU slot.
2. Seat the CPU aligning the triangle mark on the CPU with the one on the CPU socket. Make sure the alignment is exact to avoid damaging pins on the CPU.
3. Press the CPU softly with your fingers to insert into the socket and turn the cam on the CPU socket to the *closed* position with a flat-blade screwdriver to secure the CPU.
4. Seat the heat sink over the CPU and secure with four screws in the order indicated on the heat sink.
5. Seat the fan module and secure with the two M2.5x3 screws on the front side of the system board.
6. Attach the fan connector.

4.24 Display Mask

Removing the Display Mask

To remove the display mask, first remove the display assembly as described earlier, then follow the steps below:

1. Remove two M2.5x6 silver screws on the upper display mask and two M2.5x8 black screws on the lower display mask.

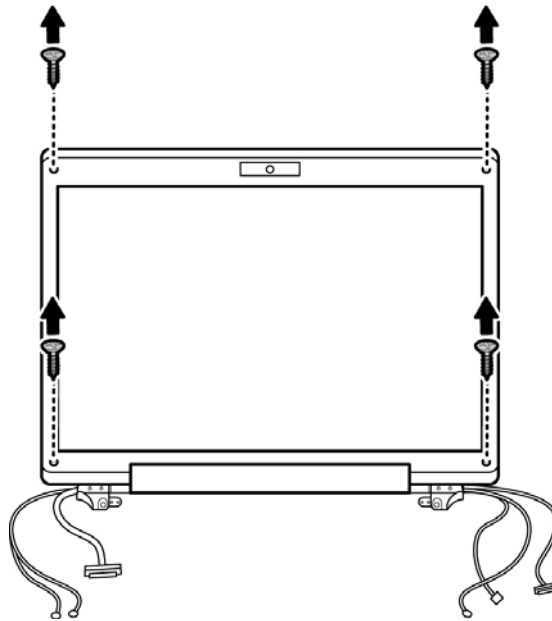

Figure 4-74 Removing the display mask screws

2. Carefully insert your fingers between the display mask and the LCD panel, and pry open the snaps. Start with the four snaps at the top of the display mask. Continue unsnapping the display mask along the two sides and the bottom edge to remove the display mask.

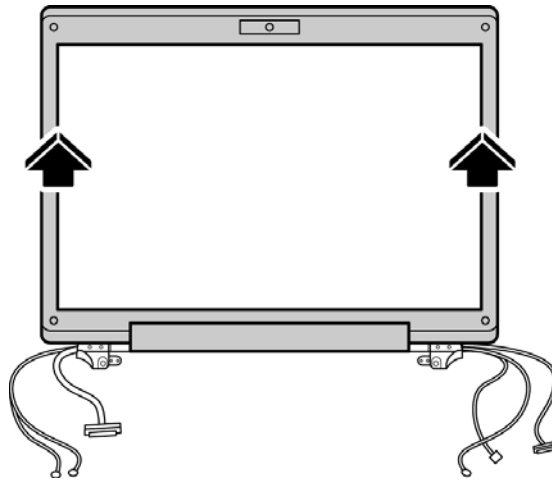

Figure 4-75 Removing the display mask screws

Installing the Display Mask

To install the display mask, follow the steps below and refer to the figures in the preceding section.

1. Seat the display mask and secure the snaps on each side.
2. Secure the display mask with two silver M2.5x6 screws and two black M2.5x8 screws.

4.25 FL Inverter Board

Removing the FL Inverter Board

To remove the FL inverter board, first remove the battery pack, the display assembly, display mask, and LCD module, then follow the steps below:

1. Remove the black M2x4 screw securing the FL invert board to the top chassis.

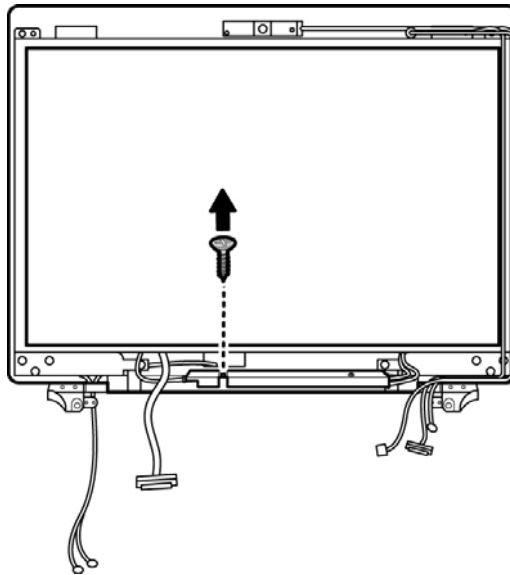

Figure 4-76 Removing the FL inverter board screws

2. Disconnect the two connectors on either side of the FL invert board.

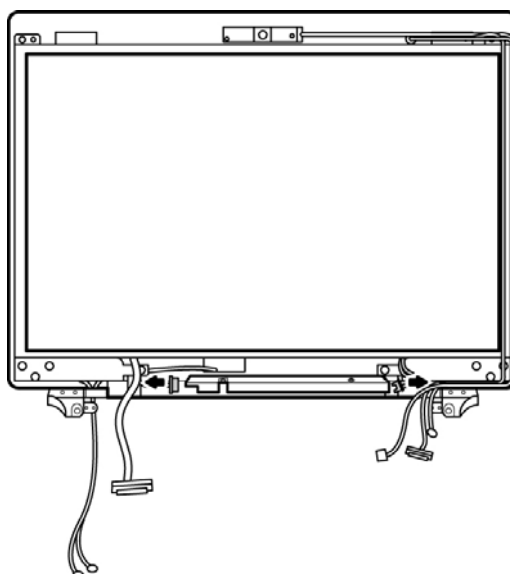

Figure 4-77 Removing the connectors

3. Lift out the FL invert board.

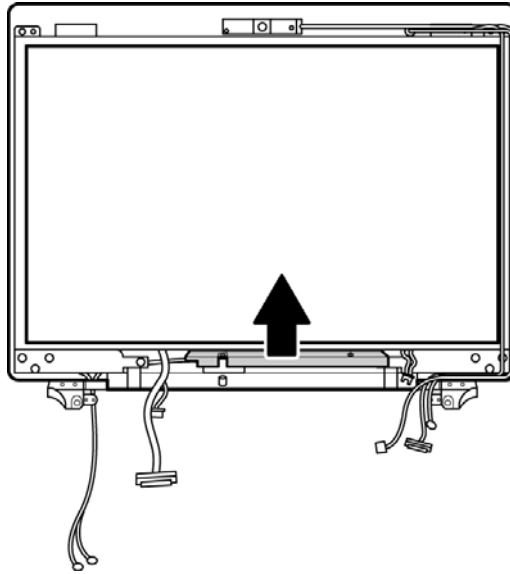

Figure 4-78 Removing the FL inverter board

Installing the FL Inverter Board

To install the FL inverter board, follow the steps below and refer to the figure in the preceding section.

1. Seat the FL inverter board in the top chassis.
2. Secure the FL inverter board with one black M2x4 screw to the top chassis.
3. Connect the two connectors on either side of the board.

4.26 LCD Module

Removing the LCD Module

To remove the LCD module, first remove the display assembly and display mask, and FL inverter board connectors. Then follow the steps below:

1. Unhook all cables from the fasteners around the edge of the top chassis.
2. Remove six M2.5x6 screws securing the LCD module to the top chassis.

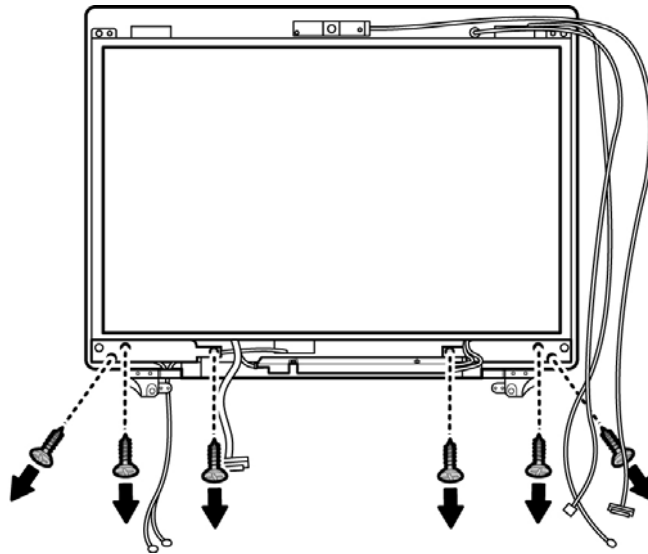

Figure 4-79 Removing the LCD module screws

3. Lift the LCD module from the top chassis.

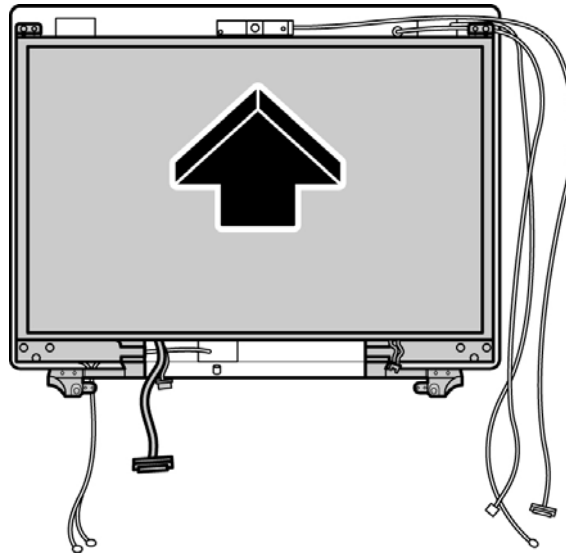

Figure 4-80 Removing the LCD Module

4. Remove eight M2x3 screws securing the LCD module bracket to the LCD module.

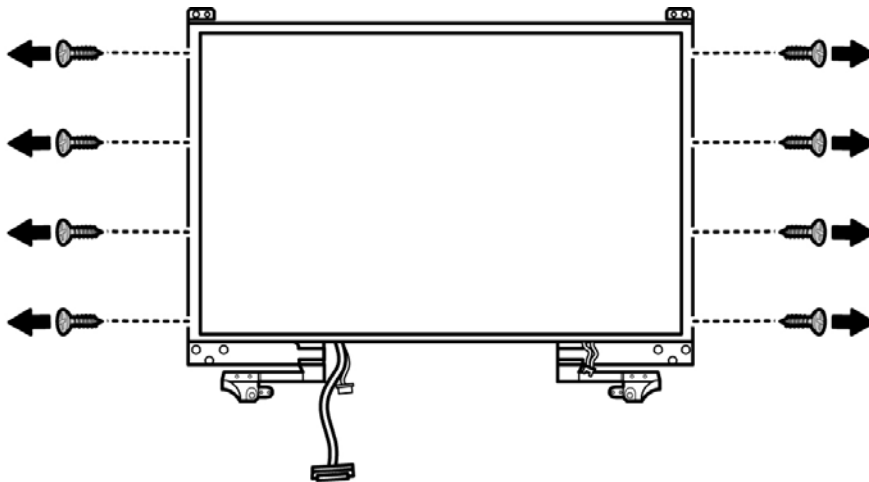

Figure 4-81 Removing the bracket screws

NOTE: If the LCD module malfunctions, remove the LCD cable and LCD bracket. Then replace the whole LCD module unit.

5. Turn over the LCD screen and remove the tape securing the LVDS cable. Detach the LVDS cable.

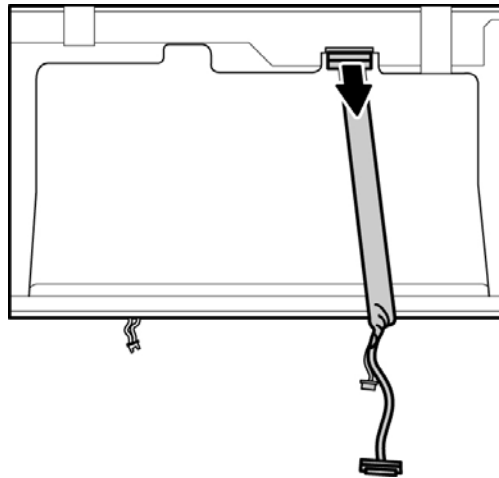

Figure 4-82 Removing the LVDS cable

Installing the LCD Module

To install the LCD module, follow the steps below and refer to the figures in the preceding section.

1. Secure the LVDS cable to the LCD module.
2. Ensure all cables are outside of the LCD display casing.
3. Set the LCD module in the display assembly with the LCD module bracket and secure it with eight M2x3 screws. Note the L and R markings to make sure that the bracket arms are secured on the correct side.
4. Seat the LCD module with bracket on the chassis.
5. Secure the LCD module to the top chassis with six M2.5x6 screws.
6. Connect the two connectors on either side of the FL inverter board.
7. Hook all the cables in the fasteners around the edge of the top chassis. Thread the thinner cables first, followed by the thicker ones.

4.27 Camera and Microphone

Removing the Camera and Microphone

To remove the camera and microphone, first remove the display assembly and display mask, then follow the steps below:

1. Remove the CMOS cable from the camera module.

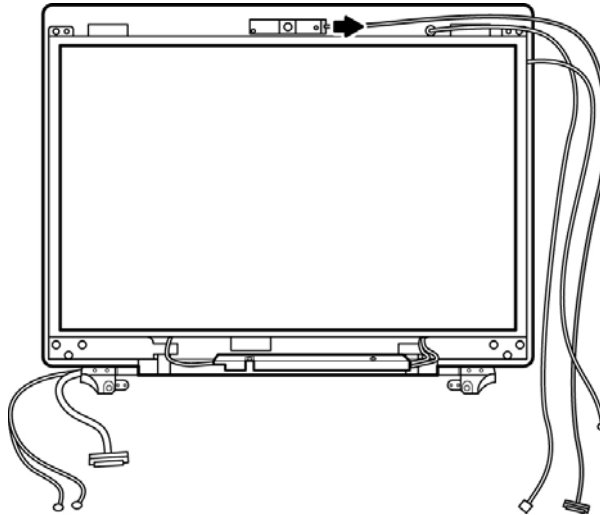

Figure 4-83 Removing the CMOS cable

2. Remove the camera module by gently peeling it away from its adhesive backing.

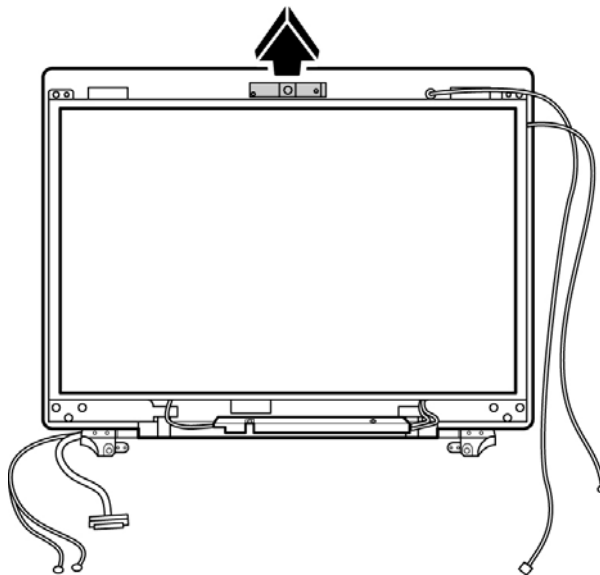

Figure 4-84 Removing the camera module

3. Use a flat screwdriver to lever the microphone module from its socket and gently lift out.

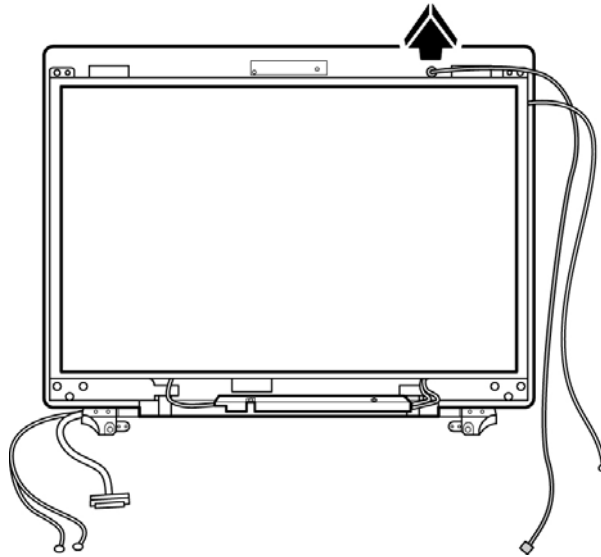

Figure 4-85 Removing the microphone

Installing the Camera and Microphone

To install the camera and microphone, follow the steps below and refer to the figure in the preceding section.

1. Fix the camera module to the adhesive backing at the top chassis.
2. Connect the CMOS cable to the camera module.
3. Push the microphone into place in its respective bracket.

Appendix A Handling the LCD Module

Precautions for handling the LCD module

The LCD module can be easily damaged during assembly or disassembly. Observe the following precautions when handling it to prevent damaging it.

1. When installing the LCD module in the display assembly, make sure that you seat it so that it is properly aligned and maximum visibility of the display is maintained.

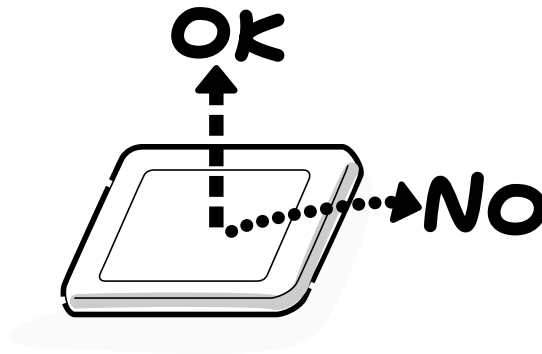

2. Be careful to align the holes at the four corners of the LCD module with the corresponding holes in the LCD cover before securing the module with screws. Do not force the module into place, because stress can affect its performance.

Note: The panel's polarized surface is easily scratched and damaged, so handle it carefully.



3. If the panel's surface gets dirty or moist, wipe it with cotton or a soft cloth. If it is still dirty, try breathing on the surface to create a light condensate and wipe it again.

If the surface is very dirty, we recommend a CRT cleaning agent. Apply the agent to a soft cloth and then wipe the panel's surface. Do not apply cleanser directly to the panel.



4. If water or other liquid is left on the panel's surface for a long period, it can change the screen's tint or stain it. Be sure to quickly wipe off any liquid.



5. Glass is used in the panel, so be careful not to drop it or let it strike a hard object, which could cause breakage or cracks.

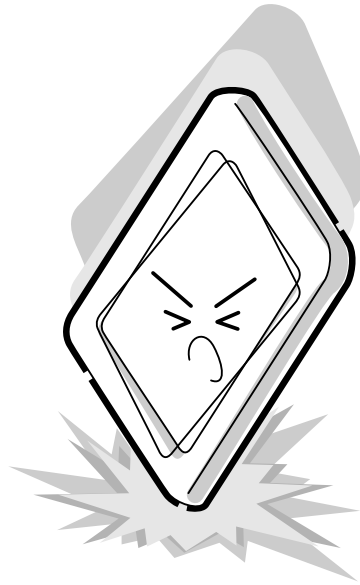

6. CMOS-LSI circuits are used in the module, so guard against damage from electrostatic discharge. Be sure to wear a wrist or ankle grounding device when handling the module.

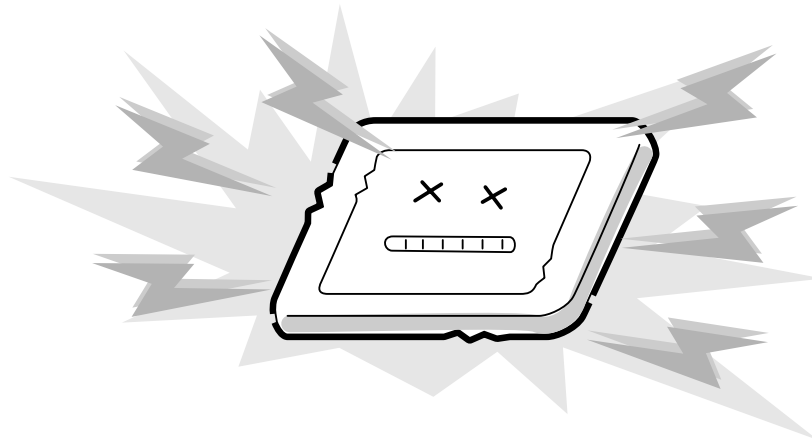

7. Do not expose the module to direct sunlight or strong ultraviolet rays for long periods.

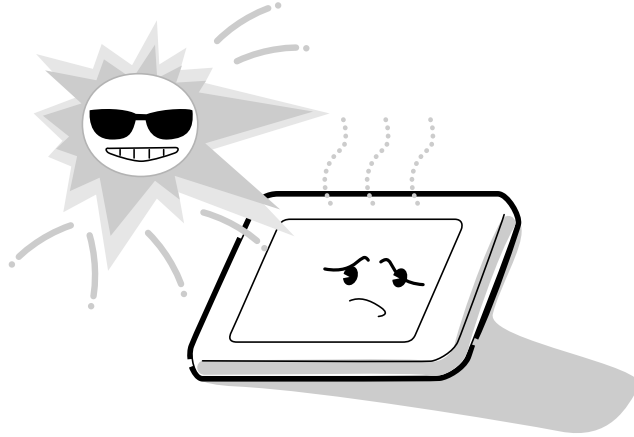

8. Do not store the module at temperatures below its specifications. Cold can cause the liquid crystals to freeze, lose their elasticity or otherwise suffer damage.

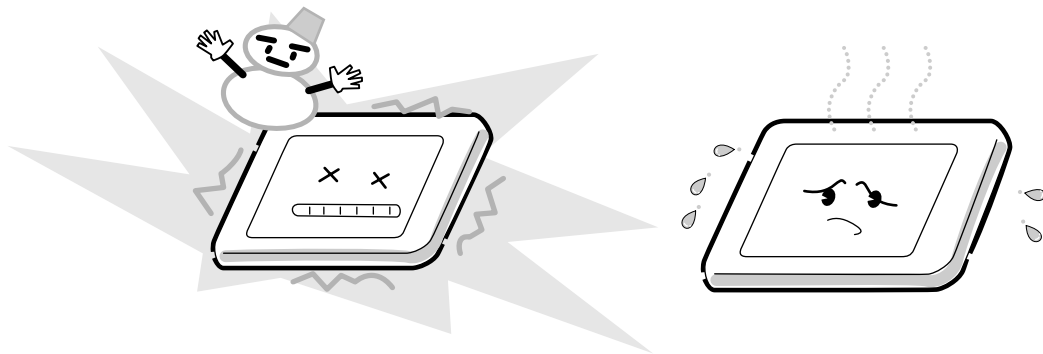

9. Do not disassemble the LCD module. Disassembly can cause malfunctions.

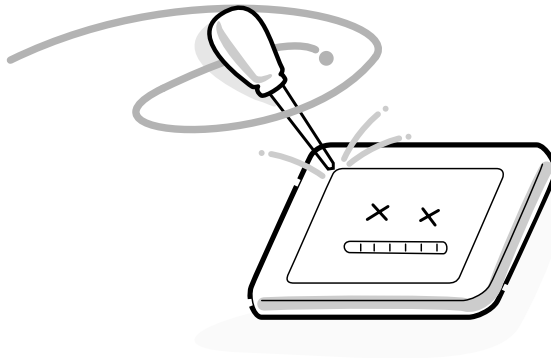

10. If you transport the module, do not use packing material that contains epoxy resin (amine) or silicon glue (alcohol or oxime). These materials can release gas that can damage the panel's polarization.

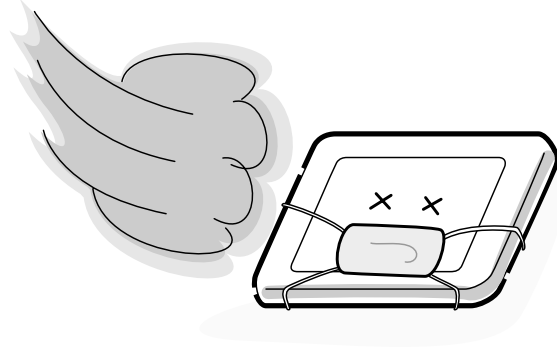

Appendix B Board Layout

B.1 System Board (FRDSY*) Top View

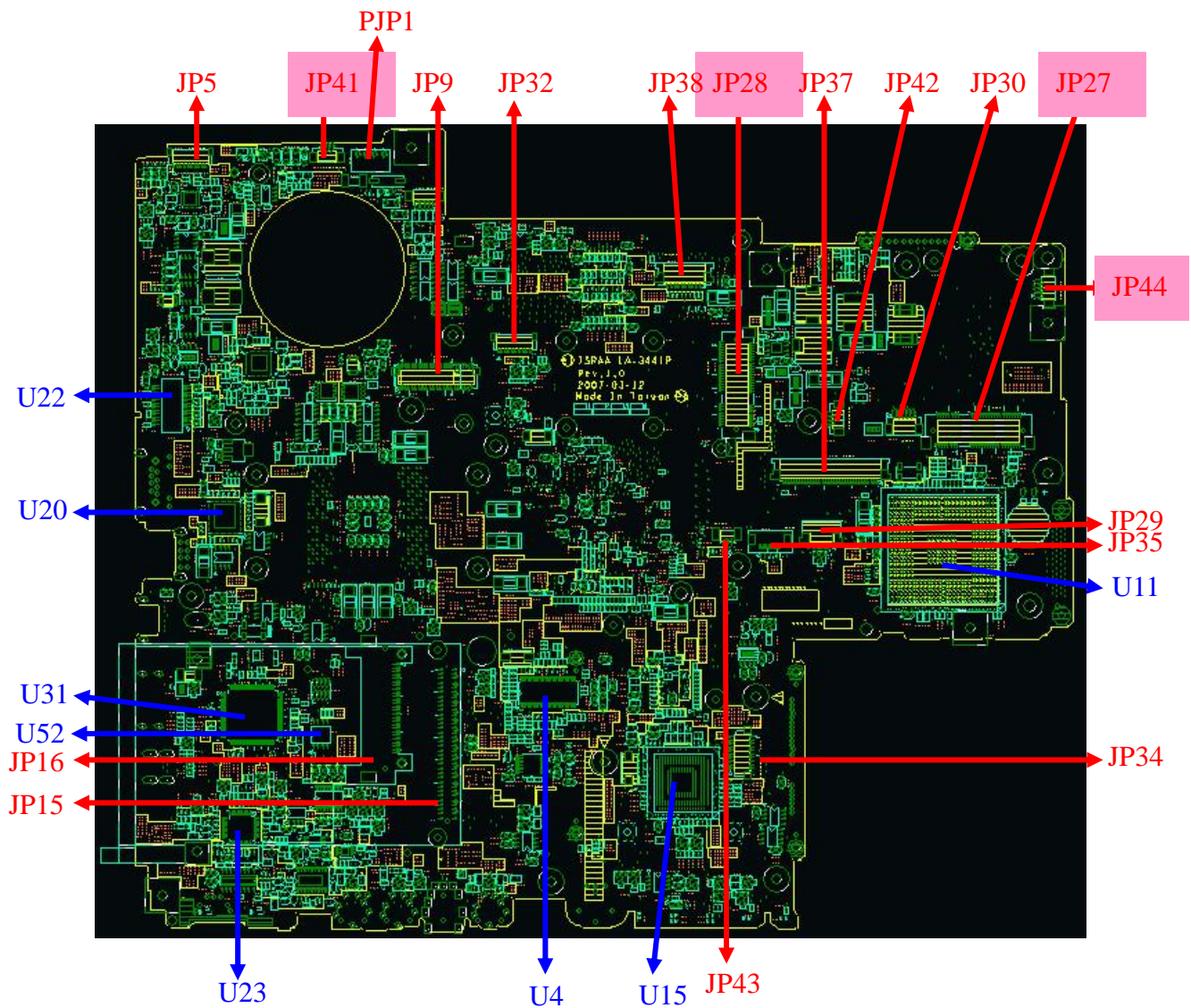

B.2 System Board (FRDSY*) Button View

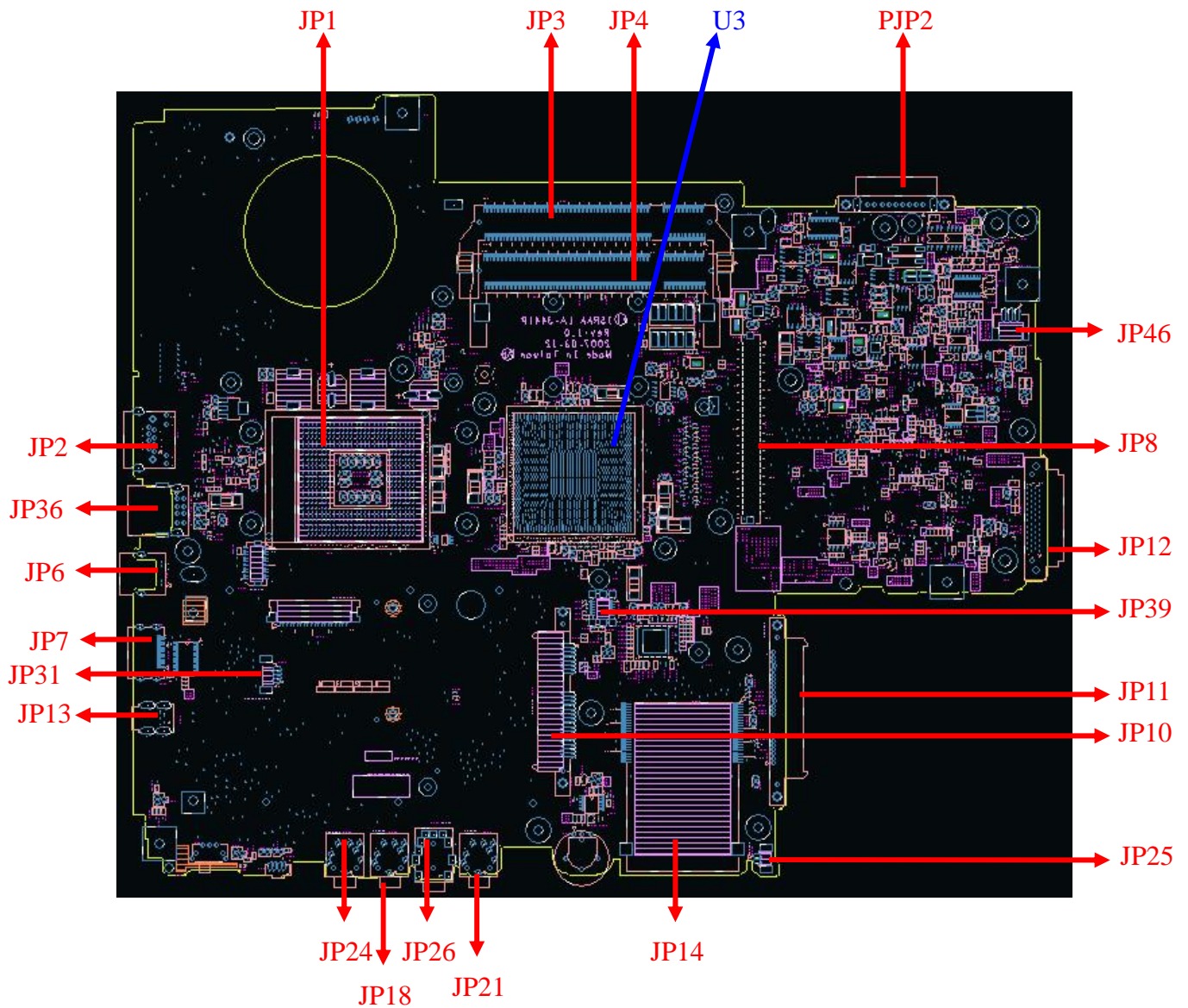

Table B-1 System board connectors (top and bottom)

Number	Name
JP1	CPU conn
JP2	LAN conn
JP3	DDR2-1 conn
JP4	DDR2-2 conn
JP5	CRT/B conn
JP6	TV-OUT conn
JP7	HDMI conn
JP8	VGA/B conn
JP9	LVDS conn
JP10	2 nd SATA HDD conn
JP11	1 st SATA HDD conn
JP12	ODD conn
JP13	1394 conn
JP14	6 in 1 CardReader conn
JP15	PCMCIA conn
JP16	New card conn
JP18	Microphone in jack
JP21	Headphone out jack
JP24	Line in jack
JP25	Sub-woofer conn
JP26	SPDIF out jack
JP27	Wireless LAN Card conn
JP28	ROBSON Card conn
JP29	Finger Printer conn
JP30	Int. Camera conn
JP31	For EC tools
JP32	Bluetooth conn
JP34	USB/B conn
JP35	Touch Pad conn
JP36	USB conn
JP37	Keyboard conn
JP38	SW/B conn
JP39	MDC conn
JP41	CPU FAN conn

JP42	VGA FAN conn
JP43	Int MIC Conn.
JP44	Speaker conn (right)
JP45	Speaker conn (left)
JP46	B+ conn
PJP1	Power core conn
PJP2	Battery conn

Table B-2 System board ICs (top and bottom)

Number	Name
U20	LAN RTL8101E/ RTL8111B
U3	North bridge 965GM/965PM
U4	Clock Generator ICS9LPRS325CKLFT
U31	EC KB926
U11	South bridge ICH8
U52	BIOS ROM
U22	LAN transformer
U15	Card bus controller TI PCI8402
U23	HD codec AC268

Appendix C Pin Assignments

System Board

C.1 JP3,JP4

Table C-1 SODIMM I/F pin assignments (200-PIN) (1/4)

Pin No.	Signal name	I/O	Pin No.	Signal Name	I/O
1	VREF	O	2	VSS	O
3	VSS	O	4	DQ4	I/O
5	DQ0	I/O	6	DQ5	I/O
7	DQ1	I/O	8	VSS	O
9	VSS	O	10	DM0	I/O
11	DQS0#	I/O	12	VSS	O
13	DQS0	I/O	14	DQ6	I/O
15	VSS	O	16	DQ7	I/O
17	DQ2	I/O	18	VSS	O
19	DQ3	I/O	20	DQ12	I/O
21	VSS	O	22	DQ13	I/O
23	DQ8	I/O	24	VSS	I/O
25	DQ9	I/O	26	DM1	O
27	VSS	O	28	VSS	O
29	DQS1#	I/O	30	CK0	I/O
31	DQS1	I/O	32	CK0#	I/O
33	VSS	O	34	VSS	O
35	DQ10	I/O	36	DQ14	I/O
37	DQ11	I/O	38	DQ15	I/O
39	VSS	O	40	VSS	O
41	VSS	O	42	VSS	O
43	DQ16	I/O	44	DQ20	I/O
45	DQ17	I/O	46	DQ21	I/O
47	VSS	O	48	VSS	O
49	DQS2#	I/O	50v	NC	-

Table C-1 SODIMM I/F pin assignments (200-PIN) (2/4)

Pin No.	Signal name	I/O	Pin No.	Signal Name	I/O
51	DQS2	I/O	52	DM2	I/O
53	VSS	O	54	VSS	O
55	DQ18	I/O	56	DQ22	I/O
57	DQ19	I/O	58	DQ23	I/O
59	VSS	O	60	VSS	O
61	DQ24	I/O	62	DQ28	I/O
63	DQ25	I/O	64	DQ29	I/O
65	VSS	O	66	VSS	O
67	DM3	I/O	68	DQS3#	I/O
69	NC	-	70	DQS3	I/O
71	VSS	O	72	VSS	O
73	DQ26	I/O	74	DQ30	I/O
75	DQ27	I/O	76	DQ31	I/O
77	VSS	O	78	VSS	O
79	CKE0	I/O	80	NC/CKE1	I/O
81	VDD	O	82	VDD	O
83	NC	-	84	NC/A15	-
85	BA2	I/O	86	NC/A14	-
87	VDD	O	88	VDD	O
89	A12	I/O	90	A11	I/O
91	A9	I/O	92	A7	I/O
93	A8	I/O	94	A6	I/O
95	VDD	O	96	VDD	O
97	A5	I/O	98	A4	I/O
99	A3	I/O	100	A2	I/O
101	A1	I/O	102	A0	I/O
103	VDD	O	104	VDD	O
105	A10/AP	I/O	106	BA1	I/O
107	BAD	I/O	108	RAS#	I/O
109	WE#	I/O	110	S0#	I/O
111	VDD	O	112	VDD	O
113	CAS#	I/O	114	ODT0	I/O

Table C-1 SODIMM I/F pin assignments (200-PIN) (3/4)

Pin No.	Signal name	I/O	Pin No.	Signal Name	I/O
115	NC/S1#	I/O	116	NC/A13	I/O
117	VDD	O	118	VDD	O
119	NC/ODT1	I/O	120	NC	-
121	VSS	O	122	VSS	O
123	DQ32	I/O	124	DQ36	I/O
125	DQ33	I/O	126	DQ37	I/O
127	VSS	O	128	VSS	O
129	DQS4#	I/O	130	DM4	I/O
131	DQS4	I/O	132	VSS	O
133	VSS	O	134	DQ38	I/O
135	DQ34	I/O	136	DQ39	I/O
137	DQ35	I/O	138	VSS	O
139	VSS	O	140	DQ44	I/O
141	DQ40	I/O	142	DQ45	I/O
143	DQ41	I/O	144	VSS	O
145	VSS	O	146	DQS5#	I/O
147	DM5	I/O	148	DQS5	I/O
149	VSS	O	150	VSS	O
151	DQ42	I/O	152	DQ46	I/O
153	DQ43	I/O	154	DQ47	I/O
155	VSS	O	156	VSS	O
157	DQ48	I/O	158	DQ52	I/O
159	DQ49	I/O	160	DQ53	I/O
161	VSS	O	162	VSS	O
163	NC,TEST	-	164	CK1	I/O
165	VSS	O	166	CK1#	I/O
167	DQS6#	I/O	168	VSS	O
169	DQS6	I/O	170	DM6	I/O
171	VSS	O	172	VSS	O
173	DQ50	I/O	174	DQ54	I/O
175	DQ51	I/O	176	DQ55	I/O
177	VSS	O	178	VSS	O
179	DQ56	I/O	180	DQ60	I/O

Table C-1 SODIMM I/F pin assignments (200-PIN) (4/4)

Pin No.	Signal name	I/O	Pin No.	Signal Name	I/O
181	DQ57	I/O	182	DQ61	I/O
183	VSS	O	184	VSS	O
185	DM7	I/O	186	DQS7#	I/O
187	VSS	O	188	DQS7	I/O
189	DQ58	I/O	190	VSS	O
191	DQ59	I/O	192	DQ62	I/O
193	VSS	O	194	DQ63	I/O
195	SDA	I/O	196	VSS	O
197	SCL	I/O	198	SA0	O
199	VDDSPD	O	200	SA1	O

C.2 JP5

Table C-2 RGB I/F pin assignments (10-pin)

Pin No.	Signal name	I/O	Pin No.	Signal Name	I/O
1	+5VS	-	2	DSUB_15_CLK	I/O
3	DSUB_12_DAT A	I/O	4	CRT_VSYNC	O
5	CRT_HSYNC	O	6	GND	-
7	CRT_B_L	O	8	DSUB_12_DATA	I/O
9	CRT_B_L	O	10	GND	-
11	CRT_B_L	O	12	GND	-

C.3 JP10

Table C-3 2nd HDD I/F pin assignments (22-pin)

Pin No.	Signal name	I/O	Pin No.	Signal Name	I/O
1	GND		2	A+	
3	A-		4	GND	
5	B-		6	B+	
7	GND		8	VCC3.3	
9	VCC3.3		10	VCC3.3	
11	GND		12	GND	
13	GND		14	VCC5	
15	VCC5		16	VCC5	
17	GND		18	NC	
19	GND		20	NC	
21	NC		22	NC	-

C.4 JP11

Table C-4 1st HDD I/F pin assignments (22-pin)

Pin No.	Signal name	I/O	Pin No.	Signal Name	I/O
1	GND		2	A+	
3	A-		4	GND	
5	B-		6	B+	
7	GND		8	V33	
9	V33		10	V33	
11	GND		12	GND	
13	GND		14	V5	
15	V5		16	V5	
17	GND		18	NC	
19	GND		20	NC	
21	NC		22	NC	-

C.5 JP12

Table C-5 ODD I/F pin assignments (52-pin)

Pin No.	Signal name	I/O	Pin No.	Signal Name	I/O
1	NC	I	2	NC	I
3	NC	-	4	NC	-
5	IDE_ODDRST#	O	6	IDE_DD8	I/O
7	IDE_DD7	I/O	8	IDE_DD9	I/O
9	IDE_DD6	I/O	10	IDE_DD10	I/O
11	IDE_DD5	I/O	12	IDE_DD11	I/O
13	IDE_DD4	I/O	14	IDE_DD12	I/O
15	IDE_DD3	I/O	16	IDE_DD13	I/O
17	IDE_DD2	I/O	18	IDE_DD14	I/O
19	IDE_DD1	I/O	20	IDE_DD15	I/O
21	IDE_DD0	I/O	22	IDE_DDREQ	I
23	GND	-	24	IDE_DIOR#	O
25	IDE_DIOW#	O	26	GND	O
27	IDE_DIORDY	I	28	IDE_DDACK#	O
29	IDE_IRQ	I	30	NC	O
31	IDE_DA1	O	32	+5VS	-
33	IDE_DA0	O	34	IDE_DA2	I
35	IDE_DCS1#	O	36	IDE_DCS3#	-
37	+5VS	-	38	+5VS	O
39	+5VS	-	40	+5VS	-
41	+5VS	-	42	+5VS	-
43	GND	-	44	GND	-
45	GND	-	46	GND	-
47	SEC_CSEL	-	48	GND	-
49	NC	-	50	NC	-
53	NC		54	NC	

C.6 JP15

Table C-6 PC Card I/F pin assignments (68-pin) (1/2)

Pin No.	Signal name	I/O	Pin No.	Signal Name	I/O
1	GND	-	35	GND	-
2	DATA3	I/O	36	CD1#	O
3	DATA4	I/O	37	DATA11	I/O
4	DATA5	I/O	38	DATA12	I/O
5	DATA6	I/O	39	DATA13	I/O
6	DATA7	I/O	40	DATA14	I/O
7	CE1#	I/O	41	DATA15	I/O
8	ADD10	I	42	CE2#	I/O
9	OE#	I/O	43	VS1#	I
10	ADD11	I	44	IORD#	I/O
11	ADD9	I	45	IOWR#	I
12	ADD8	I	46	ADD17	I
13	ADD13	I	47	ADD18	I
14	ADD14	I	48	ADD19	I
15	WE#	I	49	ADD20	I
16	READY	O	50	ADD21	I
17	VCC	-	51	VCC	-
18	VPP	-	52	VPP	-
19	ADD16	I	53	ADD22	I
20	ADD15	I	54	ADD23	I
21	ADD12	I	55	ADD24	I
22	ADD7	I	56	ADD25	I
23	ADD6	I	57	VS2#	I
24	ADD5	I	58	RESET	I
25	ADD4	I	59	WAIT#	I
26	ADD3	I	60	INPACK#	O
27	ADD2	I	61	REG#	I
28	ADD1	I	62	BVD2	O
29	ADD0	I	63	BVD1	I
30	DATA0	I	64	DATA8	I/O

Table C-6 PC Card I/F pin assignments (68-pin) (2/2)

Pin No.	Signal name	I/O	Pin No.	Signal Name	I/O
31	DATA1	I/O	65	DATA9	I/O
32	DATA2	I/O	66	DATA10	I/O
33	WP	I/O	67	CD2#	I
34	GND	-	68	GND	-

C.6 JP16

Table C-6 New Card I I/F pin assignments (26-pin)

Pin No.	Signal name	I/O	Pin No.	Signal Name	I/O
1	GND	-	2	USB20_N9	I/O
3	USB20_P9	I/O	4	CP_USB#	O
5	NC	-	6	NC	-
7	ICH_SMBCLK	O	8	ICH_SMBDATA	I/O
9	+1.5VS_CARD	O	10	+1.5VS_CARD	O
11	EC_SWI#	O	12	+3VALW_CARD	O
13	PERST#	O	14	+3VS_CARD	O
15	+3VS_CARD	O	16	CLKREQ#	I
17	EXP_CPPE#	O	18	CLK_PCIE_CARD#	O
19	CLK_PCIE_CARD	O	20	GND	-
21	PCIE_PTX_C_IRX_N1	O	22	PCIE_PTX_C_IRX_P1	O
23	GND	-	24	PCIE_ITX_C_PRX_N1	I
25	PCIE_ITX_C_PRX_P1	I	26	GND	-

C.7 JP9

Table C-7 LCDS I/F (40-pin)

Pin No.	Signal name	Function
1	+INV	Power for Panel
2	+INV	Power for Panel
3	+INV	Power for Panel
4	+INV	Power for Panel
5	NC	Non-Connection
6	NC	Non-Connection
7	GND	GND
8	GND	GND
9	VGA_TXOUT0-	Panel Data Signals
10	+LCDVDD	Power for Panel
11	VGA_TXOUT0+	Panel Data Signals
12	+LCDVDD	Power for Panel
13	VGA_TXOUT2-	Panel Data Signals
14	+3VS	Power for Panel
15	VGA_TXOUT2+	Panel Data Signals
16	INVT_PWM	Power for Panel
17	VGA_TXOUT1-	Panel Data Signals
18	DISPOFF#	LCD back light
19	VGA_TXOUT1+	Panel Data Signals
20	DAC_BRIG	Inverter Control signal
21	GND	GND
22	GND	GND
23	VGA_TXCLK-	Panel Clock Signals
24	VGA_LCD_CLK	LCD back light
25	VGA_TXCLK+	Panel Clock Signals
26	VGA_LCD_DATA	LCD DATA
27	GND	GND
28	GND	GND
29	VGA_TZOUT1+	Panel Data Signals
30	GND	GND
31	VGA_TZOUT1-	Panel Data Signals
32	GND	GND

33	VGA_TZOUT2+	Panel Data Signals
34	GND	GND
35	VGA_TZOUT2-	Panel Data Signals
36	GND	GND
37	VGA_TZOUT0+	Panel Data Signals
38	VGA_TZCLK-	Panel Clock Signals
39	VGA_TZOUT0-	Panel Data Signals
40	VGA_TZCLK+	Panel Clock Signals

C.8 JP41,JP42

Table C-8 Fan I/F pin assignments (3-pin)

Pin No.	Signal name	I/O	Pin No.	Signal Name	I/O
1	+FAN1_VOUT	I	2	FANSPEED1	O
3	GND	-			

C9 JP37

Table C-9 K/B connector pin assignments (34-pin)

Pin No.	Signal name	I/O	Pin No.	Signal Name	I/O
1	NUM_LED#	I	2	NC	-
3	CAPS_LED#	I	4	+3VS	I
5	KSI1	O	6	KSI6	I
7	KSI5	O	8	KSI0	O
9	KSI4	O	10	KSI3	O
11	KSI2	O	12	KSI7	O
13	KSO15	O	14	KSO12	O
15	KSO11	O	16	KSO10	O
17	KSO9	O	18	KSO8	O
19	KSO13	O	20	KSO7	O
21	KSO6	O	22	KSO14	O
23	KSO5	O	24	KSO3	O
25	KSO4	O	26	KSO0	O
27	KSO1	O	28	KSO2	O
29	NC	-	30	NC	-
31	KSO17	O	32	NC	-

33	KSO16	O	34	+3VS	I
----	-------	---	----	------	---

C.10 JP39

Table C-10 MDC Connector pin assignments (12-pin)

Pin No.	Signal name	I/O	Pin No.	Signal Name	I/O
1	GND	-	2	RES0	-
3	IAC_SDATA_OUT	O	4	RES1	-
5	GND	-	6	3.3V	O
7	IAC_SYNC	I/O	8	GND	-
9	IAC_SDATA_IN	I/O	10	GND	-
11	IAC_RESET	I/O	12	IAC_BITCLK	I/O

C.11 PJP1

Table C-119 AC Adaptor Connector pin assignments (4-pin)

Pin No.	Signal name	I/O	Pin No.	Signal Name	I/O
1	DC_IN_S1	I	2	DC_IN_S1	-
3	GND	-	4	GND	-

C.12 JP18

Table C-12 Microphone I/F pin assignments (6-pin)

Pin No.	Signal name	I/O	Pin No.	Signal Name	I/O
1	AGND	-	2	MIC1_L_1	I
3	MIC1_R_1	I	4	MIC_SENSE	I
5	GND	-	6	NC	-

C.13 JP21

Table C-13 Head phone Connector pin assignments (6-pin)

Pin No.	Signal name	I/O	Pin No.	Signal Name	I/O
1	GND	-	2	HPL	O
3	HPR	O	4	HP_SENSE	I
5	GND	-	6	NC	-

Appendix D Keyboard Scan/Character Codes

Table D-1 Scan codes (set 1 and set 2) (1/4)

Cap No.	Keytop	Code set 1		Code set 2		Note	
		Make	Break	Make	Break		
01	' ~	29	A9	0E	F0	0E	
02	1 !	02	82	16	F0	16	
03	2 @	03	83	1E	F0	1E	
04	3 #	04	84	26	F0	26	
05	4 \$	05	85	25	F0	25	
06	5 %	06	86	2E	F0	2E	
07	6 ^	07	87	36	F0	36	
08	7 &	08	88	3D	F0	3D	*2
09	8 *	09	89	3E	F0	3E	*2
10	9 (0A	8A	46	F0	46	*2
11	0)	0B	8B	45	F0	45	
12	- _	0C	8C	4E	F0	4E	
13	= +	0D	8D	55	F0	55	
15	BkSp	0E	8E	66	F0	66	
16	Tab	0F	8F	0D	F0	0D	
17	Q	10	90	15	F0	15	
18	W	11	91	1D	F0	1D	
19	E	12	92	24	F0	24	
20	R	13	93	2D	F0	2D	
21	T	14	94	2C	F0	2C	
22	Y	15	95	35	F0	35	
23	U	16	96	3C	F0	3C	*2
24	I	17	97	43	F0	43	*2
25	O	18	98	44	F0	44	*2
26	P	19	99	4D	F0	4D	*2
27	[{	1A	9A	54	F0	54	
28] }	1B	9B	5B	F0	5B	

Table D-1 Scan codes (set 1 and set 2) (2/4)

Cap No.	Keytop	Code set 1		Code set 2			Note
		Make	Break	Make	Break		
29	\	2B	AB	5D	F0	5D	*5
30	Caps Lock	3A	BA	58	F0	58	
31	A	1E	9E	1C	F0	1C	
32	S	1F	9F	1B	F0	1B	
33	D	20	A0	23	F0	23	
34	F	21	A1	2B	F0	2B	
35	G	22	A2	34	F0	34	
36	H	23	A3	33	F0	33	
37	J	24	A4	3B	F0	3B	*2
38	K	25	A5	42	F0	42	*2
39	L	26	A6	4B	F0	4B	*2
40	; :	27	A7	4C	F0	4C	*2
41	' "	28	A8	52	F0	52	
43	Enter	1C	9C	5A	F0	5A	*3
44	Shift (L)	2A	AA	12	F0	12	
45	No.102 key	56	D6	61	F0	61	
46	Z	2C	AC	1A	F0	1A	
47	X	2D	AD	22	F0	22	
48	C	2E	AE	21	F0	21	
49	V	2F	AF	2A	F0	2A	
50	B	30	B0	32	F0	32	
51	N	31	B1	31	F0	31	
52	M	32	B2	3A	F0	3A	*2
53	, <	33	B3	41	F0	41	*2
54	. >	34	B4	49	F0	49	*2
55	/ ?	35	B5	4A	F0	4A	*2
57	Shift (R)	36	B6	59	F0	59	

Table D-1 Scan codes (set 1 and set 2) (3/4)

Cap No.	Keytop	Code set 1		Code set 2			Note
		Make	Break	Make	Break		
58	Ctrl(L)	1D	9D	14	F0	14	*3
60	Alt (L)	38	B8	11	F0	11	*3
61	Space	39	B9	29	F0	29	
62	ALT (R)	E0 38	E0 B8	E0 11	E0 F0	11	
64	Ctrl(R)	E0 1D	E0 9D	E0 14	E0 F0	14	
75	Ins	E0 52	E0 D2	E0 70	E0 F0	70	*1
76	Del	E0 53	E0 D3	E0 71	E0 F0	71	*1
79	←	E0 4B	E0 CB	E0 6B	E0 F0	6B	*1
80	Home	E0 47	E0 C7	E0 6C	E0 F0	6C	*1
81	End	E0 4F	E0 CF	E0 69	E0 F0	69	*1
83	↑	E0 48	E0 C8	E0 75	E0 F0	75	*1
84	↓	E0 50	E0 D0	E0 72	E0 F0	72	*1
85	PgUp	E0 49	E0 C9	E0 7D	E0 F0	7D	*1
86	PgDn	E0 51	E0 D1	E0 7A	E0 F0	7A	*1
89	→	E0 4D	E0 CD	E0 74	E0 F0	74	*1
110	Esc	01	81	76	F0	76	
112	F1	3B	BB	05	F0	05	
113	F2	3C	BC	06	F0	06	
114	F3	3D	BD	04	F0	04	
115	F4	3E	BE	0C	F0	0C	
116	F5	3F	BF	03	F0	03	
117	F6	40	C0	0B	F0	0B	
118	F7	41	C1	83	F0	83	
119	F8	42	C2	0A	F0	0A	
120	F9	43	C3	01	F0	01	
121	F10	44	C4	09	F0	09	*3

Table D-1 Scan codes (set 1 and set 2) (4/4)

Cap No.	Keytop	Code set 1				Code set 2				Note
		Make		Break		Make		Break		
122	F11	57		D7		78		F0 78		*3
123	F12	58		D8		07		F0 07		*3
124	PrintSc	*6		*6		*6		*6		*6
126	Pause	*7		*7		*7		*7		*7
X	Fn	—		—		—		—		*4
X	Win	E0	5B	E0	DB	E0	1F	E0	F0 1F	
x	App	E0	5D	E0	DD	E0	2F	E0	F0 2F	

Notes:

1. * Scan codes differ by mode.
2. * Scan codes differ by overlay function.
3. * Combination with the **Fn** key gives different codes.
4. * The **Fn** key does not generate a code by itself.
5. * This key corresponds to key No. 42 in a 102-key model.
6. * Refer to Table D-6, No. 124 key scan code.
7. * Refer to Table D-7, No. 126 key scan code.

Table D-2 Scan codes with left Shift key

Cap No.	Key top	Code set 1		Code set 2	
		Make	Break	Make	Break
55	/	E0 AA E0 35	E0 B5 E0 2A	E0 F0 12 E0 4A	E0 F0 4A E0 12
75	INS	E0 AA E0 52	E0 D2 E0 2A	E0 F0 12 E0 70	E0 F0 70 E0 12
76	DEL	E0 AA E0 53	E0 D3 E0 2A	E0 F0 12 E0 71	E0 F0 71 E0 12
79	←	E0 AA E0 4B	E0 CB E0 2A	E0 F0 12 E0 6B	E0 F0 6B E0 12
80	Home	E0 AA E0 47	E0 C7 E0 2A	E0 F0 12 E0 6C	E0 F0 6C E0 12
81	End	E0 AA E0 4F	E0 CF E0 2A	E0 F0 12 E0 69	E0 F0 69 E0 12
83	↑	E0 AA E0 48	E0 C8 E0 2A	E0 F0 12 E0 75	E0 F0 75 E0 12
84	↓	E0 AA E0 50	E0 D0 E0 2A	E0 F0 12 E0 72	E0 F0 72 E0 12
85	PgUp	E0 AA E0 49	E0 C9 E0 2A	E0 F0 12 E0 7D	E0 F0 7D E0 12
86	PgDn	E0 AA E0 51	E0 D1 E0 2A	E0 F0 12 E0 7A	E0 F0 7A E0 12
89	→	E0 AA E0 4D	E0 CD E0 2A	E0 F0 12 E0 74	E0 F0 74 E0 12
X	Win	E0 AA E0 5B	E0 DB E0 2A	E0 F0 12 E0 1F	E0 F0 1F E0 12
X	App	E0 AA E0 5D	E0 DD E0 2A	E0 F0 12 E0 2F	E0 F0 2F E0 12

Note : The table above shows scan codes with the left **Shift** key. In combination with the right **Shift** key, scan codes are changed as listed below:

	With left Shift	With right Shift
Set 1	E0 AA _____	E0 B6
	E0 2A _____	E0 36
Set 2	E0 F0 12 _____	E0 F0 59
	E0 12 _____	E0 59

Table D-3 Scan codes in Numlock mode

Cap No.	Key top	Code set 1				Code set 2			
		Make		Break		Make		Break	
75	INS	E0 2A	E0 52	E0 D2	E0 AA	E0 12	E0 70	E0 F0	70 E0 F0 12
76	DEL	E0 2A	E0 53	E0 D3	E0 AA	E0 12	E0 71	E0 F0	71 E0 F0 12
79	←	E0 2A	E0 4B	E0 CB	E0 AA	E0 12	E0 6B	E0 F0	6B E0 F0 12
80	Home	E0 2A	E0 47	E0 C7	E0 AA	E0 12	E0 6C	E0 F0	6C E0 F0 12
81	End	E0 2A	E0 4F	E0 CF	E0 AA	E0 12	E0 69	E0 F0	69 E0 F0 12
83	↑	E0 2A	E0 48	E0 C8	E0 AA	E0 12	E0 75	E0 F0	75 E0 F0 12
84	↓	E0 2A	E0 50	E0 D0	E0 AA	E0 12	E0 72	E0 F0	72 E0 F0 12
85	PgUp	E0 2A	E0 49	E0 C9	E0 AA	E0 12	E0 7D	E0 F0	7D E0 F0 12
86	PgDn	E0 2A	E0 51	E0 D1	E0 AA	E0 12	E0 7A	E0 F0	7A E0 F0 12
89	→	E0 2A	E0 4D	E0 CD	E0 AA	E0 12	E0 74	E0 F0	74 E0 F0 12
X	Win	E0 2A	E0 5B	E0 DB	E0 AA	E0 12	E0 1F	E0 F0	1F E0 F0 12
X	App	E0 2A	E0 5D	E0 DD	E0 AA	E0 12	E0 2F	E0 F0	2F E0 F0 12

Table D-4 Scan codes with Fn key

Cap No.	Keytop	Code set 1		Code set 2	
		Make	Break	Make	Break
43	ENT	E0 1C	E0 9C	E0 5A	E0 F0 5A
58	L-CTRL	E0 1D	E0 9D	E0 14	E0 F0 14
60	L-ALT	E0 38	E0 B8	E0 11	E0 F0 11
121	ARROW	45	C5	77	F0 77
122	NUMERIC	45	C5	77	F0 77
123	Scrl	46	C6	7E	F0 7E

Table D-5 No.124 key scan code

Key top	Shift	Code set 1				Code set 2			
		Make		Break		Make		Break	
Prt Sc	Common	E0 2A	E0 37	E0 B7	E0 AA	E0 12	E0 7C	E0 F0	7C E0 F0 12
	Ctrl +	E0 37		E0 B7		E0 7C		E0 F0 7C	
	Shift +	E0 37		E0 B7		E0 7C		E0 F0 7C	
	Alt +		54	D4		84		F0 84	

Table D-7 No.126 key scan code

Key top	Shift	Code set 1				Code set 2			
		Make				Make			
Pause	Common	E1 1D	45 E1	9D E1	C5	E1 14	77 E1	F0 14	F0 77
	Ctrl	E0 46	E0 C6			E0 7E	E0 F0	7E	

*: This key generates only make codes.

1. United Status (US) Keyboard

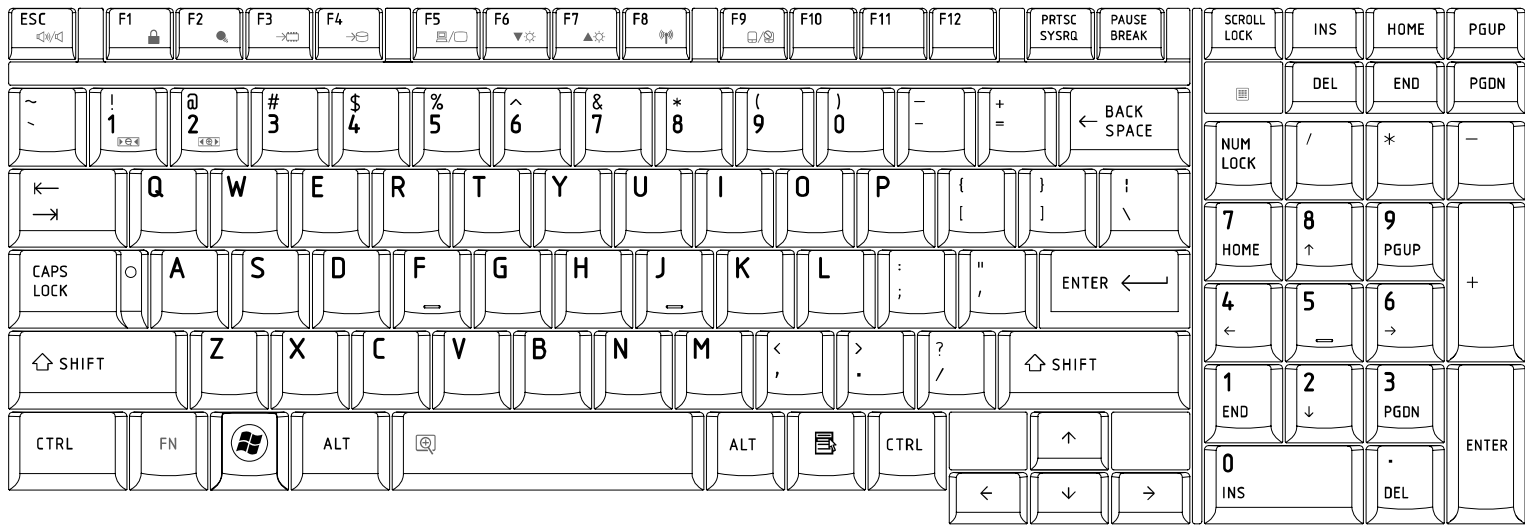

2. Traditional Chinese (CH) Keyboard



3. Thai (TI) Keyboard

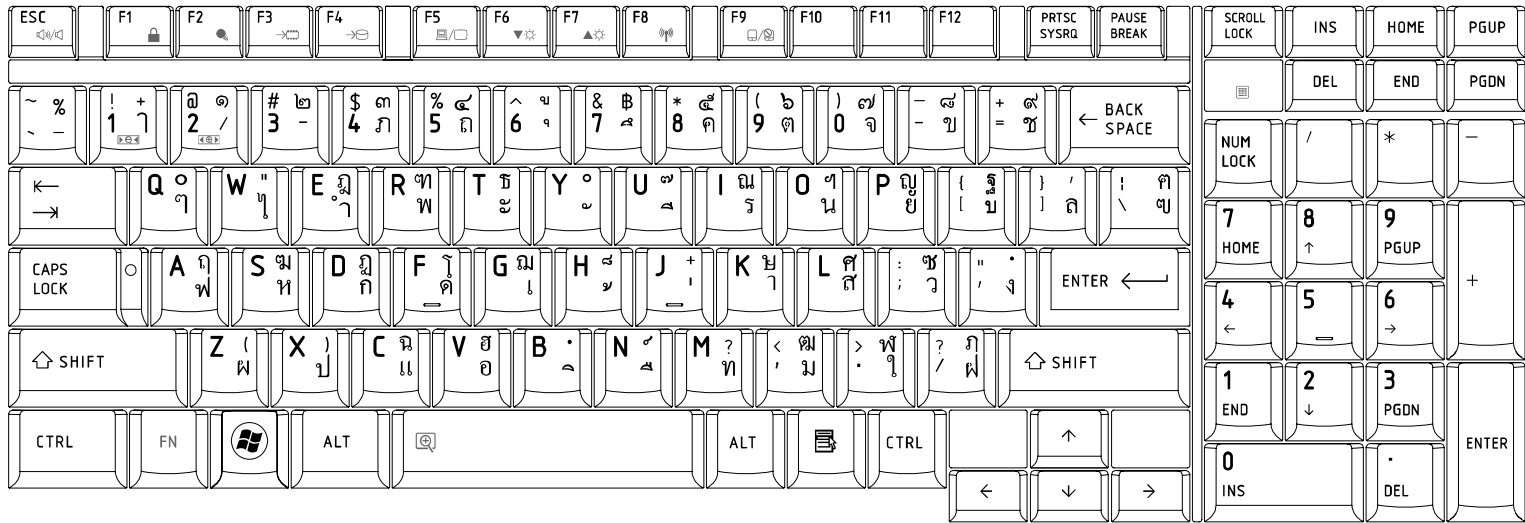

4. Korean (KO) Keyboard

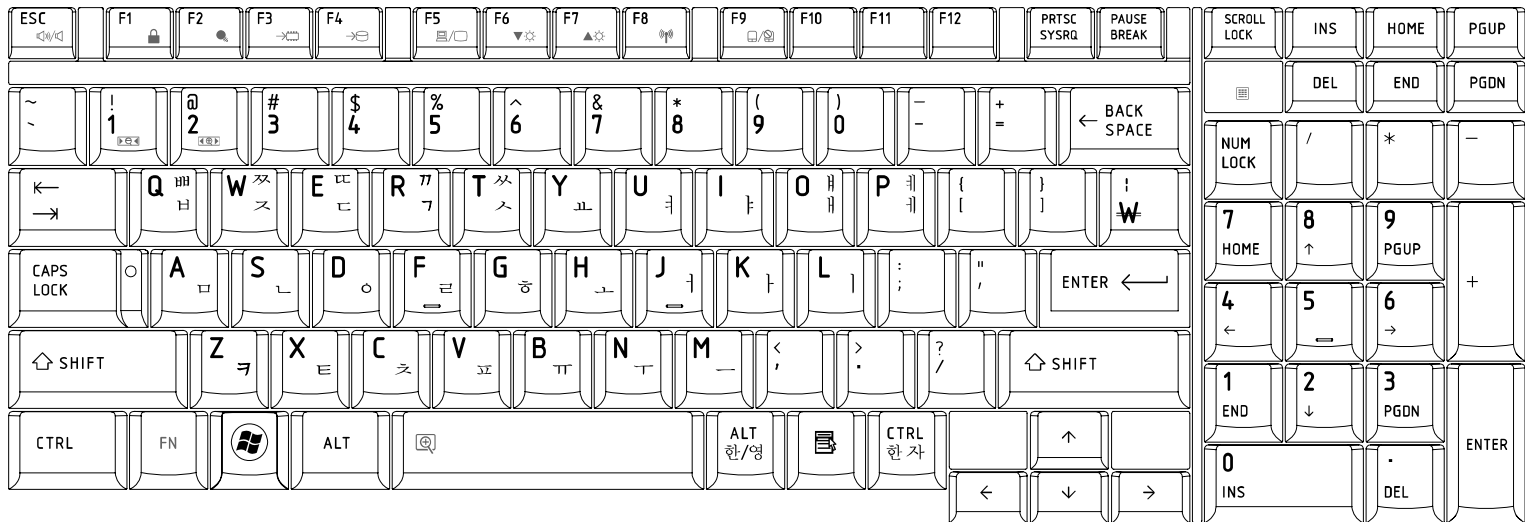

5. United Kingdom (UK) Keyboard

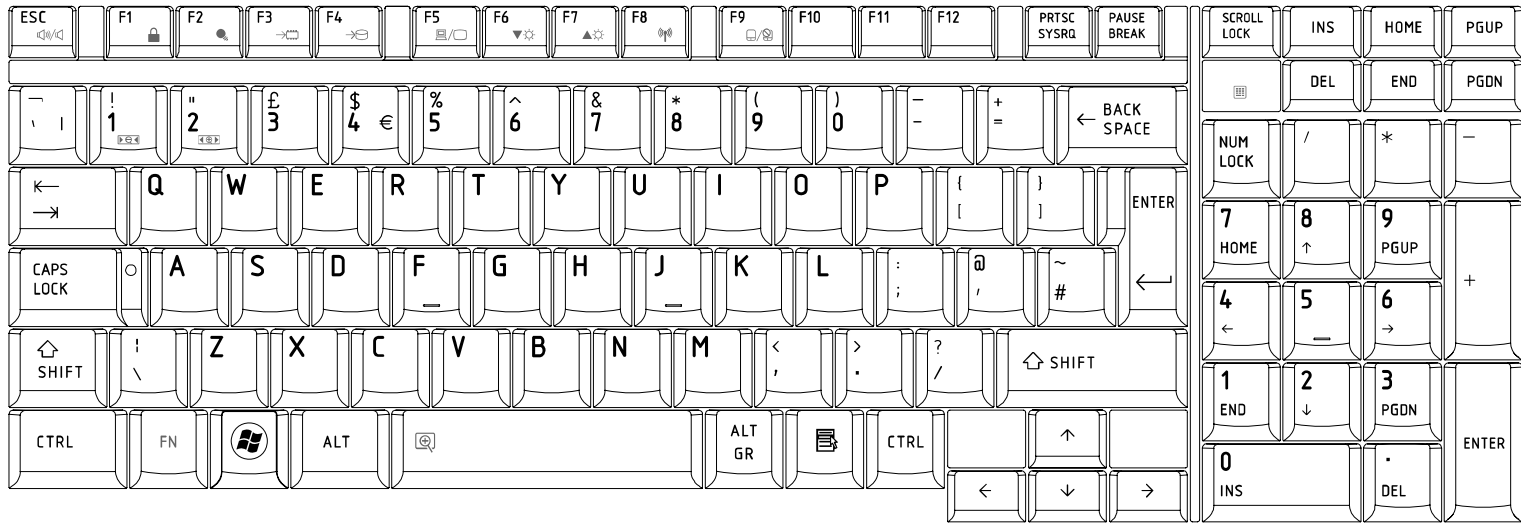

6. US International (UI) Keyboard

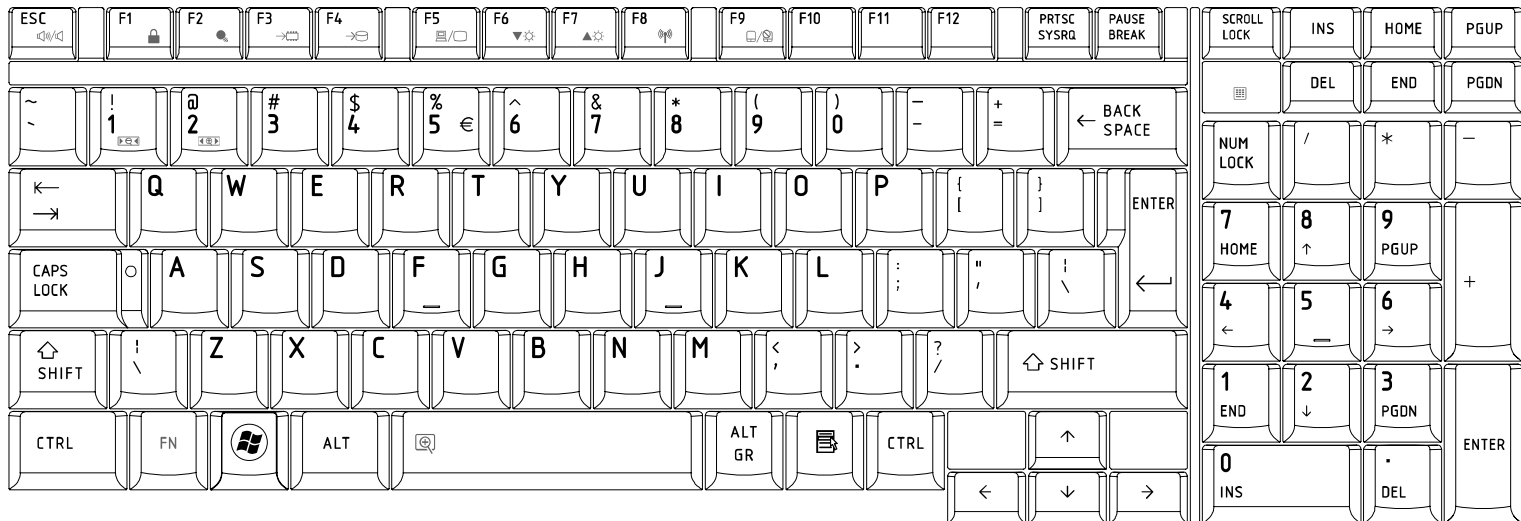

7. Hebrew (HB) Keyboard

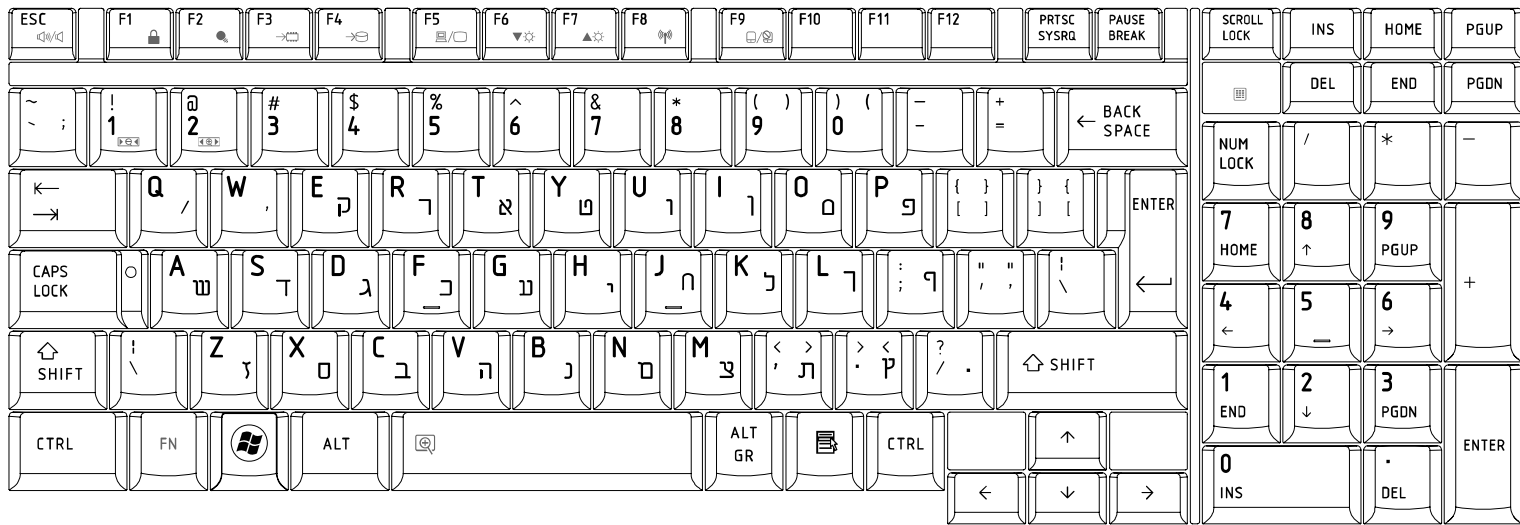

8. Danish (DM) Keyboard

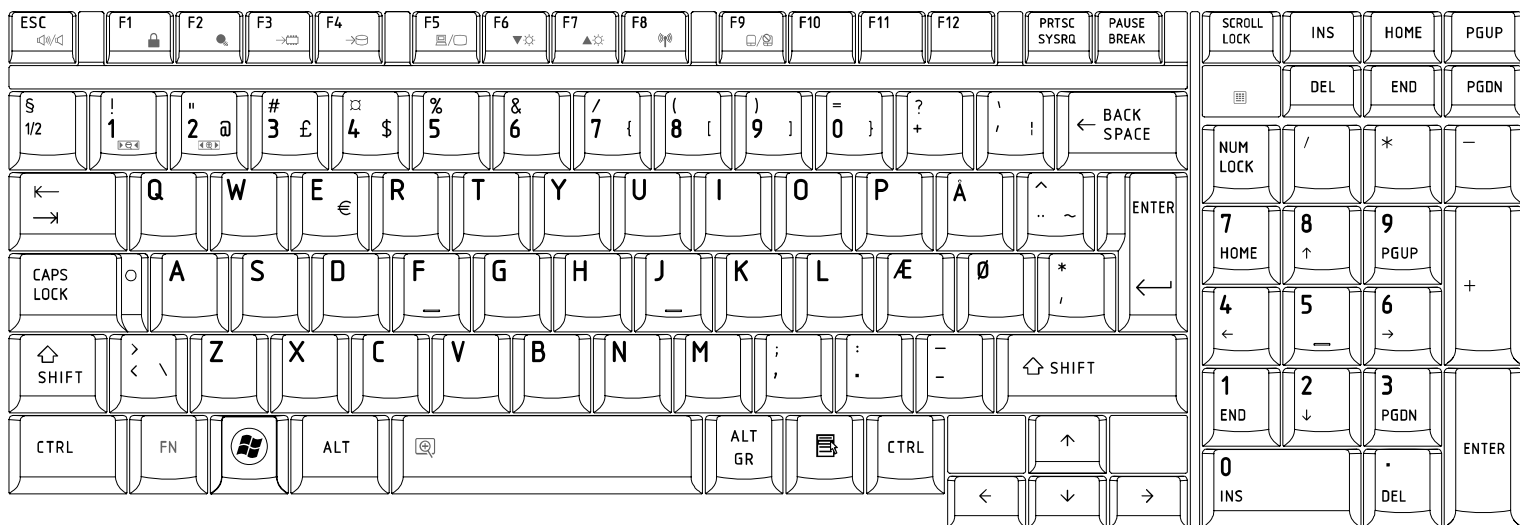

9. Swiss (SW) Keyboard

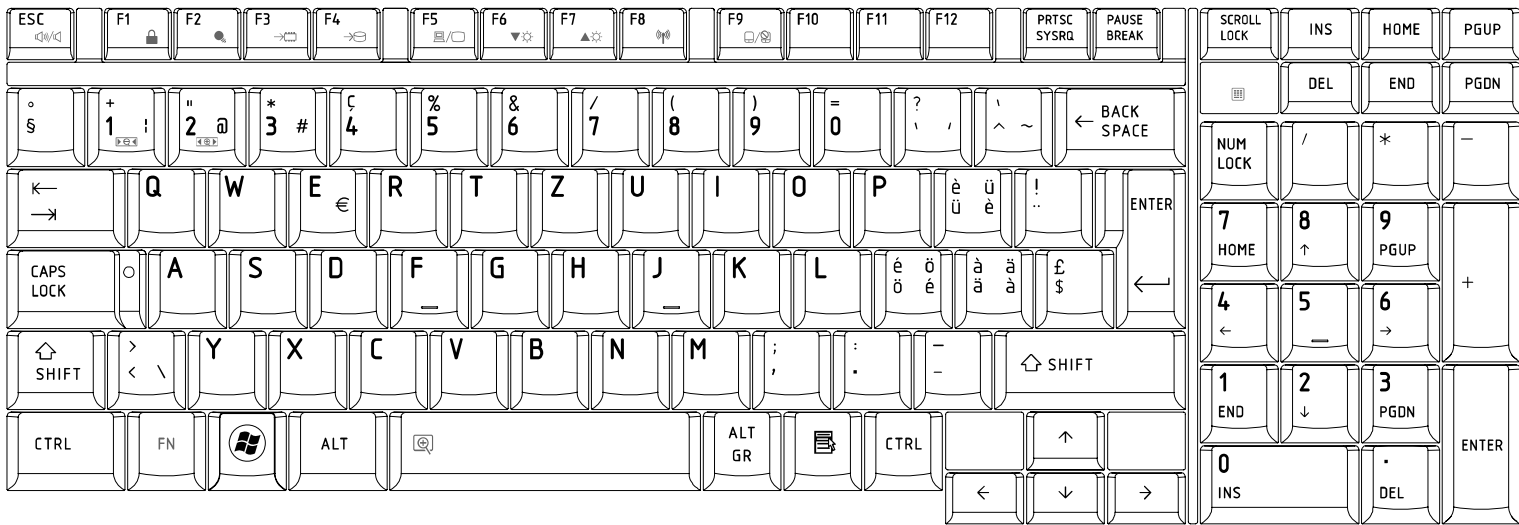

10. Arabic (ARE) Keyboard



11. Czech (CZ) Keyboard

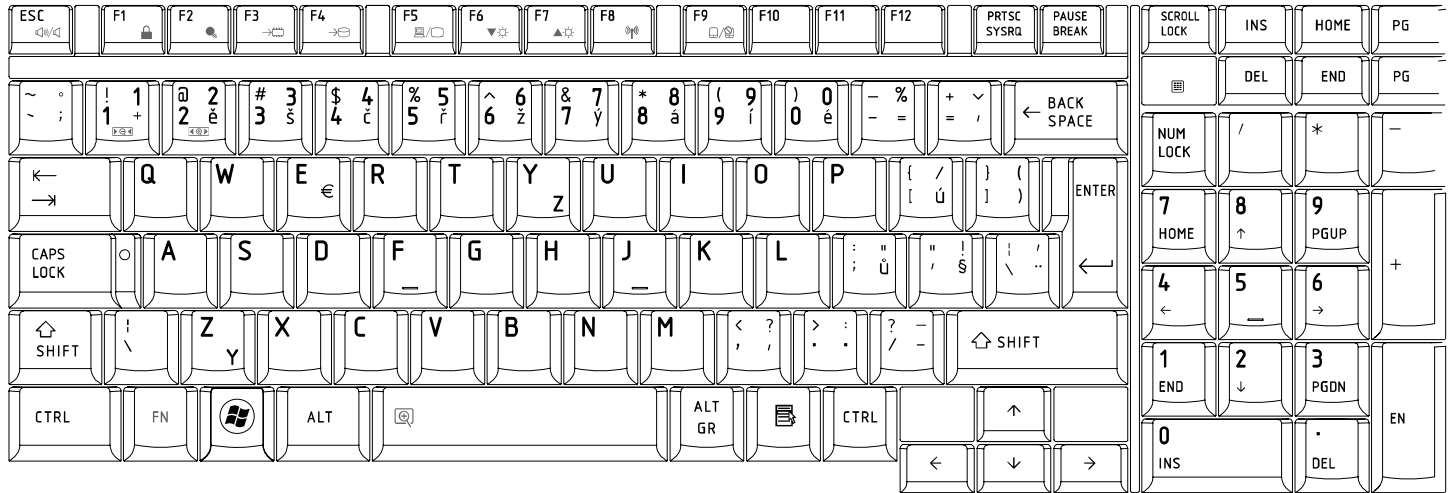

12. Russian (RU) Keyboard

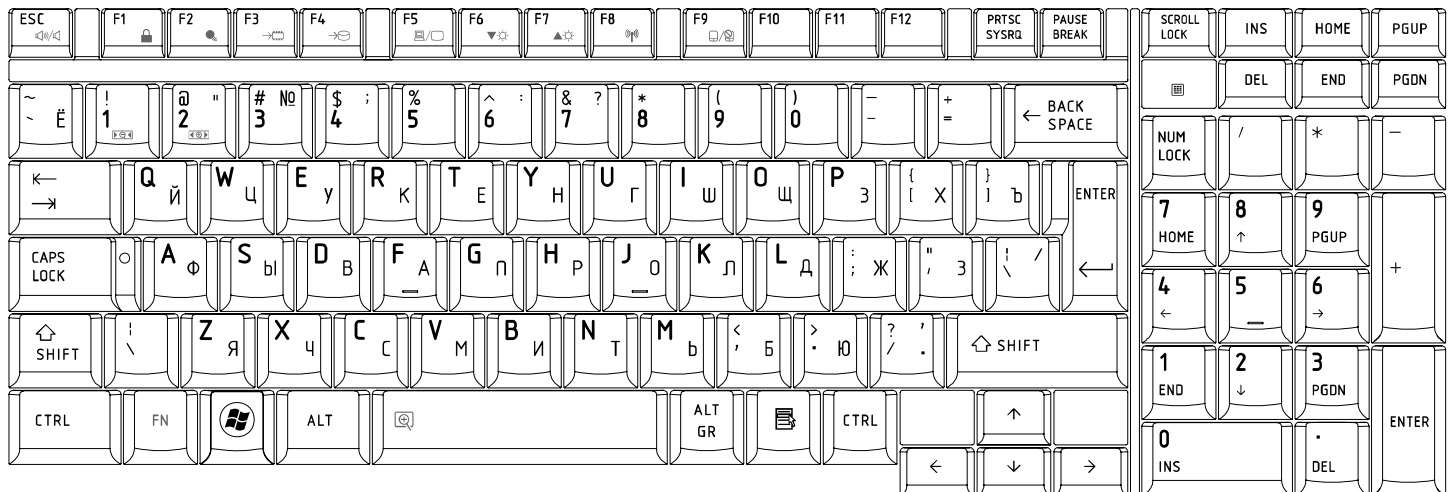

13. Portuguese (PO) Keyboard

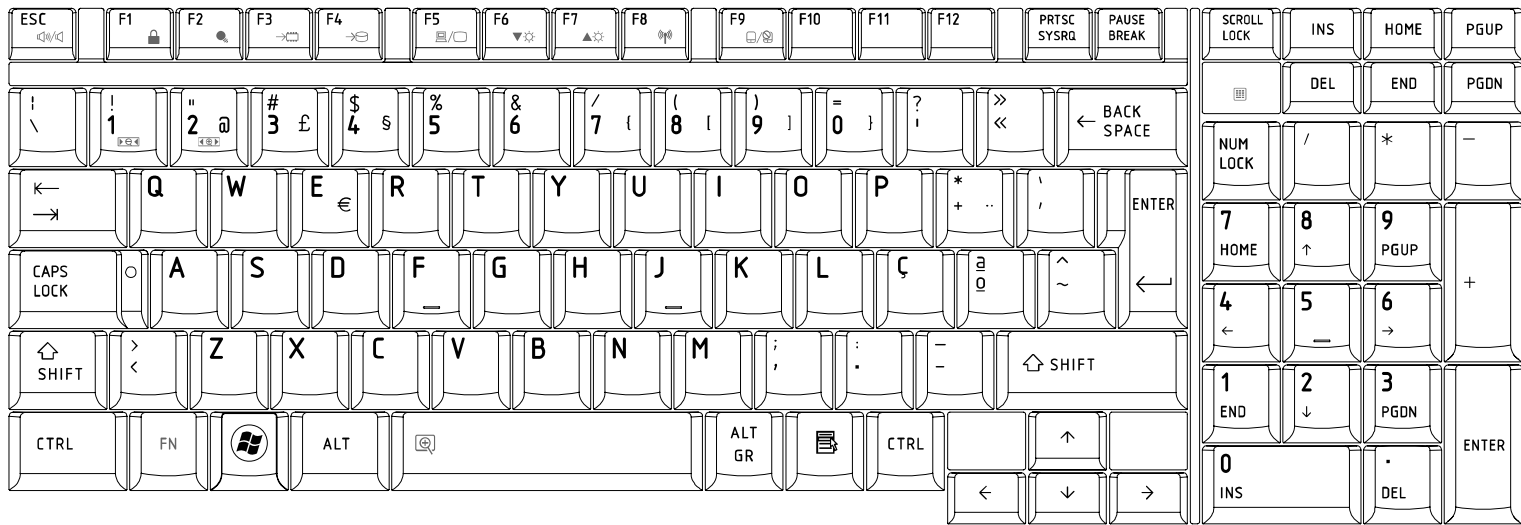

14. Slovakian (SL) Keyboard

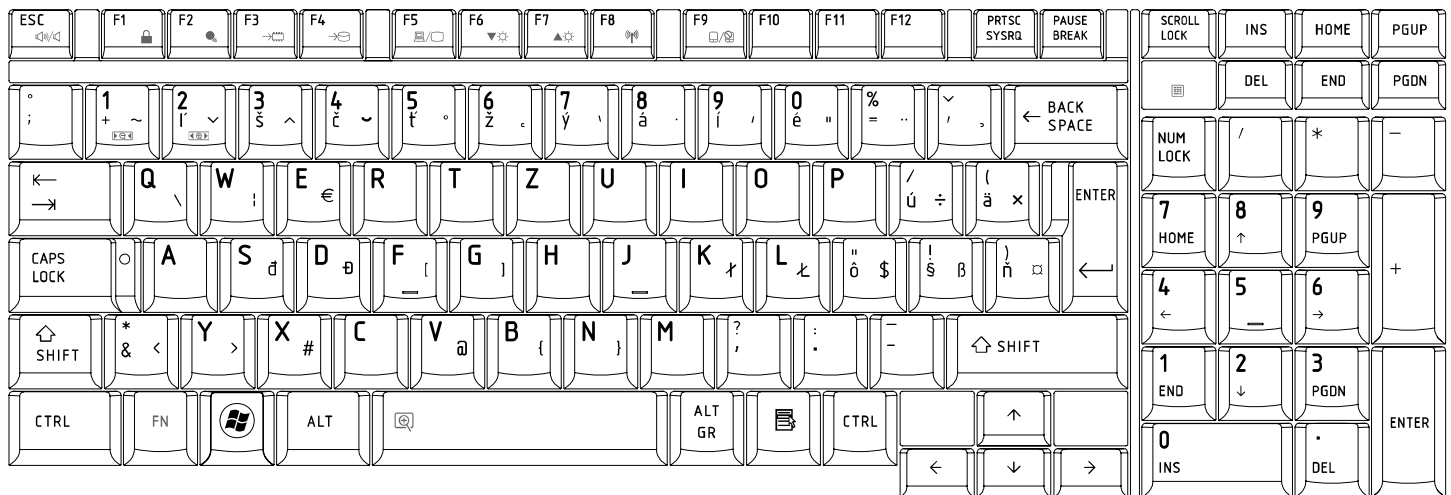

15. Italian (IT) Keyboard

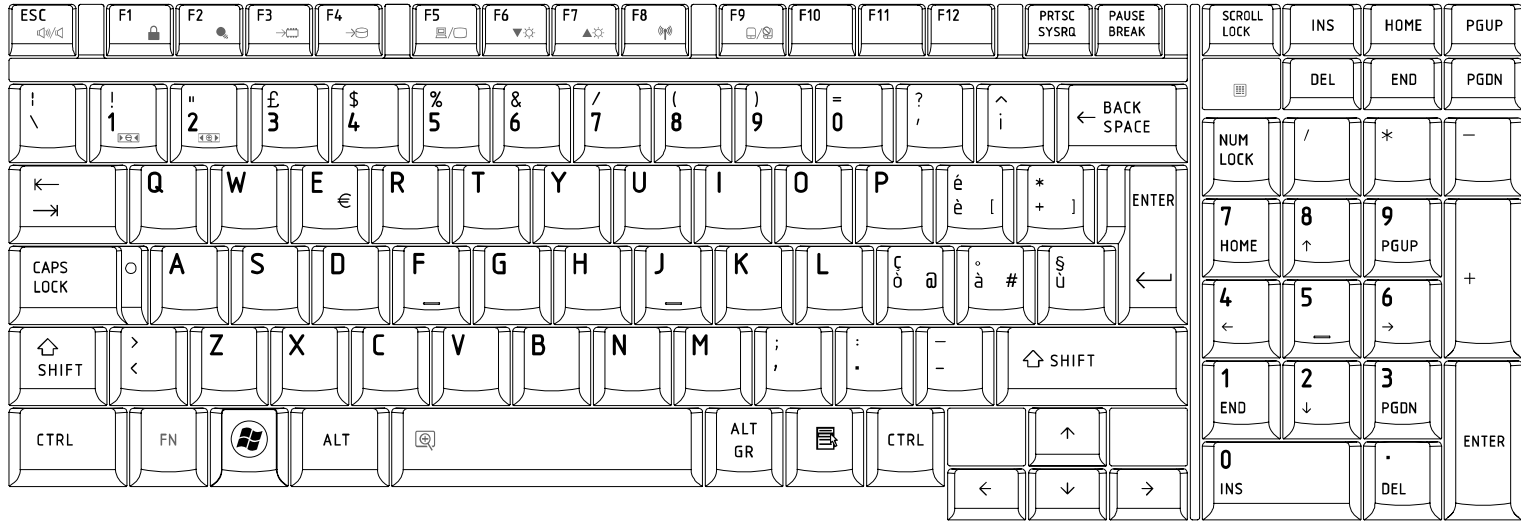

16. French (FR) Keyboard



17. German (GR) Keyboard

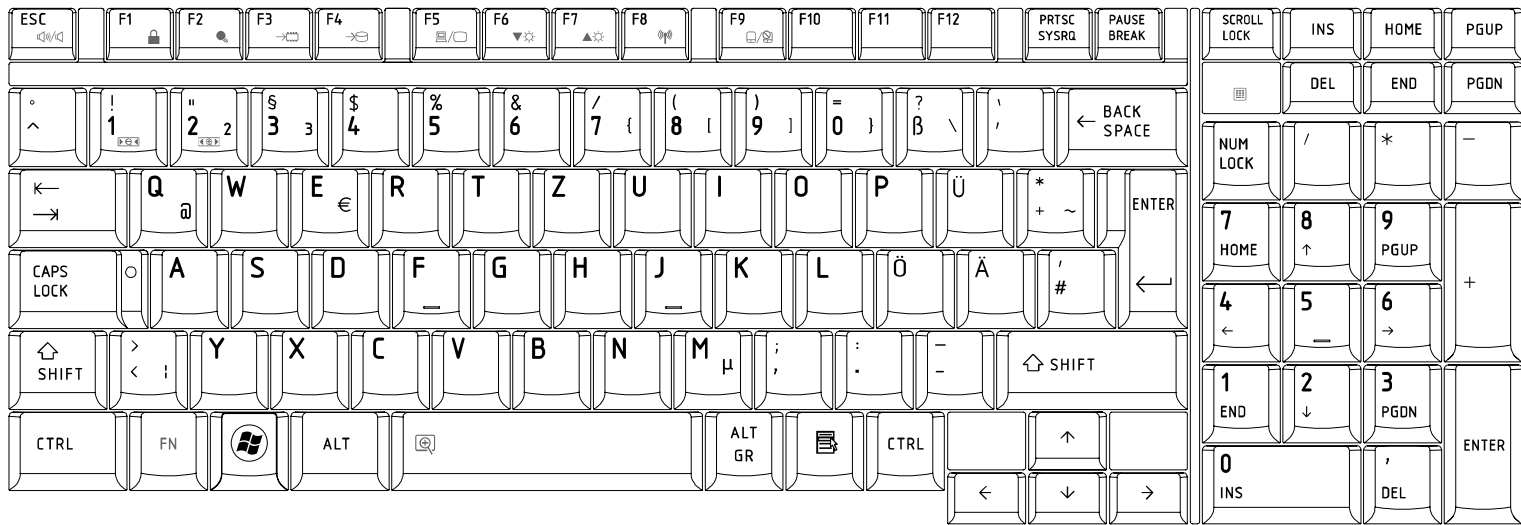

18. Greek (GK) Keyboard

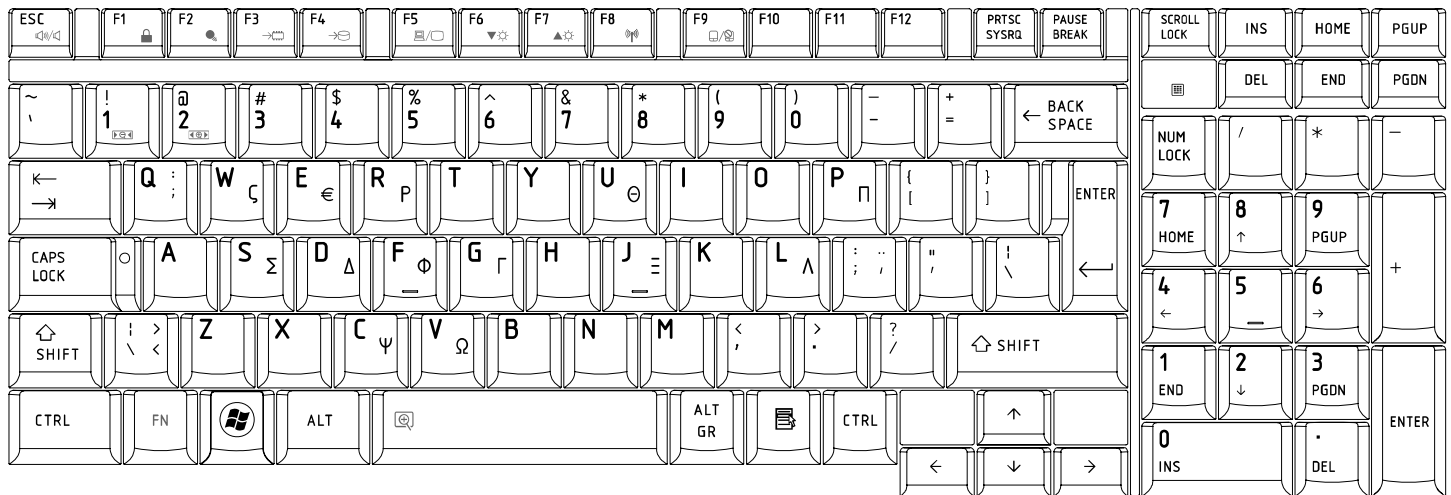

19. Hungarian (HG) Keyboard



20. Spanish (SP) Keyboard

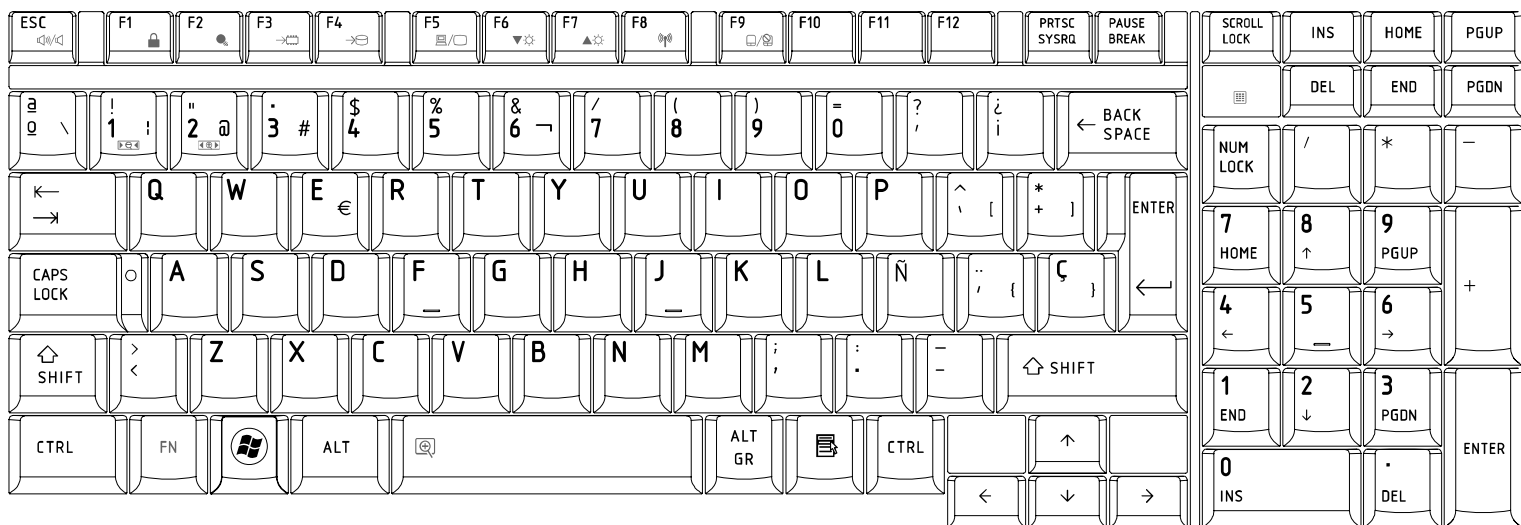

21. Turkish (TR) Keyboard

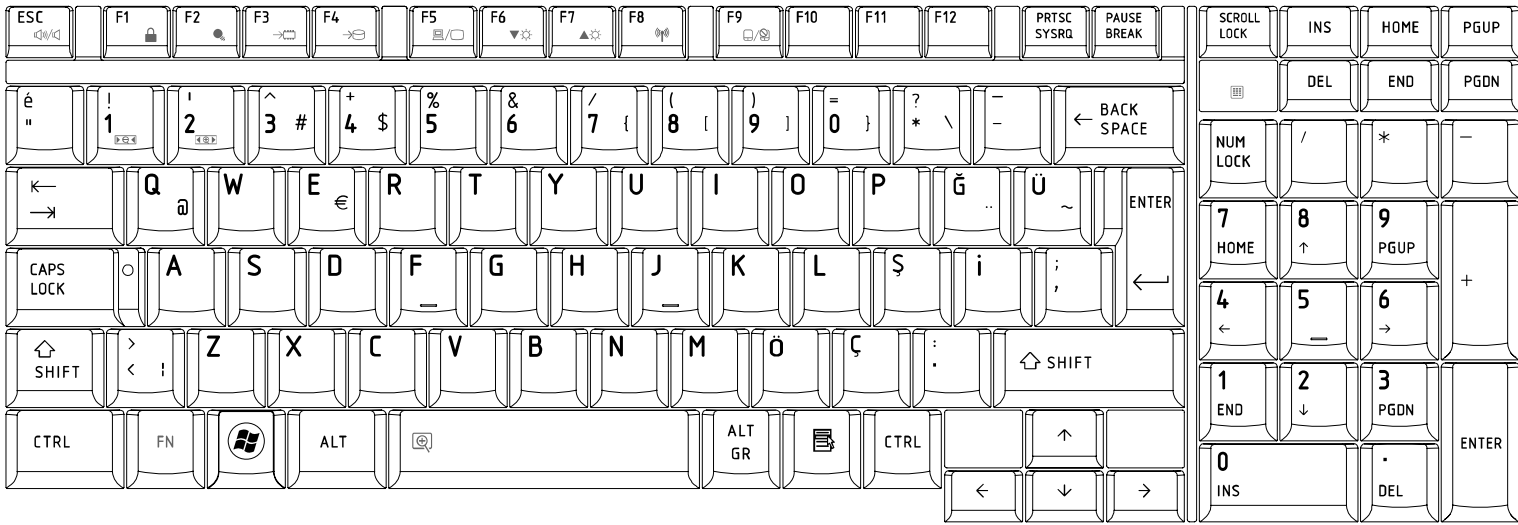

22. Turkish F (TR-F) Keyboard

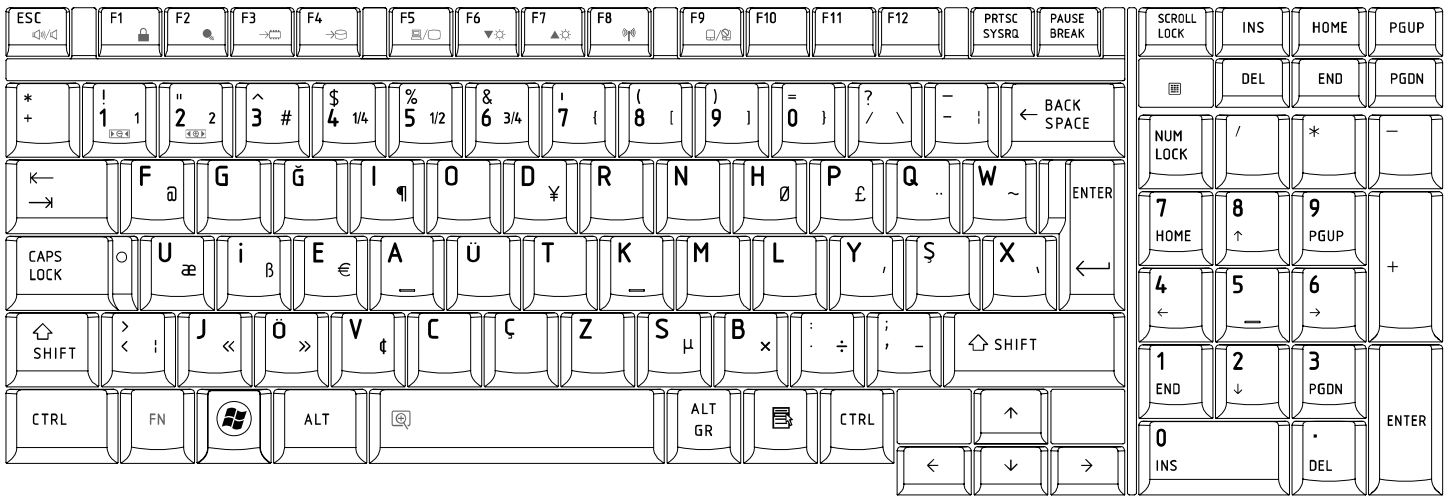

23.Swedish (SD) Keyboard

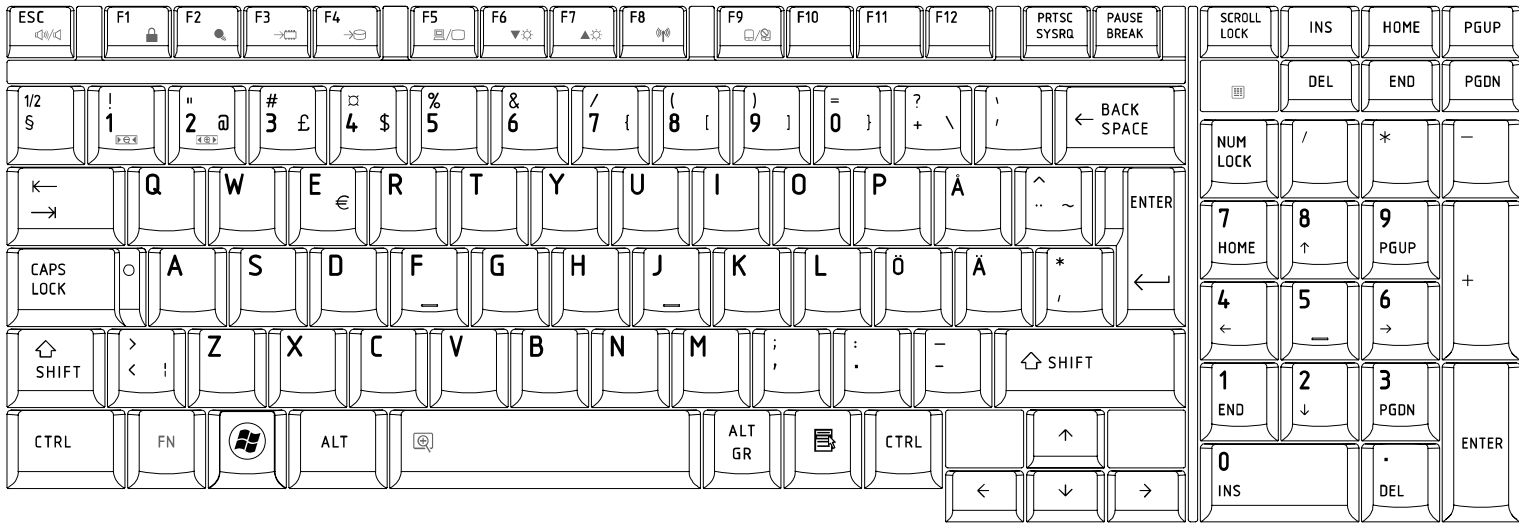

24.Belgian (BE) Keyboard

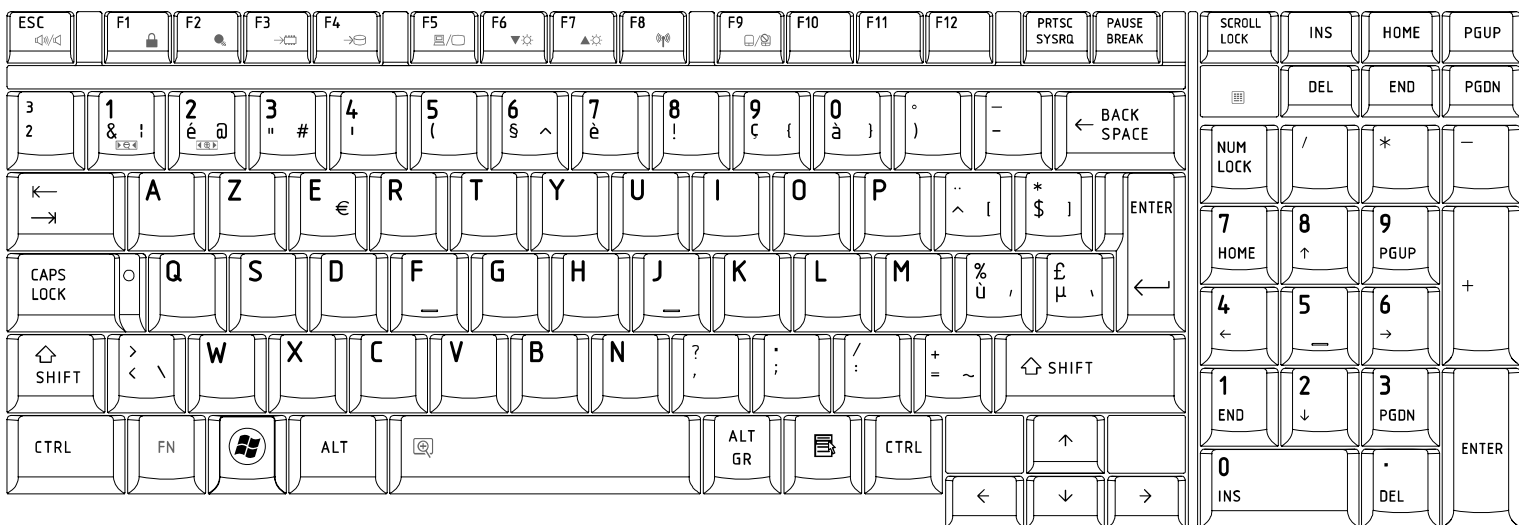

25. Yugoslavian (YU) Keyboard

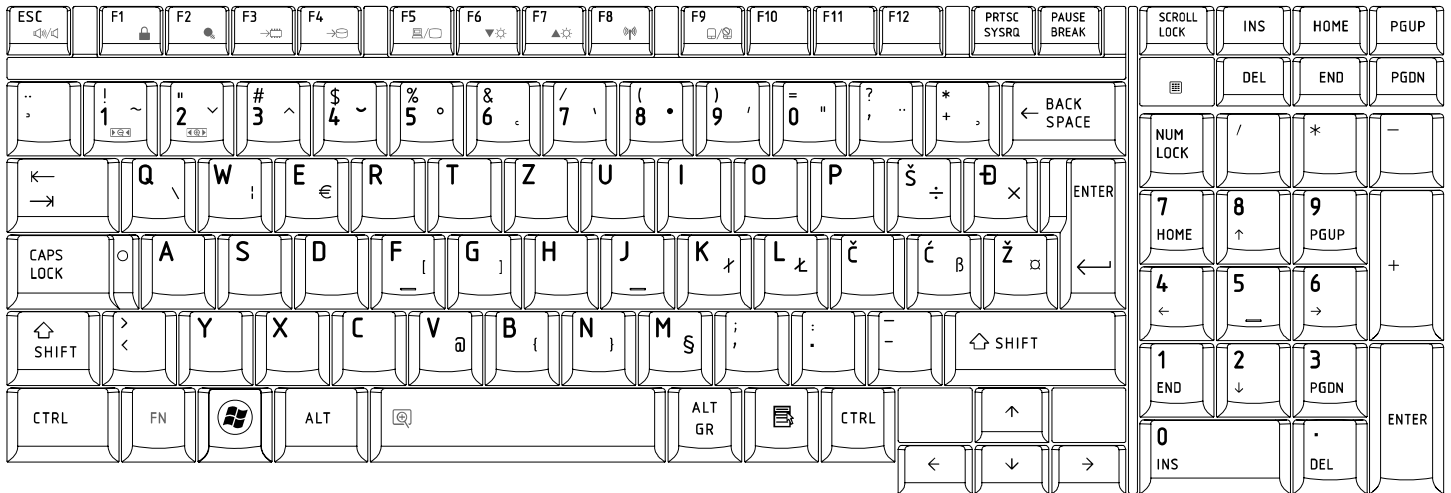

26. Norwegian (NW) Keyboard

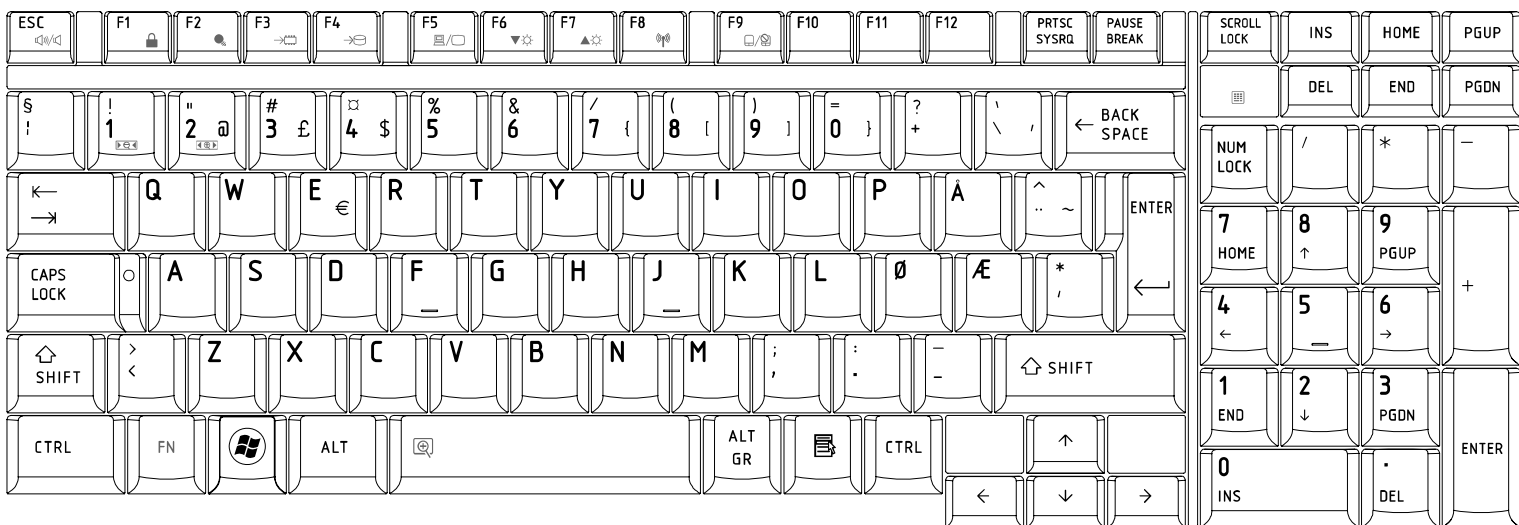

27.Scandinavian (ND) Keyboard

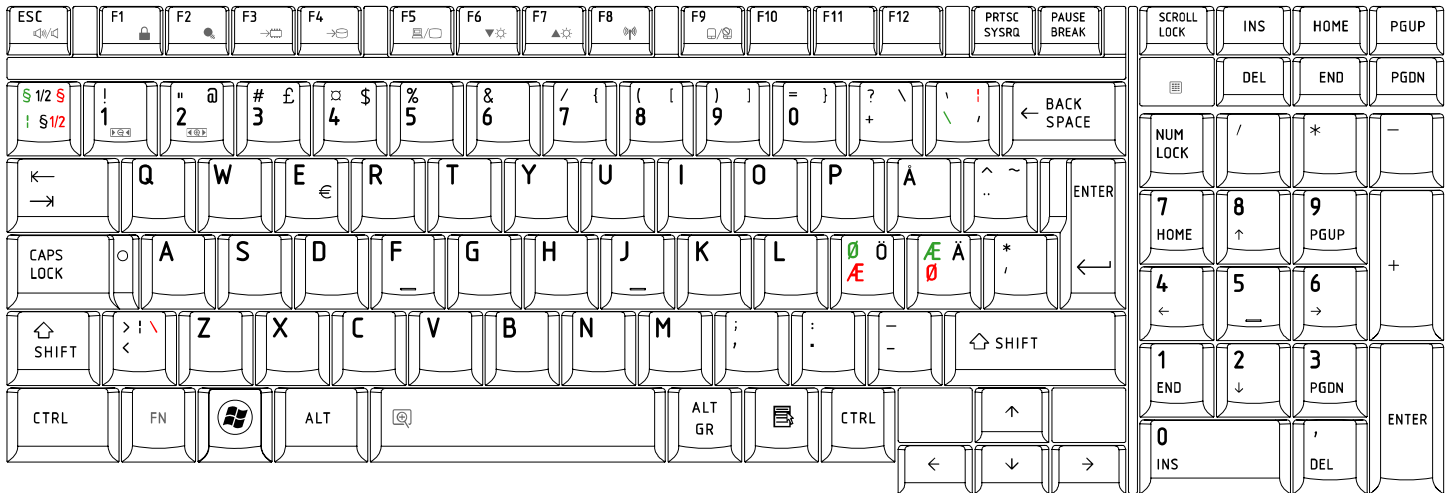

28.Canadian Multinational(AC)Keyboard



29. Canadian Bilingual (CB) Keyboard

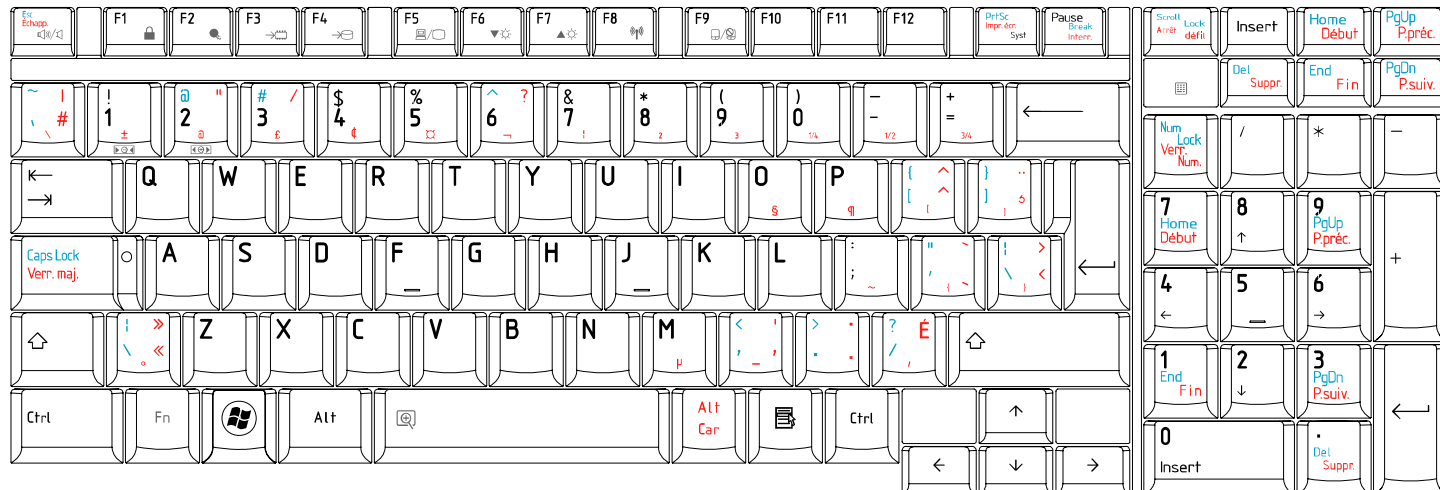

30. Japanese (JP) Keyboard

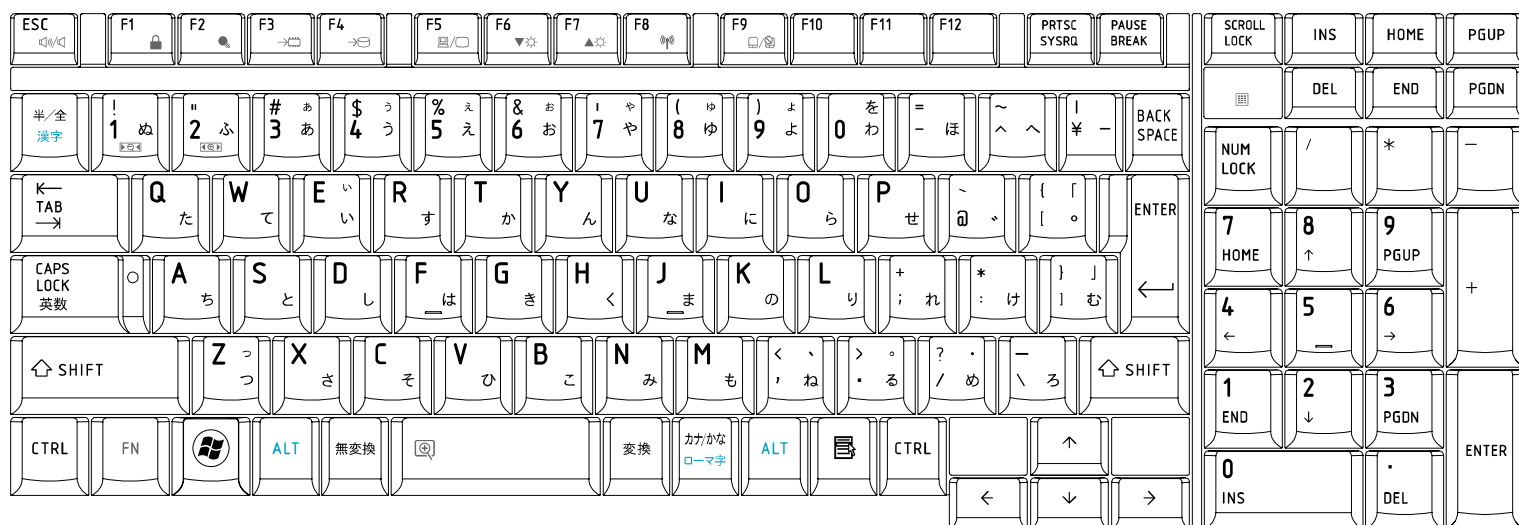

Appendix F Series Screw Torque List

Table F-1 Series Screw Torque List

SCREW P/N	DISCRIPTION	Q'ty	LOCATION	SCREW TORQUE
	LCD ASSY			
MACK20030G0	M2*3	8	LCD hinge brkt L&R to LCD	1.2~1.5Kgf.cm
MA0000069G0	M2*4	1	For singe inverter	1.5~2.0Kgf.cm
MAC925006G0	M2.5*6	6	For Cover & arm	2.5~3.0Kgf.cm
		2	Bezel up side to Cover	
MACK25070G0	M2.5*7	2	Bezel down side to Cover	2.5~3.0Kgf.cm
	MB ASSY			
MMCK20094G0	M2*2	2	Express slot to MB	1.2~1.5Kgf.cm
MACK20251G0	M2*2.5	2	mini card to MB stand-off	1.5~2.0Kgf.cm
		2	wireless card to MB stand-off	1.5~2.0Kgf.cm
MA0000069G0	M2*4	2	MB to Battery conn	1.5~2.0Kgf.cm
		2	EXPRESS conn to MB	
MMCK20060G0	M2*6	2	MB to 1'st HDD conn	1.5~2.0Kgf.cm
MA0000081G0	M2*6	2	MB to ODD conn	1.5~2.0Kgf.cm
MA000007TG0	M2*8	2	MB to 2'nd HDD conn	1.5~2.0Kgf.cm
MA000005WG0	M2.5*3	2	MDC card to MB stand-off	2.5~3.0Kgf.cm
		2	NB thermal to MB stand-off	
		4	VGA Support to MB stand-off	
		4	CPU thermal to MB stand-off	
MACA00083G0	M2.5*4	4	CPU supp brk to MB	2.5~3.0Kgf.cm
		3	VGA_Board to MB	
MA000005WG0	M2.5*3	2	MB to Thermal Fan	2.0~2.5Kgf.cm
MA000009AG0	M2.5*2	2	MB to NB stand-off	2.0~2.5Kgf.cm
AM017000800	VGA_SPRING_SCREW	4	VGA thermal module to VGA pcb	2.0~2.5Kgf.cm
	LOG UPPER ASSY			
MA000005WG0	M2.5*3	5	TP BKT to Upper	2.0~2.5Kgf.cm
		4	F/P BRKT to Upper	2.0~2.5Kgf.cm
	LOG LOWER ASSY			
MACA00083G0	M2.5*4	2	MB to Lower	2.5~3.0Kgf.cm
		1	USB/B to Lower	
		1	Function PCB to Strip coer	
		3	VGA Fan to Lower	
	LOGIC ASSY			
MA0000069G0	M2.0*4	4	K/B to Upper	1.5~2.0Kgf.cm
		1	LVDS to Upper	
MMCK20060G0	M2*6	1	CRT Board to Lower	1.5~2.0Kgf.cm

MA000005WG0	M2.5*3	1	Lower(HDD housing) to Upper	2.0~2.5Kgf.cm
MACA00083G0	M2.5*4	1	Lower(ODD) to Upper	2.5~3.0Kgf.cm
		1	Lower(HDD housing) to Upper	
		2	Lower(Batt housing) to Upper	
		3	1'st HDD Door x1, 2'nd HDD Door x2	
MA0000067G0	M2.5*6.5	1	RAM Door	2.5~3.0Kgf.cm
MAC925006G0	M2.5*6	2	From Upper Fix to Lower	2.5~3.0Kgf.cm
		1	Speaker L to Lower	
MACK25080G0	M2.5*8	14	Lower to Upper	2.5~3.0Kgf.cm
		4	Upper (KB support) to Lower	
		1	Lower(ODD) to Upper	
		2	hinge Saddle to Lower	
		2	LCD hinge to Saddle	4.0~4.5Kgf.cm
MACA00300G0	M2.5*20	1	Upper (KB support) to Lower	2.5~3.0Kgf.cm
MAFA94001N0	4.75*9.6+SW	2	Lower to D-sub conn	2.5~3.0Kgf.cm
	HDD ASSY			
MAAA03032G0	M3*3	4	HDD BRK L/R to HDD	2.5~3.0Kgf.cm
	ODD ASSY			
MACK20251G0	M2*2.5	2	ODD BRK to ODD	1.5~2.0Kgf.cm

Appendix G Reliability

The following table shows MTBF (Mean Time Between Failures) for each component.

Table G-1 MTBF

Component	Time (hours)
LCD	10,000
Keyboard	60,000
HDD	300,000
Optical (DVD/CD) drive	60,000
AC adaptor	60,000

Free Manuals Download Website

<http://myh66.com>

<http://usermanuals.us>

<http://www.somanuals.com>

<http://www.4manuals.cc>

<http://www.manual-lib.com>

<http://www.404manual.com>

<http://www.luxmanual.com>

<http://aubethermostatmanual.com>

Golf course search by state

<http://golfingnear.com>

Email search by domain

<http://emailbydomain.com>

Auto manuals search

<http://auto.somanuals.com>

TV manuals search

<http://tv.somanuals.com>