

# TOSHIBA

## Industrial Inverter (For 3-phase induction motors)

---

### Instruction Manual

---

# TOSVERT™ VF-S11

< Simplified manual >

1-phase 240V class	0.2 to 2.2kW
3-phase 240V class	0.4 to 15kW
3-phase 500V class	0.4 to 15kW
3-phase 600V class	0.75 to 15kW

#### NOTICE

1. Make sure that this instruction manual is delivered to the end user of the inverter unit.
2. Read this manual before installing or operating the inverter unit, and store it in a safe place for reference.



E6581160

Safety precautions	<b>I</b>
Contents	
Read first	<b>1</b>
Connection	<b>2</b>
Operations	<b>3</b>
Basic VF-S11 operations	<b>4</b>
Monitoring the operation status	<b>5</b>
Measures to satisfy the standards	<b>6</b>
Table of parameters and data	<b>7</b>
Specifications	<b>8</b>
Before making a service call	<b>9</b>

# I. Safety precautions

The items described in these instructions and on the inverter itself are very important so that you can use the inverter safely, prevent injury to yourself and other people around you as well as to prevent damage to property in the area. Thoroughly familiarize yourself with the symbols and indications shown below and then continue to read the manual. Make sure that you observe all warnings given.





## Explanation of markings

Marking	Meaning of marking
 <b>Danger</b>	Indicates that errors in operation may lead to death or serious injury.
 <b>Warning</b>	Indicates that errors in operation may lead to injury (*1) to people or that these errors may cause damage to physical property. (*2)

(\*1) Such things as injury, burns or shock that will not require hospitalization or long periods of outpatient treatment.

(\*2) Physical property damage refers to wide-ranging damage to assets and materials.

## Meanings of symbols

Marking	Meaning of marking
	Indicates prohibition (Don't do it). What is prohibited will be described in or near the symbol in either text or picture form.
	Indicates something mandatory (must be done). What is mandatory will be described in or near the symbol in either text or picture form.
	Indicates danger. What is dangerous will be described in or near the symbol in either text or picture form.
	Indicates warning. What the warning should be applied to will be described in or near the symbol in either text or picture form.

## ■ Limits in purpose





This inverter is used for controlling speeds of three-phase induction motors in general industrial use.





### Safety precautions



- ▼ The inverter cannot be used in any device that would present danger to the human body or from which malfunction or error in operation would present a direct threat to human life (nuclear power control device, aviation and space flight control device, traffic device, life support or operation system, safety device, etc.). If the inverter is to be used for any special purpose, first get in touch with the supplier.
- ▼ This product was manufactured under the strictest quality controls but if it is to be used in critical equipment, for example, equipment in which errors in malfunctioning signal output system would cause a major accident, safety devices must be installed on the equipment.
- ▼ Do not use the inverter for loads other than those of properly applied three-phase induction motors in general industrial use. (Use in other than properly applied three-phase induction motors may cause an accident.)



**■ General Operation**

 <b>Danger</b>	
 Disassembly prohibited	<ul style="list-style-type: none"> <li>Never disassemble, modify or repair. This can result in electric shock, fire and injury. For repairs, call your sales distributor.</li> </ul>
 Prohibited	<ul style="list-style-type: none"> <li>Never remove the front cover when power is on or open door if enclosed in a cabinet. The unit contains many high voltage parts and contact with them will result in electric shock.</li> <li>Don't stick your fingers into openings such as cable wiring hole and cooling fan covers. This can result in electric shock or other injury.</li> <li>Don't place or insert any kind of object into the inverter (electrical wire cuttings, rods, wires etc.). This can result in electric shock or fire.</li> <li>Do not allow water or any other fluid to come in contact with the inverter. This can result in electric shock or fire.</li> </ul>
 Mandatory	<ul style="list-style-type: none"> <li>Turn power on only after attaching the front cover or closing door if enclosed in a cabinet. If power is turned on without the front cover attached or closing door if enclosed in a cabinet, this can result in electric shock or other injury.</li> <li>If the inverter begins to emit smoke or an unusual odor, or unusual sounds, immediately turn power off. If the equipment is continued in operation in such a state, the result may be fire. Call your local sales agency for repairs.</li> <li>Always turn power off if the inverter is not used for long periods of time since there is a possibility of malfunction caused by leaks, dust and other material. If power is left on with the inverter in that state, it may result in fire.</li> </ul>



 <b>Warning</b>																		
 Prohibited contact	<ul style="list-style-type: none"> <li>Do not touch heat radiating fins or discharge resistors. These device are hot, and you'll get burned if you touch them.</li> </ul>																	
 Prohibited	<ul style="list-style-type: none"> <li>Avoid operation in any location where there is direct spraying of the following solvents or other chemicals. The plastic parts may be damaged to a certain degree depending on their shape, and there is a possibility of the plastic covers coming off. If the chemical or solvent is anything other than those shown below, please contact us in advance.</li> </ul> <table style="width: 100%; border-collapse: collapse;"> <tr> <td style="width: 50%; vertical-align: top;"> <p>(Table 1) Examples of applicable chemicals and solvents</p> <table border="1" style="width: 100%; border-collapse: collapse;"> <tr><td>Acetic acid (density of 10% or less)</td></tr> <tr><td>Hydrochloric acid (density of 10% or less)</td></tr> <tr><td>Sulfuric acid (density of 10% or less)</td></tr> <tr><td>Sodium chloride</td></tr> <tr><td>Hexane</td></tr> <tr><td>Triethylene glycol</td></tr> </table> </td> <td style="width: 50%; vertical-align: top;"> <p>(Table 2) Examples of unapplicable chemicals and solvents</p> <table border="1" style="width: 100%; border-collapse: collapse;"> <tr><td>Acetone</td></tr> <tr><td>Benzene</td></tr> <tr><td>Chloroform</td></tr> <tr><td>Ethylene chloride</td></tr> <tr><td>Ethyl acetate</td></tr> <tr><td>Glycerin</td></tr> <tr><td>Tetrachloroethylene</td></tr> <tr><td>Trichloroethylene</td></tr> <tr><td>Xylene</td></tr> </table> </td> </tr> </table>	<p>(Table 1) Examples of applicable chemicals and solvents</p> <table border="1" style="width: 100%; border-collapse: collapse;"> <tr><td>Acetic acid (density of 10% or less)</td></tr> <tr><td>Hydrochloric acid (density of 10% or less)</td></tr> <tr><td>Sulfuric acid (density of 10% or less)</td></tr> <tr><td>Sodium chloride</td></tr> <tr><td>Hexane</td></tr> <tr><td>Triethylene glycol</td></tr> </table>	Acetic acid (density of 10% or less)	Hydrochloric acid (density of 10% or less)	Sulfuric acid (density of 10% or less)	Sodium chloride	Hexane	Triethylene glycol	<p>(Table 2) Examples of unapplicable chemicals and solvents</p> <table border="1" style="width: 100%; border-collapse: collapse;"> <tr><td>Acetone</td></tr> <tr><td>Benzene</td></tr> <tr><td>Chloroform</td></tr> <tr><td>Ethylene chloride</td></tr> <tr><td>Ethyl acetate</td></tr> <tr><td>Glycerin</td></tr> <tr><td>Tetrachloroethylene</td></tr> <tr><td>Trichloroethylene</td></tr> <tr><td>Xylene</td></tr> </table>	Acetone	Benzene	Chloroform	Ethylene chloride	Ethyl acetate	Glycerin	Tetrachloroethylene	Trichloroethylene	Xylene
<p>(Table 1) Examples of applicable chemicals and solvents</p> <table border="1" style="width: 100%; border-collapse: collapse;"> <tr><td>Acetic acid (density of 10% or less)</td></tr> <tr><td>Hydrochloric acid (density of 10% or less)</td></tr> <tr><td>Sulfuric acid (density of 10% or less)</td></tr> <tr><td>Sodium chloride</td></tr> <tr><td>Hexane</td></tr> <tr><td>Triethylene glycol</td></tr> </table>	Acetic acid (density of 10% or less)	Hydrochloric acid (density of 10% or less)	Sulfuric acid (density of 10% or less)	Sodium chloride	Hexane	Triethylene glycol	<p>(Table 2) Examples of unapplicable chemicals and solvents</p> <table border="1" style="width: 100%; border-collapse: collapse;"> <tr><td>Acetone</td></tr> <tr><td>Benzene</td></tr> <tr><td>Chloroform</td></tr> <tr><td>Ethylene chloride</td></tr> <tr><td>Ethyl acetate</td></tr> <tr><td>Glycerin</td></tr> <tr><td>Tetrachloroethylene</td></tr> <tr><td>Trichloroethylene</td></tr> <tr><td>Xylene</td></tr> </table>	Acetone	Benzene	Chloroform	Ethylene chloride	Ethyl acetate	Glycerin	Tetrachloroethylene	Trichloroethylene	Xylene		
Acetic acid (density of 10% or less)																		
Hydrochloric acid (density of 10% or less)																		
Sulfuric acid (density of 10% or less)																		
Sodium chloride																		
Hexane																		
Triethylene glycol																		
Acetone																		
Benzene																		
Chloroform																		
Ethylene chloride																		
Ethyl acetate																		
Glycerin																		
Tetrachloroethylene																		
Trichloroethylene																		
Xylene																		

## ■ Transportation & installation



 Danger	
 Prohibited	<ul style="list-style-type: none"> <li>Do not install or operate the inverter if it is damaged or any component is missing. This can result in electric shock or fire. Please consult your local sales agency for repairs. Call your local sales agency for repairs.</li> <li>Do not place any inflammable objects nearby. If a flame is emitted due to malfunction, it may result in a fire.</li> <li>Do not install in any location where the inverter could come into contact with water or other fluids. This can result in electric shock or fire.</li> </ul>
 Mandatory	<ul style="list-style-type: none"> <li>Must be used in the environmental conditions prescribed in the instruction manual. Use under any other conditions may result in malfunction.</li> <li>Mount the inverter on a metal plate. The rear panel gets very hot. Do not install in an inflammable object, this can result in fire.</li> <li>Do not operate with the front panel cover removed. This can result in electric shock. Failure to do so can lead to risk of electric shock and can result in death or serious injury.</li> <li>An emergency stop device must be installed that fits with system specifications (e.g. shut off input power then engage mechanical brake). Operation cannot be stopped immediately by the inverter alone, thus risking an accident or injury.</li> <li>All options used must be those specified by Toshiba. The use of any other option may result in an accident.</li> </ul>



 Warning	
 Prohibited	<ul style="list-style-type: none"> <li>When transporting or carrying, do not hold by the front panel covers. The covers may come off and the unit will drop out resulting in injury.</li> <li>Do not install in any area where the unit would be subject to large amounts of vibration. That could result in the unit falling, resulting in injury.</li> </ul>
 Mandatory	<ul style="list-style-type: none"> <li>The main unit must be installed on a base that can bear the unit's weight. If the unit is installed on a base that cannot withstand that weight, the unit may fall resulting in injury.</li> <li>If braking is necessary (to hold motor shaft), install a mechanical brake. The brake on the inverter will not function as a mechanical hold, and if used for that purpose, injury may result.</li> </ul>

## ■ Wiring



 Danger	
 Prohibited	<ul style="list-style-type: none"> <li>Do not connect input power to the output (motor side) terminals (U/T1,V/T2,W/T3). That will destroy the inverter and may result in fire.</li> <li>Do not connect resistors to the DC terminals (across PA-PC or PO-PC). That may cause a fire.</li> <li>Within ten minutes after turning off input power, do not touch wires of devices (MCCB) connected to the input side of the inverter. That could result in electric shock.</li> </ul>



I

 <b>Danger</b>	
 Mandatory	<ul style="list-style-type: none"> <li>• Electrical installation work must be done by a qualified expert. Connection of input power by someone who does not have that expert knowledge may result in fire or electric shock.</li> <li>• Connect output terminals (motor side) correctly. If the phase sequence is incorrect, the motor will operate in reverse and that may result in injury.</li> <li>• Wiring must be done after installation. If wiring is done prior to installation that may result in injury or electric shock</li> <li>• The following steps must be performed before wiring.               <ol style="list-style-type: none"> <li>(1) Turn off all input power.</li> <li>(2) Wait at least ten minutes and check to make sure that the charge lamp is no longer lit.</li> <li>(3) Use a tester that can measure DC voltage (800VDC or more), and check to make sure that the voltage to the DC main circuits (across PA-PC) is 45V or less.</li> </ol>               If these steps are not properly performed, the wiring will cause electric shock.             </li> <li>• Tighten the screws on the terminal board to specified torque. If the screws are not tightened to the specified torque, it may lead to fire.</li> <li>• Check to make sure that the input power voltage is +10%, -15% of the rated power voltage written on the rating label (<math>\pm 10\%</math> when the load is 100% in continuous operation). If the input power voltage is not +10%, -15% of the rated power voltage (<math>\pm 10\%</math> when the load is 100% in continuous operation) this may result in fire.</li> </ul>
 Be Grounded	<ul style="list-style-type: none"> <li>• Ground must be connected securely. If the ground is not securely connected, it could lead to electric shock or fire when a malfunction or current leak occurs.</li> </ul>

 <b>Warning</b>	
 Prohibited	<ul style="list-style-type: none"> <li>• Do not attach equipment (such as noise filters or surge absorbers) that have built-in capacitors to the output (motor side) terminals. That could result in a fire.</li> </ul>

## ■ Operations



 <b>Danger</b>	
 Prohibited	<ul style="list-style-type: none"> <li>• Do not touch inverter terminals when electrical power is going to the inverter even if the motor is stopped. Touching the inverter terminals while power is connected to it may result in electric shock.</li> <li>• Do not touch switches when the hands are wet and do not try to clean the inverter with a damp cloth. Such practices may result in electric shock.</li> <li>• Do not go near the motor in alarm-stop status when the retry function is selected. The motor may suddenly restart and that could result in injury. Take measures for safety, e.g. attaching a cover to the motor, against accidents when the motor unexpectedly restarts.</li> </ul>
 Mandatory	<ul style="list-style-type: none"> <li>• Turn input power on after attaching the front cover. When installed inside a cabinet and using with the front cover removed, always close the cabinet doors first and then turn power on. If the power is turned on with the front cover or the cabinet doors open, it may result in electric shock.</li> <li>• Make sure that operation signals are off before resetting the inverter after malfunction. If the inverter is reset before turning off the operating signal, the motor may restart suddenly causing injury.</li> </ul>

 <b>Warning</b>	
 Prohibited	<ul style="list-style-type: none"> <li>Observe all permissible operating ranges of motors and mechanical equipment. (Refer to the motor's instruction manual.) Not observing these ranges may result in injury.</li> </ul>



When sequence for restart after a momentary failure is selected (inverter)

 <b>Warning</b>	
 Mandatory	<ul style="list-style-type: none"> <li>Stand clear of motors and mechanical equipment. If the motor stops due to a momentary power failure, the equipment will start suddenly after power recovers. This could result in unexpected injury.</li> <li>Attach warnings about sudden restart after a momentary power failure on inverters, motors and equipment for prevention of accidents in advance.</li> </ul>

When retry function is selected (inverter)

 <b>Warning</b>	
 Mandatory	<ul style="list-style-type: none"> <li>Stand clear of motors and equipment. If the motor and equipment stop when the alarm is given, selection of the retry function will restart them suddenly after the specified time has elapsed. This could result in unexpected injury.</li> <li>Attach warnings about sudden restart in retry function on inverters, motors and equipment for prevention of accidents in advance.</li> </ul>

Maintenance and inspection

 <b>Danger</b>	
 Prohibited	<ul style="list-style-type: none"> <li>Do not replace parts. This could be a cause of electric shock, fire and bodily injury. To replace parts, call the local sales agency.</li> </ul>
 Mandatory	<ul style="list-style-type: none"> <li>The equipment must be inspected every day. If the equipment is not inspected and maintained, errors and malfunctions may not be discovered and that could result in accidents.</li> <li>Before inspection, perform the following steps.             <ol style="list-style-type: none"> <li>Turn off all input power to the inverter.</li> <li>Wait at least ten minutes and check to make sure that the charge lamp is no longer lit.</li> <li>Use a tester that can measure DC voltages (800VDC or more), and check to make sure that the voltage to the DC main circuits (across PA-PC) is 45V or less.</li> </ol> </li> <li>If inspection is performed without performing these steps first, it could lead to electric shock.</li> </ul>

## — Contents —

I	Safety precautions .....	1
1.	Read first.....	7
1.1	Check product purchase .....	7
1.2	Contents of the product.....	9
1.3	Installation.....	9
2.	Connection.....	10
2.1	Standard connections .....	10
2.2	Description of terminals.....	12
3.	Operations .....	19
3.1	Simplified operation of the VF-S11.....	19
3.2	How to operate the VF-S11.....	23
4.	Basic VF-S11 operations.....	27
4.1	Flow of status monitor mode .....	28
4.2	How to set parameters .....	29
5.	Monitoring the operation status.....	36
5.1	Status monitor mode .....	36
5.2	Display of trip information.....	40
6.	Measures to satisfy the standards .....	44
6.1	How to cope with the CE directive .....	44
6.2	Compliance with UL Standard and CSA Standard .....	48
7.	Table of parameters and data .....	50
7.1	User parameters .....	50
7.2	Basic parameters .....	50
7.3	Extended parameters.....	53
8.	Specifications.....	70
8.1	Models and their standard specifications .....	70
8.2	Outside dimensions and mass .....	73
9.	Before making a service call - Trip information and remedies.....	76
9.1	Trip causes/warnings and remedies.....	76

# 1. Read first

Thank you for your purchase of the Toshiba "TOSVERT VF-S11" industrial inverter.

This manual is a simplified version.

If you need a detailed explanation, refer to the full version of English manual (E6581158).

This is the Ver. 108 / Ver. 109 CPU version inverter.  
Please be informed that CPU version will be frequently upgraded.

## 1.1 Check product purchase

Before using the product you have purchased, check to make sure that it is exactly what you ordered.

**Rating label**

Series name  
Power supply  
Motor capacity

VF-S11  
1PH-200/240V-0.75kW/1HP

**Inverter main unit**



Warning label

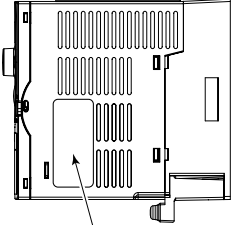

**Name plate**

**Carton box**

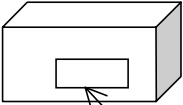

Type indication label

**Name plate**

Inverter Type  
Inverter rated output capacity  
Power supply  
Related input current  
Related output current

**Warning label**

危険

- 中が、爆発、火災の恐れがあります。
- 取り扱い説明書の注意事項を読むこと。
- 通電中及び電流遮断後10分以内は、扉を開かずに開かないこと。

**⚠ DANGER**

- Read the instruction manual.
- Do not open the cover while power is applied or for 10 minutes after power has been removed.

**Instruction manual**

This manual

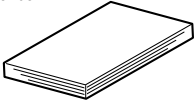

**EMC plate**

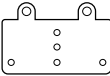

**TOSHIBA TRANSISTOR INVERTER**

**VFS11-4007/PL-WN(1):**

0.75kW-1.8kVA-1HP

	INPUT	OUTPUT
UVV	3PH 380/500	3PH 380/500
F(Hz)	50/60	0.9500
IA	3.6/2.7	2.3



S.Ct1 5000A FUSE CCU 6Amax  
Cu AWG14: 75°C  
10.7lb-in/1.2 Nm





Serial No: 1234 57000000 0000  
Lot No: 101MY60

Made in Japan

Motor Protective Device Class 10

 N1971  
Group 1 Class A  20430

 LISTED 170M  
IND. CONT. EQ.  CE

TOSHIBA CORPORATION TSU



**CD-ROM** E6581167

Contains the instruction manual in digital form.  
Some models do not come with this CD-ROM.

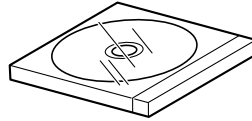
 **Warning**

Prohibited

Do not play this CD-ROM on any audio CD player to avoid hearing loss due to very loud noises or damage to the CD player.

**[System requirements]**

OS: Microsoft Windows 98/NT/2000/XP  
Browser: Internet Explorer 4.0 or later  
CPU: Pentium 100MHz or more  
Memory: 32MB or more  
DOS/V-based personal computer

**[Starting the browsing program]**

When you insert this CD-ROM in the CD-ROM drive, the program "index.htm" in the root directory starts automatically. When you want to close the browsing program or if it does not start automatically, open Windows Explorer and click "index.htm" under "CD-ROM drive" to display the top window.

**[Software needed for browsing]**

Adobe Acrobat Reader 4.0J or later

**[Trade names and trademarks]**

- Microsoft Windows and Windows logos are trademarks or registered trademarks of Microsoft Corporation in the U.S.A.
- Adobe Acrobat is a trademark of Adobe Systems Incorporated.
- Other company names and product names referred to in this manual are trade names and registered trademarks, respectively.

**[Copyright]**

This manual and other documentation included with the inverter are publications of Toshiba Schneider Inverter Corporation, and all rights to these publications, including copyrights, are reserved by the said corporation.

**[Duplication]**

No part of the contents of the CD-ROM shall be reproduced without written permission from Toshiba Schneider Inverter Corporation.

**[Exclusions]**

Toshiba Schneider Inverter Corporation shall have no liability for any damage of any kind caused by the use of this CD-ROM.

## 1.2 Contents of the product

Explanation of the name plate label. Always shut power off first then check the ratings label of inverter held in a cabinet.

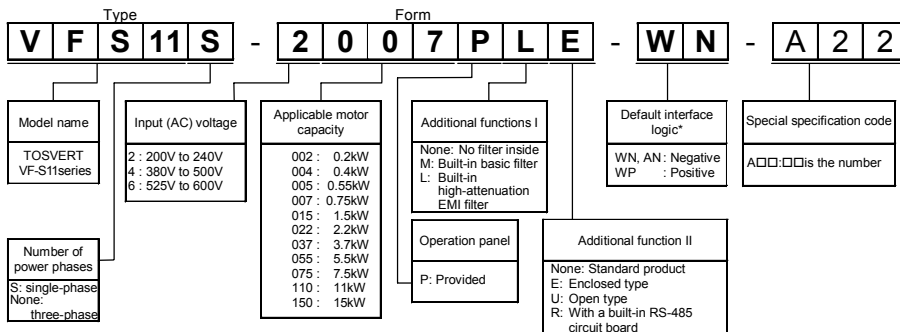

\* This code represents the factory default logic setting. You can switch from one input/output logic to the other using slide switch SW1.

## 1.3 Installation

Install the inverter in a well-ventilated indoor place and mount it on a flat metal plate in portrait orientation. If you are installing more than one inverter, the separation between inverters should be at least 5 centimeters, and they should be arranged in horizontal rows. If the inverters are horizontally arranged with no space between them (side-by-side installation), peel off the ventilation seals on top of the inverter. It is necessary to decrease the current if the inverter is operated at over 50°C.

### ●Standard installation

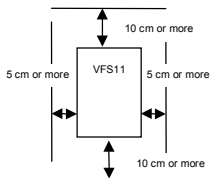

### ●Side-by-side installation

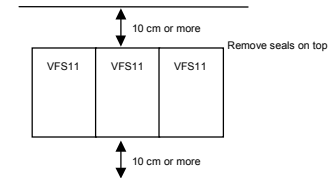

The space shown in the diagram is the minimum allowable space. Because air cooled equipment has cooling fans built in on the top or bottom surfaces, make the space on top and bottom as large as possible to allow for air passage.

Note: Do not install in any location where there is high humidity or high temperatures and where there are large amounts of dust, metallic fragments and oil mist.





## 2.2 Description of terminals

### 2.2.1 Power circuit terminals

In case of the lug connector, cover the lug connector with insulated tube, or use the insulated lug connector.

Screw size	tightening torque	
M3.5 screw	0.9Nm	7.1lb • in
M4 screw	1.3Nm	10.7lb • in
M5 screw	2.5Nm	22.3lb • in
M6 screw	4.5Nm	40.1lb • in

#### ■ Power circuit

Terminal symbol	Terminal function
	Grounding terminal for connecting inverter. There are 3 terminals in total. 2 terminals in the terminal board, 1 terminal in the cooling fin.
R/L1,S/L2,T/L3	240V class: single-phase 200 to 240V-50/60Hz three-phase 200 to 240V-50/60Hz 500V class: three-phase 380 to 500V-50/60Hz 600V class: three-phase 525 to 600V-50/60Hz * Single-phase input: R/L1 and S/L2 terminals
U/T1,V/T2,W/T3	Connect to a (three-phase induction) motor.
PA+, PB	Connect to braking resistors. Change parameters <i>F304, F305, F308, F309</i> if necessary.
PC/-	This is a negative potential terminal in the internal DC main circuit. DC common power can be input across the PA terminals (positive potential).
PO, PA/+	Terminals for connecting a DC reactor (DCL: optional external device). Shorted by a short bar when shipped from the factory. Before installing DCL, remove the short bar.

### 2.2.2 Selection of wiring materials

Voltage class	Capacity of applicable motor (kW)	Inverter model	Wire size (See Note 4)			
			Power circuit (mm <sup>2</sup> ) (Note 1.)	DC reactor (optional) (mm <sup>2</sup> )	Braking resistor/ Braking unit (optional) (mm <sup>2</sup> )	Earth cable (mm <sup>2</sup> )
Single-phase 240V class	0.2	VFS11S-2002PL	2.0 (2.0)	2.0	2.0	3.5
	0.4	VFS11S-2004PL	2.0 (2.0)	2.0	2.0	3.5
	0.75	VFS11S-2007PL	2.0 (2.0)	2.0	2.0	3.5
	1.5	VFS11S-2015PL	2.0 (2.0)	2.0	2.0	3.5
	2.2	VFS11S-2022PL	2.0 (2.0)	3.5	2.0	3.5
Three-phase 240V class	0.4	VFS11-2004PM	2.0 (2.0)	1.25	2.0	3.5
	0.55	VFS11-2005PM	2.0 (2.0)	2.0	2.0	3.5
	0.75	VFS11-2007PM	2.0 (2.0)	2.0	2.0	3.5
	1.5	VFS11-2015PM	2.0 (2.0)	2.0	2.0	3.5
	2.2	VFS11-2022PM	2.0 (2.0)	2.0	2.0	3.5
	4.0	VFS11-2037PM	2.0 (2.0)	3.5	2.0	3.5
	5.5	VFS11-2055PM	5.5 (2.0)	8.0	2.0	5.5
	7.5	VFS11-2075PM	8.0 (5.5)	14	3.5	5.5
	11	VFS11-2110PM	14 (8.0)	14	5.5	8.0
	15	VFS11-2150PM	22 (14)	22	14	8.0

Voltage class	Capacity of applicable motor (kW)	Inverter model	Wire size (See Note 4)			
			Power circuit (mm <sup>2</sup> ) (Note 1.)	DC reactor (optional) (mm <sup>2</sup> )	Braking resistor/ Braking unit (optional) (mm <sup>2</sup> )	Earth cable (mm <sup>2</sup> )
Three-phase 500V class	0.4	VFS11-4004PL	2.0 (2.0)	2.0	2.0	3.5
	0.75	VFS11-4007PL	2.0 (2.0)	2.0	2.0	3.5
	1.5	VFS11-4015PL	2.0 (2.0)	2.0	2.0	3.5
	2.2	VFS11-4022PL	2.0 (2.0)	2.0	2.0	3.5
	4.0	VFS11-4037PL	2.0 (2.0)	2.0	2.0	3.5
	5.5	VFS11-4055PL	2.0 (2.0)	3.5	2.0	3.5
	7.5	VFS11-4075PL	3.5 (2.0)	5.5	2.0	3.5
	11	VFS11-4110PL	5.5 (2.0)	8.0	2.0	5.5
	15	VFS11-4150PL	8.0 (6.5)	14	3.5	5.5
Three-phase 600V class	0.75	VFS11-6007P	2.0	2.0	2.0	3.5
	1.5	VFS11-6015P	2.0	2.0	2.0	3.5
	2.2	VFS11-6022P	2.0	2.0	2.0	3.5
	4.0	VFS11-6037P	2.0	2.0	2.0	3.5
	5.5	VFS11-6055P	2.0	2.0	2.0	3.5
	7.5	VFS11-6075P	2.0	2.0	2.0	3.5
	11	VFS11-6110P	3.5	3.5	2.0	3.5
	15	VFS11-6150P	5.5	5.5	2.0	5.5

Note 1: Sizes of the wires connected to the input terminals R/L1, S/L2 and T/L3 and the output terminals U/T1, V/T2 and W/T3 when the length of each wire does not exceed 30m.

The numeric values in parentheses refer to the sizes of wires to be used when a DC reactor is connected.

Note 2: For the control circuit, use shielded wires 0.75 mm<sup>2</sup> or more in diameter.

Note 3: For grounding, use a cable with a size equal to or larger than the above.

Note 4: The wire sizes specified in the above table apply to HIV wires (copper wires shielded with an insulator with a maximum allowable temperature of 75°C) used at an ambient temperature of 50°C or less.

Note 5: If there is a need to bring the inverter into UL compliance, use wires specified in Chapter 6.

## 2.2.3 Control circuit terminals

The control circuit terminal board is common to all equipment.

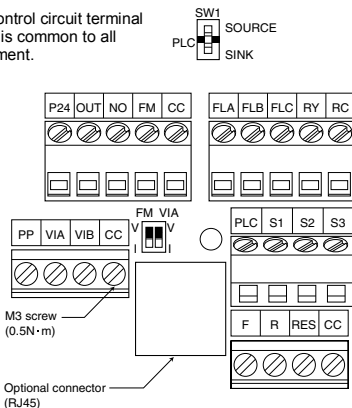

Factory default settings of slide switches

SW1: SINK (Negative) side (WN, AN type)

SOURCE (Positive) side (WP type)

FM: V side

VIA: V side

Wire size

Solid wire: 0.3 ~ 1.5 (mm<sup>2</sup>)

Stranded wire: 0.3 ~ 1.5 (mm<sup>2</sup>)  
(AWG 22 ~ 16)

Sheath strip length: 6 (mm)

Screwdriver: Small-sized flat-blade screwdriver

(Blade thickness: 0.4 mm or less,  
blade width: 2.2 mm or less)

■ Control circuit terminals

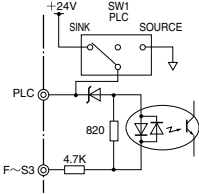
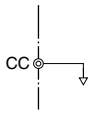
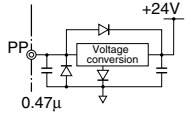
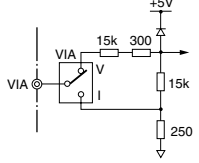
Terminal symbol	Input/output	Function	Electrical specifications	Inverter internal circuits
F	Input	Multifunction programmable contact input	No voltage contact input 24Vdc-5mA or less  *Sink/Source/PLC selectable using SW1	 <p>Factory default setting WN, AN type : SINK side WP type : SOURCE side</p>
R	Input			
RES	Input			
S1	Input			
S2	Input			
S3	Input			
PLC	Input (common)	External 24Vdc power input When the source logic is used, a common terminal is connected.	24VDC (Insulation resistance: DC50V)	
CC	Common to Input/output	Control circuit's equipotential terminal (3 terminals)		
PP	Output	Analog power supply output	10Vdc (permissible load current: 10mA)	
VIA	Input	Multifunction programmable analog input. Factory default setting: 0~10Vdc and 0~60Hz (0~50Hz) frequency input. The function can be changed to 4~20mAdc (0~20mA) current input by flipping the dip switch to the I position.  By changing parameter setting, this terminal can also be used as a multifunction programmable contact input terminal. When using the sink logic, be sure to insert a resistor between P24-VIA (4.7 kΩ—1/2 W). Also move the VIA dip switch to the V position.	10Vdc (internal impedance: 30kΩ)  4-20mA (internal impedance: 250Ω)	

Terminal symbol	Input/output	Function	Electrical specifications	Inverter internal circuits
VIB	Input	<p>Multifunction programmable analog input. Standard default setting: 0~10Vdc input and 0~60Hz (0~50Hz) frequency</p> <p>By changing parameter setting, this terminal can also be used as a multifunction programmable contact input terminal. When using the sink logic, be sure to insert a resistor between P24 and VIB. (4.7 kΩ—1/2 W)</p>	<p>10Vdc (internal impedance: 30kΩ)</p>	
FM	Output	<p>Multifunction programmable analog output. Standard default setting: output frequency. The function can be changed to 0-20mAdc (4-20mA) current output by flipping the FM slide switch to the I position.</p>	<p>1mAdc full-scale ammeter or 7.5Vdc (10Vdc)1mA full-scale voltmeter</p> <p>0-20mA (4-20mA) DC ammeter</p> <p>Permissible load resistance: 750Ω or less</p>	
P24	Output	24Vdc power output	24Vdc-100mA	
OUT NO	Output	<p>Multifunction programmable open collector output. Standard default settings detect and output speed reach signal output frequencies.</p> <p>Multifunction output terminals to which two different functions can be assigned. The NO terminal is an isoelectric output terminal. It is insulated from the CC terminal.</p> <p>By changing parameter settings, these terminals can also be used as multifunction programmable pulse train output terminals.</p>	<p>Open collector output 24Vdc-50mA</p> <p>To output pulse trains, a current of 10mA or more needs to be passed.</p> <p>Pulse frequency range: 38~1600Hz</p>	
FLA FLB FLC	Output	<p>Multifunction programmable relay contact output. Detects the operation of the inverter's protection function. Contact across FLA-FLC is closed and FLB-FLC is opened during protection function operation.</p>	<p>250Vac-1A (cosφ=1) : at resistance load 30Vdc-0.5A 250Vac-0.5A (cosφ=0.4)</p>	

\* PTC (Positive Temperature Coefficient): Resettable thermal fuse resistor for over current protection.



Terminal symbol	Input/output	Function	Electrical specifications	Inverter internal circuits
RY RC	Output	Multifunction programmable relay contact output. Standard default settings detect and output low-speed signal output frequencies. Multifunction output terminals to which two different functions can be assigned.	250Vac-1A ( $\cos\phi=1$ ) : at resistance load 30Vdc-0.5A 250Vac-0.5A ( $\cos\phi=0.4$ )	

**■ SINK (Negative) logic/SOURCE (Positive) logic (When the inverter's internal power supply is used)**

Current flowing out turns control input terminals on. These are called sink logic terminals. (Type: -AN/-WN). The general used method in Europe is source logic in which current flowing into the input terminal turns it on (Typ: -WP).

Sink logic is sometimes referred to as negative logic, and source logic is referred to as positive logic. Each logic is supplied with electricity from either the inverter's internal power supply or an external power supply, and its connections vary depending on the power supply used.

<Examples of connections when the inverter's internal power supply is used >

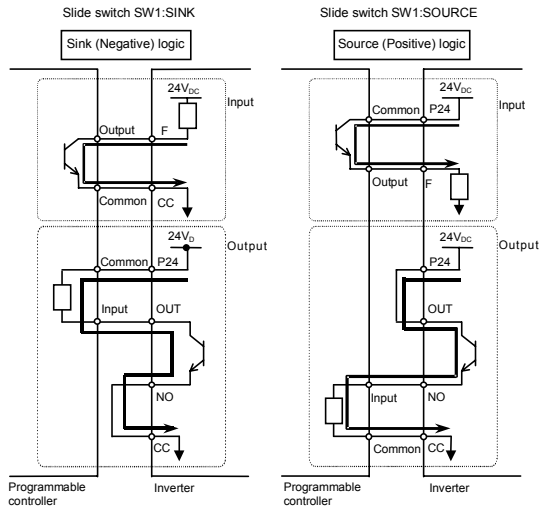

## ■ SINK (Negative) logic/SOURCE (Positive) logic (When an external power supply is used)

The PLC terminal is used to connect to an external power supply or to insulate a terminal from other input or output terminals. As for input terminals, turn the SW1 slide switch to the PLC position.

< Examples of connections when an external power supply is used >

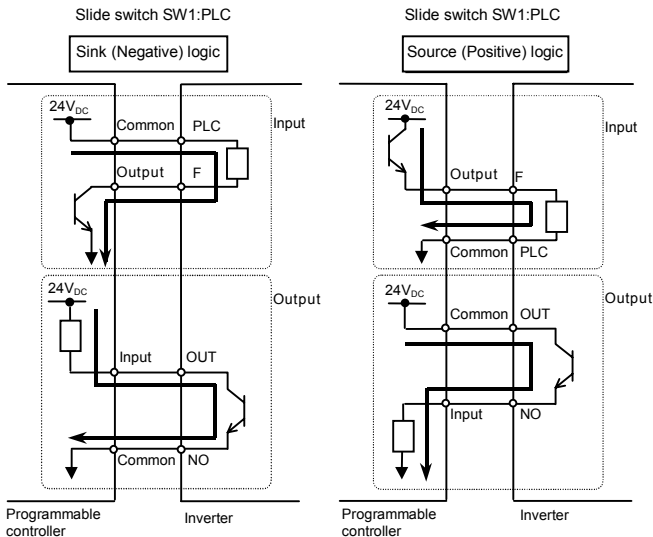

## ■ Selecting the functions of the VIA and VIB terminals between analog input and contact input

The functions of the VIA and VIB terminals can be selected between analog input and contact input by changing parameter settings (*F 109*). (Factory default setting: Analog input)

When using these terminals as contact input terminals in a sink logic circuit, be sure to insert a resistor between the P24 and VIA terminals or between the P24 and VIB terminals. (Recommended resistance: 4.7KΩ-1/2W)

When using the VIA terminal as a contact input terminal, be sure to turn the VIA switch to the V position. If no resistor is inserted or the VIA slide switch is not turned to the V position, contact input will be left always ON, which is very dangerous.

Switch between analog input and contact input before connecting the terminals to the control circuit terminals. Otherwise the inverter or devices connected to it may be damaged.

## ■ Logic switching/Voltage-current output switching (slide switch)

### (1) Logic switching

Use SW1 to switch between logics.

Switch between logics before wiring to the inverter and without supplying power. If switching between sink, source and PLC is done when power is turned on after switching or when the inverter is supplied with power, the inverter might become damaged. Confirm it before supplying power.

### (2) Voltage-current output switching

Use the FM switch to switch between voltage output and current output.

Switch the FM terminal's voltage-current output before wiring to inverter or without supplying power.

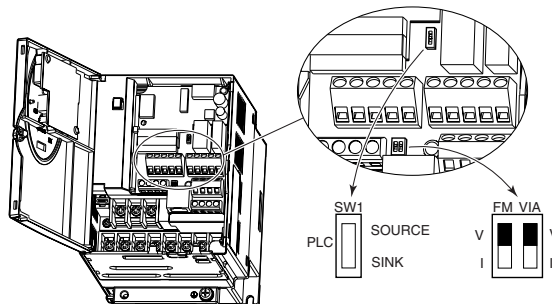

Factory default settings of slide switches

SW1 : SINK (Negative) side (WN, AN type)

SOURCE (Positive) side (WP type)

FM : V side

VIA : V side

### 3. Operations

#### 3.1 Simplified Operation of the VF-S11

The procedures for setting operation frequency and the methods of operation can be selected from the following.

- Start / Stop : (1) Start and stop using the operation panel keys  
(2) Run and stop from the operation panel

- Setting the frequency : (1) Setting using the potentiometer on the inverter main unit  
(2) Setting using the operation panel  
(3) Setting using external signals to the terminal board (0-10Vdc, 4-20mA<sub>dc</sub>)

Use the basic parameters  $Cn0d$  (Operation command mode selection),  $Fn0d$  (Speed setting mode selection).

Title	Function	Adjustment range	Default setting
$Cn0d$	Command mode selection	0: Terminal board 1: Panel	1
$Fn0d$	Frequency setting mode	0: Internal potentiometer setting 1: VIA 2: VIB 3: Operation panel 4: Serial communication 5: External contact up/down 6: VIA+VIB (Override)	0

\* See the manual E6581158 for  $Fn0d=4, 5$  and  $6$ .

### 3.1.1 How to start and stop

[Example of a  $\text{C} \text{R} \text{O} \text{d}$  setting procedure]

Key operated	LED display	Operation
	0.0	Displays the operation frequency (operation stopped). (When standard monitor display selection $F \ 7 \ 0=0$ [Operation frequency])
(MODE)	RUH	Displays the first basic parameter [History (RUH)].
( $\blacktriangle$ ) ( $\blacktriangledown$ )	CROd	Press either the $\blacktriangle$ or $\blacktriangledown$ key to select "CROd".
(ENT)	!	Press ENTER key to display the parameter setting. (Default setting: !).
( $\blacktriangle$ ) ( $\blacktriangledown$ )	0	Change the parameter to 0 (terminal board) by pressing the $\blacktriangle$ key.
(ENT)	0 $\leftrightarrow$ CROd	Press the ENTER key to save the changed parameter. CROd and the parameter set value are displayed alternately.

#### (1) Start and stop using the operation panel keys (CROd=!) :

Use the (RUN) and (STOP) keys on the operation panel to start and stop the motor.

(RUN) : Motor starts.      (STOP) : Motor stops.

★ To switch between forward run and reverse run from the control panel, the parameter  $F \ r$  (forward/reverse run selection) needs to be set to 2 or 3.

#### (2) RUN/STOP by means of an external signal to the terminal board (CROd=0): Sink (Negative) logic

Use external signals to the inverter terminal board to start and stop the motor.

Short **F** and **CC** terminals: run forward

Open **F** and **CC** terminals: slow down and stop

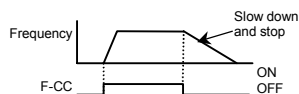

#### (3) Coast stop

The standard default setting is for slowdown stop. To make a coast stop, assign a "1(ST)" terminal function to an idle terminal using the programmable terminal function.

Change to  $F \ 1 \ 0=0$ .

For coast stop, open the ST-CC when stopping the motor in the state described at left. The monitor on the inverter at this time will display 0FF.

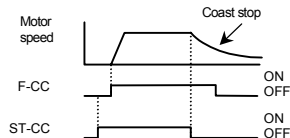

### 3.1.2 How to set the frequency

[Example of a  $F\dot{N}\dot{Q}d$  setting procedure]

Key operated	LED display	Operation
	0.0	Displays the operation frequency (operation stopped). (When standard monitor display selection $F\dot{7}1\dot{Q}=0$ [Operation frequency])
(MODE)	RUH	Displays the first basic parameter [History (RUH)].
(▲) (▼)	$F\dot{N}\dot{Q}d$	Press either the $\Delta$ key or $\nabla$ key to select " $F\dot{N}\dot{Q}d$ ".
(ENT)	0	Press ENTER key to display the parameter setting. (Default setting: 0).
(▲) (▼)	3	Change the parameter to 3 (Operation panel) by pressing the $\Delta$ key.
(ENT)	$3\leftrightarrow F\dot{N}\dot{Q}d$	Press the ENTER key to save the changed parameter. $F\dot{N}\dot{Q}d$ and the parameter set value are displayed alternately.

\* Pressing the MODE key twice returns the display to standard monitor mode (displaying operation frequency).

#### (1) Setting the frequency using the potentiometer on the inverter main unit ( $F\dot{N}\dot{Q}d=0$ )

Set the frequency with the notches on the potentiometer.



Move clockwise for the higher frequencies.

The potentiometer has hysteresis. So the set value may slightly change when the inverter is turned off, and then turned back on.

#### (2) Setting the frequency using the operation panel ( $F\dot{N}\dot{Q}d=3$ )

Set the frequency with the operation panel..



: Moves the frequency up



: Moves the frequency down

#### ■ Example of operating a run from the panel

Key operated	LED display	Operation
	0.0	Displays the operation frequency. (When standard monitor display selection $F\dot{7}1\dot{Q}=0$ [Operation frequency])
(▲) (▼)	50.0	Set the operation frequency.
(ENT)	$50.0\leftrightarrow F\dot{C}$	Press the ENT key to save the operation frequency. $F\dot{C}$ and the frequency are displayed alternately.
(▲) (▼)	60.0	Pressing the $\Delta$ key or the $\nabla$ key will change the operation frequency even during operation.

(3) Setting the frequency using the operation panel ( $FREQ = 1$  or  $2$ )

### ■ Frequency setting

#### 1) Setting the frequency using external potentiometer

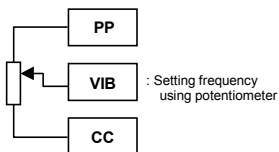

#### ★ Potentiometer

Setting frequency using the potentiometer (1-10k $\Omega$ , 1/4W)

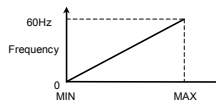

\* The input terminal VIA can be used in the same way.  
 $FREQ = 1$ : VIA effective,  $FREQ = 2$ : VIB effective

#### 2) Setting the frequency using input voltage (0~10V)

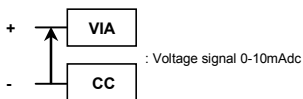

#### ★ Voltage signal

Setting frequency using voltage signals (0-10V).

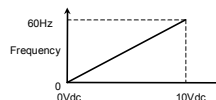

\* The input terminal VIB can be used in the same way.  
 $FREQ = 1$ : VIA effective,  $FREQ = 2$ : VIB effective

Note: Be sure to turn the VIA slide switch to the V (voltage) position.

#### 3) Setting the frequency using current input (4~20mA)

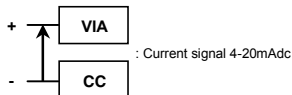

#### ★ Current Signal

Current signal Setting frequency using current signals (4~20mA).

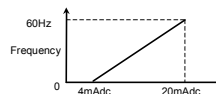

\* Setting of parameters also allow 0-20mAdc.

Note: Be sure to turn the VIA slide switch to the I (current) position.

## 3.2 How to operate the VF-S11

Overview of how to operate the inverter with simple examples.

### Ex.1

Setting the operation frequency using built-in potentiometer and running and stopping using the operation panel.

#### (1) Wiring

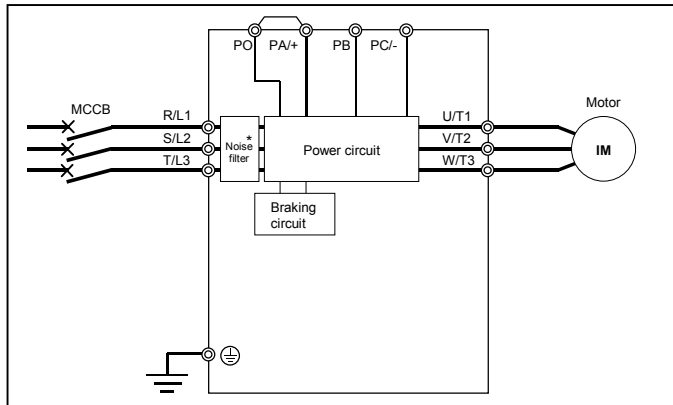

#### Parameter setting (default setting)

Title	Function	Programmed value
$\overline{C00d}$	Command mode selection	1
$\overline{F00d}$	Frequency setting mode selection 1	0

#### (3) Operation

Run/stop: Press the **(RUN)** and **(STOP)** keys on the panel.

Frequency setting: Set adjusting position of notches on the potentiometer.

\* 600V models have no noise filter inside.



## Ex.2

Setting the operation frequency using the operation panel and running and stopping using the operation panel.

## (1) Wiring

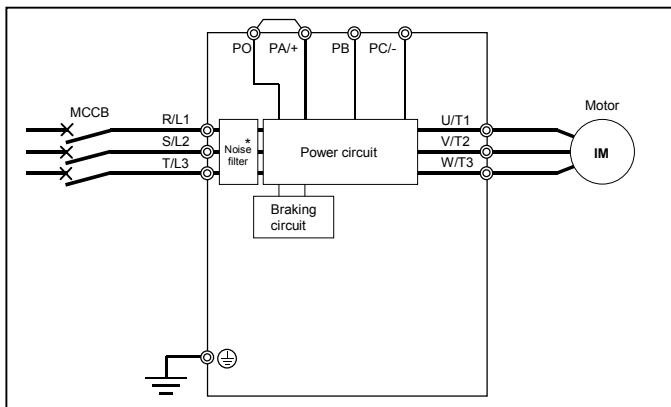

## (2) Parameter setting

Title	Function	Programmed value
$\overline{Fn0}$	Command mode selection	1
$\overline{Fn3}$	Frequency setting mode selection 1	3

## (3) Operation

Run/stop: Press the  $\text{\textcircled{R}}$  and  $\text{\textcircled{S}}$  keys on the panel.

Frequency setting: Set with the  $\text{\textcircled{\blacktriangle}}$   $\text{\textcircled{\blacktriangledown}}$  keys on the operation panel.

To store the set frequencies in memory, press the  $\text{\textcircled{ENT}}$  key.

$\overline{F}$  and the set frequency will flash on and off alternately.

\* 600V models have no noise filter inside.

**Ex.3**

Setting the operation frequency using built-in potentiometer and running and stopping using external signals.

(1) Wiring

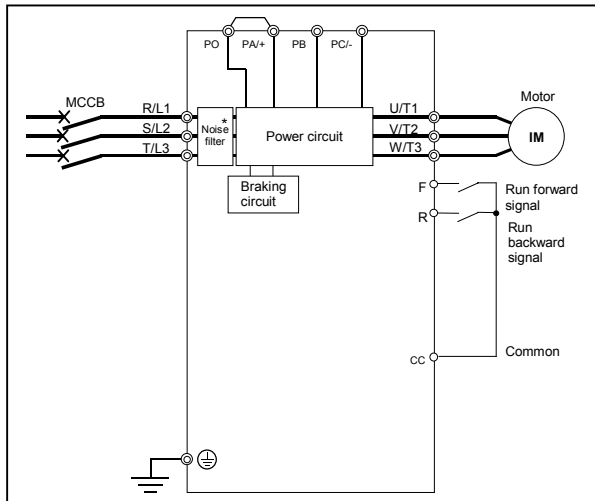

(2) Parameter setting

Title	Function	Programmed value
<i>C n d</i>	Command mode selection	0
<i>F n d</i>	Frequency setting mode selection	0

(3) Operation

Run/stop: ON/OFF input to F-CC, R-CC. (Set SW1 to Sink logic)

Frequency setting: Set adjusting position of notches on the potentiometer.

\* 600V models have no noise filter inside.

## Ex.4

## Operation frequency setting, running and stopping using external signals.

## (1) Wiring

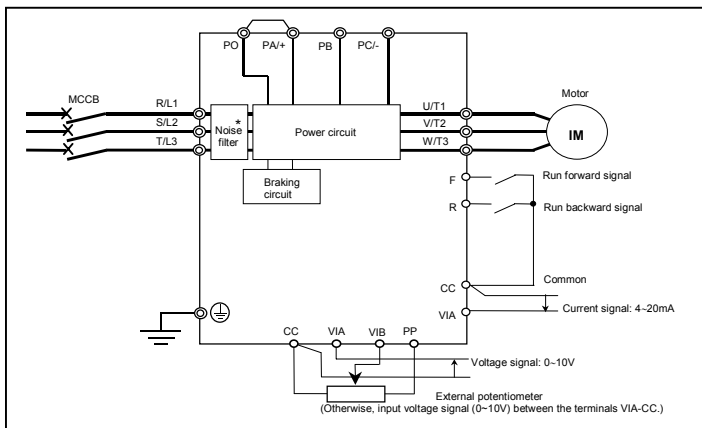

## (2) Parameter setting

Title	Function	Programmed value
<i>Fnn</i>	Command mode selection	0
<i>FQd</i>	Frequency setting mode selection	1or2

## (3) Operation

Run/stop: ON/OFF input to F-CC, R-CC. (Set SW1 to Sink logic)

Frequency setting: VIA and VIB: 0-10Vdc (External potentiometer)

VIA: Input 4-20mAadc.

Note) Use the VIA slide switch to switch between voltage and current to the VIA terminal.

Voltage input: V side

Current input: I side

\* 600V models have no noise filter inside.

## 4. Basic VF-S11 operations

The VF-S11 has the following four monitor modes.

Standard monitor mode

: The standard inverter mode. This mode is enabled when inverter power goes on.

This mode is for monitoring the output frequency and setting the frequency designated value. In it is also displayed information about status alarms during running and trips.

- Setting frequency designated values ⇒ see 3.1.2
- Status alarm

If there is an error in the inverter, the alarm signal and the frequency will flash alternately in the LED display.

$\zeta$ : When a current flows at or higher than the overcurrent stall level.

$P$ : When a voltage is generated at or higher than the over voltage stall level.

$L$ : When a load reaches 50% or higher of the overload trip value.

$H$ : When the temperature reaches the overheating protection alarm level.

Setting monitor mode

: The mode for setting inverter parameters.

[How to set parameters ⇒ see 4.2](#)

Status monitor mode

: The mode for monitoring all inverter status.

Allows monitoring of set frequencies, output current/voltage and terminal information.

[For more on how to use the monitor ⇒ see 5.1](#)

Pressing the key  will move the inverter through each of the modes.

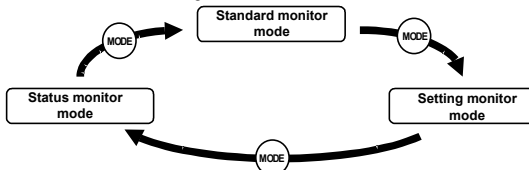

Panel jog mode

: This mode allows you to jog the motor by controlling the operation from the operation panel.  
This mode is hidden by default.

To use the panel jog mode, set the parameter  $F 2 5 2$  to  $1$ .

# 4.1 Flow of status monitor mode

Flow of monitor as following

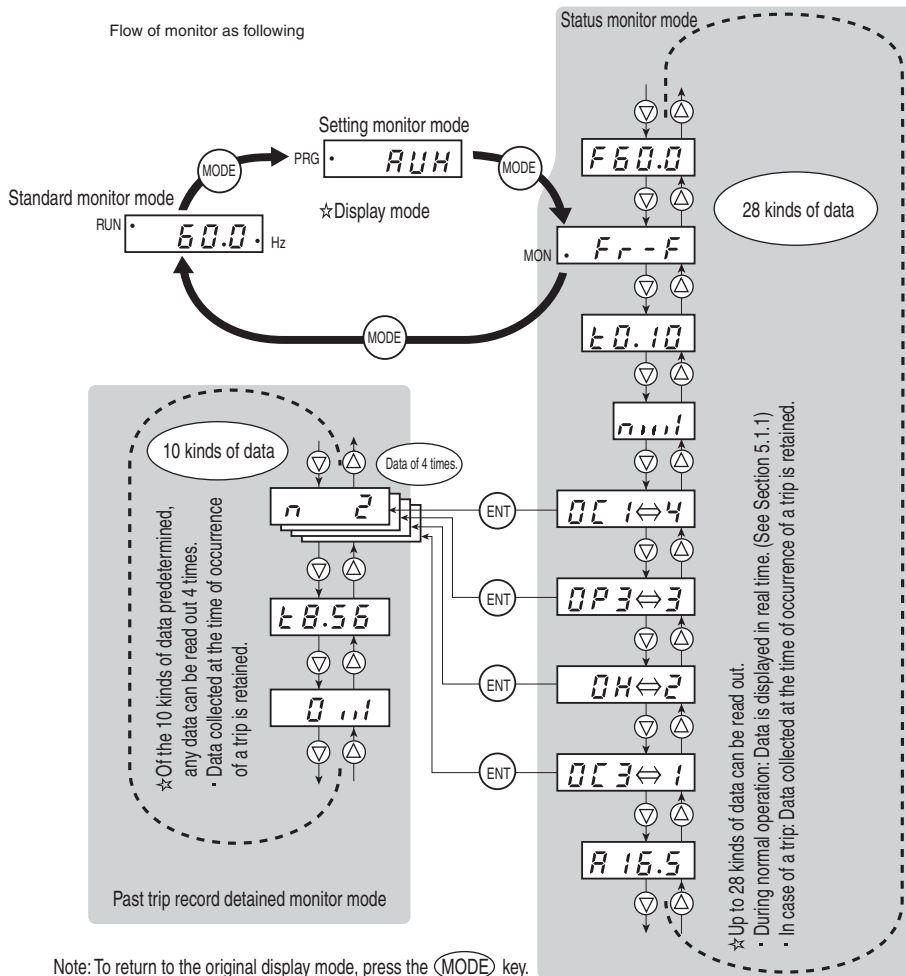

Note: To return to the original display mode, press the (MODE) key.

☆ Up to 28 kinds of data can be read out.  
 ☆ During normal operation: Data is displayed in real time. (See Section 5.1.1)  
 ☆ In case of a trip: Data collected at the time of occurrence of a trip is retained.

## 4.2 How to set parameters

The standard default parameters are programmed before the unit is shipped from the factory. Parameters can be divided into 4 major categories. Select the parameter to be changed or to be searched and retrieved.

Basic parameters

: The basic parameters that must be programmed before the first use. (See 4.2.1)

Extended parameters

: The parameters for detailed and special setting. (See 4.2.2)

User parameters

(automatic edit function)

: Indicates parameters that are different from the standard default setting parameters. Use them to check after setting and to change setting. (Parameter title:  $\overline{U}r.U$ ). (See 4.2.3)

History parameter

: This parameter has the function of displaying, in reverse chronological order, the five parameters that were changed last. This function comes in very handy when you adjust the inverter repeatedly using the same parameter. (Parameter name:  $\overline{RH}$ ). (See 4.2.4)

\* Adjustment range of parameters

$\overline{H}!$ : An attempt has been made to assign a value that is higher than the programmable range. Or, as a result of changing other parameters, the programmed value of the parameter that is now selected exceeds the upper limit.

$\overline{L}!$ : An attempt has been made to assign a value that is lower than the programmable range. Or, as a result of changing other parameters, the programmed value of the parameter that is now selected exceeds the lower limit.

If the above alarm is flashing on and off, no setting can be done of values that are equal to or greater than  $\overline{H}!$  or equal to or lower than  $\overline{L}!$ .

## 4.2.1 How to set the basic parameters





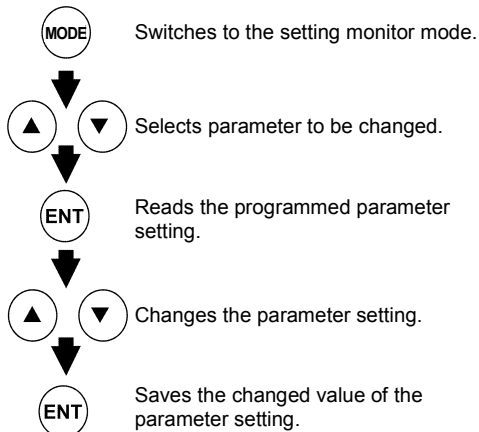



All of the basic parameters can be set by the same step procedures.

[Steps in key entry for basic parameters]



- \* Parameters were factory-set by default before shipment.
- \* Select the parameter to be changed from "Table of parameters".
- \* If there is something that you do not understand during the operation, press the MODE key to return to the  $0.0$  indication.
- \* See 7.2 for basic parameters.

Steps in setting are as follows (example of changing the maximum frequency from 80Hz to 60Hz).

Key operated	LED display	Operation
	$0.0$	Displays the operation frequency (operation stopped). (When standard monitor display selection $F \uparrow i \downarrow = 0$ [Operation frequency])
	$RUH$	The first basic parameter "RUH" (history function) is displayed.
	$FH$	Press either the $\Delta$ or $\nabla$ key to select "FH".
	$80.0$	Pressing the ENTER key reads the maximum frequency.
	$60.0$	Press the $\Delta$ key to change the maximum frequency to 60Hz.
	$80.0 \leftrightarrow FH$	Press the ENT key to save the maximum frequency. $FH$ and the frequency are displayed alternately.
After this, 	$\rightarrow$ Displays the same programmed parameter.	 $\rightarrow$ Switches to the display in the status monitor mode.
		 $\rightarrow$ Displays names of other parameters.

## 4.2.2 How to set extended parameters

The VF-S11 has extended parameters to allow you to make full use of its functions.  
All extended parameters are expressed with *F* and three digits.

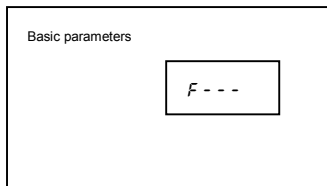

Press the MODE key once and use the ▲▼ key to select *F - - -* from the basic parameters.

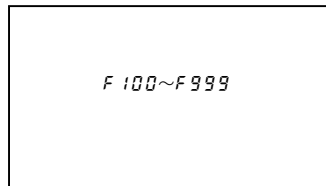

Press the ▲ key or the ▼ key to change the set value. Pressing the ENTER key allows the reading of parameter setting.

[Steps in key entry for extended parameters]

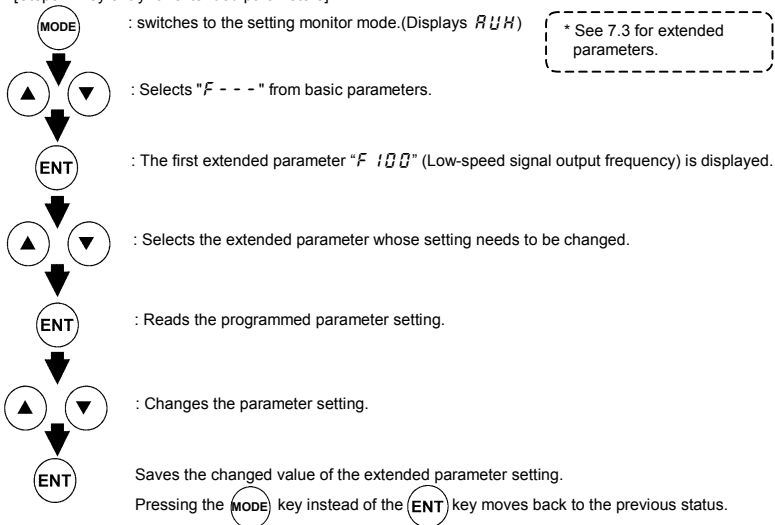









## ■ Example of parameter setting

Steps in setting are as follows

(Example of changing the dynamic braking selection  $F 304$  from 0 to 1.)

Key operated	LED display	Operation
	0.0	Displays the operation frequency (operation stopped). (When standard monitor display selection $F 710=0$ [Operation frequency])
	$RUH$	The first basic parameter " $RUH$ " (history function) is displayed.
	$F---$	Press either the $\Delta$ or the $\nabla$ to change to the parameter group $F---$ .
	$F100$	Press the ENTER key to display the first extended parameter $F100$ .
	$F304$	Press the $\Delta$ key to change to the dynamic braking selection $F304$ .
	0	Pressing the ENTER key allows the reading of parameter setting.
	1	Press the $\Delta$ key to change the dynamic braking selection from 0 to 1.
	$1 \Rightarrow F304$	Pressing the ENTER key alternately flashes on and off the parameter and changed value and allows the save of those values.

If there is anything you do not understand during this operation, press the MODE key several times to start over from the step of  $RUH$  display.

For details on the function of each parameter, refer to the full version of English manual (E6581158).

## 4.2.3 Search and resetting of changed parameters ( $\underline{U}r.U$ )



Automatically searches for only those parameters that are programmed with values different from the standard default setting and displays them in the user parameter group  $\underline{U}r.U$ . Parameter setting can also be changed within this group.















Notes on operation

- If you reset a parameter to its factory default, the parameter will no longer appear in  $\underline{U}r.U$ .
- $F7, F470 - F473$  are not appeared, if the value of these parameters are changed.

## ■ How to search and reprogram parameters

The operations of search and resetting of parameters are as follows.

Key operated	LED display	Operation
	0.0	Displays the operation frequency (operation stopped). (When standard monitor display selection $F 710=0$ [Operation frequency])
	$RUH$	The first basic parameter " $RUH$ " (history function) is displayed.
	$\underline{U}r.U$	Press $\Delta$ or $\nabla$ key to select $\underline{U}r.U$ .

Key operated	LED display	Operation
	$U - - -$	Press the ENTER key to enable the user parameter automatic edit function.
 or  	$U - - F$ ( $U - - r$ ) ↓ $ACC$	Searches for parameters that are different in value from the standard default setting and displays those parameters. Press the ENTER key or the $\Delta$ key to change the parameter displayed. (Pressing the $\nabla$ key moves the search in the reverse direction).
	$8.0$	Press the ENTER key to display the set value.
 	$5.0$	Press the $\Delta$ key and $\nabla$ key to change set value.
	$5.0 \leftrightarrow ACC$	Press the ENTER key to save the changed value. The parameter name and the programmed value will flash on and off alternately. After the change has been saved, " $U - - -$ " is displayed.
 (  )	$U - - F$ ( $U - - r$ )	Use the same steps as those given above to display parameters that you want to search for or change setting with the $\Delta$ key and $\nabla$ key.
 (  )	$Cr.U$	When $Cr.U$ appears again, the search is ended.
 	$Cr.U$ ↓ $F r - F$ ↓ $0.0$	A search can be canceled by pressing the MODE key. Press the MODE key once while the search is underway to return to the display of parameter setting mode. After that you can press the MODE key to return to the status monitor mode or the standard monitor mode (display of operation frequency).

If there is anything you do not understand during this operation, press the  key several times to start over from the step of  $RUH$  display.

## 4.2.4 Searching for a history of changes, using the history function ( $RUH$ )

History function ( $RUH$ ):

Automatically searches for 5 latest parameters that are programmed with values different from the standard default setting and displays them in the  $RUH$ . Parameter setting can also be changed within this group  $RUH$ .

Notes on operation

- If no history information is stored, this parameter is skipped and the next parameter " $RU 1$ " is displayed.
- $HERd$  and  $End$  are added respectively to the first and last parameters in a history of changes.

## ■ How to use the history function

Key operated	LED display	Operation
	0.0	Displays the operation frequency (operation stopped). (When standard monitor display selection $F7: i0=0$ [Operation frequency])
(MODE)	RUH	The first basic parameter "RUH" (history function) is displayed.
(ENT)	RCC	The parameter that was set or changed last is displayed.
(ENT)	8.0	Press the ENTER key to display the set value.
(▲) (▼)	5.0	Press the ▲ key and ▼ key to change set value.
(ENT)	5.0 ⇄ RCC	Press the ENTER key to save the changed value. The parameter name and the programmed value will flash on and off alternately.
(▲) (▼)	****	Use the same steps as those given above to display parameters that you want to search for or change setting with the ▲ key and ▼ key.
(▲) (▼)	HERd (End)	HERd: First historic record End: Last historic record
(MODE) (MODE) (MODE)	Parameter display ↓ RUH ↓ Fr - F ↓ 0.0	Press the MODE key to return to the parameter setting mode "RUH." After that you can press the MODE key to return to the status monitor mode or the standard monitor mode (display of operation frequency).

Note) Parameter  $F700$  (Prohibition of change of parameter settings) is not displayed in this "RUH".

## 4.2.5 Parameters that cannot be changed while running

For safety reasons, the following parameters have been set up so that they cannot be reprogrammed while the inverter is running. Stop operation ("0.0" or "0FF" is displayed) before changing parameter settings.

[Basic parameters]

$RU1, RU2, RU4, Cn0d^*, Fn0d^*, tYP, FH, uL, uLv, Pt$

[Extended parameters]

$F105, F108-F118, F130-F139, F170, F171, F261, F301-F311, F316, F342-F345, F400, F415-F419, F480-F496, F603, F605, F608, F613, F626, F627, F669, F910-F912$

The setting of any parameter other than the above can be changed even during operation.

Keep in mind, however, that when the parameter  $F700$  (prohibition of change of parameter settings) is set to 1 (prohibited), no parameters can be set or changed.

\* Set  $F736, Cn0d$  and  $Fn0d$  can be changed while the inverter is running.

## 4.2.6 Returning all parameters to standard default setting





Setting the standard default setting parameter  $\text{tYP}=3$ , all parameters can be returned to the those factory default settings.

Note: For more details on the standard default setting parameter  $\text{tYP}$ , see 5.6.

### Notes on operation

- We recommend that before this operation you write down on paper the values of those parameters, because when setting  $\text{tYP}=3$ , all parameters with changed values will be returned to standard factory default setting.
- Note that  $F7$ ,  $F75L$ ,  $F109$ ,  $F470-F473$ ,  $F669$  and  $F880$  will not be reset to their factory default settings.

### ■ Steps for returning all parameters to standard default setting

Key operated	LED display	Operation
	0.0	Displays the operation frequency (perform during operation stopped).
	RUH	The first basic parameter "RUH" (history function) is displayed.
	tYP	Press the $\Delta$ key or the $\nabla$ key to change to $\text{tYP}$ .
	3 0	Pressing the ENTER key displays the programmed parameters. ( $\text{tYP}$ will always display "0(zero)" on the right, the previous setting on the left.)
	3 3	Press the $\Delta$ key or the $\nabla$ key to change the set value. To return to standard factory default setting, change to "3".
	in it	Pressing the ENTER key displays "in it" while returning all parameters to factory default setting.
	0.0	The monitor returns to the display of setup parameters.

If there is anything you do not understand during this operation, press the  key several times to start over from the step of RUH display.

## 4.2.7 How to save/load the user setting parameters

The current settings of all parameters can be stored (saved) in memory at a time by setting the standard setting mode selection parameter  $\text{tYP}$  to 7. Also, all parameter settings stored in memory can be restored (loaded) by setting parameter  $\text{tYP}$  to 0. This means that you can use this parameter ( $\text{tYP}=7$  and 0) as the parameter for your own initial settings (default settings).

## 5. Monitoring the operation status

Refer to 4.1 about flow of monitor.

### 5.1 Status monitor mode













#### 5.1.1 Status monitor under normal conditions

In this mode, you can monitor the operation status of the inverter.

To display the operation status during normal operation:

Press the  key twice.

Setting procedure (eg. operation at 60Hz)

Item displayed	Key operated	LED display	Communication No.	Description
		60.0		The operation frequency is displayed (Operation at 60Hz). (When standard monitor display selection <i>F 7 1 0</i> is set at 0 [operation frequency])
Parameter setting mode		<i>R U H</i>		The first basic parameter "R U H" (history function) is displayed.
Direction of rotation		<i>F r - F</i>	FE01	The direction of rotation is displayed. ( <i>F r - F</i> : forward run, <i>F r - r</i> : reverse run)
Operation frequency command		<i>F 60.0</i>	FE02	The operation frequency command value (Hz/free unit) is displayed.
Load current		<i>ℓ 80</i>	FE03	The inverter output current (load current) (%A) is displayed.
Input voltage		<i>Y 100</i>	FE04	The inverter input (DC) voltage (%V) is displayed.
Output voltage		<i>P 100</i>	FE05	The inverter output voltage (%V) is displayed.
Torque		<i>9 60</i>	FE18	The torque (%) is displayed.
Torque current		<i>c 90</i>	FE20	The torque current (%A) is displayed.
Inverter load factor		<i>ℓ 70</i>	FE27	The inverter load factor (%) is displayed.
PBR cumulative load factor		<i>r 50</i>	FE25	The cumulative load factor of the braking resistor (%) is displayed.
Input power		<i>h 80</i>	FE29	The inverter input power (kW) is displayed.
Output power		<i>H 75</i>	FE30	The inverter output power (kW) is displayed.
Operation frequency		<i>o 60.0</i>	FD00	The operation frequency (Hz/free unit) is displayed.











(Continued overleaf)

(Continued)

Item displayed	Key operated	LED display	Communication No.	Description
Note 4 Input terminal		.....!!!	FE06	The ON/OFF status of each of the control signal input terminals (F, R, RES, S1, S2, S3, VIB and VIA) is displayed in bits.  ON: ! OFF: , 
Note 5 Output terminal		0 . . . ! !	FE07	The ON/OFF status of each of the control signal output terminals (RY, OUT and FL) is displayed in bits.  ON: ! OFF: , 
CPU1 version		u 10 !	FE08	The version of the CPU1 is displayed.
CPU2 version		u c 0 !	FE73	The version of the CPU2 is displayed.
Memory version		u E 0 !	FE09	The version of the memory mounted is displayed.
PID feedback		d 5 0	FE22	The PID feedback value is displayed. (Hz / free unit)
Frequency command value (PID-computed)	  	b 7 0	FE15	The PID-computed frequency command value is displayed. (Hz / free unit)
Note 6 Integral input power		h 8 5	FE76	The integrated amount of power (kWh) supplied to the inverter is displayed. (0.01=1kWh, 1.00=100kWh)
Note 6 Integral output power		H 7 5	FE77	The integrated amount of power (kWh) supplied from the inverter is displayed. (0.01=1kWh, 1.00=100kWh)
Rated current		R 16.5	FE70	The rated current of the inverter (A) is displayed.
Note 7 Past trip 1		0 C 3 ⇔ 1	FE10	Past trip 1 (displayed alternately)
Note 7 Past trip 2		0 H ⇔ 2	FE11	Past trip 2 (displayed alternately)
Note 7 Past trip 3		0 P 3 ⇔ 3	FE12	Past trip 3 (displayed alternately)

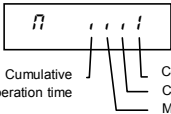
(Continued overleaf)

(Continued)

	Item displayed	Key operated	LED display	Communication No.	Description
Note 7	Past trip 4			FE13	Past trip 4 (displayed alternately)
Note 8	Parts replacement alarm information			FE79	The ON/OFF status of each of the cooling fan, circuit board capacitor, main circuit capacitor of parts replacement alarm or cumulative operation time are displayed in bits.  ON:  OFF:   
Note 9	Cumulative operation time			FE14	The cumulative operation time is displayed. (0.01=1 hour, 1.00=100 hours)
	Default display mode				The operation frequency is displayed (Operation at 60Hz).

## 5.1.2 Display of detailed information on a past trip

Details on a past trip (of trips 1 to 4) can be displayed, as shown in the table below, by pressing the **(ENT)** key when the trip record is selected in the status monitor mode.

Unlike the "Display of detailed trip information at the occurrence of a trip" in 5.2.2, details on a past trip can be displayed, even after the inverter is turned off or reset.

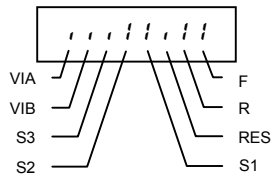
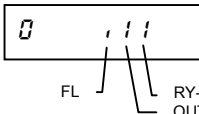
	Item displayed	Key operated	LED display	Description
Note 11	Past trip 1		$0C \ 1 \leftrightarrow \ 1$	Past trip 1 (displayed alternately)
	Continuous trips	<b>(ENT)</b>	$n \ 2$	The number of time the same trip occurred in succession is displayed. (Unit: times)
Note 1	Operation frequency	<b>(▲)</b>	$060.0$	The operation frequency when the trip occurred is displayed.
	Direction of rotation	<b>(▲)</b>	$F r - F$	The direction of rotation when the trip occurred is displayed. ( $F r - F$ : Forward run, $F r - r$ : Reverse run)
	Operation frequency command	<b>(▲)</b>	$F80.0$	The operation command value when the trip occurred is displayed.
Note 2	Load current	<b>(▲)</b>	$C \ 150$	The inverter output current when the trip occurred is displayed. (%/A)
Note 3	Input voltage	<b>(▲)</b>	$Y \ 120$	The inverter input voltage (DC) when the trip occurred is displayed. (%/V).
	Output voltage	<b>(▲)</b>	$P \ 100$	The inverter output voltage when the trip occurred is displayed. (%/V)
Note 4	Input terminal	<b>(▲)</b>	$... \ 1 \ 1 \ 1 \ 1 \ 1 \ 1$	The ON/OFF statuses of the control input terminals (F, R, RES, S1, S2, S3, VIB and VIA) are displayed in bits. 
Note 5	Output terminal	<b>(▲)</b>	$0 \ 1 \ 1 \ 1$	The ON/OFF statuses of the control output terminals (RY, OUT and FL) are displayed in bits. 
Note 9	Cumulative operation time	<b>(▲)</b>	$t \ 8.56$	The cumulative operation time when the trip occurred is displayed. (0.01=1 hour, 1.00=100 hours)
	Past trip 1	<b>(MODE)</b>	$0C \ 1 \leftrightarrow \ 1$	Press this key to return to past trip 1.



## 5.2 Display of trip information

### 5.2.1 Trip code display

If the inverter trips, an error code is displayed to suggest the cause. Since trip records are retained, information on each trip can be displayed anytime in the status monitor mode.













For the kinds of causes that can be indicated in the event of a trip, see section 9.1.

### 5.2.2 Display of trip information at the occurrence of a trip

At the occurrence of a trip, the same information as that displayed in the mode described in 5.1.1, "Status monitor under normal conditions," can be displayed, as shown in the table below, if the inverter is not turned off or reset.

To display trip information after turning off or resetting the inverter, follow the steps described in 5.1.2, "Display of detailed information on a past trip."

#### ■ Example of call-up of trip information

Item displayed	Key operated	LED display	Communication No.	Description
Cause of trip		<i>OP2</i>		Status monitor mode (The code blinks if a trip occurs.) The motor coasts and comes to a stop (coast stop).
Parameter setting mode		<i>RUH</i>		The first basic parameter "RUH" (history function) is displayed.
Direction of rotation		<i>F r - F</i>	FE01	The direction of rotation at the occurrence of a trip is displayed. ( <i>F r - F</i> : forward run, <i>F r - r</i> : reverser run).
Operation frequency command		<i>F 60.0</i>	FE02	The operation frequency command value (Hz/free unit) at the occurrence of a trip is displayed.
Load current		<i>L 130</i>	FE03	The output power of the inverter at the occurrence of a trip (%/A) is displayed.
Input voltage		<i>U 141</i>	FE04	The inverter input (DC) voltage (%/V) at the occurrence of a trip is displayed.
Output voltage		<i>P 100</i>	FE05	The output voltage of the inverter at the occurrence of a trip (%/V) is displayed.
Torque		<i>T 60</i>	FE18	The torque at the occurrence of a trip (%) is displayed.
Torque current		<i>c 90</i>	FE20	The torque current (%/A) at the occurrence of a trip is displayed.
Inverter load factor		<i>L 70</i>	FE27	The inverter load factor (%) at the occurrence of a trip is displayed.
PBR cumulative load factor		<i>r 50</i>	FE25	The cumulative load factor (%) of the resistor at the occurrence of a trip is displayed.
Input power		<i>h 80</i>	FE29	The inverter input power (kW) at the occurrence of a trip is displayed.
Output power		<i>H 75</i>	FE30	The inverter output power (kW) at the occurrence of a trip is displayed.
Operation frequency		<i>o 60.0</i>	FE00	The inverter output frequency (Hz/free unit) at the occurrence of a trip is displayed.

(Continued overleaf)

(Continued)

Item displayed	Key operated	LED display	Communication No.	Description
Note 4 Input terminal		.....	FE06	The ON/OFF statuses of the control input terminals (F, R, RES, S1, S2, S3, VIB and VIA) are displayed in bits. 
Note 5 Output terminal		0 . . .	FE07	The ON/OFF status of each of the control signal output terminals (RY, OUT and FL) at the occurrence of a trip is displayed in bits. 
CPU1 version		v 10 1	FE08	The version of the CPU1 is displayed.
CPU2 version		v c 0 1	FE73	The version of the CPU2 is displayed.
Memory version		v E 0 1	FE09	The version of the memory mounted is displayed.
PID feedback		d 5 0	FE22	The PID feedback value at the occurrence of a trip is displayed. (Hz / free unit)
Frequency command value (PID-computed)		b 7 0	FE15	The PID-computed frequency command value at the occurrence of a trip is displayed. (Hz / free unit)
Integral input power		h 8 5	FE76	The integrated amount of power (kWh) supplied to the inverter is displayed. (0.01=1kWh, 1.00=100kWh)
Integral output power		H 7 5	FE77	The integrated amount of power (kWh) supplied from the inverter is displayed. (0.01=1kWh, 1.00=100kWh)
Rated current		R 1 6.5	FE70	The inverter rated current (A) at the occurrence of a trip is displayed.
Note 7 Past trip 1		0 P 2 ⇔ 1	FE10	Past trip 1 (displayed alternately)
Note 7 Past trip 2		0 H ⇔ 2	FE11	Past trip 2 (displayed alternately)
Note 7 Past trip 3		0 P 3 ⇔ 3	FE12	Past trip 3 (displayed alternately)
Note 7 Past trip 4		n E r r ⇔ 4	FE13	Past trip 4 (displayed alternately)

(Continued overleaf)

(Continued)

	Item displayed	Key operated	LED display	Communication No.	Description
Note 8	Parts replacement alarm information			FE79	The ON/OFF status of each of the cooling fan, circuit board capacitor, main circuit capacitor of parts replacement alarm or cumulative operation time are displayed in bits.  ON: OFF:   Cumulative operation time Cooling fan Control circuit board capacitor Main circuit capacitor
Note 9	Cumulative operation time			FE14	The cumulative operation time is displayed. (0.01=1 hour, 1.00=100 hours)
	Default display mode				The cause of the trip is displayed.

Note 1: Items displayed can be changed by pressing or key in the each monitor mode.

Note 2: You can switch between % and A (ampere)/V (volt), using the parameter  $F 7 \bar{0} \bar{1}$  (current/voltage unit selection).

Note 3: The input (DC) voltage displayed is  $1. \sqrt{2}$  times as large as the rectified d.c. input voltage.

Note 4: The number of bars displayed varies depending on the setting of  $F 1 \bar{0} \bar{9}$  (analog input/logic input function selection). The bar representing VIA or VIB is displayed only when the logic input function is assigned to the VIA or VIB terminal, respectively.

If  $F 1 \bar{0} \bar{9} = \bar{0}$ : Neither the bar representing VIA nor the bar representing VIB is displayed.

If  $F 1 \bar{0} \bar{9} = \bar{1}$  or  $\bar{2}$ : The bar representing VIA is not displayed.

The bar representing VIB is displayed.

If  $F 1 \bar{0} \bar{9} = \bar{3}$  or  $\bar{4}$ : Both the bar representing VIA and VIB are displayed.

Note 5: The number of bars displayed varies depending on the setting of  $F 5 \bar{5} \bar{9}$  (logic output/pulse train output selection). The bar representing the OUT-NO terminal is displayed only when logic output function is assigned to it.

If  $F 5 \bar{5} \bar{9} = \bar{0}$ : The bar representing OUT-NO is displayed.

If  $F 5 \bar{5} \bar{9} = \bar{1}$ : The bar representing OUT-NO is not displayed.

Note 6: The integrated amounts of input and output power will be reset to zero, if you press and hold down the key for 3 seconds or more when power is off or when the input terminal function CKWH (input terminal function: 51) is turned on or displayed.

Note 7: Past trip records are displayed in the following sequence: 1 (latest trip record)  $\leftrightarrow 2 \leftrightarrow 3 \leftrightarrow 4$  (oldest trip record). If no trip occurred in the past, the message "n E r r" will be displayed. Details on past trip record 1, 2, 3 or 4 can be displayed by pressing the key when past trip 1, 2, 3 or 4 is displayed. For more information, see 5.1.2.

Note 8: Parts replacement alarm is displayed based on the value calculated from the annual average ambient temperature, the ON time of the inverter, the operating time of the motor and the output current (load factor) specified using  $F 5 \bar{3} \bar{4}$ . Use this alarm as a guide only, since it is based on a rough estimation.

Note 9: The cumulative operation time increments only when the machine is in operation.

Note 10: At the occurrence of a trip, maximum values are not always recorded and displayed for reasons of detecting time.

Note 11: If there is no trip record,  $n\bar{E}r r$  is displayed.

- ☆ Of the items displayed on the monitor, the reference values of items expressed in percent are listed below.
- Load current: The current monitored is displayed. The reference value (100% value) is the rated output current indicated on the nameplate. That is, it corresponds to the rated current at the time when the PWM carrier frequency ( $F\bar{3}\bar{0}\bar{0}$ ) is 4kHz or less. The unit can be switched to A (amperes).
  - Input voltage: The voltage displayed is the voltage determined by converting the voltage measured in the DC section into an AC voltage. The reference value (100% value) is 200 volts for 240V models, 400 volts for 500V models or 575 volts for 600V models. The unit can be switched to V (volts).
  - Torque: The torque generated by the drive motor is displayed. The reference value (100% value) is the rated torque of the motor.
  - Torque current: The current required to generate torque is calculated from the load current by vector operations. The value thus calculated is displayed. The reference value (100% value) is the value at the time when the load current is 100%.
  - Load factor of inverter: Depending on the PWM carrier frequency ( $F\bar{3}\bar{0}\bar{0}$ ) setting and so on, the actual rated current may become smaller than the rated output current indicated on the nameplate. With the actual rated current at that time (after a reduction) as 100%, the proportion of the load current to the rated current is indicated in percent. The load factor is also used to calculate the conditions for overload trip ( $\bar{0}\bar{L}\bar{1}$ ).
  - PBR cumulative load factor: The load factor of the braking resistor that may come up to the level at which an overload trip ( $\bar{0}\bar{L}\bar{r}$ ) occurs is indicated in percent. An overload trip occurs when it reaches 100%.

## 6. Measures to satisfy the standards

### 6.1 How to cope with the CE directive

In Europe, the EMC directive and the low-voltage directive, which took effect in 1996 and 1997, respectively, make it obligatory to put the CE mark on every applicable product to prove that it complies with the directives. Inverters do not work alone but are designed to be installed in a control panel and always used in combination with other machines or systems which control them, so they themselves are not considered to be subject to the EMC directive. However, the CE mark must be put on all inverters because they are subject to the low-voltage directive.

The CE mark must be put on all machines and systems with built-in inverters because such machines and systems are subject to the above directives. It is the responsibility of the manufacturers of such final products to put the CE mark on each one. If they are "final" products, they might also be subject to machine-related directives.

It is the responsibility of the manufacturers of such final products to put the CE mark on each one. In order to make machines and systems with built-in inverters compliant with the EMC directive and the low-voltage directive, this section explains how to install inverters and what measures should be taken to satisfy the EMC directive.

We have tested representative models with them installed as described later in this manual to check for conformity with the EMC directive. However, we cannot check all inverters for conformity because whether or not they conform to the EMC direction depends on how they are installed and connected. In other words, the application of the EMC directive varies depending on the composition of the control panel with a built-in inverter(s), the relationship with other built-in electrical components, the wiring condition, the layout condition, and so on. Therefore, please verify yourself whether your machine or system conforms to the EMC directive.

#### 6.1.1 About the EMC directive

Inverters themselves are not subject to approval for CE marking.

The CE mark must be put on every final product that includes an inverter(s) and a motor(s). The VF-S11 series of inverters complies with the EMC directive if an EMI filter recommended by Toshiba is connected to it and wiring is carried out correctly.

- EMC directive 89/336/EEC

The EMC standards are broadly divided into two categories; immunity- and emission-related standards, each of which is further categorized according to the operating environment of each individual machine. Since inverters are intended for use with industrial systems under industrial environments, they fall within the EMC categories listed in Table 1 below. The tests required for machines and systems as final products are almost the same as those required for inverters.

Table 1 EMC standards

Category	Subcategory	Product standards	Test standard and level
Emission	Radiation noise	IEC 61800-3	EN55011 Class A Group 1
	Transmission noise		EN55011 Class A Group 1
Immunity	Static discharge		IEC61000-4-2
	Radioactive radio-frequency magnetic contactor field		IEC61000-4-3
	First transient burst		IEC61000-4-4
	Lightning surge		IEC61000-4-5
	Radio-frequency induction/transmission interference		IEC61000-4-6
	Voltage dip/Interruption of power		IEC61000-4-11

Emission standards other than the above are applied to inverters when used in a commercial environment but not an industrial environment.

Category	Subcategory	Product standards	Test standard and level
Emission	Radiation noise	IEC 61800-3	EN55011 Class B Group 1
	Transmission noise		EN55011 Class B Group 1

6

## 6.1.2 Measures to satisfy the EMC directive

This subsection explains what measures must be taken to satisfy the EMC directive.

- (1) Insert a recommended EMI filter (Table 2) on the input side of the inverter to reduce and transmission noise and radiation noise from input cables.

In the combinations listed in Table 2, Inverters are tested in these combination to see if they comply with transmission noise standards. For inverters used in Japan, it is recommended to use the NF series of noise filters.

Table 2 lists noise filters recommended for the inverters.

Table 2 Combinations of inverter and EMI filter

Three-phase 240V class

Inverter	Combination of inverter and filter	
	Transmission noise EN55011 Class A Group 1 Applicable filters (Length of motor connecting cable: Max. 5 m)	Transmission noise EN55011 Class B Group 1 Applicable filters (Length of motor connecting cable: Max. 1 m)
VFS11-2002PM		EMFS11-2007AZ
VFS11-2004PM		EMFS11-2007AZ
VFS11-2005PM		EMFS11-2007AZ
VFS11-2007PM		EMFS11-2007AZ
VFS11-2015PM		EMFS11-4015BZ
VFS11-2022PM		EMFS11-4015BZ
VFS11-2037PM		EMFS11-4025CZ
VFS11-2055PM		EMFS11-4047DZ
VFS11-2075PM		EMFS11-4047DZ
VFS11-2110PM		EMFS11-2083EZ
VFS11-2150PM		EMFS11-2083EZ

## Three-phase 500V class

Combination of inverter and filter			
Inverter	Transmission noise EN55011 Class A Group 1 Applicable filters (Length of motor connecting cable: Max. 5 m)	Transmission noise EN55011 Class B Group 1 Applicable filters (Length of motor connecting cable: Max. 20 m)	Transmission noise EN55011 Class A Group 1 Applicable filters (Length of motor connecting cable: Max. 50 m)
VFS11-4004PL	With a built-in filter		EMFS11-4015BZ
VFS11-4007PL	With a built-in filter		EMFS11-4015BZ
VFS11-4015PL	With a built-in filter		EMFS11-4015BZ
VFS11-4022PL	With a built-in filter		EMFS11-4025CZ
VFS11-4037PL	With a built-in filter		EMFS11-4025CZ
VFS11-4056PL	With a built-in filter		EMFS11-4047DZ
VFS11-4075PL	With a built-in filter		EMFS11-4047DZ
VFS11-4110PL	With a built-in filter		EMFS11-4049EZ
VFS11-4150PL	With a built-in filter		EMFS11-4049EZ

## Single-phase 240V class

Combination of inverter and filter			
Inverter	Transmission noise EN55011 Class A Group 1 Applicable filters (Length of motor connecting cable: Max. 5 m)	Transmission noise EN55011 Class B Group 1 Applicable filters (Length of motor connecting cable: Max. 20 m)	Transmission noise EN55011 Class A Group 1 Applicable filters (Length of motor connecting cable: Max. 50 m)
VFS11S-2002PL	With a built-in filter		EMFS11S-2009AZ
VFS11S-2004PL	With a built-in filter		EMFS11S-2009AZ
VFS11S-2007PL	With a built-in filter		EMFS11S-2009AZ
VFS11S-2015PL	With a built-in filter		EMFS11S-2016BZ
VFS11S-2022PL	With a built-in filter		EMFS11S-2022CZ

Note : For 600V models compliant with EU standards, contact your nearest Toshiba inverter distributor.

- (2) Use shielded power cables, such as inverter output cables, and shielded control cables. Route the cables and wires so as to minimize their lengths. Keep a distance between the power cable and the control cable and between the input and output wires of the power cable. Do not route them in parallel or bind them together, instead cross at right angle.
- (3) Install the inverter and the filter on the same metal plate. It is more effective in limiting the radiation noise to install the inverter in a sealed steel cabinet. Using wires as thick and short as possible, earth the metal plate and the control panel securely with a distance kept between the earth cable and the power cable.
- (4) Route the EMI filter input and output wires apart from each other.
- (5) To suppress radiation noise from cables, ground all shielded cables through a noise cut plate.  
It is effective to earth shielded cables in the vicinity of the inverter, cabinet and filter (within a radius of 10cm from each of them). Inserting a ferrite core in a shielded cable is even more effective in limiting the radiation noise.
- (6) To further limit the radiation noise, insert a zero-phase reactor in the inverter output line and insert ferrite cores in the earth cables of the metal plate and cabinet.

[Example of wiring]

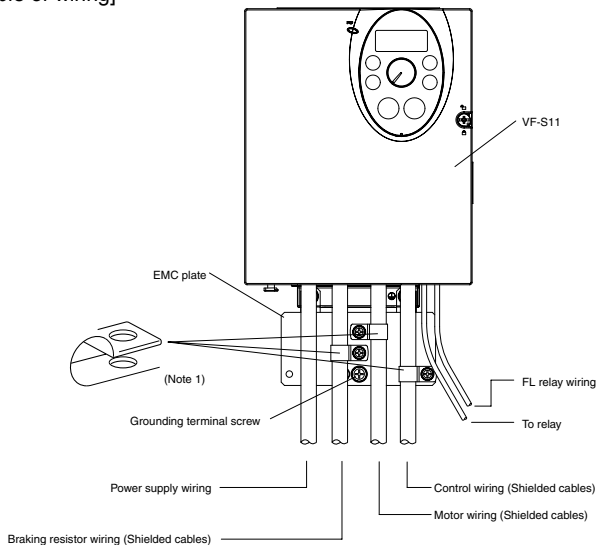

Note 1: Strip and earth the shielded cable, following the example shown in Fig.

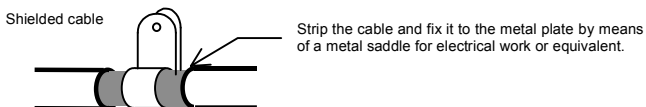

### 6.1.3 About the low-voltage directive

The low-voltage directive provides for the safety of machines and systems. All Toshiba inverters are CE-marked in accordance with the standard EN 50178 specified by the low-voltage directive, and can therefore be installed in machines or systems and imported without problem to European countries.

Applicable standard: EN50178

Electronic equipment for use in power installations

Electronic equipment for use in power installations

Pollution level: 2 (5.2.15.2)

Overvoltage category: 3

240V class - 3.0mm (5.2.16.1)

500V class - 5.5mm (5.2.16.1)



EN 50178 applies to electrical equipment intended specially for use in power installations, and sets out the conditions to be observed for electric shock prevention when designing, testing, manufacturing and installing electronic equipment for use in power installations.

## 6.1.4 Measures to satisfy the low-voltage directive

When incorporating the inverter into a machine or system, it is necessary to take the following measures so that the inverter satisfies the low-voltage directive.

- (1) Install the inverter in a cabinet and ground the inverter enclosure. When doing maintenance, be extremely careful not to put your fingers into the inverter through a wiring hole and touch a charged part, which may occur depending on the model and capacity of the inverter used.
- (2) Do not connect two or more wires to the main circuit earth terminal of the inverter. If necessary, install an additional earth terminal on the metal plate on which the inverter is installed and connect another cable to it. Or install the EMC plate (attached as standard) and another cable connect to earth terminal on the EMC plate. Refer to the table 10.1 for earth cable sizes.
- (3) Install a non-fuse circuit breaker or a fuse on the input side of the inverter.

## 6.2 Compliance with UL Standard and CSA Standard

The VF-S11 models, that conform to the UL Standard and CSA Standard have the UL/CSA mark on the nameplate.

### 6.2.1 Compliance with Installation

The VF-S11 inverter must be installed in a panel, and used within the ambient temperature specification. (See section 1.4.4)

### 6.2.2 Compliance with Connection

Use the UL conformed cables (Rating 75 °C or more) to the main circuit terminals (R/L1, S/L2, T/L3, U/T1, V/T2, W/T3, PA/+, PB, PC/-, PO).

Refer to the table of next page about wire sizes.

### 6.2.3 Compliance with Peripheral devices

Use the UL listed fuses at connecting to power supply.

Short circuit test is performed under the condition of the power supply short-circuit currents in below.

These interrupting capacities and fuse rating currents depend on the applicable motor capacities.

### ■ AIC, Fuse and Wire sizes

Voltage class	Capacity of applicable motor (kW)	Inverter model	AIC (A) (Interrupting capacity)	Fuse class and current (A)	Wire sizes of power circuit
Single-phase 240V class	0.2	VFS11S-2002PL	AIC 1000A	CC/J 6A max.	AWG 14
	0.4	VFS11S-2004PL	AIC 1000A	CC/J 10A max.	AWG 14
	0.75	VFS11S-2007PL	AIC 1000A	CC/J 15A max.	AWG 14
	1.5	VFS11S-2015PL	AIC 1000A	CC/J 20A max.	AWG 12
	2.2	VFS11S-2022PL	AIC 1000A	CC/J 30A max.	AWG 10
Three-phase 240V class	0.4	VFS11-2004PM	AIC 5000A	CC/J 6A max.	AWG 14
	0.55	VFS11-2005PM	AIC 5000A	CC/J 10A max.	AWG 14
	0.75	VFS11-2007PM	AIC 5000A	CC/J 10A max.	AWG 14
	1.5	VFS11-2015PM	AIC 5000A	CC/J 15A max.	AWG 14
	2.2	VFS11-2022PM	AIC 5000A	CC/J 20A max.	AWG 12
	4.0	VFS11-2037PM	AIC 5000A	J 35A max.	AWG 10
	5.5	VFS11-2055PM	AIC 22000A	J 50A max.	AWG 8
	7.5	VFS11-2075PM	AIC 22000A	J 60A max.	AWG 6
	11	VFS11-2110PM	AIC 22000A	J 80A max.	AWG 4
15	VFS11-2150PM	AIC 22000A	J 110A max.	AWG 6x2	
Three-phase 500V class	0.4	VFS11-4004PL	AIC 5000A	CC/J 3A max.	AWG 14
	0.75	VFS11-4007PL	AIC 5000A	CC/J 6A max.	AWG 14
	1.5	VFS11-4015PL	AIC 5000A	CC/J 10A max.	AWG 14
	2.2	VFS11-4022PL	AIC 5000A	CC/J 15A max.	AWG 14
	4.0	VFS11-4037PL	AIC 5000A	CC/J 20A max.	AWG 12
	5.5	VFS11-4055PL	AIC 22000A	CC/J 30A max.	AWG 10
	7.5	VFS11-4075PL	AIC 22000A	J 35A max.	AWG 8
	11	VFS11-4110PL	AIC 22000A	J 50A max.	AWG 8
15	VFS11-4150PL	AIC 22000A	J 70A max.	AWG 6	
Three-phase 600V class	0.75	VFS11-6007P	AIC 5000A	CC/J 6A max.	AWG 14
	1.5	VFS11-6015P	AIC 5000A	CC/J 6A max.	AWG 14
	2.2	VFS11-6022P	AIC 5000A	CC/J 10A max.	AWG 14
	4.0	VFS11-6037P	AIC 5000A	CC/J 15A max.	AWG 14
	5.5	VFS11-6055P	AIC 22000A	CC/J 20A max.	AWG 10
	7.5	VFS11-6075P	AIC 22000A	CC/J 25A max.	AWG 10
	11	VFS11-6110P	AIC 22000A	J 30A max.	AWG 8
	15	VFS11-6150P	AIC 22000A	J 45A max.	AWG 8

6

## 6.2.4 Motor thermal protection

Selects the electronic thermal protection characteristics that fit with the ratings and characteristics of the motor. In case of multi motor operation with one inverter, thermal relay should be connected to each motor.

## 7. Table of parameters and data

For details on the function of each parameter, refer to the full version of English manual (E6581158).

### 7.1 User parameters

Title	Function	Unit	Minimum setting unit Panel/Communication	Adjustment range	Default setting	User setting	Reference E6581158
F $\zeta$	Operation frequency of operation panel	Hz	0.1/0.01	1 - 10	0.0		3.2

### 7.2 Basic parameters

- Four navigation functions

Title	Communication No.	Function	Unit	Minimum setting unit Panel/Communication	Adjustment range	Default setting	User setting	Reference E6581158
R $U$ H	-	History function	-	-	Displays parameters in groups of five in the reverse order to that in which their settings were changed. * (Possible to edit)	-		4.1.4
R $U$ i	0000	Automatic acceleration/ deceleration	-	-	0: Disabled (manual) 1: Automatic 2: Automatic (only at acceleration)	0		5.1.1
R $U$ 2	0001	Torque boost setting macro function	-	-	0: Disabled 1: Automatic torque boost + auto-tuning 2: Vector control + auto-tuning 3: Energy saving + auto-tuning	0		5.2
R $U$ 4	0040	Parameter setting macro function	-	-	0: Disabled 1: Coast stop 2: 3-wire operation 3: External input UP/DOWN setting 4: 4-20 mA current input operation	0		5.3

- Basic parameters

Title	Communication No.	Function	Unit	Minimum setting unit Panel/Communication	Adjustment range	Default setting	User setting	Reference E6581158
C $R$ 3	0003	Command mode selection	-	-	0: Terminal board 1: Operation panel	1		5.4 7.2
F $R$ 3	0004	Frequency setting mode selection 1	-	-	0: Built-in potentiometer 1: VIA 2: VIB 3: Operation panel 4: Serial communication 5: UP/DOWN from external contact 6: VIA + VIB (Override)	0		5.4 6.5.1 7.1

Title	Communication No.	Function	Unit	Minimum setting unit Panel/Communication	Adjustment range	Default setting	User setting	Reference E6581158
$F\bar{A}5L$	0005	Meter selection	-	-	0: Output frequency 1: Output current 2: Set frequency 3: DC voltage 4: Output voltage command value 5: Input power 6: Output power 7: Torque 8: Torque current 9: Motor cumulative load factor 10: Inverter cumulative load factor 11: PBR (braking reactor) cumulative load factor 12: Frequency setting value (after PID) 13: V/A Input value 14: V/B Input value 15: Fixed output 1 (Output current: 100%) 16: Fixed output 2 (Output current: 50%) 17: Fixed output 3 (Other than the output current: 100%) 18: Serial communication data 19: For adjustments ( $F\bar{A}$ set value is displayed.)	0		5.5
$F\bar{A}$	0006	Meter adjustment	-	-	-	-		5.5
$L\bar{Y}P$	0007	Default setting	-	-	0: - 1: 50Hz default setting 2: 60Hz default setting 3: Default setting (Initialization) 4: Trip record clear 5: Cumulative operation time clear 6: Initialization of type information 7: Save user-setting parameters 8: Load user-setting parameters 9. Cumulative fan operation time record clears	0		4.2.6 4.2.7 5.6
$F\bar{r}$	0008	Forward/reverse run selection (Operation panel)	-	-	0: Forward run 1: Reverse run 2: Forward run (F/R switching possible) 3: Reverse run (F/R switching possible)	0		5.7
$R\bar{L}L$	0009	Acceleration time 1	S	0.1/0.1	0.0-3200	10.0		5.1.2
$d\bar{E}L$	0010	Deceleration time 1	S	0.1/0.1	0.0-3200	10.0		5.1.2
$F\bar{H}$	0011	Maximum frequency	Hz	0.1/0.01	30.0-500.0	80.0		5.8
$\bar{U}L$	0012	Upper limit frequency	Hz	0.1/0.01	0.5- $F\bar{H}$	50.0 (WP) 60.0 (WN, AN)		5.9
$\bar{L}L$	0013	Lower limit frequency	Hz	0.1/0.01	0.0- $\bar{U}L$	0.0		5.9
$\bar{u}L$	0014	Base frequency 1	Hz	0.1/0.01	25-500.0	50.0 (WP) 60.0 (WN, AN)		5.10
$\bar{u}L\bar{u}$	0409	Base frequency voltage 1	V	1/0.1	50-330 (240V class) 50-660 (500/600V class)	*3		5.10 6.13.6

\*3 : 230 (240V class), 460 (500V class), 575V (600V class)

Title	Communication No.	Function	Unit	Minimum setting unit Panel/Communication	Adjustment range	Default setting	User setting	Reference E6581158																															
PŁ	0015	V/F control mode selection	-	-	0: V/F constant 1: Variable torque 2: Automatic torque boost control 3: Vector control 4: Energy-saving 5: Dynamic energy-saving (for fans and pumps) 6: PM motor control	2		5.11																															
υb	0016	Torque boost value 1	%	0.1/0.1	0.0-30.0	* 1		5.12																															
ŁHr	0600	Motor electronic-thermal protection level 1	% (A)	1/1	10-100	100		5.13 6.19.1																															
ŁŁŃ	0017	Electronic-thermal protection characteristic selection *2	-	-	<table border="1"> <thead> <tr> <th>Setting</th> <th></th> <th>Overload protection</th> <th>OL stall</th> </tr> </thead> <tbody> <tr> <td>0</td> <td rowspan="3">Standard motor</td> <td>○</td> <td>×</td> </tr> <tr> <td>1</td> <td>○</td> <td>○</td> </tr> <tr> <td>2</td> <td>×</td> <td>×</td> </tr> <tr> <td>3</td> <td rowspan="4">VF motor</td> <td>×</td> <td>○</td> </tr> <tr> <td>4</td> <td>○</td> <td>×</td> </tr> <tr> <td>5</td> <td>○</td> <td>○</td> </tr> <tr> <td>6</td> <td>×</td> <td>×</td> </tr> <tr> <td>7</td> <td></td> <td>×</td> <td>○</td> </tr> </tbody> </table>	Setting		Overload protection	OL stall	0	Standard motor	○	×	1	○	○	2	×	×	3	VF motor	×	○	4	○	×	5	○	○	6	×	×	7		×	○	0		5.13
Setting		Overload protection	OL stall																																				
0	Standard motor	○	×																																				
1		○	○																																				
2		×	×																																				
3	VF motor	×	○																																				
4		○	×																																				
5		○	○																																				
6		×	×																																				
7		×	○																																				
5r 1	0018	Preset-speed operation frequency 1	Hz	0.1/0.01	Ł Ł -ŁŁ	0.0		5.14																															
5r 2	0019	Preset-speed operation frequency 2	Hz	0.1/0.01	Ł Ł -ŁŁ	0.0																																	
5r 3	0020	Preset-speed operation frequency 3	Hz	0.1/0.01	Ł Ł -ŁŁ	0.0																																	
5r 4	0021	Preset-speed operation frequency 4	Hz	0.1/0.01	Ł Ł -ŁŁ	0.0																																	
5r 5	0022	Preset-speed operation frequency 5	Hz	0.1/0.01	Ł Ł -ŁŁ	0.0																																	
5r 6	0023	Preset-speed operation frequency 6	Hz	0.1/0.01	Ł Ł -ŁŁ	0.0																																	
5r 7	0024	Preset-speed operation frequency 7	Hz	0.1/0.01	Ł Ł -ŁŁ	0.0																																	
F - -	-	Extended parameters	-	-	-	-	-		4.1.2																														
Łr Ł	-	Automatic edit function	-	-	-	-	-	4.1.3																															

\*1 : Default values vary depending on the capacity. See the table of the page 64.

\*2 : ○ : valid, × : invalid

## 7.3 Extended parameters

- Input/output parameters 1

Title	Communication No.	Function	Unit	Minimum setting unit Panel/Communication	Adjustment range	Default setting	User setting	Reference E6581158
F 1 0 0	0100	Low-speed signal output frequency	Hz	0.1/0.01	0.0- <i>F</i> H	0.0		6.1.1
F 1 0 1	0101	Speed reach setting frequency	Hz	0.1/0.01	0.0- <i>F</i> H	0.0		6.1.3
F 1 0 2	0102	Speed reach detection band	Hz	0.1/0.01	0.0- <i>F</i> H	2.5		6.1.2
F 1 0 5	0105	Priority selection (Both F-CC and R-CC are ON)	-	-	0: Reverse 1: Slowdown Stop	1		6.2.1
F 1 0 8	0108	Always active function selection 1	-	-	0-65 (No function)	0		6.3.1
F 1 0 9	0109	Analog/contact input function selection (VIA/VIB terminal)	-	-	0: Analog input for communications VIB - analog input 1: VIA - analog input VIB - contact input (Sink) 2: VIA - analog input VIB - contact input (Source) 3: VIA - contact input (Sink) VIB - contact input (Sink) 4: VIA - contact input (Source) VIB - contact input (Source)	0		6.2.2
F 1 1 0	0110	Always-active function selection 2	-	-	0-65 (ST)	1		6.3.1
F 1 1 1	0111	Input terminal selection 1 (F)	-	-	0-65 (F)	2		6.3.2
F 1 1 2	0112	Input terminal selection 2 (R)	-	-	0-65 (R)	3		
F 1 1 3	0113	Input terminal selection 3 (RES)	-	-	0-65 (RES)	10		
F 1 1 4	0114	Input terminal selection 4 (S1)	-	-	0-65 (SS1)	6		
F 1 1 5	0115	Input terminal selection 5 (S2)	-	-	0-65 (SS2)	7		
F 1 1 6	0116	Input terminal selection 6 (S3)	-	-	0-65 (SS3)	8		
F 1 1 7	0117	Input terminal selection 7 (VIB)	-	-	5-17 (SS4)	9		
F 1 1 8	0118	Input terminal selection 8 (VIA)	-	-	5-17 (AD2)	5		6.3.3
F 1 3 0	0130	Output terminal selection 1A (RY-RC)	-	-	0-255 (LOW)	4		
F 1 3 1	0131	Output terminal selection 2A (OUT-NO)	-	-	0-255 (RCH)	6		
F 1 3 2	0132	Output terminal selection 3 (FL)	-	-	0-255 (FL)	10		
F 1 3 7	0137	Output terminal selection 1B (RY-RC)	-	-	0-255 (always ON)	255		6.3.4
F 1 3 8	0138	Output terminal selection 2B (OUT-NO)	-	-	0-255 (always ON)	255		

Title	Communication No.	Function	Unit	Minimum setting unit Panel/Communication	Adjustment range	Default setting	User setting	Reference E6581158
F 139	0139	Output terminal logic selection (RY-RC, OUT-NO)	-	-	0: F 130 and F 137 F 131 and F 138 1: F 130 or F 137 F 131 and F 138 2: F 130 and F 137 F 131 or F 138 3: F 130 or F 137 F 131 or F 138	0		6.3.4
F 167	0167	Frequency command agreement detection range	Hz	0.1/0.01	0.0-FH	2.5		6.3.5
F 170	0170	Base frequency 2	Hz	0.1/0.01	25.0-500.0	50.0 (WP) 60.0 (WN, AN)		6.4.1
F 171	0171	Base frequency voltage 2	V	1/0.1	50-330 (240V class) 50-660 (500/600V class)	* 3		
F 172	0172	Torque boost value 2	%	0.1/0.1	0.0-30.0	* 1		
F 173	0173	Motor electronic-thermal protection level 2	% (A)	1/1	10-100	100		5.13 6.4.1
F 185	0185	Stall prevention level 2	% (A)	1/1	10-199, 200 (disabled)	150		6.4.1 6.19.2

\*1 : Default values vary depending on the capacity. See the table of page 64.

\*3 : 230 (240V class), 460 (500V class), 575 (600V class)

### • Frequency parameters

Title	Communication No.	Function	Unit	Minimum setting unit Panel/Communication	Adjustment range	Default setting	User setting	Reference E6581158
F 200	0200	Frequency priority selection	-	-	0: F 100 (Switchable to F 207 by terminal input) 1: F 100 (Switchable to F 207 at less than 1.0Hz of designated frequency)	0		6.5.1 7.1
F 201	0201	VIA input point 1 setting	%	1/1	0-100	0		6.5.2
F 202	0202	VIA input point 1 frequency	Hz	0.1/0.01	0.0-500.0	0.0		
F 203	0203	VIA input point 2 setting	%	1/1	0-100	100		
F 204	0204	VIA input point 2 frequency	Hz	0.1/0.01	0.0-500.0	50.0 (WP) 60.0 (WN, AN)		
F 207	0207	Frequency setting mode selection 2	-	-	0: Built-in potentiometer 1: VIA 2: VIB 3: Operation panel 4: Serial communication 5: UP/DOWN from external contact 6: VIA + VIB (Override)	1		6.3.5 6.5.1 7.1

Title	Communication No.	Function	Unit	Minimum setting unit Panel/Communication	Adjustment range	Default setting	User setting	Reference E6581158
F210	0210	VIB input point 1 setting	%	1/1	0-100	0		6.5.2
F211	0211	VIB input point 1 frequency	Hz	0.1/0.01	0.0-500.0	0.0		
F212	0212	VIB input point 2 setting	%	1/1	0-100	100		
F213	0213	VIB input point 2 frequency	Hz	0.1/0.01	0.0-500.0	50.0 (WP) 60.0 (WN, AN)		
F240	0240	Starting frequency setting	Hz	0.1/0.01	0.5-10.0	0.5		6.6.1
F241	0241	Operation starting frequency	Hz	0.1/0.01	0.0-FH	0.0		6.6.2
F242	0242	Operation starting frequency hysteresis	Hz	0.1/0.01	0.0-FH	0.0		6.6.2
F250	0250	DC braking starting frequency	Hz	0.1/0.01	0.0-FH	0.0		6.7.1
F251	0251	DC braking current	%(A)	1/1	0-100	50		
F252	0252	DC braking time	s	0.1/0.1	0.0-20.0	1.0		6.7.2
F254	0254	Motor shaft fixing control	-	-	0: Disabled 1: Enabled (after DC braking)	0		
F256	0256	Time limit for lower-limit frequency operation	s	0.1/0.1	0: Disabled 0.1-600.0	0.0		6.8
F260	0260	Jog run frequency	Hz	0.1/0.01	F240-20.0	5.0		6.9
F261	0261	Jog run stopping pattern	-	-	0: Slowdown stop 1: Coast stop 2: DC braking	0		
F262	0262	Panel jog run operation mode	-	-	0: Invalid 1: Valid	0		
F264	0264	Input from external contacts - UP response time	s	0.1/0.1	0.0-10.0	0.1		
F265	0265	Input from external contacts - UP frequency step width	Hz	0.1/0.01	0.0-FH	0.1		6.5.2
F266	0266	Input from external contacts - DOWN response time	s	0.1/0.1	0.0-10.0	0.1		
F267	0267	Input from external contacts - DOWN frequency step width	Hz	0.1/0.01	0.0-FH	0.1		
F268	0268	Initial value of UP/DOWN frequency	Hz	0.1/0.01	LL - UL	0.0		
F269	0269	Saving of changed value of UP/DOWN frequency	-	-	0: Not changed 1: Setting of F268 changed when power is turned off	1		6.10
F270	0270	Jump frequency 1	Hz	0.1/0.01	0.0-FH	0.0		
F271	0271	Jumping width 1	Hz	0.1/0.01	0.0-30.0	0.0		
F272	0272	Jump frequency 2	Hz	0.1/0.01	0.0-FH	0.0		



Title	Communication No.	Function	Unit	Minimum setting unit Panel/Communication	Adjustment range	Default setting	User setting	Reference E6581158
F 2 7 3	0273	Jumping width 2	Hz	0.1/0.01	0.0-30.0	0.0		6.10
F 2 7 4	0274	Jump frequency 3	Hz	0.1/0.01	0.0-FH	0.0		
F 2 7 5	0275	Jumping width 3	Hz	0.1/0.01	0.0-30.0	0.0		
F 2 8 7	0287	Preset-speed operation frequency 8	Hz	0.1/0.01	L L -U L	0.0		5.14
F 2 8 8	0288	Preset-speed operation frequency 9	Hz	0.1/0.01	L L -U L	0.0		
F 2 8 9	0289	Preset-speed operation frequency 10	Hz	0.1/0.01	L L -U L	0.0		
F 2 9 0	0290	Preset-speed operation frequency 11	Hz	0.1/0.01	L L -U L	0.0		
F 2 9 1	0291	Preset-speed operation frequency 12	Hz	0.1/0.01	L L -U L	0.0		
F 2 9 2	0292	Preset-speed operation frequency 13	Hz	0.1/0.01	L L -U L	0.0		
F 2 9 3	0293	Preset-speed operation frequency 14	Hz	0.1/0.01	L L -U L	0.0		
F 2 9 4	0294	Preset-speed operation frequency 15 (Fire-speed)	Hz	0.1/0.01	L L -U L	0.0		

• Operation mode parameters

Title	Communication No.	Function	Unit	Minimum setting unit Panel/Communication	Adjustment range	Default setting	User setting	Reference E6581158
F 3 0 0	0300	PWM carrier frequency	kHz	0.1/0.1	2.0 - 16.0	12.0		6.12
F 3 0 1	0301	Auto-restart control selection	-	-	0: Disabled 1: At auto-restart after momentary stop 2: ST terminal on or off 3: At auto-restart or when turning ST-CC on or off 4: At start-up	0		6.13.1
F 3 0 2	0302	Regenerative power ride-through control (Deceleration stop)	-	-	0: Disabled 1: Automatic setting 2: Slowdown stop	0		6.13.2
F 3 0 3	0303	Retry selection (number of times)	Times	1/1	0: Disabled 1-10	0		6.13.3
F 3 0 4	0304	Dynamic braking selection	-	-	0: Disabled 1: Enabled (Resistor overload protection enabled)	0		6.13.4
F 3 0 5	0305	Overvoltage limit operation (Slowdown stop mode selection)	-	-	0: Enabled 1: Disabled 2: Enabled (Quick deceleration) 3: Enabled (Dynamic quick deceleration)	2		6.13.5

Title	Communication No.	Function	Unit	Minimum setting unit Panel/Communication	Adjustment range	Default setting	User setting	Reference E6581158
F307	0307	Supply voltage correction (limitation of output voltage)	-	-	0: Supply voltage uncorrected, output voltage limited 1: Supply voltage corrected, output voltage limited 2: Supply voltage uncorrected, output voltage unlimited 3: Supply voltage corrected, output voltage unlimited	2 (WP, WN) 3 (AN)		6.13.6
F308	0308	Dynamic braking resistance	Ω	0.1/0.1	1.0-1000	*1		6.13.4
F309	0309	Dynamic braking resistor capacity	kW	0.01/0.01	0.01-30.00	*1		6.13.4
F311	0311	Reverse-run prohibition	-	-	0: Forward/reverse run permitted 1: Reverse run prohibited 2: Forward run prohibited	0		6.13.7
F312	0312	Random mode	-	-	0: Disabled 1: Automatic setting	0		6.12
F316	0316	Carrier frequency control mode selection	-	-	0: Carrier frequency not reduced automatically 1: Carrier frequency reduced automatically 2: Carrier frequency not reduced automatically Support for 500V/600V models 3: Carrier frequency reduced automatically Support for 500V/600V models	1		6.12
F320	0320	Droop gain	%	1/1	0-100	0		6.14
F323	0323	Droop insensitive torque band	%	1/1	0-100	10		6.14
F342	0342	Braking mode selection	-	-	0: Disabled 1: Enabled (forward run) 2: Enabled (reverse run) 3: Enabled (operating direction)	0		6.15
F343	0343	Release frequency	Hz	0.1/0.01	F240-20.0	3.0		
F344	0344	Release time	s	0.01/0.01	0.00-2.50	0.05		
F345	0345	Creeping frequency	Hz	0.1/0.01	F240-20.0	3.0		
F346	0346	Creeping time	s	0.01/0.01	0.00-2.50	0.10		
F359	0359	PID control waiting time	s	1/1	0-2400	0		6.16
F360	0360	PID control	-	-	0: Disabled, 1: Enabled	0		
F362	0362	Proportional gain	-	0.01/0.01	0.01-100.0	0.30		
F363	0363	Integral gain	-	0.01/0.01	0.01-100.0	0.20		
F366	0366	Differential gain	-	0.01/0.01	0.00-2.5	0.00		

\*1 : Default values vary depending on the capacity. See the table of 64.

• Torque boost parameters 1

Title	Communication No.	Function	Unit	Minimum setting unit Panel/Communication	Adjustment range	Default setting	User setting	Reference E6581158
F400	0400	Auto-tuning	-	-	0: Auto-tuning disabled 1: Initialization of F402 (reset to 0) 2: Auto-tuning enabled (after execution: 0)	0		5.11 6.17.1
F401	0401	Slip frequency gain	%	1/1	0-150	50		
F402	0402	Automatic torque boost value	%	0.1/0.1	0.0-30.0	* 1		
F415	0415	Motor rated current	A	0.1/0.1	0.1-100.0	* 1		
F416	0416	Motor no-load current	%	1/1	10-90	* 1		
F417	0417	Motor rated speed	min-1	1/1	100-32000	1410(WP) 1710 (WN_AN)	40	
F418	0418	Speed control response coefficient	-	1/1	1-150			
F419	0419	Speed control stability coefficient	-	1/1	1-100	20		

\*1 : Default values vary depending on the capacity. See the table of page 64.

• Input/output parameters 2

Title	Communication No.	Function	Unit	Minimum setting unit Panel/Communication	Adjustment range	Default setting	User setting	Reference E6581158
F470	0470	VIA input bias	-	-	-	-		6.5.4
F471	0471	VIA input gain	-	-	-	-		
F472	0472	VIB input bias	-	-	-	-		
F473	0473	VIB input gain	-	-	-	-		

• Torque boost parameters 2

Title	Communication No.	Function	Unit	Minimum setting unit Panel/Communication	Adjustment range	Default setting	User setting	Reference E6581158
F480	0480	Exciting current coefficient	%	1/1	100-130	100		5.11 6.17.2
F485	0485	Stall prevention control coefficient 1	-	1/1	10-250	100		
F492	0492	Stall prevention control coefficient 2	-	1/1	50-150	100		
F494	0494	Motor adjustment coefficient	-	1/1	0-200	* 1		
F495	0495	Maximum voltage adjustment coefficient	%	1/1	90-110	104		
F496	0496	Waveform switching adjustment coefficient	kHz	0.1/0.01	0.1-14.0	0.2		

\*1 : Default values vary depending on the capacity. See the table of page 64.

• Acceleration/deceleration time parameters

Title	Communication No.	Function	Unit	Minimum setting unit Panel/Communication	Adjustment range	Default setting	User setting	Reference E6581158
F500	0500	Acceleration time 2	s	0.1/0.1	0.0-3200	10.0		6.18
F501	0501	Deceleration time 2	s	0.1/0.1	0.0-3200	10.0		
F502	0502	Acceleration/deceleration 1 pattern	-	-	0: Linear 1: S-pattern 1	0		
F503	0503	Acceleration/deceleration 2 pattern	-	-	2: S-pattern 2	0		
F504	0504	Acceleration/deceleration selection (1, 2, 3)	-	-	1: Acceleration/deceleration 1 2: Acceleration/deceleration 2 3: Acceleration/deceleration 3	1		
F505	0505	Acceleration/deceleration 1 and 2 switching frequency	Hz	0.1/0.01	0.0-UL	0.0		
F506	0506	S-pattern lower-limit adjustment amount	%	1/1	0-50	10		
F507	0507	S-pattern upper-limit adjustment amount	%	1/1	0-50	10		6.18
F510	0510	Acceleration time 3	s	0.1/0.1	0.0-3200	10.0		
F511	0511	Deceleration time 3	s	0.1/0.1	0.0-3200	10.0		
F512	0512	Acceleration/deceleration 3 pattern	-	-	0: Linear 1: S-pattern 1 2: S-pattern 2	0		
F513	0513	Acceleration/deceleration 2 and 3 switching frequency	Hz	0.1/0.01	0.0-UL	0.0		

• Protection parameters

Title	Communication No.	Function	Unit	Minimum setting unit Panel/Communication	Adjustment range	Default setting	User setting	Reference E6581158
F601	0601	Stall prevention level 1	% (A)	1/1	10-199, 200 (disabled)	150		6.19.2
F602	0602	Inverter trip retention selection	-	-	0: Canceled with the power off 1: Still retained with the power off	0		6.19.3
F603	0603	Emergency stop selection	-	-	0: Coast stop 1: Slowdown stop 2: Emergency DC braking	0		6.19.4
F604	0604	Emergency DC braking time	s	0.1/0.1	0.0-20.0	1.0		6.19.4
F605	0605	Output phase failure detection mode selection	-	-	0: Disabled 1: At start-up (only one time after power is turned on) 2: At start-up (each time) 3: During operation 4: At start-up + during operation 5: Detection of cutoff on output side	0		6.19.5
F607	0607	Motor 150%-overload time limit	s	1/1	10-2400	300		6.19.1
F608	0608	Input phase failure detection mode selection	-	-	0: Disabled, 1: Enabled	1		6.19.6

Title	Communication No.	Function	Unit	Minimum setting unit Panel/Communication	Adjustment range	Default setting	User setting	Reference E6581158
F609	0609	Small current detection current hysteresis	%	1/1	1-20	10		6.19.7
F610	0610	Small current trip/alarm selection	-	-	0: Alarm only 1: Tripping	0		
F611	0611	Small current detection current	% (A)	1/1	0-100	0		
F612	0612	Small current detection time	s	1/1	0-255	0		6.19.8
F613	0613	Detection of output short-circuit during start-up	-	-	0: Each time (standard pulse) 1: At start-up (only one time after power is turned on) (standard pulse) 2: Each time (short-time pulse) 3: At start-up (only one time after power is turned on) (short-time pulse)	0		
F615	0615	Over-torque trip/alarm selection	-	-	0: Alarm only 1: Tripping	0		
F616	0616	Over-torque detection level	%	1/1	0-250	150		6.19.9
F618	0618	Over-torque detection time	s	0.1/0.1	0.0-10.0	0.5		
F619	0619	Over-torque detection level hysteresis	%	1/1	0-100	10		
F621	0621	Cumulative operation time alarm setting	100 Time	0.1/0.1 (=10 hours)	0.0-999.9	610		6.19.10
F626	0626	Over-voltage stall protection level	%	1/1	100-150	*1		6.13.5
F627	0627	Undervoltage trip/alarm selection	-	-	0: Alarm only (detection level below 60%) 1: Tripping (detection level below 60%) 2: Alarm only (detection level below 50%, DC reactor necessary)	0		6.19.12
F633	0633	Trip at VIA low level input mode	%	1/1	0: Disabled, 1-100	0		6.19.13
F634	0634	Annual average ambient temperature (parts replacement alarms)	-	-	1: -10 to +10°C 2: 11-20°C 3: 21-30°C 4: 31-40°C 5: 41-50°C 6: 51-60°C	3		6.19.14

\*1 : Default values vary depending on the capacity. See the table of 64.

• Output parameters

Title	Communication No.	Function	Unit	Minimum setting unit Panel/Communication	Adjustment range	Default setting	User setting	Reference E6581158
F 6 6 9	0669	Logic output/pulse train output selection (OUT-NO)	-	-	0: Logic output 1: Pulse train output	0		6.20.1
F 6 7 6	0676	Pulse train output function selection (OUT-NO)	-	-	0: Output frequency 1: Output current 2: Set frequency 3: DC voltage 4: Output voltage command value 5: Input power 6: Output power 7: Torque 8: Torque current 9: Motor cumulative load factor 10: Inverter cumulative load factor 11: PBR (braking reactor) cumulative load factor 12: Frequency setting value (after PID) 13: VIA/II Input value 14: VIB Input value 15: Fixed output 1 (Output current: 100%) 16: Fixed output 2 (Output current: 50%) 17: Fixed output 3 (Other than the output current: 100%)	0		6.20.1
F 6 7 7	0677	Maximum numbers of pulse train	pps	1/1	500-1600	800		6.20.1
F 6 9 1	0691	Inclination characteristic of analog output	-	-	0: Negative inclination (downward slope) 1: Positive inclination (upward slope)	1		6.20.2
F 6 9 2	0692	Meter bias	%	1/1	0-100	0		6.20.2

• Operation panel parameters

Title	Communication No.	Function	Unit	Minimum setting unit Panel/Communication	Adjustment range	Default setting	User setting	Reference E6581158
F 7 0 0	0700	Prohibition of change of parameter settings	-	-	0: Permitted 1: Prohibited	0		6.21.1
F 7 0 1	0701	Unit selection	-	-	0: % 1: A (ampere)/V (volt)	0		6.21.2
F 7 0 2	0702	Free unit selection	Times	0.01/0.01	0.00: Free unit display disabled (display of frequency) 0.01-200.0	0.00		6.21.3
F 7 0 5	0705	Inclination characteristic of free unit display	-	-	0: Negative inclination (downward slope) 1: Positive inclination (upward slope)	1		6.21.4
F 7 0 6	0706	Free unit display bias	Hz	0.01/0.01	0.00- <i>F H</i>	0.00		
F 7 0 7	0707	Free step 1 (pressing a panel key once)	Hz	0.01/0.01	0.00: Disabled 0.01- <i>F H</i>	0.00		
F 7 0 8	0708	Free step 2 (panel display)	-	1/1	0: Disabled 1-255	0		

Title	Communication No.	Function	Unit	Minimum setting unit Panel/Communication	Adjustment range	Default setting	User setting	Reference E6581158
F 7 10	0710	Standard monitor display selection	-	-	0: Operation frequency (Hz/free unit) 1: Frequency command (Hz/free unit) 2: Output current (%/A) 3: Inverter rated current (A) 4: Inverter load factor (%) 5: Output power (%) 6: Frequency command after PID control (Hz/free unit) 7: Optional item specified from an external control unit	0		6.21.5
F 7 19	0719	Canceling of operation command when standby terminal (ST) is turned off	-	-	0: Operation command canceled (cleared) 1: Operation command retained	1		6.21.6
F 7 21	0721	Panel stop pattern	-	-	0: Slowdown stop 1: Coast stop	0		6.21.7
F 7 30	0730	Prohibition of frequency setting on the operation panel (F C)	-	-	0: Permitted 1: Prohibited	0		6.21.1
F 7 33	0733	Panel operation prohibition (RUN/STOP keys)	-	-	0: Permitted 1: Prohibited	0		
F 7 34	0734	Prohibition of panel emergency stop operation	-	-	0: Permitted 1: Prohibited	0		
F 7 35	0735	Prohibition of panel reset operation	-	-	0: Permitted 1: Prohibited	0		
F 7 36	0736	Prohibition of change of F R G d / F R G d during operation	-	-	0: Permitted 1: Prohibited	1		

• Communication parameters

Title	Communication No.	Function	Unit	Minimum setting unit Panel/Communication	Adjustment range	Default setting	User setting	Reference E6581158
F 8 00	0800	Communication rate	-	-	0: 1200bps 1: 2400bps 2: 4800bps 3: 9600bps 4: 19200bps	3		6.22
F 8 01	0801	Parity	-	-	0: NON (No parity) 1: EVEN (Even parity) 2: ODD (Odd parity)	1		
F 8 02	0802	Inverter number	-	1/1	0-255	0		
F 8 03	0803	Communication error trip time	s	1/1	0: (disabled) 1-100	0		
F 8 05	0805	Communication waiting time	s	0.01/0.01	0.00-2.00	0.00		
F 8 06	0806	Setting of master and slave for communication between inverters	-	-	0: Slave (0 Hz command issued in case the master inverter fails) 1: Slave (Operation continued in case the master inverter fails) 2: Slave (Emergency stop tripping in case the master inverter fails) 3: Master (transmission of frequency commands) 4: Master (transmission of output frequency signals)	0		

Title	Communication No.	Function	Unit	Minimum setting unit Panel/Communication	Adjustment range	Default setting	User setting	Reference E6581158
F811	0811	Communication command point 1 setting	%	1/1	0-100	0		6.5.2 6.22.1
F812	0812	Communication command point 1 frequency	Hz	0.1/0.01	0.0-500.0	0.0		
F813	0813	Communication command point 2 setting	%	1/1	0-100	100		
F814	0814	Communication command point 2 frequency	Hz	0.1/0.01	0.0-500.0	50.0 (WP) 60.0 (WN, AN)		
F829	0829	Selection of communication protocol	-	-	0: Toshiba inverter protocol 1: Modbus RTU protocol	0		6.22
F870	0870	Block write data 1	-	-	0: No selection 1: Command information 1 2: Command information 2	0		
F871	0871	Block write data 2	-	-	3: Frequency command 4: Output data on the terminal board 5: Analog output for communications	0		
F875	0875	Block read data 1	-	-	0: No selection 1: Status information	0		
F876	0876	Block read data 2	-	-	2: Output frequency 3: Output current	0		
F877	0877	Block read data 3	-	-	4: Output voltage 5: Alarm information	0		
F878	0878	Block read data 4	-	-	6: PID feedback value 7: Input terminal board monitor	0		
F879	0879	Block read data 5	-	-	8: Output terminal board monitor 9: VIA terminal board monitor	0		
F880	0880	Free notes	-	1/1	10: VIB terminal board monitor	0		
F890	0890	Parameter for option 1	-	1/1	0-65535	0		
F891	0891	Parameter for option 2	-	1/1	0-65535	0		
F892	0892	Parameter for option 3	-	1/1	0-65535	0		
F893	0893	Parameter for option 4	-	1/1	0-65535	0		
F894	0894	Parameter for option 5	-	1/1	0-65535	0		

• PM motor parameters

Title	Communication No.	Function	Unit	Minimum setting unit Panel/Communication	Adjustment range	Default setting	User setting	Reference E6581158
F910	0910	Step-out detection current level	% (A)	1/1	10-150	100		6.24
F911	0911	Step-out detection time	s	1/1	0.0: No detection 0.1-25.0	0.0		
F912	0912	High-speed torque adjustment coefficient	-	0.01/0.01	0.00-650.0	0.00		



### ■ Default settings by inverter rating

Inverter type	Torque boost value 1/2	Dynamic braking resistance	Dynamic braking resistor capacity	Automatic torque boost value	Motor rated current	Motor no-load current	Motor adjustment coefficient	Over-voltage stall protection level
	$\omega b / F 172$ (%)	$F 308$ ( $\Omega$ ) (Note)	$F 309$ (kW)	$F 402$ (%)	$F 415$ (A)	$F 416$ (%)	$F 494$	$F 626$ (%)
VFS11S-2002PL	6.0	200.0	0.12	8.3	1.2	70	90	134
VFS11S-2004PL	6.0	200.0	0.12	6.2	2.0	65	90	134
VFS11S-2007PL	6.0	200.0	0.12	5.8	3.4	60	80	134
VFS11S-2015PL	6.0	75.0	0.12	4.3	6.2	55	70	134
VFS11S-2022PL	5.0	75.0	0.12	4.1	8.9	52	70	134
VFS11-2002PM	6.0	200.0	0.12	8.3	1.2	70	90	134
VFS11-2004PM	6.0	200.0	0.12	6.2	2.0	65	90	134
VFS11-2005PM	6.0	200.0	0.12	6.0	2.7	62	80	134
VFS11-2007PM	6.0	200.0	0.12	5.8	3.4	60	80	134
VFS11-2015PM	6.0	75.0	0.12	4.3	6.2	55	70	134
VFS11-2022PM	5.0	75.0	0.12	4.1	8.9	52	70	134
VFS11-2037PM	5.0	40.0	0.12	3.4	14.8	48	70	134
VFS11-2055PM	4.0	20.0	0.24	3.0	21.0	46	70	134
VFS11-2075PM	3.0	15.0	0.44	2.5	28.2	43	70	134
VFS11-2110PM	2.0	10.0	0.66	2.3	40.6	41	60	134
VFS11-2150PM	2.0	7.5	0.88	2.0	54.6	38	50	134
VFS11-4004PL	6.0	200.0	0.12	6.2	1.0	65	90	140
VFS11-4007PL	6.0	200.0	0.12	5.8	1.7	60	80	140
VFS11-4015PL	6.0	200.0	0.12	4.3	3.1	55	70	140
VFS11-4022PL	5.0	200.0	0.12	4.1	4.5	52	70	140
VFS11-4037PL	5.0	160.0	0.12	3.4	7.4	48	70	140
VFS11-4055PL	4.0	80.0	0.24	2.6	10.5	46	70	140
VFS11-4075PL	3.0	60.0	0.44	2.3	14.1	43	70	140
VFS11-4110PL	2.0	40.0	0.66	2.2	20.3	41	60	140
VFS11-4150PL	2.0	30.0	0.88	1.9	27.3	38	50	140
VFS11-6007P	3.0	285.0	0.06	3.8	1.1	61	80	134
VFS11-6015P	3.0	145.0	0.12	3.8	2.1	59	70	134
VFS11-6022P	3.0	95.0	0.18	3.2	3.0	54	70	134
VFS11-6037P	3.0	48.0	0.37	3.5	4.9	50	70	134
VFS11-6055P	2.0	29.0	0.61	2.0	7.3	55	70	134
VFS11-6075P	2.0	29.0	0.61	1.5	9.5	51	70	134
VFS11-6110P	2.0	19.0	0.92	1.9	14.5	55	60	134
VFS11-6150P	1.0	14.0	1.23	1.7	19.3	53	50	134

Note: Be sure to set  $F 308$  (Dynamic braking resistance) at the resistance of the dynamic braking resistor connected.

■ Table of input terminal functions 1

Function No.	Code	Function	Action
0	-	No function is assigned	Disabled
1	ST	Standby terminal	ON: Ready for operation OFF: Coast stop (gate off)
2	F	Forward run command	ON: Forward run OFF: Slowdown stop
3	R	Reverse run command	ON: Reverse run OFF: Slowdown stop
4	JOG	Jog run mode	ON: Jog run, OFF: Jog run canceled
5	AD2	Acceleration/deceleration 2 pattern selection	ON: Acceleration/deceleration 2 OFF: Acceleration/deceleration 1 or 3
6	SS1	Preset-speed command 1	Selection of 15-speed with SS1 to SS4 (4 bits)
7	SS2	Preset-speed command 2	
8	SS3	Preset-speed command 3	
9	SS4	Preset-speed command 4	
10	RES	Reset command	
11	EXT	Trip stop command from external input device	ON: $\bar{E}$ Trip stop
12	CFMOD	Switching of command mode and frequency setting mode	ON: Forced switching from command mode to terminal input mode, forced switching from frequency setting mode to the mode commanded between $F \bar{1} \bar{0} \bar{0} d$ and $F \bar{2} \bar{0} \bar{0} \bar{1}$ . (If $F \bar{2} \bar{0} \bar{0} \bar{0} = \bar{0}$ )
13	DB	DC braking command	ON: DC braking
14	PID	PID control prohibited	ON: PID control prohibited OFF: PID control permitted
15	PWENE	Permission of parameter editing	ON: Parameter editing permitted OFF: Parameter editing prohibited (If $F \bar{1} \bar{0} \bar{0} \bar{0} = \bar{1}$ )
16	ST+RES	Combination of standby and reset commands	ON: Simultaneous input from ST and RES
17	ST+CFMOD	Combination of standby and command/frequency setting mode switching	ON: Simultaneous input from ST and CFMOD
18	F+JOG	Combination of forward run and jog run	ON: Simultaneous input from F and JOG
19	R+JOG	Combination of reverse run and jog run	ON: Simultaneous input from R and JOG
20	F+AD2	Combination of forward run and acceleration/deceleration 2	ON: Simultaneous input from F and AD2
21	R+AD2	Combination of reverse run and acceleration/deceleration 2	ON: Simultaneous input from R and AD2
22	F+SS1	Combination of forward run and preset-speed command 1	ON: Simultaneous input from F and SS1
23	R+SS1	Combination of reverse run and preset-speed command 1	ON: Simultaneous input from R and SS1
24	F+SS2	Combination of forward run and preset-speed command 2	ON: Simultaneous input from F and SS2
25	R+SS2	Combination of reverse run and preset-speed command 2	ON: Simultaneous input from R and SS2
26	F+SS3	Combination of forward run and preset-speed command 3	ON: Simultaneous input from F and SS3
27	R+SS3	Combination of reverse run and preset-speed command 3	ON: Simultaneous input from R and SS3
28	F+SS4	Combination of forward run and preset-speed command 4	ON: Simultaneous input from F and SS4
29	R+SS4	Combination of reverse run and preset-speed command 4	ON: Simultaneous input from R and SS4
30	F+SS1+AD2	Combination of forward run, preset-speed command 1 and acceleration/deceleration 2	ON: Simultaneous input from F, SS1 and AD2
31	R+SS1+AD2	Combination of reverse run, preset-speed command 1 and acceleration/deceleration 2	ON: Simultaneous input from R, SS1 and AD2
32	F+SS2+AD2	Combination of forward run, preset-speed command 2 and acceleration/deceleration 2	ON: Simultaneous input from F, SS2 and AD2
33	R+SS2+AD2	Combination of reverse run, preset-speed command 2 and acceleration/deceleration 2	ON: Simultaneous input from R, SS2 and AD2

■ Table of input terminal functions 2

Function No.	Code	Function	Action
34	F+SS3+AD2	Combination of forward run, preset-speed command 3 and acceleration/deceleration 2	ON: Simultaneous input from F, SS3 and AD2
35	R+SS3+AD2	Combination of reverse run, preset-speed command 3 and acceleration/deceleration 2	ON: Simultaneous input from R, SS3 and AD2
36	F+SS4+AD2	Combination of forward run, preset-speed command 4 and acceleration/deceleration 2	ON: Simultaneous input from F, SS4 and AD2
37	R+SS4+AD2	Combination of reverse run, preset-speed command 4 and acceleration/deceleration 2	ON: Simultaneous input from R, SS4 and AD2
38	FCHG	Frequency command forced switching	ON: $F 2 0 1$ (if $F 2 0 0 = 0$ ) OFF: $F R 0 d$
39	VF2	No.2 Switching of V/F setting	ON: No.2 V/F setting ( $P 1 = 0, F 1 7 0, F 1 7 1, F 1 7 2, F 1 7 3$ ) OFF: No.1 V/F setting (Set value of $P 1, u L, u L u, u b, t H r$ )
40	MOT2	No.2 motor switching (VF2+AD2+OCS2)	ON: No.2 motor ( $P 1 = 0, F 1 7 0, F 1 7 1, F 1 7 2, F 1 7 3, F 1 8 5, F 5 0 0, F 5 0 1, F 5 0 3$ ) OFF: No.1 motor (Set value of $P 1, u L, u L u, u b, t H r, P 1 1, d E 1, F 5 0 2, F 5 0 1$ )
41	UP	Frequency UP signal input from external contacts	ON: Increase in frequency
42	DOWN	Frequency DOWN signal input from external contacts	ON: Reduction in frequency
43	CLR	Frequency UP/DOWN cancellation signal input from external contacts	OFF—ON: Resetting of UP/DOWN frequency by means of external contacts
44	CLR+RES	Combination of frequency UP/DOWN cancellation and reset by means of external contacts	ON: Simultaneous input from CLR and RES
45	EXTN	Inversion of trip stop command from external device	OFF: $\bar{E}$ Trip stop
46	OH	Thermal trip stop signal input from external device	ON: $\bar{O} H 2$ Trip stop
47	OHN	Inversion of thermal trip stop command from external device	OFF: $\bar{O} H 2$ Trip stop
48	SC/LC	Forced switching from remote to local control	Enabled when remote control is exercised ON: Local control (setting of $\bar{L} R 0 d, F R 0 d$ and $F 2 0 1$ ) OFF: Remote control
49	HD	Operation holding (stop of 3-wire operation)	ON: F (forward run)/R: (reverse run) held, 3-wire operation OFF: Slowdown stop
50	CMTF	Forced switching of command mode and terminal board command	ON: Terminal board operation OFF: Setting of $\bar{L} R 0 d$
51	CKWH	Display cancellation of the cumulative power amount (kWh)	ON: Monitor display cancellation of the cumulative power amount (kWh)
52	FORCE	Forced operation (factory configuration required)	ON: Forced operation mode in which operation is not stopped in the event of the occurrence of a soft fault (preset speed operation frequency 15) To use this function, the inverter needs to be so configured at the factory. OFF: Normal operation
53	FIRE	Fire-speed control	ON: Fire-speed operation (preset speed operation frequency 15) OFF: Normal operation

Note. When function 1, 10-12, 15-17, 38, 41-45 or 48 is assigned to an input terminal board, the input terminal board is enabled even if the parameter command mode selection  $\bar{L} R 0 d$  is set at 1 (panel).

### ■ Table of input terminal functions 3

Function No.	Code	Function	Action
54	STN	Coast stop (gate off)	ON: Coast stop (gate off)
55	RESN	Inversion of RES	ON: Acceptance of reset command OFF→ON: Trip reset
56	F+ST	Combination of forward run and standby	ON: Simultaneous input from F and ST
57	R+ST	Combination of reverse run and standby	ON: Simultaneous input from R and ST
58	AD3	Acceleration/deceleration 3 selection	ON: Acceleration/deceleration 3 OFF: Acceleration/deceleration 1 or 2
59	F+AD3	Combination of forward run and acceleration/deceleration 3	ON: Simultaneous input from F and AD3
60	R+AD3	Combination of reverse run and acceleration/deceleration 3	ON: Simultaneous input from R and AD3
61	OCS2	Forced switching of stall prevention level 2	ON: Enabled at the value of $F 185$ OFF: Enabled at the value of $F 601$
62	HDRY	Holding of RY-RC terminal output	ON: Once turned on, RY-RC are held on. OFF: The status of RY-RC changes in real time according to conditions.
63	HDOUT	Holding of OUT-NO terminal output	ON: Once turned on, OUT-NO are held on. OFF: The status of OUT-NO changes in real time according to conditions.
64	PRUN	Cancellation (clearing) of operation command from panel	0: Operation command canceled (cleared) 1: Operation command retained
65	ICLR	PID control integral value clear	ON: PID control integral value always zero OFF: PID control permitted

### ■ Table of output terminal functions 1

Function No.	Code	Function	Action
0	LL	Frequency lower limit	ON: The output frequency is above the $L L$ set value. OFF: The output frequency is equal to or less than the $L L$ set value.
1	LLN	Inversion of frequency lower limit	Inversion of LL setting
2	UL	Frequency upper limit	ON: Output frequency is equal to or higher than $U L$ value. OFF: Output frequency is lower than $U L$ value.
3	ULN	Inversion of frequency upper limit	Inversion of UL setting
4	LOW	Low-speed detection signal	ON: Output frequency is equal to or higher than $F 100$ value. OFF: Output frequency is lower than $F 100$ value.
5	LOWN	Inversion of low-speed detection signal	Inversion of LOW setting
6	RCH	Designated frequency attainment signal (completion of acceleration/deceleration)	ON: The output frequency is equal to or less than the specified frequency $\pm$ frequency set with $F 102$ . OFF: The output frequency is above the specified frequency $\pm$ frequency set with $F 102$ .
7	RCHN	Inversion of designated frequency attainment signal (inversion of completion of acceleration/deceleration)	Inversion of RCH setting
8	RCHF	Set frequency attainment signal	ON: The output frequency is equal to or less than the frequency set with $F 101 \pm F 102$ . OFF: The output frequency is above the frequency set with $F 101 \pm F 102$ .
9	RCHFN	Inversion of set frequency attainment signal	Inversion of RCHF setting
10	FL	Failure signal (trip output)	ON: When inverter is tripped OFF: When inverter is not tripped
11	FLN	Inversion of failure signal (inversion of trip output)	Inversion of FL setting

■ Table of output terminal functions 2

Function No.	Code	Function	Action
12	OT	Over-torque detection	ON: Torque current is equal to or larger than $F 6 15$ set value and longer than $F 6 18$ set time. OFF: The torque current is equal to or less than ( $F 6 15$ set value - $F 6 19$ set value).
13	OTN	Inversion of over-torque detection	Inversion of OT
14	RUN	Start/Stop	ON: When operation frequency is output or during (d b) OFF: Operation stopped
15	RUNN	Inversion of RUN/STOP	Inversion of RUN setting
16	POL	OL pre-alarm	ON: 50% or more of calculated value of overload protection level OFF: Less than 50% of calculated value of overload protection level
17	POLN	Inversion of OL pre-alarm	Inversion of POL setting
18	POHR	Braking resistor overload pre-alarm	ON: 50% or more of calculated value of $F 3 0 8$ set overload protection level OFF: Less than 50% of calculated value of $F 3 0 8$ set overload protection level
19	POHRN	Inversion of braking resistor overload pre-alarm	Inversion of RCHR setting
20	POT	Over-torque detection pre-alarm	ON: Torque current is equal to or larger than 70% of $F 6 15$ set value OFF: The torque current is below ( $F 6 15$ set value x 70% - $F 6 19$ set value).
21	POTN	Inversion of over-torque detection pre-alarm	Inversion of POT setting
22	PAL	Pre-alarm	One of the following is turned on: ON POL, POHR, POT, MOFF, UC, OT, LL stop, COT, and momentary power failure slowdown stop. or $C, P, Q, R, H$ issues an alarm All the following are turned off: OFF POL, POHR, POT, MOFF, UC, OT, LL stop, COT, and momentary power failure slowdown stop. or $C, P, Q, R, H$ issues no alarm
23	PALN	Inversion of pre-alarm	Inversion of PAL setting
24	UC	Small-current detection	ON: The output current is equal to or less than $F 6 11$ set value for $F 6 12$ set time. OFF: The output current is equal to or larger than $F 6 11$ set value + 10%.
25	UCN	Inversion of small-current detection	Inversion of UC setting
26	HFL	Significant failure	ON: $OL1, OL2, OL, E, EPH1, Etn, EPH0, Err2-5, OH2, UP1, EF2, UC, ELYP, Or EPH1$ OFF: Failure other than the above
27	HFLN	Inversion of significant failure	Inversion of HFL setting
28	LFL	Insignificant failure	ON: $OL1-3, OP1-3, OH, OL1-2, OLr$ OFF: Failure other than the above
29	LFLN	Inversion of insignificant failure	Inversion of LFL setting
30	RDY1	Ready for operation (including ST/RUN)	ON: Ready for operation (ST and RUN are also ON) OFF: Others
31	RDY1N	Inversion of ready for operation (including ST/RUN)	Inversion of RDY1 setting
32	RDY2	Ready for operation (excluding ST/RUN)	ON: Ready for operation (ST and RUN are not ON) OFF: Others
33	RDY2N	Inversion of ready for operation (excluding ST/RUN)	Inversion of RDY2
34	FCVIB	Frequency VIB selection	ON: VIB selected as frequency command OFF: Terminal other than VIB selected as frequency command

■ Table of output terminal functions 3

Function No.	Code	Function	Action
35	FCVIBN	Inversion of frequency VIB selection	Inversion of FCVIB
36	FLR	Fault signal (put out also at the time of a retry)	ON: When inverter trips or retries OFF: When inverter does not trip or retry
37	FLRN	Inversion of failure signal (put out also at the time of a retry)	Inversion of FLR
38	OUT0	Specified data output 1	ON: Specified data from remote control FA50: BIT0= 1 OFF: Specified data from remote control FA50: BIT0= 0
39	OUT0N	Inversion of specified data output 1	Inversion of OUT0 setting
40	OUT1	Specified data output 2	ON: Specified data from remote control FA50: BIT1= 1 OFF: Specified data from remote control FA50: BIT1= 0
41	OUT1N	Inversion of specified data output 2	Inversion of OUT1 setting
42	COT	Cumulative operation time alarm	ON: Cumulative operation time is equal to or longer than $F521$ OFF: Cumulative operation time is shorter than $F521$
43	COTN	Inversion of cumulative operation time alarm	Inversion of COT
44	LTA	Parts replacement alarm	ON: Calculation for parts replacement time is equal to or longer than the preset time OFF: Calculation for parts replacement time is shorter than the preset time
45	LTAN	Inversion of replacement alarm	Inversion of LTA
46	BR	Braking sequence output	ON: Braking retention signal OFF: Braking release signal
47	BRN	Inversion of braking sequence output	Inversion of BR
48	LI1	F terminal input signal	ON: The signal input to F terminal is ON OFF: The signal input to F terminal is OFF
49	LI1N	Inversion of F terminal input signal	Inversion of LI1
50	LI2	R terminal input signal	ON: The signal input to R terminal is ON OFF: The signal input to R terminal is OFF
51	LI2N	Inversion of R terminal input signal	Inversion of LI2
52	PIDF	Signal in accordance of frequency command	ON: Frequency commanded by $F\overline{1}\overline{0}\overline{0}$ or $F2\overline{0}\overline{1}$ and that by VIA show the same value. OFF: Frequency commanded by $F\overline{1}\overline{0}\overline{0}$ or $F2\overline{0}\overline{1}$ and that by VIA show different values.
53	PIDFN	Inversion of signal in accordance of frequency command	Inversion of PIDF setting
54	MOFF	Undervoltage detection	ON: Undervoltage detected OFF: Other than undervoltage
55	MOFFN	Inversion of undervoltage detection	Inversion of MOFF
56-253	Disabled	Invalid settings, always OFF (ignored)	Invalid settings, always OFF (ignored)
254	AOFF	Always OFF	Always OFF
255	AON	Always ON	Always ON

# 8. Specifications

## 8.1 Models and their standard specifications

### ■ Standard specifications

Item		Specification										
Input voltage		3-phase 240V										
Applicable motor (kW)		0.2	0.4	0.55	0.75	1.5	2.2	4.0	5.5	7.5	11	15
Rating	Type	VFS11										
	Form	2002PM	2004PM	2005PM	2007PM	2015PM	2022PM	2037PM	2055PM	2075PM	2110PM	2150PM
	Capacity (kVA) Note 1)	0.6	1.3	1.4	1.8	3.0	4.2	6.7	10	13	21	25
	Rated output/current (A) Note 2)	1.5 (1.5)	3.3 (3.3)	3.7 (3.3)	4.8 (4.4)	8.0 (7.9)	11.0 (10.0)	17.5 (16.4)	27.5 (26.0)	33 (33)	54 (49)	66 (60)
	Output voltage Note 3)	3-phase 200V to 240V										
Overload current rating		150%-60 seconds, 200%-0.5 second										
Power supply	Voltage-frequency	3-phase 200V to 240V - 50/60Hz										
	Allowable fluctuation	Voltage + 10%, -15% Note 4), frequency ±5%										
Protective method		IP20 Enclosed type (JEM1030)										
Cooling method		Self-cooling					Forced air-cooled					
Color		Munsel 5Y-8/0.5										
Built-in filter		Basic filter										

Item		Specification													
Input voltage		1-phase 240V					3-phase 500V								
Applicable motor (kW)		0.2	0.4	0.75	1.5	2.2	0.4	0.75	1.5	2.2	4.0	5.5	7.5	11	15
Rating	Type	VFS11S													
	Form	2002PL	2004PL	2007PL	2015PL	2022PL	4004PL	4007PL	4015PL	4022PL	4037PL	4055PL	4075PL	4110PL	4150PL
	Capacity (kVA) Note 1)	0.6	1.3	1.8	3.0	4.2	1.1	1.8	3.1	4.2	7.2	11	13	21	25
	Rated output current (A) Note 2)	1.5 (1.5)	3.3 (3.3)	4.8 (4.4)	8.0 (7.9)	11.0 (10.0)	1.5 (1.5)	2.3 (2.1)	4.1 (3.7)	5.5 (5.0)	9.5 (8.6)	14.3 (13.0)	17.0 (17.0)	27.7 (25.0)	33 (30)
	Rated output voltage Note 3)	3-phase 200V to 240V					3-phase 380V to 500V								
Overload current rating		150%-60 seconds, 200%-0.5 second					150%-60 seconds, 200%-0.5 second								
Power supply	Voltage-current	1-phase 200V to 240V - 50/60Hz					3-phase 380V to 500V - 50/60Hz								
	Allowable fluctuation	Voltage + 10%, -15% Note 4), frequency ±5%					Voltage + 10%, -15% Note 4), frequency ±5%								
Protective method,		IP20 Enclosed type (JEM1030)					IP20 Enclosed type (JEM1030)								
Cooling method		Self-cooling		Forced air-cooled			Forced air-cooled								
Color		Munsel 5Y-8/0.5					Munsel 5Y-8/0.5								
Built-in filter		EMI filter					EMI filter								

Item		Specification									
Input voltage		3-phase 600V									
Applicable motor (kW)		0.75	1.5	2.2	4.0	5.5	7.5	11	15		
Rating	Type	VFS11-									
	Form	6007P	6015P	6022P	6037P	6055P	6075P	6110P	6150P		
	Capacity (kVA) Note 1)	1.7	2.7	3.9	6.1	9	11	17	22		
	Rated output/current (A) Note 2)	1.7 (1.5)	2.7 (2.4)	3.9 (3.5)	6.1 (5.5)	9 (8.1)	11 (9.9)	17 (15.3)	22 (19.8)		
	Output voltage Note 3)	3-phase 525V to 600V									
Overload current rating		150%-60 seconds, 200%-0.5 second									
Power supply	Voltage-frequency	3-phase 525V to 600V - 50/60Hz									
	Allowable fluctuation	Voltage + 10%, -15% Note 4), frequency ±5%									
Protective method		IP20 Enclosed type (JEM1030)									
Cooling method		Forced air-cooled									
Color		Munsel 5Y-8/0.5									
Built-in filter		No filter									

- Note 1. Capacity is calculated at 220V for the 240V models, at 440V for the 500V models and at 575V for the 600V models.  
 Note 2. Indicates rated output current setting when the PWM carrier frequency (parameter F300) is 4kHz or less. When exceeding 4kHz, the rated output current setting is indicated in the parentheses. It needs to be further reduced for PWM carrier frequencies above 12 kHz.

The rated output current is reduced even further for 500V models with a supply voltage of 480V or more.

The default setting of the PWM carrier frequency is 12kHz.

- Note 3. Maximum output voltage is the same as the input voltage.

- Note 4.  $\pm 10\%$  when the inverter is used continuously (load of 100%).

- Note 5. If you are using 600V model, be sure to connect an input reactor (ACL).

## ■ Common specification

	Item	Specification
Principal control functions	Control system	Sinusoidal PWM control
	Rated output voltage	Adjustable within the range of 50 to 600V by correcting the supply voltage (not adjustable above the input voltage)
	Output frequency range	0.5 to 500.0Hz, default setting: 0.5 to 80Hz, maximum frequency: 30 to 500Hz
	Minimum setting steps of frequency	0.1Hz: analog input (when the max. frequency is 100Hz), 0.01Hz: Operation panel setting and communication setting.
	Frequency accuracy	Digital setting: within $\pm 0.01\%$ of the max. frequency (-10 to +60°C) Analog setting: within $\pm 0.5\%$ of the max. frequency (25°C $\pm 10^\circ\text{C}$ )
	Voltage/frequency characteristics	V/f constant, variable torque, automatic torque boost, vector control, automatic energy-saving, dynamic automatic energy-saving control, PM motor control, Auto-tuning, Base frequency (25 - 500Hz) adjusting to 1 or 2, torque boost (0 - 30%) adjusting to 1 or 2, adjusting frequency at start (0.5 - 10Hz)
	Frequency setting signal	Potentiometer on the front panel, external frequency potentiometer (connectable to a potentiometer with a rated impedance of 1 - 10k $\Omega$ ), 0 - 10Vdc (input impedance: VIA/VIB=30k $\Omega$ , 4 - 20mAdc (input impedance: 250 $\Omega$ ))
	Terminal board base frequency	The characteristic can be set arbitrarily by two-point setting. Possible to set individually for three functions: analog input (VIA and VIB) and communication command.
	Frequency jump	Three frequencies can be set. Setting of the jump frequency and the range.
	Upper- and lower-limit frequencies	Upper-limit frequency: 0 to max. frequency, lower-limit frequency: 0 to upper-limit frequency
	PWM carrier frequency	Adjustable within a range of 2.0 to 16.0Hz (default: 12kHz).
PID control	Setting of proportional gain, integral gain, differential gain and control wait time. Checking whether the amount of processing amount and the amount of feedback agree.	
Operation specifications	Acceleration/deceleration time	Selectable from among acceleration/deceleration times 1, 2 and 3 (0.0 to 3200 sec.). Automatic acceleration/deceleration function, S-pattern acceleration/deceleration 1 and 2 and S-pattern adjustable. Control of forced rapid deceleration and dynamic rapid deceleration
	DC braking	Braking start-up frequency: 0 to maximum frequency, braking rate: 0 to 100%, braking time: 0 to 20 seconds, emergency DC braking, motor shaft fixing control
	Dynamic braking	Control and drive circuit is built in the inverter with the braking resistor outside (optional).
	Input terminal function (programmable)	Possible to select from among 66 functions, such as forward/reverse run signal input, jog run signal input, operation base signal input and reset signal input, to assign to 8 input terminals. Logic selectable between sink and source.
	Output terminal functions (programmable)	Possible to select from among 58 functions, such as upper/lower limit frequency signal output, low speed detection signal output, specified speed reach signal output and failure signal output, to assign to FL relay output, open collector output and RY output terminals.
	Forward/reverse run	The RUN and STOP keys on the operation panel are used to start and stop operation, respectively. The switching between forward run and reverse run can be done from one of the three control units: operation panel, terminal board and external control unit.
	Jog run	Jog mode, if selected, allows jog operation from the operation panel or the terminal board.
	Preset speed operation	Base frequency + 15-speed operation possible by changing the combination of 4 contacts on the terminal board.
	Retry operation	Capable of restarting automatically after a check of the main circuit elements in case the protective function is activated. 10 times (Max.) (selectable with a parameter)
	Various prohibition settings	Possible to write-protect parameters and to prohibit the change of panel frequency settings and the use of operation panel for operation, emergency stop or resetting.
	Regenerative power ride-through control	Possible to keep the motor running using its regenerative energy in case of a momentary power failure (default: OFF).
	Auto-restart operation	In the event of a momentary power failure, the inverter reads the rotational speed of the coasting motor and outputs a frequency appropriate to the rotational speed in order to restart the motor smoothly. This function can also be used when switching to commercial power.
	Drooping function	When two or more inverters are used to operate a single load, this function prevents load from concentrating on one inverter due to unbalance.
Override function	The sum of two analog signals (VIA/VIB) can be used as a frequency command value.	
Failure detection signal	1c-contact output: (250Vac-0.5A-cos $\phi$ =0.4)	

<Continued overleaf>



<Continued>

Item		Specification
Protective function	Protective function	Stall prevention, current limitation, over-current, output short circuit, over-voltage, over-voltage limitation, undervoltage, ground fault, power supply phase failure, output phase failure, overload protection by electronic thermal function, armature over-current at start-up, load side over-current at start-up, over-torque, undercurrent, overheating, cumulative operation time, life alarm, emergency stop, braking resistor over-current/overload, various pre-alarms
	Electronic thermal characteristic	Switching between standard motor and constant-torque VF motor, switching between motors 1 and 2, setting of overload trip time, adjustment of stall prevention levels 1 and 2, selection of overload stall
	Reset function	Function of resetting by closing contact 1a or by turning off power or the operation panel. This function is also used to save and clear trip records.
Display function	Alarms	Stall prevention, overvoltage, overload, under-voltage, setting error, retry in process, upper/lower limits
	Causes of failures	Over-current, overvoltage, overheating, short-circuit in load, ground fault, overload on inverter, over-current through arm at start-up, over-current through load at start-up, CPU fault, EEPROM fault, RAM fault, ROM fault, communication error. (Selectable: Overload of braking resistor, emergency stop, under-voltage, low voltage, over-torque, motor overload, output open-phase)
	Monitoring function	Operation frequency, operation frequency command, forward/reverse run, output current, voltage in DC section, output voltage, torque, torque current, load factor of inverter, integral load factor of PBR, input power, output power, information on input terminals, information on output terminals, version of CPU1, version of CPU2, version of memory, PID feedback amount, frequency command (after PID), integral input power, integral output power, rated current, causes of past trips 1 through 4, parts replacement alarm, cumulative operation time
	Past trip monitoring function	Stores data on the past four trips: number of trips that occurred in succession, operation frequency, direction of rotation, load current, input voltage, output voltage, information on input terminals, information on output terminals, and cumulative operation time when each trip occurred.
	Output for frequency meter	Analog output: (1mAdc full-scale DC ammeter or 7.5Vdc full-scale DC ammeter / Rectifier-type AC voltmeter, 225% current Max. 1mAdc, 7.5Vdc full-scale), 4 to 20mA/0 to 20mA output
	4-digit 7-segments LED	Frequency: inverter output frequency. Alarm: stall alarm "C", overvoltage alarm "P", overload alarm "L", overhear alarm "H". Status: inverter status (frequency, cause of activation of protective function, input/output voltage, output current, etc.) and parameter settings. Free-unit display: arbitrary unit (e.g. rotating speed) corresponding to output frequency.
Indicator	Lamps indicating the inverter status by lighting, such as RUN lamp, MON lamp, PRG lamp, % lamp, Hz lamp, frequency setting potentiometer lamp, UP/DOWN key lamp and RUN key lamp. The charge lamp indicates that the main circuit capacitors are electrically charged.	
Environments	Use environments	Indoor, altitude: 1000m (Max.), not exposed to direct sunlight, corrosive gas, explosive gas or vibration (less than 5.9m/s <sup>2</sup> ) (10 to 55Hz)
	Ambient temperature	-10 to +60°C Note)1,2.
	Storage temperature	-20 to +65°C
	Relative humidity	20 to 93% (free from condensation and vapor).

Note 1. Above 40°C : Remove the protective seal from the top of VF-S11.

If the ambient temperature is above 50°C: Remove the seal from the top of the inverter and use the inverter with the rated output current reduced.

Note 2. If inverters are installed side by side (with no sufficient space left between them): Remove the seal from the top of each inverter.

When installing the inverter where the ambient temperature will rise above 40°C, remove the seal from the top of the inverter and use the inverter with the rated output current reduced.

## 8.2 Outside dimensions and mass

### ■ Outside dimensions and mass

Voltage class	Applicable motor (kW)	Inverter type	Dimensions (mm)							Drawing	Approx. weight (kg)
			W	H	D	W1	H1	H2	D2		
1-phase 240V	0.2	VFS11S-2002PL	72	130	130	60	121.5	15	8	A	1.0
	0.4	VFS11S-2004PL			140						1.0
	0.75	VFS11S-2007PL	105	130	150	93	13	B			1.2
	1.5	VFS11S-2015PL			150	13	C	1.4			
	2.2	VFS11S-2022PL			140	170	150	126			157
3-phase 240V	0.2	VFS11-2002PM	72	130	120	60	121.5	15	8	A	0.9
	0.4	VFS11-2004PM									130
	0.55	VFS11-2005PM			130						1.1
	0.75	VFS11-2007PM									1.1
	1.5	VFS11-2015PM	105	130	150	93	13	B		1.2	
	2.2	VFS11-2022PM			150	13	C	1.3			
	4.0	VFS11-2037PM			140	170	150	126		157	14
	5.5	VFS11-2055PM	180	220	170	160	210	12		D	4.8
	7.5	VFS11-2075PM									4.9
	11	VFS11-2110PM									9.3
	15	VFS11-2150PM	245	310	190	225	295	19.5		E	9.6
3-phase 500V	0.4	VFS11-4004PL	105	130	150	93	121.5	13	8	B	1.4
	0.75	VFS11-4007PL									1.5
	1.5	VFS11-4015PL									1.5
	2.2	VFS11-4022PL	140	170	150	126	157	14		C	2.3
	4.0	VFS11-4037PL									2.5
	5.5	VFS11-4055PL	180	220	170	160	210	12		D	5.0
	7.5	VFS11-4075PL									5.1
	11	VFS11-4110PL									9.6
	15	VFS11-4150PL	245	310	190	225	295	19.5		E	9.6
3-phase 600V	0.75	VFS11-6007P	105	130	150	93	121.5	13	8	B	1.3
	1.5	VFS11-6015P									1.3
	2.2	VFS11-6022P	140	170	150	126	157	14		C	2.1
	4.0	VFS11-6037P									2.2
	5.5	VFS11-6055P									4.7
	7.5	VFS11-6075P	180	220	170	160	210	12		D	4.7
	11	VFS11-6110P									8.8
	15	VFS11-6150P	245	310	190	225	295	19.5		E	8.8

8

■ Outline drawing

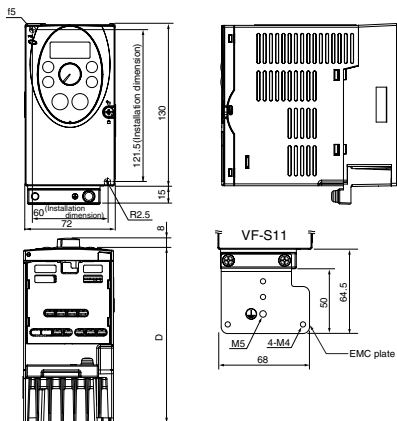

Fig.A

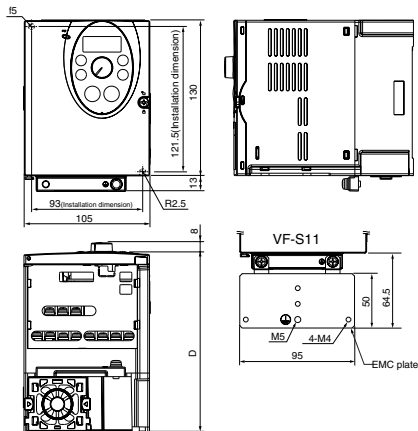

Fig.B

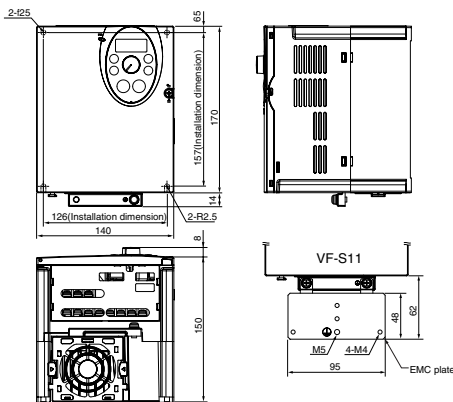

Fig.C

Note 1. To make it easier to grasp the dimensions of each inverter, dimensions common to all inverters in these figures are shown with numeric values but not with symbols.

Here are the meanings of the symbols used.

- W: Width
- H: Height
- D: Depth
- W1: Mounting dimension (horizontal)
- H1: Mounting dimension (vertical)
- H2: Height of EMC plate mounting area
- D2: Depth of frequency setting knob

Note 2. Here are the available EMC plate

- Fig.A : EMP003Z (Approx. weight : 0.1kg)
- Fig.B, Fig.C: EMP004Z (Approx. weight : 0.1kg)
- Fig.D : EMP005Z (Approx. weight : 0.3kg)
- Fig.E : EMP006Z (Approx. weight : 0.3kg)

Note 3. The models shown in Fig. A and Fig. B are fixed at two points: in the upper left and lower right corners.

Note 4. The model shown in Fig. A is not equipped with a cooling fan.

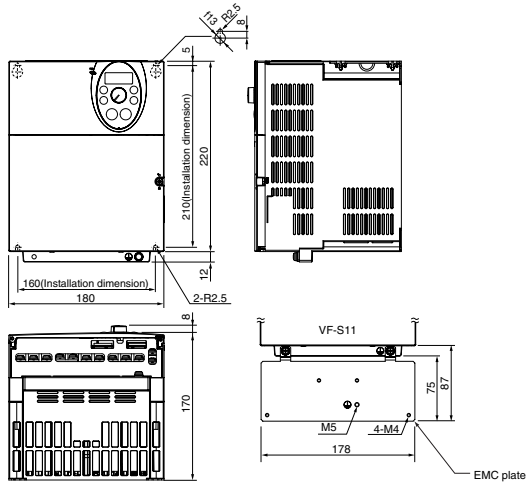

Fig.D

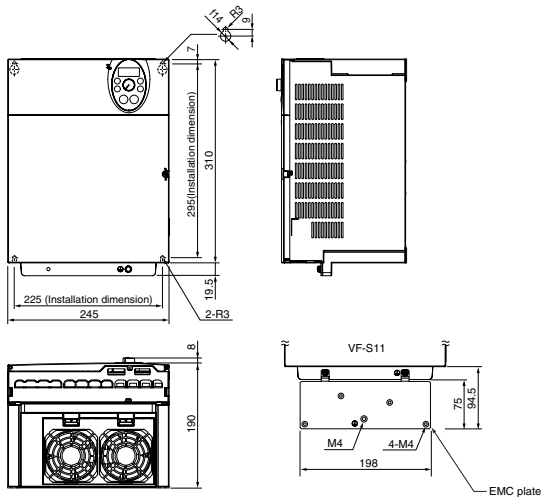

Fig.E

## 9. Before making a service call

### - Trip information and remedies

#### 9.1 Trip causes/warnings and remedies

When a problem arises, diagnose it in accordance with the following table.

If it is found that replacement of parts is required or the problem cannot be solved by any remedy described in the table, contact your Toshiba dealer.

[Trip information]

Error code	Failure code	Problem	Possible causes	Remedies
<i>OC1</i> <i>OC1P</i>	0001 0025	Overcurrent during acceleration Overcurrent flowing in element during acceleration	<ul style="list-style-type: none"> <li>The acceleration time <i>ACC</i> is too short.</li> <li>The V/F setting is improper.</li> <li>A restart signal is input to the rotating motor after a momentary stop, etc.</li> <li>A special motor (e.g. motor with a small impedance) is used.</li> </ul>	<ul style="list-style-type: none"> <li>Increase the acceleration time <i>ACC</i>.</li> <li>Check the V/F parameter.</li> <li>Use <i>F301</i> (auto-restart) and <i>F302</i> (ride-through control).</li> <li>Adjust the carrier frequency <i>F300</i>.</li> <li>Set the carrier frequency control mode selection parameter <i>F315</i> to 1 or 3 (carrier frequency decreased automatically).</li> </ul>
<i>OC2</i> <i>OC2P</i>	0002 0026	Overcurrent during deceleration Overcurrent flowing in element during deceleration	<ul style="list-style-type: none"> <li>The deceleration time <i>DEC</i> is too short.</li> </ul>	<ul style="list-style-type: none"> <li>Increase the deceleration time <i>DEC</i>.</li> <li>Set the carrier frequency control mode selection parameter <i>F315</i> to 1 or 3 (carrier frequency decreased automatically).</li> </ul>
<i>OC3</i> <i>OC3P</i>	0003 0027	Overcurrent during constant speed operation Overcurrent flowing in element during operation	<ul style="list-style-type: none"> <li>The load fluctuates abruptly.</li> <li>The load is in an abnormal condition.</li> </ul>	<ul style="list-style-type: none"> <li>Reduce the load fluctuation.</li> <li>Check the load (operated machine).</li> <li>Set the carrier frequency control mode selection parameter <i>F315</i> to 1 or 3 (carrier frequency decreased automatically).</li> </ul>
<i>OC1P</i> <i>OC2P</i> <i>OC3P</i>	0025 0026 0027	Ground fault trip Arm overcurrent at start-up (for 11 and 15 kW models only)	<ul style="list-style-type: none"> <li>A current leaked from an output cable or the motor to ground.</li> <li>A main circuit elements is defective.</li> </ul>	<ul style="list-style-type: none"> <li>Check cables, connectors, and so on for ground faults.</li> <li>Make a service call.</li> </ul>
<i>OCL</i>	0004	Overcurrent (An overcurrent on the load side at start-up)	<ul style="list-style-type: none"> <li>The insulation of the output main circuit or motor is defective.</li> <li>The motor has too small impedance.</li> <li>A 11 or 15 kW model was started, although a current is leaked from an output cable or the motor to ground.</li> </ul>	<ul style="list-style-type: none"> <li>Check the cables and wires for defective insulation.</li> <li>When using a 11 or 15 kW model, check cables, connectors, and so on for ground faults.</li> </ul>
<i>OCRA</i>	0005	Arm overcurrent at start-up	<ul style="list-style-type: none"> <li>A main circuit elements is defective.</li> </ul>	<ul style="list-style-type: none"> <li>Make a service call.</li> </ul>
* <i>EPH1</i>	0008	Input phase failure	<ul style="list-style-type: none"> <li>A phase failure occurred in the input line of the main circuit.</li> <li>The capacitor in the main circuit lacks capacitance.</li> </ul>	<ul style="list-style-type: none"> <li>Check the main circuit input line for phase failure.</li> <li>Enable <i>F508</i> (input phase failure detection)</li> <li>Check the capacitor in the main circuit for exhaustion.</li> </ul>
* <i>EPH0</i>	0009	Output phase failure	<ul style="list-style-type: none"> <li>A phase failure occurred in the output line of the main circuit.</li> </ul>	<ul style="list-style-type: none"> <li>Check the main circuit output line, motor, etc. for phase failure.</li> <li>Enable <i>F505</i> (Output phase failure detection).</li> </ul>

\* You can select a trip ON/OFF by parameters.

(Continued overleaf)

(Continued)

Error code	Failure code	Problem	Possible causes	Remedies
$OP1$	000A	Overvoltage during acceleration	<ul style="list-style-type: none"> <li>The input voltage fluctuates abnormally.</li> <li>(1) The power supply has a capacity of 200kVA or more.</li> <li>(2) A power factor improvement capacitor is opened or closed.</li> <li>(3) A system using a thyristor is connected to the same power distribution line.</li> <li>A restart signal is input to the rotating motor after a momentary stop, etc.</li> </ul>	<ul style="list-style-type: none"> <li>Insert a suitable input reactor.</li> <li>Use <math>F301</math> (auto-restart) and <math>F302</math> (ride-through control).</li> </ul>
$OP2$	000B	Overvoltage during deceleration	<ul style="list-style-type: none"> <li>The deceleration time <math>dEC</math> is too short. (Regenerative energy is too large.)</li> <li><math>F304</math> (dynamic braking resistor) is off.</li> <li><math>F305</math> (overvoltage limit operation) is off.</li> <li>The input voltage fluctuates abnormally.</li> <li>(1) The power supply has a capacity of 200kVA or more.</li> <li>(2) A power factor improvement capacitor is opened and closed.</li> <li>(3) A system using a thyristor is connected to the same power distribution line.</li> </ul>	<ul style="list-style-type: none"> <li>Increase the deceleration time <math>dEC</math>.</li> <li>Install a dynamic braking resistor.</li> <li>Enable <math>F304</math> (dynamic braking resistor).</li> <li>Enable <math>F305</math> (overvoltage limit operation).</li> <li>Insert a suitable input reactor.</li> </ul>
$OP3$	000C	Overvoltage during constant-speed operation	<ul style="list-style-type: none"> <li>The input voltage fluctuates abnormally.</li> <li>(1) The power supply has a capacity of 200kVA or more.</li> <li>(2) A power factor improvement capacitor is opened or closed.</li> <li>(3) A system using a thyristor is connected to the same power distribution line.</li> <li>The motor is in a regenerative state because the load causes the motor to run at a frequency higher than the inverter output frequency.</li> </ul>	<ul style="list-style-type: none"> <li>Insert a suitable input reactor.</li> <li>Install a dynamic braking resistor.</li> </ul>
$OL1$	000D	Inverter overload	<ul style="list-style-type: none"> <li>The acceleration time <math>ACC</math> is too short.</li> <li>The DC braking amount is too large.</li> <li>The V/F setting is improper.</li> <li>A restart signal is input to the rotating motor after a momentary stop, etc.</li> <li>The load is too large.</li> </ul>	<ul style="list-style-type: none"> <li>Increase the acceleration time <math>ACC</math>.</li> <li>Reduce the DC braking amount <math>F251</math> and the DC braking time <math>F252</math>.</li> <li>Check the V/F parameter setting.</li> <li>Use <math>F301</math> (auto-restart) and <math>F302</math> (ride-through control).</li> <li>Use an inverter with a larger rating.</li> </ul>
$OL2$	000E	Motor overload	<ul style="list-style-type: none"> <li>The V/F setting is improper.</li> <li>The motor is locked up.</li> <li>Low-speed operation is performed continuously.</li> <li>An excessive load is applied to the motor during operation.</li> </ul>	<ul style="list-style-type: none"> <li>Check the V/F parameter setting.</li> <li>Check the load (operated machine).</li> <li>Adjust <math>OL1</math> to the overload that the motor can withstand during operation in a low speed range.</li> </ul>
$OLr$	000F	Dynamic braking resistor overload trip	<ul style="list-style-type: none"> <li>The deceleration time is too short.</li> <li>Dynamic braking is too large.</li> </ul>	<ul style="list-style-type: none"> <li>Increase the deceleration time <math>dEC</math>.</li> <li>Increase the capacity of dynamic braking resistor (wattage) and adjust PBR capacity parameter <math>F308</math>.</li> </ul>
* $OLt$	0020	Over-torque trip	<ul style="list-style-type: none"> <li>Over-torque reaches to a detection level during operation.</li> </ul>	<ul style="list-style-type: none"> <li>Enable <math>F515</math> (over-torque trip selection).</li> <li>Check system error.</li> </ul>
$OH$	0010	Overheat	<ul style="list-style-type: none"> <li>The cooling fan does not rotate.</li> <li>The ambient temperature is too high.</li> <li>The vent is blocked up.</li> <li>A heat generating device is installed close to the inverter.</li> <li>The thermistor in the unit is broken.</li> </ul>	<ul style="list-style-type: none"> <li>Restart the operation by resetting the inverter after it has cooled down enough.</li> <li>The fan requires replacement if it does not rotate during operation.</li> <li>Secure sufficient space around the inverter.</li> <li>Do not place any heat generating device near the inverter.</li> <li>Make a service call.</li> </ul>

\* You can select a trip ON/OFF by parameters.  
(Continued overleaf)

(Continued)

Error code	Failure code	Problem	Possible causes	Remedies
<i>PH2</i>	002E	External thermal trip	<ul style="list-style-type: none"> <li>An external thermal trip is input.</li> </ul>	<ul style="list-style-type: none"> <li>Check the external thermal input.</li> </ul>
<i>E</i>	0011	Emergency stop	<ul style="list-style-type: none"> <li>During automatic operation or remote operation, a stop command is entered from the operation panel or a remote input device.</li> </ul>	<ul style="list-style-type: none"> <li>Reset the inverter.</li> </ul>
<i>EEP1</i>	0012	EEPROM fault 1	<ul style="list-style-type: none"> <li>A data writing error occurs.</li> </ul>	<ul style="list-style-type: none"> <li>Turn off the inverter, then turn it again. If it does not recover from the error, make a service call.</li> </ul>
<i>EEP2</i>	0013	EEPROM fault 2	<ul style="list-style-type: none"> <li>Power supply is cut off during <i>tYP</i> operation and data writing is aborted.</li> </ul>	<ul style="list-style-type: none"> <li>Turn the power off temporarily and turn it back on, and then try <i>tYP</i> operation again.</li> </ul>
<i>EEP3</i>	0014	EEPROM fault 3	<ul style="list-style-type: none"> <li>A data reading error occurred.</li> </ul>	<ul style="list-style-type: none"> <li>Turn off the inverter, then turn it again. If it does not recover from the error, make a service call.</li> </ul>
<i>Err2</i>	0015	Main unit RAM fault	<ul style="list-style-type: none"> <li>The control RAM is defective.</li> </ul>	<ul style="list-style-type: none"> <li>Make a service call.</li> </ul>
<i>Err3</i>	0016	Main unit ROM fault	<ul style="list-style-type: none"> <li>The control ROM is defective.</li> </ul>	<ul style="list-style-type: none"> <li>Make a service call.</li> </ul>
<i>Err4</i>	0017	CPU fault 1	<ul style="list-style-type: none"> <li>The control CPU is defective.</li> </ul>	<ul style="list-style-type: none"> <li>Make a service call.</li> </ul>
<i>Err5</i>	0018	Remote control error	<ul style="list-style-type: none"> <li>An error arises during remote operation.</li> </ul>	<ul style="list-style-type: none"> <li>Check the remote control device, cables, etc.</li> </ul>
<i>Err7</i>	001A	Current detector fault	<ul style="list-style-type: none"> <li>The current detector is defective.</li> </ul>	<ul style="list-style-type: none"> <li>Make a service call.</li> </ul>
<i>Err8</i>	001B	Optional circuit board format error	<ul style="list-style-type: none"> <li>An optional circuit board in a different format is installed.</li> </ul>	<ul style="list-style-type: none"> <li>Check again to be sure that the circuit board is connected correctly, and then reset the power supply.</li> <li>Replace the circuit board with a correctly formatted one.</li> </ul>
* <i>UC</i>	001D	Low-current operation Trip	<ul style="list-style-type: none"> <li>The output current decreased to a low-current detection level during operation.</li> </ul>	<ul style="list-style-type: none"> <li>Enable <i>F510</i> (low-current detection).</li> <li>Check the suitable detection level for the system (<i>F511</i>, <i>F512</i>).</li> <li>Make a service call if the setting is correct.</li> </ul>
* <i>UP1</i>	001E	Undervoltage trip (main circuit)	<ul style="list-style-type: none"> <li>The input voltage (in the main circuit) is too low.</li> </ul>	<ul style="list-style-type: none"> <li>Check the input voltage.</li> <li>Enable <i>F527</i> (undervoltage trip selection).</li> <li>To cope with a momentary stop due to undervoltage, enable <i>F302</i> (ride-through control) and <i>F301</i> (auto-restart).</li> </ul>
<i>EF2</i>	0022	Ground fault trip	<ul style="list-style-type: none"> <li>A ground fault occurs in the output cable or the motor.</li> </ul>	<ul style="list-style-type: none"> <li>Check the cable and the motor for ground faults.</li> </ul>
<i>Et n1</i>	0054	Auto-tuning error	<ul style="list-style-type: none"> <li>Check the motor parameter <i>F401</i> to <i>F494</i>.</li> <li>The motor with the capacity of 2 classes or less than the inverter is used.</li> <li>The output cable is too thin.</li> <li>The motor is rotating.</li> <li>The inverter is used for loads other than those of three-phase induction motors.</li> </ul>	<ul style="list-style-type: none"> <li>Make a service call.</li> </ul>
<i>EtYP</i>	0029	Inverter type error	<ul style="list-style-type: none"> <li>Circuit board is changed. (Or main circuit/drive circuit board)</li> </ul>	<ul style="list-style-type: none"> <li>Make a service call.</li> </ul>
* <i>E-18</i>	0032	Brea in analog signal cable	<ul style="list-style-type: none"> <li>The signal input via VIA is below the analog signal detecto level set with <i>F533</i>.</li> </ul>	<ul style="list-style-type: none"> <li>Check the cables for breaks. And check the setting of input signal or setting value of <i>F533</i>.</li> </ul>
<i>E-19</i>	0033	CPU communications error	<ul style="list-style-type: none"> <li>A communications error occurs between control CPUs.</li> </ul>	<ul style="list-style-type: none"> <li>Make a service call.</li> </ul>
<i>E-20</i>	0034	Excessive torque boosted	<ul style="list-style-type: none"> <li>The torque boost parameter <i>F402</i> is set too high.</li> <li>The motor has too small impedance.</li> </ul>	<ul style="list-style-type: none"> <li>Decrease the setting of the torque boost parameter <i>F402</i>.</li> </ul>
<i>E-21</i>	0035	CPU fault 2	<ul style="list-style-type: none"> <li>The control CPU is defective.</li> </ul>	<ul style="list-style-type: none"> <li>Make a service call.</li> </ul>
<i>SOUE</i>	002F	Step-out (For PM motor only)	<ul style="list-style-type: none"> <li>The motor shaft is locked.</li> <li>One output phase is open.</li> <li>An impact load is applied.</li> </ul>	<ul style="list-style-type: none"> <li>Unlock the motor shaft.</li> <li>Check the interconnect cables between the inverter and the motor.</li> </ul>

\* You can select a trip ON/OFF by parameters.

[Alarm information] Each message in the table is displayed to give a warning but does not cause the inverter to trip.

Error code	Problem	Possible causes	Remedies
<i>OFF</i>	ST terminal OFF	• The ST-CC circuit is opened.	• Close the ST-CC circuit.
<i>UVFF</i>	Undervoltage in main circuit	• The supply voltage between R, S and T is under voltage.	• Measure the main circuit supply voltage. If the voltage is at a normal level, the inverter requires repairing.
<i>rtry</i>	Retry in process	• The inverter is in the process of retry. • A momentary stop occurred.	• The inverter is normal if it restarts after several tens of seconds. The inverter restarts automatically. Be careful of the machine because it may suddenly restart.
<i>Err 1</i>	Frequency point setting error alarm	• The frequency setting signals at points 1 and 2 are set too close to each other.	• Set the frequency setting signals at points 1 and 2 apart from each other.
<i>CLR</i>	Clear command acceptable	• This message is displayed when pressing the STOP key while an error code is displayed.	• Press the STOP key again to clear the trip.
<i>EOFF</i>	Emergency stop command acceptable	• The operation panel is used to stop the operation in automatic control or remote control mode.	• Press the STOP key for an emergency stop. To cancel the emergency stop, press any other key.
<i>Hll</i> <i>L0</i>	Setting error alarm / An error code and data are displayed alternately twice each.	• An error is found in a setting when data is reading or writing.	• Check whether the setting is made correctly.
<i>HEAd</i> <i>End</i>	Display of first/last data items	• The first and last data item in the <i>RUH</i> data group is displayed.	• Press MODE key to exit the data group.
<i>db</i>	DC braking	• DC braking in process	• The message goes off in several tens of seconds if no problem occurs. (Note)
<i>dbon</i>	Shaft fixing control	• Motor shaft fixing control is in process.	• Normal if the message disappears when a stop command is entered (or the operation command is canceled).
<i>E1</i> <i>E2</i> <i>E3</i>	Flowing out of excess number of digits	• The number of digits such as frequencies is more than 4. (The upper digits have a priority.)	• Lower the frequency free unit magnification <i>F702</i> .
<i>STOP</i>	Momentary power failure slowdown stop prohibition function activated.	• The slowdown stop prohibition function set with <i>F302</i> (momentary power failure ride-through operation) is activated.	• To restart operation, reset the inverter or input an operation signal again.
<i>LEP</i>	Auto-stop because of continuous operation at the lower-limit frequency	• The automatic stop function selected with <i>F255</i> was activated.	• To deactivate the automatic stop function, increase the frequency command above the lower-limit frequency (LL) + 0.2 Hz or turn off the operation command.
<i>inlt</i>	Parameters in the process of initialization	• Parameters are being initialized to default values.	• Normal if the message disappears after a while (several seconds to several tens of seconds).
<i>E-17</i>	Operation panel key fault	• The RUN or STOP key is held down for more than 20 seconds. • The RUN or STOP key is faulty.	• Check the operation panel.
<i>Ren 1</i>	Auto-tuning	• Auto-tuning in process	• Normal if the message disappears after a few seconds.

Note) When the ON/OFF function is selected for DC braking (DB), using the input terminal selection parameter, you can judge the inverter to be normal if "db" disappears when opening the circuit between the terminal and CC.

[Prealarm display]

<i>OC</i>	Overcurrent alarm	Same as <i>OC</i> (overcurrent)
<i>OP</i>	Overvoltage alarm	Same as <i>OP</i> (overvoltage)
<i>OL</i>	Overload alarm	Same as <i>OL 1</i> and <i>OL 2</i> (overload)
<i>OH</i>	Overheat alarm	Same as <i>OH</i> (overheat)



# TOSHIBA

## **TOSHIBA CORPORATION** INDUSTRIAL AND POWER SYSTEMS & SERVICES COMPANY

OVERSEAS SALES & MARKETING DEPT.  
ELECTRICAL APPARATUS & MEASUREMENT DIV.

1-1, Shibaura 1-chome, Minato-Ku,  
Tokyo 105-8001, Japan  
TEL: +81-(0)3-3457-4911  
FAX: +81-(0)3-5444-9268

## **TOSHIBA INTERNATIONAL CORPORATION**

13131 West Little York Rd., Houston,  
TX 77041, U.S.A  
TEL: +1-713-466-0277  
FAX: +1-713-896-5226

## **TOSHIBA ASIA PACIFIC PTE., LTD**

152 Beach Rd., #16-00 Gateway East,  
Singapore 189721  
TEL: +65-6297-0900  
FAX: +65-6297-5510

## **TOSHIBA CHINA CO., LTD**

23rd Floor, HSBC Tower, 101 Yin Cheng  
East Road, Pudong New Area, Shanghai  
200120, The People's Republic of China  
TEL: +86-(0)21-6841-5666  
FAX: +86-(0)21-6841-1161

## **TOSHIBA INTERNATIONAL CORPORATION PTY., LTD**

2 Morton Street Parramatta, NSW2150, Australia  
TEL: +61-(0)2-9768-6600  
FAX: +61-(0)2-9890-7542

## **TOSHIBA INFORMATION, INDUSTRIAL AND POWER SYSTEMS TAIWAN CORP.**

6F, No66, Sec1 Shin Sheng N.RD, Taipei, Taiwan  
TEL: +886-(0)2-2581-3639  
FAX: +886-(0)2-2581-3631

● For further information, please contact your nearest Toshiba Liaison Representative or International Operations - Producer Goods.

● The data given in this manual are subject to change without notice.

## Free Manuals Download Website

<http://myh66.com>

<http://usermanuals.us>

<http://www.somanuals.com>

<http://www.4manuals.cc>

<http://www.manual-lib.com>

<http://www.404manual.com>

<http://www.luxmanual.com>

<http://aubethermostatmanual.com>

Golf course search by state

<http://golfingnear.com>

Email search by domain

<http://emailbydomain.com>

Auto manuals search

<http://auto.somanuals.com>

TV manuals search

<http://tv.somanuals.com>