

SALES GUIDE

e-STUDIO232/282



Chapter	Page	
Introduction.....	2	1
Quick Overview.....	4	2
Optional Configuration.....	6	3
Predecessor Comparison.....	8	4
Features & Benefits.....	10	5
Purchase Motivations.....	28	6
Competitor Comparisons.....	38	7
Specifications.....	42	8

1 INTRODUCTION



Many firms and industries are aware of the importance of selecting efficient and secure solutions for sharing and managing information to maximise the value of their business.

Achieving these and similar goals were contributing factors for implementing Toshiba's e-BRIDGE technology into our line of multifunctional systems, and the driving force behind the development of the 2nd Generation technology.

As a pioneer and technological innovator, Toshiba has developed new competitive MFP solutions that lead the way in high-quality document management and work flow performance.

New sales opportunities lie in the growth of networked office environments and the demand for digital multifunctionality. There is also an increased demand for higher performance.

Notable, the majority of our customers within the low to mid-range markets have followed this trend and demand greater versatility, flexibility, and durability as well as the latest in connectivity, security, customisation, and lower maintenance costs, especially cost-per-copy.

Following the success of its predecessors, Toshiba proudly presents the new modular mid-range e-STUDIO232/282. This well-renowned line of models now offers refreshing strengths and competitive performance from the 2nd generation e-BRIDGE technology, and introduces similar or improved capabilities to those seen in higher segment models.

The result is a solution that rivals and counters our closest competitors by setting new standards in functional integration and flexible architecture, noise reduction, and lowering running cost. In addition, we have also introduced other technologies that offer more satisfaction through strengthened solutions and performance benefits, increased security measures, and user-friendliness.



USER SEGMENTS

The e-STUDIO232/282 therefore appeals to small offices with few employees as well as medium- to large-sized departmental office environments. Users will value the ease of use, flexibility and time saving benefits these advanced features will offer and the harmonious design will easily fit into almost any environment. In addition, the system provides a strong blend of extensive network-ready functionality with the necessary security features for safe sharing and storage of digital documents.

The responsible sales professionals should focus on the following factors and user advantages when approaching a potential client for the e-STUDIO232/282:

Analogue Machine Users

Existing analogue users can gain tremendous productivity advantages by switching to a digital copier, especially because of the added memory copying, scanning and electronic sorting. For instance, these digital features allow for immediate retrieval of the originals whilst the job is being completed. This not only means a saving in time and an improvement in productivity, but also a reduction in power consumption. It is also important to point out that the integrated multifunctionality of the e-STUDIO232/282 will play a vital role for analogue users seeking a flexible and durable system by offering higher usability and network connectivity.

Digital Machine Users

Existing digital users are aware of the cost benefit of digital MFP systems, but often the wish to take advantage of more convenient functions means acquiring expensive parts and controllers. Here it is important to emphasise that the e-STUDIO232/282 can expand and be integrated under various business environments by taking advantage of the copy-printer-scan-network capabilities.

First / Additional Purchasers

The majority of these customers are mainly found within big company departments, but also smaller environments such as home offices (SOHOs), start up companies and aspiring entrepreneurs that all stand to benefit from our all-in-one office solutions. Again, it is essential to point out that integration and management in the clients network is abreeze for one or many e-studio devices supplementing a centralised machine and reducing "bottlenecks" with a more flexible solution. As a result, many of the running-costs and Total-Cost-of-Ownership (TCO) related to productivity and daily operations can be reduced or even eliminated. The ability to adapt with changing business environments via the integrated network solutions are qualities that should be explained to your customer.

After reading this sales guide, the professional sales person will understand the strong merits of the e-STUDIO232/282 and how they relate to and are of benefit to the above mentioned user segments.

- 1
- 2
- 3
- 4
- 5
- 6
- 7
- 8

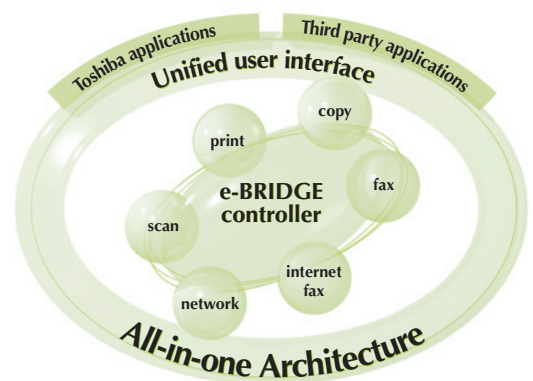

2 QUICK OVERVIEW

The e-STUDIO232/282 builds upon the success of its predecessor with even more office productivity and data security, and continues to incorporate the same clear and sharp image reproduction quality made possible through the refined toner design and high-level imaging technology.



Demands that previously extended to high-end digital functionality and greater paper handling capabilities are now widely accessible through various standard network configurations. As a result, users gain access at all time to a fully Network MFP System — both as an efficient multifunctional solution or a stand-alone machine. For instance, exchanging electronic documents and managing various data are now carried out more easily and more securely than ever before with strong and reliable access management through individual User Authentication. Also the optional Data Overwrite Kit will securely and permanently erase unwanted data, leaving no retrievable trace behind. In addition, installing the optional Scrambler Board will offer even higher levels of security with its industrial strength encryption of any data remaining on the hard drive after copying, printing, scanning or faxing is completed. Utilising all security solutions will provide the highest industry level safeguards for protecting sensitive or classified information.

The new 2nd generation e-BRIDGE architecture provides enhanced integration of individual features and options, allowing for faster response, stress-free operation, and consistent and speedy quality copy/print/scan output. New technologies and methods

have also been adopted for better workflow control whilst keeping overall running costs at a minimum.

Additionally, the modular system architecture ensures a faster response to individual business situations with a wide array of efficient and competitive paper handling features with a maximum capacity of 3,700 sheets using all available paper sources, including standard as well as optional.

Similar to the optional configuration of their predecessors, the e-STUDIO232/282 can be readily customised for your clients needs. This creates new value and satisfaction by adding optional trays, a hole punch unit and two essential finishers that combined bring document production to a whole new level.

Adding the new low noise optional RADF unit provides the benefit of fast and accurate paper feeding of multi-page or double-sided originals and, amongst other things, assist users with productive duplex printing. Everything is at hand for creating professional in-house documentation.



STRONGER FUNCTIONAL INTEGRATION & PERFORMANCE

The e-STUDIO232/282 ranks at the top of its class by incorporating both basic and advanced features to help users' expand their business scope and overall performance.

The expandable architecture enables users to match their current and future business requirements through the many flexible options. The following lists the key improvements and highlights the five main features that make up the core capabilities of the e-STUDIO232/282:

Basic Features

- Copy/Print Speed: 23/28 cpm/ppm
- Warm-up Time: 25 sec.
- CPU: PowerPC 750Cxr 333MHz
- Memory: 32 MB (Page Memory) / 256 MB (Main Memory)
- HDD: 40 GB+
- Paper Capacity: 1,200 sheets (Std.) / 3,700 sheets (Max.)
- Network Interface: 10BASE-T/100BASE-TX (Std.), USB (Full-Speed) (Std.)

Copier Features

- First Copy Time: 5.4 sec.
- Scan Speed for Copy: 45 spm
- Maximum Pages: 1,000 pages (per job or total)
- Job Reservation: 10 jobs
- Special Functions: Job Build, Proof Copy

Printer Features

- Resolution: 2400 x 600 dpi (with smoothing)
- PDL: PCL6® Compatibility, PostScript®3™ Compatibility
- Protocol: TCP/IP, LPR/LDR, IPP, EtherTalk, IPX/SPX
- Special Functions: Proof Print, Private Print, Tab Print

Scanner Features

- Scan Speed: 50 spm (400 dpi) / 45 spm (600 dpi)
- File Format: TIFF, PDF
- Resolution: 150, 200, 300, 400, 600 dpi

Security Features

- Data Overwrite Kit
- Scrambler Board
- LDAP Authentication
- Active Directory
- Role Based Access
- User Authentication (10,000 users)
- Private Print (Printer Function)

1

2

3

4

5

6

7

8

3 OPTIONAL CONFIGURATION

The e-STUDIO232/282 comes with several enhancements such as standard multifunctional solutions that ensures a quick response to any business situation. Unlocking the full potential of the network ready MFP system is easily done via the expandable architecture with its integrated e-BRIDGE technology. This thereby enables users to match their current and future business requirements through its flexible options.

1

2

3

4

5

6

7

8

Powerful Paper Handling Option

Job Separator
MJ-5004



Offset Tray
MJ-5005

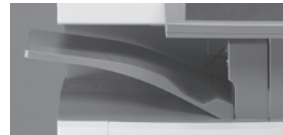

Reversing Auto Document Feeder
MR-3020

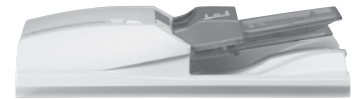

Standard

Inner
Tray

Hanging type Finisher
MJ-1022



Saddle-stitch Finisher
MJ-1025



Bridge kit
KN-3520



Hole Punch Unit
MJ-6005



Platen cover
KA-3511PC

Work Tray
KK-3511



All-in-One,
e-BRIDGE
CONTROLLER

Auto Duplexing Unit

Stack Feed Bypass

Network Interface

2 Drawers

Paper Feed Pedestal
KD-1011



Drawer Module
MY-1021



Large Capacity Feeder
KD-1012



Network Printer/Scanner Option

Printer Kit
GM-1070



Printer/Scanner Kit
GM-2070



Scanner Kit
GM-4070



Wireless Option

Wireless LAN Module
GN-1041

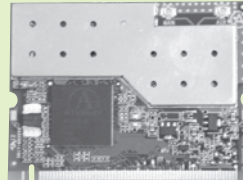

Antenna
GN-3010



Security Option

Scrambler Board
GP-1040

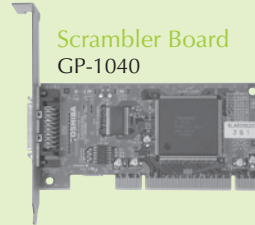

Date Overwrite Kit
GP-1060



Fax Option

Fax Board
GD-1150

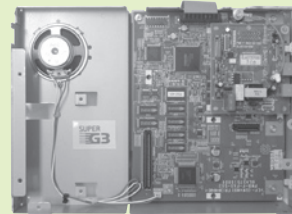

Fax 2nd Line Board
GD-1160

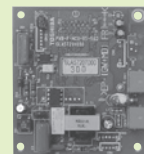

Other Option

PCI Slot
GO-1060
(Required for Scrambler Board)

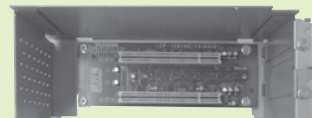

1
2
3
4
5
6
7
8

The new network ready mid-range e-STUDIO232/282 provides all the advantages of a truly compact digital copier and satisfies the versatility and flexibility of a multifunctional system with outstanding quality and speed. Each model comes bundled with a strong blend of enhancements and customisable solutions, that extend beyond the success of the e-STUDIO230/280. As a result, both general users and those with higher requirements will be ensured the highest productivity at all times. What's more, users have access to high quality and optional solutions that help eliminate many of the running-costs related to productivity and daily operations.

Most important, compared with their predecessors, the e-STUDIO232/282 offer more multitasking solutions with less complexity with the improved copy-print-scan-network capabilities adopted in the 2nd generation e-BRIDGE technology.

At the same time as incorporating improved support for the latest in network infrastructures, the e-STUDIO232/282 also places a stronger emphasis on high level data security and access restrictions in all aspects of sharing and managing data.

Key improvements are:

- Stronger upgradability; 2nd generation e-BRIDGE architecture
- Improved machine longevity
- Increased paper handling capability, inc. new, low noise RADF unit design
- Advanced Job Build and Job Reservation capabilities
- High speed scanning for copier functions
- Powerful unified template functionality with preset templates
- High level data security; incl. HDD and document management
- Strong network connectivity, high standard compatibility
- Advanced User Management Options

Distinguished differences include:

- Tiltable Control Panel visible from adjustable angles
- Double sized LCD Touch Panel Display
- Responsive QWERTY-type Touch Panel Keyboard



		e-STUDIO232/282	e-STUDIO230/280	e-STUDIO200/250
General Features				
Control Panel	Display	1/2 VGA LCD Touch Panel	1/2 VGA LCD Touch Panel	LCD (4-Line)
	Tilt	Available	Available	Not Available
Template	Keyboard	QWERTY (Soft Keypad)	QWERTY (Soft Keypad)	Ten-key Keypad
	Copy	12,060	12,060	4 (Job Memory)
	Scan	(Shared)	(Shared)	Not Available
	Fax			Not Available
Warm-up Time		25 sec.	25 sec.	70 sec.
Toner Recycle		Available	Available	Not Available
Toner Yield		23.0k	22.0k	7.5k
Department code		1000	1000	99
Paper Handling Features				
Paper Weight	Cassette	64 - 105 g/m ²	64 - 105 g/m ²	64 - 80 g/m ²
	Bypass (Multi-feed)	64 - 209 g/m ²	64 - 209 g/m ²	64 - 80 g/m ²
	Bypass (Single-feed)	50 - 209 g/m ²	50 - 209 g/m ²	64 - 163 g/m ²
RADF	Paper weight (Simplex)	35 - 157g/m ²	50 - 127g/m ²	50 - 127g/m ²
	Paper weight (Duplex)	50 - 157g/m ²	50 - 105g/m ²	50 - 105g/m ²
Paper Handling	ADU	Standard	Standard	Option
	2nd Drawer	Standard	Standard	Option
	Bypass	Standard	Standard	Option
Optional Tray	Job Separator	Available	Available	Available
	Offset Tray	Available	Available	Available
	Saddle Stitch Finisher	Available	Available	Not Available
Special Paper	Envelope	Available	Available	Not Available
Security Features				
HDD data security		Scrambler Board (Opt.)	Scrambler Board (Opt.)	-
HDD data overwrite		Data overwrite kit (Opt.)	Data overwrite kit (Opt.)*	-
User authentication		Available (10000)	Not Available	Not Available
Copier Features				
First copy time		5.4 sec.	5.4 sec.	6 sec.
Page Memory		32MB+HDD	32MB+HDD	32MB+128MB (Opt.)
Scanning Speed		45 spm	45 spm	20 spm/25 spm
Custom Mode		Available	Available	Not Available
Job Build		Max. 1000 builds	Max. 1000 builds*	Max. 5 builds
Job Reservation		10 jobs	5 jobs	Not Available
Image Adjustment		Available	Available	Not Available
Mixed original size with different width		Available	Available	Same width only
Dual Agent (e-Filing, file)		Available	Available	Not Available
Printer Features				
GDI Print		Not Available	Not Available	Standard
PDL		PS3, PCL6 (emulation)	PS3, PCL6 (emulation)	PS2, PCL6 (emulation)
Interface	NIC	Standard	Standard	Option
	USB	Standard	Standard	Not Available
	Parallel	Not Available	Option	Standard
Scan Features				
TWAIN Scan		Standard (Copy to Box)	Standard (Copy to Box)	Option
Scan to File (Protocol)		SMB, FTP, IPX/SPX	SMB, FTP	Not Available
Dual Agent (e-Filing, File, e-mail)		Available	Available	Not Available
e-Filing Features				
e-Filing Function		Available	Available	Not Available
Image Source	Copy	Standard	Standard	Not Available
	Print	Option	Option	Not Available
	Scan	Option	Option	Not Available
	Received Fax	Option	Option	Not Available
Fax Features				
Phonebook	Destination type	Phone Number, e-mail address	Phone Number, e-mail address	Phone Number, e-mail address
	Numbers	1000	1000	375
Dual Agent (e-mail, Internet fax, file)		Available	Available	Not Available

* These features became available by version up.

The e-STUDIO232/282 provide all the advantages of a digital copier and satisfy the versatility and flexibility of a multifunctional system with outstanding quality and speed. With our unique network ready MFP design, users will have quick access to a multitude of templates and other simple step-by-step features that delivers maximum value for minimum outlay.

Depending on your individual sales technique and the needs of your prospects, the following presents the main features and their related benefits, which we recommend as a general guideline as well as sales aid during presentations.

PRODUCTIVITY

Assuring the highest productivity for our customers has always been one of the cornerstones of Toshiba's worldwide products. The e-STUDIO232/282 feature the latest in technological insights and front-end solutions that will only increase that reputation.

MULTITASK FEATURES

With today's vast amounts of information, selecting the right multitasking tools is critical in helping you save time, increase overall efficiency, and streamline your workflow. The e-STUDIO232/282 provide just the right blend of multi-functional productivity with their new levels of machine integration and stronger performance. This provides quick access to numerous copy-print-scan-network capabilities that allow concurrent and/or overlapping tasks to be carried out simultaneously or sequentially.

Scan Once/Copy Many

The Scan Once/Copy Many functionality provides a tremendous productivity increase in comparison with analogue copiers thanks to utilising the hard drive capacity and fast scanning speed that also surpasses the printing speed of most analogue copiers. In other words, rather than by continual scanning of the original, multiple copies are made from the stored image in the memory. This not only results in speedier output after scanning, but the copy job can also be saved for later retrieval. Another benefit over analogue copiers is the reduction of noise and excess power consumption resulting from multiple scanning.

Convenient Electronic Sort

Thanks to the high memory capacity, once all originals are scanned and stored in memory the outputs of copies/prints are instantly sorted without the need for mechanical sorters. **Electronic sorting** makes it easy to separate jobs at the point of printing (**alternation**) or allow documents to be copied/printed in proper magazine order (**magazine sort**).



Advanced Job Reservation

The large memory capacity of the e-STUDIO232/282 makes it possible to realise advanced automation and reservation capabilities. Users can Pre-Scan documents while the system is warming up, which automatically initiates the job after the system is ready. This Auto Job Start capability is supplemented by the advanced **Job Reservation** functionality, which also offers time saving solutions by allowing users to Pre-Scan during printing and copying with the possibility to reserve up to ten different jobs, each of which will start automatically as the previous job finishes, saving valuable time.

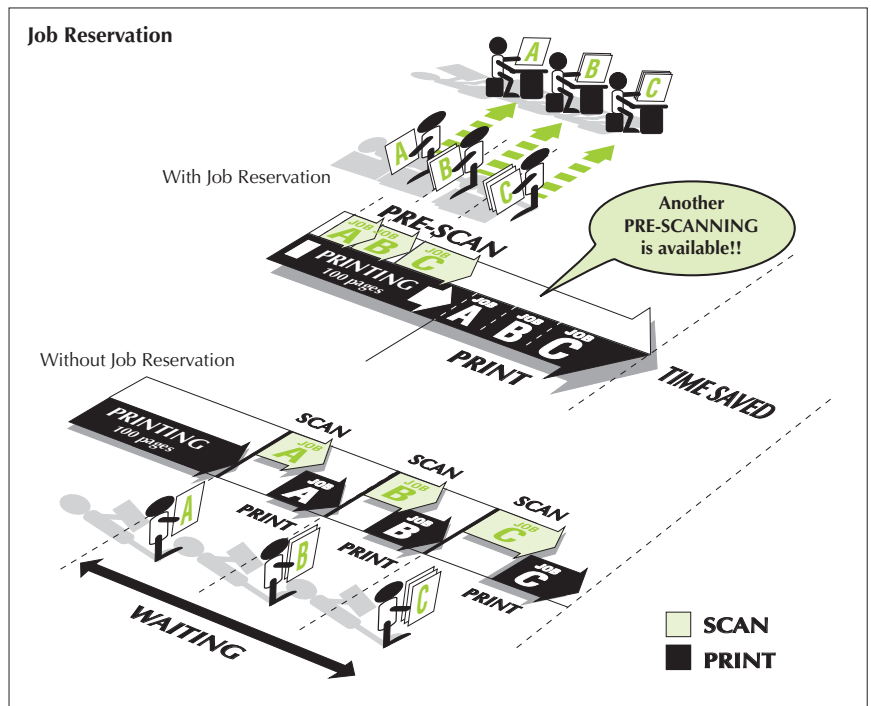

1

2

3

4

5

6

7

8

5 FEATURES & BENEFITS

Job Build

The e-studio232/282 is equipped with the unique Job Build function in copying mode. This feature enables combinations of different jobs, so if your original contains pages that have to be handled differently such as single or double sided, varying enlargements or reductions, various image quality settings to name just a few- these can be combined as a single job. Add electronic sorting with Job Build and you have a dramatic increase in productivity and efficiency.

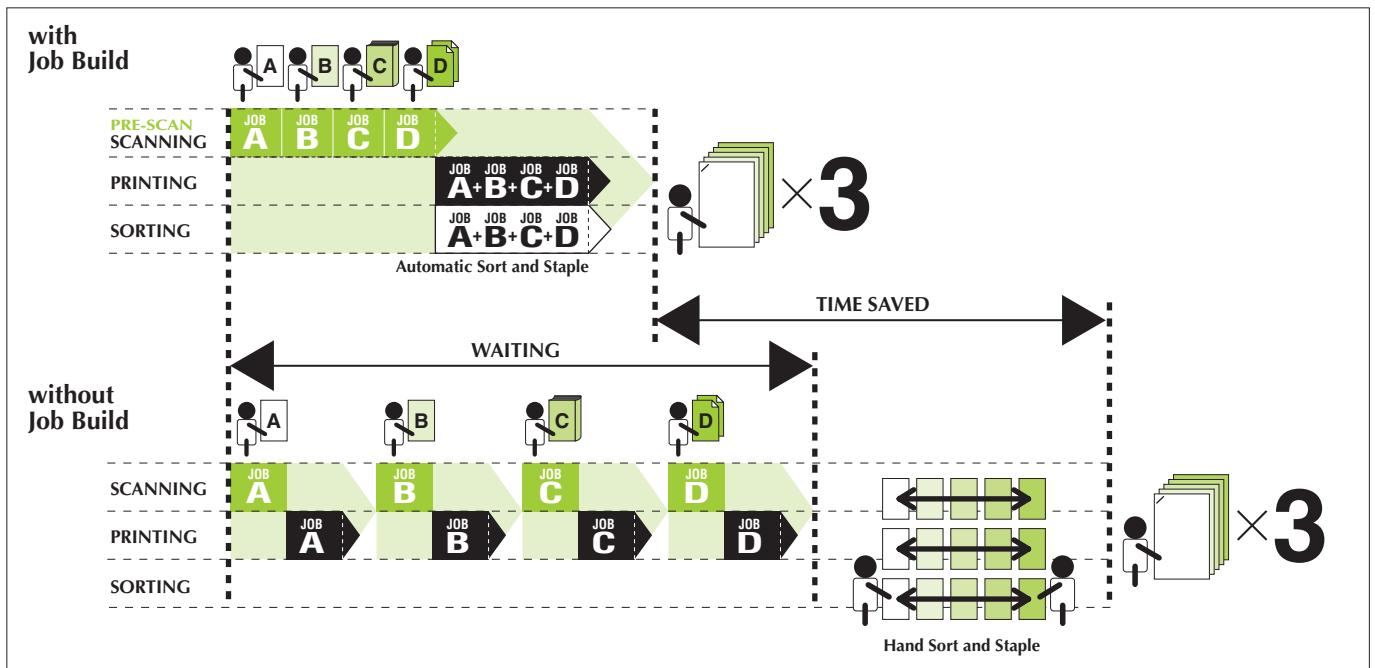

Multitasking Features

The e-STUDIO232/282 provides a range of multi-tasking features such as concurrent processing and dual agent functions that help streamline office workflow and increase overall productivity. Concurrent Processing allows users to process one job while another is still in progress, which reduces downtime, and provides users with the possibility to use both fax and scan while printing, just to mention a few. Dual Agent Processing also saves time by allowing users to combine two agents for simple operation and assign them to a convenient template, making it possible to initiate two jobs simultaneously.



SPEED

The e-STUDIO232/282 are faster and more efficient than previous models, providing users with many customisable, result-oriented and multifunctional features such as high-speed print/scan, concurrent multi-job tasks, and easy operation that will help maximise productivity.

High Performance Processor and High-Speed Memory

The e-STUDIO232/282's 2nd generation e-BRIDGE technology makes a considerable difference in performance, and what's more, they also come equipped with a new processor core and increased memory capacity to increase overall output efficiency. As a result, embedded with the high performance PowerPC 750CXr (333 MHz), designed along RISC microprocessor principles, and high-speed memory (256MB DDR DRAM) for system performance, the new e-BRIDGE Controller provides concurrent processing of copying, printing, scanning without straining the CPU and memory.

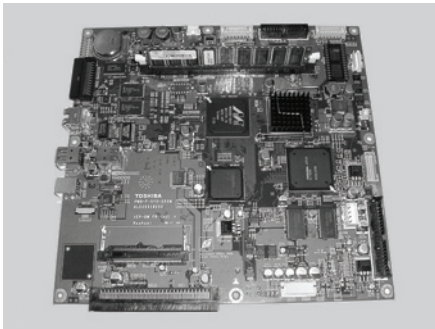

Maximum Speed Performance

The e-STUDIO232/282 combine many improvements that help users achieve maximum performance through quick machine access and speedy output. For instance, each MFP system comes with a remarkable first copy speed of 5.4 seconds as well as a redesigned duplexing mechanism that results in 100% productivity without the usual loss in speed.

Speedy and High-Quality Scanning

Users will find that high-quality scanning is quick and easy when either selecting the fast scanning speed of 50 scans per minute (spm) at an image resolution of 400 dpi (scan mode), or the speedy 45 spm at a higher resolution of 600 dpi (copy/scan mode). With these scanning speeds available, users will have no trouble processing high volume scanning jobs. It also becomes possible to efficiently convert paper documents into electronic format that can be easily managed and shared in an electronic filing system.

1

2

3

4

5

6

7

8

5 FEATURES & BENEFITS

ECONOMY

Keeping track on expenditure and striving towards the highest cost-benefit to a business is a sound practice that is relevant today more than ever. With the release of the e-STUDIO232/282 users now have access to the latest tool-kit for combating waste in resources and time.

COST EFFICIENCY

Many factors influence durability, including quality of product, the frequency of maintenance and the intensity of usage, just to mention a few. For this reason, preventive maintenance can make a world of difference, especially when it comes to improving the life expectancy of your investment. In line with Toshiba Quality concept, we have addressed ways to further improve durability and other related aspects in all our products, and we are certain that with the e-STUDIO232/282 users can truly look forward to maximised uptime and reduction of service costs.

Improved Toner Life (Toner Recycle System)

The e-STUDIO232/282 introduces a new toner recycling system that does away with the need for a waste toner bag and uses 100% of the toner without waste. The space previously taken up by the waste toner bag has been replaced by a new, much larger capacity toner cartridge, in fact it is approx 2.5 times larger. Not only are these initiatives more environmentally friendly but also provide users with the benefit of easy maintenance.

Conventional toner recycling systems suffer from inconsistent image quality due to the deterioration of the toner and the contamination of paper fibres. The e-STUDIO232/282 is equipped with a system that removes paper fibres and a developing system that accurately controls the mix of waste and fresh toner to ensure image quality is maintained from PM to PM.

Efficient and Cost-reducing Paper Savings

Finding new ways to reduce daily paper waste, lowering copy/print volume to a reasonable level and ultimately cutting costs has been of top priority with the e-STUDIO232/282. For example, the Automatic Duplexing Unit (ADU) makes **duplex** printing easy with the potential to cut paper costs in half, and likewise **N-in-1** printing can reduce costs through condensing multiple originals on one or both sides of a single sheet.

Additionally, standard or optional features like **Network Fax** Functionality, **Proof Copy**, and **Proof Print** functions provide users with similar ways for reducing any unnecessary printing costs.

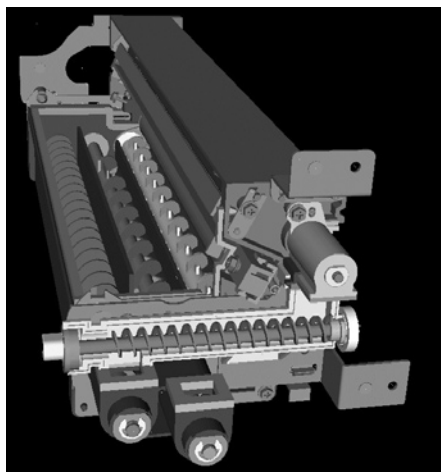



ENVIRONMENT

Toshiba have always valued the importance of using recycled materials whenever possible and to incorporate features to reduce power consumption and noise levels for the benefit of the working environment. Our e-STUDIO232/282 reflect these commitments via careful design and technology, and also by complying with the Energy Star for their energy saving design initiatives. We have further restricted the use of certain hazardous substances as stipulated in the international RoHS Directive. Also, Toshiba has a long tradition of promoting the use of recyclable plastic, lead- and halogen-free materials on Toshiba's printed circuit boards, as well as chromium (VI) free steel plates and screws.

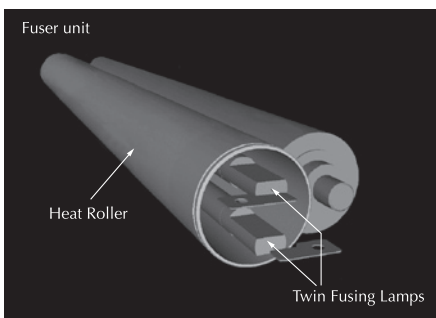

Advanced Fusing System

Toshiba's innovative and well-proven fusing technology has been further enhanced in the e-STUDIO232/282. The Twin Lamp Fusing system consists of separated lamps, concentrated at the centre and edges, where only the necessary area heats up, providing a more efficient utilisation of energy. In addition, the thin heat roller plates – about half the thickness than previously – enables better heat distribution and toner is fused to the paper more evenly as a result. Likewise, better utilisation of the low temperature fusing toner has resulted in significant reductions in temperature compared with the previous model. Together these improvements have reduced warm-up time to just 25 seconds.

Many Energy Saving Modes

Introducing power management techniques into our daily work is all about simplicity, automation and the right of solutions. The e-STUDIO232/282 incorporate these energy saving functions; **Auto Energy Saver**, **Auto Sleep Mode**, and **Weekly Timer** for minimising power consumption and reducing electricity costs.

Low Noise (Quiet)

Studies have shown that noise is the number one disturbance in an open office environment, and Toshiba are constantly finding new ways to reduce noise levels. With the release of the e-STUDIO232/282, we have redesigned the overall paper feeding mechanism and also introduced a new low noise RADF unit, resulting in substantial reductions in noise levels during machine operation.

ISO 14001 Environmental Management Standard

Toshiba maintain high environmental standards in everyday operations, and to date all of our manufacturing facilities have been awarded the ISO 14001 certification in recognition for their high environmental management system standards that minimise the ecological impact of business activities.

1

2

3

4

5

6

7

8

5 FEATURES & BENEFITS

USABILITY

This simple and easy-to-understand user-interface are design fundamentals for enhancing business practices and achieving cost-efficient work procedures. The e-STUDIO232/282 offer just that by building on the success of their predecessors and by adopting the latest knowledge in optimised ergonomics and ergonomometrics.

USER FRIENDLY DESIGN

It all comes down to design and quality when looking to achieve the highest outcome possible. Like all Toshiba MFP products, the design of e-STUDIO232/282 is based on simplicity and ease-of-use that allow users to take advantage of the many features, including:

Compact All-in-One System

The e-STUDIO232/282 are all-in-one digital multifunctional solutions that offer the advantage of copier-printer-scanner-fax-network capabilities all in a powerful single compact design. This saves office space without compromising in functionality or quality.

Easy-to-Use / Easy-to-Access Wide Control Panel

The enhanced Control Panel and Touch Panel Display provide quick access to desired functions. Represented by large visual icons, well organised and spaciouly arranged in a single view, and by using the built-in QWERTY touch keyboard, makes it easy to enter text or symbols. Moreover, the entire Control Panel has been designed to be tilted to more convenient viewing angles under various light conditions and to provide natural and stress-free operation. For example, the universal design makes it very accessible to wheelchair users or people of different heights.





Time Saving Templates

The **template** function is highly useful for defining frequently used settings and speeding up overall workflow, its as simple as clicking a single graphic icon. The many preset templates offer immediate time saving and operational simplicity that can be further enhanced with the Auto Start function.

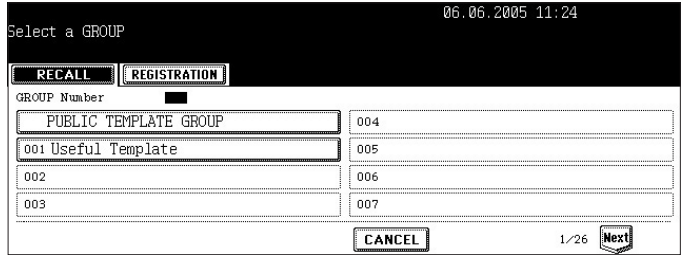
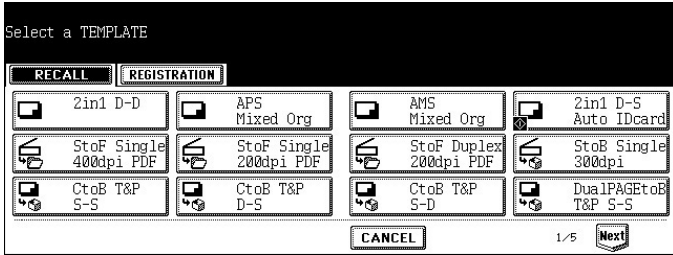

Easy-to-Use Printer Driver

The Printer Driver offers a simple and intuitive layout for sending complex jobs to print in minimal time. A powerful preview window provides real status information and graphically displays how the print job has been set for layout and finishing prior to the final print. This allows for late changes to be made, such as magazine sort, hole punch, or even use previously saved profile settings.

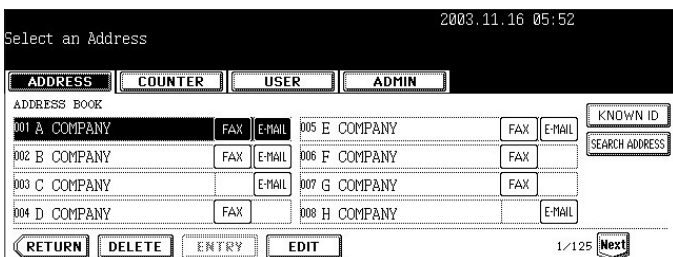
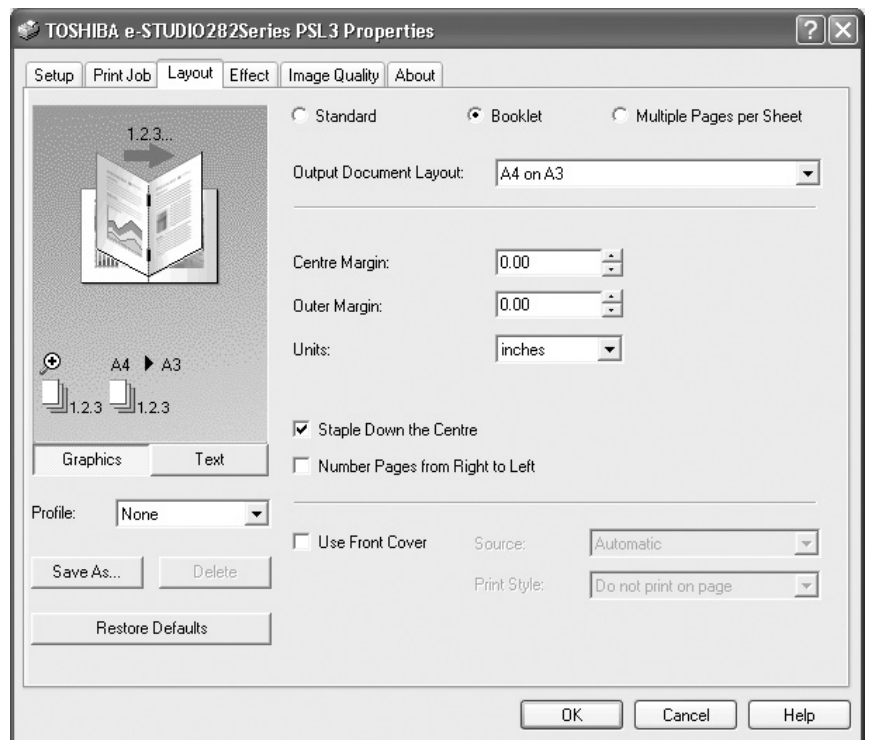

A Single, Easy-to-Use Address Book

Email and fax jobs have all been designed with access to the same **unified address book**, removing the need to create addresses for each individual function. Once the addresses are registered, simultaneous email and fax transmissions to multiple recipients can be carried out with ease.

1
2
3
4
5
6
7
8

5 FEATURES & BENEFITS

HIGH IMAGE QUALITY

Toshiba has taken image quality to new heights, carefully considering the feedback and opinions of our MFP users to bring about further refinement in the e-STUDIO232/282, including:

Higher Image Reproduction Quality

As well as taking advantage of Toshiba's original image processing technology, successful reduction of size of the micrograins in the toner and developer has resulted in higher image reproduction quality levels.

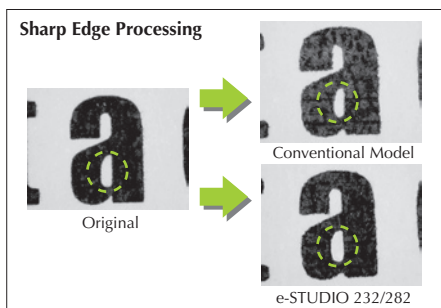

Sharper and Smoother Copied Text and Graphics

Digital copiers are well known for their excellent reproduction of characters and graphics, and thanks to Toshiba's original **Serial Filter** and **Sharp Edge** Processing technology, every printout of the e-STUDIO232/282 provide superb image quality with crystal clear rendition of even handwritten text and signatures written in pencil. Edges are supremely sharp for both copied text and graphics, resulting in heightened quality.

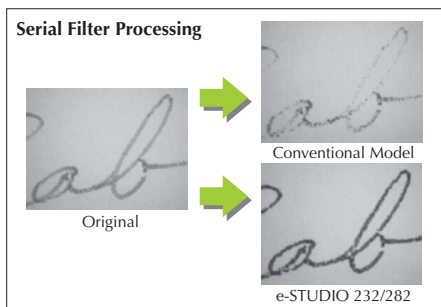

Image Adjustments (Background, Sharpness)

Besides the more common contrast adjustment of copy image quality, users can further improve the output by adjusting both **background** and **sharpness** through a simple operation on the Control Panel.

Original Modes

A broad selection of Original Modes ensures optimum copy image quality regardless of the type of the original. Users can just use the standard exposure setting in the default **Text/Photo** Mode or manually select between **Text**, **Photo** or **Custom** Mode settings, which can be registered according to specific user needs.

Printer Driver

The e-STUDIO232/282 come with an additional mode for improving print quality even further. Through the PCL6[®] driver, users can select Detail mode for text and Smooth mode for pictures. And from the PostScript^{®3}™ driver, users have the option of choosing Auto mode, which automatically determines the mode to use depending on the type of document, assuring the highest print quality at all times.

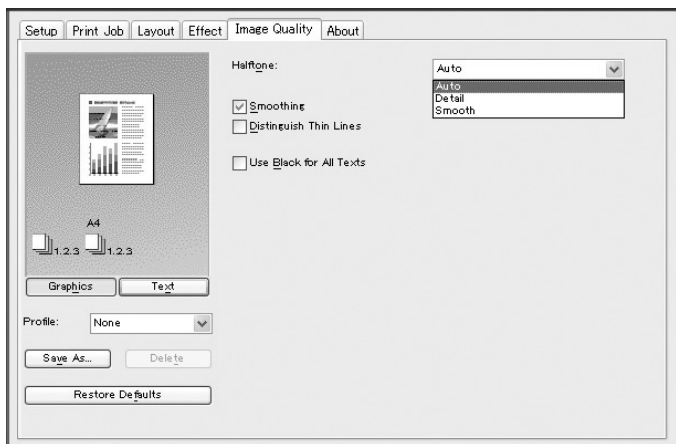



VERSATILITY

In terms of versatility, the e-STUDIO232/282 combine the increased advantages of today's digital technology achievements and multifunctionality, offering numerous network protocols and various paper handling features for today's diverse office requirements.

POWERFUL PAPER HANDLING

Toshiba have always given high priority to developing strong paper handling features in all our MFP products.

The e-STUDIO232/282 can play a vital role in the most demanding document workflow due to their ability to control almost every step in the process, providing document input, transmission, editing, output, storage and even e-Filing capabilities. To some extent, this is accomplished by the versatile integrated e-BRIDGE architecture, and high performance print engine of the e-STUDIO232/282. The following lists some of the powerful paper handling features available:

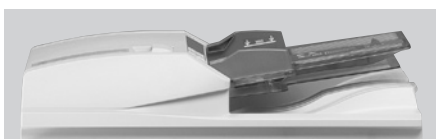

Stackless Automatic Duplexing Unit (ADU)

The standard ADU delivers two-sided copies/prints in minimal time. The structural simplicity results in fewer paper jams and trouble-shooting is also easy and quick. The design also leads to performance that's 100% productive.

Stack Feed Bypass (SFB)

Various paper types like thick paper and OHP sheets are quickly fed through the SFB unit that can easily hold up to 100 sheets at a time, providing users with more copying/printing flexibility.

High Speed Scanning with Optional RADF

The optional RADF (Reversing Automatic Document Feeder) is an essential part of the powerful paper handling features offered with the e-STUDIO232/282. It has been redesigned for quieter operation, lighter weight, smaller dimensions and easier access. Other design improvements are the transparent upper tray which prevents users from leaving originals behind on the output tray, and the more clearly visible paper-size markings which make it easier to feed different sized originals at the same time.

Maximum 3,700-sheet Capacity / Maximum 5-Way Paper Supply

The e-STUDIO232/282 provide an impressive maximum paper capacity of 3,700 sheets. The 2,500-sheet optional Large Capacity Feeder (LCF), plus the standard two drawers, each hold a maximum of 550 sheets. The SFB unit, which can handle up to 100 sheets, meets a wide range of business needs. Thanks to the large paper capacity, there is no need to replenish as often. Furthermore, users can select the number of paper sources to a total of five by adding the optional Paper Feed Pedestal (PFP) and Drawer Module to the standard two drawers and SFB unit. This allows users to load several paper types and sizes simultaneously in a single machine.

1

2

3

4

5

6

7

8

Thick Paper / Envelope Printing

Users can take advantage of a variety of advanced paper handling features that maximises productivity and efficiency when dealing with complex bookbinding and presentation materials. For instance, the e-STUDIO232/282 can easily handle extra thick paper up to 209g/m², and also provides printing on envelopes (COM10, Monarch, DL, You-4, Cho-3), transparencies, or other kinds of special paper.

Optional Finishers

Finishing is an essential part of any paper handling and printing process that produces different types of documents. The e-STUDIO232/282 offer a Job Separator MJ-5004 and an Offset Tray MJ-5005 that ensure high output productivity by separating or offsetting the print/copy output. In addition, the hanging-type Finisher MJ-1022 and a Saddle-stitch Finisher MJ-1025 makes it easy to produce multiple copy/print sets and complex print jobs.

1

2

3

4

5

6

7

8



EXPANDABILITY

The modular architecture of the e-STUDIO232/282 and the many available Expansion Kits ensure a faster response to business situations. Building on the flexible e-BRIDGE technology, it is easy for users to activate options to the already standard copy and network capabilities. In this way, all advanced features can be quickly enabled without the time-consuming installation of expensive system boards. Only the Fax-option remains as a board to be installed in the traditional way. The following mentions how users can easily expand the functionality of their MFP machine:

OPTIONAL FAX/INTERNET FAX FEATURES

The e-STUDIO232/282 comes with large memory capacity and support for JBIG image compression technology, essential for cutting transmission time, of large and complex documents. High-speed Walk-Up Fax capabilities become available with the optional Fax Board installed, and with the additional Printer/Scanner Kit or Scanner Kit installed, users will also have access to Internet Fax and Network Fax capability.

Economical Internet Fax

The **Internet Fax** function replaces conventional fax transmission by exchanging the data via the Internet. This drastically saves communication costs of the conventional phone line and also offers the benefit of sending to multiple recipients simultaneously. Also, **On Ramp/Off Ramp Gateway** functionality is available.

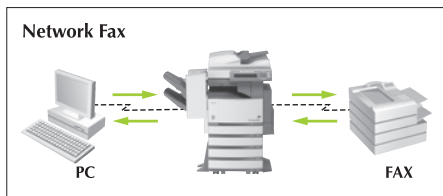
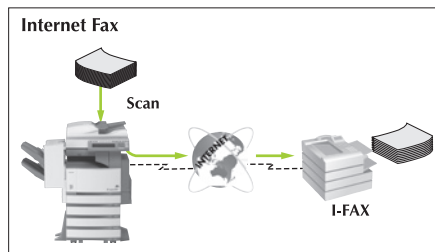
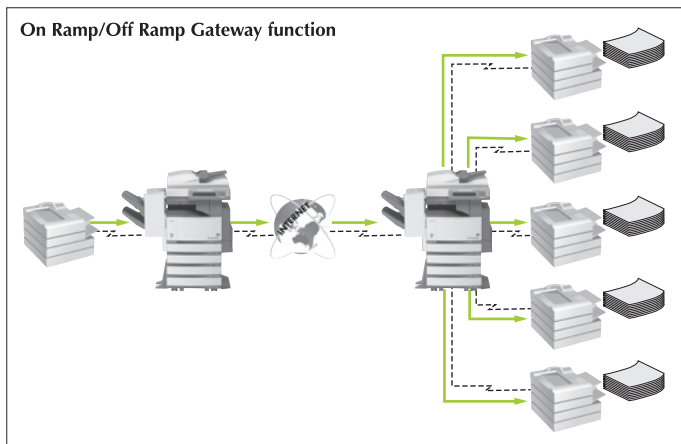

Efficient Network Fax

The **Network Fax** function allows users to send a fax directly from the client PCs without prior printing to specified destinations over the network and/or phone line. You can therefore reduce unnecessary printing costs and manual handling. In addition, incoming fax messages can be automatically stored into the e-Filing box or forwarded directly to their final destinations according to the fax numbers, resulting in a paperless office environment.

Optional Walk-Up Fax (Super G3/G3)

With the optional Fax Board installed, users have access to **Super G3** fax capability that allows for high-speed transfer of fax data almost twice as fast as the normal G3 fax standard. The result is a significant reduction in communication costs, particularly for long distance faxing. Moreover, a 2nd line board can be installed, making it possible to transmit or receive a fax at the same time for increased transmission efficiency.

1

2

3

4

5

6

7

8

5 FEATURES & BENEFITS

INTEGRATED NETWORK SOLUTIONS

The e-STUDIO232/282 are an all-in-one high performance MFP solution with the advantage of unified high-level copy-print-scan-network capabilities, as explained in the previous sections. As a network ready MFP, however, special features and benefits relate exclusively to the strong network functionality and its ability to be upgraded with various optional features. The following will identify some of the major benefits found.

Comprehensive Network Compatibility

In today's networked business environment it is necessary to have office equipment that supports various network protocols and one that is also compliant with future standards, assuring integration in virtually any network structure. As standard e-STUDIO232/282 live up to all these requirements by supporting a vast array of network protocols such as TCP/IP, IXP/SPX, SMB, FTP, IPP, and Windows (PS3™/ PCL6®), Mac, and UNIX printing protocol compatibility.

Optional Expansion Kits

The e-STUDIO232/282's provide even greater performance and security with the new 2nd generation e-BRIDGE architecture and available Expansion Kits. Users can easily upgrade from a stand-alone machine to a secure Network MFP system. Selecting the Data Overwrite Kit will immediately activate the full security potential of each machine. Users can add the combined Printer/Scanner Kit to activate both printing and scanning functions simultaneously. Of course, users who opt to only use the Printer Kit can later easily activate the scanning functions using the Scanner Kit.

Network Print Features

The e-STUDIO232/282 offer sufficient memory and hard drive capacity to handle large volume printing and high-resolution text and graphics. Using a hub, users can take advantage of both existing cable-based networks as well as wireless LAN systems to establish an optional wireless printing solution (IEEE802.11g). Also, in terms of network print efficiency, compatibility with PCL6® and PostScript®3™ printer drivers (emulation) ensures faster printing of complex graphics and improved print quality, truer to the original.

Network Scan Features

High-speed Network Scan capability embedded within the e-BRIDGE architecture makes it easy for any user to scan documents, convert them into electronic form and share them over the network. Using **Scan to File** allows users to store the scanned images on a networked client PC or on the e-STUDIO232/282's own hard drive for later SMB/FTP retrieval. In a similar way, by using the **Scan to e-Filing** (Scan to Box) enables users to store the scanned images in an e-Filing box, on the hard drive of the e-STUDIO232/282, for easy centralised access to scanned images via the TWAIN driver or "File Downloader".

Scan to Email is another convenient feature that allows users to transfer scanned images as email attachments to specific destinations via a mail server. Users can choose to enter the destination email addresses manually, or take advantage of the **unified Address Book**, which makes it easy to choose one or multiple recipients. Not only will it be simple to share, store and access information but it will bring about significant savings in both time and money.

Expansion Kits



Scan to File

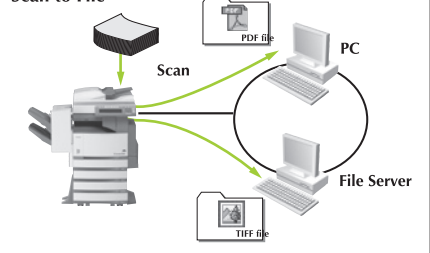

Scan to Email

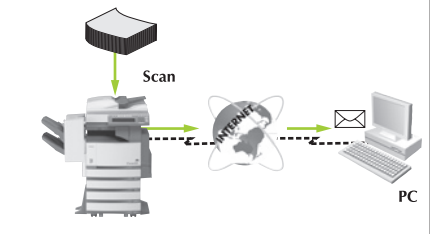

Scan to e-Filing

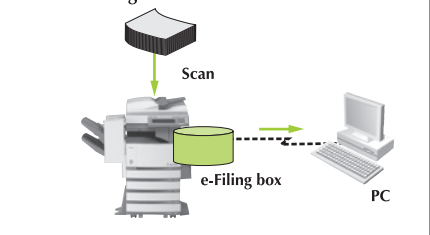



e-Filing Box Functions

The e-BRIDGE architecture supports various **e-Filing** functions without the need for a server. With all options data from copied or scanned pages, received

faxes and prints can be directly stored in the e-STUDIO232/282, and can be later accessed via the control panel for a simple print-on-demand functionality. Furthermore, by using the e-Filing web, specific pages can be easily copied, deleted, replaced, or merged together with other documents.

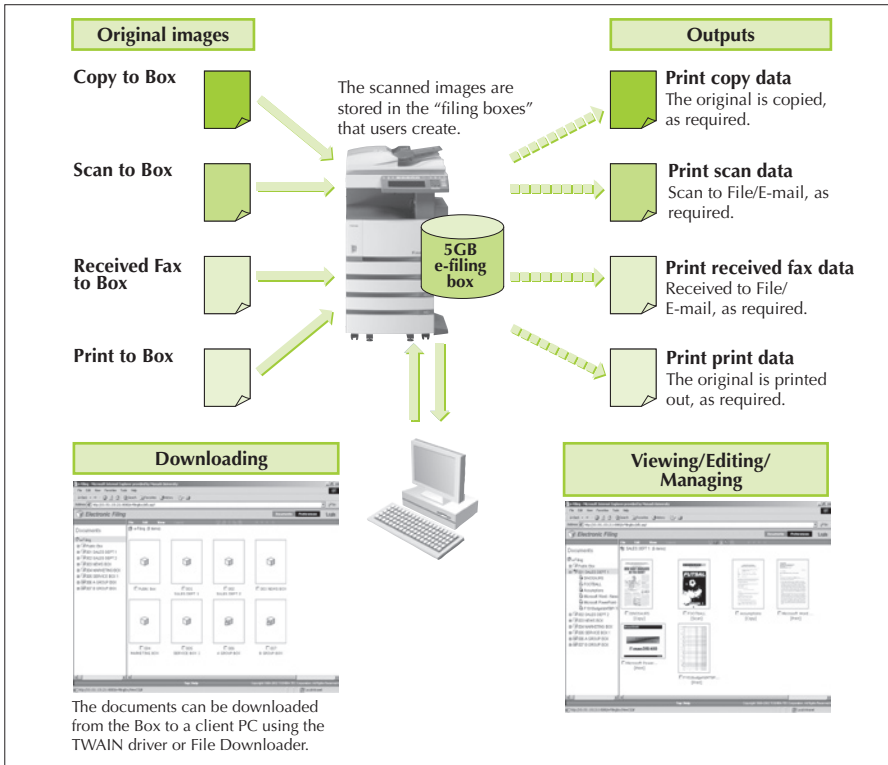

Wireless LAN Compatibility

The e-STUDIO232/282 are full Network MFP systems that have the option to be implemented into a Wireless LAN compatible with the high-speed IEEE802.11g standard. With a top speed of 54 Mbps, it is possible to quickly establish cost-efficient wireless high-speed network environments without the hassle of network cables.

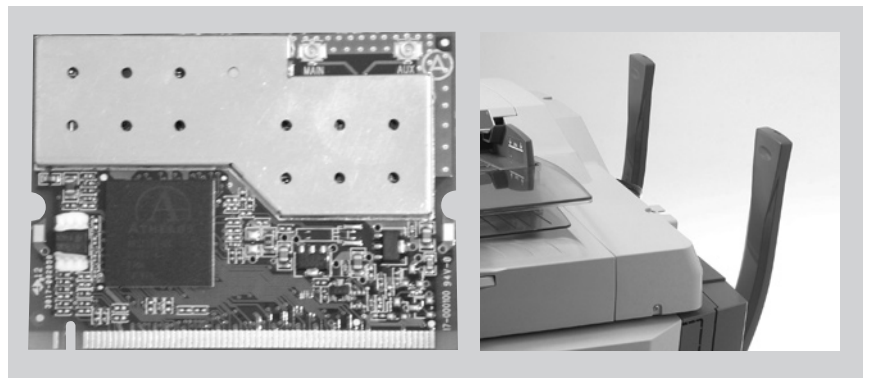

1

2

3

4

5

6

7

8

5 FEATURES & BENEFITS

SPECIAL FEATURES

Several special features enable the e-STUDIO232/282 to better adapt to changes in the office environment and respond quickly to current and future business needs. Furthermore, we have placed a great emphasis on making it easy to expand functionality according to needs, including the ability to add extra security features when sharing information.

SECURITY

As today's workplace has become more integrated into various networks, demands for flexible and simple solutions have increased, and likewise has the need for higher security options. The e-STUDIO232/282 come with an array of solid standard security solutions that can be easily expanded.

Hard Drive Data Security

In a multi-user environment information security is essential, and several solutions are available to extend the level of security of the e-STUDIO232/282. As standard, Toshiba's proprietary compression technology offers high data security and makes it almost impossible to extract information even if the hard drive was removed. Adding the optional **Scrambler Board** offers an even tighter level of security for businesses dealing with sensitive information. All data on the hard drive is encrypted with a 128-bit security, ensuring that all information is stored safely within the e-STUDIO232/282. An extra layer of security can also be achieved by adding the optional **Data Overwrite Kit**, which erases data generated during printing, copying and faxing process using the DoD standard methods, providing high levels of security for sensitive information.

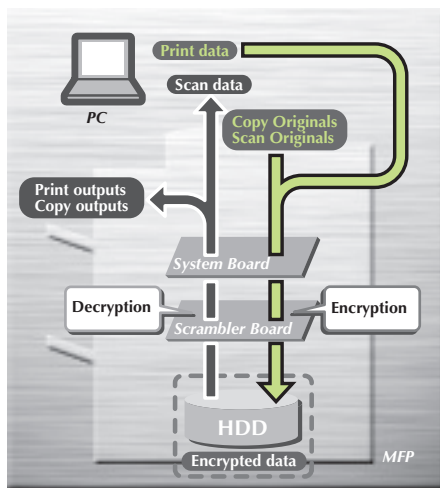
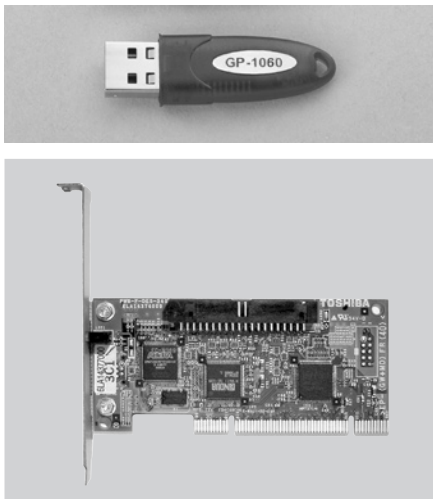

HDD Encryption

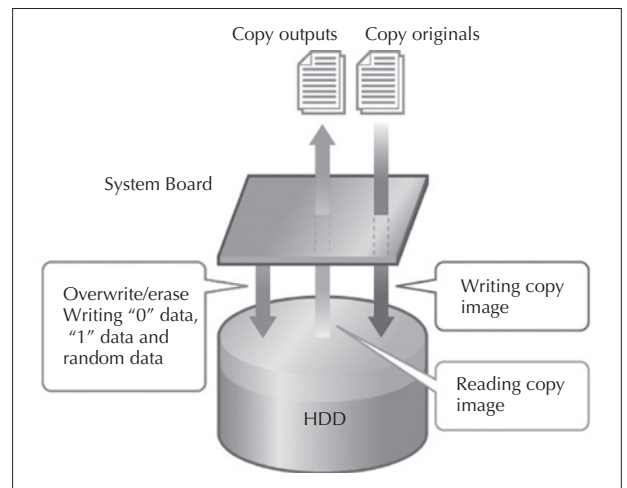

Data Overwriting



2005.11.04 11:16

PRINT FAX SCAN LOG STATUS

PRIVATE PRINT JOB

Document Name	Date,Time	Paper	Pages	Sets
New Brochure.pdf	04,11:11	A4	6	1
Microsoft PowerPoint - Global me	04,11:12	A4	14	1
Microsoft Word - New Technology.	04,11:12	A4	2	1
Microsoft Word - Specifications.	04,11:14	A4	24	1

PRINT PROOF PRIVATE INVALID

RETURN DELETE ALL CLEAR SELECT ALL EDIT RELEASE 1/1

2005.11.04 11:15

PRINT FAX SCAN LOG STATUS

PRIVATE PRINT JOB

User Name

07266

PRINT PROOF PRIVATE INVALID

RETURN ADMIN PASSWORD 1/1

2005.11.04 11:05

ADDRESS COUNTER USER ADMIN

ADMINISTRATOR PASSWORD

PASSWORD

Private Print

Private Print protects confidential documents from unauthorised public viewing. The user must first password protect each print job on the computer, then at any time release the job for immediate printing by entering the same password on the Touch Panel Display. Releasing an entire batch of jobs can be done in a similar way by using one password rather than several for each of the jobs.

Password Management and Authentication

Password management has been further reinforced for the e-STUDIO232/282 with 10-digit alphanumeric passwords for administrators. Moreover, with the ability to recognise up to 1,000 Department Codes, and to authenticate up to 10,000 users with individual ID & Password, it is possible to restrict machine access of each employee in almost any company. Access is easily controlled, and unauthorised operations prevented. Other security solutions like Active Directory and SMTP/LDAP Authentication are also available.

IP Address Filtering is another way of controlling access to the e-STUDIO232/282 by limiting the access based on the individual client PC's IP address. In this way it is possible to strengthen security by blocking certain IP address or range of IP values, and only allow designated client PCs to gain machine access.

1

2

3

4

5

6

7

8

5 FEATURES & BENEFITS

MANAGEMENT

The e-STUDIO232/282 offer many standard management tools accessible by all users, as well as more specific functions that are only available for the administrator. The main management tools are:

TopAccess™ Web-based Utility and TopAccessDocMon

The convenient **TopAccess™** web utility is a standard feature that offers real-time device management and makes it easy to identify machine errors so prompt action can be taken. Besides offering all users a convenient and quick way to register data in the templates and Address Books, **TopAccess™** provides administrator specific functions for more precise management and security settings like Password Settings, Print Counter Management, Device Setup, Job Log, Network and Printer settings.

In addition, the **TopAccessDocMon** is a handy job monitoring application that allows users to monitor various status information about ongoing jobs, take control over their own jobs and confirm the status of the system. Instant messages like machine errors, print event status, job failure, and job completion are displayed as popup alerts directly to the computer so users are well informed to be able to take action if necessary without even having to leave their chair.

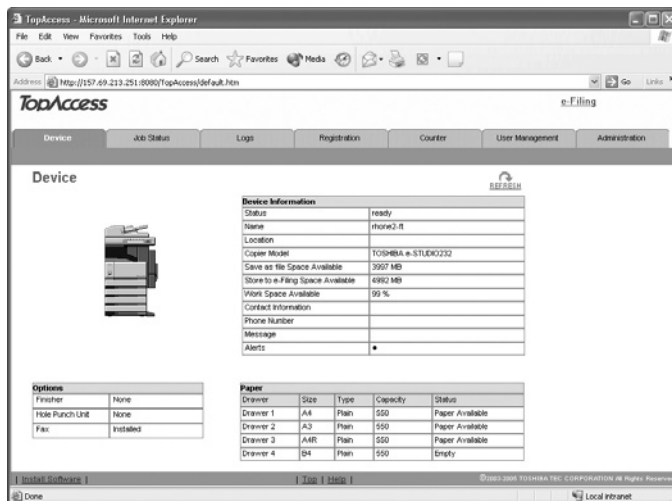
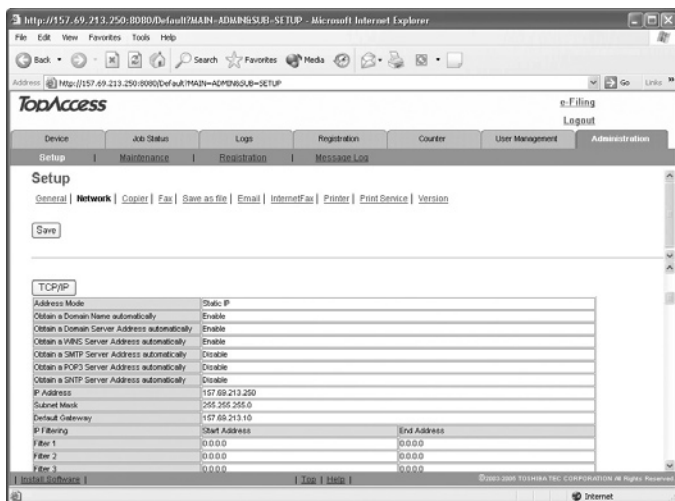

Remote Service

This automated maintenance feature can only be set by the service technician and consists of Service Notification and Auto Supply Order, and when used properly helps remove troublesome maintenance and unnecessary downtime. The Service Notification reports the Total Counter, PM Counter and Service Call notifications and automatically informs the status of the e-STUDIO232/282 to the service provider by email or regular fax*. In the same way, the Auto Supply Order function automatically orders the toner and used toner container.

*Requires the optional Fax Board GD-1150.

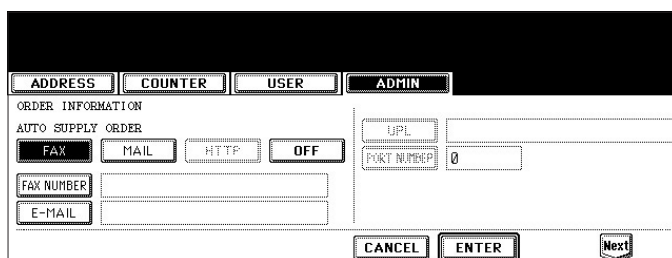
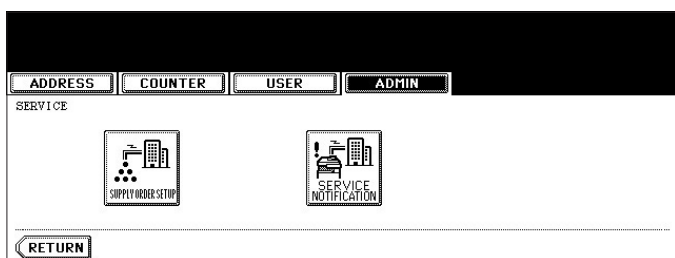



Features List

Item	e-STUDIO232/282	Item	e-STUDIO232/282
MFP General Features		Fax Features	
Templates	Yes	Super G3	Yes
Easy-to-Use Wide Control Panel	Yes	Memory Faxing/Direct Faxing	Yes
Unified Address Book	Yes	Internet Fax	Yes
Mixed Sized Scans	Yes	Fax & Email	Yes
Energy Savings	Yes	Chain Dial	Yes
Copying Features		Polling	
Memory Copy	Yes	Schedule	Yes
Duplex	Yes	2-Sided Original Scanning/Duplex Printing	Yes
N-in-1	Yes	Mail Box	Yes
Magazine Sort	Yes	Network Fax	Yes
Electronic Sort	Yes	On Ramp/Off Ramp	Yes
Alternation	Yes	2nd Line (Dual Access)	Yes
Image Shift	Yes	Recovery Transmission	Yes
Background/Sharpness Adjustment	Yes	Save as File	Yes
Job Reservation	Yes	e-Filing Features	
Time Stamp/Page Numbering	Yes	Editing	Yes
Center Erase	Yes	Printing	Yes
Edge Erase	Yes	Copy to/and Box	Yes
Dual Page Copying	Yes	Print to/and Box	Yes
X-Y Zoom	Yes	Scan to Box	Yes
Trimming/Masking	Yes	Received Fax to Box	Yes
Mirror Image	Yes	Email Forwarding	Yes
Cover Sheet/Sheet Insertion	Yes	e-Filing Web Utility	Yes
Rotation Copy	Yes	File Downloader	Yes
Image Direction	Yes	TWAIN Driver	Yes
Proof Copy	Yes	Imaging Features	
Custom mode (Original Mode)	Yes	2400 x 600 dpi Resolution	Yes
Color mode (Original Mode)	-	Serial Filter	Yes
Copy as File/Copy to e-Filing	Yes	Sharp Edge	Yes
Job Build	Yes	Small Particle Toner	Yes
Printing Features		Management Features	
Duplex Printing	Yes	Standard TopAccess	Yes
N-in-1	Yes	Department Codes	Yes
Private Print	Yes	Email Notification by TopAccess Setting	Yes
Proof Print	Yes	Remote Service	Yes
Schedule Printing	Yes	Job Status (Key)	Yes
Cover Sheet/Sheet Insertion	Yes	Copy/Print Management for Colour Only	-
Tab Sheet Printing	Yes	Security Features	
Image Overlay	Yes	HDD Encryption (Scrambler Board)	Yes
Water mark	Yes	Erasing HDD Data (Data Overwrite kit)	Yes
Toner Save	Yes	User Authentication	Yes
"Do not print blank pages" functionality	Yes	Role Base Access Control	Yes
Email Printing	Yes	LDAP Authentication	Yes
FTP Printing	Yes	Active Directory	Yes
TopAccessDocMon	Yes	Finishing Features	
Scanning Features		Staple	
Scan to Email	Yes	Bookbinding (Saddle-Stitch)	Yes
Scan to File	Yes	Hole Punch	Yes
Scan to e-Filing	Yes	Offset Tray	Yes
Background/Sharpness Adjustment	-	Job Separate	Yes
File Format (PDF/TIFF/JPEG)	PDF/TIFF	Manual Stapling	-
		Other Features	
		e-BRIDGE Viewer	Yes

Each of the features are described in detail in the General Sales Guide

6 PURCHASE MOTIVATIONS

The comprehensive value-added features of the mid-range e-STUDIO232/282 provide users with several improvements and capabilities on par with high-range models. The result is a cost-efficient digital solution that further contributes to office productivity and also offers the flexibility to add new options when new needs arise. In this chapter we will identify some of the major concerns and frequently asked questions and the solutions or benefits that can be achieved with the e-STUDIO232/282.

The sales professionals can use these examples to help expand their sales and success in business.

1. What are the advantages of a digital copier?

Our small-sized company has for many years relied on an analogue copier, but recently demands have outgrown the copier's capacity and we're therefore looking for other solutions, so what's behind the advantage of shifting towards a digital machine?

Scan Once/Copy Many

Using digital solutions means, firstly taking advantage of the system's memory capacity as with the Scan Once/Copy Many functionality offered by the e-STUDIO232/282 for more productivity and convenience. Rather than the time-consuming and noisy continual scanning of an original, multiple copies of a single original can be quickly printed out of memory. Digital copier features delivers faster scanning and print output, and with the ability to store jobs for later retrieval; something an analogue copier cannot do.

2. What about the tiresome collating process?

Manually compiling and distributing paper documents to various workgroups is often very time consuming and troublesome, so how can I become more efficient and achieve greater productivity while reducing costs and time?

Electronic Sorting

The standard hard drive of the digital e-STUDIO232/282 enables the use of easy and instantaneous electronic sorting of documents without the need for mechanical sorters. More important, by combining electronic sorting with the optional finishers, users also have access to everything needed for attractive automated stapling and booklet making.



3. What are the merits of a multi-functional product?

Copier, printer, scanner and fax machine as well as office furniture and different consumables all occupy valuable space, making the office environment smaller. Furthermore, ordering different consumables for the various devices separately is a pain as well as having several service agents. Is there a better way of creating a more comfortable office environment?

All-in-One

The e-STUDIO232/282 represents an all-in-one digital multifunctional solution that offers the advantage of a copier, printer, scanner and fax machine all in a powerful compact design that saves office space without compromising functionality or quality. And, because this is a single unit, you can also minimise the costs associated with maintaining consumables and service calls. All copier-printer-scanner-fax-network capabilities are combined into a single machine, making it necessary to have only one power and network cable. Adding the optional Wireless LAN capability can further enhance the office environment by removing restrictions as to where the machine is placed.

4. What about reducing daily paper usage?

I'm wondering how your digital solution helps promote a healthier office environment that actively involves our office staff in conserving natural resources and reducing daily paper consumption?

N-in-1/Duplex

The e-STUDIO232/282 offer several ways to reduce paper consumption and also introduce effective steps towards a paperless office environment. Among those most effective are both N-in-1 and Duplex functionality that allow users to condense multiple originals onto one or both sides of a single sheet, thereby saving time, paper and printing costs.

1

2

3

4

5

6

7

8

6 PURCHASE MOTIVATIONS

5. What about adjusting image quality?

I'm having trouble getting a white background when copying newspaper clips, so I'm looking for the easiest way of copying these kinds of documents. How can I achieve the best output quality regardless of the original image?

Image Quality Adjustment

The e-STUDIO232/282 offers quick access to flexible image quality settings such as text, text/photo and photo modes. Auto and manual exposure settings make it possible to make background adjustments according to the original image contents.

6. What about creating electronic documents?

Our office is considering turning our current and future documents into digital files, so what kind of solution do you offer that efficiently scans large and complex documents?

e-Filing Box

One of the many flexible features that come with the e-Filing box is the ability to combine or merge various data sources, such as copies, scans, prints and even received faxes into a single document for printing later on. By taking advantage of the e-Filing box it becomes easy to create and manage electronic documents from various existing sources.

7. What about ease of use?

I've heard that your digital copier has many rich features, but I'm wondering if they are easy to use?

1/2 VGA LCD Touch Panel

The overall control panel of the e-STUDIO232/282 is designed to be wider and more readily visible making it easy to use. Moreover, the control panel is tiltable to convenient viewing angle for many users. The 1/2 VGA LCD Touch Panel consists of large, well placed icons for easy recognition of any function.



8. What about automating routine jobs?

I understand that an MFP has many more possibilities, but I'm worried that in the long run I'll get tired of always having to go through the same settings to achieve my goals. There has to be a simple and more time efficient way of deciding the modes and procedures?

Template Functions

The e-STUDIO232/282 offer many multi-purpose templates for effectively automating routine or complex tasks. Each template is a useful shortcut to getting jobs done quickly and easily. As they all have the same basic interface, each operation is smooth, intuitive and user-friendly, even though the functions you want to use are different.

9. What about replacing the toner cartridge?

Frequently having to replace the toner cartridge can be a troublesome and costly process, and I was wondering if you have a solution resolving that problem?

Toner Recycle System — Large Capacity Toner Cartridge

The e-STUDIO232/282 utilises an advanced toner recycling system that even removes the need for the common waste toner bag. Improvements have also been made to the life span of the toner cartridge. As a result, the frequent and troublesome process of replacing the toner has been reduced substantially, and the waste toner bag has become obsolete.

10. What about using special paper stock?

In our day-to-day work we deal with different types of paper, and we are therefore looking for a digital copier that doesn't jam all the time when using various thick papers and can also easily print onto envelopes. What kind of solution do you offer?

Envelope Compatibility

The e-STUDIO232/282 supports the printing of address and logos on various envelope formats as well as a large variety of special paper media like tab sheet papers, transparencies, and thick paper formats up to 209g/m².

1

2

3

4

5

6

7

8

6 PURCHASE MOTIVATIONS

11. Is there an inexpensive network solution?

Integrating an MFP into a network environment provides a wealth of new possibilities. However adding extra options or additional software solutions is often a costly affair, so what kind of solution do you offer?

NIC Standard

The e-STUDIO232/282 comes standard with a Network Interface that is used to provide a network connection for many useful features such as automatic service notification, and scanning to file or TWAIN. The e-STUDIO232/282 also come with the Top Access web utility, which allows network administration of many features such as the Department Codes or machine default settings.

12. What about cable-free network capability?

Our company has recently set up a wireless network environment to expand and supplement the reach of our cable-based office networks. How can your digital system be fitted to our existing network configuration?

Wireless LAN (Option)

The e-STUDIO232/282 are compatible with common network protocols—even wireless LAN systems, which ensures that users can establish a “cable free” office environment.

13. What about high image quality improvements?

The need for higher image quality has increased, and we are therefore looking at acquiring a digital copier that offers more flexibility and overall quality improvements.

New Toner/New Developer

The digital e-STUDIO232/282 incorporate Toshiba’s latest image technology research and introduces a totally new concept in toner and developer improvements, setting a new standard in image reproduction levels.



14. What about specific image quality settings?

We're using a particular original that requires special care, and are struggling to get a clear copy. So we asked the service person to adjust the quality settings to suit the original, unfortunately that's now affected our other originals. How can we avoid this problem?

Custom Mode

The e-STUDIO232/282 allows the service person to make image quality adjustments and to individually set a custom mode for that special image, thereby avoiding any adverse affect on your normal settings. The custom mode button can be found among the other available original mode buttons.

15. What about loss in speed when duplex copying and printing?

I've noticed that the output speed of our current copier slows down when making double-sided copies, so how does your digital machine differ?

High Speed Duplex

The duplexing mechanism of the e-STUDIO232/282 has been redesigned to have a simpler paper path and fewer mechanical parts. These improvements resulted in productivity achievements of 100% of its rated engine speed without the usual loss in speed.

16. What about the merits of the optional printer solutions?

We have an analogue copier and printer, but the printer is getting outdated and often out of order, so we're interested to know what advantages we'll gain from using the optional printer functionality of your digital system?

Optional Printer Functionality

The digital e-STUDIO232/282 is a versatile multifunctional solution, ideal for many business environments. When increasing the flexibility of the e-STUDIO232/282 with optional printer functionality, you will gain many benefits such as reduced running costs, the flexibility of paper supply and features normally found only on copiers, and the long life consumables requiring much less user intervention.

1

2

3

4

5

6

7

8

17. What are the merits of the optional scanner functionality?

Now we have a large volume of paper documents, which we need to digitise by using our flatbed scanner. This is a tedious process, so I was wondering what kind of solution you offer?

Optional Scanner Functionality

The scanner option of the e-STUDIO232/282 operates at a speed of 50 spm with the optional RADF and also has the ability to automatically handle documents that are double sided and up to A3 in size. A perfect solution for turning any paper documents into electronic documents, fast and efficiently. Furthermore, without the need for any additional software to create PDF or TIFF documents.

18. What are the merits of using the optional fax functions?

Our business requirements have changed, and we now have more fax jobs than ever before, which is putting a real strain on our normal fax machine. So what can you offer us?

Optional Fax Functionality

The optional fax function of the e-STUDIO232/282 is faster than regular fax machines due to its increased scanning speed, and its high capacity memory. In addition, the e-STUDIO232/282 are also capable of automatically double siding received faxes to save on paper not to mention the fact that incoming faxes can also be routed to file, email or e-Filing systems. The control panel is much larger and easier to use than most regular fax machines.

19. What about higher print/copy functionality and increased productivity?

In our office we share one single copier, so we often have to wait in line when somebody is processing high volume printing jobs! Isn't there a way to avoid this inefficiency?

High Productivity

The e-STUDIO232/282 is a cost-efficient solution that provides a speedy 23/28 cpm copying speed as well as a quick scanning speed of 45 spm, which in combination with the advanced Job reservation capability (up to 10 different jobs) improves overall productivity and convenience. In this way, the e-STUDIO232/282 can scan while processing another copy/print job, so that the users can focus on more important work. This improves productivity and saves valuable time.



20. What about increasing paper handling productivity through job build functionality?

Having to copy different materials that also vary in size can be a time-consuming process, especially when collating manually. What kind of solution do you offer?

Job Build

The unique Job Build function of the e-STUDIO232/282 makes it possible to combine various copy jobs independent of their individual settings or document size, thereby removing many repetitive and manual steps in the paper handling process. Furthermore, multiple sets of these documents can be produced with electronic sorting.

21. What about registering frequently used document formats?

We have many company standard format documents that we frequently use, which unfortunately occupy large office space. Consequently, sometimes it is difficult to identify the right document. I was therefore wondering if you have any solution for this problem?

Standard Scan

Yes, we have a good solution to get you organised that is also a standard feature of this machine. The e-STUDIO232/282 is equipped with a Copy to e-Filing that stores the copy images directly into the registered e-Filing box in the HDD. It is therefore very easy to register frequently used fax forms or even letterheads and combine them with various data for printing out at a more convenient time. Moreover, the saved data can later be retrieved as PDF or TIFF file format to the client PC via the File Downloader software.

1

2

3

4

5

6

7

8

22. What about remote notification?

Machine problems or failures result in unnecessary downtime that could be prevented by an early warning system. What kind of features do you offer that help prevent frequent recurrence of machine trouble, and how would it help our business?

Remote Service

The e-STUDIO232/282 support many remote monitoring features that are both cost efficient and performance enhancing. Automatic system notifications via email can notify the service department that attention is required for preventative maintenance or breakdown and will even transmit meter readings without user intervention. Also, supplies can be monitored so that you never run out by the automatic supply ordering system via email or fax. Using these convenient features will lead to a reduction in downtime

23. What about data security and access restrictions?

Our department often deals with sensitive information and I'm worried about the data security when connecting to a network. What kind of solution do you offer?

Security

The e-STUDIO232/282 offer strong data security and access restrictions. Security is provided to documents in the e-Filing box, where all access to personal folders can be password protected. In copy mode, Toshiba's original data compression technology makes it difficult to extract information. In addition, when installing the optional Overwrite Kit, which is a secure data erase tool offered as an expansion key, temporary data that is left behind after each job will be automatically overwritten using the US Department of Defence (DoD) standard, making this kind of temporary data irretrievable. Adding to these security measures, the optional scrambler board will encrypt data on the HDD to a level of 128-bit, further safeguarding copy-print-scan data from unauthorised access should the HDD be removed.



24. What about reducing misprints when dealing with large copy/print volume?

We are handling large print/copy jobs, and worried that a tiny mistake in the output can turn into costly disasters. What solution do you offer to help prevent these errors and waste of resources?

Proof Print/Proof Copy

The e-STUDIO232/282 come with two efficient and easy-to-use functions ideal for large print or copy jobs consisting of many sets. For instance, the Proof Print allows users to print out only one single set as a proof when printing more than one set of documents. Users can then check this proof print and select whether they want to print out the rest or quit printing to change the settings on the proof print job list. When printing out the rest, users can change the number of printouts. In a similar way, when selecting the Proof Copy function prior to final printing users can print out a single copy for detecting and correcting any errors, including deleting, changing the number of copies or used staples, and use image shift when necessary, before committing to costly high-volume production. In comparison, the Proof Copy function allows for more direct ways to correct errors than using the Proof Print function.

1

2

3

4

5

6

7

8

7 COMPETITOR COMPARISONS



Brand		TOSHIBA	CANON	RICOH	SHARP
Model		e-STUDIO232	iR2270	Aficio 3025	AR-M236
Basic Feature					
Copy / Print Speed(ppm)	A4/LT	23	22	25	23
Warm-up Time		25 sec.	30 sec.	12 sec.	23 sec.
Dimension (W x D x H)		637 x 715 x 739 mm	565 x 700 x 761 mm	550 x 604 x 980 mm	623 x 610 x 641 mm
Weight		74.8 kg	61.6 kg	62 kg	46 kg
Control Panel	Display Type	1/2 VGA Touch panel	7.8 inch Touch panel	1/2 VGA Touch panel	Original size Touch panel
	Tilt	Yes (Free angle)	No	No	No
Template		Unified Type	Individual Type	Individual Type	Individual Type
Duplex		Std. Stackless	Std. Stackless	Opt. Stackless	Std. Stackless
Document Feeder		Opt. 100-sheet RADF	Opt. 50-sheet RADF	Opt. 50-sheet RADF	Opt. 100-sheet RADF
Input Paper Capacity	Std. / Max.	1,200 / 3,700 sheets	1,150 / 4,750 sheets	1,000 / 3,100 sheets	1,100 / 2,100 sheets
	Bypass	100 sheets	50 sheets	100 sheets (Opt.)	100 sheets
	Opt. Drawer	550 sheets x 2	550 sheets x 2	500 sheets x 2	500 sheets x 2
Paper Weight	LCF	2,500 sheets	2,500 sheets	2,000 sheets	-
	Drawer	64 - 105 g/m ²	64 - 80 g/m ²	60 - 105 g/m ²	56 - 105 g/m ²
	Bypass	50 - 209 g/m ²	64 - 128 g/m ²	52 - 157 g/m ²	52 - 200 g/m ²
Finishing Options	#1	2 / 30 / 900 / No / No	1 (2 Opt.) / 50 / 1000 / Opt. / No	1 / 30 / 500 / No / No	2 / 30 / 1100 / No / No
Tray / Staple capacity / Total paper capacity / Hole punch / Saddle stitch	#2	1 / 50 / 1000 / Opt. / Yes	2 / 50 / 2000 / No / No	2 / 50 / 1250 / No / No	1 / 50 / 1000 / Opt. / Yes
	#3	-	2 / 50 / 2000 / Opt. / Yes	-	-
	Other	Job Separator Offset Tray	Inner Tray	-	Job Separator
Copier Feature					
First Copy Speed		5.4 sec.	4.9 sec.	4.4 sec.	4.8 sec.
Job Reservation		10 Jobs	5 Jobs	Yes	Yes
Resolution		2400 x 600dpi (With smoothing)	1200 x 600 dpi (With smoothing)	600 x 600dpi	600dpi (2ÇRcpm) / 1200dpi (13.5 cpm)
Zoom	Platen	25 to 400 %	25 to 400 %	25 to 400 %	25 to 400 %
	RADF	25 to 200 %	25 to 200 %	25 to 400 %	25 to 400 %
Memory (Std./Max)	RAM	32 MB / 32 MB	512 MB / 512 MB	128 MB / 384 MB	32 MB / 1056 MB
	HDD	40 GB+	20 GB	20 GB (Opt.)	-
Printer Feature		Opt.	Opt.	Opt.	Opt. (GDI standard)
Memory (Std./Max.)	RAM	256 MB / 256 MB	512 / 512 MB (Shared)	384 MB (Shared)	64 MB / 320 MB
	HDD	40 GB+ (Shared)	20 GB (Shared)	Opt. 20 GB (Shared)	-
Resolution		2400 x 600dpi (With smoothing)	2400 x 600dpi (With smoothing)	2400 x 600 dpi (With smoothing)	1200dpi
PDL	Std.	PCL6, PS3	PCL5e/6, PS3, UFR II	PCL5e/6, RPCS	PCL5e/6
	Opt.	-	-	Adobe PostScript3	PS3
Fonts (Kinds)		PCL 80 / PS 136	PCL 80 / PS 136	PCL 59 / PS 136	PCL 80 / PS 136
Interface	Std.	USB (Full-Speed), 10BaseT/100BaseTX	10/100BaseT USB 2.0 High-speed	10Base T/100BaseTX USB 2.0	IEEE1284, USB2.0, 10/100 BaseT
	Opt.	Wireless LAN	Wireless LAN	IEEE1284, FireWire Bluetooth, WirelessLAN	-
Scanner Feature		Opt.	Opt.	Opt.	Opt.
Resolution		150/200/300/400/600dpi	150/200/300/400/600dpi	Up to 600dpi	200/300/600dpi
Max. Scan Speed		50 spm (400dpi)	45 spm (300dpi)	52 spm (200dpi)	40 spm
Data format		TIFF, PDF	TIFF / PDF	TIFF, JPEG, PDF	TIFF, PDF
Scan to File (Protocols)		SMB, FTP, IPX/SPX	SMB, FTP, IPX	SMB, FTP, NCP	FTP
Scan to Email		Yes	Yes	Yes	Yes
TWAIN Scan		Yes	Yes	Yes	Yes
Document Storage (Box Function)		Yes	Yes	Yes	-
Internet fax		Yes	Yes	Yes	-
Fax Feature		Opt.	Opt.	Opt.	Opt.
Communication mode		Super G3	SuperG3	SuperG3	Super G3
Modem Speed		33.6kbps	33.6kbps	33.6kbps	33.6kbps
Data Compression		MH, MR, MMR, JBIG	MH, MR, MMR, JBIG	MH, MR, MMR, JBIG	MH, MR, MMR, JBIG
Number of Lines	Std./Max.	1 / 2	1 / 2	1 / 2	1 / 1
Phonebook (including speed dial)		1000	200 / 1,800 (Opt.)	500 / 2,000 (Opt.)	500
Network Fax		Yes	Yes	Yes	Yes
Security Feature		Opt.	Opt.	Opt.	-
HDD Encryption		Yes	Yes	-	-
HDD Data Overwrite		Yes	Yes	Yes	-

* " - " is not available



Konica Minolta bizhub 200/250	KYOCERA MITA KM-2050 / KM-2550	Panasonic DP-2330	Xerox WorkCentrePro123	Fuji Xerox DocumentCentre236
20 / 25 24 sec.	20 / 25 20 sec.	23 35 sec.	23 12 sec.	23 25 sec.
677 x 710 x 718 mm	570 x 592 x 607 mm	597 x 707 x 860 mm	1340 x 1185 x 1340 mm	640 x 650 x 1114 mm
74 kg	47 kg	82 kg	63 kg	99 kg
1/4 VGA Touch Panel Yes (3 angles)	Original size LCD No	1/2 VGA Touch panel No	1/2 VGA Touch Panel No	1/2 VGA Touch Panel No
Individual Type Std. Stackless Opt. 80-sheet RADF	Individual Type Opt. Stackless Opt. 50-sheet RADF	Individual Type Std. Stackless Std. 50-sheet RADF	Individual Type Opt. Stackless Std. 50-sheet RADF	Individual Type Std. Stackless Std. 75-sheet RADF
1,150 / 3,650 sheets 150 sheets 500 sheets x 2 2,500 sheets	650 / 1,250 sheets 50 sheets 300 sheets x 2	1,150 / 2,250 sheets 50 sheets 550 sheets x 2	1,100 / 3,100 sheets 100 sheets 500 sheets x 2 2,000 sheets	1,095 / 4,095 sheets 95 sheets 500 sheets x 2 2,000 sheets
56 -90 g/m ² 50-210 g/m ²	64-105 g/m ² 45-160 g/m ²	60 - 90 g/m ² 55 - 133 g/m ²	60-216 g/m ² 60-216 g/m ²	60-216 g/m ² 60-216 g/m ²
2 / 50 / 1200 / Opt./ Opt.	-	1 / 30 / 500 No / No	1 / 50 / 1000 / No / No	1 (2 Opt.) / 1000/ 50 / No / No
-	-	-	-	-
Job Separator Mail bin	Job Separator Internal Finisher	-	-	-
5.3 sec.	5.9 sec. / 4.9 sec.	4.5 sec.	4.5 sec	4.5 sec.
5 Jobs	-	12 Jobs	Yes	Yes
600 x 600 dpi	600 x 600 dpi	600 x 600dpi	600 x 600 dpi	600 x 600 dpi
25 to 400 % 25 to 400 %	50 to 200 % 50 to 200 %	25 to 400 % 25 to 400 %	25 to 400 % 25 to 400 %	25 to 400 % 25 to 400 %
192 M / 320 MB 40 GB (Opt.)	64MB / 256 MB	32 MB / 160 MB 40 GB (Opt.)	256 MB / 256 MB 20 GB (Opt.)	128 MB 20 GB (Opt.)
Opt. 192 M / 320 MB Opt. 40 GB (Shared)	Std. 64 MB / 320 MB	Std. 50 MB Opt. 40 GB (Shared)	Std. 256 MB / 512MB 20 GB (Opt.)	Std. 256 MB Opt. 20 GB
600 x 600 dpi	2400 x 600 dpi (With smoothing)	1200 x 600 dpi (With smoothing)	1200 x 1200 dpi	1200 x 1200 dpi
PCL5e/6 PS3	PCL5e/6, KPDL3	GDI PCL5e/6, PS3	PCL5e/6 Adobe PostScript3	PCL6 Adobe PostScript3
Not mentioned 10/100BaseT, USB (Full-speed)	PCL 80 / PS 136 IEEE1284, USB 2.0, 10BASE T/100BaseTX	No Information 10/100BaseTX, USB1.1	PCL 80 / PS 136 10/100BaseT, USB2.0, IEEE1284	PCL 81 / PS 136 10/100BaseT, USB2.0, IEEE1284
IEEE1284	-	-	IEEE802.11b	-
Opt. Up to 600 dpi 70 spm (200dpi)	Opt. 200/300/400/600dpi 20 spm / 25 spm	Opt. 150/300/600dpi 30 spm	Opt. 200/300/400/600dpi 50 spm	Std. 200/300/400/600dpi 50 spm (200dpi)
TIFF, PDF SMB, FTP	TIFF, PDF TCP/IP	TIFF, PDF TCP/IP, FTP	TIFF, JPEG, PDF FTP, SMB	TIFF, JPEG, PDF FTP, SMB
Yes Yes Yes	Yes Yes	Yes - Yes	Yes - Yes	Yes Yes Yes
Opt.	Opt.	Opt.	Opt.	Std.
Super G3 33.6kbps	Super G3 33.6kbps	Super G3 33.6kbps	Super G3 33.6kbps	Super G3 33.6kbps
MH, MR, MMR, JBIG 1 / 2	MH, MR, MMR, JBIG 1 / 1	MH, MR, MMR, JBIG 1 / 1	MH, MR, MMR, JBIG 1 / 1	MH, MR, MMR, JBIG 1 / 3
540	232	200 (max.1000)	500	500
Yes	Yes	Yes	No	Yes
-	-	Opt.	Opt.	Opt.
-	-	-	-	Yes
-	-	Yes	Yes	Yes

7 COMPETITOR COMPARISONS



Brand		TOSHIBA	CANON	RICOH	SHARP
Model		e-STUDIO282	iR2870	Aficio 3030	AR-M276
Basic Feature					
Copy / Print Speed(ppm)	A4 / LT	28	28	30	27
Warm-up Time		25 sec.	30 sec.	12 sec.	23 sec.
Dimension (W x D x H)		637 x 715 x 739 mm	565 x 700 x 761 mm	550 x 604 x 980 mm	623 x 610 x 641 mm
Weight		74.8 kg	61.6 kg	62 kg	46 kg
Control Panel	Display Type	1/2 VGA Touch panel	1/4 VGA Touch panel	1/2 VGA Touch panel	Original size Touch panel
	Tilt	Yes (Free angle)	No	No	No
Template		Unified Type	Individual Type	Individual Type	Individual Type
Duplex		Std. Stackless	Std. Stackless	Opt. Stackless	Std. Stackless
Document Feeder		Opt. 100-sheet RADF	Opt. 50-sheet RADF	Opt. 50-sheet RADF	Opt. 100-sheet RADF
Input Paper Capacity	Std. / Max.	1,200 / 3,700 sheets	1,150 / 4,750 sheets	1,000 / 3,100 sheets	1,100 / 2,100 sheets
	Bypass	100 sheets	50 sheets	100 sheets (Opt.)	100 sheets
	Opt. Drawer	550 sheets x 2	550 sheets x 2	500 sheets x 2	500 sheets x 2
Paper Weight	LCF	2,500 sheets	2,500 sheets	2,000 sheets	-
	Drawer	64 - 105 g/m ²	64 - 80 g/m ²	60 - 105 g/m ²	56 - 105 g/m ²
	Bypass	50 - 209 g/m ²	64 - 128 g/m ²	52 - 157 g/m ²	52 - 200 g/m ²
Finishing Options	#1	2 / 30 / 900 / No / No	1 (2 Opt.) / 50 / 1000 / Opt. / No	1 / 30 / 500 / No / No	2 / 30 / 1100 / No / No
Tray / Staple capacity / Total paper capacity / Hole punch / Saddle stitch	#2	1 / 50 / 1000 / Opt. / Yes	2 / 50 / 2000 / No / No	2 / 50 / 1250 / No / No	1 / 50 / 1000 / Opt. / Yes
	#3	-	2 / 50 / 2000 / Opt. / Yes	-	-
	Other	Job Separator Offset Tray	Inner Tray	-	Job Separator
Copier Feature					
First Copy Speed		5.4 sec.	4.9 sec.	4.4 sec.	4.8 sec.
Job Reservation		10 Jobs	5 Jobs	Yes	Yes
Resolution		2400 x 600dpi (With smoothing)	1200 x 600 dpi (With smoothing)	600 x 600dpi	600dpi (27cpm) / 1200dpi (13.5 cpm)
Zoom	Platen	25 to 400 %	25 to 400 %	25 to 400 %	25 to 400 %
	RADF	25 to 200 %	25 to 200 %	25 to 400 %	25 to 400 %
Memory (Std./Max)	RAM	32 MB / 32 MB	512 MB / 512 MB	128 MB / 384 MB	32 MB / 1056 MB
	HDD	40 GB+	20 GB	20 GB (Opt.)	-
Printer Feature		Opt.	Opt.	Opt.	Opt. (GDI standard)
Memory (Std./Max.)	RAM	256 MB / 256 MB	512 / 512 MB (Shared)	384 MB (Shared)	64 MB / 320 MB
	HDD	40 GB+ (Shared)	20 GB (Shared)	Opt. 20 GB (Shared)	-
Resolution		2400 x 600dpi (With smoothing)	2400 x 600dpi (With smoothing)	2400 x 600 dpi (With smoothing)	1200dpi
PDL	Std.	PCL6, PS3	PCL5e/6, PS3, UFR II	PCL5e/6, RPCS	PCL5e/6
	Opt.	-	-	Adobe PostScript3	PS3
Fonts (Kinds)		PCL 80 / PS 136	PCL 80 / PS 136	PCL 59 / P3 136	PCL 80 / PS 136
Interface	Std.	USB(Full-Speed), 10BaseT/100BaseTX	10/100BaseT USB 2.0 High-speed	10Base T/100 Base TX USB 2.0	IEEE1284, USB2.0, 10/100 BaseT
	Opt.	Wireless LAN	Wireless LAN	IEEE 1284, FireWire Bluetooth, WirelessLAN	-
Scanner Feature		Opt.	Opt.	Opt.	Opt.
Resolution		150/200/300/400/600dpi	150/200/300/400/600dpi	Up to 600dpi	200/300/600dpi
Max. Scan Speed		50 spm (400dpi)	45 spm (300dpi)	52 spm (200dpi)	40 spm
Data format		TIFF, PDF	TIFF / PDF	TIFF, JPEG, PDF	TIFF, PDF
Scan to File (Protocols)		SMB, FTP, IPX/SPX	SMB, FTP, IPX	SMB, FTP, NCP	FTP
Scan to Email		Yes	Yes	Yes	Yes
TWAIN Scan		Yes	Yes	Yes	Yes
Document Storage (Box Function)		Yes	Yes	Yes	-
Internet fax		Yes	Yes	Yes	-
Fax Feature		Opt.	Opt.	Opt.	Opt.
Communication mode		Super G3	Super G3	Super G3	Super G3
Max. Modem Speed		33.6kbps	33.6kbps	33.6kbps	33.6kbps
Data Compression		MH, MR, MMR, JBIG	MH, MR, MMR, JBIG	MH, MR, MMR, JBIG	MH, MR, MMR, JBIG
Number of Lines	Std./Max.	1 / 2	1 / 2	1 / 2	1 / 1
Phonebook (including speed dial)		1000	200 / 1,800 (Opt.)	500 / 2,000 (Opt.)	500
Network Fax		Yes	Yes	Yes	Yes
Security Feature		Opt.	Opt.	Opt.	-
HDD Encryption		Yes	Yes	No	-
HDD Data Overwrite		Yes	Yes	Yes	-

* " - " is not available



Konica Minolta Di3010 / f	KYOCERA MITA KM-3035	PANASONIC DP-3030	Xerox WorkCentrePro 128	Fuji Xerox DocumentCentre 286
30	30	30	28	28
17 sec. / 22 sec.	25 sec.	35 sec.	12 sec.	25 sec.
677 x 710 x 718 mm	585 x 646 x 745 mm 23" x 25" x 29"	597 x 707 x 860 mm	1340 x 1185 x 1340 mm	640 x 650 x 1114 mm
74 kg	82 kg	82 kg	63 kg	99 kg
1/4 VGA Touch panel	1 / 2 VGA Touch Panel	1/2 VGA Touch panel	1/2 VGA Touch Panel	1/2 VGA Touch Panel
Yes (3 angles)	No	No	No	No
Individual Type	Individual Type	Individual Type	Individual Type	Individual Type
Std. Stackless	Std. Stackless	Std. Stackless	Opt. Stackless	Std. Stackless
Opt. 80-sheet RADF	Opt. 100 sheets RADF	Std. 50-sheet RADF	Std. 50-sheet RADF	Std. 75-sheet RADF
1,050 / 3,650 sheets	1,200 / 4,200 sheets	1,150 / 2,250 sheets	1,100 / 3,100 sheets	1,095 / 4,095 sheets
150 sheets	200 sheets	50 sheets	100 sheets	95 sheets
500 sheets x 2	500 sheets x 2	550 sheets x 2	500 sheets x 2	500 sheets x 2
2,500 sheets	3,000 sheets	-	2,000 sheets	2,000
56 - 90 g/m ²	60 - 105 g/m ²	60 - 90 g/m ²	60 - 216 g/m ²	60 - 216 g/m ²
56 - 160 g/m ²	45 - 200g/m ²	55 - 133 g/m ²	60 - 216 g/m ²	60 - 216 g/m ²
2 / 50 / 1200 / Opt. / Opt.	2 / 50 / 3000 / Yes / No	1 / 30 / 500 No / No	1 / 50 / 1000 / No / No	1(2 Opt.) / 50 / 1000 / No / No
-	1 / 50 / 1000 / Opt. / Yes	-	-	-
-	1 / 30 / 1000 / No / No	-	-	-
Job Separator	Job Separator, Mail-bin Internal Finisher	-	-	-
5.3 sec.	3.9 sec.	4.5 sec.	4.5 sec	25 sec.
10 Jobs	9 Jobs	12 Jobs	Yes	Yes
600 x 600 dpi	600 x 600 dpi	600 x 600dpi	600 x 600 dpi	600 x 600 dpi
25 to 400 %	25 to 400 %	25 to 400 %	25 to 400 %	25 to 400 %
25 to 400 %	25 to 400 %	25 to 400 %	25 to 400 %	25 to 400 %
64 MB / 192 MB	64MB / 64 MB	32 MB / 160 MB	256 MB / 256 MB	128 MB
-	20 GB (Opt.)	40 GB (Opt.)	20 GB (Opt.)	20 GB (Opt.)
Opt. (Pi3505e / PS3)	Opt.	Std.	Std.	Std.
128 MB / 320 MB	64 MB / 576 MB	50 MB	256 MB / 512 MB	256 MB
Opt. 16 GB	Opt. 20 GB	Opt. 40 GB (Shared)	20 GB (Opt.)	Opt. 20GB
600 x 600dpi	1200 x 600 dpi / 2400 x 600dpi (KPDL3)	1200 x 600 dpi (With smoothing)	1200 x 1200 dpi	1200 x 1200 dpi
PCL5e/6, PS3	PCL6 , KPDL3	GDI	PCL5e/6	PCL6
-	-	PCL5e/6, PS3	Adobe PostScript3	Adobe PostScript3
PCL 46 / PS 136	PCL 80 / KPDL3 136	No Information	PCL 80 / PS 136	PCL 81 / PS 136
-	IEEE1284, USB 2.0 10/100BaseT	10/100BaseTX, USB1.1	10/100BaseT, USB2.0, IEEE1284	10/100BaseT, USB2.0, IEEE1284
10/100BaseT, USB1.1, IEEE1284	TokenRing, Wireless LAN 100BaseFX, 10BaseFL	-	IEEE802.11b	-
Opt. (SU-3)	Opt.	Opt.	Opt.	Std.
200/400/600dpi	200/300/400/600dpi	150/300/600dpi	200/300/400/600dpi	200/300/400/600dpi
35 spm	50 spm (600 dpi)	30 spm	50 spm	50 spm (200dpi)
TIFF, PDF	TIFF, PDF	TIFF, PDF	TIFF, JPEG, PDF	TIFF, JPEG, PDF
FTP	SMB, FTP	TCP/IP, FTP	FTP, SMB	FTP, SMB
Yes	Yes	Yes	Yes	Yes
Yes	Yes	-	No	Yes
Yes	-	Yes	Yes	Yes
Yes	-	Yes	Yes	Yes
Only f model	Opt.	Opt.	Opt.	Opt.
Super G3	Super G3	Super G3	Super G3	Super G3
33.6kbps	33.6kbps	33.6kbps	33.6kbps	33.6kbps
MH, MR, MMR, JBIG	MH, MR, MMR, JBIG	MH, MR, MMR, JBIG	MH, MR, MMR, JBIG	MH, MR, MMR, JBIG
1 / 2	1 / 1	1 / 1	1 / 1	1 / 3
540	600	200 (max.1000)	500	500
Yes	Yes	Yes	No	Yes
-	-	Opt.	Opt.	Opt.
-	-	-	-	Yes
-	-	Yes	Yes	Yes



General Specifications

Copying/Printing process	Indirect electrostatic photographic method
Type	Desktop
Original scanning method	CCD line sensor
Resolution	
Scanning.....	600 X 600 dpi
Printing.....	2400 X 600 dpi (with smoothing)
Gradation	256 steps
Original platen type.....	Fixed hard platen (optional: RADF or Platen cover)
Available original size	Maximum A3
Available paper size	
Drawer	Maximum A3, Minimum A5-R
Stack Feed Bypass.....	Maximum A3, Minimum A5-R, Envelope*
	*The acceptable envelop sizes are COM10, MONARCH, DL, YOU-4 and CHO-3
Paper supply.....	Standard 2 Drawers (550 sheets x 2) and Stack Feed Bypass (100 sheets)
Available paper weight.....	Drawer : 64 to 105 g/m ²
Stack Feed Bypass.....	50 to 209 g/m ² (Single-feed) 64 to 209 g/m ² (Multi-feed)
Auto Duplexing Unit	Standard
Paper exit	Face down/Inner Exit Tray
Processor.....	PowerPC 750CXr 333MHz
Memory (Shared for all imaging functions)	
Main memory	256 MB
Page memory	32 MB
Hard disk drive	40 GB+*
	*For hard drives, GB means 1 billion bytes.
Warm-up time	Approx. 25 seconds
Counter	Electronic counter
Power supply & consumption	Max. 1.5 kW (220 - 240 V)
Dimensions (W x D x H)	637 mm x 719 mm x 739 mm
With Pedestal (or LCF)	637 mm x 719 mm x 1016 mm
Weight	76.6 kg
Special Features.....	Energy Saver, Auto Energy Saver, Weekly Timer, Notification via e-mail, Template, IP filing, Department codes (1000 kinds), User authentication

Copier Specifications

Copying speed.....	23/28* cpm (A4) 16/16* cpm (A3)
	*e-STUDIO232/282 respectively.
Multiple copying	Up to 999 copies (Ten key input)
Reproduction ratio	
Zoom.....	25 % to 400 % in 1 % increments (platen), 25 % to 200 % in 1 % increments (RADF)
Original/Copy size.....	A3 to A5-R
First copy time.....	5.4 seconds
Original mode	Photo, Text/Photo, Text, Custom
Image density control	Automatic/Manual (11 steps)
Special Features.....	Interrupt, Zoom indicator, Dual page, Edge erase, Image shift, Trimming/ Masking, APS/AMS, Help/Info. Function, Auto job start, Auto drawer change, Auto duplex, Cover sheet, Sheet insertion, Auto sort mode, Mixed size original, X-Y zoom, Mirror, Alternation, 2-in-1 / 4-in-1, Page numbering, Date/Time print, Job reservation, Image Rotation,



Printer Specifications (Option : GM-1070 or GM-2070)

Processor.....	PowerPC 750Cxr 333MHz (Shared for all imaging functions)
Printing resolution	2400 dpi x 600 dpi (with smoothing)
Printing speed.....	23/28* ppm (A4) 16/16* ppm (A3) *e-STUDIO232/282 respectively.
Interface	
Standard	Ethernet 10Base-T/100Base-TX, USB 2.0 (Full speed)
Optional	Wireless LAN (IEEE802.11g)
Printer Language.....	PCL6 (compatible), PostScript3 (compatible)
Resident Fonts	PCL font: 80 fonts, PS font: 136 fonts
Support OS.....	Windows98/Me/NT4.0/2000/XP/2003 server (only 32 bit) Mac OS 8.6/9.x/X (10.1/10.2/10.3) Solaris (2.6/ 2.7/ 7.8/ 8), HP-UX (10.20/ 11.x), AIX (4.3.3), Linux (Redhat 7.2/ 7.3, SuSE Linux ver. 7.0, Mandrake Linux ver. 7.1, Turbo Linux 8), SCO (UnixWare7/ OpenUnix8)
Network Protocols.....	IPX/SPX, TCP/IP, EtherTalk, NetBIOS over TCP/IP
IP Addressing.....	Static IP, Auto IP, BOOTP, DHCP, Dynamic DNS (DHCP server)
Printing Protocols	Windows Printing (SMB), LPR/LPD, IPP ver1.1, NetWare P-SERVER with NDS/Binary/TOSHIBA NPDS Gateway/LPD with iPRINT, Apple Talk PAP or EtherTalk, Port9100 (bi-directional)
Client software	Windows printer driver, UNIX print filter, Macintosh printer driver, Network device management utility (TopAccessDocMon),
Special features	Scheduled print, Private print, Proof print, Print to overlay file, Store to e-Filing, Front cover, Back cover, Insert pages, booklet, Multiple pages per sheet, Watermark, Toner save, Halftone Type, Use black for all text, SSL print for IPP, Email printing, FTP printing

Scanner Specifications (Option : GM-4070 or GM-2070)

Connection type.....	Network (Ethernet)
Scanning Resolution.....	600, 400, 300, 200, 150 dpi
Scanning speed	50 spm (A4, at 150, 200, 300, 400 dpi) 45 spm (A4, at 600 dpi)
File format	PDF (Single/ Multi), TIFF (Single/ Multi)
Number of pages.....	Up to 1,000 pages (or HDD full)
Capacity of HDD.....	4 GB*
	*For hard drives, GB means 1 billion bytes
Compatibility.....	TWAIN
Scan agent.....	Scan to File, Scan to Email, Scan to e-Filing
Original mode.....	Photo, Text/Photo, Text
Protocol	
Scan to file.....	SMB, FTP, IPX/SPX
Scan to Email.....	SMTP,MIME (Base64)
Special Features.....	Job Template for multiple agents, Address Book (Scan to Email), LDAP Search (Scan to Email), Background adjustment

1

2

3

4

5

6

7

8

Internet Fax Specifications (Option : GM-4070 or GM-2070)

Connectivity	T.37 (Simple mode)
File format	TIFF-S
Resolution	Standard (8 x 3.85 dots/mm), Fine (8 x 7.7 dots/mm)
Document size	A3, B4, A4, A4-R, B5, B5-R, A5, A5-R , FOLIO
Address Book	1,000 destinations (Shared with fax number when installing Fax board)
Broadcast transmission	Maximum 400 destinations per job (including fax numbers)
Message size limitation.....	Maximum 30MB
Message Division	Page by page
Acceptable format	TIFF-S, TIFF-F, TIFF-J, TIFF-FX
Receive method.....	SMTP, POP3
Special Features.....	On Ramp Gateway, Off Ramp Gateway, Incoming routing (Send to File, Send to E-mail, Send to Internet Fax, Send to Box, Multiple agents for mailbox)

Walk-up FAX Specifications (Option : GD-1150)

Image format on PSTN.....	JBIG, MMR, MR, MH
Resolution	Standard (8 x 3.85 dots/mm), Fine (8 x 7.7 dots/mm), Super Fine (8 x 15.4 dots/mm), Ultra Fine (16 x 15.4 dots/mm)
Document size	A3 to A5-R
Compatibility.....	Super G3, G3
Modem speed.....	33.6kbps to 2.4kbps (automatic fallback)
Transmission speed.....	Approx. 3 seconds
Communication protocols	ITU-T T.30
Memory capacity.....	Transmission: 500MB (HDD) Reception: 120MB (HDD)
Transmission features.....	Direct transmission, Memory transmission, Delayed transmission, Quality transmission (Low speed transmission), Relay transmission, Recovery transmission (Maximum 24 hours), Priority transmission, Busy transmission, Batch transmission
Special Features.....	Second line optional, Specified cassette for fax reception (User setting)

e-Filing Specifications

Number of boxes	
Public box	1 box
User box.....	200 boxes
Number of pages	1,000 pages per document
Number of folders	100 folders per box
Number of documents.....	400 per box/folder
Capacity of HDD.....	5 GB*
	*For hard drives, GB means 1 billion bytes.
Input to Box (Single agent).....	Copy to Box, Print to Box, Received Fax to Box, Received Internet Fax to Box, Scan to Box
Input to Box (Multi agent).....	Copy & Box, Print & Box, Received Fax to File & Box, Received Internet Fax to File & Box, Received Fax to E-mail & Box, Received Internet Fax to E-mail & Box, Received FAX/Internet-Fax relay & Box, Received Internet FAX to Internet relay & Box, Fax to mailbox & Box, Scan to File & Box, Scan to E-mail & Box
Output from Box	Box to Print, Box to Email
Client software (Output from network)	
TWAIN driver (Available with Windows 98/Me/NT 4.0/2000/XP/2003),	
File Downloader (Available with Windows 98/Me/NT 4.0/2000/XP/2003)	
Special Features	
e-Filing Web utility	Box edit, Doc view, Folder edit, Doc edit, Page edit, Archive
Control Panel	Box edit, Folder edit



Paper Handling Options

*Not mentioned paper weights are 80 g/m²

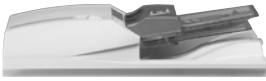

Reversing Automatic Document Feeder (RADF) MR-3020

Stack capacity100 sheets (A3 to A5-R)
Original setting.....Face up
Original paper size.....A3 to A5-R
Original paper weight.....35-157 g/m² (Simplex) / 50-157 g/m² (Duplex)
Dimensions (W x D x H)600 mm x 523 mm x 135 mm
Weight:12.5 kg



Paper Feed Pedestal (PFP) KD-1011

Paper supply.....Maximum 550 sheets or paper height 60.5 mm
Paper size.....A3 to A5-R
Paper weight.....64-105g/m²
Dimensions (W x D x H)623 mm x 657 mm x 320 mm (with Stabilizer)
530 mm x 577 mm x 320 mm (without Stabilizer)
Weight21.5 kg



Drawer module MY-1021

Paper supply.....Maximum 550 sheets or paper height 60.5 mm
Paper size.....A3 to A5-R
Paper weight.....64-105 g/m²
Dimensions (W x D x H)526 mm x 569.5 mm x 107 mm
Weight3.8 kg



Large Capacity Feeder (LCF) KD-1012A4

Paper supply.....Maximum 2,500 sheets or paper height 137.5 mm
Paper size.....A4
Paper weight.....64-105 g/m²
Dimensions (W x D x H)623 mm x 657 mm x 307.5 mm (with Stabilizer)
530 mm x 577 mm x 307.5 mm (without Stabilizer)
Weight27 kg

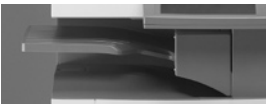

Job Separator MJ-5004

Tray Capacity.....Upper tray: 150 sheets or paper height 25 mm
Lower tray: 250 sheets or paper height 40 mm
Dimensions (W x D x H)498 mm x 415 mm x 153 mm
Weight3.3 kg

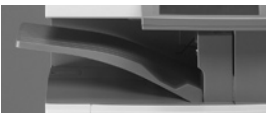

Offset Tray MJ-5005

Tray Capacity.....250 sheets or paper height 39 mm
Dimensions (W x D x H)500 mm x 415 mm x 169 mm
Weight3.5 kg

1

2

3

4

5

6

7

8



Finisher (Hanging type) MJ-1022

Trays.....	2 trays
Upper tray capacity	200 sheets (A4, B5, B5-R, A4-R) 140 sheets (B4) 100 sheets (A3, FOLIO)
Lower tray capacity	700 sheets (A4, B5, B5-R, A4-R) 490 sheets (B4) 350 sheets (A3, FOLIO)
Paper size	A3 to A5-R
Staple position.....	1 position
Staple capacity	30 sheets (A4, A4-R, B5) 20 sheets (B4) 15 sheets (A3, FOLIO)
Upper tray capacity of staple mode :	30 sets or 170 sheets (A4, A4-R, B5) 30 sets or 110 sheets (B4) 30 sets or 80 sheets (A3, Folio)
Lower tray capacity of staple mode :	50 sets or 600 sheets (A4, A4-R, B5) 50 sets or 400 sheets (B4) 50 sets or 300 sheets (A3, Folio)
Dimensions (W x D x H)	451 mm x 539 mm x 590 mm
Weight	Approx. 17 kg



Finisher (Saddle-stitch) MJ-1025

Trays.....	1 tray + Saddle-stitch tray
tray capacity.....	1,000 sheets or paper height 160 mm (A4, A4-R, B5, A5-R) 600 sheets or paper height 80 mm (B4, A3, B5-R, FOLIO)
Paper size	A3 to A5-R
Staple position.....	Multi-position (3 kinds)
Staple capacity	50 sheets (A4, A4-R, B5) 25 sheets (A3, B4, FOLIO)
Tray capacity of staple mode	30 sets or 1,000 sheets or paper height 160 mm (A4, A4-R, B5) 30 sets or 500 sheets or paper height 80 mm (A3, B4, FOLIO)
Saddle-stitch staple capacity.....	10 sheets (A3, B4, A4-R)
Saddle-stitch tray capacity	10 sets (6 - 10 sheets copy) 20 sets (2 - 5 sheets copy)
Dimensions (W x D x H)	538 mm x 603 mm x 1,011 mm
Weight	Approx. 38 kg

Hole Punch Unit MJ-6005 (for MJ-1025)

Type and hole location	MJ-6005E 2 holes (Pitch: 80 mm), MJ-6005F - 4 holes (Pitch: 80 mm), MJ-6005S - 4 holes (Pitch: 21 mm, 70 mm, 21 mm)
Dimensions (W x D x H)	90 mm x 560 mm x 170 mm (embedded MJ-1025)
Weight	Approx. 4 kg

Other options

Platen Cover KA-3511PC, Work Tray KK-3511, Bridge Kit KN-3520, Fax 2nd Line Board GD-1160, Scrambler board GP-1040, Data Overwrite kit GP-1060, PCI Slot GO-1060, Wireless LAN Adapter GN-1041, Antenna for Wireless LAN GN-3010, Harness kit for coin controller GQ-1020



1

2

3

4

5

6

7

8

Working together for the planet

Reflecting our commitment to environmental protection, Toshiba champions the creation of products whose ecological impact through their life cycle is kept to a minimum. For example, the e-STUDIO232/282 are compliant with both the ENERGY STAR® energy saving requirements of the U.S. Environmental Protection Agency (EPA) and the RoHS (Restriction of Hazardous Substances) requirements of the EU, and also follows the European WEEE (Waste Electrical and Electronic Equipment) Directive, which sets collection, recycling and recovery targets for all types of electrical products. The unit offers Energy Saver modes and a Sleep Mode to reduce power consumption when not in use, as well as paper saving features.

Toshiba printed circuit boards are 100% free of lead and halogen materials, plastic parts are halogen free, and Chromium (VI) free is also achieved for steel plates and screws.

Toshiba is also committed to environmentally responsible manufacturing facilities and practices. To date, four copier sales affiliates and all of manufacturing facilities have been awarded ISO 14001 certification, the internationally recognised standard for environmental management systems that minimise the ecological impact of business activities.

As a Toshiba customer, you play an active role in Toshiba's environmental efforts. Let's work together for the sake of our shared habitat.

1

2

3

4

5

6

7

8

Microsoft, Windows, and Windows NT are registered trademarks of Microsoft Corporation in the United States and/or other countries.
All other brand and/or product names are trademarks of their respective owners.
For hard drives, GB means 1 billion bytes. Total hard drive accessible capacity may vary depending on operating environment.
Design and specifications subject to change without notice.
All rights reserved. No part of this material may be used or reproduced in any manner whatsoever without permission.

Free Manuals Download Website

<http://myh66.com>

<http://usermanuals.us>

<http://www.somanuals.com>

<http://www.4manuals.cc>

<http://www.manual-lib.com>

<http://www.404manual.com>

<http://www.luxmanual.com>

<http://aubethermostatmanual.com>

Golf course search by state

<http://golfingnear.com>

Email search by domain

<http://emailbydomain.com>

Auto manuals search

<http://auto.somanuals.com>

TV manuals search

<http://tv.somanuals.com>