

TABLE OF CONTENTS

	Page
1. UNPACKING	1- 1
1.1 PROCEDURE.....	1- 1
1.2 CHECKS.....	1- 1
2. MAJOUR UNIT REPLACEMENT.....	2- 1
2.1 REPLACING THE CPU PC BOARD	2- 1
2.2 REPLACING THE MOTOR	2- 5
2.2.1 Ribbon Motor	2- 5
2.2.2 Stepping Motor.....	2- 6
2.3 REPLACING THE PS UNIT	2- 7
2.4 REPLACING THE PRINT HEAD.....	2-11
2.5 REPLACING THE MEDIA SENSOR	2-11
2.5.1 Replacing the Sensor PCB (TR)	3-10
2.5.2 Replacing the Sensor PCB (LED).....	3-11
3. TROUBLESHOOTING	3- 1

CAUTION!

1. *This manual may not be copied in whole or in part without prior written permission of TOSHIBA TEC.*
2. *The contents of this manual may be changed without notification.*

1. UNPACKING

1.1 PROCEDURE

- 1) Open the carton.
- 2) Unpack the side pad (R) and cushions and the printer from the carton.

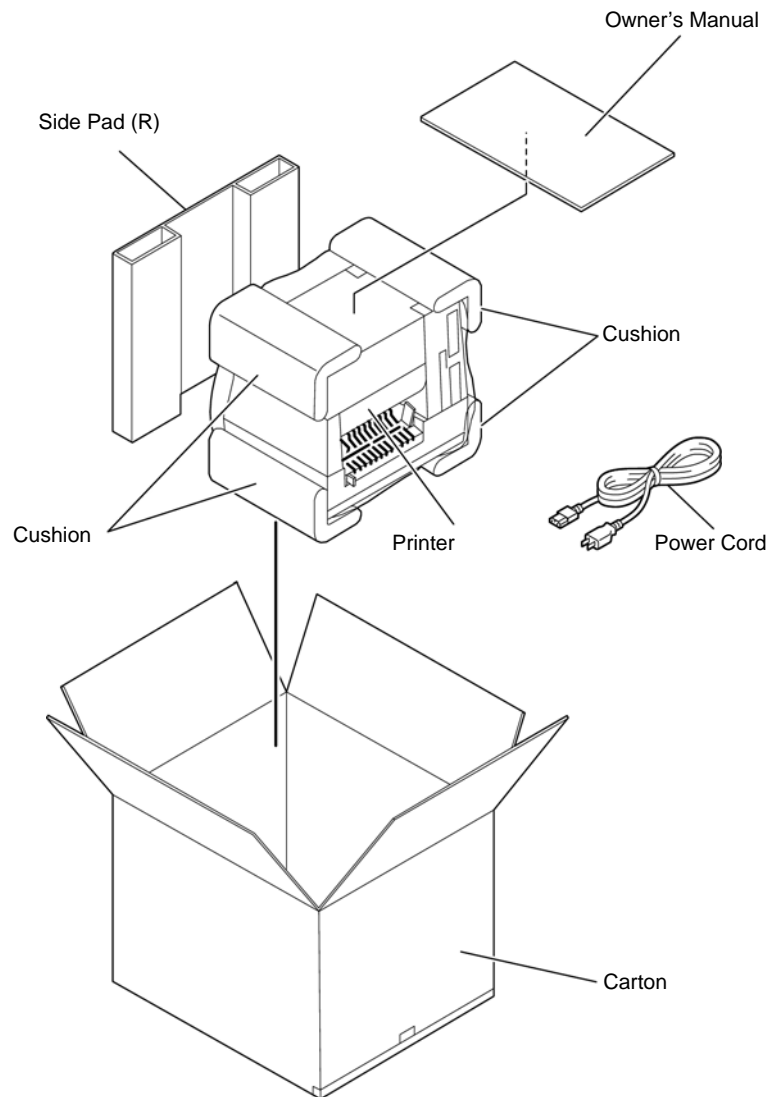

- 3) Place the printer on a level surface.

1.2 CHECKS

Check for damage or scratches on the printer.

NOTE: Keep the carton, pads and cushions for later transport.

2. MAJOR UNIT REPLACEMENT

WARNING!

Disconnect power cord before replacing important parts.

■ Lubrication

CAUTION: 1) *Lubrication: During parts replacement.*
2) *Kinds of oil: 1Kg can. (Part No. 19454906001).*

Any machine is generally in its best condition when delivered; therefore, it is necessary to try to keep this condition. Unexpected failure occurs due to lack of oil, debris or dust. To keep its best condition, periodically clean the machine and apply proper kinds of oil to each part in which lubrication is needed. Although the frequency of lubrication varies according to how much the machine is used, at least it is necessary to lubricate before the machine becomes dry. It is also necessary to wipe off excessive oil as it collects dirt.

CAUTION: *Do not spray the inside of the printer with lubricants. Unsuitable oil can damage the mechanism.*

2.1 REPLACING THE CPU PC BOARD

- 1) Open the Top Cover.
- 2) Remove the two PT-3x10 screws to detach the Side Cover L.

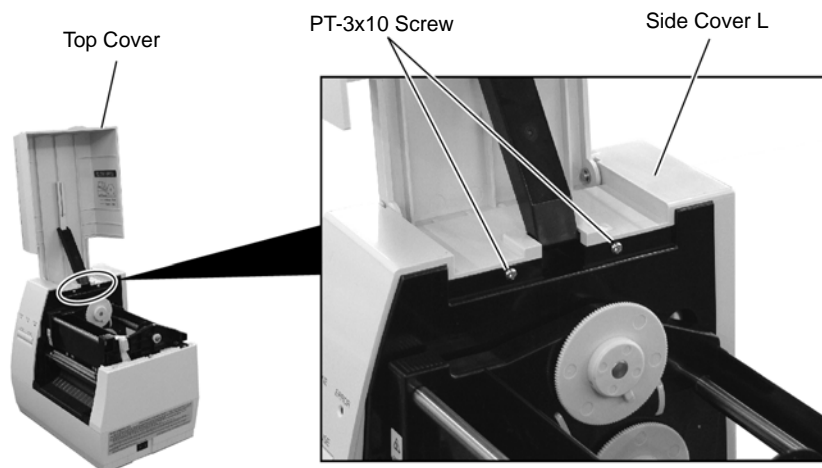

- 3) Disconnect KEY/LED Harness from connector CN13 on the CPU PC Board.

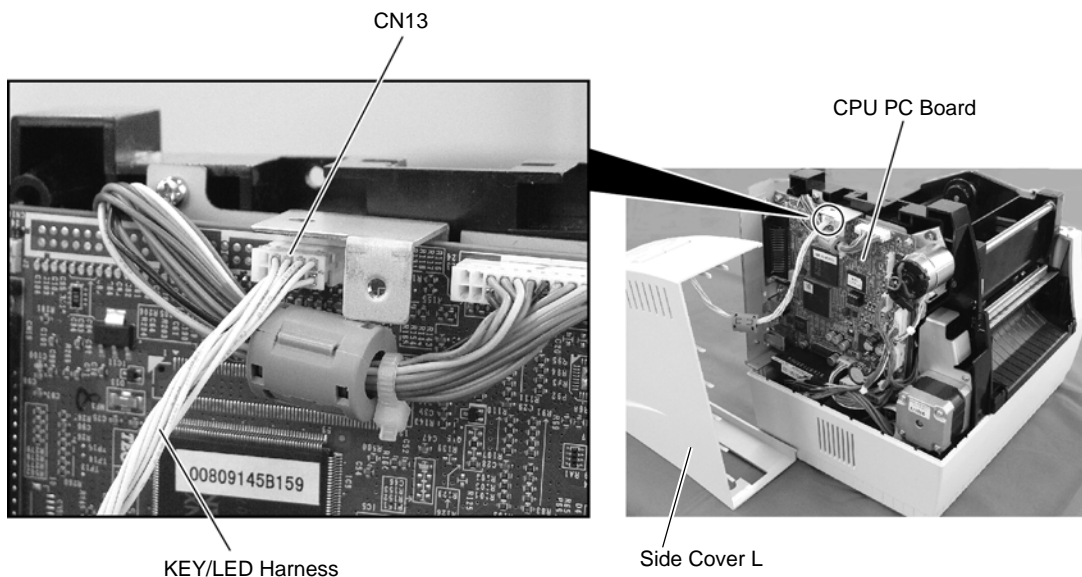

- 4) Remove the PT-3x10 screw and detach the Side Cover R from the printer.

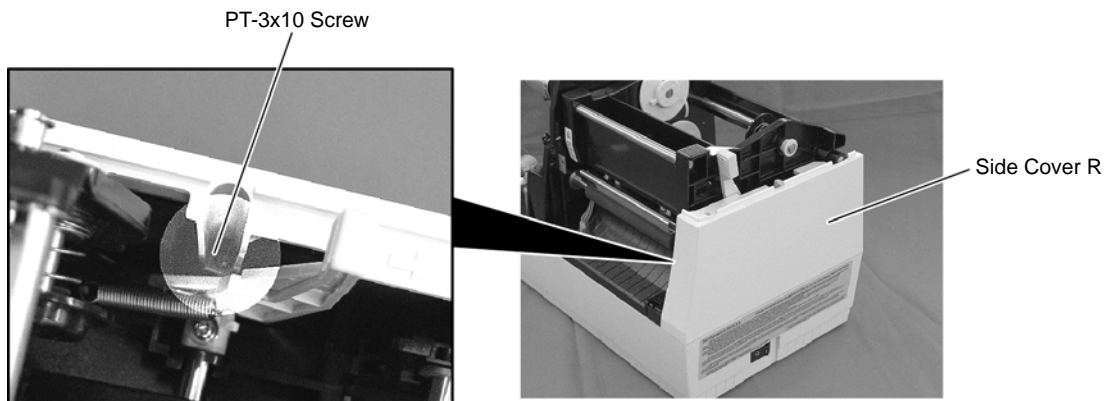

- 5) Disconnect the seven harnesses from CN1, CN2, CN5, CN8 to CN10, and CN500 on the CPU PC Board.
- 6) Remove the T-3x10 screw and the Ground Wire to detach the CPU PC Board.

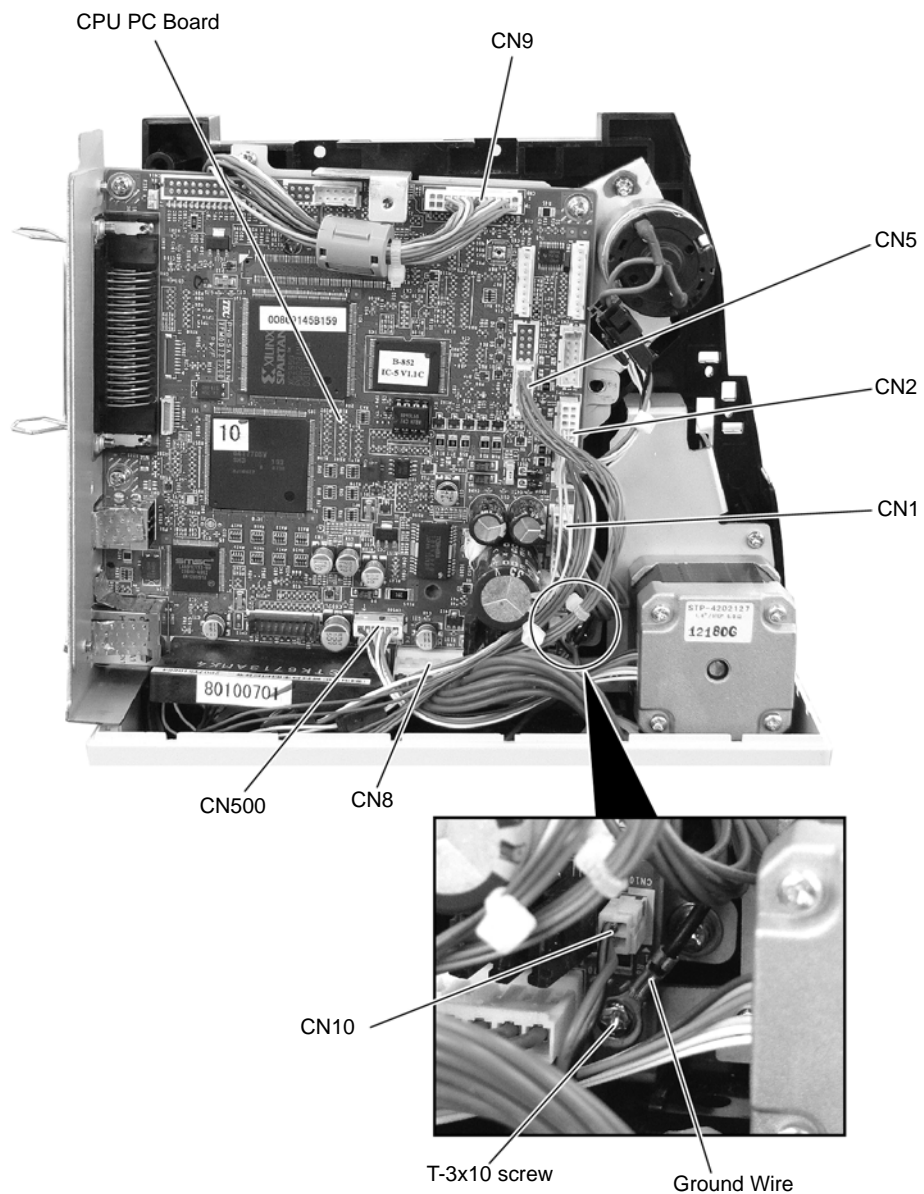

7) Release the two Hooks securing the Printer Unit.

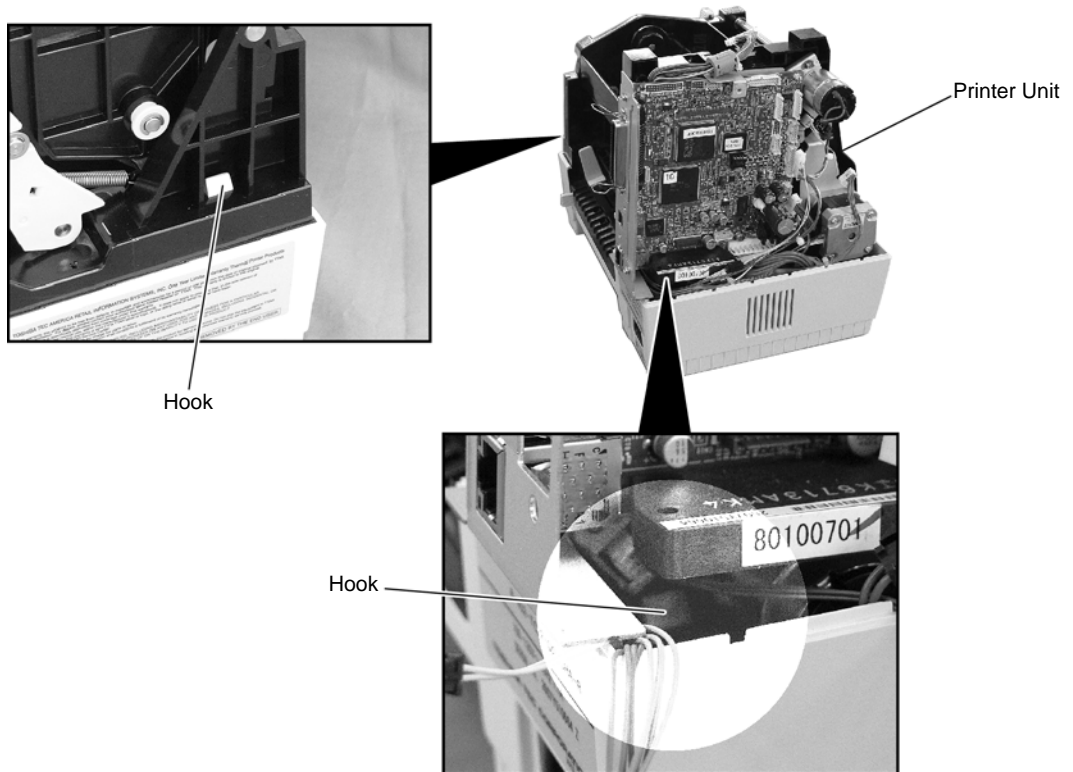

8) Detach the Printer Unit from the Bottom Cover.

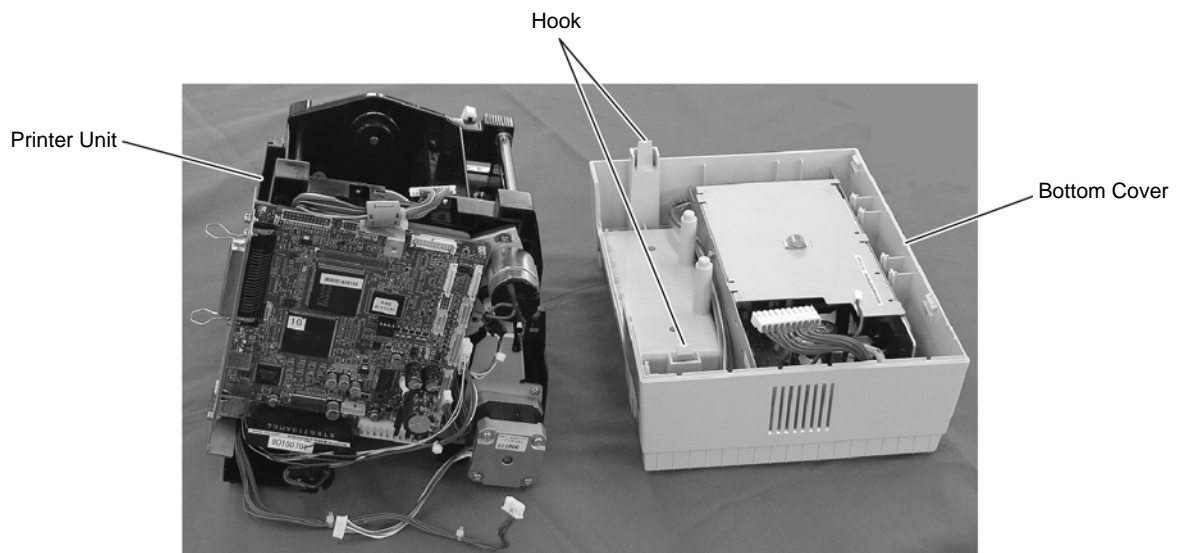

- 9) Remove the four screws (T-3x10 and SMW-3x6) and detach the CPU PC Board Ass'y from the Printer Block.

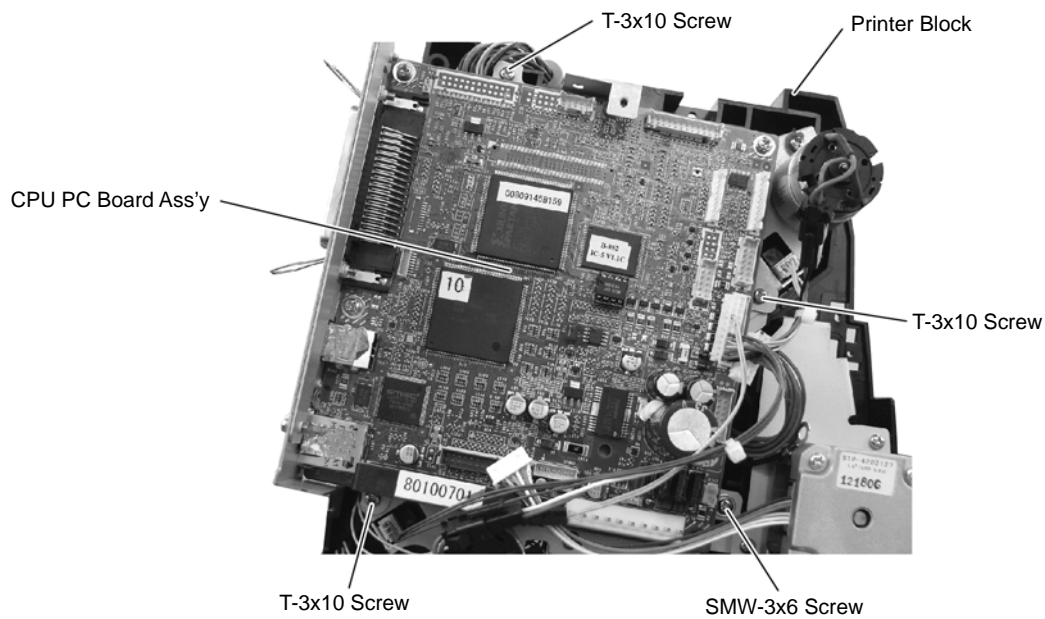

- 10) Remove the four screws (SMW-3x6 and P-3x6) and detach the CPU PC Board from the PC Board Attached Plate.

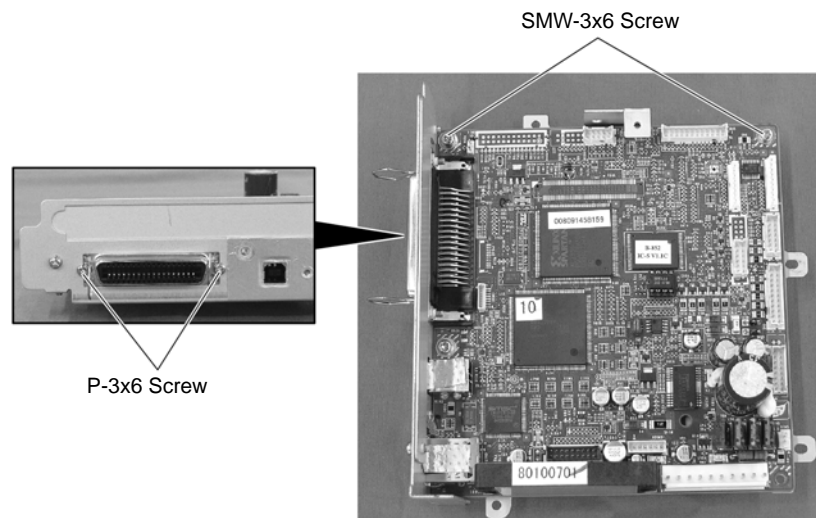

- 11) Remove the SMW-3x6 screw, N-3 Nut and Ground Plate.

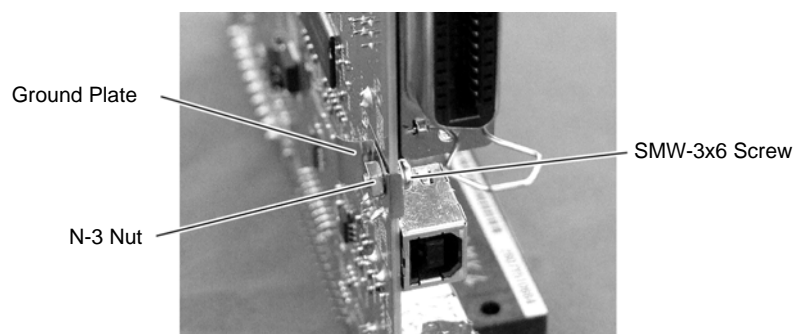

- 12) Replace the CPU PC Board with a new one, and then reassemble in the reverse order of removal.

2.2 REPLACING THE MOTOR

2.2.1 Ribbon Motor

- 1) Remove the CPU PC Board Ass'y. (Refer to Section 2-1)
- 2) Remove the two PT-3x10 screws and harnesses to detach the Ribbon Motor Attaching Plate.

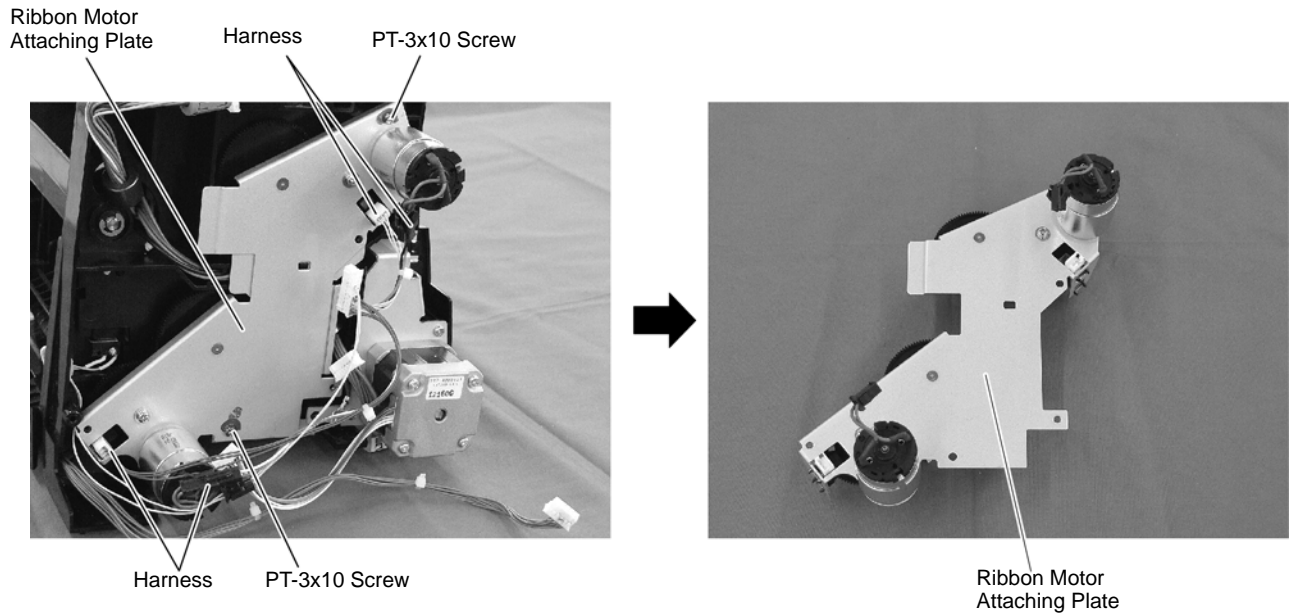

- 3) Remove the four SMW-2.6x6 screws to detach the two Ribbon Motors from the Ribbon Motor Attaching Plate.

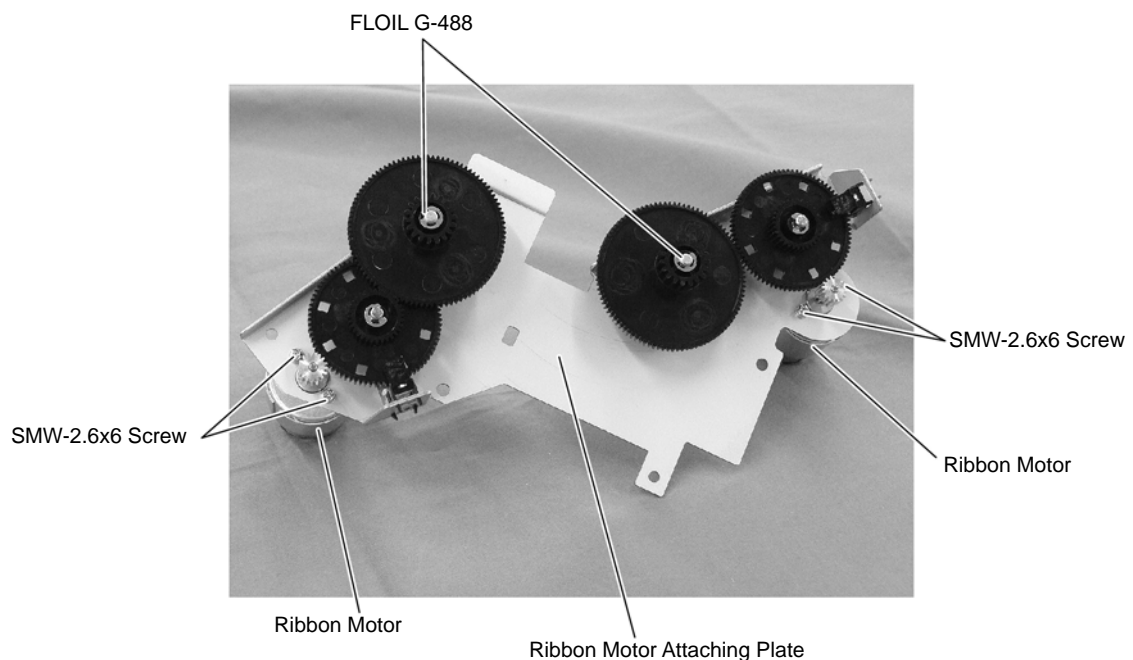

- 4) Replace the Ribbon Motors with new ones, and then reassemble in the reverse order of removal.

2.2.2 Stepping Motor

WARNING!

Be careful not to get burned when handling the stepping motor since it becomes very hot while printing.

- 1) Remove the CPU PC Board Ass'y. (Refer to Section 2.1)
- 2) Remove the two PT-3x10 screws to detach the Stepping Motor Ass'y.

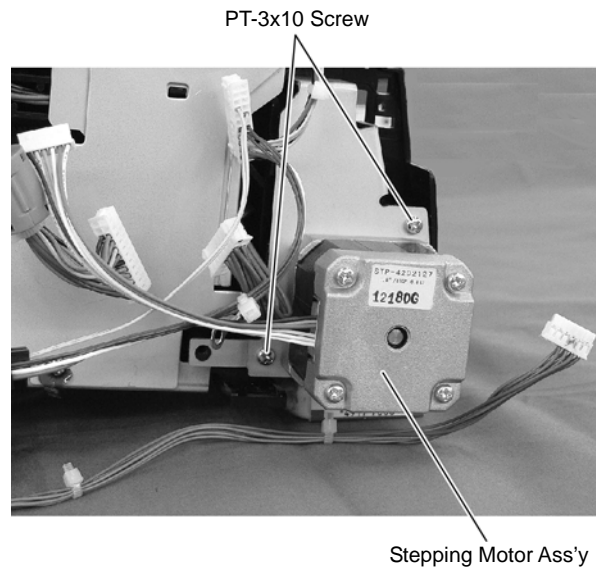

- 3) Remove the two SMW-3x6 screws to detach the Stepping Motor.

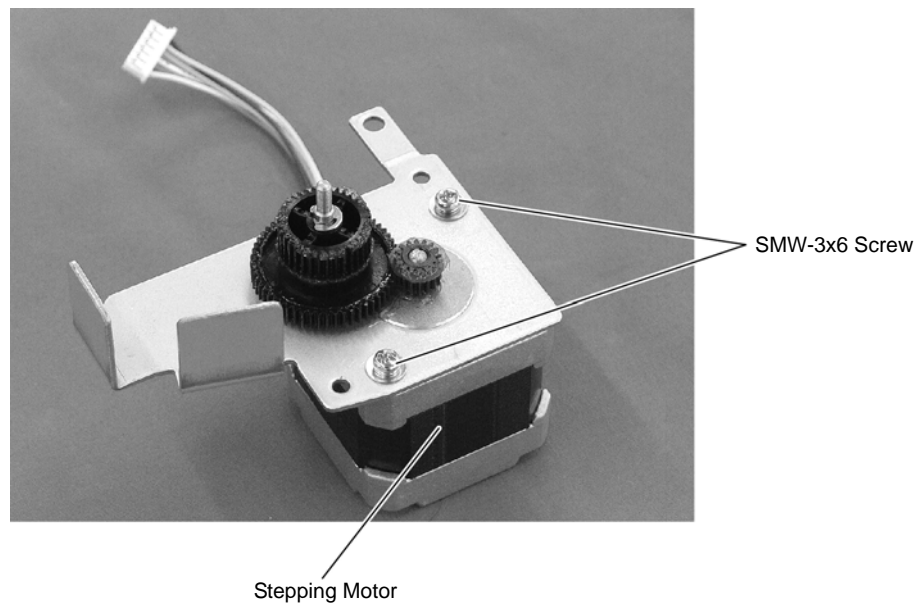

- 4) Replace the Stepping Motor with a new one, and then reassemble in the reverse order of removal.

2.3 REPLACING THE PS UNIT

WARNING!

Replace only with the same type and rated of fuse for continued protection against risk of fire.

- 1) Remove the Top Cover and Side Cover L. (Refer to Section 2.1)
- 2) Remove the PT-3x10 screw to detach the Side Cover R.

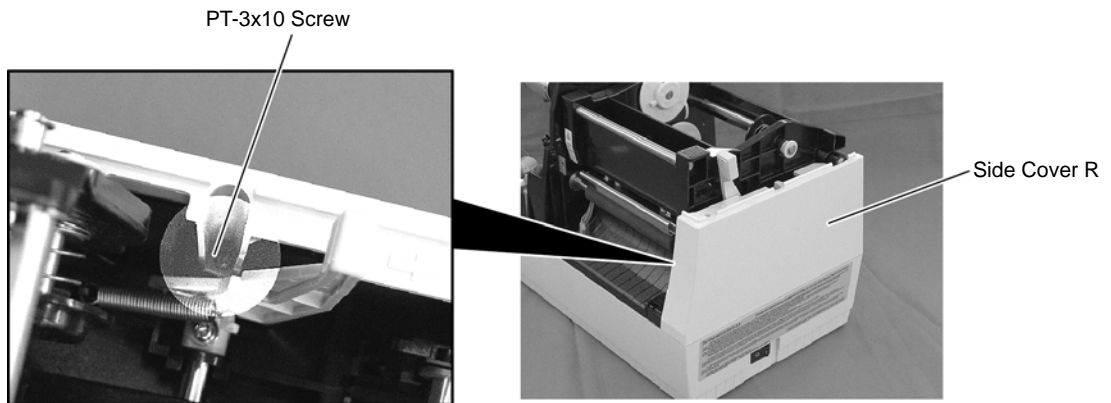

- 3) Disconnect the Power Harness and Fan Motor Harness from CN8 and CN10 on the CPU PC Board.

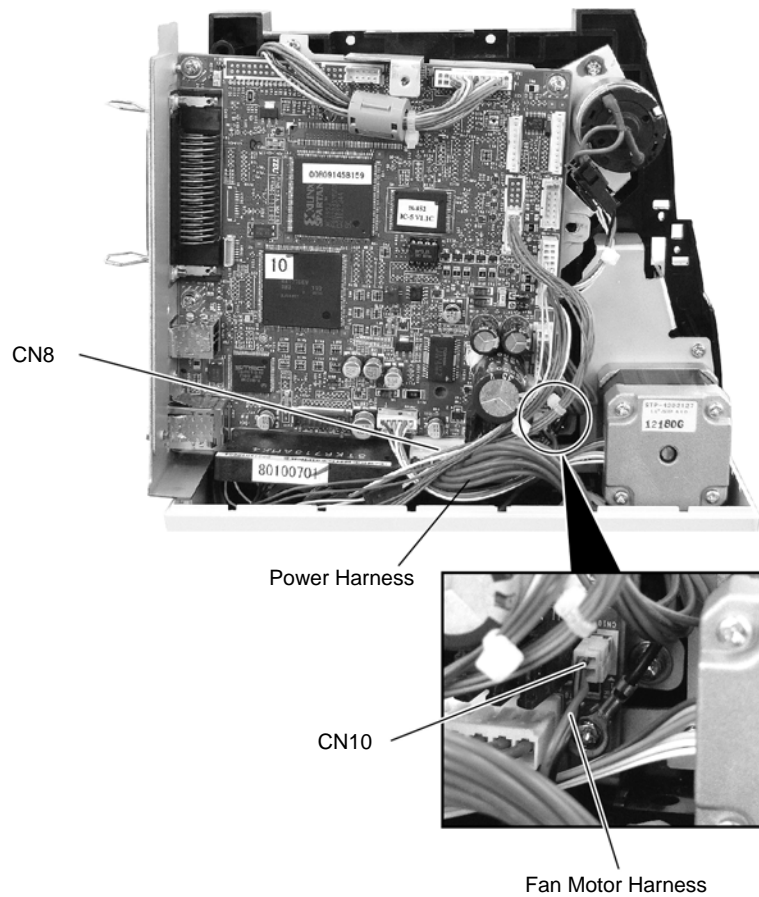

- 4) Release the two Hooks securing the Printer Unit.

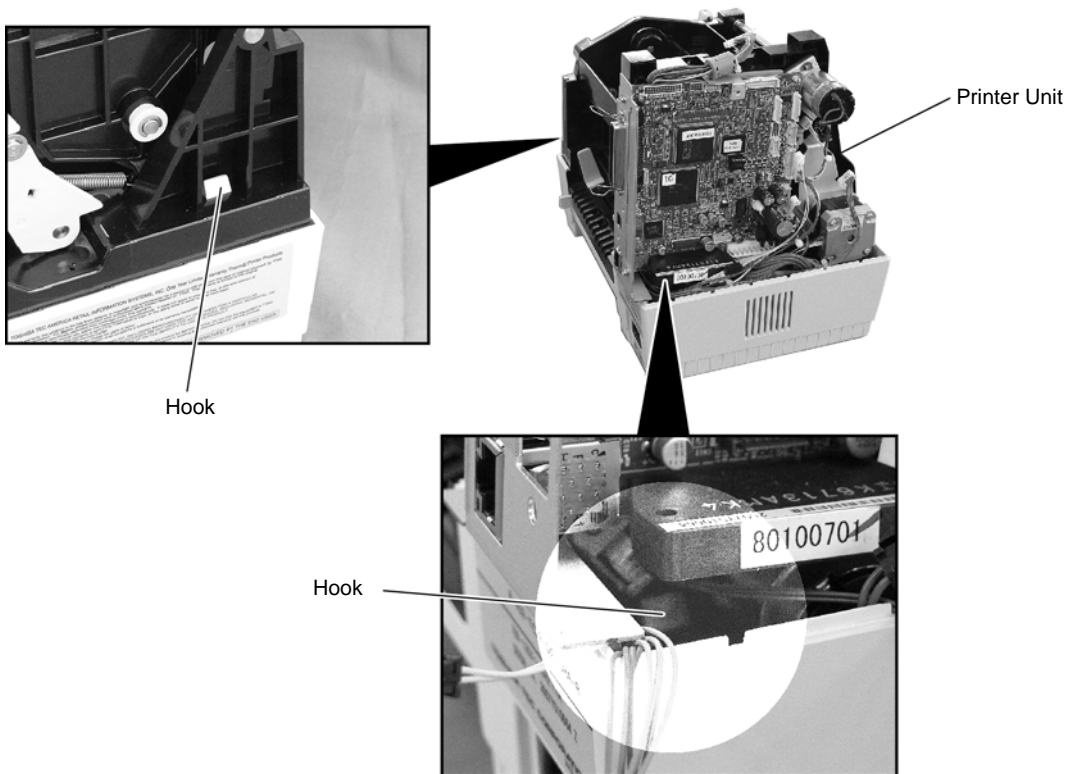

- 5) Detach the Printer Unit from the Bottom Cover.

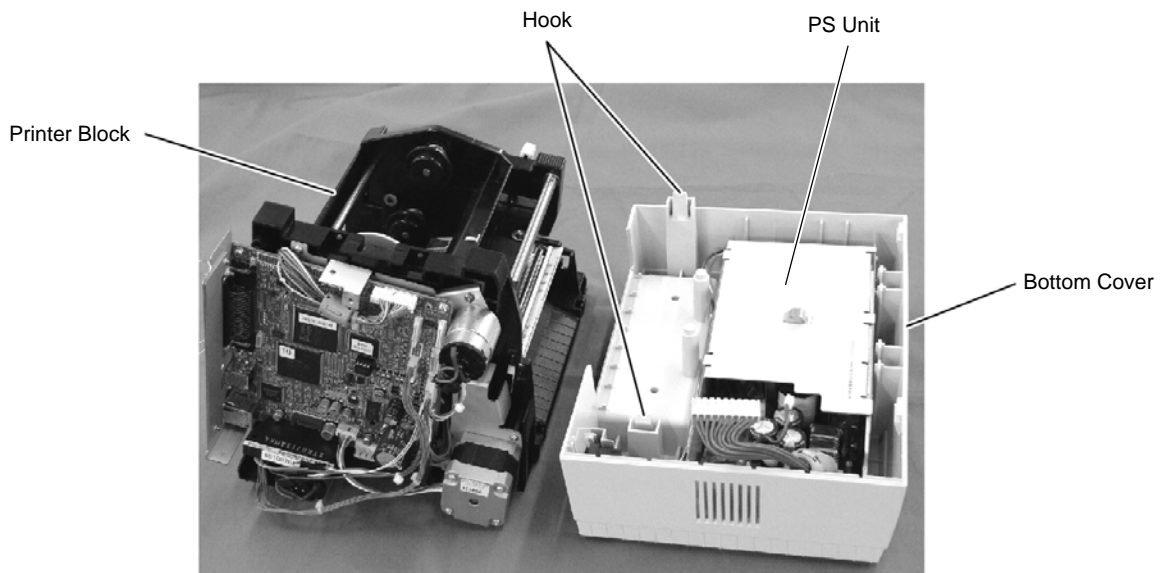

- 6) Detach the PS Unit from the Bottom Cover.

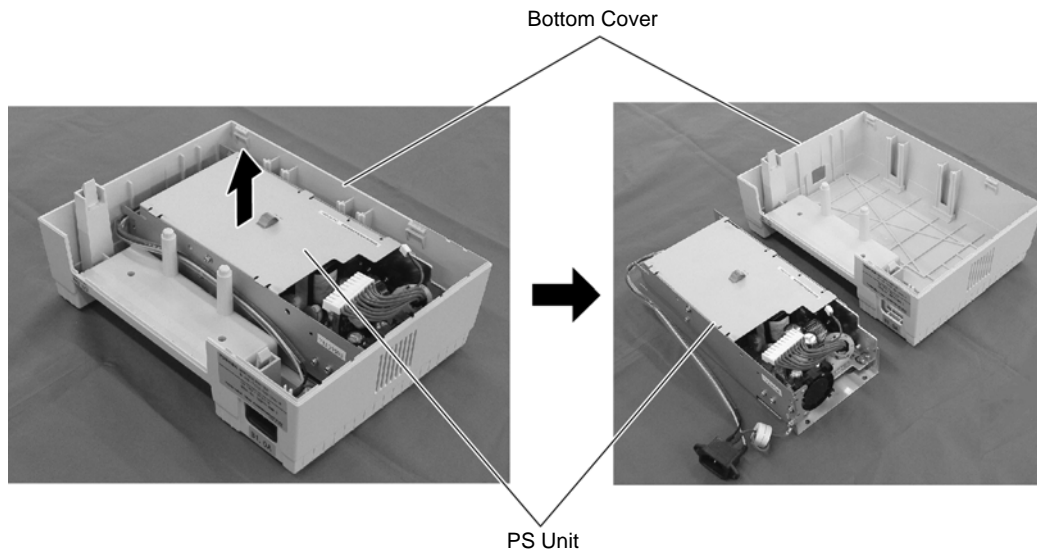

- 7) Replace the PS Unit as an assembly, then, reassemble in the reverse order of steps 1) to 6). To replace the Fan Motor, Power Harness, Inlet Ass'y, PSU Cover, etc. individually, follow the steps 8) to 12) provided below.

- 8) Remove the SMW-3x6, SMW-3x8, and D-3x5 screws to detach the PSU Cover from the PS Unit.

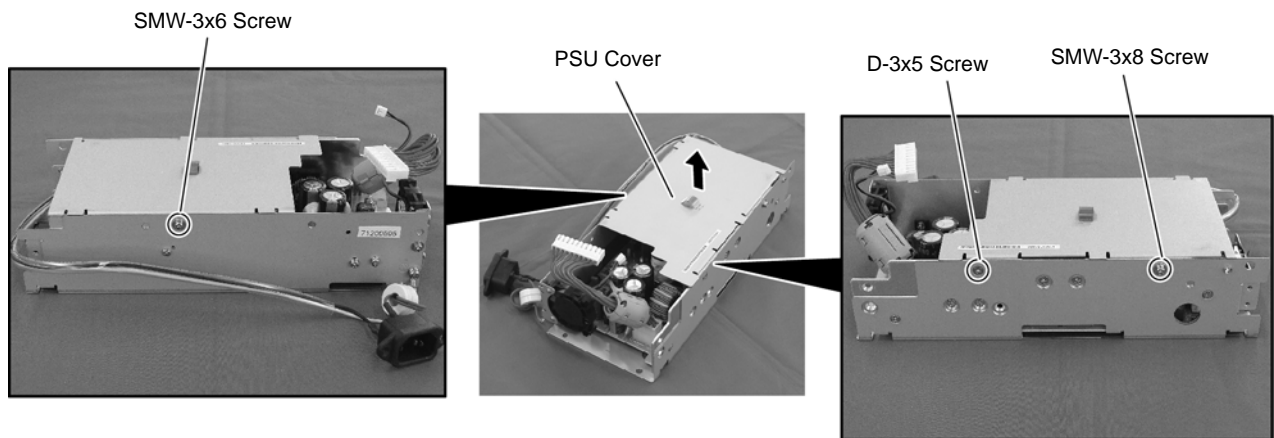

- 9) Disconnect the Power Harness from CN4 on the PS Unit. Remove the SMW-4x8 screw to release the Ground Wire of the Inlet Ass'y.

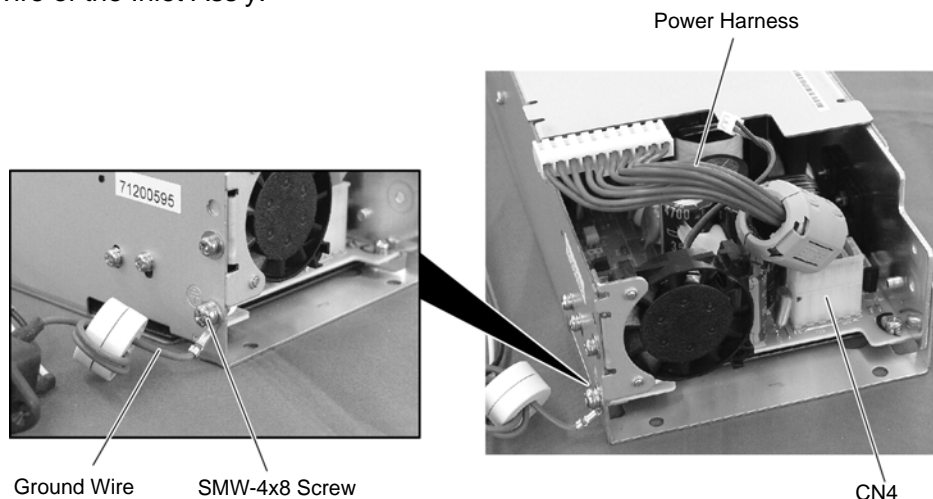

- 10) Push both sides of the Power Switch with something like pliers and remove it from the frame of the PS Unit. Disconnect the Inlet Ass'y from CN1 on the PS Unit.

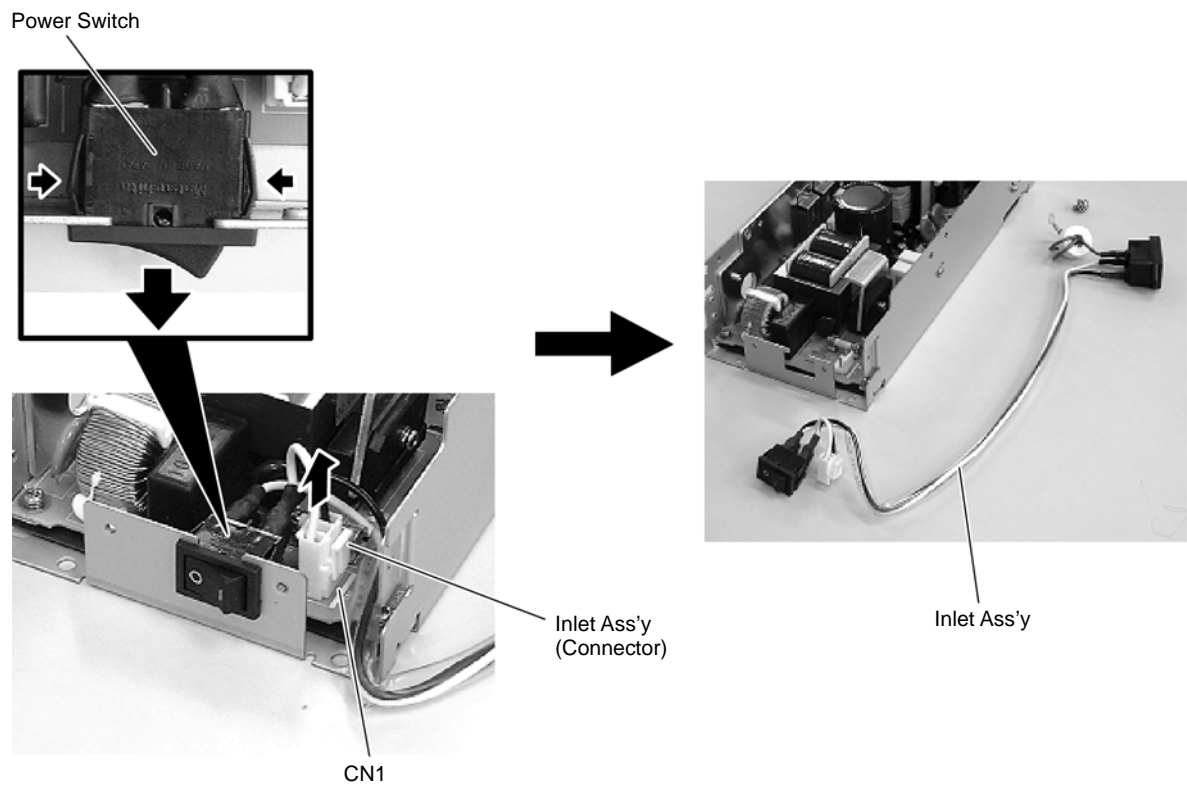

- 11) Remove the SMW-3x4 screw to detach the Fan Motor Attachment Plate from the PS Unit.

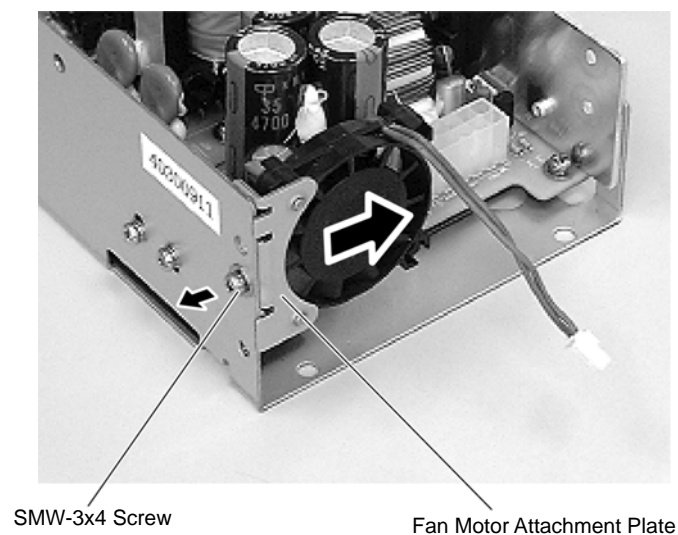

- 12) After replacing the individual part with a new one as necessary, reassemble in the reverse order of steps 8) to 11).

2.4 REPLACING THE PRINT HEAD

CAUTION: 1. NEVER touch the element when handling the print head.
2. NEVER touch the connector pins. Touching them may cause a static electric discharge which will damage the print head.

- 1) Open the Top Cover.
- 2) Push down the Head Release Lever R to open the Print Head Block.

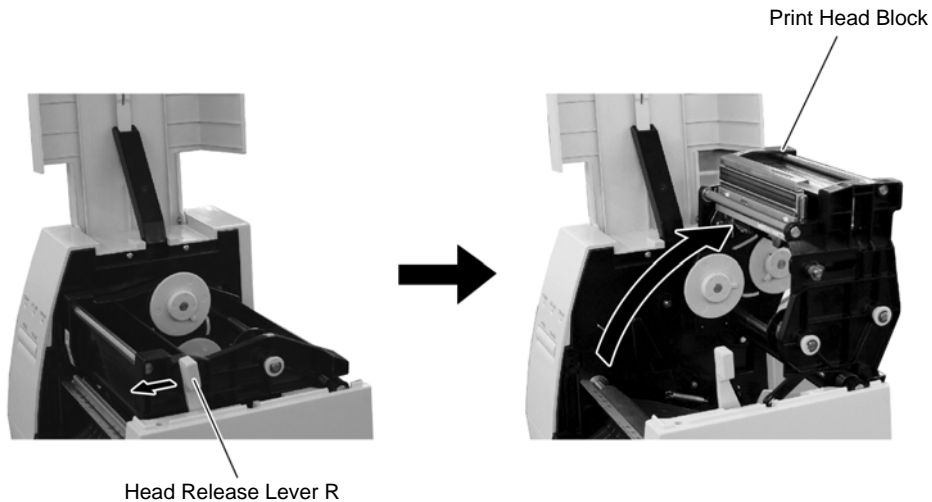

- 3) Disconnect the two Print Head Harnesses. Then, pull the Print Head Ass'y upward while pulling the Knob.

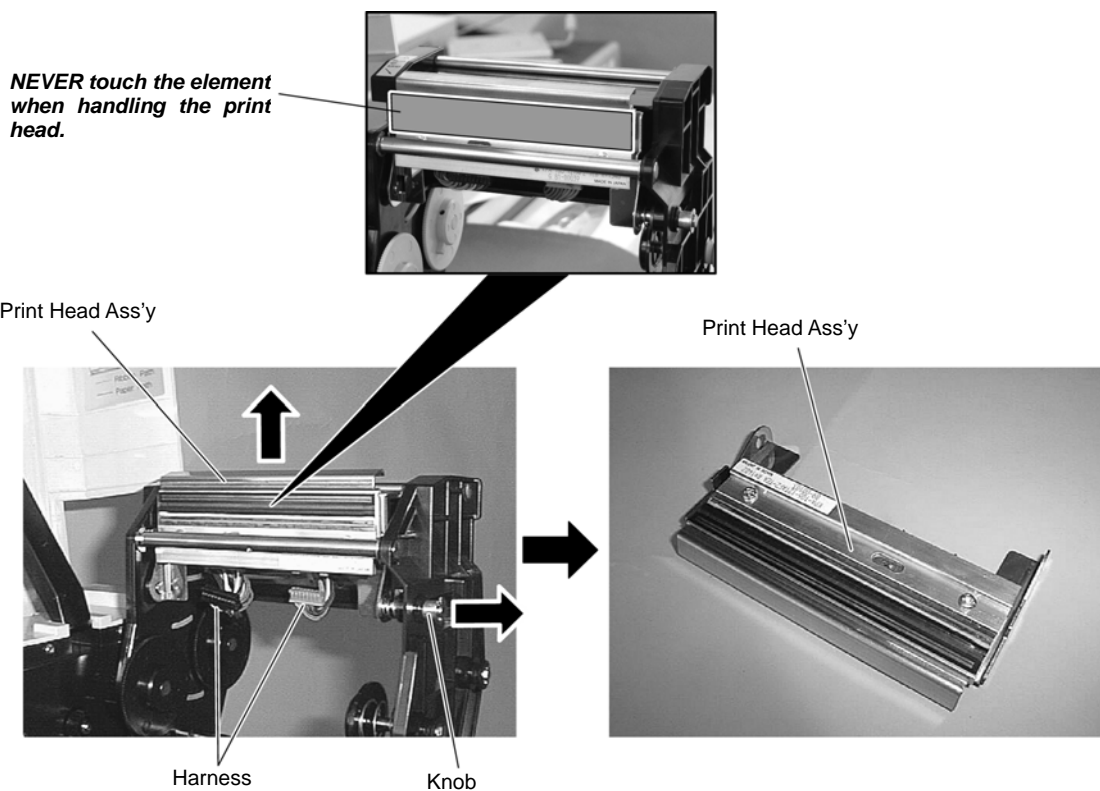

- 4) Replace the Print Head with a new one, and then reassemble in the reverse order of removal.

2.5 REPLACING THE MEDIA SENSOR

2.5.1 Replacing the Sensor PCB (TR)

- 1) Push down the Head Release Lever R to open the Print Head Block. (Refer to Section 2.4)
- 2) Remove the Sensor Holder from the Sensor Holder Arm.

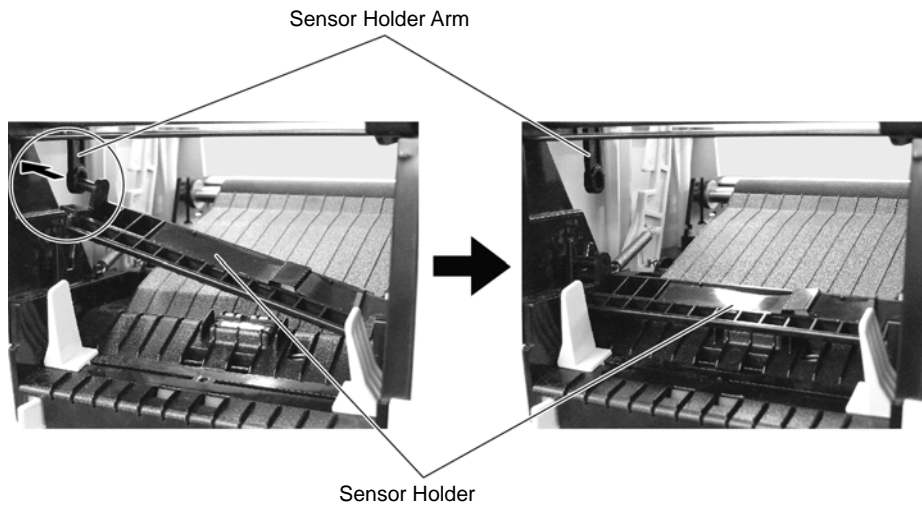

- 3) Remove the Sensor Cover Sheet from the Sensor Holder.

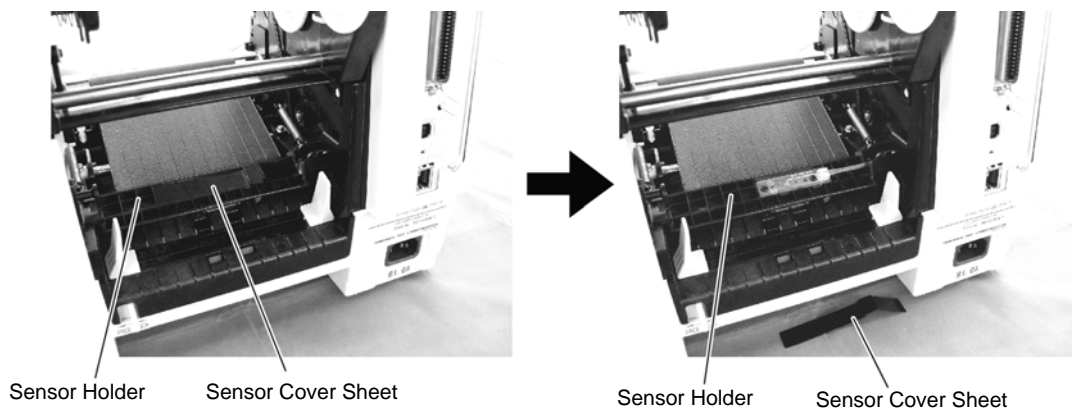

- 4) Release the Sensor Holder while spreading the tabs of the Sensor Holder. Be careful not to break the tabs when spreading them.

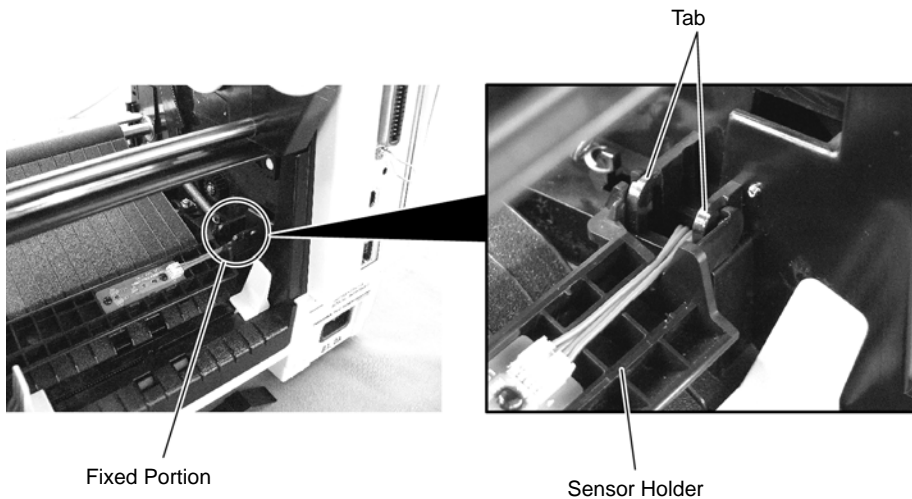

- 5) Disconnect the harness from the Sensor PCB (TR), and remove the Sensor PCB (TR) from the Sensor Holder by releasing the two Rivets.

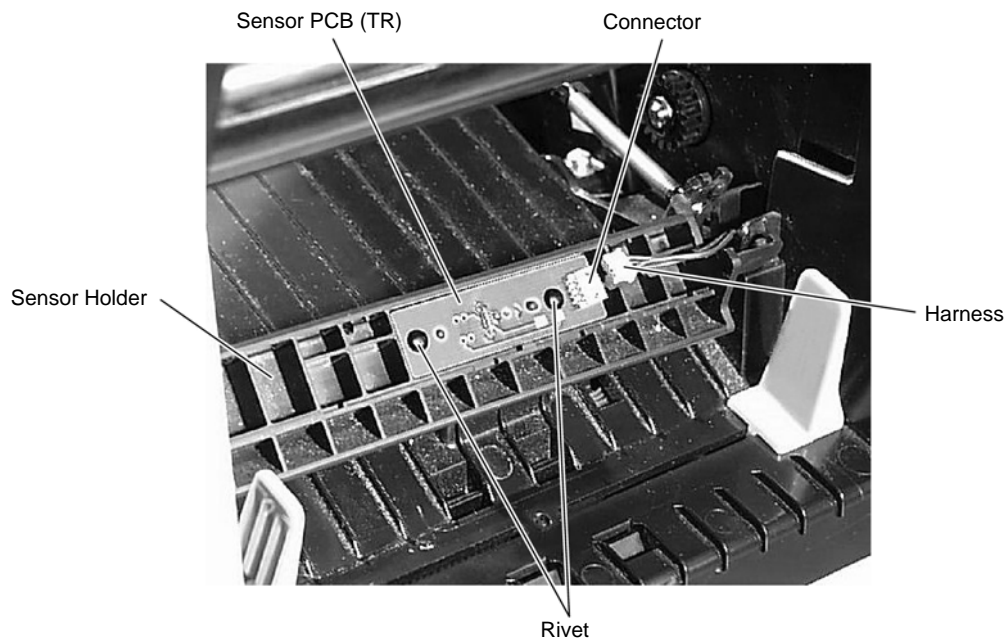

- 6) Replace the Sensor PCB (TR) with a new one, and then reassemble in the reverse order of removal.

2.5.2 Replacing the Sensor PCB (LED)

- 1) Open the Top Cover.
- 2) Remove the two PT-3x10 screws to detach the Side Cover L.

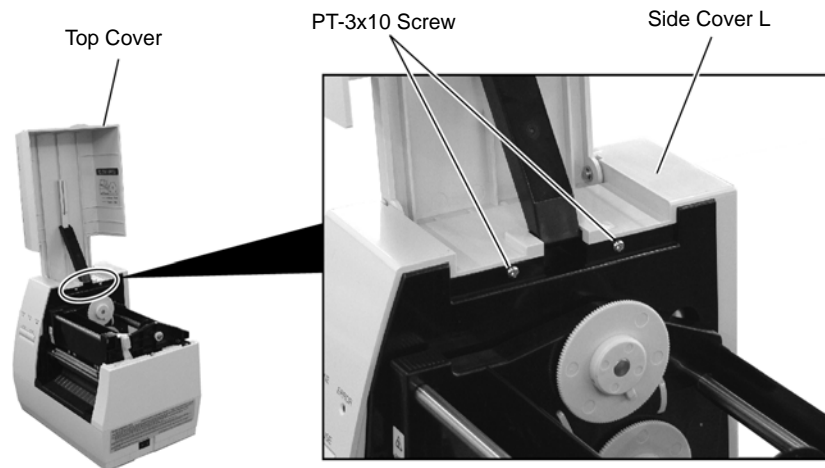

- 3) Disconnect KEY/LED Harness from connector CN13 on the CPU PC Board.

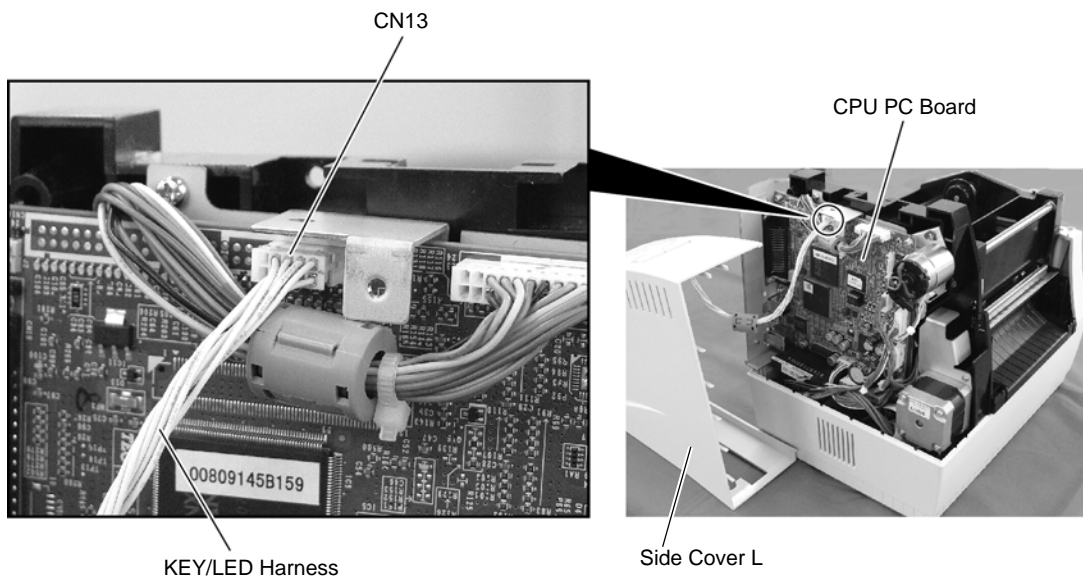

- 4) Remove the PT-3x10 screw and detach the Side Cover R from the printer.

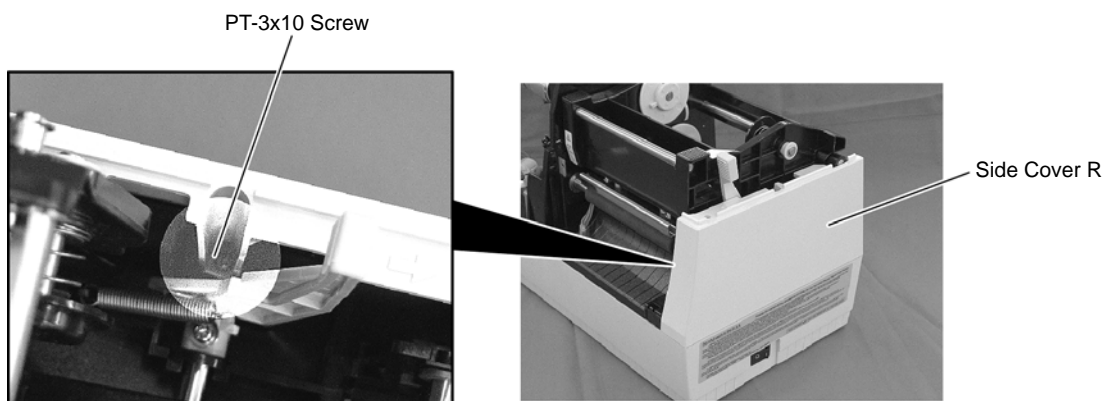

- 5) Disconnect the Power Harness and Fan Motor Harness from CN8 and CN10 on the CPU PC Board.

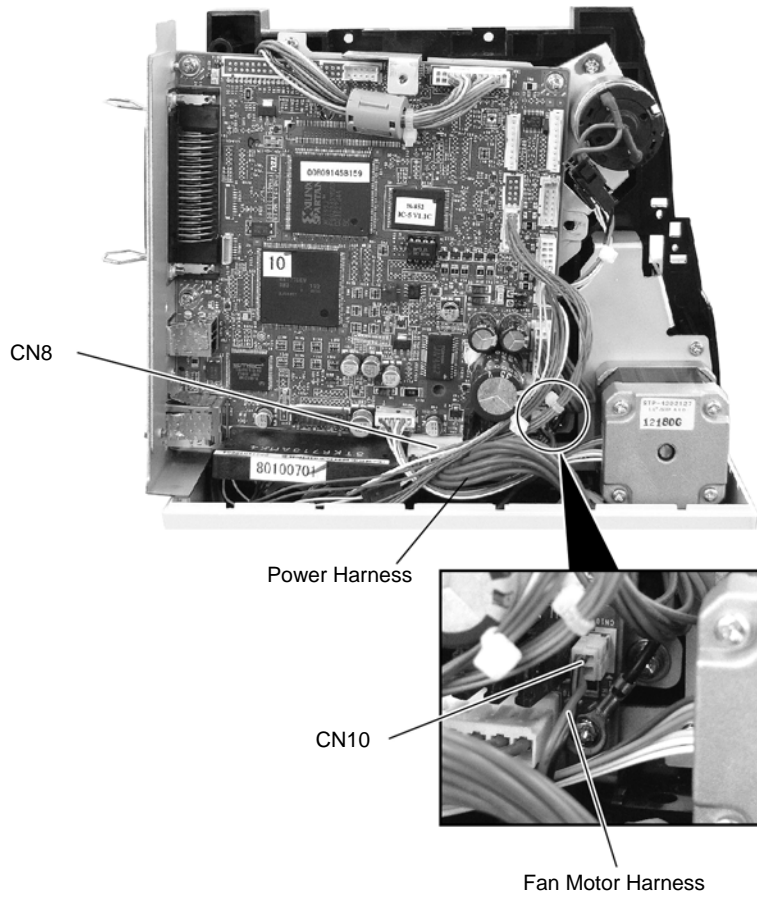

- 6) Release the two Hooks securing the Printer Unit.

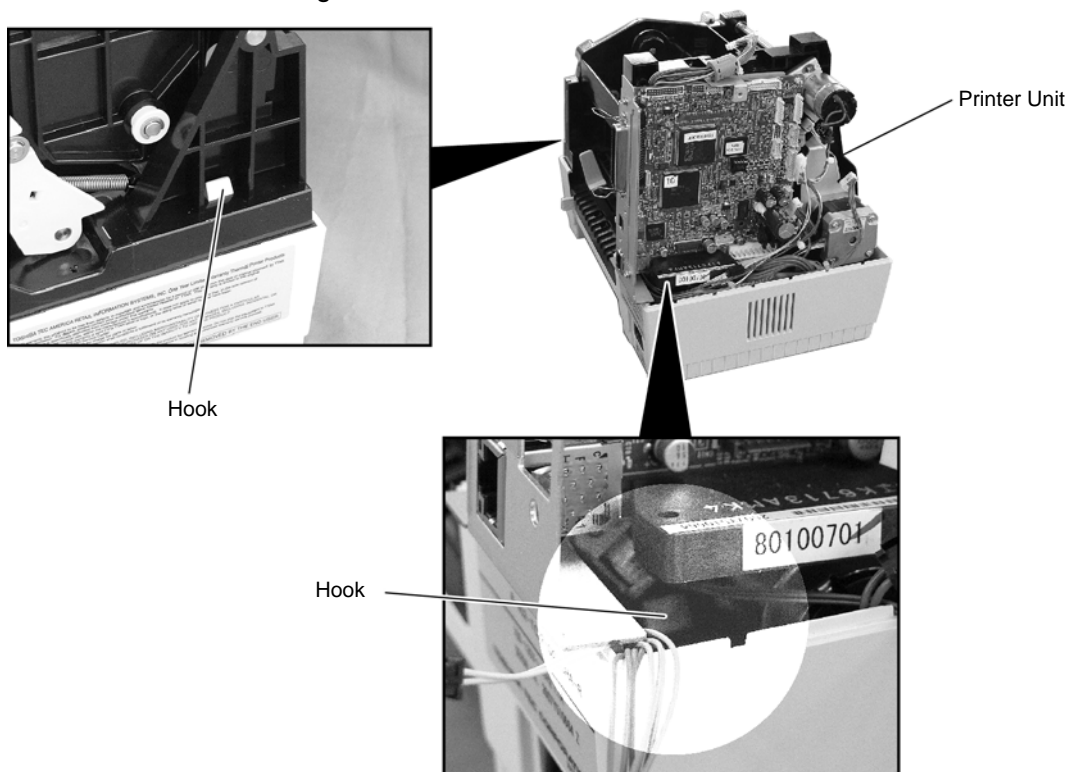

- 7) Detach the Printer Unit from the Bottom Cover.

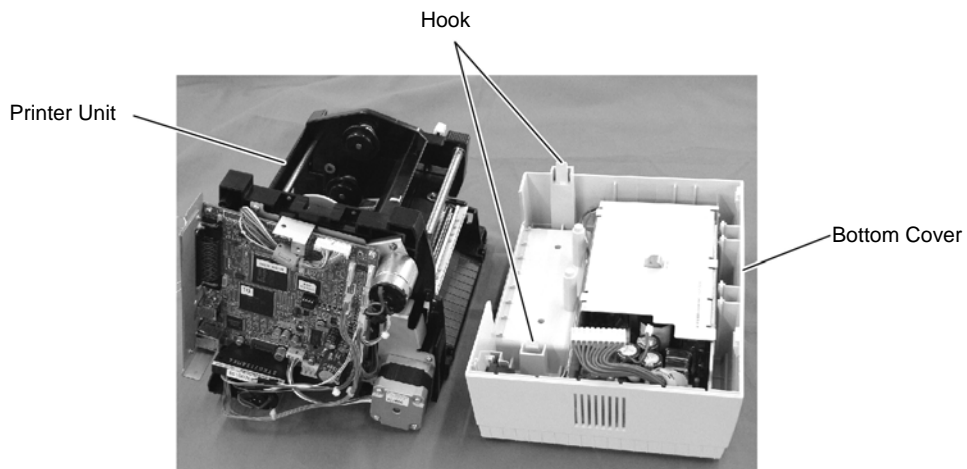

- 8) Disconnect the harness from the Sensor PCB (LED) which is attached to the bottom of the Printer Unit. Then remove the Rivet to detach the Sensor PCB (LED) from the Printer Unit.

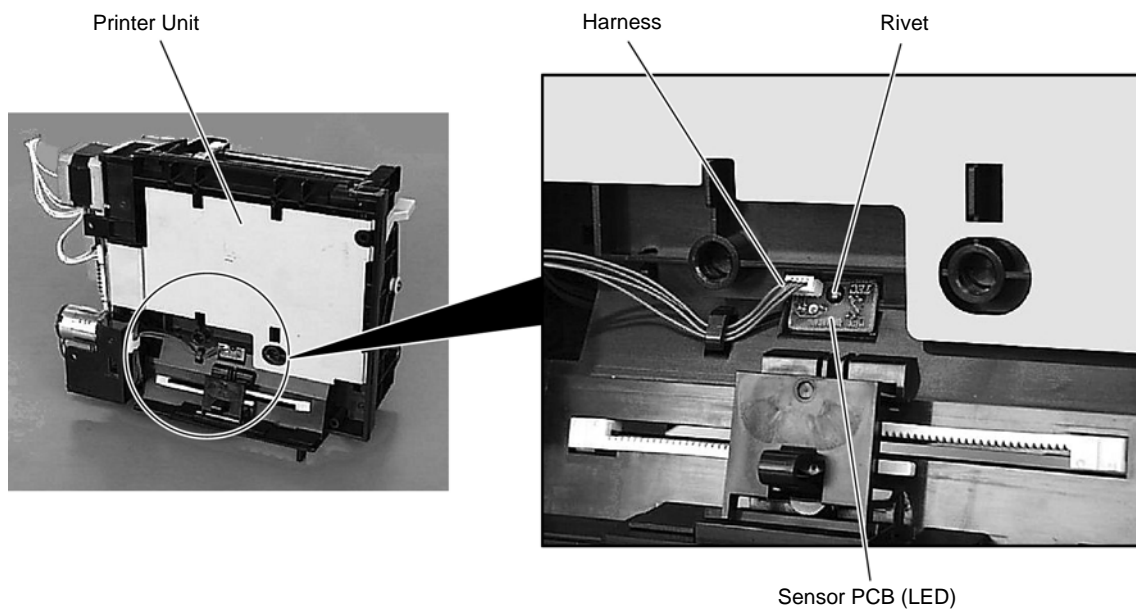

- 9) Replace the Sensor PCB (LED) with a new one, and then reassemble in the reverse order of removal.

3. TROUBLESHOOTING

Problems	Cause	Solution
Power is not turned ON.	<ol style="list-style-type: none"> 1. Input voltage to the printer is not within the rated voltage. 2. Output voltage from the printer is not within the rated voltage. 3. MAIN PC Board is not applied with voltage. 4. Failure of MAIN PC board. 	<ul style="list-style-type: none"> • Replace the power cord or power inlet. • Replace the PS unit. • Replace the power harness. • Replace the MAIN PC board.
LED does not light.	<ol style="list-style-type: none"> 1. Failure of the KEYLED PC board. 2. Failure of the KEYLED harness. 3. Failure of the MAIN PC board. 	<ul style="list-style-type: none"> • Replace the KEYLED PC board. • Replace the KEYLED harness. • Replace the MAIN PC board.
Poor printing.	<ol style="list-style-type: none"> 1. The print paper is of poor quality. 2. Dirty print head. 3. The head lever fastens the print head incompletely. 4. Alignment adjustment of the print head is improper. 	<ul style="list-style-type: none"> • Use the paper approved by TOSHIBA TEC. • Clean the print head. • Fasten the head lever completely. • Re-adjust the print head.
Printer does not print.	<ol style="list-style-type: none"> 1. Print head failure. 2. Connection of the print head connector is incomplete, a bad contact, or broken wires. 3. Failure of the MAIN PC board. 4. Failure of the software. 5. Failure of the printer cable. 	<ul style="list-style-type: none"> • Replace the print head. • Connect the harness completely, or replace the harness. • Replace the MAIN PC board. • Check the program. • Replace the printer cable.
Dot missing.	<ol style="list-style-type: none"> 1. Broken element of the print head. 2. Broken wires of the print head cable. 3. Failure of the MAIN PC board. 	<ul style="list-style-type: none"> • Replace the print head. • Replace the print head harness. • Replace the MAIN PC board.
Blurred print.	<ol style="list-style-type: none"> 1. Poor quality of paper. 2. Dust is attached to the paper. 	<ul style="list-style-type: none"> • Use only TOSHIBA TEC specified paper. • Clean the print head and remove the dust from the paper.
Label feed failure.	<ol style="list-style-type: none"> 1. Paper is not set properly. 2. Paper of poor quality. 3. Improper adjustment of the feed gap sensor or black mark sensor. 4. Failure of the feed gap sensor or blackmark sensor. 5. Labels cannot be stripped off the backing paper or the backing paper with labels cannot be would properly. 6. The cutter mechanism is not installed properly. 7. Failure of the stepping motor. 	<ul style="list-style-type: none"> • Set the paper properly. • Use the paper approved by TOSHIBA TEC. • Re-adjust the sensor. • Replace the feed gap sensor or black mark sensor. • Replace the take-up motor or black mark sensor. • Install the cutter mechanism properly. • Replace the stepping motor or MAIN PC board.
Communication error.	<ol style="list-style-type: none"> 1. Failure of the communication cable. 2. Failure of the RS-232C interface. 3. Failure of the communication connector. 4. Failure of the PC or application software. 5. Failure of the MAIN PC board. 	<ul style="list-style-type: none"> • Replace the cable. • Replace the serial I/F Board. • Replace the connector. • Modify the program. • Replace the MAIN PC board.

Free Manuals Download Website

<http://myh66.com>

<http://usermanuals.us>

<http://www.somanuals.com>

<http://www.4manuals.cc>

<http://www.manual-lib.com>

<http://www.404manual.com>

<http://www.luxmanual.com>

<http://aubethermostatmanual.com>

Golf course search by state

<http://golfingnear.com>

Email search by domain

<http://emailbydomain.com>

Auto manuals search

<http://auto.somanuals.com>

TV manuals search

<http://tv.somanuals.com>