

# **TOSHIBA**

TOSHIBA Barcode Printer

## **B-852 SERIES**

**Owner's Manual**  
**Mode d'emploi**  
**Bedienungsanleitung**  
**Manual de instrucciones**  
**Gebruikershandleiding**  
**Manuale Utente**  
**Manual do Utilizador**



## CE Compliance (for EU only)

This product complies with the requirements of EMC and Low Voltage Directives including their amendments.

### **VORSICHT:**

- *Schallemission: unter 70dB (A) nach DIN 45635 (oder ISO 7779)*
- *Die für das Gerät Vorgesehene Steckdose muß in der Nähe des Gerätes und leicht zugänglich sein.*

Centronics is a registered trademark of Centronics Data Computer Corp.  
Microsoft is a registered trademark of Microsoft Corporation.  
Windows is a trademark of Microsoft Corporation.

This equipment has been tested and found to comply with the limits for a Class A digital device, pursuant to Part 15 of the FCC Rules. These limits are designed to provide reasonable protection against harmful interference when the equipment is operated in a commercial environment. This equipment generates, uses, and can radiate radio frequency energy and, if not installed and used in accordance with the instruction manual, may cause harmful interference to radio communications. Operations of this equipment in a residential area is likely to cause harmful interference in which case the user will be required to correct the interference at his own expense.

(for USA only)

Changes or modifications not expressly approved by manufacturer for compliance could void the user's authority to operate the equipment.

"This Class A digital apparatus meets all requirements of the Canadian Interference-Causing Equipment Regulations."

"Cet appareil numérique de la classe A respecte toutes les exigences du Règlement sur le matériel brouilleur du Canada."

(for CANADA only)

# **TOSHIBA**

TOSHIBA Barcode Printer

## **B-852 SERIES**

### **Owner's Manual**

**Waste Recycling information for users:**

Following information is only for EU-member states:

The use of the crossed-out wheeled bin symbol indicates that this product may not be treated as general household waste.

By ensuring this product is disposed of correctly you will help prevent potential negative consequences for the environment and human health, which could otherwise be caused by inappropriate waste handling of this product. For more detailed information about the take-back and recycling of this product, please contact your supplier where you purchased the product.



## Safety Summary

Personal safety in handling or maintaining the equipment is extremely important. Warnings and Cautions necessary for safe handling are included in this manual. All warnings and cautions contained in this manual should be read and understood before handling or maintaining the equipment.

Do not attempt to effect repairs or modifications to this equipment. If a fault occurs that cannot be rectified using the procedures described in this manual, turn off the power, unplug the machine, then contact your authorised TOSHIBA TEC representative for assistance.

### Meanings of Each Symbol



This symbol indicates warning items (including cautions). Specific warning contents are drawn inside the  $\Delta$  symbol. (The symbol on the left indicates a general caution.)



This symbol indicates prohibited actions (prohibited items). Specific prohibited contents are drawn inside or near the  $\odot$  symbol. (The symbol on the left indicates “no disassembling”.)



This symbol indicates actions which must be performed. Specific instructions are drawn inside or near the  $\bullet$  symbol. (The symbol on the left indicates “disconnect the power cord plug from the outlet”.)



### WARNING

This indicates that there is the risk of **death** or **serious injury** if the machines are improperly handled contrary to this indication.



Any other than the specified AC voltage is prohibited.

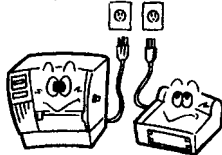

Do not use voltages other than the voltage (AC) specified on the rating plate, as this may cause **fire** or **electric shock**.



Prohibited



Do not plug in or unplug the power cord plug with wet hands as this may cause **electric shock**.



Prohibited



If the machines share the same outlet with any other electrical appliances that consume large amounts of power, the voltage will fluctuate widely each time these appliances operate. Be sure to provide an exclusive outlet for the machine as this may cause **fire** or **electric shock**.



Prohibited



Do not place metal objects or water-filled containers such as flower vases, flower pots or mugs, etc. on top of the machines. If metal objects or spilled liquid enter the machines, this may cause **fire** or **electric shock**.



Prohibited



Do not insert or drop metal, flammable or other foreign objects into the machines through the ventilation slits, as this may cause **fire** or **electric shock**.



Prohibited



Do not scratch, damage or modify the power cords. Also, do not place heavy objects on, pull on, or excessively bend the cords, as this may cause **fire** or **electrical shock**.



Disconnect the plug.









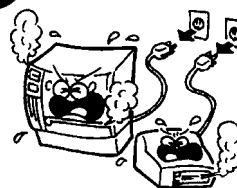

If the machines are dropped or their cabinets damaged, first turn off the power switches and disconnect the power cord plugs from the outlet, and then contact your authorised TOSHIBA TEC representative for assistance. Continued use of the machine in that condition may cause **fire** or **electric shock**.



Disconnect the plug.



Continued use of the machines in an abnormal condition such as when the machines are producing smoke or strange smells may cause **fire** or **electric shock**. In these cases, immediately turn off the power switches and disconnect the power cord plugs from the outlet. Then, contact your authorised TOSHIBA TEC representative for assistance.

 <p>Disconnect the plug.</p> 	<p>If foreign objects (metal fragments, water, liquids) enter the machines, first turn off the power switches and disconnect the power cord plugs from the outlet, and then contact your authorised TOSHIBA TEC representative for assistance. Continued use of the machine in that condition may cause <b>fire</b> or <b>electric shock</b>.</p>	 <p>Disconnect the plug.</p> 	<p>When unplugging the power cords, be sure to hold and pull on the plug portion. Pulling on the cord portion may cut or expose the internal wires and cause <b>fire</b> or <b>electric shock</b>.</p>
 <p>Connect a grounding wire.</p> 	<p>Ensure that the equipment is properly grounded. Extension cables should also be grounded. <b>Fire</b> or <b>electric shock</b> could occur on improperly grounded equipment.</p>	 <p>No disassembling.</p> 	<p>Do not remove covers, repair or modify the machine by yourself. You may be <b>injured</b> by high voltage, very hot parts or sharp edges inside the machine.</p>



**CAUTION**

This indicates that there is the risk of personal **Injury** or **damage** to objects if the machines are improperly handled contrary to this indication.

**Precautions**

The following precautions will help to ensure that this machine will continue to function correctly.

- Try to avoid locations that have the following adverse conditions:
  - \* Temperatures out of the specification
  - \* Shared power source
- \* Direct sunlight
- \* Excessive vibration
- \* High humidity
- \* Dust/Gas
- The cover should be cleaned by wiping with a dry cloth or a cloth slightly dampened with a mild detergent solution. **NEVER USE THINNER OR ANY OTHER VOLATILE SOLVENT** on the plastic covers.
- **USE ONLY TOSHIBA TEC SPECIFIED** paper and ribbons.
- **DO NOT STORE** the paper or ribbons where they might be exposed to direct sunlight, high temperatures, high humidity, dust, or gas.
- Ensure the printer is operated on a level surface.
- Any data stored in the memory of the printer could be lost during a printer fault.
- Try to avoid using this equipment on the same power supply as high voltage equipment or equipment likely to cause mains interference.
- Unplug the machine whenever you are working inside it or cleaning it.
- Keep your work environment static free.
- Do not place heavy objects on top of the machines, as these items may become unbalanced and fall causing **injury**.
- Do not block the ventilation slits of the machines, as this will cause heat to build up inside the machines and may cause **fire**.
- Do not lean against the machine. It may fall on you and could cause **injury**.
- Care must be taken not to injure yourself with the printer paper cutter.
- Unplug the machine when it is not used for a long period of time.
- Place the machine on a stable and level surface.

**Request Regarding Maintenance**

- Utilize our maintenance services.  
After purchasing the machine, contact your authorised TOSHIBA TEC representative for assistance once a year to have the inside of the machine cleaned. Otherwise, dust will build up inside the machines and may cause a **fire** or a **malfunction**. Cleaning is particularly effective before humid rainy seasons.
- Our preventive maintenance service performs the periodic checks and other work required to maintain the quality and performance of the machines, preventing accidents beforehand.  
For details, please consult your authorised TOSHIBA TEC representative for assistance.
- Using insecticides and other chemicals  
Do not expose the machines to insecticides or other volatile solvents. This will cause the cabinet or other parts to deteriorate or cause the paint to peel.

## TABLE OF CONTENTS

	Page
<b>1. PRODUCT OVERVIEW.....</b>	<b>E1-1</b>
1.1 Introduction.....	E1-1
1.2 Features .....	E1-1
1.3 Unpacking.....	E1-1
1.4 Accessories .....	E1-2
1.5 Appearance .....	E1-3
1.5.1 Dimensions.....	E1-3
1.5.2 Front View .....	E1-3
1.5.3 Rear View .....	E1-3
1.5.4 Operation Panel.....	E1-4
1.5.5 Interior .....	E1-4
1.6 Options .....	E1-5
<b>2. PRINTER SETUP .....</b>	<b>E2-1</b>
2.1 Installation .....	E2-2
2.2 Assembling the Accessories.....	E2-3
2.3.1 Assembling the Supply Holder Frame .....	E2-3
2.3 Connecting the Power Cord .....	E2-4
2.4 Loading the Media .....	E2-5
2.4.1 Installing the Media onto the Supply Holder Unit.....	E2-5
2.4.2 Installing the Supply Holder onto the Supply Holder Frame .....	E2-7
2.4.3 Loading Media into the Printer.....	E2-7
2.5 Setting Sensor Positions .....	E2-10
2.5.1 Setting the Feed Gap Sensor .....	E2-10
2.5.2 Setting the Black Mark Sensor .....	E2-10
2.6 Loading the Ribbon .....	E2-11
2.7 Connecting the Cables to Your Printer .....	E2-12
2.8 Turning the Printer ON/OFF .....	E2-13
2.8.1 Turning ON the Printer .....	E2-13
2.8.2 Turning OFF the Printer.....	E2-13
2.9 Setting an Operating Environment .....	E2-14
2.9.1 Parameter Setting.....	E2-15
2.9.2 Dump Mode Setting.....	E2-27
2.9.3 BASIC Expansion Mode.....	E2-29
2.9.4 Automatic Calibration .....	E2-30
2.9.5 LAN Setting .....	E2-31
2.9.6 Real Time Clock Setting.....	E2-32
2.9.7 IP Address Setting (TCP/IP).....	E2-34
2.10 Installing the Printer Drivers .....	E2-40
2.10.1 Introduction.....	E2-40
2.10.2 General Description.....	E2-40
2.10.3 Installing the Printer Driver .....	E2-41
2.10.4 Uninstalling the Printer Driver .....	E2-54
2.10.5 Adding/Deleting a LAN Port.....	E2-55
2.10.6 Cautions .....	E2-57
2.10.7 Using the Printer Driver .....	E2-58
2.11 Test Print .....	E2-59
2.12 Position and Print Tone Fine Adjustment .....	E2-61
2.13 Threshold Setting .....	E2-68

<b>3. ON LINE MODE</b> .....	<b>E3-1</b>
3.1 Operation Panel.....	E3-1
3.2 Operation.....	E3-2
3.3 Reset.....	E3-2
<b>4. MAINTENANCE</b> .....	<b>E4-1</b>
4.1 Cleaning .....	E4-1
4.1.1 Print Head/Platen/Sensors .....	E4-1
4.1.2 Covers and Panels .....	E4-2
4.1.3 Optional Cutter Module.....	E4-2
<b>5. TROUBLESHOOTING</b> .....	<b>E5-1</b>
5.1 Error Messages .....	E5-1
5.2 Possible Problems.....	E5-3
5.3 Removing Jammed Media.....	E5-5
<b>6. PRINTER SPECIFICATIONS</b> .....	<b>E6- 1</b>
<b>7. SUPPLY SPECIFICATIONS</b> .....	<b>E7- 1</b>
7.1 Media.....	E7- 1
7.1.1 Media Type.....	E7- 1
7.1.2 Detection Area of the Transmissive Sensor .....	E7- 2
7.1.3 Detection Area of the Reflective Sensor.....	E7- 2
7.1.4 Effective Print Area.....	E7- 3
7.2 Ribbon .....	E7- 4
7.3 Recommended Media and Ribbon Types .....	E7- 4
7.4 Care/Handling of Media and Ribbon .....	E7- 5
<b>APPENDIX 1 MESSAGES AND LEDS</b> .....	<b>EA1-1</b>
<b>APPENDIX 2 INTERFACE</b> .....	<b>EA2-1</b>
<b>APPENDIX 3 PRINT SAMPLES</b> .....	<b>EA3-1</b>
<b>APPENDIX 4 GLOSSARIES</b> .....	<b>EA4-1</b>
<b>INDEX</b>	

**WARNING!**

*This is a Class A product. In a domestic environment this product may cause radio interference in which case the user may be required to take adequate measures.*

**CAUTION!**

- 1. This manual may not be copied in whole or in part without prior written permission of TOSHIBA TEC.*
- 2. The contents of this manual may be changed without notification.*
- 3. Please refer to your local Authorised Service representative with regard to any queries you may have in this manual.*



# 1. PRODUCT OVERVIEW

## 1.1 Introduction

Thank you for choosing the TOSHIBA B-852 series label/tag printer. This Owner's Manual contains from general set-up through how to confirm the printer operation using a test print, and should be read carefully to help gain maximum performance and life from your printer. For most queries please refer to this manual and keep it safe for future reference. Please contact your TOSHIBA TEC representative for further information concerning this manual.

## 1.2 Features

The B-852 printer has the following features:

- A 8.3 inch wide print head is installed in such a compact body that the size of the printer body (except the Supply Holder Unit) is about 1/3 of the B-SX6T or B-SX8T printer.
- The print head block which can be fully opened realizes great operability.
- Various kinds of media can be used since the black mark sensors are located above and under the media passage, respectively, and the media sensors can be moved from the center to the left edge of the media.
- When the optional interface board is installed, Web functions such as remote maintenance and other advanced network functions are available.
- Superior hardware, including the specially developed 11.8 dots/mm (300 dots/inch) thermal print head which will allow very clear print at a printing speed of 50.8 mm/sec. (2 inches/sec.) or 101.6 mm/sec. (4 inches/sec.).
- Besides the optional cutter module, there is also an optional Expansion I/O Interface Board, Serial Interface Board, Wireless LAN Board, and Real Time Clock.

## 1.3 Unpacking

Unpack the printer as per the Unpacking Instructions supplied with the printer.

**NOTES:**

- *Check for damage or scratches on the printer. However, please note that TOSHIBA TEC shall have no liability for any damage of any kind sustained during transportation of the product.*
- *Keep the cartons and pads for future transportation of the printer.*

### 1.4 Accessories

When unpacking the printer, please make sure all accessories are supplied with the printer.

- Start-up CD-ROM (1 pc.)



<Contents>

- Bar code print application (Bartender ultra lite)
- Windows Driver
- Owner's Manual
- Specifications (Programming, Key operation, etc.)
- Product information (Catalogue)

- Power Cord QQ (1 pc.)

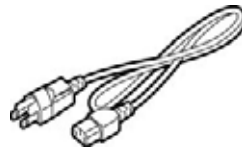

- Power Cord QP (1 pc.)

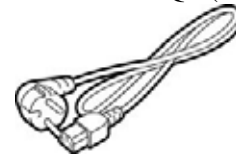

- Print Head Cleaner (1 pc.)



- Supply Holder Unit (1 pc.)



**CAUTION!**  
 Be sure to use TOSHIBA  
 TEC approved print head  
 cleaner. Failure to do this  
 may shorten the print head  
 life.

- Supply Holder Frame (L)  
(1 pc.)



- Supply Holder Frame (R)  
(1 pc.)



- Supply Holder Base (1 pc.)



- Wing Bolt M-4x6 (2 pcs.)

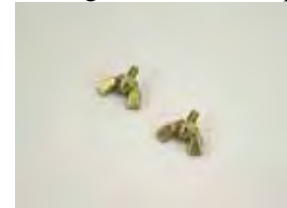

- Cable Clamp (1 pc.)



- Screw (1 pc.)



- Supply Loading Instructions  
(1 sheet)

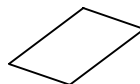

- Safety Precautions  
(1 sheet)

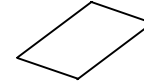

- Quality Control Report  
(1 sheet) (QQ)

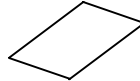

- Warranty Disclaimer Sheet  
(1sheet) (QQ)

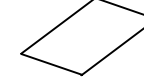

## 1.5 Appearance

The names of the parts or units introduced in this section are used in the following chapters.

### 1.5.1 Dimensions

**NOTE:**  
 Depth is 470 mm (18.5 inches) when the optional Cutter Module is installed on the printer.

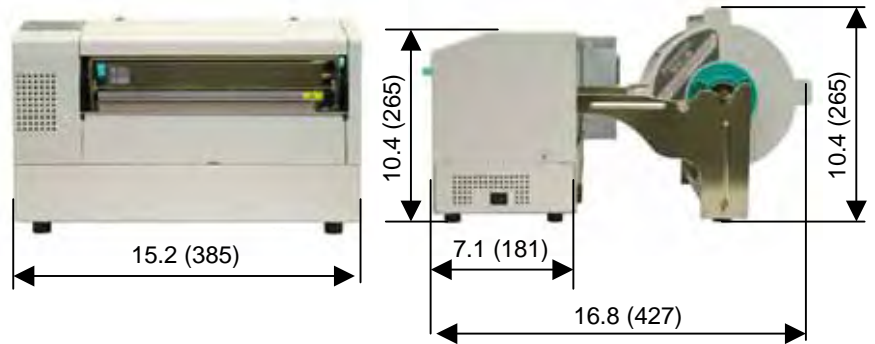

Dimensions in inches +(mm)

### 1.5.2 Front View

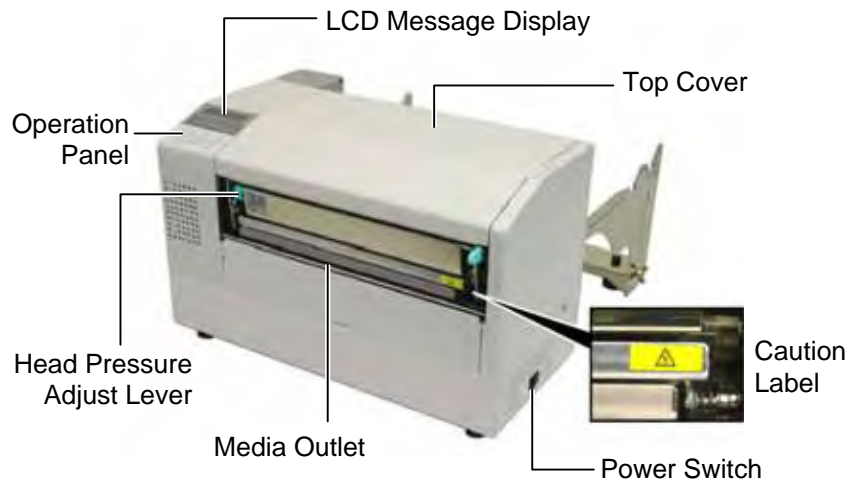

### 1.5.3 Rear View

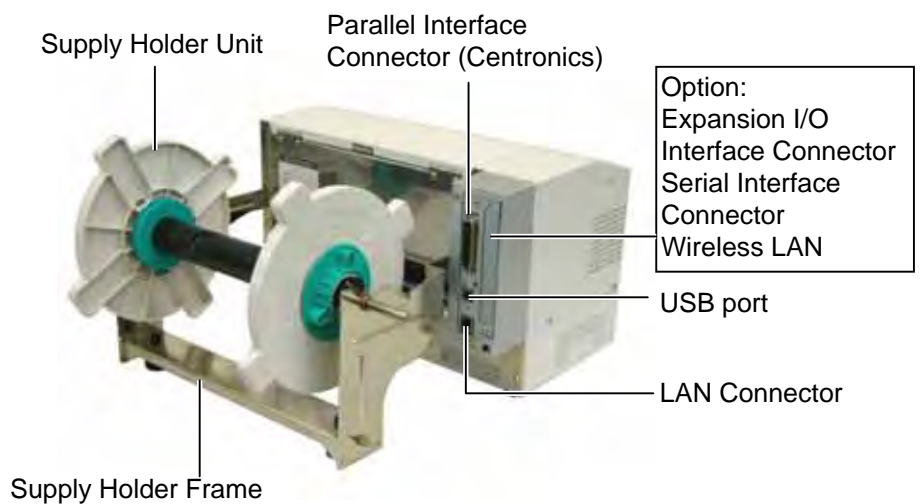

### 1.5.4 Operation Panel

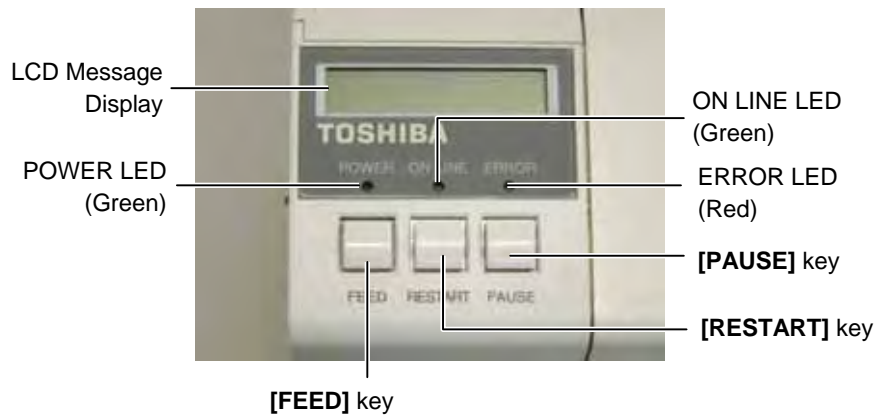

Please see **Section 3.1** for further information about the Operation Panel.

### 1.5.5 Interior

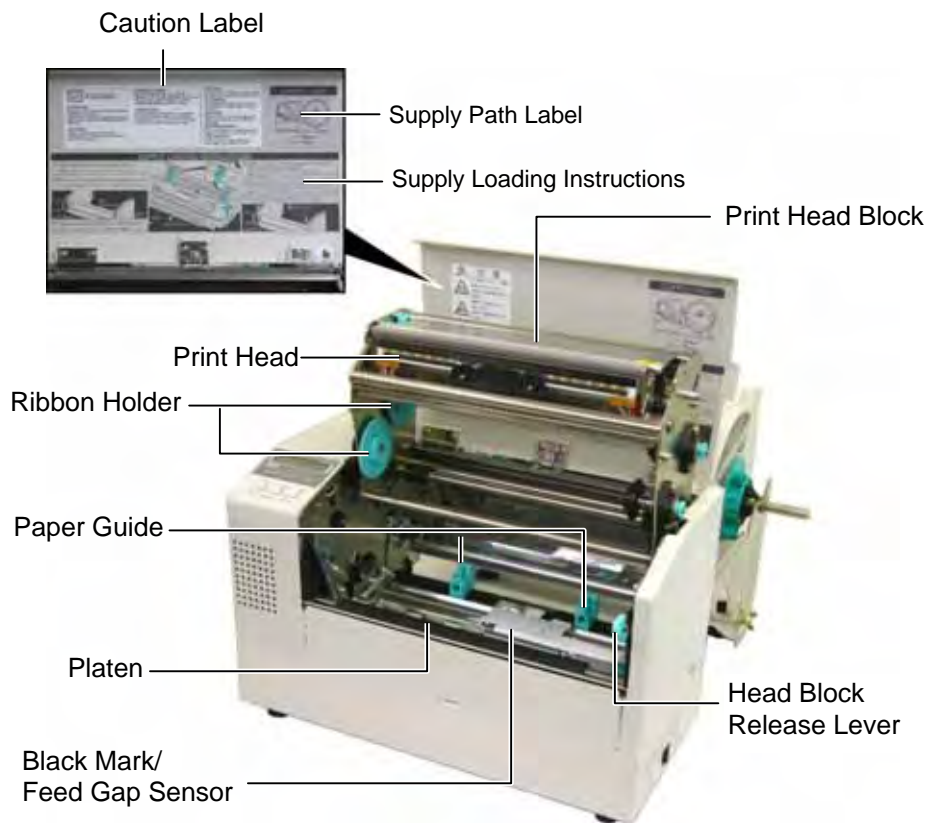

## 1.6 Options

Option Name	Type	Description
Cutter module	B-7208-QM-R	A stop and cut swing cutter.
Expansion I/O interface board	B-SA704-IO-QM-R	Installing this board in the printer allows a connection with an external device with the exclusive interface, such as the keyboard module.
Serial Interface board	B-SA704-RS-QM-R	Installing this PC board provides an RS232C interface port.
Wireless LAN board	B-SA704-WLAN-QM-R	Installing this PC board allows a communication by wireless LAN.
Real time clock	B-SA704-RTC-QM-R	This module holds the current time: year, month, day, hour, minute, second

**NOTE:**

Available from your nearest TOSHIBA TEC representative or TOSHIBA TEC Head Quarters.

## 2. PRINTER SETUP

This section outlines the procedures to setup your printer prior to its operation. The section includes precautions, loading media and ribbon, connecting cables, setting the operating environment of the printer, and performing an online print test.

Setup Flow	Procedure	Reference
Installation	After referring to the Safety Precautions in this manual, install the printer on a safe and stable location.	2.1 Installation
Assembling the supply holder frame	Assemble the supply holder stand, and attach it to the rear of the printer.	2.2 Assembling the Supply Holder Frame
Connecting the power cord	Connect a power cord to the power inlet of the printer, then, to an AC outlet.	2.3 Connecting the Power Cord
Loading the media	Load a label stock or tag stock.	2.4 Loading the Media
Media sensor position alignment	Adjust the position of feed gap sensor or black mark sensor according to the media to be used.	2.5 Setting Sensor Positions
Loading the ribbon	In case of thermal transfer printing, load the ribbon.	2.6 Loading the Ribbon
Connecting to a host computer	Connect the printer to a host computer or a network.	2.7 Connecting the Printer to Your Host Computer
Turning the power ON	Turn on the printer power.	2.8 Turning the Printer ON/OFF
Setting the operating environment	Set the printer parameters in the system mode.	2.9 Setting an Operating Environment
Installing the printer driver	If necessary, install the printer driver in your host computer.	2.10 Installing the Printer Drivers
Print test	Make a print test in your operating environment and check the print result.	2.11 Print Test
Position and Print Tone Fine adjustment	If necessary, fine adjust the print start position, cut/strip position, print tone, etc.	2.12 Position and Print Tone Fine Adjustment
Automatic threshold setting	If the print start position cannot be detected properly when pre-printed label is used, set the threshold automatically.	2.13 Threshold Setting
Manual threshold setting	If the print start position cannot be detected properly even an automatic threshold setting is performing, manually set the threshold.	2.13 Threshold Setting

## 2.1 Installation

To insure the best operating environment, and to assure the safety of the operator and the equipment, please observe the following precautions.

- Operate the printer on a stable, level, operating surface in a location free from excessive humidity, high temperature, dust, vibration or direct sunlight.
- Keep your work environment static free. Static discharge can cause damage to delicate internal components.
- Make sure that the printer is connected to a clean source of AC Power and that no other high voltage devices that may cause line noise interference are connected to the same mains.
- Assure that the printer is connected to the AC mains with a three-prong power cable that has the proper ground (earth) connection.
- Do not operate the printer with the cover open. Be careful not to allow fingers or articles of clothing to get caught into any of the moving parts of the printer especially the optional cutter mechanism.
- Make sure to turn off the printer power and to remove the power cord from the printer whenever working on the inside of the printer such as changing the ribbon or loading the media, or when cleaning the printer.
- For best results, and longer printer life, use only TOSHIBA TEC recommended media and ribbons.
- Store the media and ribbons in accordance with their specifications.
- This printer mechanism contains high voltage components; therefore you should never remove any of the covers of the machine as you may receive an electrical shock. Additionally, the printer contains many delicate components that may be damaged if accessed by unauthorised personnel.
- Clean the outside of the printer with a clean dry cloth or a clean cloth slightly dampened with a mild detergent solution.
- Use caution when cleaning the thermal print head as it may become very hot while printing. Wait until it has had time to cool before cleaning. Use only the TOSHIBA TEC recommended print head cleaner to clean the print head.
- Do not turn off the printer power or remove the power plug while the printer is printing or while the ON LINE lamp is blinking.

## 2.2 Assembling the Accessories

The following procedure outlines the steps required to assemble the Supply Holder Frame and attach the frame to the B-852 printer in preparation for loading the media.

### 2.2.1 Assembling the Supply Holder Frame

1. Assemble the Supply Holder Frame (L) and Supply Holder Frame (R) to the Supply Holder Base using the two M-4X6 Wing Bolts supplied, as shown below.

**NOTE:**  
 Make sure that the two small flanges at each end of the Supply Holder Base fit into the small rectangular holes at the bottom of the Supply Holder Frames before tightening the Wing Bolts.

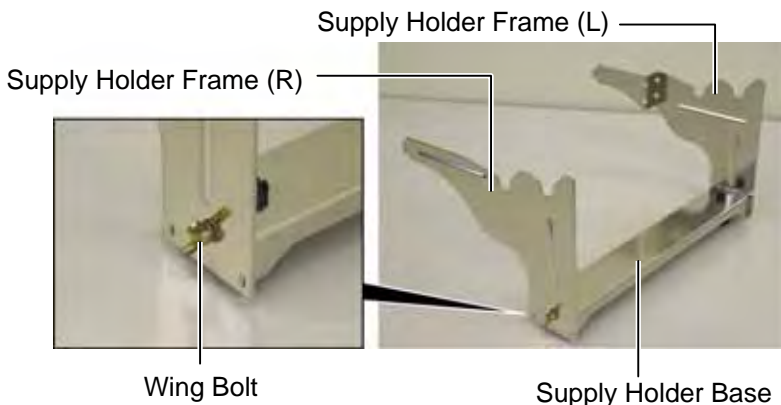

**NOTE:**  
 After attaching the supply holder frame to the printer, make sure that it is assembled firmly.

2. Attach the assembled Supply Holder Frame to the rear of the B-852 printer by inserting the hooks of the Frame into the two slots in the rear of the printer as shown in the figure below.

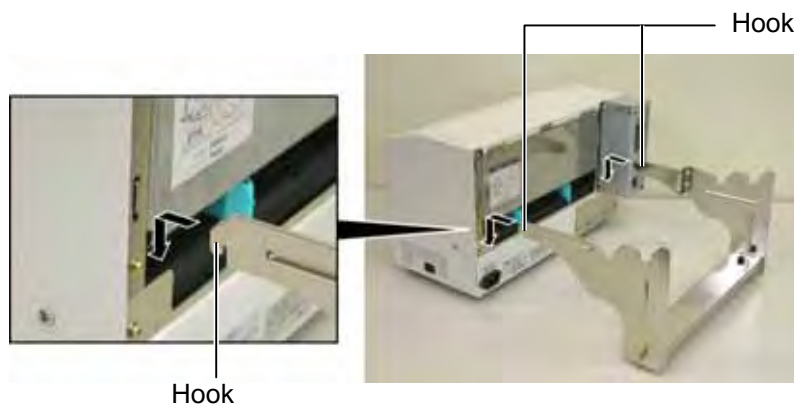



### 2.3 Connecting the Power Cord

1. Make sure that the printer power switch is in the off position.

**CAUTION!**

1. Make sure that the printer power switch is turned to the off position  before connecting the power cord to prevent possible electric shock or damage to the printer.
2. Use only the power cord supplied with the printer. Use of any other cord may cause electric shock or fire.
3. Connect the power cord to a three-prong outlet only, with the third prong being a good ground (earth) connection.



2. Connect the Power Cord to the printer as shown in the figure below.

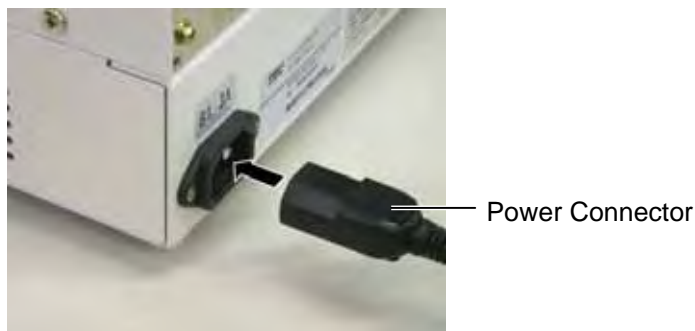

3. Plug the other end of the Power Cord into a grounded outlet as shown in the figure below.

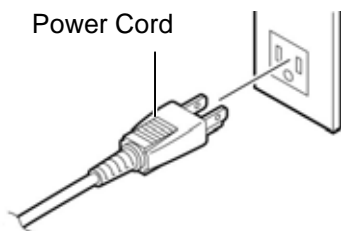

[Example of US Type(QQ model)]

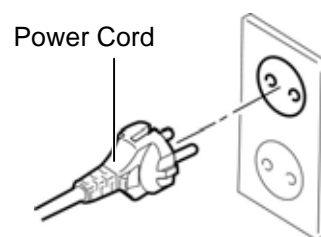

[Example of EU Type(QP model)]

## 2.4 Loading the Media

The following procedure will outline the steps required to install the media onto the Supply Holder Unit and adjust its position in the Supply Holder Frame at the rear of the B-852 printer. The procedure will then show the steps to properly load the media into the printer so that it feeds straight and true through the printer.

### 2.4.1 Installing the Media onto the Supply Holder Unit

The figure below shows the assembled Supply Holder Unit and the paragraphs that follow show the step-by-step procedures to disassemble the Supply Holder Unit, install the media onto the Supply Shaft, then reassembling the Supply Holder Unit so that the auto centering mechanism will automatically center the media on the Supply Shaft.

**NOTES:**

1. The Non-removable Supply Holder is the one that slides in the wide slot while the Removable Supply Holder is the one that slides in the narrow slot.
2. Do not turn the Supply Holder Locking Knob anti-clockwise too far, or it may come off the Supply Holder.

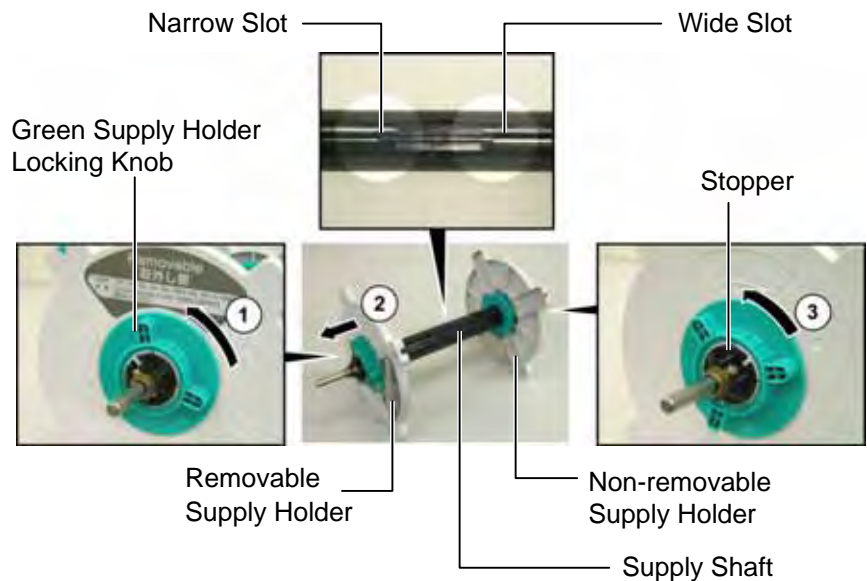

#### Disassembling the Supply Holder Unit

1. Position the Supply Holder Unit as shown in the above diagram so that the Non-removable Supply Holder is at the right.
2. Rotate the Green Supply Holder Locking Knob in the direction of arrow ① (counterclockwise) to loosen the Removable Supply Holder.
3. Slide the Removable Supply Holder in the direction of arrow ② to remove it from the Supply Shaft.
4. Rotate the green Supply Holder Locking Knob in the direction of arrow ③ (counterclockwise) to loosen the Non-removable Supply Holder.
5. Slide the Non-removable Supply Holder all the way to the end of the Supply Shaft until it stops.

**2.4.1 Installing the Media onto the Supply Holder Unit (Cont.)**

**WARNING!**  
If you turn the Removable Supply Holder side down after loading the media, the media may drop by weight. You might be injured by the dropped media.

**CAUTION!**  
When installing the media roll, do not push on the Non-removable Supply Holder as this will result in the media roll not being properly centred.

**NOTES:**

- This Supply Holder accepts four sizes of media core: 38 mm, 40 mm, 42 mm and 76.2 mm..  
When using a media roll of 38 mm, 40 mm, or 42 mm, remove the spacers from the Supply Holders by pushing both hooks of the Spacer. Keep the removed Spacers safe.
- Use only inside wound label stock. Outside wound label stock may not feed properly. Use outside wound label stock at your own risk.
- Do not over-tighten the green Supply Holder Locking Knob.

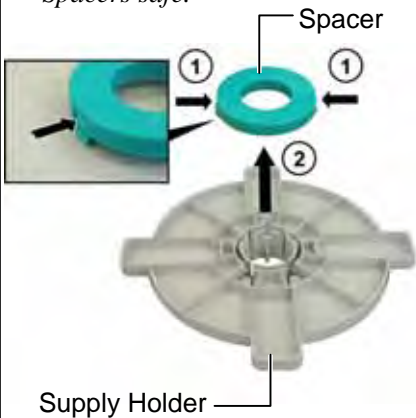

The diagram below, and the steps that follow, show the procedures for installing the Media onto the Supply Shaft and reassembling the Supply Holder Unit. Be sure to follow the step-by-step procedure exactly or the auto centering mechanism may not work properly.

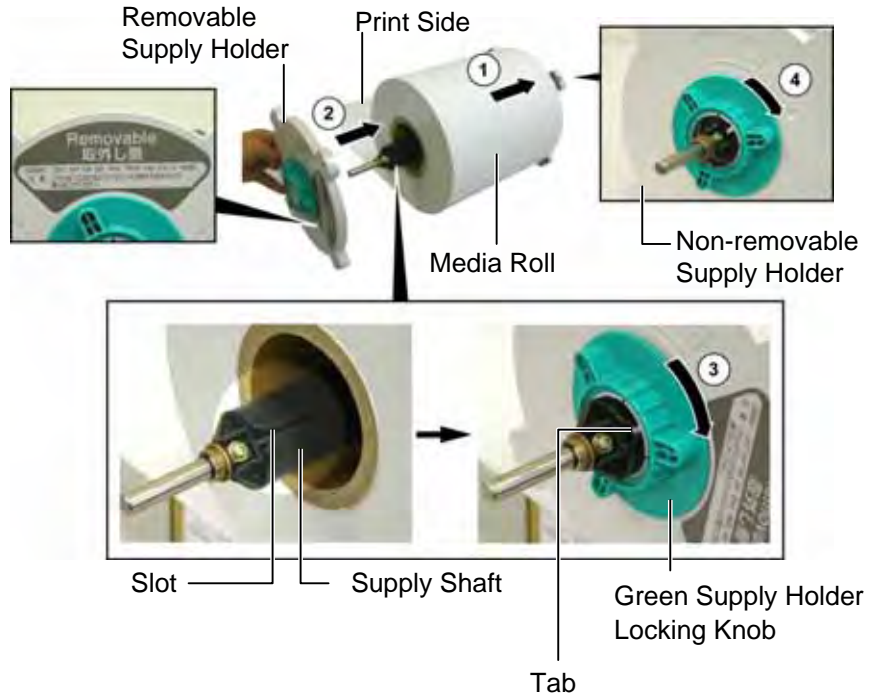

Installing the Media and reassembling the Supply Holder

- Place the media roll onto the Supply Shaft with the media feeding from the bottom as shown in the diagram above. ①
- Align the tab of the Removable Supply Holder with the Slot in the Supply Shaft, then reinstall the Removable Supply Holder by sliding it onto the Supply Shaft as shown in the figure above.
- Holding the reassembled Supply Holder Unit in your right hand, apply pressure only to the reinstalled Removable Supply Holder to push it in the direction of arrow ②, causing the auto centering mechanism to center the media on the Supply Shaft.
- Tighten the green Supply Holder Locking Knob for the Removable Supply Holder by turning it in the direction of arrow ③.
- Tighten the green Supply Holder Locking Knob for the Non-removable Supply Holder by turning it in the direction of arrow ④ .

### 2.4.2 Installing the Supply Holder Unit onto the Supply Holder Frame

**NOTE:**

*Make sure that the brass bushings of the Supply Shaft are seated into the notches so that the entire Supply Holder Unit rotates smoothly.*

**CAUTION!**

*The reassembled Supply Holder Unit and media roll may be quite heavy, so be careful not to pinch your fingers when installing the Supply Holder Unit onto the Supply Holder Frame.*

1. Insert the assembled Supply Holder Unit into the rear notches of the Supply Holder Frame as shown in the diagram below.

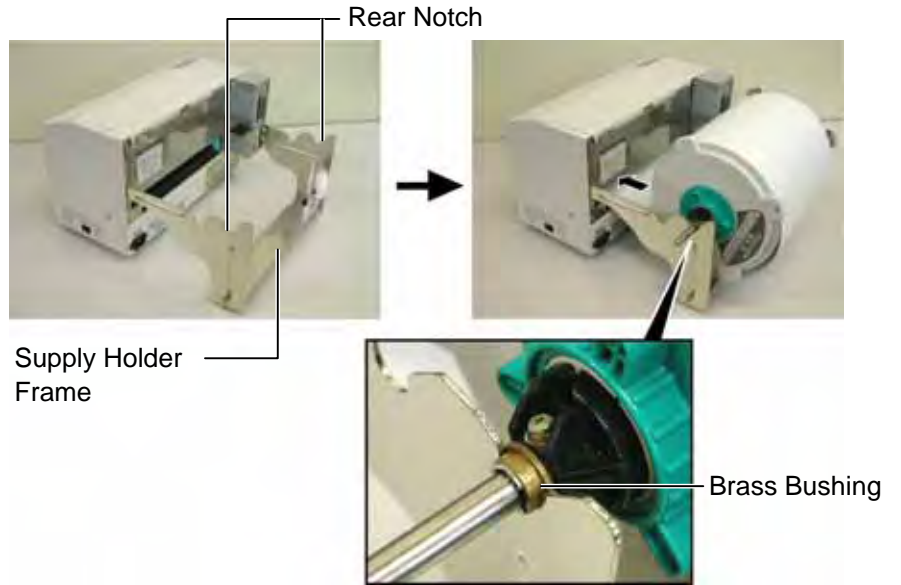

2. Now feed the media from the bottom of the media roll into the media slot at the rear of the printer as shown.

### 2.4.3 Loading Media into the Printer

**WARNING!**

*The Top Cover can be opened during the operation for control purposes only. It should be closed during normal operation.*

The following paragraphs outlines how to properly install the media into the printer from the Supply Holder Unit that has been installed in the previous steps.

1. Raise the Top Cover as shown in the diagram below.



**2.4.3 Loading Media into the Printer (Cont.)**

**WARNING!**

1. The Print Head may become hot. Do not touch the Print Head.
2. Risk of injuries. Do not touch moving parts. Disconnect the mains before maintenance of ribbon and media.

**CAUTION!**

Be careful not touch the Print Head Element when raising the Print Head Block. Failure to do this may cause missing dots by static electricity or other print quality problems.

2. Release the Print Head Block by pressing down on the Head Block Release Lever ① as shown below.
3. Raise the Print Head Block to its fully open position as shown by the arrow ② in the above diagram.

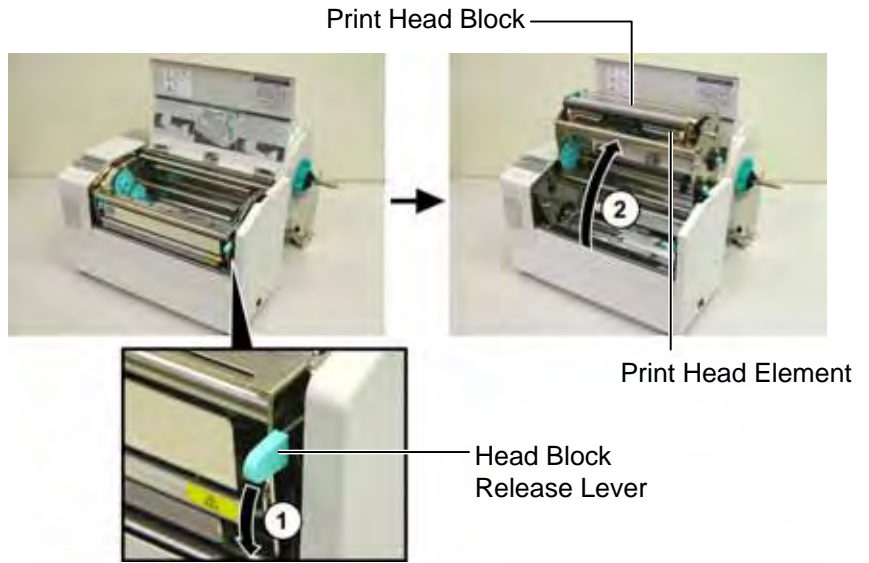

4. Release the locking levers on the two paper guides as shown in the figure below.
5. Grasp the right hand Paper Guide and move it to the right to open the Paper Guides wide enough to accept the media.
6. Feed the media between the two guides.
7. Feed the paper under the Upper Sensor Ass'y and pull the paper until it extends past the Platen. (until it extends past the cutter outlet when the optional cutter is attached.)
8. Grasp the right Paper Guide and move it to the left to close both Paper Guides and automatically center the media.
9. Press the Paper Guide Locking Levers to lock the Paper Guides in place.

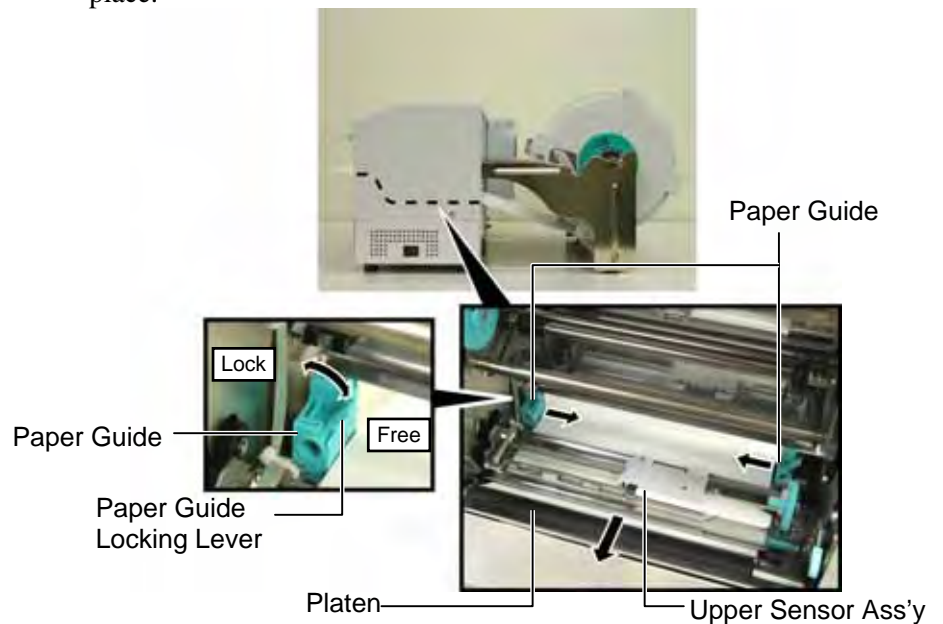

**2.4.3 Loading Media into the Printer (Cont.)**

10. After loading the media, don't forget to move the Supply Holder Unit to the forward notch of the Supply Roll Frame as shown below.

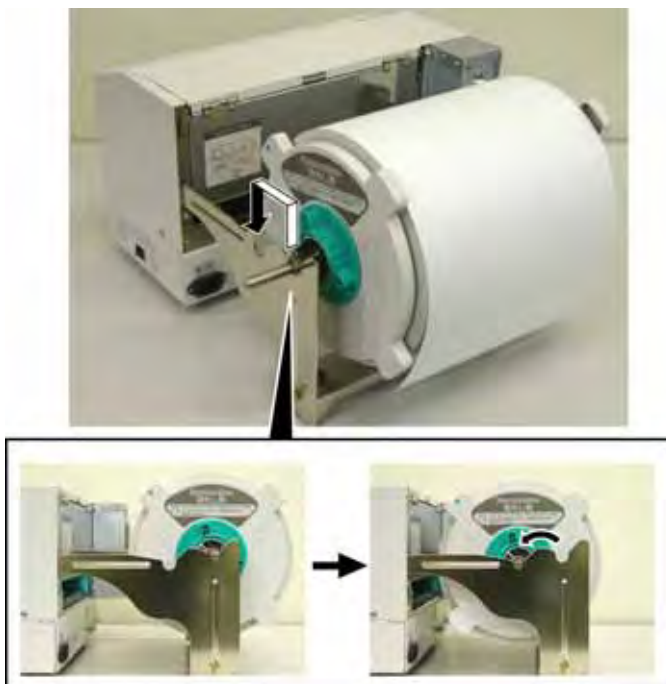

11. If you are using labels or thick tag paper, then it may be necessary to increase the head pressure by lowering the Head Pressure Adjust Lever in the figure below.

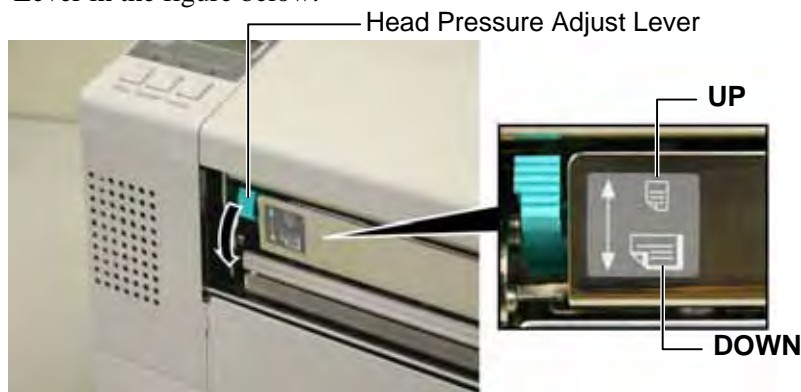

**NOTE: Head Pressure Adjust Lever Position**

Lever position	Head pressure	Available media
<b>UP</b>	Low	<ul style="list-style-type: none"> <li>•Thin tag paper</li> <li>•Narrow media</li> </ul>
<b>DOWN</b>	High	<ul style="list-style-type: none"> <li>•Label</li> <li>•Thick tag paper</li> <li>•Wide media</li> <li>•Full width media</li> </ul>

- When using full width media, be sure to turn the Head Pressure Adjust Lever to DOWN, regardless of the thickness.
- For all kinds of media except the full width media, turn the Head Pressure Adjust Lever to UP, if the print quality is to be ensured.
- If the print tone is light when using thin tag paper, turn the Head Pressure Adjust Lever to DOWN.

## 2.5 Setting Sensor Positions

After loading the media, as outlined in the previous paragraphs, it will usually be necessary to set the Media Sensors used to detect the print start position for label or tag printing.

### 2.5.1 Setting the Feed Gap Sensor

1. With the Print Head Block raised as described in **section 2.4.3**, pass the labels under the Upper Sensor Ass'y as shown in the figure below.
2. Rotate the Green Sensor Adjust Gear to move the Sensor Ass'y to the left or right to center the arrow (↑) over the label.
3. With the sensor set to the center of the labels, it will be guaranteed to detect the gap between labels even if the labels are round.

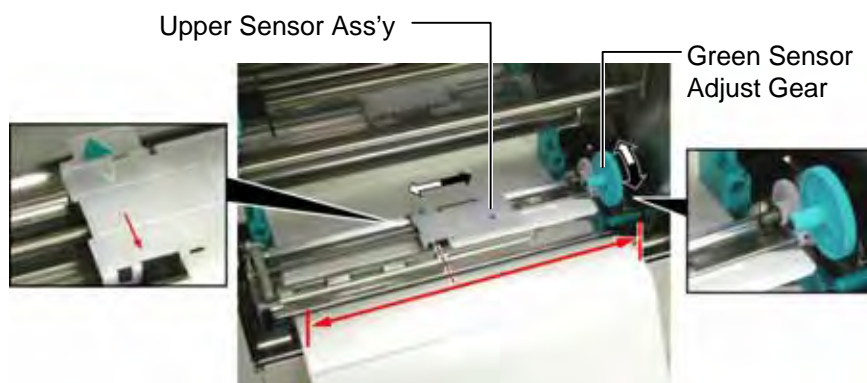

### 2.5.2 Setting the Black Mark Sensor

1. If the Black Mark is printed on the top of the tag media then simply rotate the Green Sensor Adjust Gear to move the Sensor Ass'y so that the Black Mark Indicator (∨) is directly in line with the Black Mark on the top of the paper.
2. If the Black Mark is printed on the bottom of the tag media then fold the media back to be able to see the Black Mark and its relationship to the Sensor Ass'y as shown in the figure below.

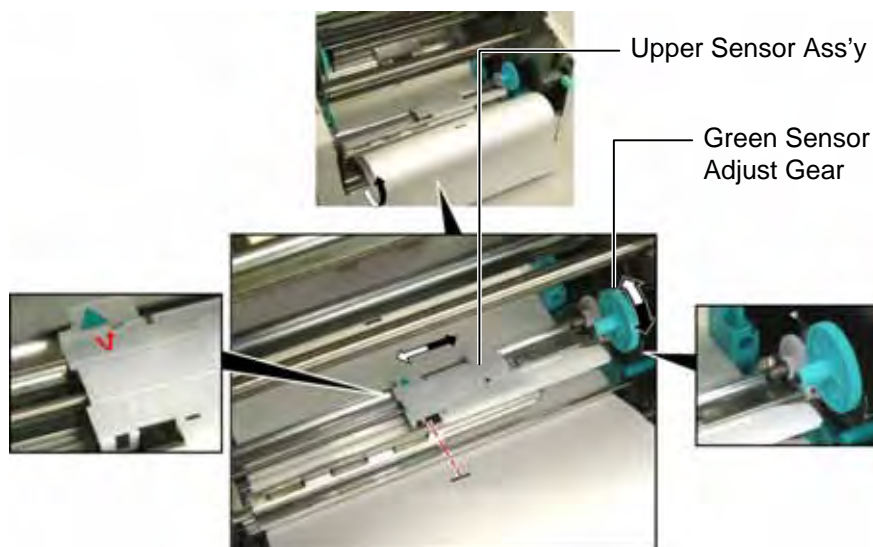

## 2.6 Loading the Ribbon

**WARNING!**

- The Print Head may become hot. Do not touch the Print Head.
- The Top Cover can be opened during the operation for control purposes only. It should be closed during normal operation.
- Risk of injuries. Do not touch moving parts. Disconnect the mains before maintenance of ribbon and media.

**NOTE:**

Be sure to remove any slack in the ribbon. Printing with a wrinkled ribbon will lower the print quality.

1. Raise the Top Cover and release and raise the Print Head Block as described in **section 2.4.3**, steps **1** and **2**.
2. Hold the Ribbon Supply Roll in your left hand and the Ribbon Take up Roll in your right hand.
3. Install the Ribbon Supply Roll into the Print Head Block as shown in the figure below and described in the following paragraphs.
4. Step 1, engage the end of the Ribbon Supply Roll Core to the Ribbon Core Guide ① and push to compress the Ribbon Spring.
5. Step 2, engage the opposite end of the Ribbon Supply Roll Core to the Green Ribbon Winding Core ② releasing pressure to relax the Ribbon Spring.
6. Rotate the Green Ribbon Winding Core to lock the Ribbon Supply Roll into position. ③

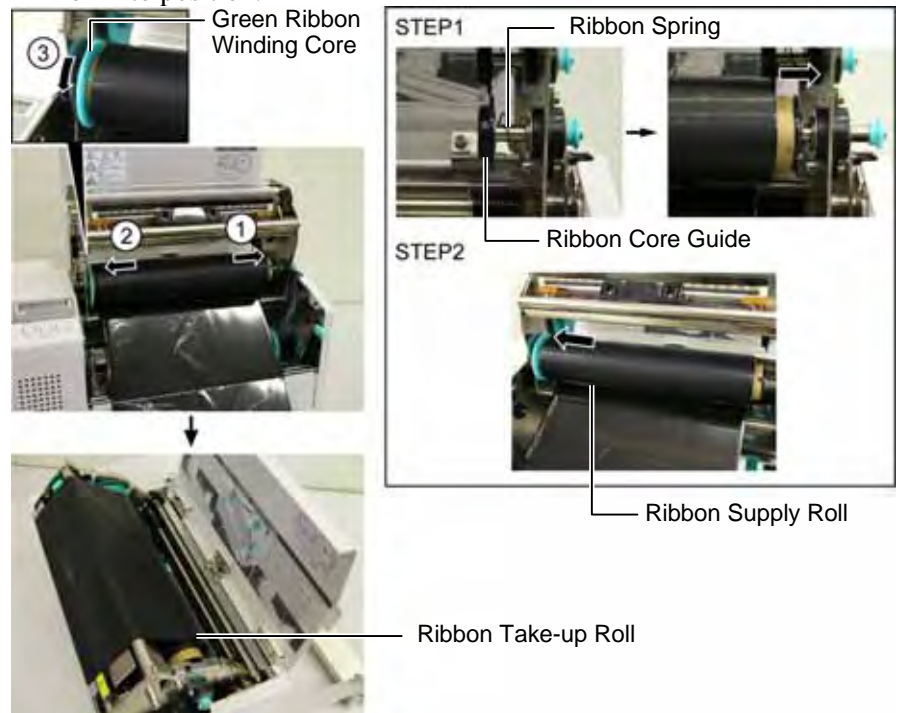

7. Repeat steps 4 through 6 with the Ribbon Take up Roll, locking it in place also.
8. Take up any slack in the ribbon by rotating the green Ribbon Winding Core on the take up in the direction of arrow ①.
9. Close the Print Head Block and lock it in place by pressing at locations ② and ③ in the figure below.





## 2.7 Connecting the Cables to Your Printer

**CAUTION!**

Do not directly connect the LAN cable wired outside of a building to the LAN port provided on this product, as the LAN port on this product is intended for indoor connection.

To connect such LAN cable to the product, be sure to use any communication equipment, like a router, a hub, or a modem which is located within the same building as the product.

**NOTE:**

When using the Parallel interface, fix the Parallel Interface Cable to the printer back with the supplied Cable Clamp and the SMW-3x8 screw.

Parallel Interface Cable



Screw



Cable Clamp

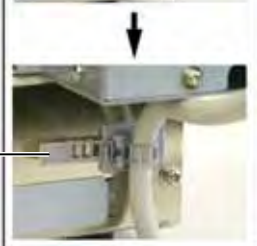

The following paragraphs outline how to connect your host computer to the printer, and will also show how to make cable connections to other devices. Depending on the system configuration you use to print labels, there are 5 possibilities for connecting the printer to your host computer. These are:

- A parallel cable connection between the printer's standard parallel connector and your host computer's parallel port (LPT).
- An Ethernet connection using the standard LAN board.
- A USB cable connection between the printer's standard USB connector and your host computer's USB port. (Conforming to USB 2.0 Full Speed)
- A serial cable connection between the printer's optional RS-232C serial connector and one of your host computer's COM ports. <Option>
- Wireless LAN using an optional Wireless LAN board. <Option>

For details of each interface, refer to **APPENDIX 2**.

After connecting the necessary interface cables, set an operating environment of the printer. Refer to **Section 2.9.1 Parameter Setting**.

The diagram below shows all the possible cable connections to the current version of the printer.

Parallel Connector

USB Connector

LAN Connector

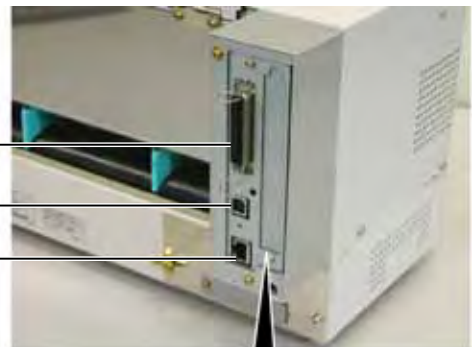

**Expansion I/O and Serial I/F (Option)**



Expansion I/O Connector

Serial I/F Connector

**Wireless LAN (Option)**



Wireless LAN

## 2.8 Turning the Printer ON/OFF

When the printer is connected to your host computer it is good practice to turn the printer ON before turning on your host computer and turn OFF your host computer before turning off the printer.

### 2.8.1 Turning ON the Printer

#### CAUTION!

Use the power switch to turn the printer On/Off. Plugging or unplugging the power cord to turn the printer On/Off may cause fire, an electric shock, or damage to the printer.

#### NOTE:

If an error message appears in the display instead of the ON LINE message or the ERROR LED lamp is illuminated, go to **Chapter 5.1, Error Messages**.

1. To turn ON the printer power, press the power switch as shown in the diagram below. Note that (I) is the power ON side of the switch.



2. Check that the ON LINE message appears in the LCD Message Display and that the ON LINE and POWER LED lights are illuminated.

### 2.8.2 Turning OFF the Printer

1. Before turning off the printer power switch verify that the ON LINE message appears in the LCD Message Display and that the ON LINE LED light is on and is not flashing.
2. To turn OFF the printer power press the power switch as shown in the diagram below. Note that (O) is the power OFF side of the switch.

#### CAUTION!

- Do not turn off the printer power while the media is being printed as this may cause a paper jam or damage to the printer.
- Do not turn off the printer power while the ON LINE light is blinking as this may cause damage to your computer.

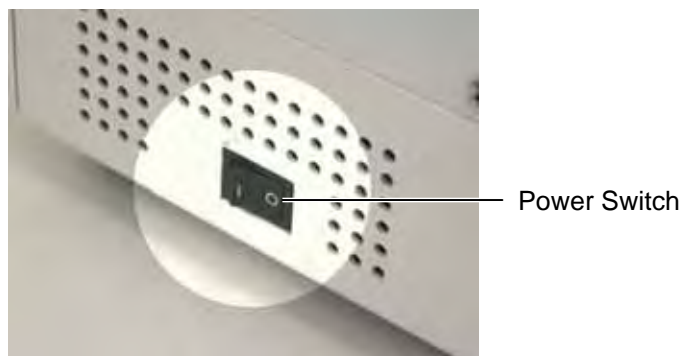

## 2.9 Setting an Operating Environment



Depending on the settings of your host computer or an interface to be used, it may be necessary to change the printer parameter settings.

Follow the procedures described below to change the printer parameter settings in the System Mode to correspond to your environment.

**NOTE:**

*Incorrect settings can cause the printer to function erroneously. If you have any problems with the parameter settings, please contact your nearest TOSHIBA TEC service representative.*

*For the settings this manual does not cover, please contact your nearest TOSHIBA TEC service representative, or refer to the **B-852 Series Key Operation Specification**.*

### How to enter the System Mode

1. Turn on the printer and confirm that "ONLINE" appears on the LCD Message Display.
2. Press the **[PAUSE]** key to pause the printer.
3. Hold down the **[RESTART]** key for three seconds until "<1>RESET" is displayed.

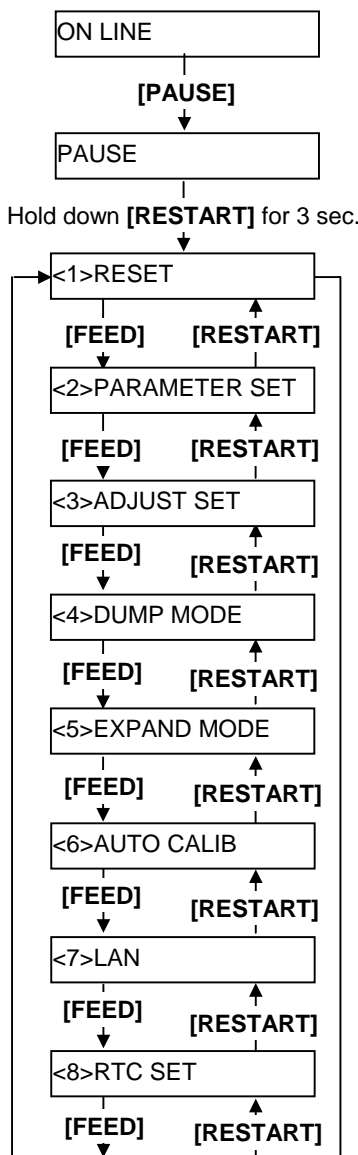

The System Mode consists of the following menus.

- <1>RESET This menu is used to clear print data sent from a PC and return the printer to an idle state. Refer to **Section 3.3 Reset**.
- <2>PARAMETER SET This menu is used to set the printer parameters. Refer to **Section 2.9.1 Parameter Setting**.
- <3>ADJUST SET This menu is used to make a fine adjustment of a print start position, cut position, etc. Refer to **Section 2.12 Position and Print Tone Fine Adjustment**.
- <4>DUMP MODE This menu is used to print the data in the receive buffer for debug. Refer to **Section 2.9.2 Dump Mode Setting**.
- <5>EXPAND MODE This menu is used to start the program for BASIC mode. Refer to **Section 2.9.3 BASIC Expansion Mode**.
- <6>AUTO CALIB This menu is used to enable or disable the automatic calibration function. Refer to **Section 2.9.4 Automatic Calibration**.
- <7>LAN This menu is used to enable or disable the LAN communication and SNMP. Refer to **Section 2.9.5 LAN Setting**.
- <8>RTC SET This menu is used to set the date and time of the real time clock, enable or disable the low battery check, and choose a real time renewal timing. Refer to **Section 2.9.6 Real Time Clock Setting**.

**NOTES:**

1. System Mode menus can be selected with the **[RESTART]** or **[FEED]** key.
2. To enter each of the above System Mode menus, press the **[PAUSE]** key when the menu is displayed.
3. If the **[PAUSE]** key is pressed with "<1>RESET" being displayed, the printer will turn to an idle state and the message will change to "ONLINE"

### 2.9.1 Parameter Setting

While “<2>PARAMETER SET” is displayed on the LCD Message Display, press the **[PAUSE]** key to enter the Parameter Setting Mode.

The Parameter Setting Mode contains the following sub menus. Each time the **[PAUSE]** key is pressed, the sub menus are displayed sequentially.

- (1) Character code selection
- (2) Character zero selection
- (3) Baud rate selection
- (4) Data length selection
- (5) Stop bit length selection
- (6) Parity selection
- (7) Flow control code selection
- (8) LCD language selection
- (9) Auto forward wait selection
- (10) Control code selection
- (11) FEED key function selection
- (12) KANJI code selection
- (13) EURO code selection
- (14) Auto print head check selection
- (15) Centronics ACK/BUSY timing selection
- (16) Web printer function selection
- (17) Input prime selection
- (18) Expansion I/O interface selection
- (19) Plug & Play selection
- (20) Label end/ribbon end selection
- (21) Maxi code specification selection

**2.9.1 Parameter Setting (Cont.)**

**NOTE:**  
 Be careful if the printer is turned off without pressing the **[PAUSE]** key, the selected value does not become effective.

**(1) Character Code Selection**

This parameter is to choose a character code used for printing. Printed characters differ depending on a chosen character code and font. For details of characters, refer to the **B-852 Series External Equipment Interface Specification** (Printer Command Manual).

When “<2>PARAMETER SET” appears, press the **[PAUSE]** key.

FONT CODE PC-850

Use the **[FEED]** or **[RESTART]** key to select a desired option.

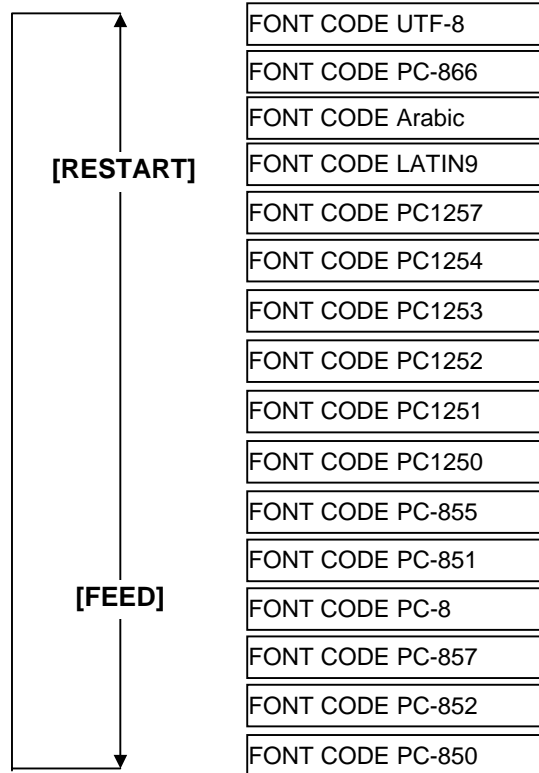

After selecting a character code, press the **[PAUSE]** key.

**(2) Character Zero Selection**

This parameter is to choose the way to indicate zero between “0” and “∅”. When “<2>PARAMETER SET” appears, press the **[PAUSE]** key twice.

ZERO FONT 0

Use the **[FEED]** or **[RESTART]** key to select a desired option.

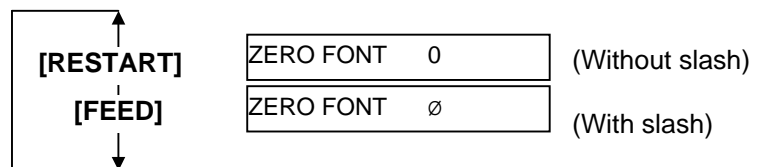

After selecting a character zero, press the **[PAUSE]** key.

**NOTE:**  
 The following fonts do not support a zero with slash.  
**Bit Map Font:**  
 OCR-A, OCR-B, GOTHIC 725 Black, Kanji, Chinese  
**Outline Font:**  
 Price Font 1, Price Font 2, Price Font 3, DUTCH 801 Bold, BRUSH 738 Regular, GOTHIC 725 Black, True Type Font

**2.9.1 Parameter Setting (Cont.)**



<Reference>  
Properties screen of Serial (COM) port under Windows98

**(3) Baud Rate Selection**

This parameter is to choose a baud rate of the RS-232C interface. When the printer communicates with a host computer by serial interface, be sure to match the setting with the host.

When “<2>PARAMETER SET” appears, press the **[PAUSE]** key until the following display appears.

SPEED 9600bps

Use the **[FEED]** or **[RESTART]** key to select a desired option.

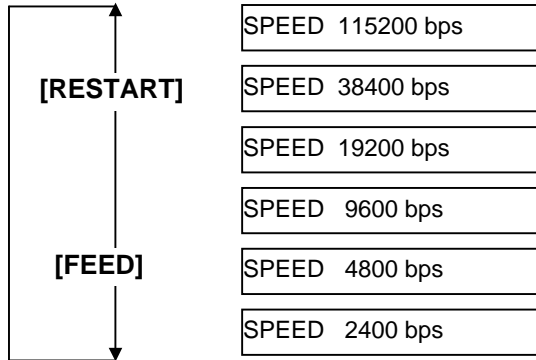

After selecting a baud rate, press the **[PAUSE]** key.

**(4) Data Length Selection**

This parameter is to choose a communication data length of the RS-232C interface.

7 bits is used when transmitting alphanumeric data only. 8 bits is used to when transmitting special characters. Be sure to match a setting with a host computer.

When “<2>PARAMETER SET” appears, press the **[PAUSE]** key until the following display appears.

DATA LENG. 8bits

Use the **[FEED]** or **[RESTART]** key to select a desired option.

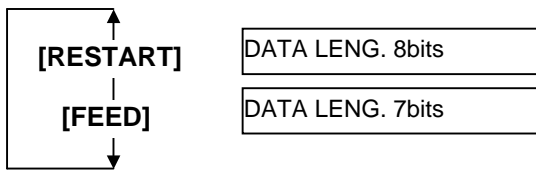

After selecting a data length, press the **[PAUSE]** key.

**2.9.1 Parameter Setting (Cont.)**

**NOTES:**

1. When using the hardware flow control, the control signals and data must be in pairs between the printer and the PC.

Printer		Host
TD	→	RD
RD	←	TD
RTS	→	CTS
CTS	←	RTS
DSR	→	DTR
DTR	←	DSR

Refer to the RS-232C connector's pin layout in APPENDIX 2.

Check if the printer and the PC is properly connectable with your cable

2. Be careful that there are two types of RS-232C cable; straight cable and cross cable. Use a straight cable for this printer.

**NOTE:**

The following is the detailed descriptions for each transmission control code.

- 1) XON/XOFF AUTO  
At the power on time, the printer outputs XON. At the power off time, the printer outputs XOFF.
- 2) XON+READY AUTO  
At the power on time, the printer outputs XON. At the power off time, the printer outputs XOFF.
- 3) READY/BUSY  
At the power on time, the DTR signal output from the printer turns to High level (READY). At the power off time, the printer does not output XOFF.
- 4) ON/XOFF  
At the power on time, the printer outputs XON. At the power off time, the printer does not output XOFF.
- 5) READY/BUSY RTS  
At the power on time, the RTS signal output from the printer turns to High level (READY). At the power off time, the printer does not output XOFF.

**(5) Stop Bit Length Selection**

This parameter is to choose a stop bit length of the RS-232C interface. Be sure to match a setting with a host computer. When "<2>PARAMETER SET" appears, press the [PAUSE] key until the following display appears.

STOP BIT 1bit

Use the [FEED] or [RESTART] key to select a desired option.



After selecting a stop bit length, press the [PAUSE] key.

**(6) Parity Selection**

This parameter is to choose the parity of the RS-232C interface. When "<2>PARAMETER SET" appears, press the [PAUSE] key until the following display appears.

PARITY NONE

Use the [FEED] or [RESTART] key to select a desired option.

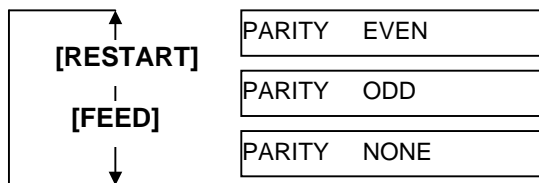

After selecting the parity, press the [PAUSE] key.

**(7) Flow Control Code Selection**

This parameter is to choose a flow control code of the RS-232C interface. When "<2>PARAMETER SET" appears, press the [PAUSE] key until the following display appears.

XON+READY AUTO

Use the [FEED] or [RESTART] key to select a desired option.

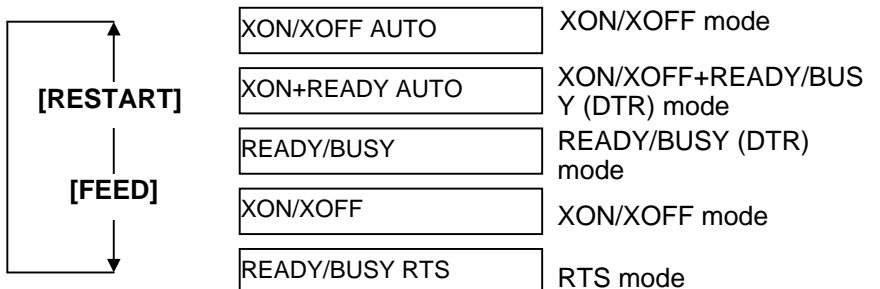

After selecting a flow control code, press the [PAUSE] key.

**2.9.1 Parameter Setting (Cont.)**

**(8) LCD Language Selection**

This parameter is to choose a language in which the LCD message is displayed.

When “<2>PARAMETER SET” appears, press the **[PAUSE]** key until the following display appears.

LCD ENGLISH

Use the **[FEED]** or **[RESTART]** key to select a desired option.

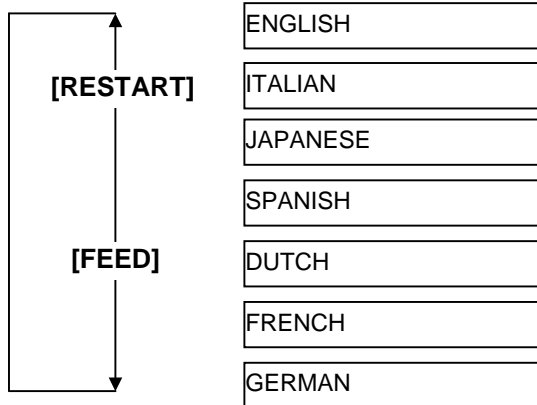

After selecting a language, press the **[PAUSE]** key.

**(9) Auto Forward Wait Selection**

This parameter is to choose whether to activate the Auto Forward Wait function or not.

This function, used in the cut mode, automatically feeds the media forward for about 19 mm if there is more than 1-second idle time after printing, to prevent the top edge of the media from curling.

When “<2>PARAMETER SET” appears, press the **[PAUSE]** key until the following display appears.

FORWARD WAIT OFF

Use the **[FEED]** or **[RESTART]** key to select a desired option.

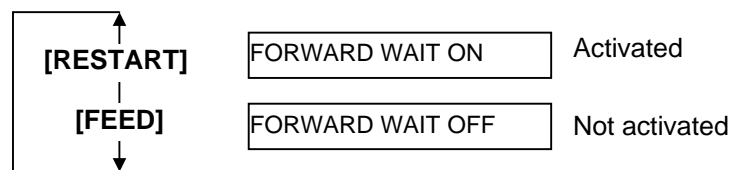

After selecting an auto forward wait, press the **[PAUSE]** key.

**NOTES:**

1. If the printer is not used for a few days, the top edge of the media may become curly, which may cause a paper jam. The Auto Forward Wait Function prevents this problem since the media feed amount is increased so that the media stops past the platen.
2. When the Stop Position Fine Adjustment Value is set in + direction, the media will stop past the media outlet. When the value is set in - direction, the media will stop inside the media outlet.
3. This setting will be useful to fine adjust the cut position of labels.



**2.9.1 Parameter Setting (Cont.)**

When ON is selected, pressing the **[PAUSE]** key will result that the LCD Message Display shows the stop position fine adjustment value setting screen.

POSITION +0.0mm

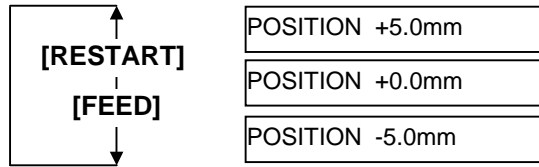

**[FEED]** key: Pressing the **[FEED]** key one time causes a -0.1mm change, up to -5.0 mm.

**[RESTART]** key: Pressing the **[RESTART]** key one time causes a +0.1mm change, up to +5.0 mm.

After selecting an auto forward wait, press the **[PAUSE]** key.

**(10) Control Code Selection**

This parameter is to choose a Control Code.

When “<2>PARAMETER SET” appears, press the **[PAUSE]** key until the following display appears.

CODE AUTO

Use the **[FEED]** or **[RESTART]** key to select a desired option.

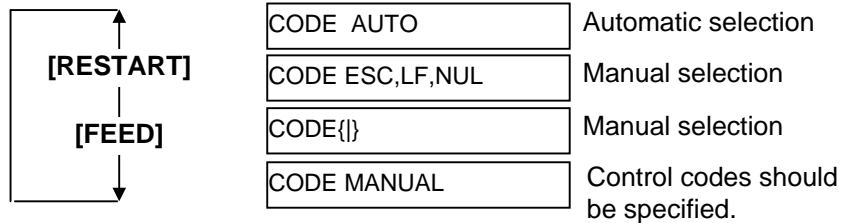

When “CODE MANUAL” is selected and the **[PAUSE]** key is pressed, the LCD display will show the setting screen of CONTROL CODE1 to CONTROL CODE3 as follows.

CONTROL CODE1 1B

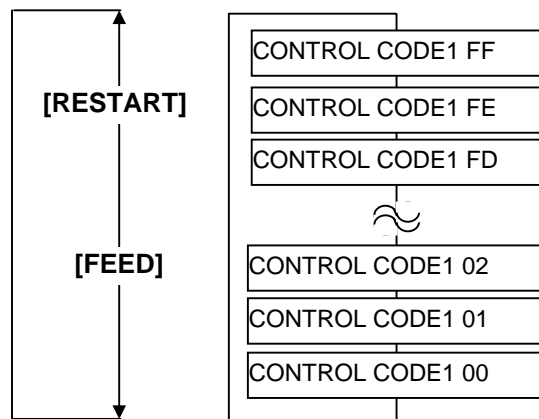

### 2.9.1 Parameter Setting (Cont.)

After setting the control code for Control Code 1, press the **[PAUSE]** key to show the CONTROL CODE2 screen. In a same manner, press the **[PAUSE]** key after setting the control code for Control Code 2 to display the CONTROL CODE3 screen.

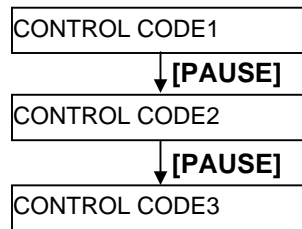

Press the **[PAUSE]** key after setting the control code for Control Code 3.

#### (11) FEED Key Function Selection

This parameter is to choose the function of the **[FEED]** key. When “<2>PARAMETER SET” appears, press the **[PAUSE]** key until the following display appears.

FEED KEY FEED

Use the **[FEED]** or **[RESTART]** key to select a desired option.

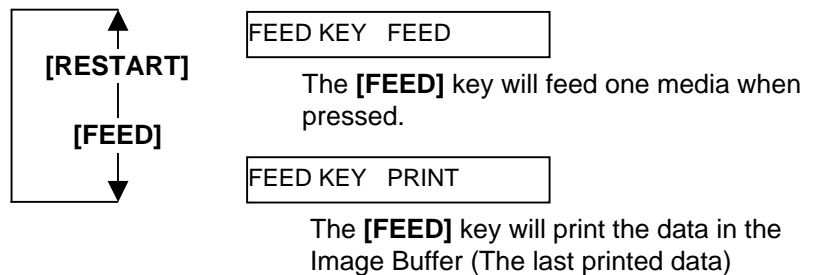

After selecting the FEED key function, press the **[PAUSE]** key.

### 2.9.1 Parameter Setting (Cont.)

**NOTE:**  
*Kanji code selection is not supported by the QQ/QP model as the Kanji ROMs are not installed.*

#### (12) KANJI Code Selection

This parameter is to choose a KANJI code.  
 When “<2>PARAMETER SET” appears, press the **[PAUSE]** key until the following display appears.

KANJI CODE TYPE1

Use the **[FEED]** or **[RESTART]** key to select a desired option.

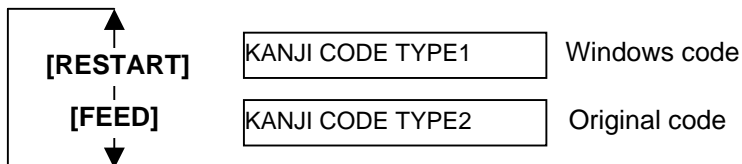

After selecting a Kanji code, press the **[PAUSE]** key.

#### (13) EURO Code Selection

This parameter is to choose a Euro code (€).  
 When “<2>PARAMETER SET” appears, press the **[PAUSE]** key until the following display appears.

EURO CODE B0

**NOTE:**  
*Pressing the **[FEED]** or **[RESTART]** key causes 1 byte change in the Euro Code value.*

Use the **[FEED]** or **[RESTART]** key to select a desired option.

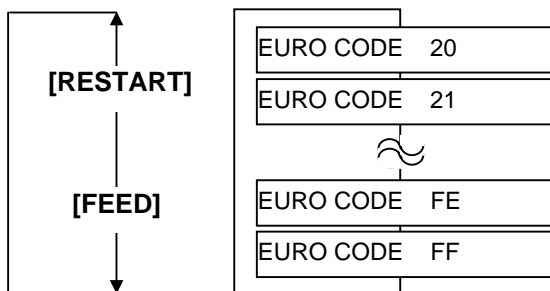

After selecting a Euro code, press the **[PAUSE]** key.

**2.9.1 Parameter Setting (Cont.)**

- NOTES:**
1. It will take about 2 seconds to perform an Auto Print Head check.
  2. It is recommended that this function should be activated when high quality printing such as bar codes printing is required. Otherwise, choose OFF.
  3. When a broken element is found, the printer stops, displaying "HEAD ERROR". The error state can be cleared by pressing the [RESTART] key, but if the broken element affects bar code readability or actual operations, please replace the print head with a proper one.

**(14) Auto Print Head Check Selection**

This parameter is to choose whether to perform the Auto Print Head Check function at the power on time. When "<2>PARAMETER SET" appears, press the [PAUSE] key until the following display appears.

AUTO HD CHK OFF

Use the [FEED] or [RESTART] key to select a desired option.

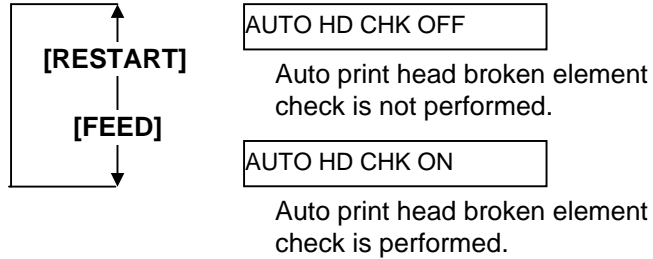

After selecting auto print head check, press the [PAUSE] key.

**(15) Centronics Interface ACK/BUSY Timing Selection**

This parameter is to choose an ACK/BUSY timing of the Centronics interface.

"TYPE1" has been chosen as default, but if a communication error occurs or a communication is not properly made, change to "TYPE2".

When "<2>PARAMETER SET" appears, press the [PAUSE] key until the following display appears".

ACK/BUSY TYPE1

Use the [FEED] or [RESTART] key to select a desired option.

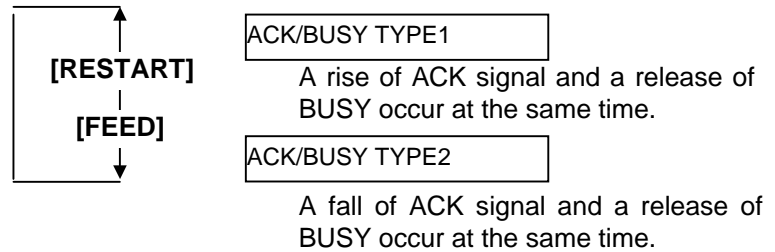

After selecting an ACK/BUSY timing, press the [PAUSE] key.

**2.9.1 Parameter Setting (Cont.)**

**NOTE:**  
 When "WEB PRINTER ON" is selected, the status of the printer connected in a network can be checked through the Web browser.

**(16) Web Printer Function Selection**

This parameter is to choose whether to use the printer as a web printer. When "<2>PARAMETER SET" appears, press the [PAUSE] key until the following display appears.

WEB PRINTER OFF

Use the [FEED] or [RESTART] key to select a desired option.

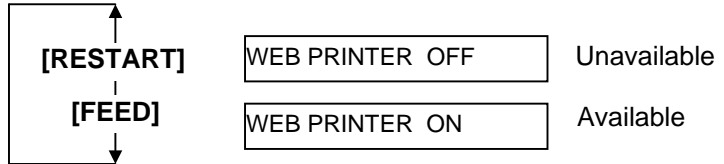

After selecting the Web printer function, press the [PAUSE] key.

**(17) Input Prime Selection**

This parameter is to choose whether to enable a reset operation when INIT signal is ON.

Normally, when the printer receives a reset request signal (nInit signal) from the host via Centronics interface, the printer will be reset and turn to the idle state.

When the INPUT PRIME parameter is set to OFF, the printer is reset but does not turn to idle.

When this parameter is set to ON, the host sends an  $\overline{\text{INIT}}$  signal and the printer turns to idle each time the printer is turned on. If you would like to avoid this processing, set this parameter to OFF.

When "<2>PARAMETER SET" appears, press the [PAUSE] key until the following display appears.

INPUT PRIME ON

Use the [FEED] or [RESTART] key to select a desired option.

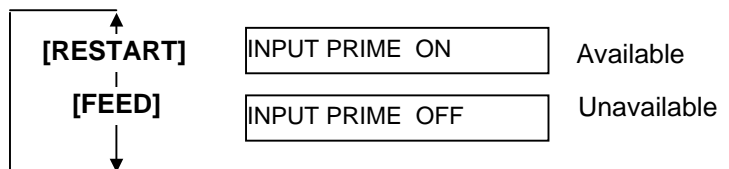

After selecting the Input Prime, press the [PAUSE] key.

### 2.9.1 Parameter Setting (Cont.)

#### (18) Expansion I/O Interface Type Selection

This parameter is to choose a type of the Expansion I/O interface operating mode.

This parameter should be set depending on the expansion I/O control specification of the device to be connected via the expansion I/O interface. For details, refer to the **External Equipment Interface Specification**.

When “<2>PARAMETER SET” appears, press the **[PAUSE]** key until the following display appears.

EX.I/O TYPE1

Use the **[FEED]** or **[RESTART]** key to select a desired option.

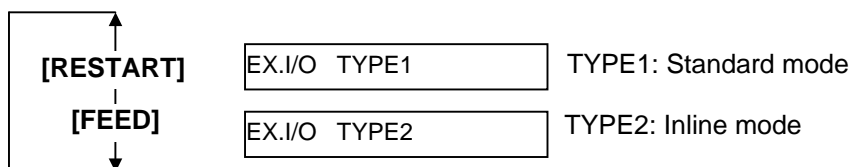

After selecting an Expansion I/O Interface type, press the **[PAUSE]** key.

#### (19) Plug & Play Selection

This parameter is to choose whether to enable a Plug & Play function. When “<2>PARAMETER SET” appears, press the **[PAUSE]** key until the following display appears.

PLUG & PLAY OFF

Use the **[FEED]** or **[RESTART]** key to select a desired option.

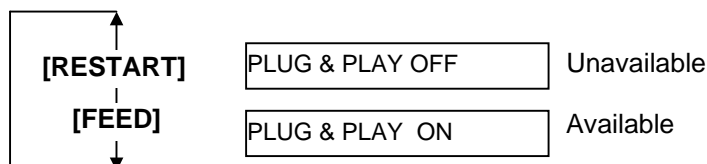

After selecting a Plug & Play, press the **[PAUSE]** key.

**NOTE:**

*If the printer and the PC are connected by USB, plug & play will be automatically enabled, regardless of the setting of this parameter.*

### 2.9.1 Parameter Setting (Cont.)

#### (20) Label End/Ribbon End Selection

This parameter is to choose a printing process when a label end or ribbon end is detected.

When “<2>PARAMETER SET” appears, press the **[PAUSE]** key until the following display appears.

LBL/RBN END TYP1

Use the **[FEED]** or **[RESTART]** key to select a desired option.

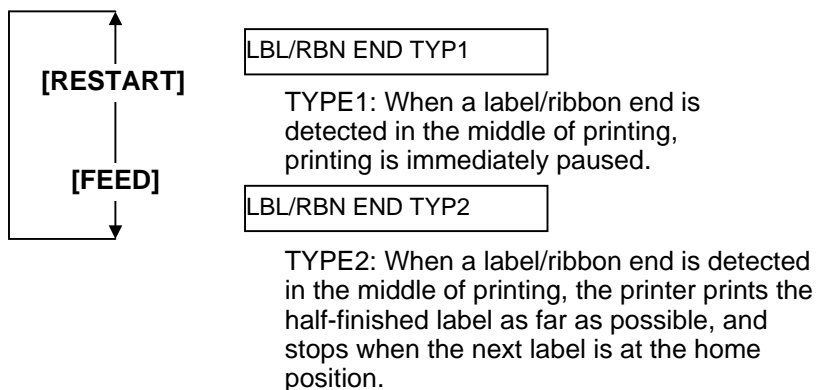

After selecting a Label End type, press the **[PAUSE]** key.

#### (21) Maxi Code Specification Selection

This parameter is to choose a Maxi code specification.

When “<2>PARAMETER SET” appears, press the **[PAUSE]** key until the following display appears.

MAXI CODE TYPE1

Use the **[FEED]** or **[RESTART]** key to select a desired option.

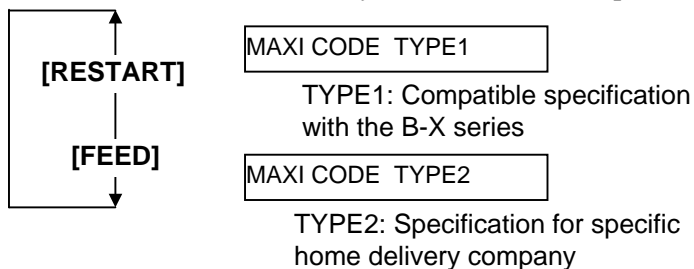

After selecting a Maxi code specification, press the **[PAUSE]** key.

### 2.9.2 Dump Mode Setting

While “<4>DUMP MODE” is displayed on the LCD Message Display, press the **[PAUSE]** key to enter the Dump Mode.

In the Dump Mode, data in the receive buffer are printed. Data are expressed in hexadecimal values. This operation allows the user to verify programming commands or debug the program.

When “<4>DUMP MODE” appears, press the **[PAUSE]** key.

BUFFER RS-232C

Use the **[FEED]** or **[RESTART]** key to choose a receive buffer to be dumped.

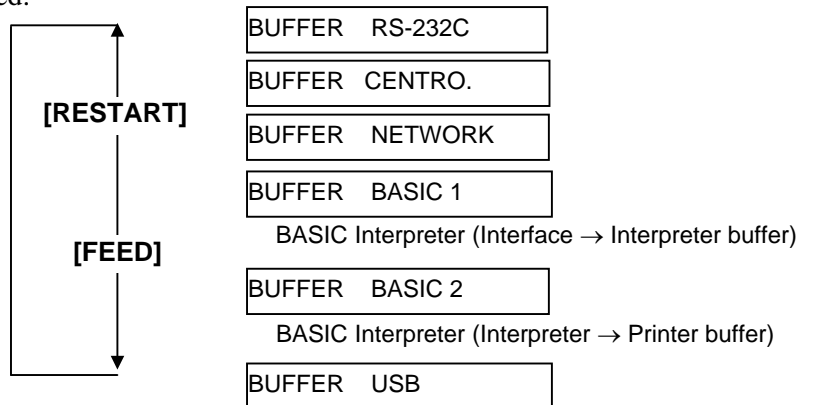

After selecting the receive buffer, press the **[PAUSE]** key.

PRINT ON DEMAND

**NOTES:**

1. When “ON DEMAND” is selected, it is required to choose a printing method again and press the **[PAUSE]** key to print the subsequent data until the all data has been printed.
2. If an error occurs during dumping, the printer will display an error message and stop printing. The error can be cleared by pressing the **[PAUSE]** key, and then the display will show “<4>DUMP MODE” again.  
After a recovery from the error the printer will not start printing automatically.

Use the **[FEED]** or **[RESTART]** key to select a printing method.

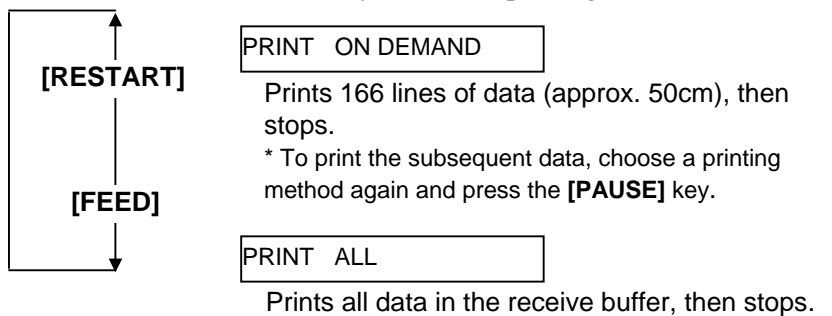

After selecting a printing method, press the **[PAUSE]** key.

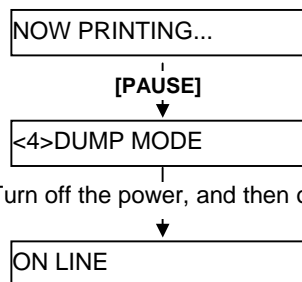



**2.9.2 Dump Mode Setting (Cont.)**

- Print Conditions**
- Printing width: 3.9 inches (100 mm)
  - Sensor selection: None
  - Print speed: 4"/sec.
  - Printing mode: Depends on the selection in use.
  - 16 bytes/line
  - Data is printed in the order from the new one to the old one.
  - Data specified by the receive buffer write pointer will be printed in boldface.

The data in the receive buffer is printed as follows:

```

00 00 00 00 00 00 00 00 00 00 00 00 00 00 00 00
00 00 00 00 00 00 00 00 00 00 00 00 00 00 00 00
00 00 00 00 00 00 00 00 00 00 00 00 00 00 00 00
7B 41 58 3B 2B 30 30 30 2C 2B 30 30 30 2C 2B 30 {AX;+000,+000,+0
30 7C 7D 7B 44 30 37 37 30 2C 31 31 30 30 2C 30 0}}{D0760,1100,0
37 34 30 7C 7D 7B 43 7C 7D 7B 4C 43 3B 30 30 33 740|}{C|}{LC;003
30 2C 30 30 32 30 2C 30 30 33 30 2C 30 36 36 30 0,0020,0030,0660
2C 30 2C 32 7C 7D 7B 4C 43 3B 30 30 37 30 2C 30 ,0,2|}{LC;0070,0
30 32 30 2C 30 30 37 30 2C 30 36 36 30 2C 30 2C 020,0070,0660,0,
39 7C 7D 7B 4C 43 3B 30 30 35 30 2C 30 30 32 30 9|}{LC;0050,0020
:
:
44 45 46 47 48 49 4A 7C 7D 7B 50 43 31 30 3B 30 DEFGHIJ|}{PC10;0
33 35 30 2C 30 34 30 30 2C 31 2C 31 2C 4B 2C 30 350,0400,1,1,K,0
30 2C 42 3D 41 42 43 44 65 66 67 68 69 6A 6B 6C 0,B=ABCDefghijk|
6D 6E 6F 70 7C 7D 7B 50 56 30 32 3B 30 33 33 30 mnop|}{PV02;0330
2C 30 36 36 30 2C 30 32 37 30 2C 30 32 35 30 2C ,0660,0270,0250,
41 2C 30 30 2C 42 3D 42 7C 7D 7B 50 56 30 33 3B A,00,B=B|}{PV03;
:
:
3B 30 39 30 30 2C 30 31 38 30 2C 54 2C 48 2C 30 ;0900,0180,T,H,0
35 2C 41 2C 30 3D 31 32 33 34 35 36 37 38 39 30 5,A,0=1234567890
41 42 43 44 45 7C 7D 00 00 00 00 00 00 00 00 00 ABCDE|}
:
:

```

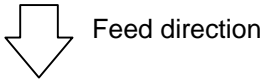

**Receive Buffer Size**

Interface	Buffer size
RS-232C	1MB (65536 lines)
Centronics	1MB (65536 lines)
Network Interface	1MB (65536 lines)
BASIC 1	8KB (512 lines)
BASIC 2	8KB (512 lines)
USB	1MB (65536 lines)

**Required Label Length**

Interface	Media length*
RS-232C	198.2m
Centronics	198.2m
Network Interface	198.2m
BASIC 1	2m
BASIC 2	2m
USB	198.2m

\*: Media length required for printing all data in the receive buffer.

### 2.9.3 BASIC Expansion Mode

**NOTE:**  
*For the BASIC enable setting mode, refer to the **B-852 Series Key Operation Specification** stored in the CD-ROM.*

While “<5>EXPAND MDOE” is displayed on the LCD Message Display, press the **[PAUSE]** key to enter the BASIC Expansion Mode.

In the BASIC Expansion Mode, it is possible to execute the BASIC expansion mode program under the following conditions.

- The BASIC expansion mode program has already been loaded.
- The BASIC enable setting mode is selected.

The basic expansion mode ends when the basic expansion program is exited.

When “<5>EXPAND MODE” appears, press the **[PAUSE]** key.

<5>EXPAND MODE

When the **[PAUSE]** key is pressed, BASIC program is executed.

**2.9.4 Automatic Calibration**

While “<6>AUTO CALIB” is displayed on the LCD Message Display, press the **[PAUSE]** key to enter the Automatic Calibration Mode.

In the Automatic Calibration Mode, whether to activate the automatic calibration at a power on time or not is selectable. When the automatic calibration is activated, the printer feeds the media for about 160 mm each time the power is turned on or the Top Cover is opened, to detect a print start position.

When “<6>AUTO CALIB” appears, press the **[PAUSE]** key.

OFF
-----

Use the **[FEED]** or **[RESTART]** key to select a desired option.

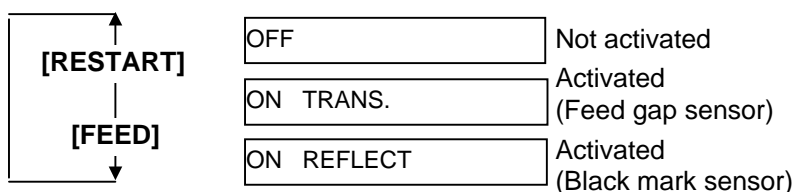

After selecting the automatic calibration, press the **[PAUSE]** key.

**NOTES:**

1. This function is available only when the media pitch is 10.0 mm to 150.0 mm.
2. When this function is activated, the media length, effective print length, and sensor type specified in the command are ignored.
3. When the printer cannot find a print start position properly, it will continue to feed the media for up to 500.0 mm. If that does not work, the printer will stop, resulting in a paper jam.
4. During an automatic calibration, the printer also feeds the ribbon.
5. An automatic forward feed is not performed immediately after an automatic calibration, even if the auto forward wait parameter is set to ON.

### 2.9.5 LAN Setting

While “<7>LAN” is displayed on the LCD Message Display, press the **[PAUSE]** key to enter the LAN Setting Mode.

In the LAN Setting Mode, whether to enable the LAN communication and SNMP or not is selectable.

When “<7>LAN” appears, press the **[PAUSE]** key.

ON SNMP ON

Use the **[FEED]** or **[RESTART]** key to select a desired option.

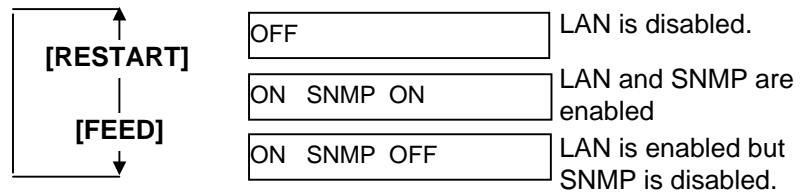

After selecting the LAN setting, press the **[PAUSE]** key.

### 2.9.6 Real Time Clock Setting

While “<8>RTC SET” is displayed on the LCD Message Display, press the **[PAUSE]** key to enter the Real Time Clock Setting Mode.

**NOTE:**  
The Real Time Clock Setting is effective only when an optional Real Time Clock, B-SA704-RTC-QM-R, is installed.

The Real Time Clock Setting Mode contains the following sub menus. Each time the **[PAUSE]** key is pressed, the sub menus are displayed sequentially.

- (1) Date setting (Year, Month, Day)
- (2) Time setting (Hour, Minute, Second)
- (3) Low battery check setting
- (4) RTC data renewal timing setting

#### (1) Date Setting

This parameter is to set the Year, Month, and Day, in order. When “<8>RTC SET” appears, press the **[PAUSE]** key.

DATE 05/01/01

Press the **[PAUSE]** key to set the date.

**NOTE:**  
Use the **[FEED]** or **[RESTART]** key to set the value.

DATE Y 06/01/01      Year

[PAUSE]

DATE M 06/03/01      Month

[PAUSE]

DATE D 06/03/01      Day

After selecting the date, press the **[PAUSE]** key.

#### (2) Time Setting

This parameter is to set the Hour, Minute, and Second, in order.

TIME 00/00/00

Press the **[PAUSE]** key to set the time.

TIME H 10/01/01      Hour

[PAUSE]

TIME M 10/30/01      Minute

[PAUSE]

TIME S 10/30/00      Second

After selecting the time, press the **[PAUSE]** key.

### 2.9.6 Real Time Clock Setting (3) Low Battery Check Setting (Cont.)

This parameter is to choose whether to activate the low battery check function or not.

**NOTE:**

1. Be sure to load the battery and set the low battery check function to ON whenever the real time clock is used. If the battery is not loaded or the battery voltage is low, the real time clock data is erased at the power off time.
2. When the low battery check function is set to ON and if the battery voltage is 1.9V or less, the printer will result in a "LOW BATTERY" error and stop at the power on time. As a restart is invalidated in this case, hold down the [RESTART] key to cause the printer to enter <1>RESET mode, access the Real Time Clock setting mode, and set the low battery function to OFF.

LOW BATT. CHECK

Press the [PAUSE] key to set.

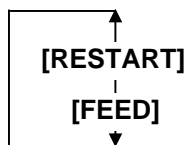

LOW BATT. ON

Low battery check is activated.

LOW BATT. OFF

Low battery check is not activated.

After selecting the low battery check, press the [PAUSE] key.

### (4) RTC Data Renewal Timing Setting

This parameter is to choose the RTC data renewal timing.

RENEWAL

Press the [PAUSE] key to set.

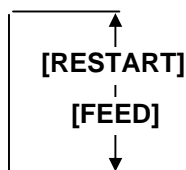

RENEWAL BATCH

Batch print is possible. However, the same time is printed on the all media issued in a batch because the real time clock data is read only for the first media.

RENEWAL PAGE

A real time can be printed on each media. However, the printer needs to stop the motion before printing each media to read the real time clock data.

After selecting the RTC data renewal timing, press the [PAUSE] key.  
The current date is displayed.

DATE 06/03/01

Press the [FEED] and [RESTART] keys at the same time to return to the <8>RTC SET display.

<8>RTC SET

### 2.9.7 IP Address Setting (TCP/IP)

When the printer is connected to a PC through TCP/IP by using a LAN cable, it is necessary to set an IP address in the System Mode for system administrators.

The System Mode for system administrators consists of the following menus.

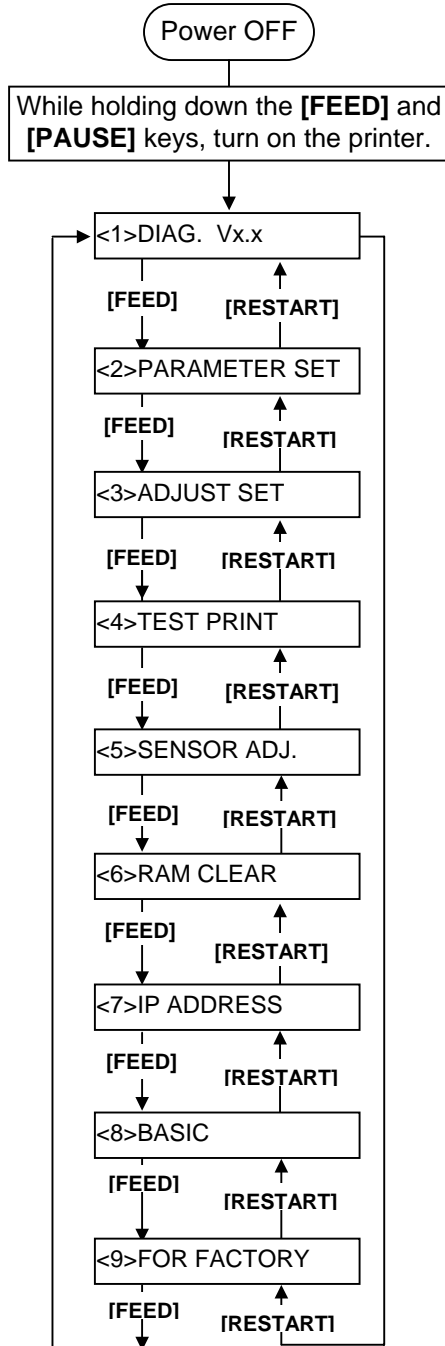

- |               |  |   |
|---------------|--|---|
| <1>DIAG. Vx.x |  | This menu is used to check and print the printer system information and maintenance counter status. |
|---------------|--|---|
- |                  |  |  |
|------------------|--|--|
| <2>PARAMETER SET |  | This menu is used to set the printer parameters. |
|------------------|--|--|
- |               |  |   |
|---------------|--|---|
| <3>ADJUST SET |  | This menu is used to make a fine adjustment of a print start position, cut position, etc. |
|---------------|--|---|
- |               |  |   |
|---------------|--|---|
| <4>TEST PRINT |  | This menu is used to perform print tests. |
|---------------|--|---|
- |                |  |  |
|----------------|--|--|
| <5>SENSOR ADJ. |  | This menu is used to check the sensor statuses and adjust each sensor. |
|----------------|--|--|
- |              |  |   |
|--------------|--|---|
| <6>RAM CLEAR |  | This menu is used to perform a RAM clear. DO NOT USE this menu. |
|--------------|--|---|
- |               |  |   |
|---------------|--|---|
| <7>IP ADDRESS |  | This menu is used to set an IP address. |
|---------------|--|---|
- |          |  |   |
|----------|--|---|
| <8>BASIC |  | This menu is used to enable the printer to use Basic program. |
|----------|--|---|
- |                |  |   |
|----------------|--|---|
| <9>FOR FACTORY |  | This menu is intended for an in-process inspection. Do not use this menu. |
|----------------|--|---|

### 2.9.7 IP Address Setting (TCP/IP) (Cont.)

In this section, how to set the IP address is described.

First, you need to access the System Mode for system administrators.

1. While holding down the **[FEED]** and **[PAUSE]** keys, turn on the printer.
2. When “<1>DIAG” appears on the LCD Message Display, release the **[FEED]** and **[PAUSE]** keys.

Now, the printer is in the System Mode for system administrators.

3. Press the **[FEED]** or **[RESTART]** key until “<7>IP ADDRESS” appears on the LCD Message Display.
4. Press the **[PAUSE]** key to enter the IP Address Setting Mode.

The IP Address Setting Mode contains the following sub menus. To enter each sub menu, press the **[PAUSE]** key.

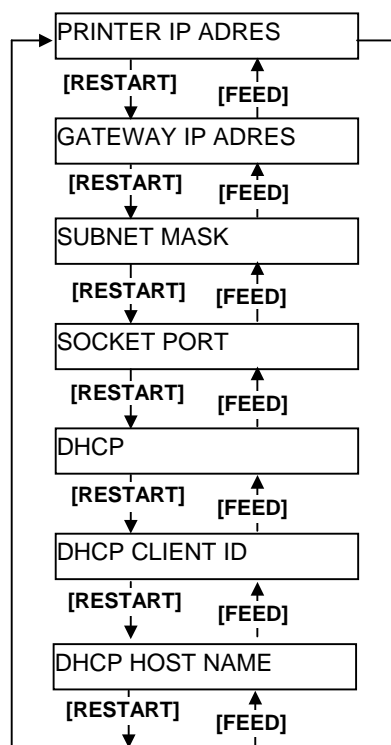



### 2.9.7 IP Address Setting (TCP/IP) (Cont.)

- NOTES:**
1. Set each 3-digit value by using the **[RESTART]** or **[FEED]** key.  
**[RESTART]** key: Increment  
**[FEED]** key: Decrement  
 Range: 0 to 255
  2. Press the **[PAUSE]** key to move the cursor to the next 3-digit value.
  3. After the last 3-digit value is set, press the **[PAUSE]** key to go to Gateway IP Address Setting.

#### (1) Printer IP Address

This parameter is to set an IP address.

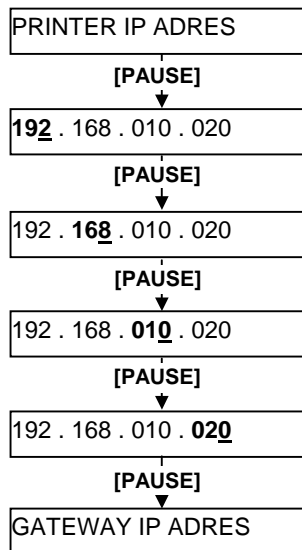

#### (2) Gateway IP Address

This parameter is to set a Gateway IP address.

**NOTE:**  
 After the last 3-digit value is set, press the **[PAUSE]** key to go to Subnet Mask Setting.

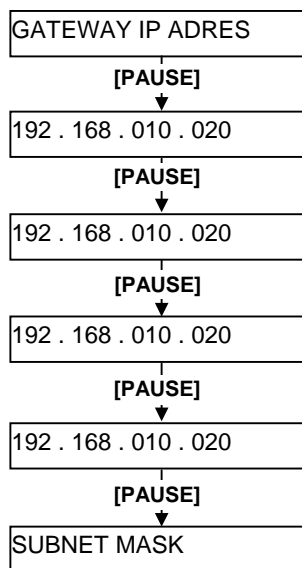

**2.9.7 IP Address Setting (TCP/IP) (Cont.)**

**NOTE:**  
After the last 3-digit value is set, press the **[PAUSE]** key to go to Socket Port Setting.

**(3) Subnet Mask**

This parameter is to set a Subnet Mask.

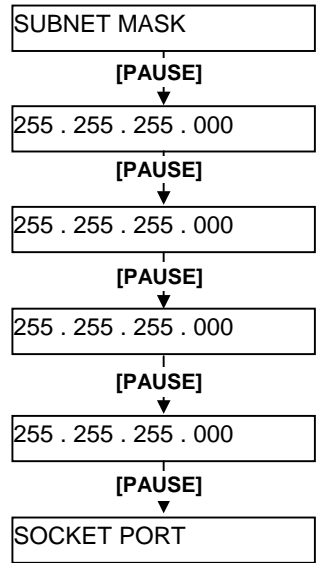

**(4) Socket Port**

This parameter is to enable a socket port and set a socket number.

**NOTES:**

1. Pressing the **[PAUSE]** key while "PORT ON 08000" is displayed allows you to set the port number.
2. Set a number for each digit by using the **[RESTART]** or **[FEED]** key.  
**[RESTART]** key: Increment  
**[FEED]** key: Decrement  
 Range: 00000 to 65535  
 A number exceeding 65535 will be automatically corrected to 65535.
3. Be careful not to set the same port number that other applications are using.
4. Press the **[PAUSE]** key to move the cursor to the next digit.
5. After the last digit is set, press the **[PAUSE]** key to go to DHCP Setting.

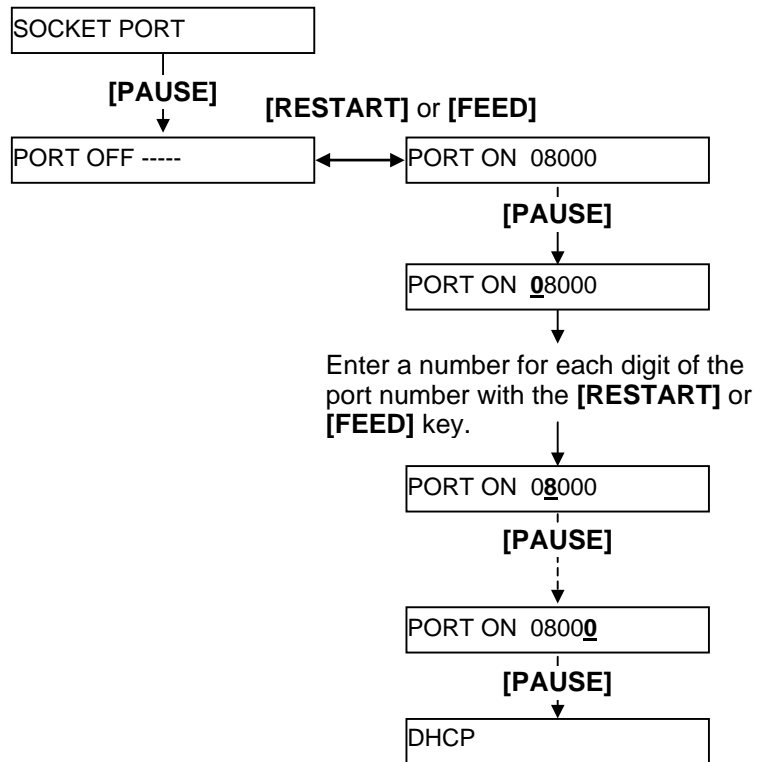

**2.9.7 IP Address Setting (TCP/IP) (Cont.)**

**NOTE:**  
Pressing the **[PAUSE]** key while "DHCP ON" is displayed allows you to set a DHCP client ID.

**(5) DHCP**

This parameter is to enable DHCP.

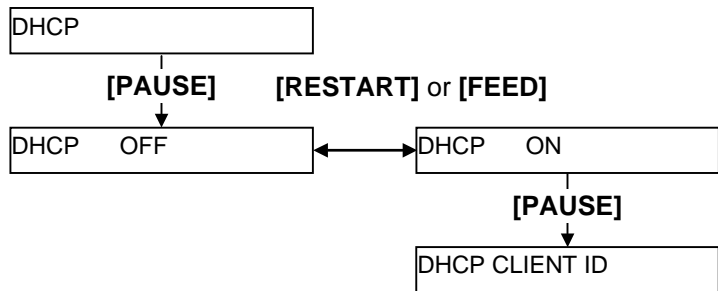

**(6) DHCP Client ID**

This parameter is to set a DHCP client ID.

**NOTES:**

- Code used to enter a DHCP client ID is selectable between ASCII code (alphanumeric) and Hex code.
- Set a character or value for each byte by using the **[RESTART]** or **[FEED]** key. **[RESTART]** key: Increment **[FEED]** key: Decrement
- Press the **[PAUSE]** key to enter the next byte. Repeat this until 16th byte is entered.
- A DHCP ID can be used to check what IP address is assigned to which client on a DHCP server. If a DHCP ID is not assigned, MAC address of a network device (LAN card or LAN interface board) will be notified to the server as a DHCP ID instead. A DHCP ID is a 16-byte character string. As "FFH" (hex. code) is recognized as a terminator, if the top byte of DHCP ID is "FFH", it is considered that a DHCP ID is not assigned.

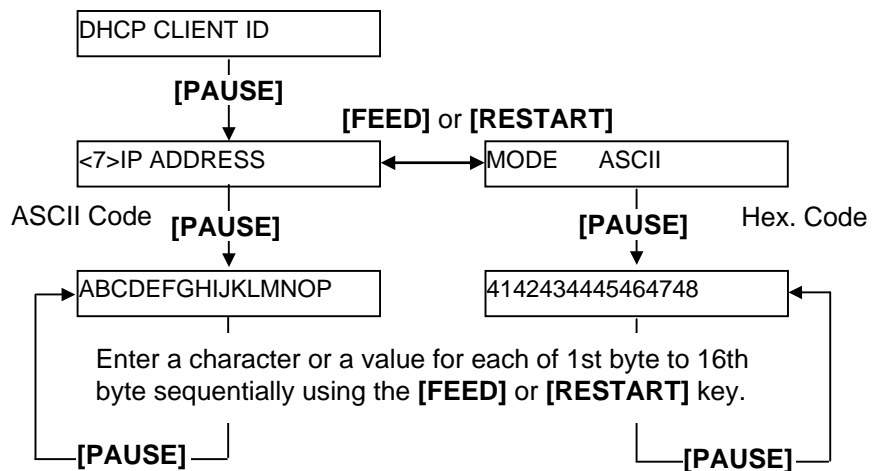

**2.9.7 IP Address Setting (TCP/IP) (Cont.)**

**(7) DHCP Host Name**

This parameter is to set a DHCP host name.

**NOTE:**  
After the 16th byte of the DHCP host name is set, press the **[PAUSE]** key. At this time, the display will turn to “<7>IP ADDRESS”.

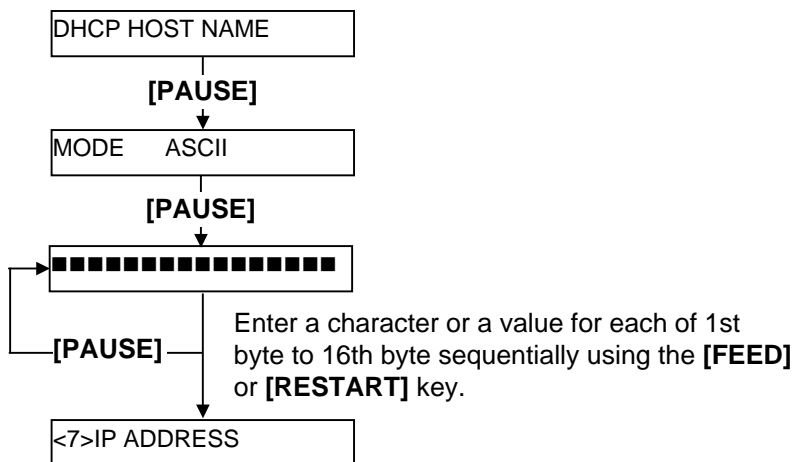

**ASCII code and Hex. code correspondence table**

Upper 4 bits \ Lower 4 bits	2	3	4	5	6	7
0	SP	0	@	P	`	p
1	!	1	A	Q	a	q
2	“	2	B	R	b	r
3	#	3	C	S	c	s
4	\$	4	D	T	d	t
5	%	5	E	U	e	u
6	&	6	F	V	f	v
7	‘	7	G	W	g	w
8	(	8	H	X	h	x
9	)	9	I	Y	i	y
A	*	:	J	Z	j	z
B	+	;	K	[	k	{
C	,	<	L	\	l	
D	-	=	M	]	m	}
E	.	>	N	^	n	/
F	/	?	O	_	o	\

SP = Space

**(Example)** To enter “TOSHIBA” in Hex. code:

54 4F 53 48 49 42 41

When the system mode settings have been completed, turn off the printer.

## 2.10 Installing the Printer Drivers

### 2.10.1. Introduction

This manual describes how to install the TOSHIBA printer driver for the TOSHIBA bar code printer on your Windows host computer; install and delete the printer driver, the procedure for adding the LAN port, cautions and limitations.

The examples provided here illustrate the procedure for installing the printer driver version V7.0 for the B-SA4T series.

### 2.10.2. General Description

#### (1) Features

Once you install the TOSHIBA printer driver on your Windows host computer, you can use the TOSHIBA bar code printer, as well as the easy-to-use general printers.

You can use this printer by connecting a parallel interface cable (printer cable), a USB cable, or a LAN cable to your host computer.

#### (2) System Requirements

To install the TOSHIBA printer driver on your host computer, the following system and environment are required:

- Operating system: Windows 98, Windows Me, Windows 2000, Windows XP
- Hardware: A DOS-/V (IBM PC/AT compatible) machine running an above operating system.
- Interface:
  - Parallel interface conforming to the IEEE1284 standard
  - USB interface
  - LAN interface

### 2.10.3. Installing the Printer Driver

The installation procedure differs depending on the interface connected to the printer and the operation system you are using. Please install the printer driver by performing the appropriate procedure.

If the previous version of the printer driver has been installed on your host computer, be sure to uninstall it before you install this printer driver. (Refer to **Section 2.10.4 Uninstalling the Printer Driver.**)

To print via your network, please install the printer driver by performing the installation procedure for the parallel interface, and also perform the following:

1. In the procedure, select “LPT1” for the port.
2. After installation of the printer driver is completed, add the LAN port by referring to **Section 2.10.5 Adding/Deleting a LAN Port**, and specify the LAN port.

#### (1) Parallel Interface

To use the parallel interface, the following settings are required, after installing the printer driver:

For Windows 98/Me:                   Open the printer properties.   Select the “Details” tab and click on the **[Spool Settings...]** button. The “Spool Settings” dialog box is displayed. Select “Disable bi-directional support for this printer”.

For Windows 2000/XP:               Open the printer properties and select the “Ports” tab. Mark off the “Enable bidirectional support” checkbox.

**NOTE:**

*In case of the B-SX4T or B-SX5T series, make sure that the Centronics interface type is set to SPP (default).*

<b>Windows 98/Me</b>
----------------------

- (1) Select “Settings” – “Printers” from the “Start” menu to open the printer folder.
- (2) Double-click on the “Add Printer” icon. The Add Printer Wizard runs. Click on the **[Next]** button.
- (3) Select “Local printer”, then click on the **[Next]** button. The screen listing “Manufacturers and Printers” is displayed.
- (4) Click on the **[Have Disk...]** button. The “Install From Disk” dialog box is displayed. Specify the “\driver” folder in the CD-ROM drive, then click on the **[OK]** button.

**NOTE:**

The latest printer driver is available from the web site.

(<http://www.toshibatec-ris.com/products/barcode/download/index.html>)

- (5) Select the printer to be installed from “Printers” list, then click on the **[Next]** button.

Driver name	Model	Driver name	Model	Driver name	Model
TEC B-372	B-372-QP	TEC B-415	B-415-GH24-QM B-415-GH25-QM	TEC B-419	B-419-GS10-QQ B-419-GS12-QP B-419-GS12-CN
TEC B-431	B-431-GS10-QP B-431-GS10-CN	TEC B-452	B-452-TS10-QQ B-452-TS10-QQ-US B-452-TS11-QQ-PAC B-452-TS12-QP B-452-TS12-QP-PAC B-452-TS12-CN	TEC B-452H	B-452-HS12-QQ B-452-HS12-QQ-US B-452-HS12-QP B-452-HS12-CN
TEC B-472	B-472-QQ B-472-QQ-US B-472-GH12-QQ B-472-QP	TEC B-472-CN	B-472-GH12-CN B-472-GH14-CN	TEC B-482	B-482-TS10-QQ B-482-TS10-QQ-US B-482-TS10-QP
TEC B-492	B-492L-TH10-QQ B-492R-TH10-QQ B-492L-TH10-QP B-492R-TH10-QP	TEC B-572	B-572-QQ B-572-QQ-US B-572-QP	TEC B-672	B-672-QQ B-672-QQ-US B-672-QP
TEC B-682	B-682-TS10-QQ B-682-TS10-QQ-US B-682-TS10-QP	TEC B-852	B-852-TS12-QQ B-852-TS12-QQ-US B-852-TS12-QP	TEC B-852-R	B-852-TS22-QQ-R B-852-TS22-QP-R
TEC B-872	B-872-QQ B-872-QQ-US B-872-QP	TEC B-882	B-882-TS10-QQ B-882-TS10-QQ-US B-882-TS10-QP	TEC B-SA4G	B-SA4TM-GS12-QM-R B-SA4TP-GS12-QM-R
TEC B-SA4T	B-SA4TM-TS12-QM-R B-SA4TP-TS12-QM-R	TEC B-SA4T-CN	B-SA4TM-TS12-CN B-SA4TP-TS12-CN	TEC B-SP2D	B-SP2D-GH20-QM B-SP2D-GH30-QM B-SP2D-GH30-QM B-SP2D-GH20-QM-R B-SP2D-GH30-QM-R B-SP2D-GH30-QM-R
TEC B-SV4	B-SV4D-GS10-QM B-SV4D-GH10-QM B-SV4D-GS10-QM-R B-SV4D-GH10-QM-R	TEC B-SX4	B-SX4T-GS10-QQ B-SX4T-GS10-QQ-US B-SX4T-GS10-QP B-SX4T-GS20-QQ B-SX4T-GS20-QQ-US B-SX4T-GS20-QP B-SX4T-GS20-QM-R	TEC B-SX4-CN	B-SX4T-GS10-CN B-SX4T-GS20-CN
TEC B-SX5	B-SX5T-TS12-QQ B-SX5T-TS12-QQ-US B-SX5T-TS12-QP B-SX5T-TS22-QQ B-SX5T-TS22-QQ-US B-SX5T-TS22-QP B-SX5T-TS22-QM-R	TEC B-SX5-CN	B-SX5T-TS12-CN B-SX5T-TS22-CN	TEC B-SX6T-R	B-SX6T-TS12-QM-R
TEC B-SX8T-R	B-SX8T-TS12-QM-R	TEC CB-416-T3	CB-416-T3-QQ CB-416-T3-QQ-US CB-416-T3-QP	TEC CB-426-T3	CB-426-T3-QQ CB-426-T3-QQ-US CB-426-T3-QP

- (6) The screen to select the existing installed printer driver or use the new one, is displayed. Select “Replace existing driver”, then click on the **[Next]** button. If you install the printer driver for the first time, this screen is not displayed.
- (7) Select the port to be used for printing from the “Available ports” list, then click on the **[Next]** button.
- (8) Change the printer name if necessary, and select whether or not you use the printer as the default printer (“Yes” or “No”). Click on the **[Finish]** button.
- (9) The printer driver is installed. When installation is completed, the new printer icon is added in the “Printers” folder.



**Windows 2000/XP**

- (1) Log on to your host computer as a member who has full control access privilege concerning the printer settings.
- (2) Select “Settings” – “Printers” from the “Start” menu to open the printer folder.
- (3) Double-click on the “Add Printer” icon. The Add Printer Wizard runs. Click on the **[Next]** button.
- (4) Select “Local printer”. Mark off the “Automatically detect and install my Plug and Play printer” checkbox, then click on the **[Next]** button.
- (5) Select the port to be used for printing from the “Available ports” list, then click on the **[Next]** button.
- (6) On the screen listing “Manufacturers and Printers”, click on the **[Have Disk...]** button. The “Install From Disk” dialog box is displayed.
- (7) Specify the “\driver” folder in the CD-ROM drive, then click on the **[OK]** button.

**NOTE:**

The latest printer driver is available from the web site.

(<http://www.toshibatec-ris.com/products/barcode/download/index.html>)

- (8) Select the printer to be installed from “Printers” list, then click on the **[Next]** button.

Driver name	Model	Driver name	Model	Driver name	Model
TEC B-372	B-372-QP	TEC B-415	B-415-GH24-QM B-415-GH25-QM	TEC B-419	B-419-GS10-QQ B-419-GS12-QP B-419-GS12-CN
TEC B-431	B-431-GS10-QP B-431-GS10-CN	TEC B-452	B-452-TS10-QQ B-452-TS10-QQ-US B-452-TS11-QQ-PAC B-452-TS12-QP B-452-TS12-QP-PAC B-452-TS12-CN	TEC B-452H	B-452-HS12-QQ B-452-HS12-QQ-US B-452-HS12-QP B-452-HS12-CN
TEC B-472	B-472-QQ B-472-QQ-US B-472-GH12-QQ B-472-QP	TEC B-472-CN	B-472-GH12-CN B-472-GH14-CN	TEC B-482	B-482-TS10-QQ B-482-TS10-QQ-US B-482-TS10-QP
TEC B-492	B-492L-TH10-QQ B-492R-TH10-QQ B-492L-TH10-QP B-492R-TH10-QP	TEC B-572	B-572-QQ B-572-QQ-US B-572-QP	TEC B-672	B-672-QQ B-672-QQ-US B-672-QP
TEC B-682	B-682-TS10-QQ B-682-TS10-QQ-US B-682-TS10-QP	TEC B-852	B-852-TS12-QQ B-852-TS12-QQ-US B-852-TS12-QP	TEC B-852-R	B-852-TS22-QQ-R B-852-TS22-QP-R
TEC B-872	B-872-QQ B-872-QQ-US B-872-QP	TEC B-882	B-882-TS10-QQ B-882-TS10-QQ-US B-882-TS10-QP	TEC B-SA4G	B-SA4TM-GS12-QM-R B-SA4TP-GS12-QM-R
TEC B-SA4T	B-SA4TM-TS12-QM-R B-SA4TP-TS12-QM-R	TEC B-SA4T-CN	B-SA4TM-TS12-CN B-SA4TP-TS12-CN	TEC B-SP2D	B-SP2D-GH20-QM B-SP2D-GH30-QM B-SP2D-GH30-QM B-SP2D-GH20-QM-R B-SP2D-GH30-QM-R B-SP2D-GH30-QM-R
TEC B-SV4	B-SV4D-GS10-QM B-SV4D-GH10-QM B-SV4D-GS10-QM-R B-SV4D-GH10-QM-R	TEC B-SX4	B-SX4T-GS10-QQ B-SX4T-GS10-QQ-US B-SX4T-GS10-QP B-SX4T-GS20-QQ B-SX4T-GS20-QQ-US B-SX4T-GS20-QP B-SX4T-GS20-QM-R	TEC B-SX4-CN	B-SX4T-GS10-CN B-SX4T-GS20-CN
TEC B-SX5	B-SX5T-TS12-QQ B-SX5T-TS12-QQ-US B-SX5T-TS12-QP B-SX5T-TS22-QQ B-SX5T-TS22-QQ-US B-SX5T-TS22-QP B-SX5T-TS22-QM-R	TEC B-SX5-CN	B-SX5T-TS12-CN B-SX5T-TS22-CN	TEC B-SX6T-R	B-SX6T-TS12-QM-R
TEC B-SX8T-R	B-SX8T-TS12-QM-R	TEC CB-416-T3	CB-416-T3-QQ CB-416-T3-QQ-US CB-416-T3-QP	TEC CB-426-T3	CB-426-T3-QQ CB-426-T3-QQ-US CB-426-T3-QP

- (9) The “Use Existing Driver” screen is displayed. Select “Replace existing driver”, then click on the **[Next]** button. If you install the printer driver for the first time, this screen is not displayed.
- (10) Change the printer name if necessary, and select whether or not you use the printer as the default printer (“Yes” or “No”). Click on the **[Next]** button.
- (11) Select whether or not the printer will be shared with other network users (“Shared” or “Not shared”). Click on the **[Next]** button.
- (12) Select whether or not the test page will be printed (“Yes” or “No”), then click on the **[Finish]** button.
- (13) If the “Digital Signature Not Found” screen is displayed, click on the **[Yes]** button.
- (14) When the “Completing the Add Printer Wizard” screen is displayed, click on the **[Finish]** button.
- (15) When installation is completed, the new printer icon is added in the “Printers” folder.

## (2) USB INTERFACE

Installation starts by the operating system's plug-and-play function.

### Windows 98/Me

- (1) Turn the printer ON, then connect it to your host computer with the USB cable.  
The "New Hardware Found" dialog box is displayed, and "USB Device" is detected.

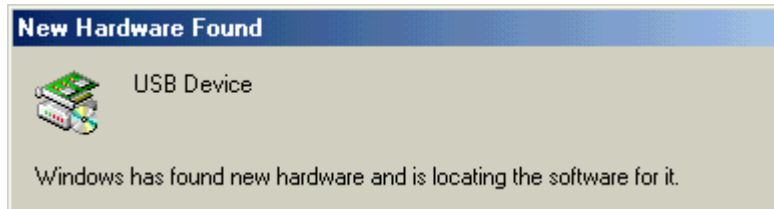

- (2) After a while, the "Add New Hardware Wizard" dialog box is displayed. Select "Specify the location of the driver (Advanced)", then click on the **[Next]** button.



- (3) Select “Search for the best driver for your device. (Recommended)”  
Mark the “Specify a location” checkbox, then click on the **[Browse]** button.  
Specify “\driver” folder, then click on the **[Next]** button.

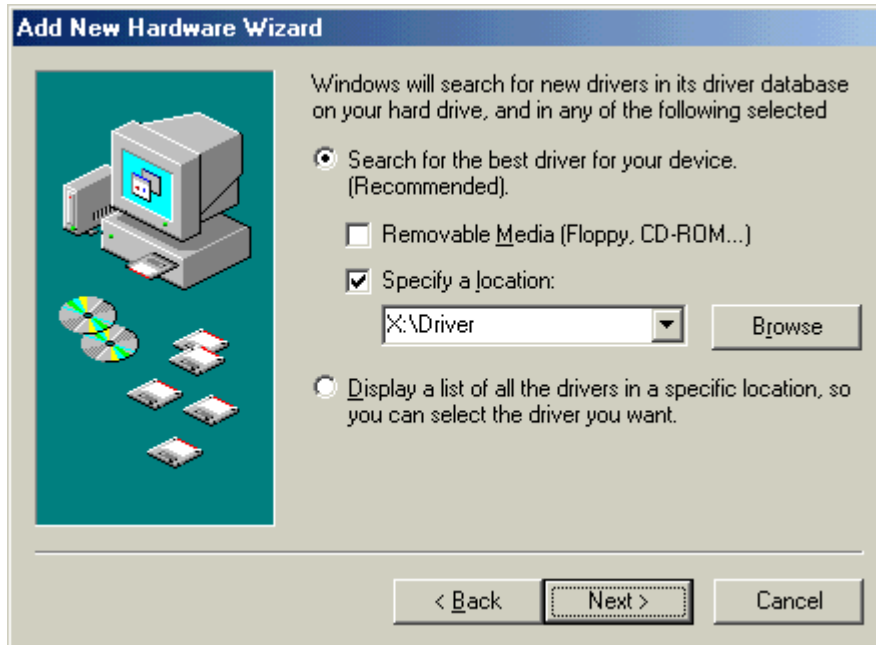

- (5) When the screen which indicates the USB Printing Support driver has been installed, is displayed, click on the **[Finish]** button.



- (6) After a while, “TEC B-SA4T” is detected as a new hardware.

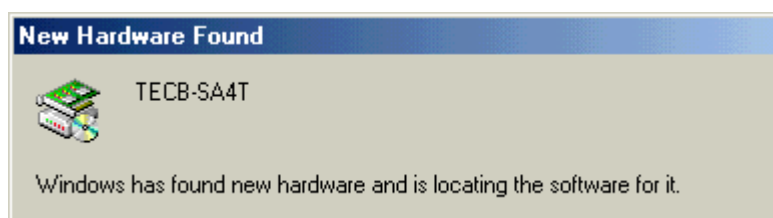

- (7) The “Add New Hardware Wizard” dialog box is displayed. Select “Specify the location of the driver (Advanced)”, then click on the **[Next]** button.



- (8) Select “Search for the best driver for your device. (Recommended)”  
Mark the “Specify a location” checkbox, then click on the **[Browse]** button.  
Specify “\driver” folder, then click on the **[Next]** button.



- (9) Check to see that the “TEC B-SA4T” driver is detected, then click on the **[Next]** button.

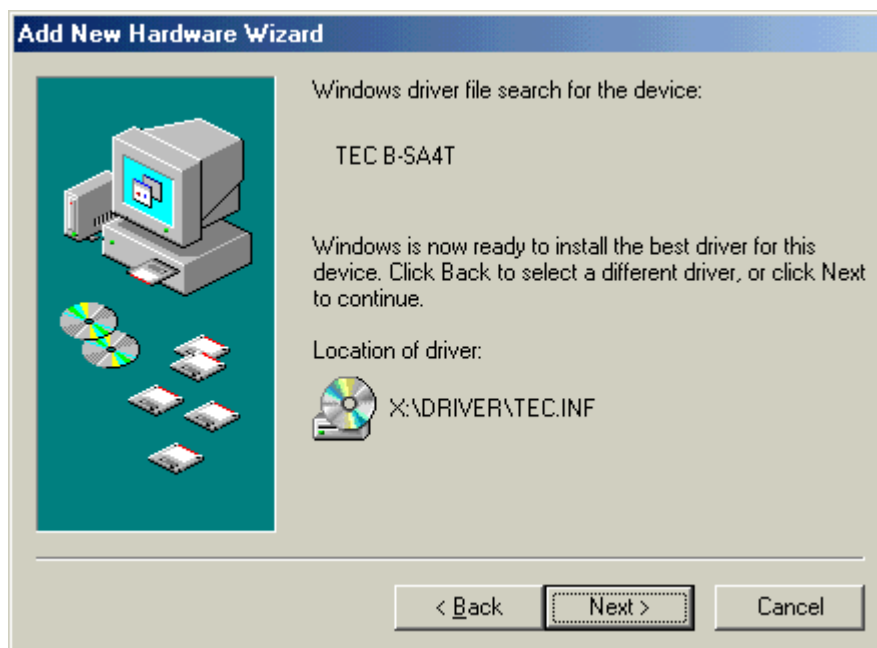

- (10) Change the printer name if necessary, and select whether or not you use the printer as the default printer (“Yes” or “No”). Click on the **[Finish]** button.

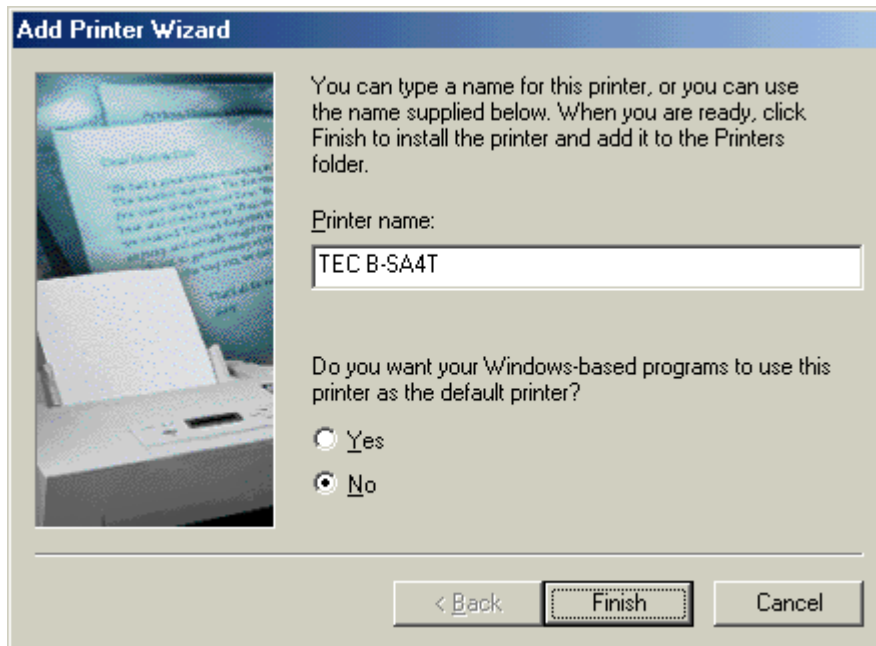

- (11) When the screen, which indicates TEC B-SA4T has been installed, is displayed, click on the **[Finish]** button.



- (12) When installation is completed, the new printer icon is added in the “Printers” folder.

**Windows 2000/XP****NOTE:**

*When plug-and-play printer installation in progress is stopped, be sure to delete the printer detected and displayed on the “Device Manager” tab of the “System Properties” dialog box.*

- (1) Log on to your host computer as a member who has full control access privilege concerning the printer settings.
- (2) Turn the printer ON, then connect it to your host computer with the USB cable.
- (3) “USB Device” is automatically detected, and “USB Printing Support” is automatically installed.
- (4) After a while, for Windows XP, “**TEC B-SA4T**” is detected as a new device.  
For Windows 2000, “Unknown” device is detected as a new device. In both cases, perform the following steps, though dialog boxes for Windows XP are used.
- (5) The “Found New Hardware Wizard” dialog box is displayed.  
Select “No, not this time”, then click on the **[Next]** button.





- (6) Select “Install from a list or specific location (Advanced)”, then click on the **[Next]** button.

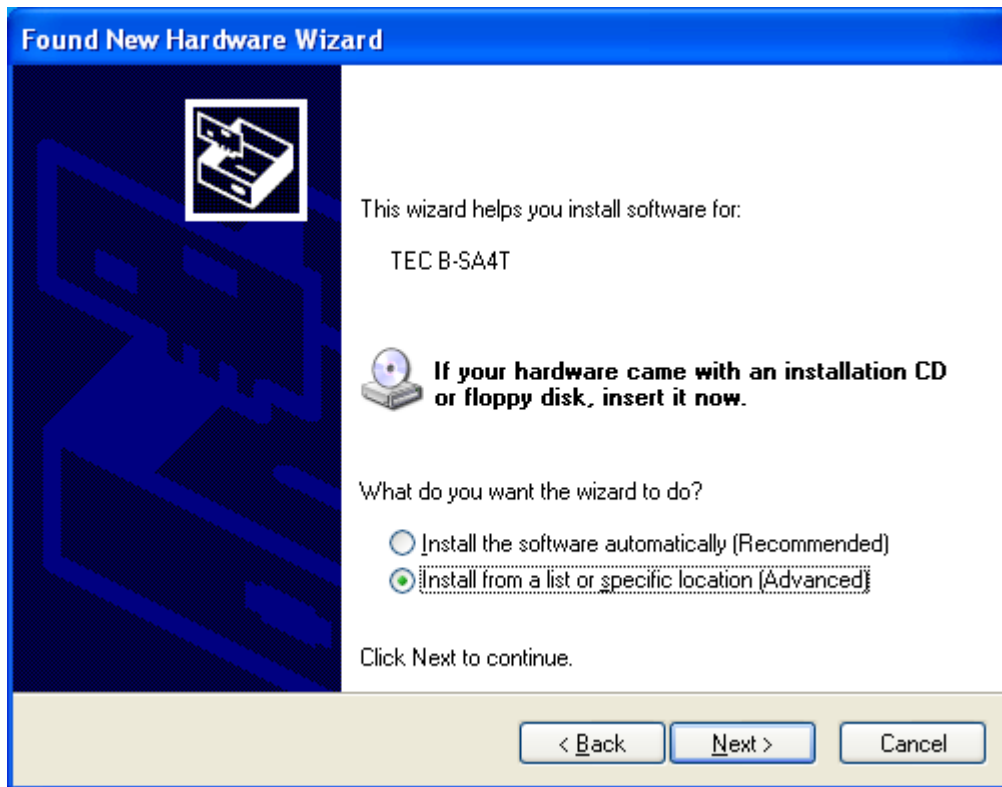

- (7) Select “Search for the best driver in these locations”. Mark the “Include this location in the search” checkbox, then click on the **[Browse]** button. Specify the “\driver” folder in the CD-ROM, then click on the **[Next]** button.

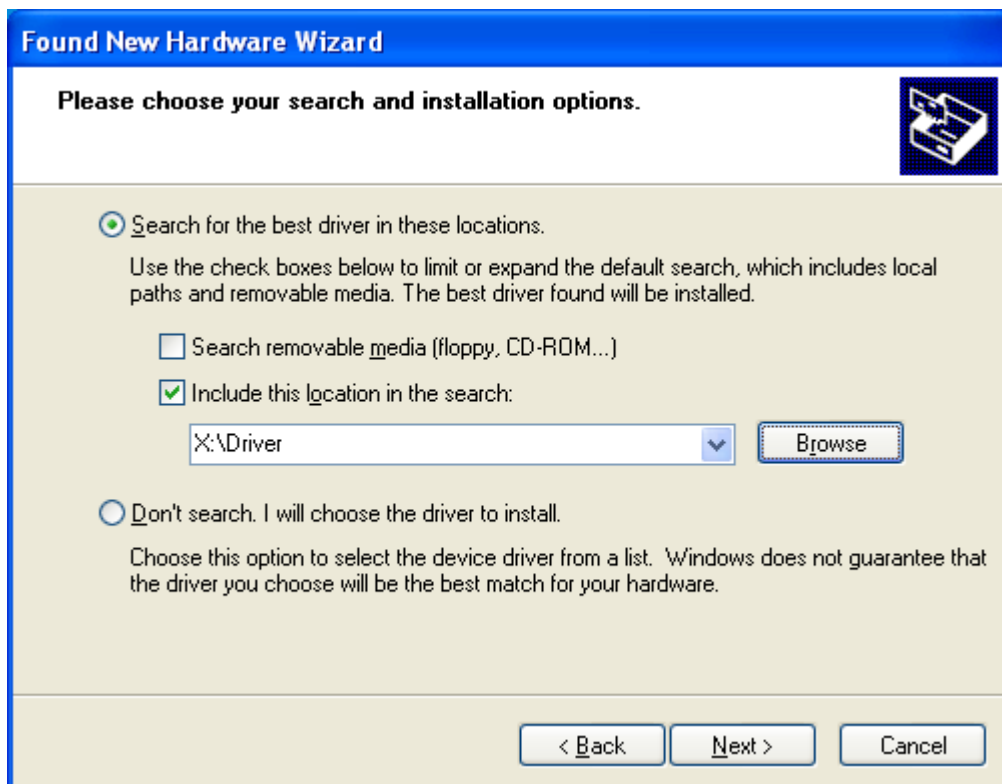

- (8) When the dialog box below is displayed, click on the **[Continue Anyway]** button.



- (9) When the "Completing the Found New Hardware Wizard" screen is displayed, click on the **[Finish]** button.

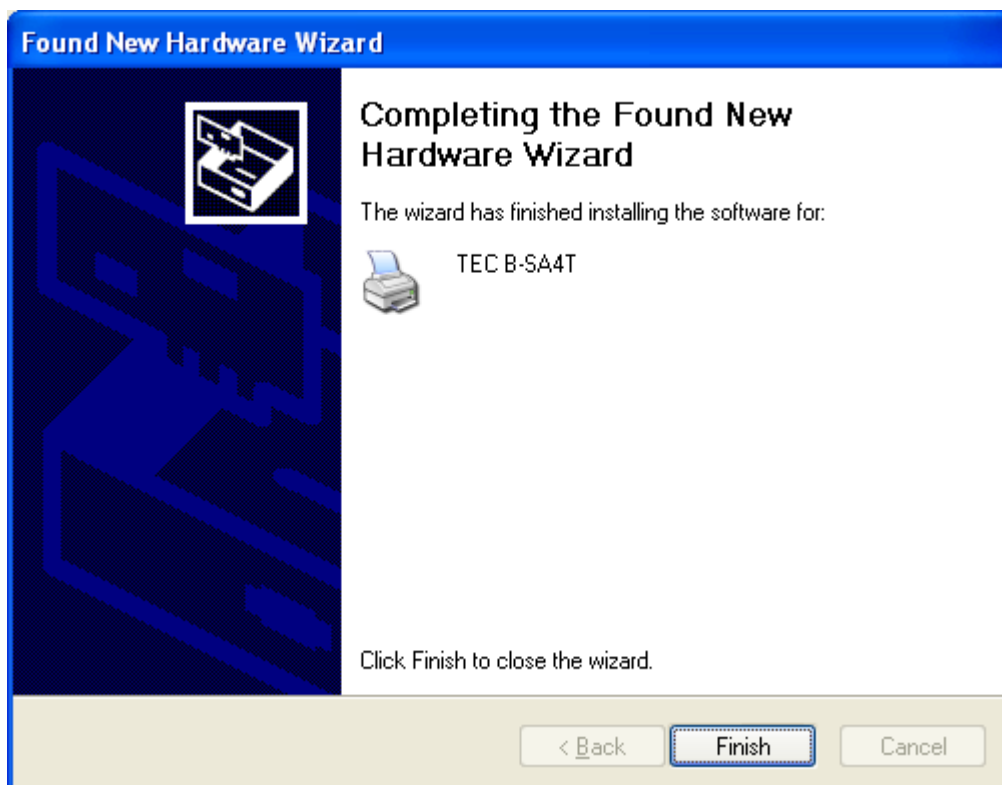

- (10) When installation is completed, the new printer icon is added in the "Printers" folder.

### 2.10.4. Uninstalling the Printer Driver

**NOTE:**

*Before uninstalling the printer driver, be sure to complete all of printing, the status monitor, and properties settings.*

**Windows 98/ME**

- (1) Select “Settings” – “Printers” from the “Start” menu to open the printer folder.
- (2) Right-click on the printer driver icon to be deleted, then select “Delete”. The confirmation message is displayed.
- (3) Click on the **[Yes]** button to delete.
- (4) After the printer driver icon is deleted, restart your host computer.

**Windows 2000/XP**

- (1) Log on to your host computer as a member who has full control access privilege concerning the printer settings.
- (2) Select “Settings” – “Printers” from the “Start” menu to open the printer folder.
- (3) Right-click on the printer driver icon to be deleted, then select “Delete”. The confirmation message is displayed.
- (4) Click on the **[Yes]** button to delete.
- (5) After the printer icon is deleted, select “Server Properties” from “File” menu of the “Printers” folder.
- (6) Select the printer driver to be deleted, then click on the **[Remove]** button. After the printer driver is deleted, restart your host computer.

### 2.10.5 Adding/Deleting a LAN Port

To use the LAN interface, first, you have to make the following settings in “<7> IP ADDRESS” in the system mode of the printer. (Refer to TOSHIBA TEC support representative.)

- Set the printer IP address (“**PRINTER IP ADRES**”), the gateway IP address (“**GATEWAY IP ADRES**”), and subnet mask (“**SUBNET MASK**”).
- Set the port number (“**SOCKET PORT**”).

Among these settings, the printer IP address and the port number are also required for adding a LAN port.

#### (1) Adding a LAN Port

##### Windows 98/ME

- (1) Right-click on the printer icon. Select “Properties” to open the printer “Properties” dialog box.
- (2) Select the “Details” tab, and click on the **[Add Port...]** button. The “Add Port” dialog box is displayed.
- (3) Select “Other”.  
Select “Seagull Scientific TCP/IP Port” from the list, then click on the **[OK]** button.
- (4) On the “Add Seagull TCP/IP Port” dialog box, enter the name or IP address, the port number, and the port name. For the IP address and the port number, enter the same ones as you have set in “<7> IP ADDRESS” in the system mode of the printer. After entering these, click on the **[OK]** button.

- (5) When addition of the port is completed, the port is added to the drop down list for “Print to the following port”.

**Windows 2000/XP**

- (1) Right-click on the printer icon. Select “Properties” to open the printer “Properties” dialog box.
- (2) Select the “Ports” tab, and click on the **[Add Port...]** button. The “Printer Ports” dialog box is displayed.
- (3) Select “Seagull Scientific TCP/IP Port” from the “Available Printer Ports” list, then click on the **[OK]** button.
- (4) On the “Add Seagull TCP/IP Port” dialog box, enter the name or IP address, the port number, and the port name. For the IP address and the port number, enter the same ones as you have set in “<7> **IP ADDRESS**” in the system mode of the printer. After entering these, click on the **[OK]** button.
- (5) When addition of the port is completed, the port is added to the “Print to the following port(s)” list.

**(2) Deleting a LAN Port****NOTE:**

*Before deleting a port, be sure to check if other printers also use it. If there are printers which use the port to be deleted, change their port to another, before deleting the port.*

**Windows 98/ME**

- (1) Right-click on the printer icon. Select “Properties” to open the printer “Properties” dialog box.
- (2) Select the “Details” tab, and click on the **[Delete Port...]** button.
- (3) Select the port to be deleted, then click on the **[OK]** button.
- (4) When deletion of the port is completed, the port is also deleted from the “Print to the following port” list.

**Windows 2000/XP**

- (1) Right-click on the printer icon. Select “Properties” to open the printer “Properties” dialog box.
- (2) On the “Ports” tab, select the port to be deleted, then click on the **[Delete Port]** button.
- (3) When deletion of the port is completed, the port is also deleted from the “Print to the following port(s)” list.

### 2.10.6 Cautions

#### (1) Printer Driver Upgrades

- To upgrade the printer driver to this version, uninstall the previous version of the printer driver, before installing this printer driver.
- Be sure to restart your host computer, after you upgrade the printer driver.
- When your operating system is Windows 98, or Windows Me, be sure to restart your host computer, after you uninstall the previous version of the printer driver. Or, the printer driver is not upgraded properly.

#### (2) Others

- If your operating system is Windows 2000 or Windows XP, when plug-and-play printer installation in progress is stopped, be sure to delete the printer detected and displayed on the “Device Manager” tab of the “System Properties” dialog box.
- Before uninstalling the printer driver, be sure to complete all of printing, the status monitor, and properties settings.
- Before deleting a port, be sure to check if other printers also use it. If there are printers which use the port to be deleted, change their port to another, before deleting the port.

### 2.10.7 Using the Printer Driver

For how to use the Printer Driver, please refer to the Help for Windows Printer Drivers screen.

- 1) Open the Properties screen of the Printer Driver.
- 2) Clicking on the **About** tab causes the following screen to appear.  
Click on the **[Help]** button.

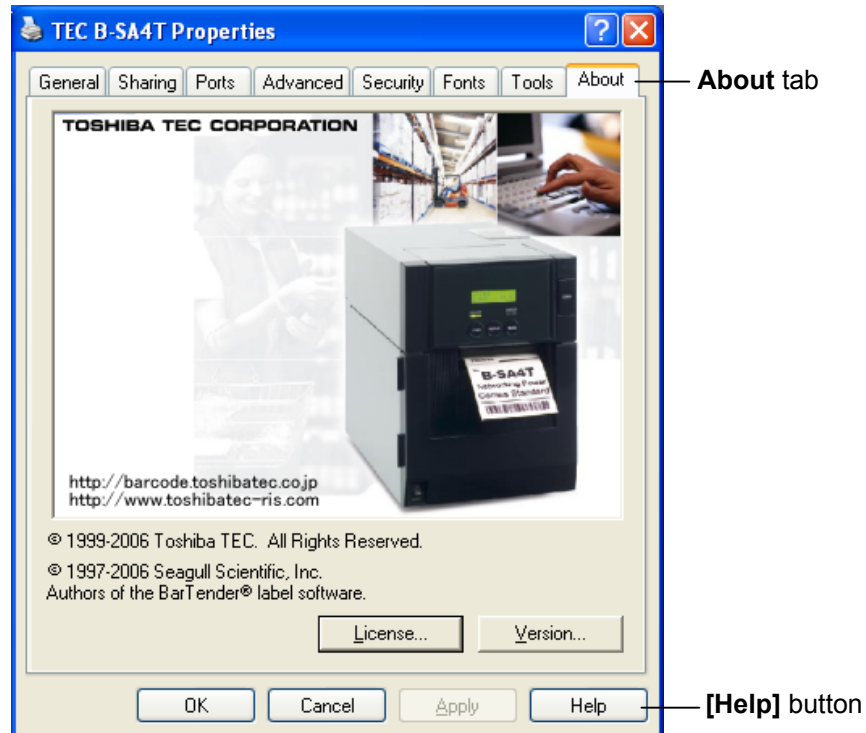

- 3) The Help for Windows Printer Drivers screen appears. This screen will provide how to use the printer driver.

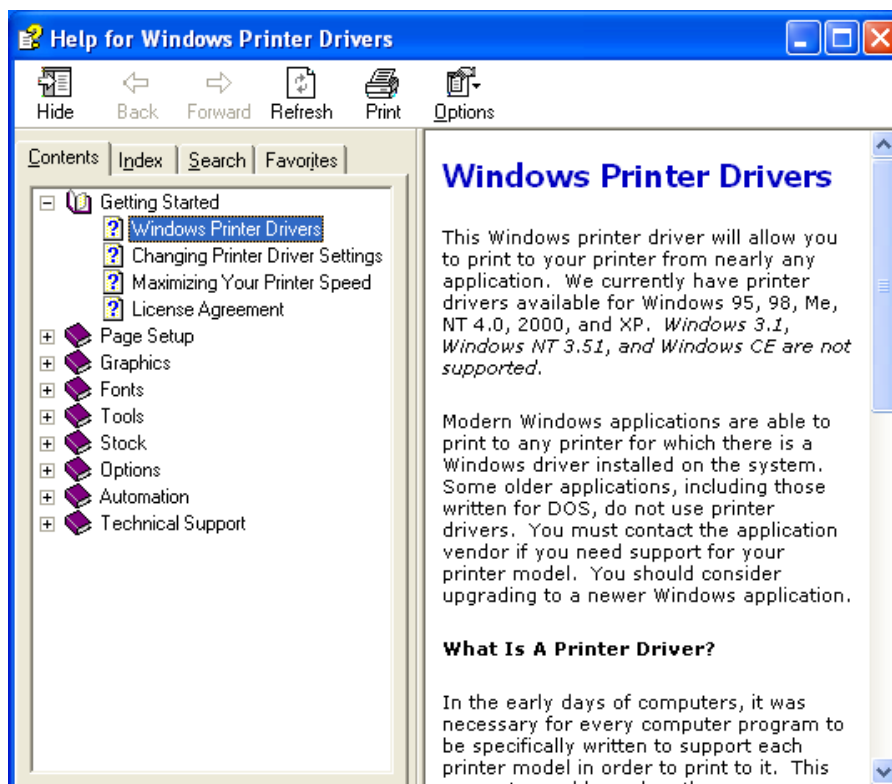

## 2.11 Print Test

After your operating environment has been set, perform a print test.

### 1. Perform a print test by using the Printer Driver or an Issue Command.

The printer driver's Properties screen allows you to set the communication conditions, media size, and other printing conditions in accordance with your operating environment. For details, refer to the **Help for the Windows Printer Drivers** screen.

Example: Stock tab display of the Printer Driver's Properties Screen

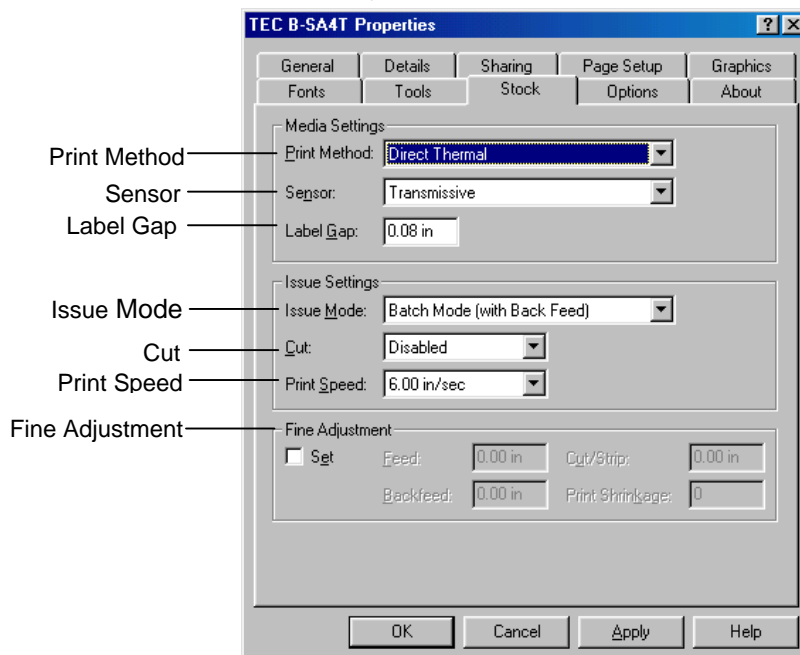

- |                  |   |
|------------------|---|
| Print Method:    | Direct thermal or thermal transfer is selectable.                           |
| Sensor:          | Media sensor type is selectable.  |
| Issue Mode:      | Batch or strip is selectable.   |
| Cut:             | Whether to use the cutter or not is selectable.                             |
| Fine Adjustment: | Adjustment values for the feed amount, cut/strip position, etc. can be set. |

### 2. Confirm the print test result.

- When a print start position, cut/strip position, or print tone needs to be adjusted: ⇒ **Section 2.12 Position and Print Tone Fine Adjustment**
- When pre-printed media is used, and if a print start position is not properly detected: ⇒ **Section 2.13 Threshold Setting**



## 2.11 Print Test (Cont.)

### When using an optional Cutter Module

It is necessary to set the issue mode, cut position, etc. for the Printer Driver or TPCL (TEC Printer Command Language) in accordance with your printing condition.

For details of the TPCL, refer to the **B-852 Series External Equipment Interface Specification** stored in the CD-ROM.

Regarding how to use the Printer Driver, refer to the **Help for the Windows Printer Drivers** screen.

To gain maximum performance and life from the Cutter Module, periodic cleaning is required.

Before starting a cleaning, be sure to TURN OFF the printer to avoid risk of injury.

For details of cleaning, refer to **Section 4.1.3 Optional Cutter Module**.

## 2.12 Position and Print Tone Fine Adjustment

This section describes how to fine adjust a print start position, cut/strip position, reverse feed amount, print tone, and ribbon motor torque. When a fine adjustment is required, such as print start position, print tone, etc, follow the procedure below.

1. Turn on the printer and confirm that “ONLINE” appears on the LCD Message Display.
2. Press the **[PAUSE]** key to pause the printer.
3. Hold down the **[RESTART]** key for three seconds until “<1>RESET” is displayed.
4. Press the **[FEED]** or **[RESTART]** key until “<3>ADJUST SET” appears on the LCD Message Display.
5. When “<3>ADJUST SET” appears, press the **[PAUSE]** key to enter the Parameter Fine Adjustment Mode.

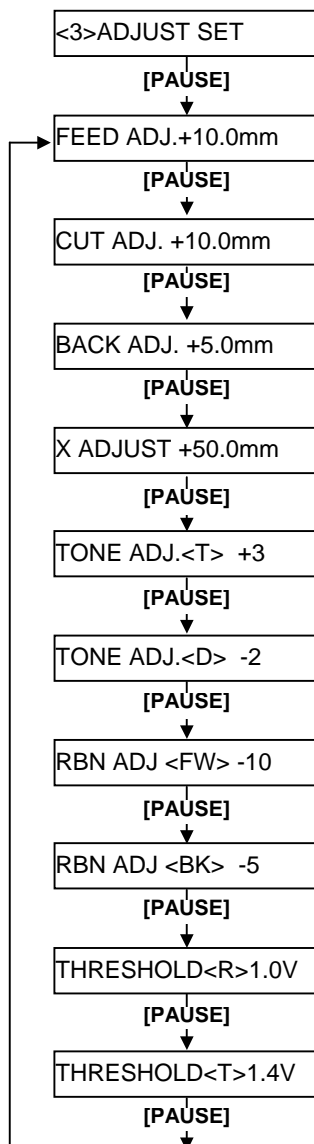

The Parameter Fine Adjustment Mode contains the following sub menus. Each time the **[PAUSE]** key is pressed, the sub menus are displayed sequentially.

- (1) **Feed Amount Fine Adjustment:**  
Feed amount to the print start position is fine adjusted.
- (2) **Cut Position Fine Adjustment:**  
Cut position is fine adjusted.
- (3) **Reverse Feed Amount Fine Adjustment:**  
Reverse feed amount is fine adjusted.
- (4) **X-coordinate Fine Adjustment:**  
X-coordinate of a print position is fine adjusted.
- (5) **Print Tone Fine Adjustment (Thermal transfer):**  
Print tone is fine adjusted for thermal transfer mode.
- (6) **Print Tone Fine Adjustment (Thermal direct):**  
Print tone is fine adjusted for thermal direct mode.
- (7) **Ribbon Motor Drive Voltage Fine Adjustment (Take-up motor):**  
Drive voltage of the ribbon take-up motor is fine adjusted.
- (8) **Ribbon Motor Drive Voltage Fine Adjustment (Feed motor)**  
Drive voltage of the ribbon feed motor is fine adjusted.
- (9) **Threshold Fine Adjustment (Black mark sensor):**  
Threshold for the black mark sensor is fine adjusted. See **Section 2.13**.
- (10) **Threshold Fine Adjustment (Feed gap sensor):**  
Threshold for the feed gap sensor is fine adjusted. See **Section 2.13**.

**NOTE:**

The printer driver's properties screen also has Parameter Fine Adjustment menu.

## 2.12 Position and Print Tone Fine Adjustment (Cont.)

### Print Start Position Fine Adjustment

**NOTES:**  
 Choose a desired value by using the **[RESTART]** or **[FEED]** key.  
 Pressing the **[FEED]** key one time causes a  $-0.1\text{mm}$  change, up to  $-50.0\text{mm}$ .  
 Pressing the **[RESTART]** key one time causes a  $+0.1\text{mm}$  change, up to  $+50.0\text{mm}$ .

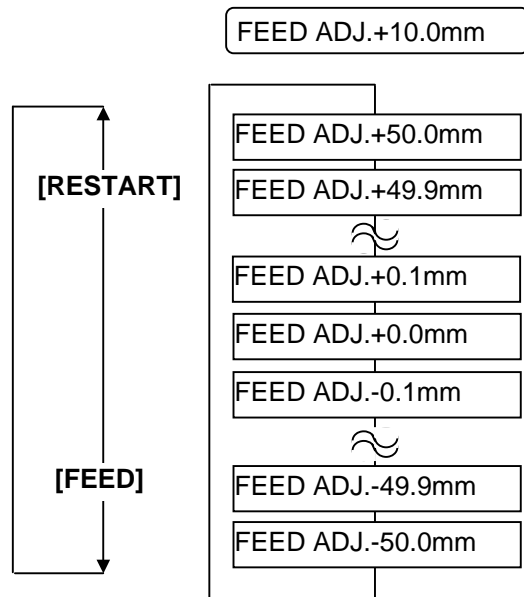

After selecting a fine adjustment value, press the **[PAUSE]** key.

#### • Example of Print Start Position Fine Adjustment

When setting  $+3.0\text{mm}$

Compared with “ $+0.0\text{mm}$ ” position, the print start position is shifted forward.

When setting  $+0.0\text{mm}$

When setting  $-3.0\text{mm}$

Compared with “ $+0.0\text{mm}$ ” position, the print start position is shifted backward.

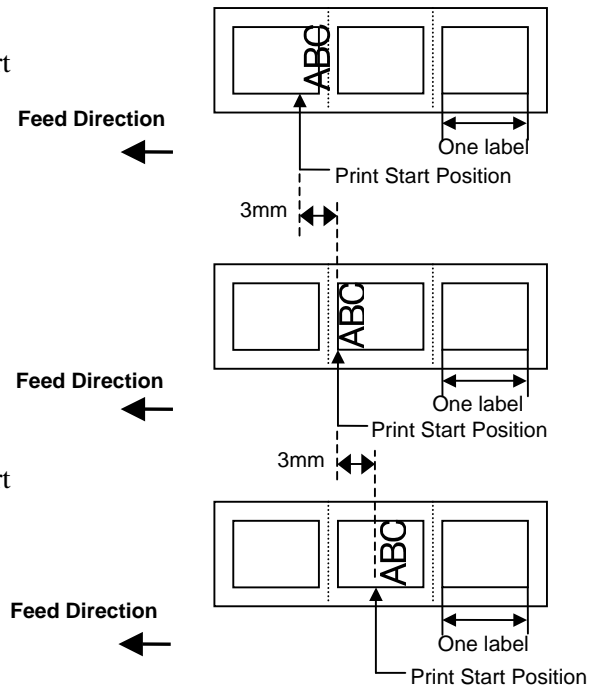

## 2.12 Position and Print Tone Fine Adjustment (Cont.)

### Cut Position Fine Adjustment

**NOTES:**  
 Choose a desired value by using the **[RESTART]** or **[FEED]** key.  
 Pressing the **[FEED]** key one time causes a  $-0.1\text{mm}$  change, up to  $-50.0\text{ mm}$ .  
 Pressing the **[RESTART]** key one time causes a  $+0.1\text{mm}$  change, up to  $+50.0\text{ mm}$ .

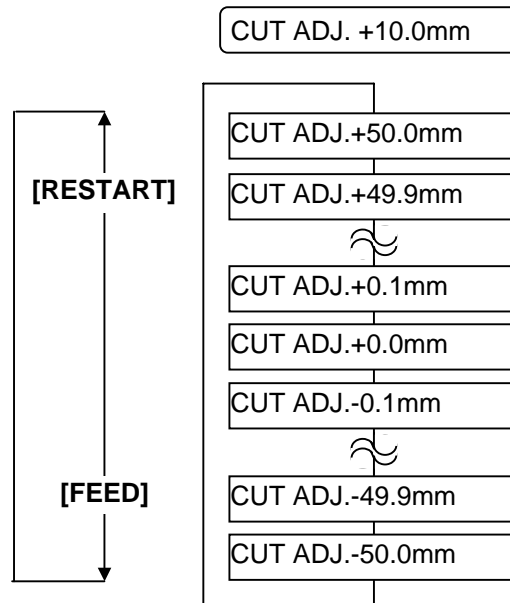

After selecting a fine adjustment value, press the **[PAUSE]** key.

#### • Example of Cut Position Fine Adjustment

When setting  $+3.0\text{ mm}$

Compared with “ $+0.0\text{mm}$ ” position, the cut position is shifted forward.

When setting  $+0.0\text{ mm}$

When setting  $-3.0\text{ mm}$

Compared with “ $+0.0\text{mm}$ ” position, the cut position is shifted backward.

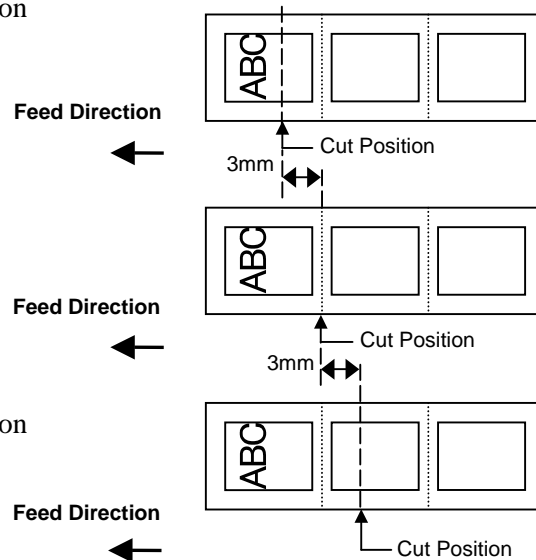

## 2.12 Position and Print Tone Fine Adjustment (Cont.)

### Reverse Feed Amount Fine Adjustment

**NOTES:**  
 Choose a desired value by using the **[RESTART]** or **[FEED]** key.  
 Pressing the **[FEED]** key one time causes a  $-0.1\text{mm}$  change, up to  $-9.9\text{mm}$ .  
 Pressing the **[RESTART]** key one time causes a  $+0.1\text{mm}$  change, up to  $+9.9\text{mm}$ .

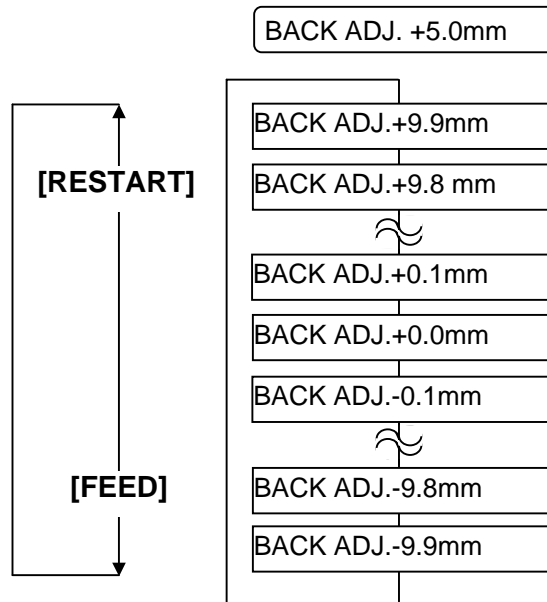

After selecting a fine adjustment value, press the **[PAUSE]** key.

#### • Example of Reverse Feed Amount Fine Adjustment

When setting  $+3.0\text{mm}$

Compared with “ $+0.0\text{mm}$ ” position, the print start position after a reverse feed is shifted forward.

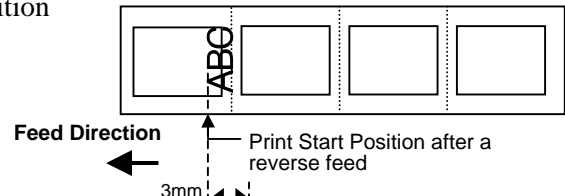

When setting  $+0.0\text{mm}$

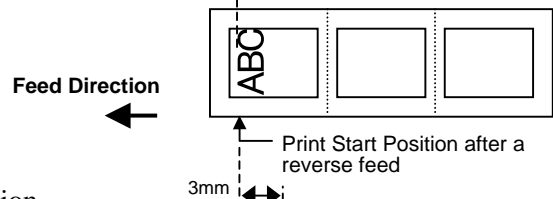

When setting  $-3.0\text{mm}$

Compared with “ $+0.0\text{mm}$ ” position, the print start position after a reverse feed is shifted backward.

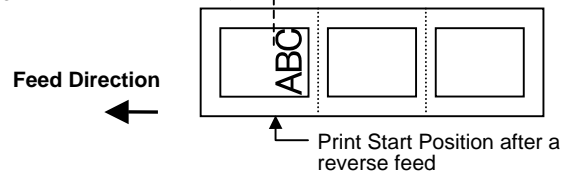

## 2.12 Position and Print Tone Fine Adjustment (Cont.)

### X Coordinate Fine Adjustment

**NOTES:**  
 Choose a desired value by using the **[RESTART]** or **[FEED]** key.  
 Pressing the **[FEED]** key one time causes a  $-0.1\text{mm}$  change, up to  $-99.9\text{mm}$ .  
 Pressing the **[RESTART]** key one time causes a  $+0.1\text{mm}$  change, up to  $+99.9\text{mm}$ .

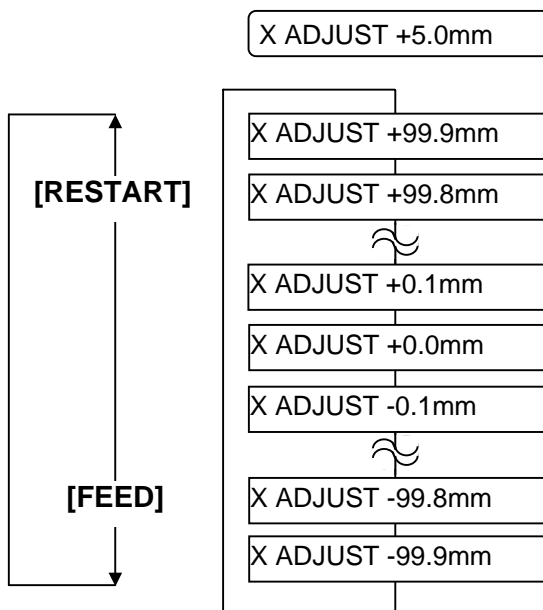

After selecting a fine adjustment value, press the **[PAUSE]** key.

#### • Example of X Coordinate Fine Adjustment

When setting  $-50.0\text{mm}$   
 Compared with “ $+0.0\text{mm}$ ” position, the print position is shifted to the left.

When setting  $+0.0\text{mm}$

When setting  $+50.0\text{mm}$   
 Compared with “ $+0.0\text{mm}$ ” position, the print position is shifted to the right.

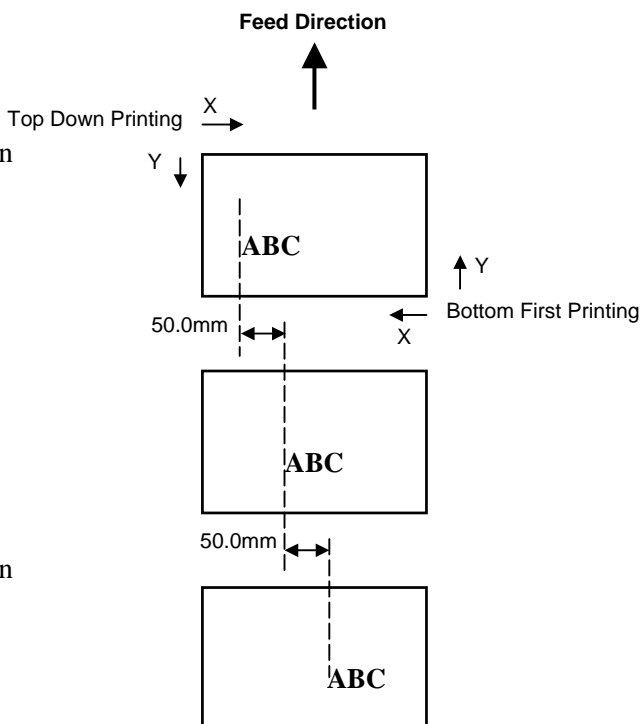

## 2.12 Position and Print Tone Fine Adjustment (Cont.)

### Print Tone Fine Adjustment

#### Thermal Transfer Print

**NOTES:**  
 Choose a desired value by using the **[RESTART]** or **[FEED]** key.  
 Pressing the **[FEED]** key one time causes a -1 tone change, up to -10 tones.  
 Pressing the **[RESTART]** key one time causes a +1 tone change, up to +10 tones.

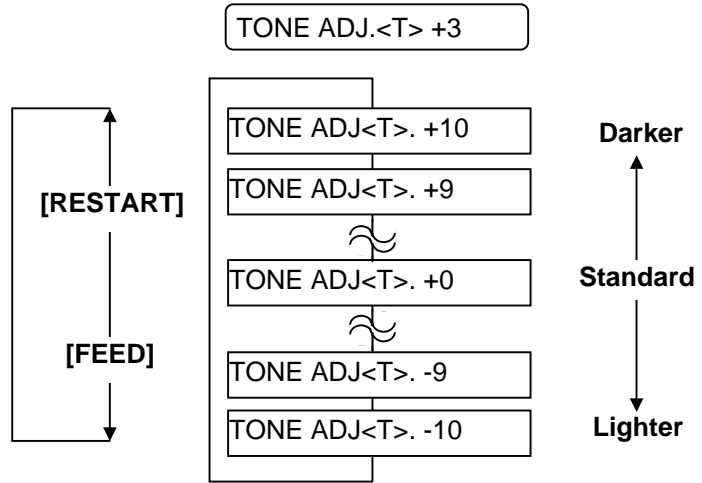

After selecting a fine adjustment value or to skip this menu, press the **[PAUSE]** key.

#### Thermal Direct Print

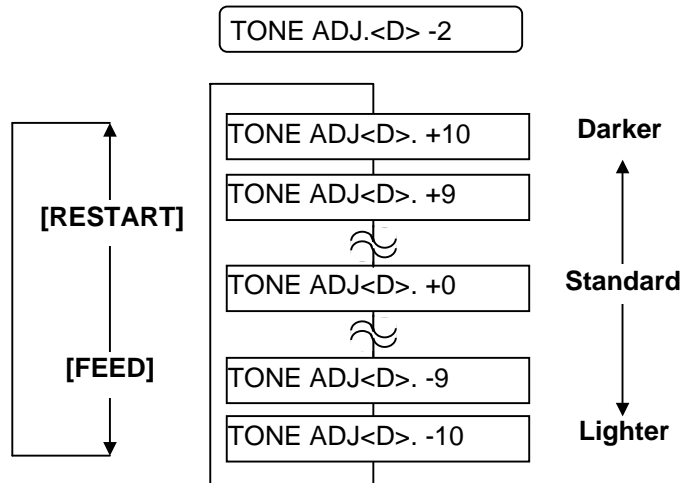

After selecting a fine adjustment value or to skip this menu, press the **[PAUSE]** key.

## 2.12 Position and Print Tone Fine Adjustment (Cont.)

### Ribbon Motor Voltage Fine Adjustment

When the ribbon is slack or wrinkled and printing is affected, fine adjust the ribbon motor torque by using the following procedure.

#### Take-up Motor (RBN ADJ <FW>)

**NOTES:**  
 Choose a desired value by using the **[RESTART]** or **[FEED]** key.  
 Pressing the **[FEED]** key one time causes a -1 step change, up to -15 steps.  
 Pressing the **[RESTART]** key one time causes a +1 step change, up to +6 steps.

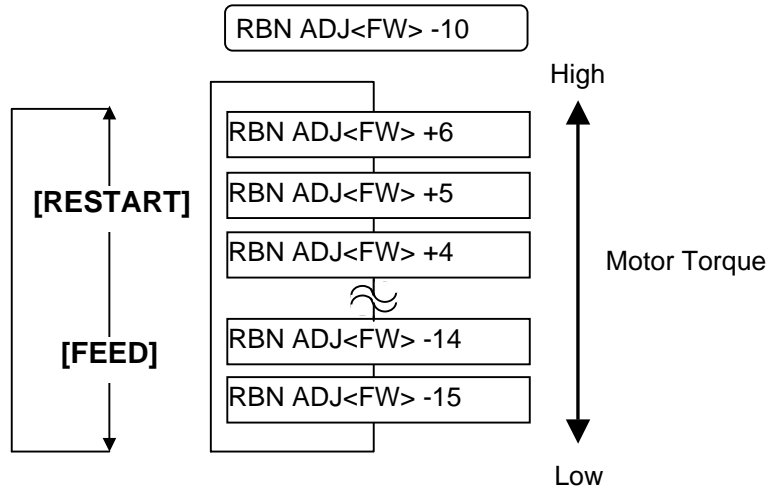

After selecting a fine adjustment value or to skip this menu, press the **[PAUSE]** key.

#### Feed Motor (RBN ADJ <BK>)

**NOTES:**  
 Choose a desired value by using the **[RESTART]** or **[FEED]** key.  
 Pressing the **[FEED]** key one time causes a -1 step change, up to -15 steps.  
 Pressing the **[RESTART]** key one time causes a +1 step change, up to +10 steps.

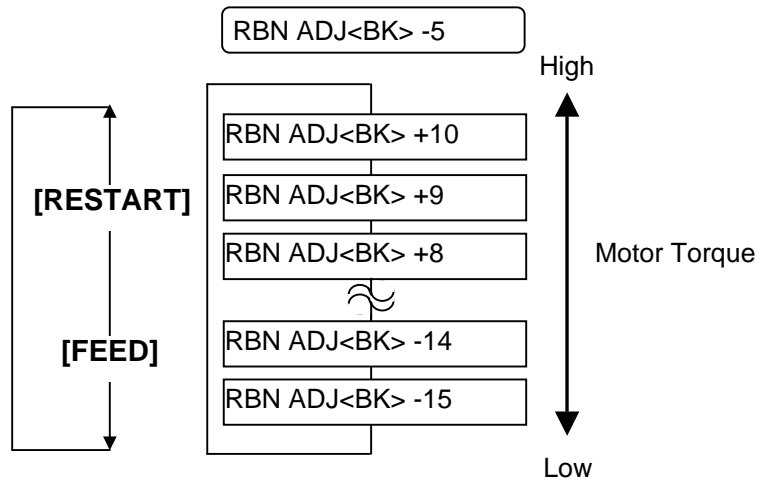

After selecting a fine adjustment value or to skip this menu, press the **[PAUSE]** key.



## 2.13 Threshold Setting

To maintain a constant print position the printer uses the media sensor to detect a print start position according to the difference of voltage between a print area and a gap or black mark. When the media is pre-printed, the darker (or more dense) inks can interfere with this process causing paper jam errors.

To get around this problem, first, try an automatic threshold setting. If the problem still occurs, then, the threshold voltage needs to be manually set.

### Automatic threshold setting procedure

1. Turn the power ON. The printer is in online mode.
2. Load a pre-printed media roll.  
When using a label stock, move the Feed Gap Sensor so that it is in line with the centre of the label.  
When using a tag stock, move the Black Mark Sensor so that it is in line with the centre of a black mark.
3. Press the **[PAUSE]** key.
4. The printer enters the pause mode.
5. Press and hold the **[PAUSE]** key in the pause state until the following screen appears.
6. The sensor type is displayed.

TRANSMISSIVE

7. Select the sensor to be adjusted by using the **[FEED]** key.

REFLECTIVE

←**[FEED]**→

TRANSMISSIVE

Black mark sensor

Feed gap sensor

8. Press and hold the **[PAUSE]** key until more than 1.5 labels (tags) have been issued.

The media will continue to be fed until the **[PAUSE]** key is released. (An automatic threshold setting for the selected sensor is completed by this operation.)

PAUSE

9. Press the **[RESTART]** key.

ON LINE

10. The printer returns to online mode.  
Send an issue command from the host computer to the printer.

#### NOTES:

1. Failure to feed more than 1.5 labels may result in an incorrect threshold setting.
2. While the Top Cover is raised, the **[PAUSE]** key does not work
3. A paper end error cannot be detected during paper feed.

### 2.13 Threshold Setting (Cont.)

#### Manual threshold setting procedure

If a paper jam error still occurs even after an automatic threshold setting has been performed, manually set the threshold voltage.

To make a threshold value manually set in this section effective, select the Transmissive Sensor (when using manual threshold value) or Reflective Sensor (when using manual threshold value) within software commands or the printer driver.

1. While holding down the [FEED] and [PAUSE] keys, turn on the printer.
2. When “<1>DIAG.” appears on the LCD Message Display, release the [FEED] and [PAUSE] keys.

<1>DIAG.

Now, the printer is in the System Mode for system administrators.

3. Press the [FEED] or [RESTART] key until “<5>SENSOR ADJ.” appears on the LCD Message Display.

<5>SENSOR ADJ.

4. Press the [PAUSE] key to enter the Sensor Adjustment Mode.

[H]28°C [A]28°C

The Sensor Adjustment Mode contains sub menus for displaying the current status of each sensor and for storing “media level” voltage and “no media level” voltage. Each time the [PAUSE] key is pressed, the sub menus are displayed sequentially.

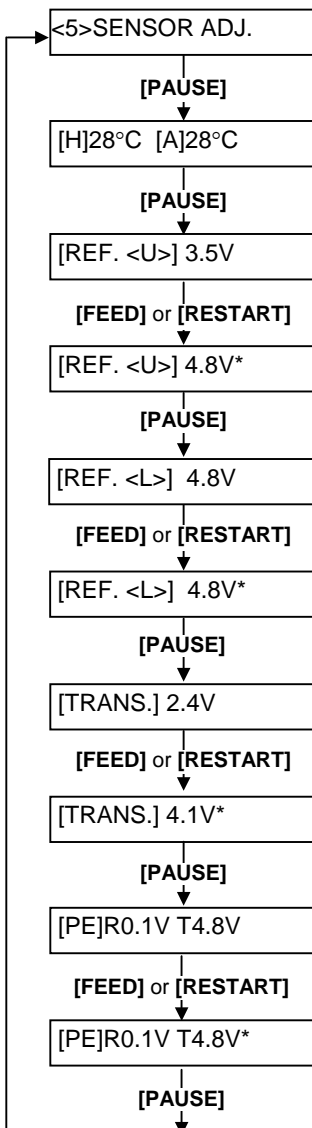

**(1) Sensor Status Display:**

Temperatures being detected by the Print Head Thermistor and the Ambient Thermistor are displayed.

**(2) Upper Black Mark Sensor Status Display:**

Voltage being detected by the upper Black Mark Sensor is displayed.

**(3) Upper Black Mark Sensor Adjustment:**

Using the media actually used, a “media level” voltage is stored.

**(4) Lower Black Mark Sensor Status Display:**

Voltage being detected by the lower Black Mark Sensor is displayed.

**(5) Lower Black Mark Sensor Adjustment:**

Using the media actually used, a “media level” voltage is stored.

**(6) Feed Gap Sensor Status Display:**

Voltage being detected by the Feed Gap Sensor is displayed.

**(7) Feed Gap Sensor Adjustment:**

Using the media actually used, a “media level” voltage is stored.

**(8) Lower Black Mark Sensor/Feed Gap Sensor Status Display (No media):**

“No media level” voltage detected by the lower Black Mark Sensor/Feed Gap Sensor is displayed.

**(9) Lower Black Mark Sensor/Feed Gap Sensor Adjustment (No media):**

“No media level” voltage is stored.

### 2.13 Threshold Setting (Cont.)

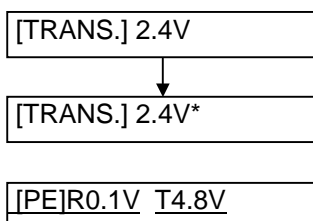
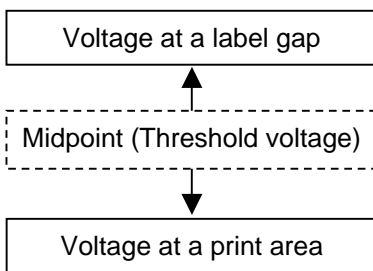
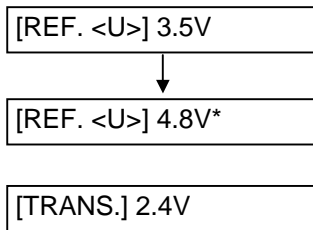
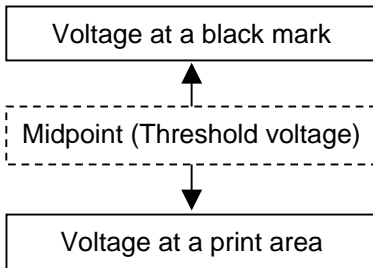

#### ■ When using the Black Mark Sensor

- (1) While “<5>SENSOR ADJ.” is displayed, press the **[PAUSE]** key until the message appears.  
The displayed value is a real-time voltage being detected by the Black Mark Sensor.

[REF. <U>] 3.5V

- (2) Measure a voltage at a blank part of media and a black mark, respectively. At this time, write down the midpoint between both voltages. (This value is used later for a threshold setting.)

(Example)

Print area = 4.8V, Black mark = 2.4V → Midpoint = 3.6V

**NOTES:**

1. When measuring a voltage of a blank area, be careful not to align a pre-print with the sensor by mistake.
2. Confirm that there is at least 0.7V difference between the two values. If the difference in voltage is less than 0.7V, a print start position cannot be detected. In that case, please consider changing the media type.
3. Make sure that the Top Cover is closed when measuring the voltages.

- (3) Press and hold the **[RESTART]** or **[FEED]** key for about 3 seconds aligning a blank part of print area with the Black Mark Sensor.
- (4) When storing a “media level” voltage is completed, an asterisk “\*” is displayed on the right side of a voltage. Press the **[PAUSE]** key.
- (5) A real-time voltage being detected by the Feed Gap Sensor is displayed.

#### ■ When using the Feed Gap Sensor

- (1) Measure a voltage at a blank part of label and a label gap, respectively. At this time, write down the midpoint of both voltages. (This value is used later for a threshold setting.)

(Example)

Print area = 2.4V, Gap = 4.0V → Midpoint = 3.2V

**NOTES:**

1. When measuring a voltage at a blank area, be careful not to align a pre-print with the sensor by mistake.
2. Confirm that there is at least 0.7V difference between the two values. If the difference in voltage is less than 0.7V, a print start position cannot be detected. In that case, please consider changing the media type.
3. Make sure that the Top Cover is closed when measuring the voltages.

- (2) Press and hold the **[RESTART]** or **[FEED]** key for about 3 seconds aligning a blank part of print area with the Feed Gap Sensor.
- (3) When storing a “media level” voltage is completed, an asterisk “\*” is displayed on the right side of a voltage. Press the **[PAUSE]** key.
- (4) The display changes as shown on the left.

## 2.13 Threshold Setting (Cont.)

### ■ Storing a “No Media Level” Voltage

The following is how to set a “No media level” voltage that is used to detect a paper end.

If a “NO PAPER” is displayed even if the media has not run out yet, this voltage needs to be set again.

(1) Remove any media from the Black Mark Sensor/Feed Gap Sensor.

(2) A real-time voltages being detected by the lower Black Mark Sensor and Feed Gap Sensor are displayed.

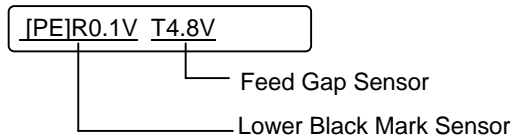

(3) Press and hold the **[RESTART]** or **[FEED]** key for about 3 seconds.

[PE]R0.1VT4.8V\*

(4) When storing a “no media level” voltage is completed, an asterisk “\*” is displayed on the right side of a voltage. Press the **[PAUSE]** key.

(5) The message returns to “<5>SENSOR ADJ.”.

<5>SENSOR ADJ.

### ■ Manual Threshold Setting

Then, set the calculated threshold voltage in the Parameter Fine Adjustment mode.

(1) While “<5>SENSOR ADJ.” is displayed, press the **[FEED]** or **[RESTART]** key until “<3>ADJUST SET” is displayed.

<3>ADJUST SET

(2) Press the **[PAUSE]** key to enter the Parameter Fine Adjustment Mode.

FEED ADJ.+10.0mm

### 2.13 Threshold Setting (Cont.)

(3) Press the **[PAUSE]** key until the target sensor type is displayed.

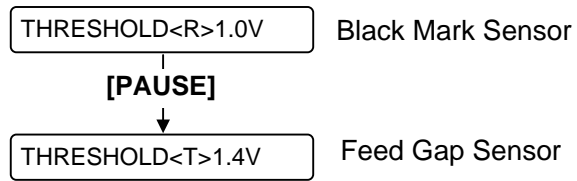

(4) Set a threshold voltage (calculated in Sensor Adjustment Menu) by using the **[FEED]** or **[RESTART]** key, as shown below.

**Threshold voltage = Midpoint between voltage at a print area and voltage at a gap/black mark**

**NOTE:**  
 Pressing the **[FEED]** key one time causes a  $-0.1V$  change, up to  $0.0V$ .  
 Pressing the **[RESTART]** key one time causes a  $+0.1V$  change, up to  $+4.0V$ .

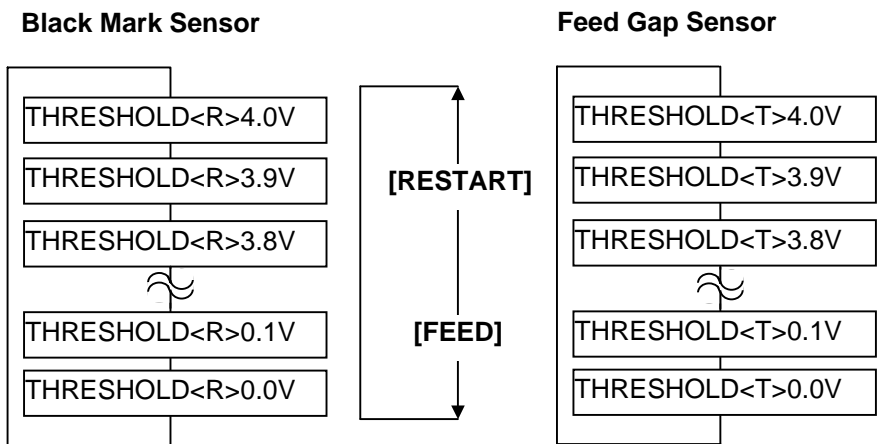

(5) After choosing a threshold voltage, press the **[PAUSE]** key.

(6) To check for a proper operation, issue the pre-printed media in online.  
 If an error still occurs even after a manual threshold setting, change the threshold voltage a little, and retry.

### 3. ON LINE MODE

This chapter describes usage and purpose of the keys on the Operation Panel in On Line Mode.

When the printer is in On Line Mode and connected to a host computer, normal operation of printing images on labels or tags can be accomplished.

#### 3.1 Operation Panel

- The figure below illustrates the Operation Panel and key functions.

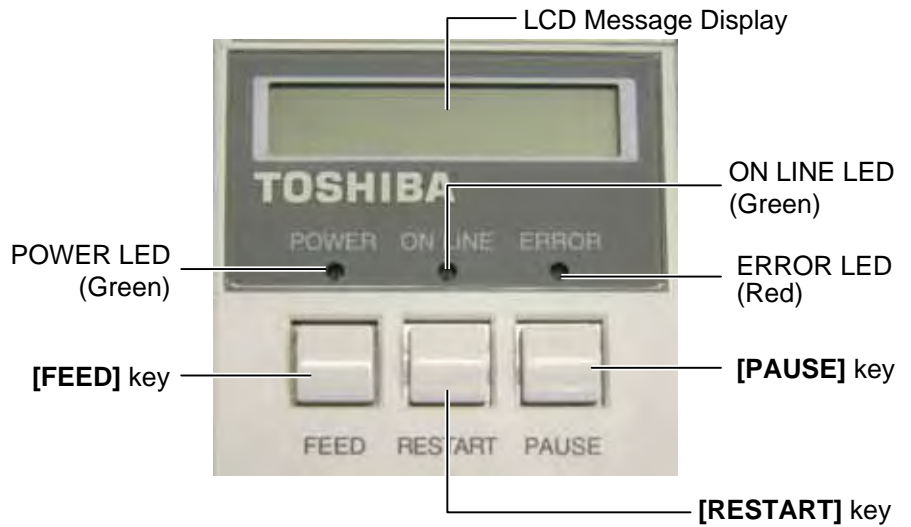

The LCD Message Display shows messages in alphanumeric characters and symbols to indicate the printer's status. Up to 16 characters can be displayed on one line.

There are three LED lights on the Operation Panel.

LED	Illuminates when...	Flashes when...
<b>POWER</b>	The printer is turned on.	-----
<b>ON LINE</b>	The printer is ready to print.	The printer is communicating with your computer.
<b>ERROR</b>	Any error occurs with the printer.	-----

**NOTE:**  
Use the **[RESTART]** key to resume printing after a pause condition, or after clearing an error.

There are three keys on the Operation Panel.

<b>PAUSE</b>	Used to stop printing temporarily.
<b>RESTART</b>	Used to restart printing.
<b>FEED</b>	Used to feed the media.

## 3.2 Operation

When the printer is turned on, the "ON LINE" message appears on the LCD Message Display. It is shown during standby or normal printing.

1. The printer is turned on, standing by, or printing.

ON LINE

2. If any error occurs during printing, an error message appears. The printer stops printing automatically. (The number on the right column shows the number of unprinted media.)

NO PAPER 125

3. To clear the error, press the **[RESTART]** key. The printer resumes printing.

ON LINE

4. If the **[PAUSE]** key is pressed during printing, the printer stops printing temporarily. (The number on the right column shows the number of unprinted media.)

PAUSE 52

5. When the **[RESTART]** key is pressed, the printer resumes printing.

ON LINE

## 3.3 Reset

Reset operation clears the print data sent to the printer from the computer, and returns the printer to an idle condition.

1. The printer is turned on, standing by, or printing.

ON LINE

2. To stop printing, or clear the data sent from the computer, press the **[PAUSE]** key. The printer stops printing.

PAUSE 52

3. Press and hold the **[RESTART]** key for 3 seconds or longer.

<1>RESET

4. Press the **[PAUSE]** key. The data sent from the computer will be cleared, and the printer returns to an idle condition.

ON LINE

**NOTE:**

*If the **[RESTART]** key is held for less than 3 seconds when the printer is in an error or pause state, the printer restarts printing. However, when a communication error or command error occurs, the printer returns to an idle condition.*

## 4. MAINTENANCE

### **WARNING!**

1. Be sure to disconnect the Power Cord before performing maintenance. Failure to do this may cause an electric shock.
2. To avoid injury, be careful not to pinch or jam your fingers while opening or closing the cover and Print Head Block.
3. The Print Head may become hot. Do not touch the Print Head.
4. Do not pour water directly onto the printer.

This chapter describes how to perform normal maintenance.

To maintain the printer performance and quality print, please clean the printer regularly, or whenever media or ribbon is replaced.

### 4.1 Cleaning

The following sections describe periodic cleaning of the unit.

#### 4.1.1 Print Head/Platen/Sensors

### **CAUTION!**

1. Do not allow any hard objects to touch the print head or platen, as this may cause damage to them.
2. Do not use any volatile solvent including thinner and benzene, as this may cause discoloration to the cover, print failure, or breakdown of the printer.
3. Do not touch the print head element with bare hands, as static may damage the print head.
4. Be sure to use the print head cleaner enclosed with this printer. Failure to do this may shorten the print head life.

### **NOTE:**

Please purchase the Print Head Cleaner from the authorised TOSHIBA TEC service representative.

1. Turn off the printer. Open the Top Cover.
2. Press the Head Block Release Lever to release the Print Head Block.
3. Raise the Print Head Block and remove the ribbon.
4. Clean the Print Head Element with the supplied Print Head Cleaner.

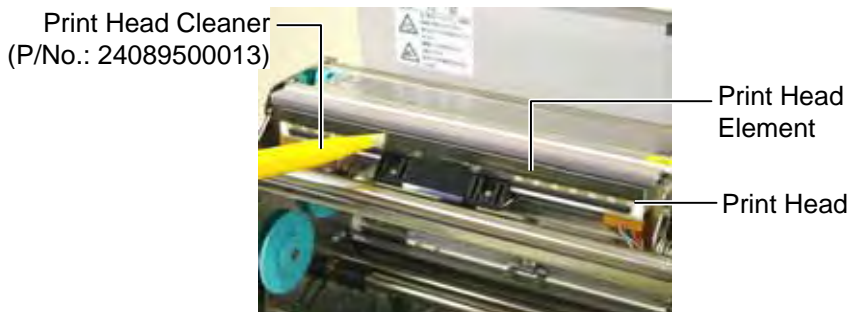

5. Hold the Sensor Lift Tab and lift the Upper Sensor Ass'y.
6. Wipe the Feed Gap Sensor and Black Mark Sensor with a dry soft cloth.
7. Wipe the Platen with a soft cloth slightly moistened with ethyl alcohol.

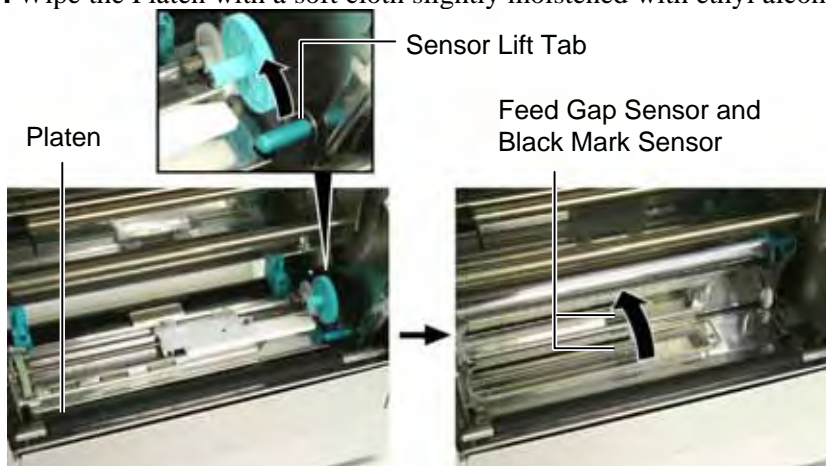



### 4.1.2 Covers and Panels

Wipe the Cover and Front Panel with a dry soft cloth. Wipe off dirt with a soft cloth slightly moistened with water.

**CAUTION!**

*Do not use any volatile solvent including thinner and benzene, as this may cause discoloration or distortion of the cover.*



### 4.1.3 Optional Cutter Module

**WARNING!**

1. Be sure to turn the power off before cleaning the Cutter Module.
2. The Cutter is sharp, so care should be taken not to injure yourself when cleaning.

1. Remove the Plastic Head Screw and to detach the Cutter Cover.
2. Remove the jammed paper and trash, if any.
3. Clean the Cutter Blade with a dry cloth.

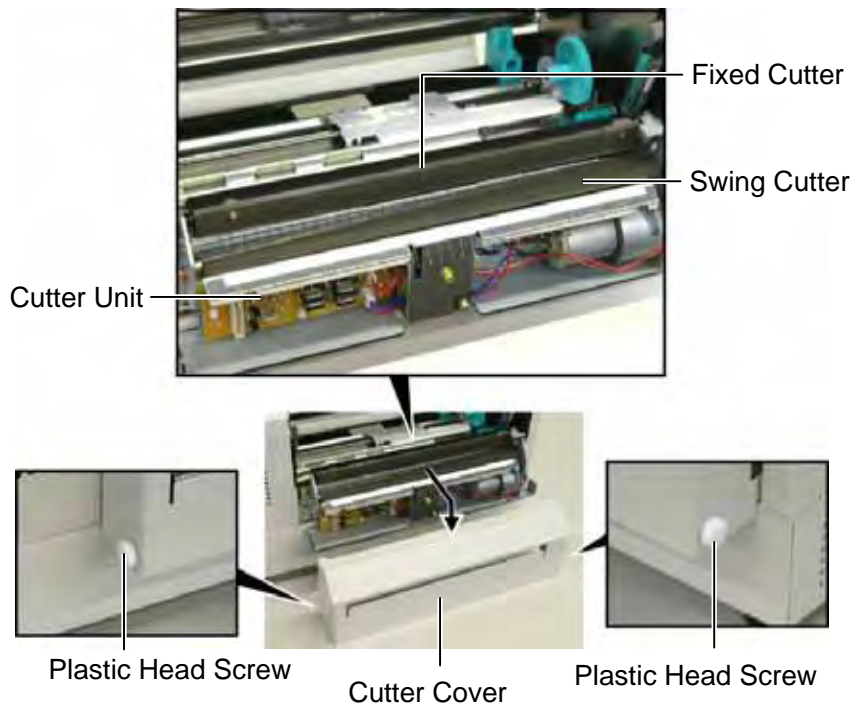

## 5. TROUBLESHOOTING

This chapter lists the error messages and possible problems and their solutions.

### WARNING!

If a problem cannot be solved by taking actions described in this chapter, do not attempt to repair the printer. Turn off and unplug the printer. Then contact an authorised TOSHIBA TEC service representative for assistance.

### 5.1 Error Messages

#### NOTES:

- If an error is not cleared by pressing the **[RESTART]** key, turn the printer off and then on.
- After the printer is turned off, all print data in the printer is cleared.
- "\*\*\*\*" indicates the number of unprinted media. Up to 9999 (in pieces).

Error Messages	Problems/Causes	Solutions
<b>HEAD OPEN</b>	The print head block is opened in Online Mode.	Close the print head block. Then press the <b>[RESTART]</b> key.
<b>HEAD OPEN ****</b>	Feed or printing has been attempted with the Print Head Block open.	Close the print head block. Then press the <b>[RESTART]</b> key.
<b>COMMS ERROR</b>	A communication error has occurred.	Make sure the interface cable is firmly connected to the computer, and the computer is turned on.
<b>PAPER JAM ****</b>	1. The media is jammed at the media path. The media is not fed smoothly.	1. Remove the jammed media, and clean the Platen. Then reload the media properly. Finally press the <b>[RESTART]</b> key. ⇒ <b>Section 5.3.</b>
	2. A wrong media sensor is selected for the media being loaded.	2. Turn the printer off and then on. Then select the media sensor supporting the media being loaded. Finally resend the print job.
	3. The Black Mark Sensor is not aligned to the Black Mark on the media.	3. Adjust the sensor position. Then press the <b>[RESTART]</b> key. ⇒ <b>Section 2.5.</b>
	4. Size of the loaded media is not consistent with the programmed size.	4. Turn the printer off and then on. Replace the loaded media with one which matches the programmed size, or select a programmed size that matches the loaded media. Finally resend the print job.
	5. The Feed Gap Sensor cannot distinguish the print area from a label gap.	5. Refer to <b>Section 2.13</b> to set the threshold. If this does not solve the problem, turn off the printer, and call an authorised service representative.
<b>CUTTER ERROR ****</b> (Only when the Cutter Module is installed on the printer.)	The media is jammed in the Cutter.	Remove the jammed media. Then press the <b>[RESTART]</b> key. If this does not solve the problem, turn off the printer, and call an authorised service representative. ⇒ <b>Section 4.1.3</b>

## 5.1 Error Messages (Cont.)

Error Messages	Problems/Cause	Solutions
<b>NO PAPER ****</b>	1. The media has run out.	1. Load new media. Then press the <b>[RESTART]</b> key. ⇒ <b>Section 2.4</b>
	2. The media is not loaded properly.	2. Load the media properly. Then press the <b>[RESTART]</b> key. ⇒ <b>Section 2.4</b>
	3. The media is slack.	3. Take up any slack in the media.
<b>RIBBON ERROR ****</b>	1. The ribbon is not fed properly.	1. Remove the ribbon, and check the status of the ribbon. Replace the ribbon, if necessary. If the problem is not solved, turn off the printer, and call an authorised service representative.
	2. The ribbon has run out.	2. Load a new ribbon. Then press the <b>[RESTART]</b> key. ⇒ <b>Section 2.6</b>
<b>EXCESS HEAD TEMP</b>	The print head is overheated.	Turn off the printer, and allow it to cool down (about 3 minutes). If this does not solve the problem, call an authorised service representative.
<b>HEAD ERROR</b>	There is a problem with the Print Head.	Replace the Print Head. Then press the <b>[RESTART]</b> key.
<b>POWER FAILURE</b>	A momentary power failure has occurred.	Check the power source which supplies power to the printer. If the rating is not correct, or if the printer shares the same power outlet with other electrical appliances that consume large amounts of power, change the outlet.
<b>SYSTEM ERROR</b>	1. The printer is used in a location where it is subject to noise. Or, there are power cords of other electrical appliances near the printer or interface cable.	1. Keep the printer and the interface cables away from the source of noise.
	2. The Power Cord of the printer is not grounded.	2. Ground the Power Cord.
	3. The printer shares the same power source with any other electrical appliances.	3. Provide an exclusive power source for the printer.
	4. An application software used on your host computer has an error or malfunction.	4. Confirm the host computer operates properly.
<b>FLASH WRITE ERR.</b>	An error has occurred in writing to the flash ROM.	Turn the printer off, and then on again.
<b>FORMAT ERROR</b>	An error has occurred in formatting the flash ROM.	Turn the printer off, and then on again.
<b>FLASH CARD FULL</b>	Saving failed because of an insufficient capacity of the flash ROM.	Turn the printer off, and then on again.
<b>EEPROM ERROR</b>	Data cannot be read from/written to a backup EEPROM properly.	Turn the printer off, and then on again.

## 5.1 Error Messages (Cont.)

Error Messages	Problems/Cause	Solutions
<b>SYNTAX ERROR</b>	While the printer is in the Download mode for upgrading the firmware, it receives an improper command, for example, an Issue Command.	Turn the printer off, and then on again.
<b>LOW BATTERY</b>	The voltage of the Real Time Clock Battery is 1.9V or less.	Hold down the <b>[RESTART]</b> key until “<1>RESET” is displayed. If you would like to keep using the same battery even after “LOW BATTERY” error occurs, set the Low battery check function to OFF, and set the date and time to the real time. As long as the power is on, the Real Time Clock will function. ⇒ <b>Section 2.9.6</b> However, once the power is turned off, the date and time will be reset. Call a TOSHIBA TEC authorized service representative for replacement of the battery.
Other error messages	Hardware or software problems may have occurred.	Turn the printer off and then on. If this does not solve the problem, turn off the printer again, and call a TOSHIBA TEC authorised service representative.

## 5.2 Possible Problems

This section describes problems that may occur when using the printer, and their causes and solutions.

Possible Problems	Causes	Solutions
The printer will not turn on.	1. The Power Cord is disconnected.	1. Plug in the Power Cord.
	2. The AC outlet is not functioning correctly.	2. Make sure that the power is supplied using another electric appliance.
	3. The fuse has blown, or the circuit breaker has tripped.	3. Check the fuse or breaker.
The media is not fed.	1. The media is not loaded properly.	1. Load the media properly. ⇒ <b>Section 2.4.</b>
	2. The printer is in an error condition.	2. Solve the error in the Message Display. (See <b>Section 5.1</b> for more detail.)
Pressing the <b>[FEED]</b> key in the initial state results in an error.	A feed or an issue was attempted not on the following default conditions. Sensor type: Feed gap sensor Printing method: Thermal transfer Media pitch: 76.2 mm	Change the print condition by using the printer driver or a print command so that it corresponds to your printing conditions. Then, clear the error state by pressing the <b>[RESTART]</b> key.

## 5.2 Possible Problems (Cont.)

Possible Problems	Causes	Solutions
Nothing is printed on the media.	1. The media is not loaded properly.	1. Load the media properly. ⇒ <b>Section 2.4.</b>
	2. The ribbon is not loaded properly.	2. Load the ribbon properly. ⇒ <b>Section 2.6</b>
	3. A print head is not installed properly.	3. Install the Print Head properly. Close the Print Head Block.
	4. The ribbon and media are not matched.	4. Select an appropriate ribbon for the media type being used.
The printed image is blurred.	1. The ribbon and media are not matched.	1. Select an appropriate ribbon for the media type being used.
	2. The Print Head is not clean.	2. Clean the print head using the supplied Print Head Cleaner. ⇒ <b>Section 4.1.1</b>
The Cutter does not cut.	1. The Cutter Cover is not attached properly.	1. Attach the Cutter Cover properly.
	2. The media is jammed in the Cutter.	2. Remove the jammed paper. ⇒ <b>Section 4.1.3</b>
	3. The Cutter Blade is dirty.	3. Clean the Cutter Blade. ⇒ <b>Section 4.1.3</b>

### 5.3 Removing Jammed Media

This section describes in detail how to remove jammed media from the printer.

**CAUTION!**

*Do not scratch the Print Head or Platen using a sharp instrument, as this may cause media feed failure or damage to the printer.*

Remove the jammed media from under the Upper Sensor Ass'y as follows:

1. Open the Top Cover.
2. Push the Head Block Release Lever to release and raise the Print Head Block.
3. Lift the Upper Sensor Ass'y, and remove the jammed media.



Upper Sensor Ass'y

**NOTE:**

*If you get frequent jams in the Cutter, contact a TOSHIBA TEC authorised service representative.*

4. Clean the Platen and sensors as described in **Section 4.1.1**.
5. Media jams in the Cutter Module can be caused by wear or residual glue from label stock on the Cutter Blade. Do not use non-specified media with the Cutter.

## 6. PRINTER SPECIFICATIONS

This section describes the printer specifications.

Model		B-852-TS22-QQ-R	B-852-TS22-QP-R
Item			
Dimension (W × D × H)		385 mm × 181 mm* × 243 mm (15.2" × 7.1"* × 9.6") *: Depth is 16.8" (427 mm) when the supply holder is installed.	
Weight		34.4 lb (15.6 kg) (Media and ribbon are not included.)	
Operating temperature range		5°C to 40°C (41°F to 104°F)	
Relative humidity		25% to 85% RH (no condensation)	
Input voltage		AC100 – 120V, 60 Hz	AC220 – 240V, 50 Hz
Power consumption	During a print job	2.5 A, 190 W maximum	1.1 A, 217 W maximum
	During standby	0.16 A, 15 W maximum	0.1 A, 20 W maximum
Resolution		11.8 dots/mm (300 dpi)	
Printing method		Thermal transfer or Thermal direct	
Printing speed		50.8mm/sec. (2 inches/sec.) 101.6 mm/sec (4 inches/sec.)	
Available media width (including backing paper)		100 mm to 242 mm (3.9 inches to 9.5 inches)	
Maximum effective print width		8.5" (216.8 mm)	
Issue mode		Batch Cut (Cut mode is enabled only when the optional cutter module is installed)	
LCD Message display		16 characters × 1 line	

Model	B-852-TS22-QQ-R	B-852-TS22-QP-R
<b>Item</b>		
Available bar code types	JAN8, JAN13, EAN8, EAN8+2 digits, EAN8+5 digits, EAN13, EAN13+2 digits, EAN13+5 digits, UPC-E, UPC-E+2 digits, UPC-E+5 digits, UPC-A, UPC-A+2 digits, UPC-A+5 digits, MSI, ITF, NW-7, CODE39, CODE93, CODE128, EAN128, Industrial 2 to 5, Customer Bar Code, POSTNET, KIX CODE, RM4SCC (ROYAL MAIL 4STATE CUSTOMER CODE), RSS14	
Available two-dimensional code	Data Matrix, PDF417, QR code, Maxi Code, Micro PDF417, CP Code	
Available font	Times Roman (6 sizes), Helvetica (6 sizes), Presentation (1 size), Letter Gothic (1 size), Prestige Elite (2 sizes), Courier (2 sizes), OCR (2 types), Gothic (1 size), Outline font (4 types), Price font (3 types)	
Rotations	0°, 90°, 180°, 270°	
Standard interface	Parallel interface (Centronics, Bidirectional 1284 Nibble mode) USB interface (V2.0 Full speed) LAN interface (10/100BASE)	
Optional equipment	Serial interface board (RS-232C) (B-SA704-RS-QM-R) Wireless LAN interface board (B-SA704-WLAN-QM-R) Cutter module (B-7208-QM-R) Expansion I/O board (B-SA704-IO-QM-R) Real time clock (B-SA704-RTC-QM-R)	

**NOTES:**

- *Data Matrix™* is a trademark of International Data Matrix Inc., U.S.
- *PDF417™* is a trademark of Symbol Technologies Inc., US.
- *QR Code* is a trademark of DENSO CORPORATION.
- *Maxi Code* is a trademark of United Parcel Service of America, Inc., U.S.



## 7. SUPPLY SPECIFICATIONS

### 7.1 Media

Please make sure that the media that will be used is approved by TOSHIBA TEC. The warranty does not apply when a problem is caused by using media that is not approved by TOSHIBA TEC.

For information regarding TOSHIBA TEC approved media, please contact a TOSHIBA TEC authorised service representative.

#### 7.1.1 Media Type

Two types of media can be loaded for this thermal transfer and direct thermal printer label or tag. The table below shows size and shape of the media available for this printer.

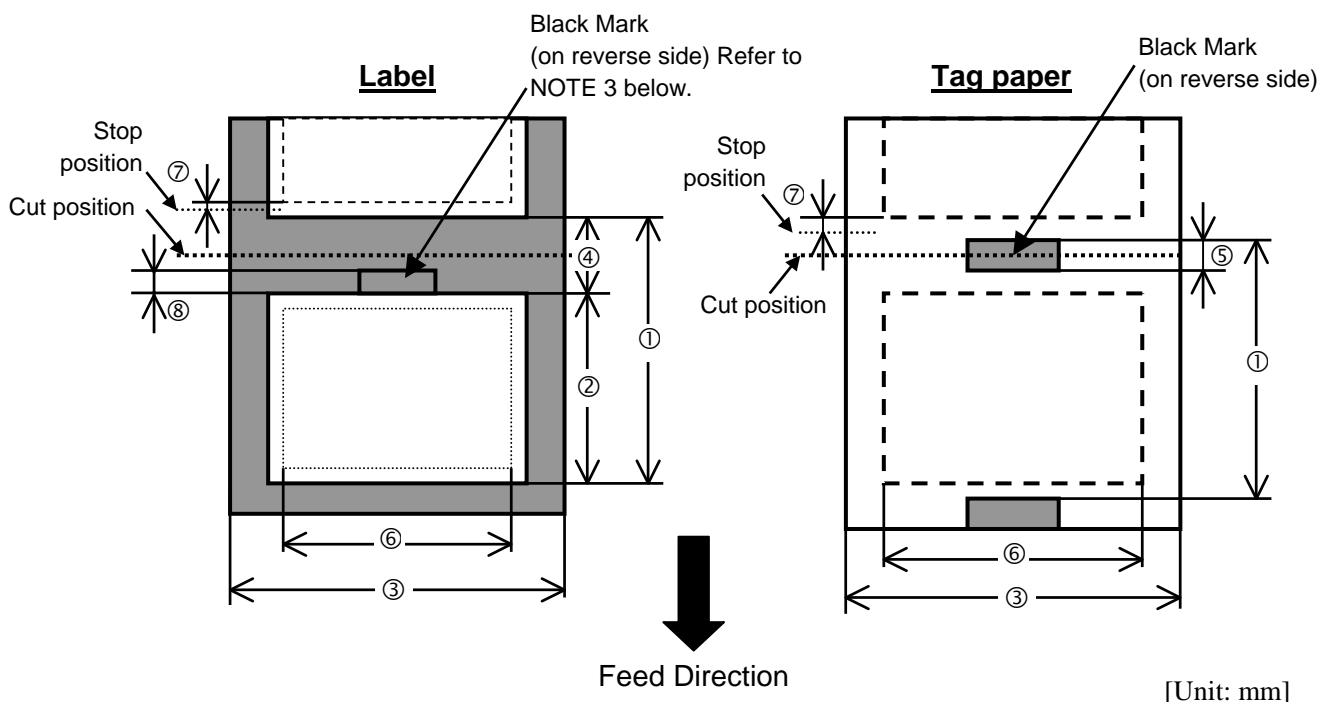

Label dispensing mode		Batch mode	Cut mode
① Minimum media pitch	15.0		Label: 38.0
			Tag: 25.4
② Label length	Min. 12.5		Min. 32.0
③ Width including backing paper	100.0- 242.0		100.0 – 235.0
④ Gap length	2.5 – 20.0		6.0 – 20.0
⑤ Black mark length (Tag paper)	2.0 – 10.0		
⑥ Effective print width	216.8±0.2		
⑦ Print speed up/slow down area	1.0		
⑧ Black mark length (Label)	2.0 – 20.0		6.0 – 20.0
Max. print length		640.0	
Maximum effective length for on the fly issue		320.0	
Max. outer roll diameter		φ230	
Thickness	Label + backing paper	0.13 – 0.18	
	Tag	0.08 – 0.18	

### 7.1.1 Media Type (Cont.)

#### NOTES:

1. To ensure print quality and print head life use only TOSHIBA TEC specified media.
2. When using the cutter ensure that label length ② plus inter-label gap length ④ exceeds 38 mm. (i.e. label pitch should be greater than 38 mm.)
3. When marking black marks on label rolls, the following requirements must be satisfied.
  - When the gap length is less than 4 mm:  
The black mark length should be longer than the gap length.
  - When the gap length is 4 mm or more:  
The black mark should not overlap the gap for more than 4 mm and the following label. Black marks should be printed on reverse side of the gaps. Also, they should contact or overlap the preceding label's bottom end line.
4. "On the fly issue" means that the printer can feed and print without stopping between labels.

### 7.1.2 Detection Area of the Transmissive Sensor

The transmissive sensor is movable from the center to the left edge of media.  
The transmissive sensor detects a gap between labels, as illustrated below.

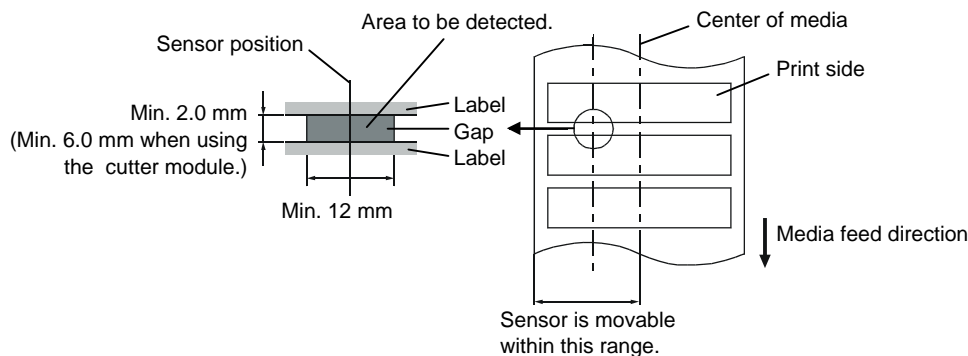

### 7.1.3 Detection Area of the Reflective Sensor

The reflective sensor is movable from the center to the left edge of media.  
The reflection factor of the black mark must be 10% or lower with a waveform length of 950 nm.  
The reflective sensor should be aligned with the center of the black mark.

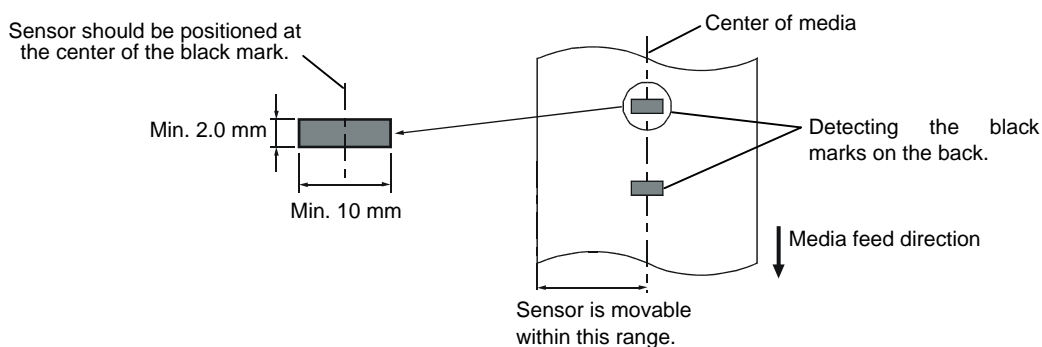

### 7.1.4 Effective Print Area

The figure below illustrates the relation between the head effective print width and media width.

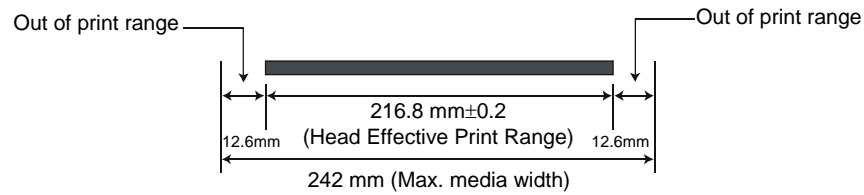

The figure below shows the effective print area on the media.

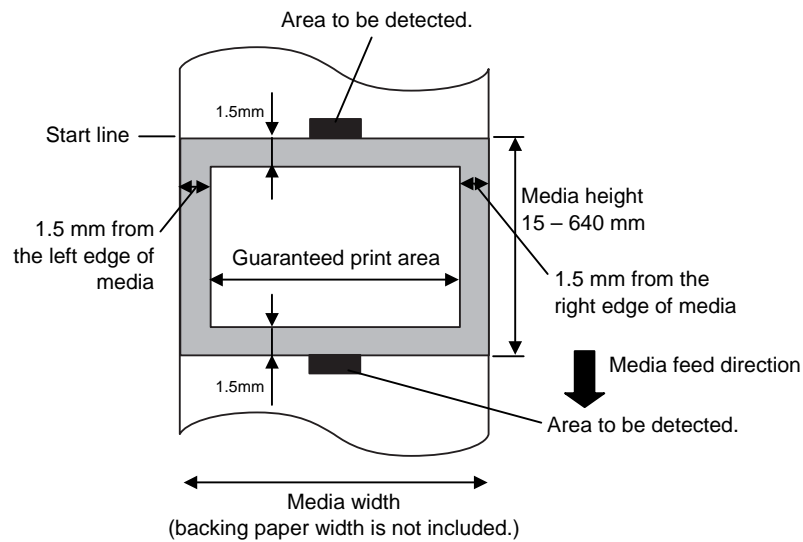

**NOTES:**

1. Be sure not to print on the 1.5-mm wide area from the media edges (shaded area in the above figure).
2. The center of media is positioned at the center of the print heads.

## 7.2 Ribbon

Please make sure that the ribbon being used is approved by TOSHIBA TEC. The warranty does not apply to any problem caused by using non-approved ribbons.

For information regarding TOSHIBA TEC approved ribbon, please contact a sales representative.

Type	Spool type
Width	120 – 220 mm Recommended width is 120, 160 and 220 mm.
Length	300 m
Outside Diameter	φ72 mm (max.)

The table below shows the correlation between ribbon width and media width (backing paper is not included).

Ribbon width	Media width
120 mm	100 – 110 mm
160 mm	110 – 150 mm
220 mm	150 – 242 mm

### NOTES:

1. To ensure print quality and print head life use only TOSHIBA TEC specified ribbons.
2. To avoid ribbon wrinkles use a ribbon that is wider than the media by 10 mm or more. However, too much difference in width between the two may cause wrinkles.

## 7.3 Recommended Media and Ribbon Types

Media type	Description
Vellum paper and labels	General use for low cost applications.
Coated paper	Matt coated paper General use including applications that require small letters and/or symbols. Glossy coated paper Used where a high-grade finish is required
Plastic films	Synthetic film (Polypropylene, etc.) This water-proof and solvent-resistant material has high physical strength and low-temperature resistance, but poor heat resistance (dependant upon material). This material can be used for labels stuck to recyclable containers, so it can be recycled in the same process. PET film This water-proof and solvent-resistant material has high physical strength, and low-temperature resistance as well as heat resistance. This material is used for many applications, especially where high durability is required. Mode/serial plate labels, caution labels, etc. Polyimide This material gives the best performance on heat resistance (greater than PET film). It is often used for PCB labels as it can withstand passage through a solder bath.

### 7.3 Recommended Media and Ribbon Types (Cont.)

Ribbon type	Description
Vellum wax ribbon	This ribbon is mainly used for vellum paper and labels. It has a very high ink density to cope with uneven printing surface
Standard wax ribbon	Good match for coated paper (Matt coat and glossy coat).
Smear-less ribbon (Wax resin ribbon)	Good match for coated paper. The printed image will resist water and light rubbing.
Scratch and solvent resistance ribbon	Very good match for plastic films (synthetic paper, PET, polyimide, etc.) Scratch and solvent resistance Heat resistance with PET and polyimide.

#### Combination of Media and Ribbon

Media type Ribbon type	Vellum paper and label	Coated paper	Plastic films
Vellum wax ribbon	○		
Standard wax ribbon		○	
Smear-less ribbon (wax-resin ribbon)		○	
Scratch/solvent resistance ribbon			○

○: Good match

### 7.4 Care/Handling of the Media and Ribbon

#### CAUTION!

*Be sure to read carefully and understand the Supply Manual. Use only media and ribbons which meet specified requirements. Use of non-specified media and ribbons may shorten the head life and result in problems with bar code readability or print quality. All media and ribbons should be handled with care to avoid any damage to the media, ribbons or printer. Read the guideline in this section carefully.*

- Do not store the media and ribbon for longer than the manufacturer's recommended shelf life.
- Store media rolls on the flat end. Do not store them on the curved sides as this might flatten that side causing erratic media advance and poor print quality.
- Store the media in plastic bags and always reseal after opening. Unprotected media can get dirty and the extra abrasion from the dust and dirt particles will shorten the print head life.
- Store the media and ribbon in a cool, dry place. Avoid areas where they would be exposed to direct sunlight, high temperature, high humidity, dust or gas.
- The thermal paper used for direct thermal printing must not have specifications which exceed Na<sup>+</sup> 800 ppm, K<sup>+</sup> 250 ppm and Cl<sup>-</sup> 500 ppm.
- Some ink used on pre-printed media may contain ingredients which shorten the print head's product life. Do not use labels pre-printed with ink which contain hard substances such as carbonic calcium (CaCO<sub>3</sub>) and kaolin (Al<sub>2</sub>O<sub>3</sub>, 2SiO<sub>2</sub>, 2H<sub>2</sub>O).

For further information, please contact your local distributor or your media and ribbon manufacturers.

## APPENDIX 1 MESSAGES AND LEDS

Appendix 1 describes the LCD messages displayed on the operation panel.

### Symbols in the message

- 1: ○: The LED is illuminated. ◎: The LED is flashing. ●: The LED is unlit.  
 2: \*\*\*\*: the number of unprinted media. Up to 9999 (in pieces)  
 3: ###: Flash memory card remaining memory for PC save area: 0 to 895 (in K bytes)  
 4: &&&&: Remaining flash memory capacity for storing writable characters 0 to 3147 (in K bytes)

No.	LCD Message	LED Indication			Printer Status	Restoration by RESTART key Yes/No	Acceptance of Status Request Reset Command Yes/No
		POWER	ONLINE	ERROR			
1	ON LINE	○	○	●	In online mode	----	Yes
	ON LINE	○	◎	●	In online mode (The printer in communication)	----	Yes
2	HEAD OPEN	○	●	●	The print head block is opened in online mode.	----	Yes
3	PAUSE ****	○	●	●	The printer is paused.	Yes	Yes
4	COMMS ERROR	○	●	○	A parity, overrun, or framing error has occurred during communication through the RS-232C.	Yes	Yes
5	PAPER JAM ****	○	●	○	The media is jammed during paper feed.	Yes	Yes
6	CUTTER ERROR****	○	●	○	A problem has occurred with the cutter module.	Yes	Yes
7	NO PAPER ****	○	●	○	The media has run out, or the media is not loaded on the supply holder properly.	Yes	Yes
8	RIBBON ERROR****	○	●	○	The ribbon has run out, or has been torn. A problem has occurred with the sensor that determines the torque for the ribbon motor.	Yes	Yes
9	HEAD OPEN ****	○	●	○	Feed or printing was attempted with the print head block open.	Yes	Yes
10	HEAD ERROR	○	●	○	There is a problem with the print head	Yes	Yes
11	EXCESS HEAD TEMP	○	●	○	The print head is overheated.	No	Yes
12	SAVING ###&&&&	○	○	●	In writable character or PC command save mode	----	Yes
13	FLASH WRITE ERR.	○	●	○	An error has occurred while writing to flash memory.	No	Yes
14	FORMAT ERROR	○	●	○	An erase error has occurred in formatting the flash memory.	No	Yes
15	FLASH CARD FULL	○	●	○	Data cannot be stored because the flash memory.	No	Yes
16	POWER FAILURE	○	●	○	A power failure has occurred.	No	No
17	MEM. INTIAL...	○	●	●	A flash memory card is being initialised.	----	----
18	EEPROM ERROR	○	●	○	Data cannot be read from/written to a backup EEPROM properly	No	No

No.	LCD Message	LED Indication			Printer Status	Restoration by RESTART key Yes/No	Acceptance of Status Request Reset Command Yes/No
		POWER	ONLINE	ERROR			
19	SYSTEM ERROR	○	●	○	When the following abnormal operations are performed, a system error occurs: (a) Command fetch from an odd address (b) Access to word data at an odd address (c) Access to long-word data at an odd address (d) Access to the area of 80000000H to FFFFFFFFH in the logic space in user mode. (e) An undefined instruction in an area other than a delay slot was decoded. (f) An undefined instruction in a delay slot was decoded. (g) An instruction to rewrite a delay slot was decoded.	No	No
20	LAN INITIAL...	○	●	●	100BASE LAN is being initialised.	----	----
21	DHCP INITIAL...	○	●	●	DHCP CLIENT is being initialised.	----	----
22	LOW BATTERY	○	●	○	The voltage of the Real Time Clock Battery is 1.9V or less	No	Yes
23	Display of error message (See Notes.)	○	●	○	A command error has occurred in analyzing the command.	Yes	Yes

**NOTE:** When an error message listed above appears on the LCD message display, please refer to **Section 5 TROUBLESHOOTING** for solution.

**NOTES:**

- If a command error is found in the command received, 16 bytes of the command error, starting from the command code, will be displayed. (However, [LF] and [NUL] will not be displayed.)

## Example 1

[ESC] T20 E30 [LF] [NUL]  
                  └─── Command error

The following message appears.

T20E30

## Example 2

[ESC] XR; 0200, 0300, 0450, 1200, 1, [LF] [NUL]  
  └─── Command error

The following message appears.

XR;0200,0300,045

## Example 3

[ESC] PC001; 0A00, 0300, 2, 2, A, 00, B [LF] [NUL]  
  └─── Command error

The following message appears.

PC001;0A00,0300,

- When the error command is shown, "? (3FH)" appears for codes other than codes 20H to 7FH and A0H to DFH.
- For details, please refer to the **B-852 Series External Equipment Interface Specification**.



## APPENDIX 2 INTERFACE

**NOTE:**

To prevent radiation and reception of electrical noise, the interface cables must meet the following requirements:

- In case of a parallel interface cable or serial interface cable, fully shielded and fitted with metal or metallised connector housings.
- Keep as short as possible.
- Should not be bundled tightly with power cords.
- Should not be tied to power line conduits.
- A parallel interface cable to be used should conform to IEEE1284.

### ■ Parallel interface (Centronics)

Mode: Conforming to IEEE1284  
Compatible mode (SPP mode), Nibble mode

Data input method: 8 bit parallel

Control signal:

SPP Mode	Nibble Mode
nStrobe	HostClk
nAck	PtrClk
Busy	PtrBusy
Perror	AckDataReq
Select	Xflag
nAutoFd	HostBusy
nInit	nInit
nFault	nDataAvail
nSelectIn	IEEE1284Active

Data input code: ASCII code  
European 8 bit code  
Graphic 8 bit code  
JIS8 code  
Shift JIS Kanji code  
JIS Kanji code

Receive buffer: 1M byte

Connector:

PIN No.	Signal	
	SPP Mode	Nibble Mode
1	nStrobe	HostClk
2	Data 1	Data 1
3	Data 2	Data 2
4	Data 3	Data 3
5	Data 4	Data 4
6	Data 5	Data 5
7	Data 6	Data 6
8	Data 7	Data 7
9	Data 8	Data 8
10	nAck	PtrClk
11	Busy	PtrBusy
12	PError	AckDataReq
13	Select	Xflag
14	nAutoFd	HostBusy
15	NC	NC
16	0V	0V
17	CHASSIS GND	CHASSIS GND
18	+5V (For detection)	+5V (For detection)
19	TWISTED PAIR GND(PIN1)	TWISTED PAIR GND(PIN1)
20	TWISTED PAIR GND(PIN2)	TWISTED PAIR GND(PIN2)
21	TWISTED PAIR GND(PIN3)	TWISTED PAIR GND(PIN3)
22	TWISTED PAIR GND(PIN4)	TWISTED PAIR GND(PIN4)
23	TWISTED PAIR GND(PIN5)	TWISTED PAIR GND(PIN5)
24	TWISTED PAIR GND(PIN6)	TWISTED PAIR GND(PIN6)
25	TWISTED PAIR GND(PIN7)	TWISTED PAIR GND(PIN7)
26	TWISTED PAIR GND(PIN8)	TWISTED PAIR GND(PIN8)
27	TWISTED PAIR GND(PIN9)	TWISTED PAIR GND(PIN9)
28	TWISTED PAIR GND(PIN10)	TWISTED PAIR GND(PIN10)
29	TWISTED PAIR GND(PIN11)	TWISTED PAIR GND(PIN11)
30	TWISTED PAIR GND(PIN31)	TWISTED PAIR GND(PIN31)
31	nInit	nInit
32	nFault	NDataAvail
33	0V	0V
34	NC	NC
35	NC	NC
36	nSelectIn	IEEE1284Active

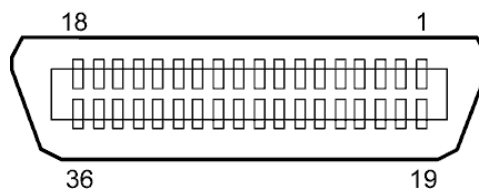

IEEE1284-B Connector

■ **USB interface**

Standard: Conforming to V2.0 Full speed  
 Transfer type: Control transfer, Bulk transfer  
 Transfer rate: Full speed (12M bps)  
 Class: Printer class  
 Control mode: Status with the receive buffer free space information  
 Number of ports: 1  
 Power source: Self power  
 Connector: Type B

Pin No.	Signal
1	VCC
2	D-
3	D+
4	GND

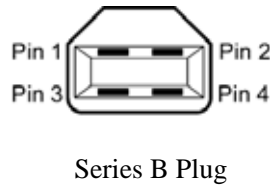

■ **LAN**

Standard: IEEE802.3 10BASE-T/100BASE-TX  
 Number of ports: 1  
 Connector: RJ-45  
 LED status: Link LED  
 Activity LED

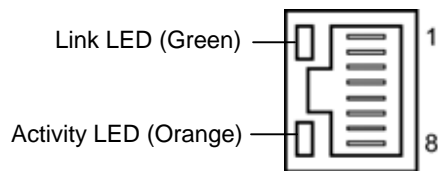

LED	LED Status	LAN status
Link	ON	10Mbps link or 100Mbps link is detected.
	OFF	No link is detected. * <i>Communication cannot be made while the Link LED is off.</i>
Activity	ON	Communicating
	OFF	Idle

LAN cable: 10BASE-T: UTP category 3 or category 5  
 100BASE-TX: UTP category 5  
 Cable length: Segment length Max. 100 m

**NOTES:**

1. For IP address setting, refer to **Section 2.9.7 IP Address Setting (TCP/IP)**.
2. When a generally-used twisted pair Ethernet (TPE) or UTP cable is used, a communication error may occur depending on your operating environment. In such case, you may be requested to use a shielded twisted pair cable.

### ■ Serial interface (Option: B-SA704-RS-QM-R)

Type:	RS-232C
Communication mode:	Full duplex
Transmission speed:	2400 bps, 4800 bps, 9600 bps, 19200 bps, 38400 bps, 115200 bps
Synchronization:	Start-stop synchronization
Start bit:	1 bit
Stop bit:	1 bit, 2 bit
Data length:	7 bit, 8 bit
Parity:	None, EVEN, ODD
Error detection:	Parity error, Framing error, Overrun error
Protocol:	Unprocedure communication
Data input code:	ASCII code, European character 8 bit code, graphic 8 bit code, JIS8 code, Shift JIS Kanji code, JIS Kanji code
Receive buffer:	1M byte
Connector:	

Pin No.	Signal
1	N.C
2	TD (Transmit Data)
3	RD (Received Data)
4	DSR (Data Set Ready)
5	SG (Signal Ground)
6	DTR (Data Terminal Ready)
7	CTS (Clear to Send)
8	RTS (Request to Send)
9	N.C

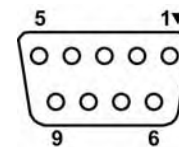

**■ Wireless LAN (Option: B-SA704-WLAN-QM-R)**

Standard:	Conforming to IEEE802.11a, IEEE802.11b, and IEEE802.11g
Protocol:	IP (RFC791), ICMP (RFC792), UDP (RFC768), TCP (RFC793,896), ARP (RFC826), HTTPD (RFC1866), TELNET, FTPD (RFC959), DHCP (RFC2131), SNMP
Security protocol:	WEP (64 bits/128 bits/152 bits) or AES, AES-OCB (128 bits) TKIP (only when using WPA, WPA-PSK) TWSL (unique encryption)
Antenna:	Chip type, diversity antenna
Parameter setting:	via HTTP
Default IP address:	192.168.10.21
Default subnet mask:	255.255.255.0

**NOTE:**

*MAC address of the Wireless LAN module will be necessary when setting the MAC address filtering function of an access point. Please ask a service person of your nearest TOSHIBA TEC service representative.*

■ Expansion I/O Interface (Option: B-SA704-IO-QM-R)

Input Signal IN0 to IN5  
 Output Signal OUT0 to OUT6  
 Connector (External Device Side) FCN-781P024-G/P or equivalent  
 Connector (Printer Side) FCN-685J0024 or equivalent

Pin	Signal	I/O	Function	Pin	Signal	I/O	Function
1	IN0	Input	FEED	13	OUT6	Output	
2	IN1	Input	PRINT	14	N.C.	----	
3	IN2	Input	PAUSE	15	COM1	Common (Power)	
4	IN3	Input		16	N.C.	----	
5	IN4	Input		17	N.C.	----	
6	IN5	Input		18	N.C.	----	
7	OUT0	Output	FEED	19	N.C.	----	
8	OUT1	Output	PRINT	20	N.C.	----	
9	OUT2	Output	PAUSE	21	COM2	Common (Ground)	
10	OUT3	Output	ERROR	22	N.C.	----	
11	OUT4	Output		23	N.C.	----	
12	OUT5	Output	POWER ON	24	N.C.	----	

N.C.: No Connection

Input Circuit

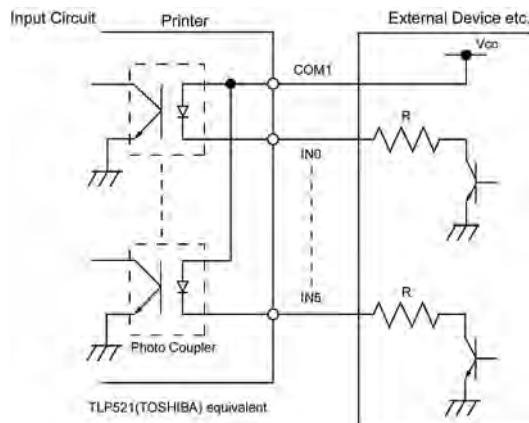

Output Circuit

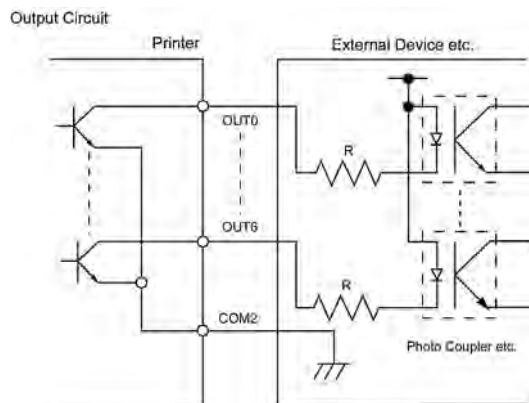

Operating environment Temperature: 0 to 40 °C  
 Humidity: 20 to 90% (No Condensation)

## APPENDIX 3 PRINT SAMPLES

### ■ Font

<A>Times Roman medium:8point

<B>Times Roman medium:10point

<C>Times Roman bold:10point

<D>Times Roman bold:12point

<E>Times Roman bold:14point

<F>Times Roman italic:12point

<G>Helvetica medium:6point

<H>Helvetica medium:10point

<I>Helvetica medium:12point

<J>Helvetica bold:12point

<K>Helvetica bold:14point

<L>Helvetica italic:12point

<M>PRESENTATION BOLD:18POINT

<N>Letter Gothic medium:9.5point

<O>Prestige Elite medium:7point

<P>Prestige Elite bold:10point

<Q>Courier medium:10point

<R>Courier bold:12point

<S>OCR-A:12point

<T>OCR-B:12point

<Outline Font:B>Helvetica bold

<Outline Font:B>Helvetica bold

# APPENDIX 3 PRINT SAMPLES (Cont.)

■ Bar codes

0: JAN8, EAN8



1: MSI



2: Interleaved 2 of 5



3: CODE39 (Standard)



4: NW7



5: JAN13, EAN13



6: UPC-E



7: EAN13+2 digits



8: EAN13+5 digits



A: CODE128



B: CODE39 (Full ASCII)



C: CODE93



G: UPC-E+2 digits



H: UPC-E+5 digits



I: EAN8+2 digits



J: EAN8+5 digits





# APPENDIX 3 PRINT SAMPLES (Cont.)

**K: UPC-A**



**L: UPC-A+2 digits**



**M: UPC-A+5 digits**



**N: UCC/EAN128**



**O: Industrial 2 of 5**



**P: PDF417**



**Q: Data Matrix**



**R: Customer bar code**



**S: Customer bar code of high priority**



**T: QR code**



**U: POSTNET**



**V: RM4SCC**



**W: KIX Code**



**X: Micro PDF417**



**Z: MaxiCode**

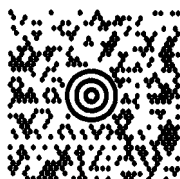

## APPENDIX 4 GLOSSARIES

### **Bar code**

A code which represents alphanumeric characters by using a series of black and white stripes in different widths. Bar codes are used in various industrial fields: Manufacturing, Hospitals, Libraries, Retail, Transportation, Warehousing, etc. Reading bar codes is a fast and accurate means of capturing data while keyboard entry tends to be slow and inaccurate.

### **Batch mode**

Issue mode that continuously prints media until the specified number of media has been printed.

### **Black mark**

A mark printed on the media so that the printer can maintain a constant print position by detecting this mark.

### **Black mark sensor**

A reflective sensor which detects the difference of potential between the black mark and print area to find the print start position.

### **Cut mode**

Printer mode of operation where an optional cutter module is installed to automatically cut media from the supply roll after they are printed. The print command can specify to cut every media or to cut after a set number of media have been printed.

### **Cutter module**

A device used to cut the media.

### **DPI**

Dot Per Inch

The unit used to express print density.

### **Expansion I/O interface**

An optional interface circuit that may be installed into the B-852 printer to allow the printer to be connected to an external device such as a wrapping machine and to receive feed, print start, and pause signals from the external device and to send back print, pause, and error status signals to the external device.

### **Feed gap sensor**

A transmissive sensor which detects the difference of potential between the gap between labels and the label to find the print position of the label.

### **Font**

A complete set of alphanumeric characters in one style of type. E.g. Helvetica, Courier, Times

### **Gap**

Clearance between labels

### **IPS**

Inch per second

The unit used to express print speed.

### **LCD**

Liquid Crystal Display

Installed on the operation panel and displays operation modes, error message and so on.

### **Label**

A type of media with adhesive backing.

### **Media**

Material on which data is printed by the printer. Label, tag paper, fanfold paper, perforated paper, etc.

### **Plug and Play**

When Plug and Play is enabled, the PC will automatically identify the printer (if the PC supports Plug & Play), optimize the system resource (IRQ and DMA), and display a message prompting a printer driver installation.

### **Pre-printed media**

A type of media on which characters, logos, and other designs have been already printed.

### **Print head element**

The thermal print head consists of a single line of tiny resistive elements and when current is allowed to flow through each element it heats up causing a small dot to be burned onto thermal paper or a small dot of ink to be transferred from a thermal ribbon to ordinary paper.

**Print speed**

The speed at which printing occurs. This speed is expressed in units of ips (inches per second).

**Reflective sensor**

See Black mark sensor.

**Resolution**

The degree of detail to which an image can be duplicated. The minimum unit of divided image is called a pixel. As the resolution becomes higher, the number of pixels increased, resulting in more detailed image

**Ribbon**

An inked film used to transfer an image onto the media. In the thermal transfer printing, it is heated by the thermal print head, causing an image to be transferred onto the media

**Supply**

Media and ribbon

**Supply holder**

This unit holds a media roll at the rear of the printer so that the media is fed toward the print head.

**Tag**

A type of media having no adhesive backing but black marks to indicate the print area. Usually tags are made of cardboard or other durable material.

**Thermal direct printing**

A printing method using no ribbon, but thermal media which reacts to heat. The thermal print head heats the thermal media directly, causing print image to be printed on the media.

**Thermal print head**

A print head using thermal transfer or thermal direct printing method.

**Thermal transfer printing**

A printing method that the thermal print head heats an ink or resin coating on the ribbon against the media, causing the ink/resin to transfer onto the media.

**Threshold setting**

A sensor setting operation to have the printer maintain a constant print position of pre-printed media.

**Transmissive sensor**

See Feed gap sensor.

**USB (Universal Serial Bus)**

An interface that is used to connect peripherals, such as a printer, keyboard, mouse. The USB allows disconnection of a USB device without turning off the power.

**Web printer**

The web printer function allows you to browse the printer status on the PC, issue media, check or change the settings, or download the firmware to the printer. For details, refer to the **Network Specification**.

# INDEX

## B

Backing paper 7-1  
Bar code 6-2, A3-2, A4-1  
Batch mode 7-1, A4-1  
Black mark 2-10, 7-1, 7-2, A4-1  
Black mark length 7-1  
Black mark sensor 1-4, 2-10, 2-68, 2-72, 4-1, A4-1

## C

Centronics 1-3, 2-23, A2-1  
Cut mode 6-1, 7-1, A4-1  
Cut position fine adjustment 2-63  
Cutter module 1-1, 1-5, 2-60, 4-2, 6-2, A4-1

## D

DHCP 2-38  
DHCP client ID 2-38  
DHCP host name 2-39

## E

Effective print width 6-1, 7-1, 7-3  
ERROR LED 1-4, 3-1, A1-1  
Error message 5-1  
Expansion I/O interface 1-3, 2-12, 2-25, A2-6,  
A4-1  
Expansion I/O interface board 1-1, 1-5, 6-2

## F

Feed gap sensor 1-4, 2-10, 2-68, 2-70, 4-1, A4-1

## G

Gap between labels 7-2  
Gap length 7-1  
Gateway IP address 2-36  
Guaranteed print area 7-3

## H

Head block release lever 1-4, 2-8  
Head pressure adjust lever 1-3, 2-9

## I

Input voltage 6-1  
Interface 6-2, A2-1  
IP address 2-35, A2-3  
Issue mode 2-59, 6-1

## J

Jammed media 5-5

## L

Label 2-9, 7-1, 7-2, A4-1  
Label length 7-1  
LAN interface 6-2  
LCD language 2-19  
LCD message display 1-3, 1-4, 3-1, 6-1, A1-2

## M

Media 2-5, 7-1, 7-5, A4-1  
Media pitch 7-1

## O

ONLINE LED 1-4, 3-1, A1-1  
Operation Panel 1-3, 1-4, 3-1

## P

Paper guide 1-4, 2-8  
Parallel interface 1-3, 2-12, 6-2, A2-1  
Platen 1-4, 2-8, 4-1  
Power consumption 6-1  
Power cord 1-2, 2-4  
POWER LED 1-4, 3-1, A1-1  
Power switch 1-3, 2-4, 2-13  
Pre-printed media 2-59, 2-68, A4-1  
Print head 1-4, 4-1  
Print head block 1-4, 2-8, 4-1  
Print head cleaner 1-2, 4-1, 5-4  
Print length 7-1  
Print start position fine adjustment 2-62  
Print tone fine adjustment 2-66  
Printing method 6-1  
Printing speed 1-1, 6-1

## R

Real time clock 1-1, 1-5, 2-32, 6-2  
Reflective sensor 7-2  
Resolution 6-1, A4-2  
Ribbon 2-11, 7-4, 7-5, A4-2  
Ribbon holder 1-4  
Ribbon supply roll 2-11  
Ribbon take up roll 2-11  
Ribbon width 7-4  
RS-232C 1-12, 2-17, 2-18, 6-2, A2-4

**S**

Sensor adjust gear 2-10

Serial interface 1-3, A2-4

Serial interface board 1-1, 1-5, 6-2

Socket port 2-37

Subnet mask 2-37

Supply Holder Frame 1-2, 1-3, 2-3, 2-7

Supply Holder Locking Knob 2-5, 2-6

Supply Holder Unit 1-2, 1-3, 2-5, 2-7

**T**

Tag 2-9, 2-10, 7-1, A4-2

Thermal direct 2-66, 6-1, A4-2

Thermal transfer 2-66, 6-1, A4-2

Transmissive sensor 7-2

**U**

USB 1-3, 2-12, 6-2, A2-3, A4-2

**W**

Web printer 2-24

Wireless LAN 1-1, 1-3, 1-5, 2-12, 6-2, A2-5



## Free Manuals Download Website

<http://myh66.com>

<http://usermanuals.us>

<http://www.somanuals.com>

<http://www.4manuals.cc>

<http://www.manual-lib.com>

<http://www.404manual.com>

<http://www.luxmanual.com>

<http://aubethermostatmanual.com>

Golf course search by state

<http://golfingnear.com>

Email search by domain

<http://emailbydomain.com>

Auto manuals search

<http://auto.somanuals.com>

TV manuals search

<http://tv.somanuals.com>