

TOSHIBA

TOSHIBA Barcode Printer

B-SV4T SERIES

Owner's Manual
Mode d'emploi
Bedienungsanleitung
Manual de instrucciones
Gebruikershandleiding
Manuale Utente
Manual do Utilizador



TOSHIBA

TOSHIBA Barcode Printer

B-SV4T SERIES

Owner's Manual

CE Compliance (for EU only)

This product complies with the requirements of EMC and Low Voltage Directives including their amendments.

VORSICHT:

- *Schallemission: unter 70dB (A) nach DIN 45635 (oder ISO 7779)*
- *Die für das Gerät Vorgesehene Steckdose muß in der Nähe des Gerätes und leicht zugänglich sein.*

Centronics is a registered trademark of Centronics Data Computer Corp.
Microsoft is a registered trademark of Microsoft Corporation.
Windows is a trademark of Microsoft Corporation.

This equipment has been tested and found to comply with the limits for a Class B digital device, pursuant to Part 15 of the FCC Rules. These limits are designed to provide reasonable protection against harmful interference in a residential installation. This equipment generates, uses, and can radiate radio frequency energy and, if not installed and used in accordance with the instructions, may cause harmful interference to radio communications. However, there is no guarantee that interference will not occur in a particular installation. If this equipment does cause harmful interference to radio or television reception, which can be determined by turning the equipment off and on, the user is encouraged to try to correct the interference by one or more of the following measures:

- Reorient or relocate the receiving antenna.
- Increase the separation between the equipment and receiver.
- Connect the equipment into an outlet on a circuit different from that to which the receiver is connected.
- Consult the dealer or an experienced radio/TV technician for help.

(for USA only)

Changes or modifications not expressly approved by manufacturer for compliance could void the user's authority to operate the equipment.

"This Class B digital apparatus meets all requirements of the Canadian Interference-Causing Equipment Regulations."

"Cet appareil numérique de la classe B respecte toutes les exigences du Règlement sur le matériel brouilleur du Canada."

(for CANADA only)

The EA10953 AC adapter should be exclusively used for the B-SV4T Series printer.
The B-SV4T Series printer must be powered by the EA10953 AC adapter.

Waste Recycling information for users:

Following information is only for EU-member states:

The use of the crossed-out wheeled bin symbol indicates that this product may not be treated as general household waste.

By ensuring this product is disposed of correctly you will help prevent potential negative consequences for the environment and human health, which could otherwise be caused by inappropriate waste handling of this product. For more detailed information about the take-back and recycling of this product, please contact your supplier where you purchased the product.



Safety Summary

Personal safety in handling or maintaining the equipment is extremely important. Warnings and Cautions necessary for safe handling are included in this manual. All warnings and cautions contained in this manual should be read and understood before handling or maintaining the equipment.

Do not attempt to effect repairs or modifications to this equipment. If a fault occurs that cannot be rectified using the procedures described in this manual, turn off the power, unplug the machine, then contact your authorised TOSHIBA TEC representative for assistance.

Meanings of Each Symbol



This symbol indicates warning items (including cautions). Specific warning contents are drawn inside the Δ symbol. (The symbol on the left indicates a general caution.)



This symbol indicates prohibited actions (prohibited items). Specific prohibited contents are drawn inside or near the \odot symbol. (The symbol on the left indicates “no disassembling”.)



This symbol indicates actions which must be performed. Specific instructions are drawn inside or near the \bullet symbol. (The symbol on the left indicates “disconnect the power cord plug from the outlet”.)



WARNING

This indicates that there is the risk of **death** or **serious injury** if the machines are improperly handled contrary to this indication.



Any other than the specified AC voltage is prohibited.

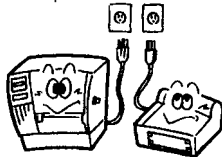

Do not use voltages other than the voltage (AC) specified on the rating plate, as this may cause **fire** or **electric shock**.



Prohibited

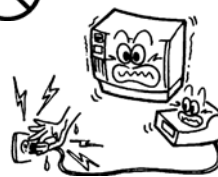

Do not plug in or unplug the power cord plug with wet hands as this may cause **electric shock**.



Prohibited



If the machines share the same outlet with any other electrical appliances that consume large amounts of power, the voltage will fluctuate widely each time these appliances operate. Be sure to provide an exclusive outlet for the machine as this may cause **fire** or **electric shock**.



Prohibited



Do not place metal objects or water-filled containers such as flower vases, flower pots or mugs, etc. on top of the machines. If metal objects or spilled liquid enter the machines, this may cause **fire** or **electric shock**.



Prohibited

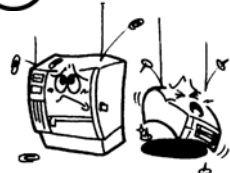

Do not insert or drop metal, flammable or other foreign objects into the machines through the ventilation slits, as this may cause **fire** or **electric shock**.



Prohibited



Do not scratch, damage or modify the power cords. Also, do not place heavy objects on, pull on, or excessively bend the cords, as this may cause **fire** or **electrical shock**.



Disconnect the plug.









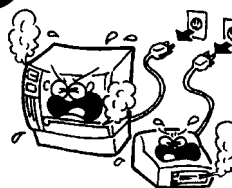

If the machines are dropped or their cabinets damaged, first turn off the power switches and disconnect the power cord plugs from the outlet, and then contact your authorised TOSHIBA TEC representative for assistance. Continued use of the machine in that condition may cause **fire** or **electric shock**.



Disconnect the plug.



Continued use of the machines in an abnormal condition such as when the machines are producing smoke or strange smells may cause **fire** or **electric shock**. In these cases, immediately turn off the power switches and disconnect the power cord plugs from the outlet. Then, contact your authorised TOSHIBA TEC representative for assistance.

 <p>Disconnect the plug.</p> 	<p>If foreign objects (metal fragments, water, liquids) enter the machines, first turn off the power switches and disconnect the power cord plugs from the outlet, and then contact your authorised TOSHIBA TEC representative for assistance. Continued use of the machine in that condition may cause fire or electric shock.</p>	 <p>Disconnect the plug.</p> 	<p>When unplugging the power cords, be sure to hold and pull on the plug portion. Pulling on the cord portion may cut or expose the internal wires and cause fire or electric shock.</p>
 <p>Connect a grounding wire.</p> 	<p>Ensure that the equipment is properly grounded. Extension cables should also be grounded. Fire or electric shock could occur on improperly grounded equipment.</p>	 <p>No disassembling.</p> 	<p>Do not remove covers, repair or modify the machine by yourself. You may be injured by high voltage, very hot parts or sharp edges inside the machine.</p>



CAUTION

This indicates that there is the risk of personal **Injury** or **damage** to objects if the machines are improperly handled contrary to this indication.

Precautions

The following precautions will help to ensure that this machine will continue to function correctly.

- Try to avoid locations that have the following adverse conditions:
 - * Temperatures out of the specification
 - * Shared power source
- * Direct sunlight
- * Excessive vibration
- * High humidity
- * Dust/Gas
- The cover should be cleaned by wiping with a dry cloth or a cloth slightly dampened with a mild detergent solution. NEVER USE THINNER OR ANY OTHER VOLATILE SOLVENT on the plastic covers.
- USE ONLY TOSHIBA TEC SPECIFIED paper and ribbons.
- DO NOT STORE the paper or ribbons where they might be exposed to direct sunlight, high temperatures, high humidity, dust, or gas.
- Ensure the printer is operated on a level surface.
- Any data stored in the memory of the printer could be lost during a printer fault.
- Try to avoid using this equipment on the same power supply as high voltage equipment or equipment likely to cause mains interference.
- Unplug the machine whenever you are working inside it or cleaning it.
- Keep your work environment static free.
- Do not place heavy objects on top of the machines, as these items may become unbalanced and fall causing **injury**.
- Do not block the ventilation slits of the machines, as this will cause heat to build up inside the machines and may cause **fire**.
- Do not lean against the machine. It may fall on you and could cause **injury**.
- Care must be taken not to injure yourself with the printer paper cutter.
- Unplug the machine when it is not used for a long period of time.
- Place the machine on a stable and level surface.

Request Regarding Maintenance

- Utilize our maintenance services.
After purchasing the machine, contact your authorised TOSHIBA TEC representative for assistance once a year to have the inside of the machine cleaned. Otherwise, dust will build up inside the machines and may cause a **fire** or a **malfunction**. Cleaning is particularly effective before humid rainy seasons.
- Our preventive maintenance service performs the periodic checks and other work required to maintain the quality and performance of the machines, preventing accidents beforehand.
For details, please consult your authorised TOSHIBA TEC representative for assistance.
- Using insecticides and other chemicals
Do not expose the machines to insecticides or other volatile solvents. This will cause the cabinet or other parts to deteriorate or cause the paint to peel.

TABLE OF CONTENTS

	Page
1. PRODUCT OVERVIEW	E1-1
1.1 Introduction.....	E1-1
1.2 Features.....	E1-1
1.3 Unpacking.....	E1-1
1.4 Accessories.....	E1-1
1.5 Appearance.....	E1-3
1.5.1 Dimensions.....	E1-3
1.5.2 Front View.....	E1-3
1.5.3 Rear View.....	E1-3
1.5.4 Interior.....	E1-4
1.5.5 Button and Indicator Lamp.....	E1-4
2. PRINTER SETUP	E2-1
2.1 Precautions.....	E2-1
2.2 Procedure before Operation.....	E2-2
2.3 Turning the Printer ON/OFF.....	E2-2
2.3.1 Turning ON the Printer.....	E2-2
2.3.2 Turning OFF the Printer.....	E2-3
2.4 Connecting the Cables to the Printer.....	E2-3
2.5 Connecting the Power Adapter and the Power Cord.....	E2-4
2.6 Opening/Closing the Top Cover.....	E2-5
2.7 Loading the Media.....	E2-7
2.8 Loading the Ribbon.....	E2-13
2.9 Media Sensor Calibration, Self Print Test, and Dump Mode Utilities.....	E2-15
2.9.1 Media Sensor Calibration.....	E2-15
2.9.2 Self Print Test and Dump Mode.....	E2-15
3. MAINTENANCE	E3-1
3.1 Cleaning.....	E3-1
3.1.1 Print Head.....	E3-1
3.1.2 Platen/Sensors.....	E3-2
3.1.3 Cover.....	E3-2
3.2 Care/Handling of the Media and Ribbon.....	E3-3
4. TROUBLESHOOTING	E4-1
4.1 Troubleshooting Guide.....	E4-1
4.2 Removing Jammed Media.....	E4-1
APPENDIX 1 SPECIFICATIONS	EA1-1
A1.1 Printer.....	EA1-1
A1.2 Options.....	EA1-2
A1.3 Media.....	EA1-2
A1.3.1 Media Type.....	EA1-2
A1.3.2 Detection Area of the Transmissive Sensor.....	EA1-3
A1.3.3 Detection Area of the Reflective Sensor.....	EA1-4
A1.3.4 Effective Print Area.....	EA1-5
A1.4 Ribbon.....	EA1-5

APPENDIX 2 INTERFACE EA2-1

GLOSSARIES

INDEX

CAUTION!

- 1. This manual may not be copied in whole or in part without prior written permission of TOSHIBA TEC.*
- 2. The contents of this manual may be changed without notification.*
- 3. Please refer to your local Authorized Service representative with regard to any queries you may have in this manual.*

1. PRODUCT OVERVIEW

1.1 Introduction

Thank you for choosing the TOSHIBA B-SV4T series barcode printer. This Owner's Manual contains valuable information from general set-up to confirming the printer's operation using test prints. You should read it carefully to help you gain maximum performance and life from your printer. This manual should be kept close at hand for everyday reference. Please contact your TOSHIBA TEC representative for further information concerning this manual.

1.2 Features

This printer has the following features:

- This printer is equipped with a 32-bit RISC processor, which offers up to 5 inches/sec. print speed.
- A standard USB interface for convenient label printing connectivity.
- The clamshell design and moveable media sensor enable easy media loading and use of a wide range of media.
- All frequently used bar code formats are available in this printer. Fonts and bar codes can be printed in any rotation.
- This printer provides a choice of six different type faces of alphanumeric font, and outline font printing capability.
- This is the most cost-effective and high performance printer in this class.

1.3 Unpacking

1. Unpack the printer.
2. Check for damage or scratches on the printer. However, please note that TOSHIBA TEC shall have no liability for any damage of any kind sustained during transportation of the product.
3. Keep the cartons and pads for future transportation of the printer

1.4 Accessories

When unpacking the printer, please check that the following accessories are supplied with the printer.

- | | |
|--|---|
| <input type="checkbox"/> CD-ROM (1 copy) | <input type="checkbox"/> Power Adapter (1 pc.) |
| <input type="checkbox"/> Ribbon Spindle (2 pcs.) | <input type="checkbox"/> Media Shaft (1 pc.) |
| <input type="checkbox"/> Media Holder (2 pcs.) | <input type="checkbox"/> Media Holder Spacer (2 pcs.) |

■ When purchasing the power cord

Since the power cord set is not enclosed in this unit, please purchase an approved one that meets the following standard from your Authorised TOSHIBA TEC representative.

(As of September 2004)

Country	Agency	Certification mark	Country	Agency	Certification mark	Country	Agency	Certification mark
Australia	SAA		Germany	VDE		Sweden	SEMKKO	
Austria	OVE		Ireland	NSAI		Switzerland	SEV	
Belgium	CEBEC		Italy	IMQ		UK	ASTA	
Canada	CSA		Japan	METI		UK	BSI	
Denmark	DEMKO		Netherlands	KEMA		U.S.A.	UL	
Finland	FEI		Norway	NEMKO		Europe	HAR	
France	UTE		Spain	AEE				

Power Cord Instruction				
1. For use with 100 – 125 Vac mains power supply, please select a power cord rated Min. 125V, 10A. 2. For use with 200 – 240 Vac mains power supply, please select a power cord rated Min. 250V. 3. Please select a power cord with the length of 4.5m or less.				
Country/Region	North America	Europe	United Kingdom	Australia
Power Cord Rated (Min.) Type	125V, 10A SVT	250V H05VV-F	250V H05VV-F	250V AS3191 approved, Light or Ordinary Duty type
Conductor size (Min.)	No. 3/18AWG	3 x 0.75 mm ²	3 x 0.75 mm ²	3 x 0.75 mm ²
Plug Configuration (locally approved type)				
Rated (Min.)	125V, 10A	250V, 10A	250V, *1	250V, *1

*1: At least, 125% of the rated current of the product.

1.5 Appearance

1.5.1 Dimensions

The names of the parts or units introduced in this section are used in the following chapters.

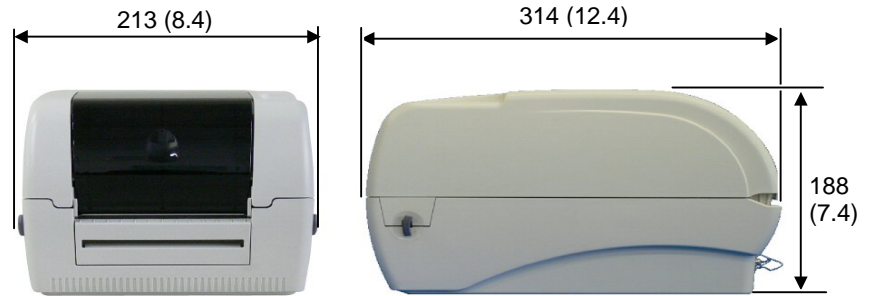

Dimensions in mm (inches)

1.5.2 Front View

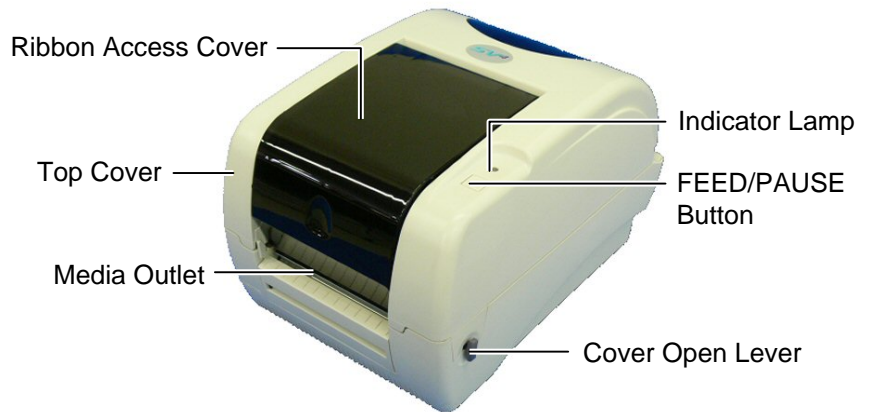

1.5.3 Rear View

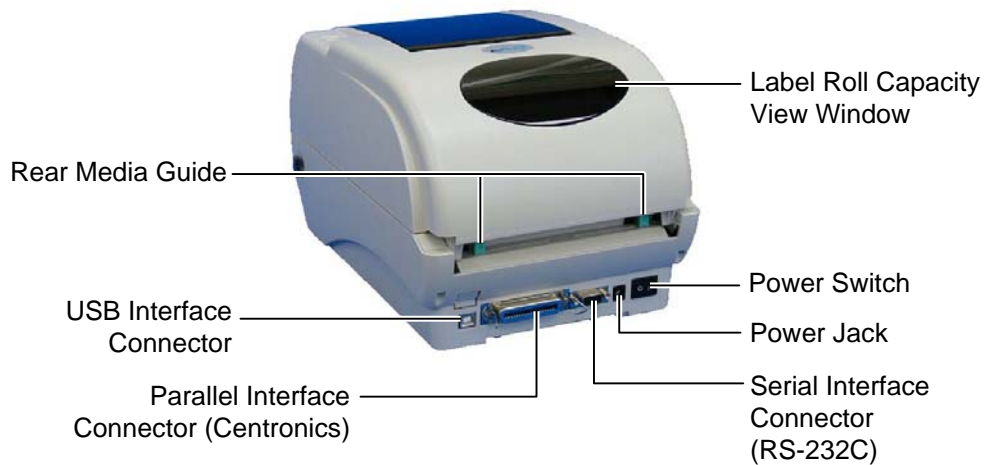

1.5.4 Interior

WARNING!
 Do not touch the print head or around it just after printing. You may get burned as the print head becomes very hot during printing.

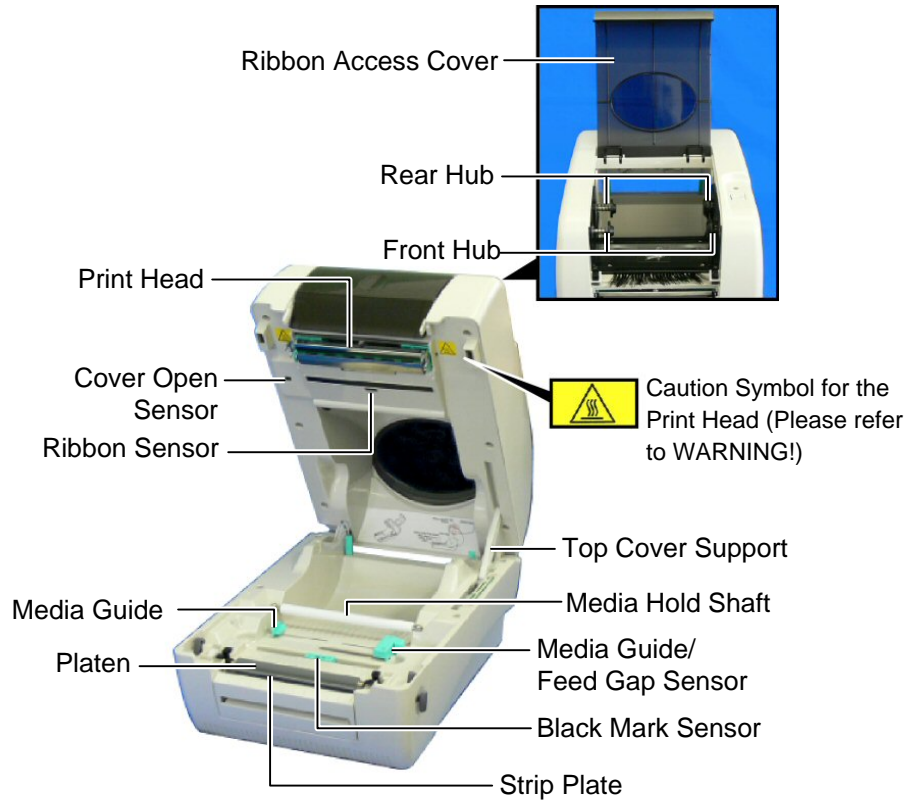

1.5.5 Button and Indicator Lamp

The FEED/PAUSE Button and the Indicator Lamp have the following functions:

As the FEED button	<ul style="list-style-type: none"> Pressing this button when the printer is in online state causes a media feed. Pressing this button after removing a cause of an error returns the printer to online state.
As the PAUSE button	<ul style="list-style-type: none"> Pressing this button during printing stops printing after completing the current label. The printer resumes printing when this button is pressed again.

Color	Illuminates when...	Flashes when...
RED	<ul style="list-style-type: none"> A print error, such as a memory error, syntax error, etc. The top cover is opened. 	<ul style="list-style-type: none"> There is no label. The ribbon has run out or torn.
GREEN	<ul style="list-style-type: none"> The printer is on-line and ready to print. 	<ul style="list-style-type: none"> The button is pressed as a PAUSE function. The printer is downloading files.

2. PRINTER SETUP

This section outlines the steps necessary to setup your printer prior to its operation. The section includes precautions, connecting cables, assembling accessories, loading media and ribbon, and performing a test print.

2.1 Precautions

To insure the best operating environment, and to assure the safety of the operator and the equipment, please observe the following precautions.

- Operate the printer on a stable, level, operating surface in a location free from excessive humidity, high temperature, dust, vibration or direct sunlight.
- Keep your work environment static free. Static discharges can cause damage to delicate internal components.
- Make sure that the printer is connected to a clean source of AC Power and that no other high voltage devices that may cause line noise interference are connected to the same mains.
- Ensure that the printer is connected only to AC mains that has a proper ground (earth) connection.
- Do not operate the printer with the cover open. Be careful not to allow fingers or articles of clothing to get caught into any of the moving parts of the printer.
- Make sure to turn off the printer power and to remove the power adapter connector from the printer whenever working on the inside of the printer or when cleaning the printer.
- For best results, and longer printer life, use only TOSHIBA TEC recommended media and ribbon. (Refer to the Supply Manual.)
- Store the media and ribbon in accordance with the specifications.
- This printer mechanism contains high voltage components; therefore you should never remove any of the covers of the machine as you may receive an electrical shock. Additionally, the printer contains many delicate components that may be damaged if accessed by unauthorized personnel.
- Clean the outside of the printer with a clean dry cloth or a clean cloth slightly dampened with a mild detergent solution.
- Use caution when cleaning the thermal print head as it may become very hot while printing. Wait until it has had time to cool before cleaning. Use only the TOSHIBA TEC recommended print head cleaner to clean the print head.
- Do not turn off the printer power or remove the power plug while the printer is printing or while the Indicator Lamp is flashing.

2.2 Procedure before Operation

NOTE:

To communicate directly with a host computer, an RS-232C, Centronics, or USB cable is required.

(1) RS-232C cable: 9 pins

(do not use a null modem cable)

(2) Centronics cable: 36 pins

(3) USB cable: V1.1

NOTE:

Use of a Windows Driver will allow issuing media on the printer from a Windows application.

The printer can also be controlled with its own programming commands. For details, please contact your TOSHIBA TEC reseller.

This section describes the outline of the printer setup.

1. Unpack the accessories and printer from the box.
2. Refer to Safety Precautions in this manual and set up the printer at a proper location.
3. Make sure that the Power Switch is off. (Refer to **Section 2.3**.)
4. Connect the printer to a host computer with an RS-232C, Centronics interface, or USB cable. (Refer to **Section 2.4**.)
5. Connect the Power Adapter to the printer, and then plug the Power Cord into a properly grounded power outlet. (Refer to **Section 2.5**.)
6. Load the media. (Refer to **Section 2.7**.)
7. Adjust the position of the Feed Gap Sensor or Black Mark Sensor to match the media being used. (Refer to **Section 2.7**.)
8. Load the ribbon. (Refer to **Section 2.8**.)
9. Turn the Power ON. (Refer to **Section 2.3**.)
10. Install the Printer Drivers in the host computer. (Refer to the Printer Driver in the CD-ROM.)

2.3 Turning the Printer ON/OFF

When the printer is connected to a host computer it is good practice to turn the printer ON before turning on the host computer and to turn OFF the host computer before turning off the printer.

2.3.1 Turning ON the Printer

CAUTION!

Use the power switch to turn the printer On/Off. Plugging or unplugging the power cord to turn the printer On/Off may cause fire, an electric shock, or damage to the printer.

1. To turn ON the printer power, press the power switch as shown in the picture below. Note that (|) is the power ON side of the switch.

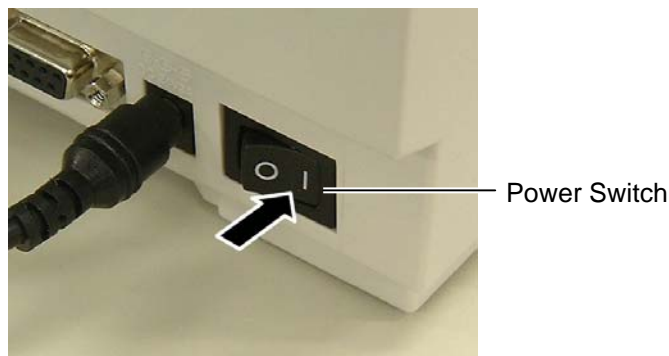

2. Check that the Indicator Lamp is illuminated in green.

NOTE:

If the Red Indicator Lamp is illuminated, go to **Section 4.1, Troubleshooting Guide**.

2.3.2 Turning OFF the Printer

CAUTION!

1. Do not turn off the printer power while the media is being printed as this may cause a paper jam or damage to the printer.
2. Do not turn off the printer power while the Green Indicator Lamp is flashing as this may cause damage to the data being downloaded.

1. Before turning off the printer power switch verify that the Indicator Lamp is illuminated in green, not flashing.
2. To turn OFF the printer power press the power switch as shown in the diagram below. Note that (O) is the power OFF side of the switch.

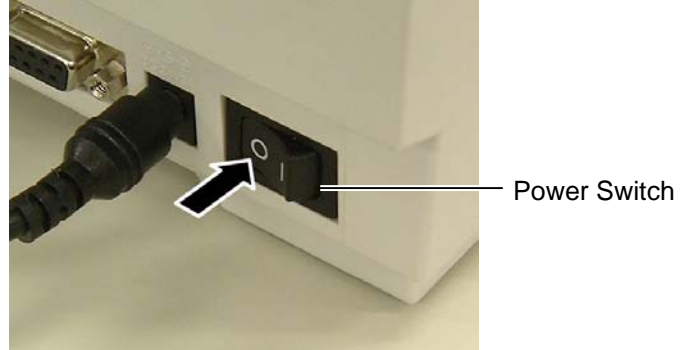

2.4 Connecting the Cables to the Printer

NOTE:

*For the specifications of the serial interface cable, refer to **APPENDIX 2, INTERFACE.***

The following paragraphs outline how to connect the cables from the printer to your host computer, and will also show how to make cable connections to other devices. Depending on the application software you use to print labels, there are three possibilities for connecting the printer to your host computer. These are:

- A serial cable connection between the printer's RS-232C serial connector and one of your host computer's COM ports.
- A parallel cable connection between the printer's standard parallel connector and your host computer's parallel port (LPT).
- A USB cable connection between the printer's USB interface connector and one of your host computer's USB port.

The diagram below shows all the possible cable connections to the current version of the printer.

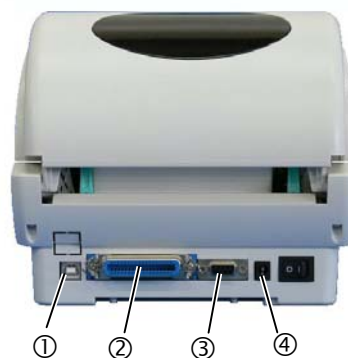

- ① USB Interface
- ② Parallel Interface (Centronics)
- ③ Serial Interface (RS-232C)
- ④ Power Jack

2.5 Connecting the Power Adapter and the Power Cord

NOTES:

1. Since the power cord is not enclosed in this printer, please purchase a proper one after referring to page 1-2.
2. The EA10953 AC adapter should be exclusively used for the B-SV4T Series printer. The B-SV4T Series printer must be powered by the EA10953 AC adapter.

1. Make sure that the printer power switch is in the OFF (O) position.
2. Insert the Power Cord into the inlet of the Power Adapter.

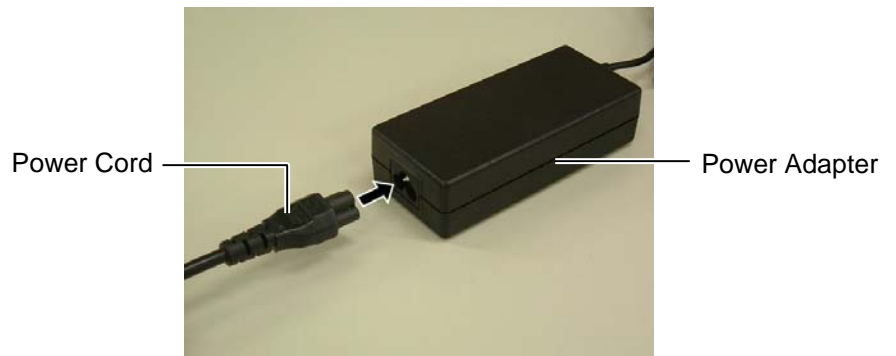

3. Insert the Power Adapter connector into the Power Jack on the rear of the printer.

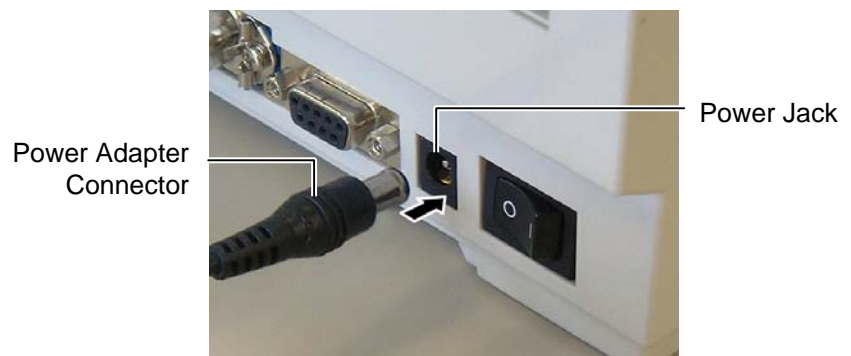

4. Plug the other end of the Power Cord into a grounded outlet as shown in the figure below.

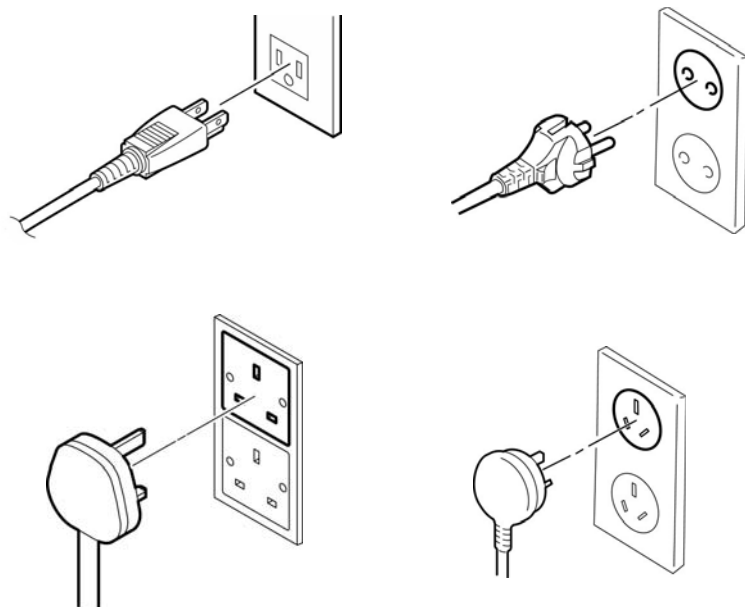

2.6 Opening/Closing the Top Cover

When opening or closing the Top Cover, please be sure to follow the instructions below.

WARNING!

1. To avoid injury, be careful not to trap your fingers while opening or closing the cover.
2. When closing the Top Cover, do not place your hands or fingers between the Top Cover and the Lower Cover. The Top Cover may free-fall, which may cause injury.

CAUTION!

1. Be careful not to touch the Print Head Element when opening the Top Cover. Failure to do this may cause missing dots by static electricity or other print quality problems.
2. Do not forcibly close the Top Cover while it is held at Position 1 or Position 2. Doing this could damage the Top Cover Support.

To open the Top Cover:

1. Turn the Cover Open Levers frontward, and gradually open the Top Cover.



There are four positions for the Top Cover: OPEN position, Position 1, Position 2, and CLOSE position. The Top Cover can be held at Position 1 or Position 2.

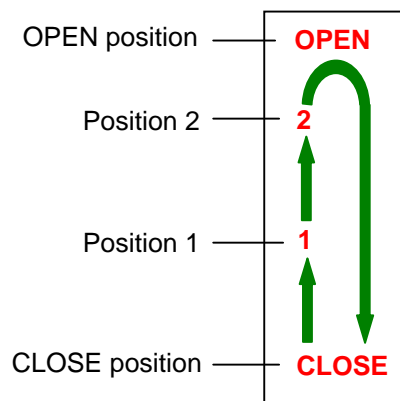

To hold the Top Cover at Position 1, first open the Top Cover until the Top Cover Support goes over Position 1 (①), then close the Top Cover a little (②) to secure the Top Cover Support.

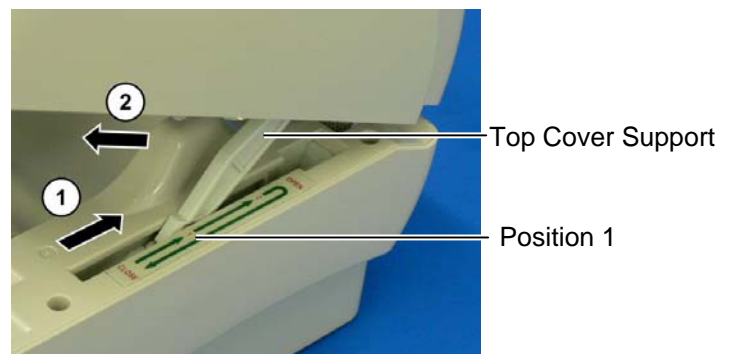

2.6 Opening/Closing the Top Cover (Cont.)

To hold the Top Cover at Position 2, first open the Top Cover until the Top Cover Support goes over Position 2 (①), then close the Top Cover a little (②) to secure the Top Cover Support.

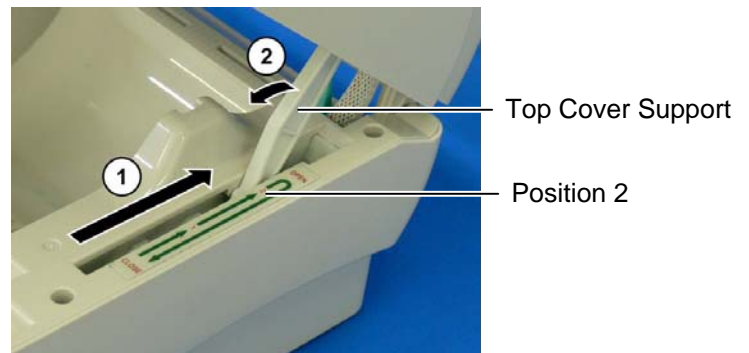

To close the Top Cover:

1. Open the Top Cover until the Top Cover Support goes to the OPEN position.

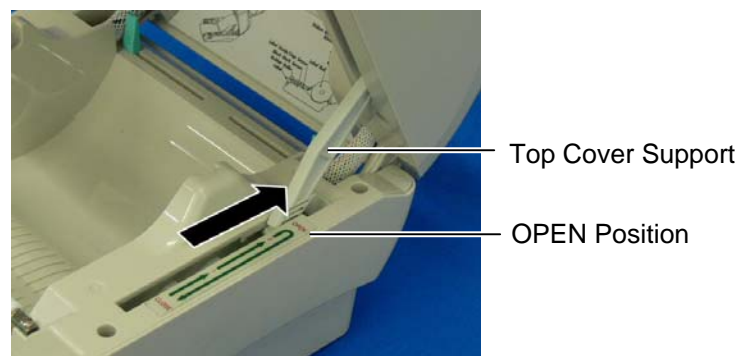

NOTE:
Be sure to close the Top Cover completely. Failure to do this may affect the print quality.

2. Hold the both sides of the Top Cover with your hands, and gently close it until you hear it click.



2.7 Loading the Media

This section describes in detail how to load a media roll.

WARNING!

1. Do not touch any moving parts. To reduce the risk of fingers, jewellery, clothing, etc. being drawn into the moving parts, be sure to load the media once the printer has stopped moving completely.
2. To avoid injury, be careful not to trap your fingers while opening or closing the Top Cover.

CAUTION!

Be careful not to touch the Print Head Element when opening the Top Cover. Failure to do this may cause missing dots by static electricity or other print quality problems.

NOTE:

When the outer roll diameter exceeds 127 mm (5") or the inner core diameter exceeds 38.1 mm (1.5"), an optional External Media Roll Hanger is required. For details, refer to page 2-12.

1. Turn OFF the printer.
2. Turn the Cover Open Levers frontward, and open the Top Cover.
3. When the inner core diameter of the media roll is 25.4 mm (1"), remove the Media Holder Spacers from the Media Holders. The Media Holder Spacers are required to print media rolls with 38.1-mm (1.5") inner core diameter.

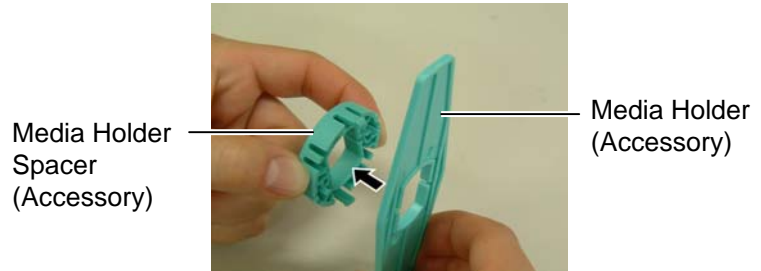

4. Insert the Media Shaft into the paper core so that the print side faces up as shown below.

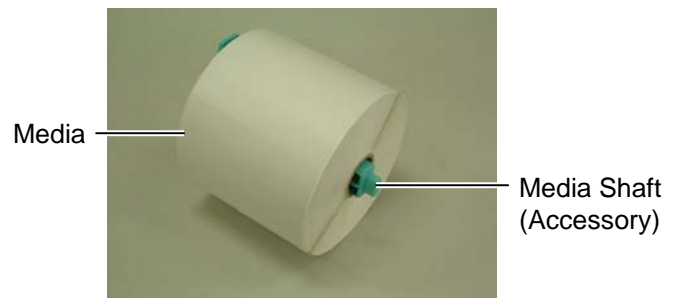

5. Hold the Media Holder with the smooth side facing the media roll, align the Media Holder's centre hole with the Media Shaft, and then install the Media Holder by sliding it onto the Media Shaft. Make sure that the media roll is positioned at the centre of the Media Shaft.

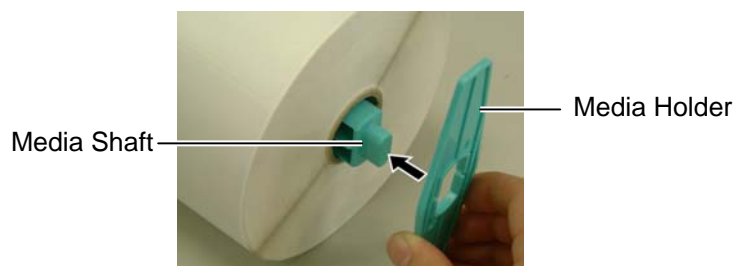

2.7 Loading the Media (Cont.)

6. Insert the both ends of the Media Shaft into the slots of the printer to place the Media Holder Ass'y into the printer. Make sure that the media feeds from the top, as shown below.

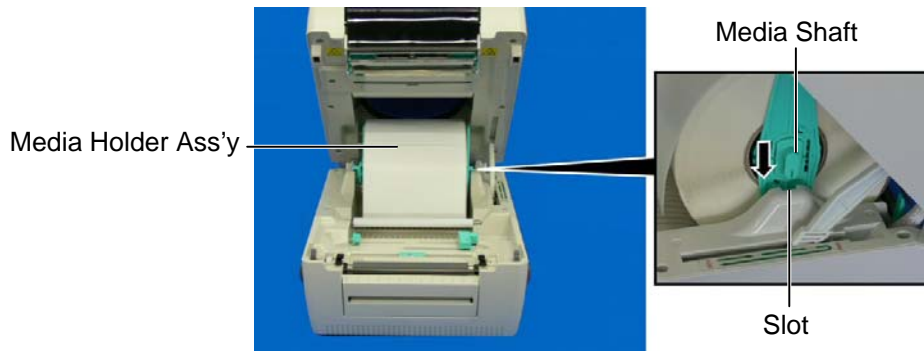

7. Insert the leading edge of the media under the Media Hold Shaft, and feed the media between the Media Guides.
8. Pull the media until it extends past the Media Outlet.

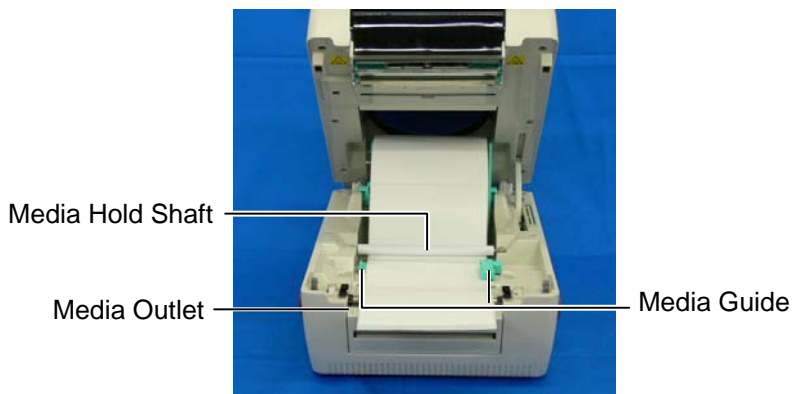
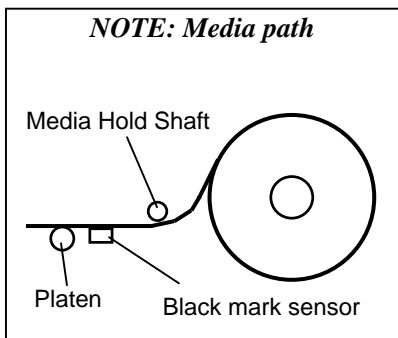

9. Manually adjust the Media Guide position to the media width.

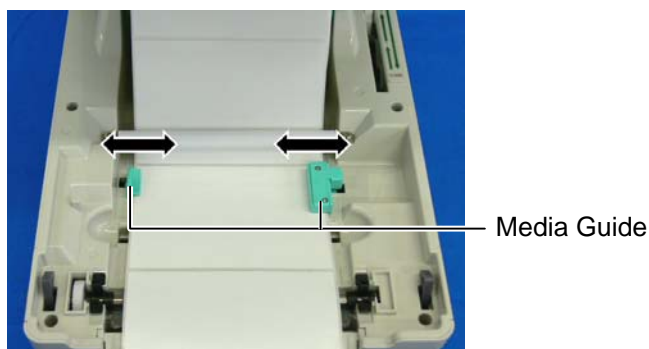

10. Make sure that the media path through the printer is straight, otherwise a skew feeding or a paper jam may occur.

2.7 Loading the Media (Cont.)

NOTES:

1. The selected sensor type is the one used in the last print job. The Feed Gap Sensor has been selected as the factory default. To change the sensor type, refer to **Section 2.9.1 Media Sensor Calibration.**
2. When the Media Guides are fitted to the media edges, the Feed Gap Sensor is positioned at 6 mm from the right end of media.

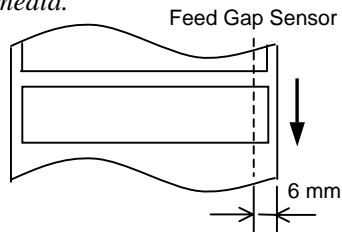

3. The Black Mark Sensor is movable in a range of media width.

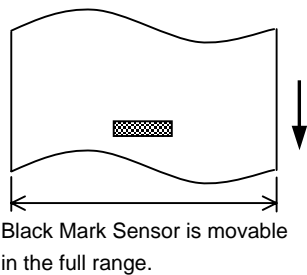

11. After loading the media, manually set the Media Sensor to the correct position. The Feed Gap Sensor is included in the right Media Guide. Position of the Feed Gap Sensor can be set by fitting the Media Guides to the media ends.

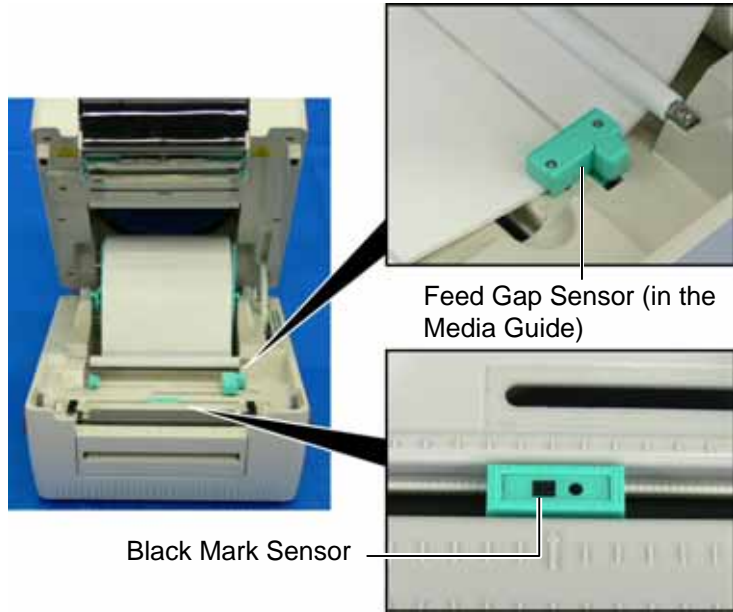

When using the Black Mark Sensor, it should be positioned in line with the centre of the black marks on the reverse side of the media.

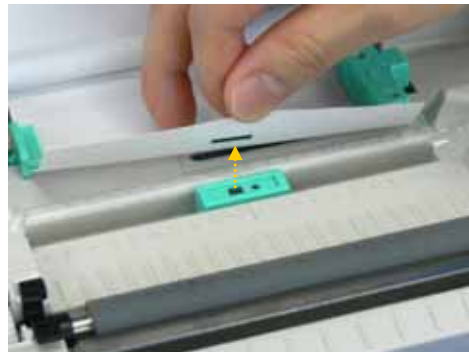

There are three issue modes available for this printer.

CAUTION!

To separate the printed media from the media roll in batch mode, be sure to tear off the media at the Media Outlet or cut the media past the Strip Plate. If you tear off the media at the Print Head by mistake, be sure to feed one label (10 mm or more) with the FEED/PAUSE Button prior to a next issue. Failure to do this may cause a paper jam.

Batch mode:

In the batch mode, the media is continuously printed and fed until the number of media specified in the issue command has been printed.



2.7 Loading the Media (Cont.)

Strip mode (Option):

When issued in the strip mode, labels are automatically removed from the backing paper each time a label is printed.

- **How to set the media**

When issuing labels in the strip mode, set the label in the following procedure:

1. Load the media as described on the previous pages.
2. Open the Strip Block by pulling it out.



Strip Block

NOTE:

When the media is correctly set, the backing paper is supposed to be pinched by the Platen and the Strip Feed Roller as shown below.

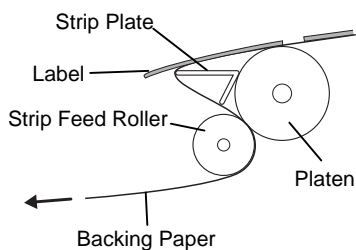

3. Feed the paper through the Media Guide until it extends past the platen.
4. Remove enough labels from the leading edge of the media to leave about 200 mm of backing paper free.
5. Pass the backing paper over the Platen and the Strip Plate, and insert the leading edge of the backing paper into the Backing Paper Slot.

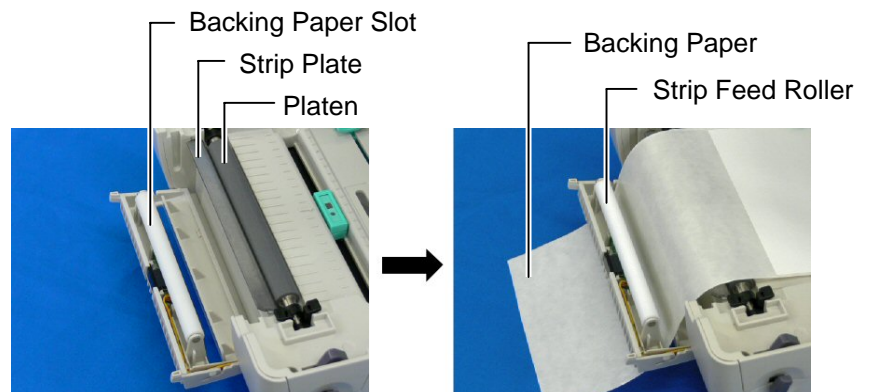

6. Close the Strip Block and Top Cover.



2.7 Loading the Media (Cont.)

WARNING!

The cutter is sharp, so care must be taken not to injure yourself when handling the cutter.

CAUTION!

- 1. Be sure to cut the backing paper of the label. Cutting labels will cause the glue to stick to the cutter which may affect the cutter quality and shorten the cutter life.*
- 2. Use of tag paper of which thickness exceeds the specified value may affect the cutter life.*

Cut mode (Option):

When the Cutter is installed, the media is automatically cut. After loading the media as described on the previous pages, insert the leading edge of the media through the Media Outlet of the Cutter Cover.

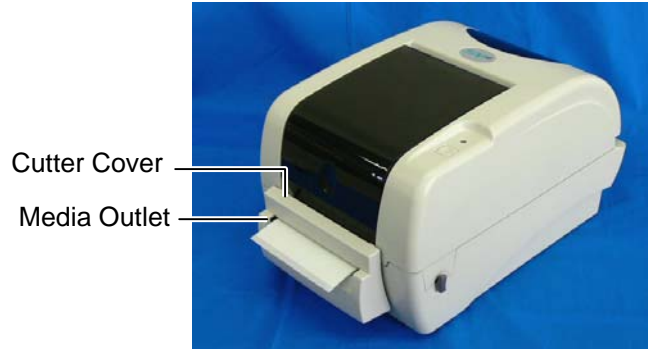

2.7 Loading the Media (Cont.)

When a media roll has an outside diameter exceeding 127 mm (5") or an inner core diameter of 38.1 mm (1.5"), the optional External Media Roll Hanger is required.

1. Fit the protrusions on the bottom of the printer into the holes in the External Media Roll Hanger.

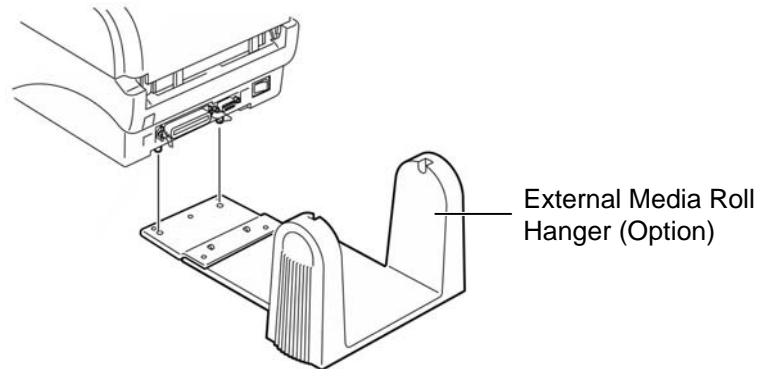

2. Load a media roll onto the printer's Media Holder Ass'y, and place it into the cuts of the External Media Roll Hanger.
3. Pull the media forward and insert the leading edge into the printer so that it passes between the Rear Media Guides.
4. Manually move the Rear Media Guides so that the media is centred.

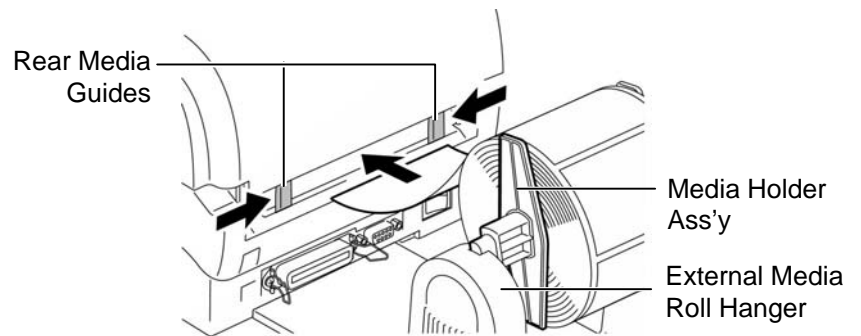

When the media roll has the inner core diameter of 76.2 mm (3"), use the 3"-Diameter Media Shaft supplied with the optional External Media Roll Hanger.

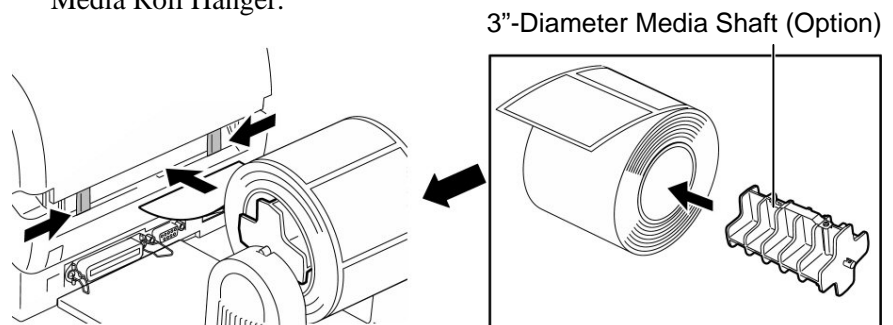

5. Refer to the previous pages to complete the media loading.
6. Close the Top Cover.

2.8 Loading the Ribbon

WARNING!

1. Do not touch any moving parts. To reduce the risk of fingers, jewellery, clothing, etc. being drawn into the moving parts, be sure to load the media once the printer has stopped moving completely.
2. To avoid injury, be careful not to trap your fingers while opening or closing the cover.

CAUTION!

Be careful not to touch the Print Head Element when opening the Top Cover. Failure to do this may cause missing dots by static electricity or other print quality problems.

NOTE: Inside of the Ribbon Access Cover

Rear Hub



Front Hub

When the printer is turned on, it automatically detects whether a ribbon is installed or not and switches the printing method between thermal transfer or direct thermal. If the printer does not detect a ribbon (direct thermal mode), the motor that drives the ribbon spindles will be turned off.

1. Open the Top Cover.
2. Push down on the Ribbon Access Cover to unlock and open.

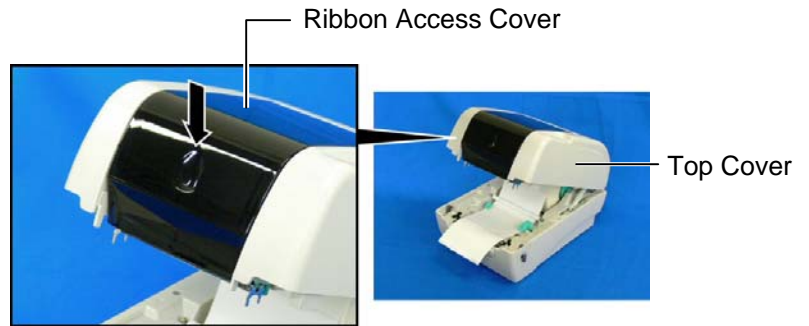

3. Insert one of the Ribbon Spindles into a ribbon core in the orientation shown below, with the ink side facing outside. Then, mount it on the Rear Hubs.

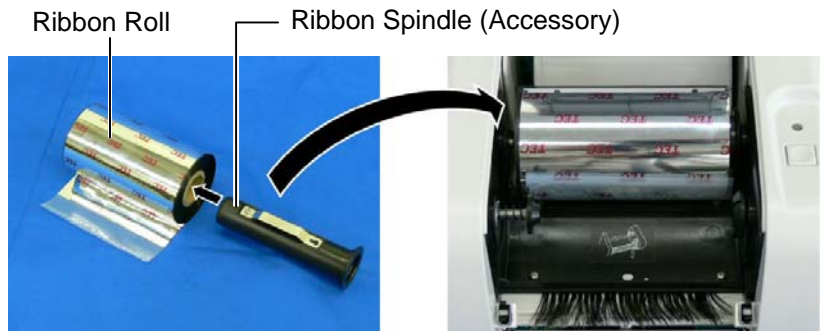

4. Insert the other Ribbon Spindle into the Paper Core supplied with the printer, and mount it on the Front Hubs.

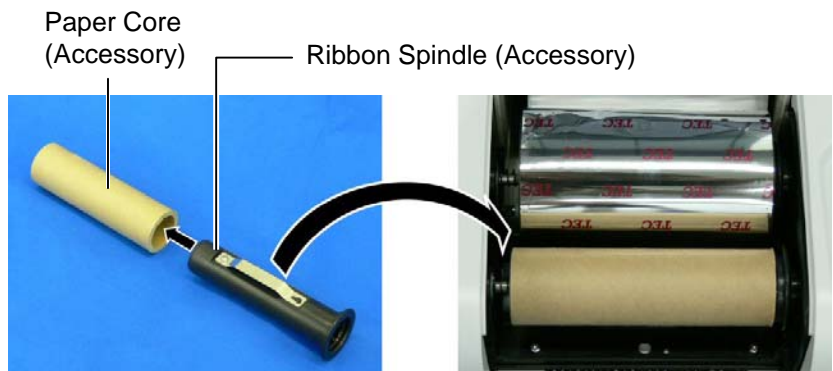

2.8 Loading the Ribbon (Cont.)

NOTES:

1. Take up any slack in the ribbon.
2. Do not load a ribbon when using a direct thermal media.

5. Pull the leader tape of the ribbon downward, and feed it under the Print Head.
6. Attach the leader tape to the Paper Core with adhesive tape.

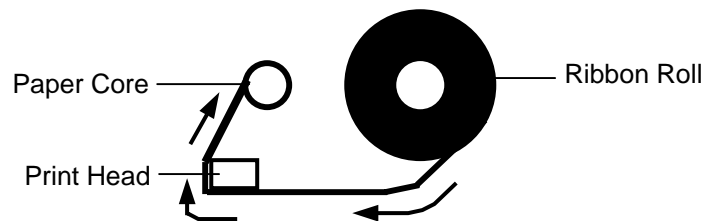

7. Rotate the Paper Core to take up the ribbon leader tape until it is thoroughly covered by the black section of the ribbon.



8. Close the Ribbon Access Cover and Top Cover.

2.9 Media Sensor Calibration, Self Print Test, and Dump Mode Utilities

This utility is used to calibrate the sensitivity of the Feed Gap/Black Mark Sensor.

It is necessary to set the media sensors after the media is changed to different type.

2.9.1 Media Sensor Calibration

NOTE:

The sensor type to be calibrated is the one used in the last print job. The Feed Gap Sensor has been selected as the factory default.

1. First, select the sensor to calibrate in the following procedure.

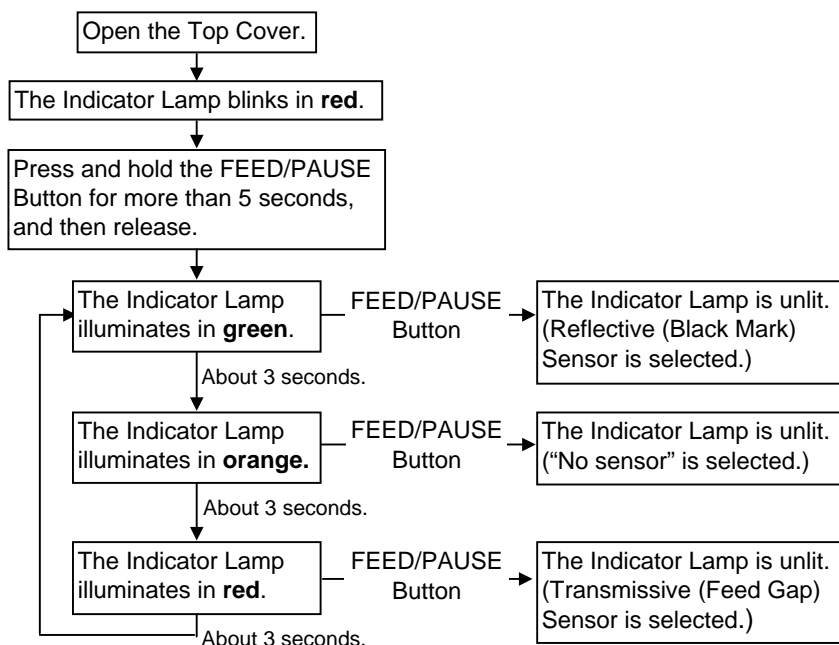

2. Turn off the printer power and install blank media (without pre-printing) on the printer.
3. To calibrate the Black Mark Sensor, align the sensor position with the black marks on the media. (Refer to **Section 2.7.**)
4. Press the FEED/PAUSE Button while turning on the printer. The Indicator Lamp will be illuminated in the following order: Orange → Orange (Flashing) → Red (Flashing)
5. Release the FEED/PAUSE Button when the Indicator Lamp flashes in red. This completes the Media Sensor calibration.
6. To start the Online operation, turn the printer off, then on again.

2.9.2 Self Print Test and Dump Mode

1. Turn off the printer power and install a media roll on the printer.
2. Press the FEED/PAUSE Button while turning on the printer. The Indicator Lamp will be illuminated in the following order: Orange → Orange (Flashing) → Red (Flashing) → Green
3. Release the FEED/PAUSE Button when the Indicator Lamp is illuminated in green.
4. The printer automatically performs a self print test, and then enters the Dump Mode.
5. To start the Online operation, turn the printer off, then on again.

2.9.2 Self Print Test and Dump Mode (Cont.)

Print test label sample

NOTE:
*The following commands should not affect the test print issue.
 D, AX, XS, Z2;1, Z2;2 (without AY)*

PRINTER INFO.	
PROGRAM VERSION	VX.XX XXXX
TONE ADJUST	+XX
FEED ADJUST	+XX.Xmm
CUT POSITION ADJUST	+XX.Xmm
BACKFEED ADJUST	+XX.Xmm
PARAMETER	[PC-850][0]
	[9600][8][1][NONE][0]
	[ON][AUTO][FEED][B0]
X-COORDINATE ADJUST	+XX.Xmm
SENSOR	TRANSMISSIVE [17]
MEMORY	[192KB][XXXXKB]
TTF AREA	[XXXXKB][XXXXKB]
EXT CHAR AREA	[XXXXKB][XXXXKB]
BASIC AREA	[XXXXKB][XXXXKB]
PC SAVE AREA	[XXXXKB][XXXXKB]
INFORMATION	XXXXXXXXXXXXXXXXXXXX
TOTAL FEED	X.XXKm

The test print contents should be changed by the following commands and parameters:

- PROGRAM VERSION: VX.XX XXXX --- Firmware version and checksum
- TONE ADJUST: +XX ----- Print tone fine adjustment value
- FEED ADJUST: +XX.Xmm ----- Print position fine adjustment value
- CUT POSITION ADJUST: +XX.Xmm ----- Cut position fine adjustment value
- BACKFEED ADJUST: +XX.Xmm ----- Back feed amount fine adjustment value
- PARAMETER: [PC-850][0] ----- Character code selection and Font "0" selection
- [9600][8][1][NONE][0] --- Baud rate, Data length, Stop bit length, Parity, and Transmission control of RS-232C
- [ON][AUTO][FEED][B0] ----- Forward feed wait function, Control code, Feed key function, and Euro code
- X-COORDINTE ADJUST: +XX.Xmm ----- X-coordinate fine adjustment value
- SENSOR: TRANSMISSIVE [17] ----- Sensor selection and sensitivity
- MEMORY: [192KB][XXXXKB] ----- Memory capacity of the Main PC Board and optional memory card (0,1,2,3,4,6,8)
- TTF AREA: [XXXXKB][XXXXKB] ----- True type font storage area, Main PC board and optional memory card
- EXT CHAR AREA: [XXXXKB][XXXXKB] -- Writable character storage area, Main PC board and optional memory card
- BASIC AREA: [XXXXKB][XXXXKB] ----- BASIC file storage area, Main PC board and optional memory card
- PC SAVE AREA: [XXXXKB][XXXXKB] ----- PC save storage area, Main PC board and optional memory card
- INFORMATION: ----- Printed only when some information is stored in the flash ROM
- TOTAL FEED ----- Total feed distance

3. MAINTENANCE

WARNING!

1. *Be sure to turn OFF the power before performing maintenance. Failure to do this may cause an electric shock.*
2. *To avoid injury, be careful not to trap your fingers while opening or closing the cover.*
3. *Be careful when handling the print head as it becomes very hot immediately after printing. Allow it to cool before performing any maintenance.*
4. *Do not pour water directly onto the printer.*

This chapter describes how to perform routine maintenance.

To ensure the continuous high quality operation of your printer, you should perform a regular maintenance routine. For high throughput it should be done on a daily basis. For low throughput it should be done on a weekly basis.

3.1 Cleaning

To maintain the printer performance and print quality, please clean the printer regularly, or whenever the media is replaced.

3.1.1 Print Head

CAUTION!

1. *Do not allow any hard objects to touch the print head or platen, as this may cause damage to them.*
2. *Do not use any volatile solvents including thinner and benzene, as this may cause discoloration of the cover, print failure, or breakdown of the printer.*
3. *Do not touch the print head element with bare hands, as static may damage the print head.*

NOTE:

Please purchase the Print Head Cleaner from the authorised TOSHIBA TEC service representative.

1. Turn the power off.
2. Open the Top Cover and Ribbon Access Cover.
3. Remove the ribbon.
4. Clean the Print Head Element with a Print Head Cleaner, cotton swab or soft cloth slightly moistened with ethyl alcohol.

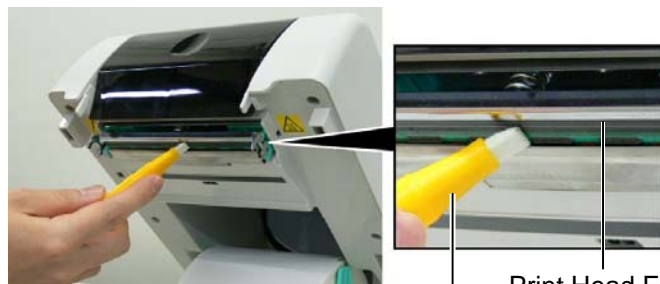

Print Head Cleaner

Print Head Element
(Positioned at the
print head edge)

3.1.2 Platen/Sensors

1. Wipe the Platen with a soft cloth moistened with absolute alcohol.
2. Remove dust or paper particles from the Black Mark Sensor, Feed Gap Sensor, and Ribbon Sensor using an air blower.

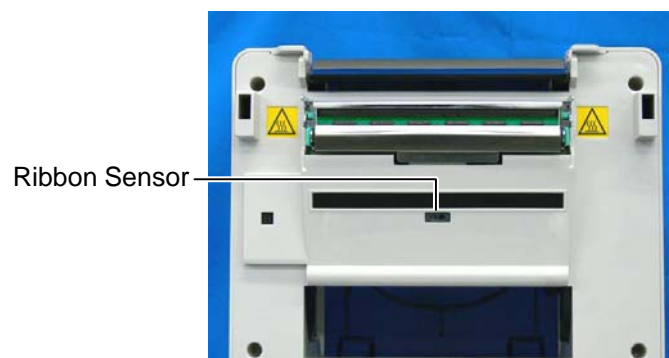
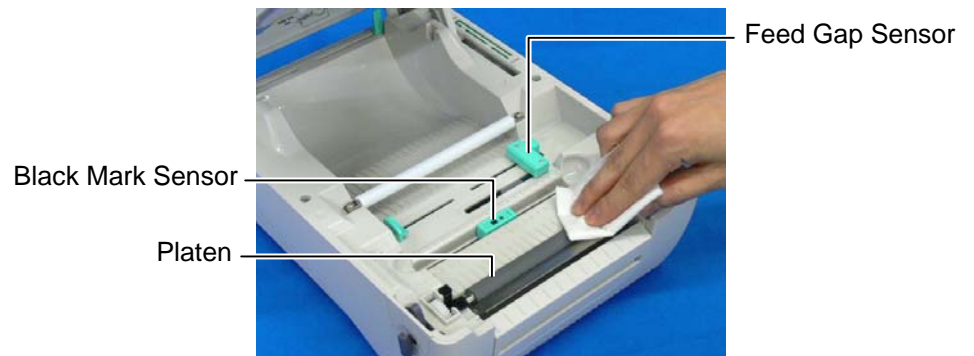

3.1.3 Cover

Wipe the Cover with a dry soft cloth. Wipe off dirt with a soft cloth slightly moistened with water.

CAUTION!

Do not use any volatile solvents including thinner and benzene, as this may cause discoloration or distortion of the cover.



3.2 Care/Handling of the Media and Ribbon

CAUTION!

Be sure to carefully review and understand the Supply Manual. Use only media and ribbon which meet specified requirements. Use of non-specified media or ribbon may shorten the head life and result in problems with bar code readability or print quality. All media and ribbons should be handled with care to avoid any damage to the media, ribbons, or printer. Read the guideline in this section carefully.

- Do not store media or ribbons for longer than the manufacturer's recommended shelf life
- Store media rolls on the flat end. Do not store them on the curved sides as this might flatten that side causing erratic media advance and poor print quality.
- Store the media in plastic bags and always reseal after opening. Unprotected media can get dirty and the extra abrasion from the dust and dirt particles will shorten the print head life.
- Store the media and ribbons in a cool, dry place. Avoid areas where they would be exposed to direct sunlight, high temperature, high humidity, dust or gas.
- The thermal paper used for direct thermal printing must not have specifications which exceed Ca^{2+} , K^+ , Na^+ 800 ppm, and Cl^- 600 ppm.
- Some ink used on pre-printed media may contain ingredients which shorten the print head's product life. Do not use labels pre-printed with ink which contain hard substances such as carbonic calcium (CaCO_3) and kaolin (Al_2O_3 , 2SiO_2 , $2\text{H}_2\text{O}$).

For further information, please contact your local distributor or your media and ribbon manufacturer.

4. TROUBLESHOOTING

This chapter lists the error messages, possible problems, and their solutions.

WARNING!

If a problem cannot be solved by taking actions described in this chapter, do not attempt to repair the printer. Turn off and unplug the printer. Then contact an authorised TOSHIBA TEC service representative for assistance.

4.1 Troubleshooting Guide

Problems	Solutions
The Online Indicator Lamp (green) is not illuminated.	<ol style="list-style-type: none"> 1. Check that the Power Cord is properly connected. 2. If the LED on the AC Adapter is not illuminated, please contact an authorised TOSHIBA TEC service representative.
The Online Indicator Lamp (green) is flashing.	The printer is in PAUSE state. Press the FEED/PAUSE Button to return to Online state.
The Error Indicator Lamp (red) is illuminated, not flashing.	The Top Cover is not closed completely. Close the Top Cover completely and confirm that the Indicator Lamp flashes. Then press the FEED/PAUSE Button to return to Online state.
The Error Indicator Lamp (red) is flashing.	<ol style="list-style-type: none"> 1. The media has run out. Install a new media roll. 2. The Media Sensor cannot detect the print start position. Retry the Media Sensor calibration. 3. A paper jam occurred. 4. The ribbon has run out. Install a new ribbon roll. 5. The ribbon has been torn. Check the status of the ribbon, and replace the ribbon, if necessary. 6. A cutter jam occurred. <p>After removing causes of the problems, press the FEED/PAUSE Button to return to Online state.</p>
Poor print quality	<ol style="list-style-type: none"> 1. The Top Cover is not closed completely. Close the Top Cover completely. 2. Clean the Print Head. 3. The media or ribbon being used does not meet the specification. Use TOSHIBA TEC recommended media only.

4.2 Removing Jammed Media

This section describes in detail how to remove jammed media from the printer.

CAUTION!

Do not use any tool that may damage the print head.

1. Turn the power off.
2. Open the Top Cover and remove the media roll.
3. Open the Ribbon Access Cover and remove the ribbon.
4. Remove the jammed media from the printer. DO NOT USE any sharp implements or tools as these could damage the printer.
5. Clean the Print Head and Platen, then remove any further dust or foreign substances.
6. Load the media and ribbon again, and close the Ribbon Access Cover and the Top Cover.

APPENDIX 1 SPECIFICATIONS

Appendix 1 describes the printer specifications and supplies for use on the B-SV4T printer.

A1.1 Printer

The following are the printer specifications.

Item	Specifications
Supply voltage	AC100 to 240V, 50/60 Hz
Power consumption	
During a print job	100 to 120V: 2.1 A, 49.0 W maximum, 200 to 240V: 2.1 A, 49.9 W maximum
During standby	100 to 120V: 0.13 A, 4.0 W maximum, 200 to 240V: 0.16 A, 3.8 W maximum
Power supply	100 to 240V universal switching power supply
Operating temperature range	5°C to 40°C (40°F to 104°F)
Storage temperature range	-40°C to 60°C
Relative humidity	25% to 85% RH (no condensation)
Humidity for storage	10% to 90% RH (no condensation)
Ventilation for storage	Free air environment
Resolution	203 dpi
Printing method	Thermal transfer and Direct thermal
Issue mode	Batch, Strip (option), Cut (option)
Printing speed	
In the batch/cut mode	50.8 mm/sec. (2"/sec.), 76.2 mm/sec. (3"/sec.), 101.6 mm/sec. (4"/sec.), 127 mm/sec. (5"/sec.)
In the strip mode	50.8 mm/sec. (2"/sec.), 76.2 mm/sec. (3"/sec.)
Available media width (including backing paper)	25.4 mm (1.0") to 112 mm (4.4")
Effective print width (max.)	108.0 mm (4.3")
Dimension (W × D × H)	213.0 mm × 314.0 mm × 188.0 mm (8.4" × 12.4" × 7.4")
Weight	2.8 kg (6.2 lb) (Excluding media and ribbon)
Available bar code types	EAN8, EAN13, EAN128, EAN and UPC 2(5) digital add-on, UPC-A, UPC-E, MSI, Interleaved 2 of 5, CODE39, CODE39C, CODE93, CODE128UCC, CODE128 Subsets A.B.C, CODE11, CODABAR, POSTNET, PLESSEY, Reduced Space Symbology
Available two-dimensional code	Data Matrix, PDF417, QR code, Maxi Code, Micro PDF417
Available bar code font	Times Roman (14 point), Helvetica (12 point), Presentation (18 point), Letter Gothic (9.5 pint), Courier (10 point), Prestige Elite (7 point), Outline font (1 type)
Rotations	0°, 90°, 180°, 270°
Standard interface	Serial interface (RS-232C) Parallel interface (Centronics) USB (V1.1)
Optional interface	LAN Adapter

NOTES:

- *Data Matrix™* is a trademark of International Data Matrix Inc., U.S.
- *PDF417™* is a trademark of Symbol Technologies Inc., US.
- *QR Code* is a trademark of DENSO CORPORATION.
- *Maxi Code* is a trademark of United Parcel Service of America, Inc., U.S.

A1.2 Options

Option Name	Type	Description
Keyboard display unit	KB-75-QM-R	This module is an external intelligent keyboard display unit.
Cutter module	B-SV204-QM-R B-SV404-QM-R	A cutter unit that makes stub cuts. A cutter unit that makes normal cuts.
Strip module	B-SV404-H-QM-R	When attached to the front of the Media Outlet, this sensor allows the on-demand strip issue by detecting the presence or lack of a label.
Memory module	B-SV704-E1M-QM-R (1MB) B-SV704-E2M-QM-R (2MB) B-SV704-E3M-QM-R (3MB) B-SV704-E4M-QM-R (4MB) B-SV704-E6M-QM-R (6MB) B-SV704-E8M-QM-R (8MB)	A flash ROM memory PC board
External media roll hanger	B-SV904-PH-QM-R	When this option is attached to the printer, a media roll with an outer roll diameter exceeding 127 mm (5") can be used.
LAN adapter	B-SV704-LAN-QQ-R (For AC100 to 120V) B-SV704-LAN-QP-R (For AC200 to 240V)	This option enables the printer to be used in a LAN network.

NOTE:

The above options are available from your nearest TOSHIBA TEC representative or TOSHIBA TEC Head Quarters.

A1.3 Media

Please make sure that the media to be used is approved by TOSHIBA TEC. The warranties do not apply to problems caused by using media that is not approved by TOSHIBA TEC.

For information regarding TOSHIBA TEC-approved media, please contact a TOSHIBA TEC authorised representative.

A1.3.1 Media Type

The table below shows the size and shape of the media that can be used on this printer.

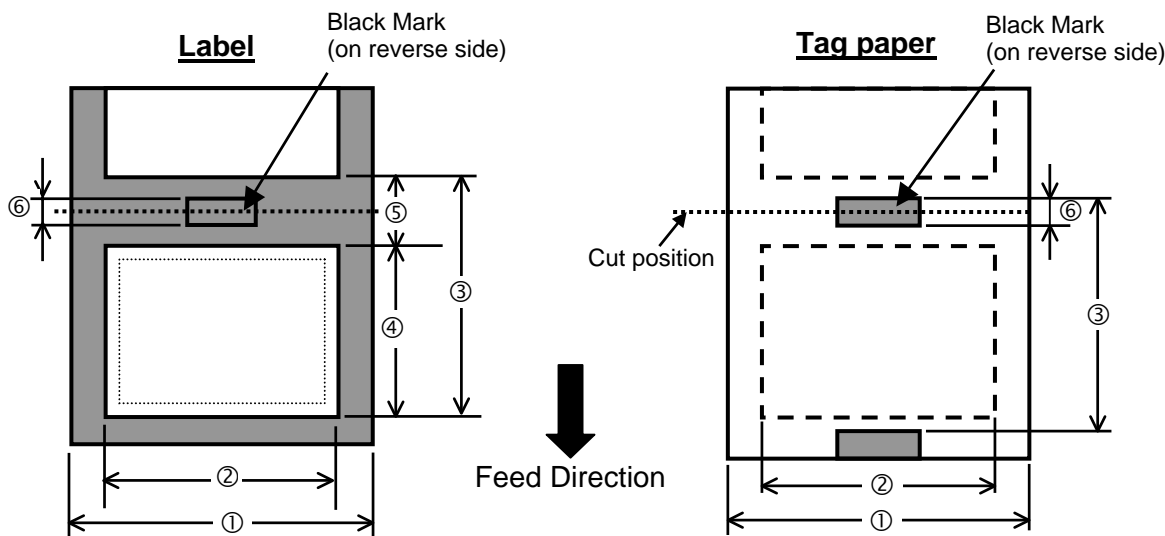

A1.3.1 Media Type (Cont.)

Unit: mm (inch)

Issue mode		Batch mode	Strip mode	Cut mode
① Width including backing paper		20 to 112 (0.8 to 4.4)		
② Media width		17 to 109 (0.7 to 4.3)		
③ Media pitch	Label	12 to 609.6 (0.5 to 24.0)	27.4 to 154.4 (1.1 to 6.1)	27.4 to 609.6 (1.1 to 24.0)
	Tag	10 to 609.6 (0.4 to 24.0)	-----	25.4 to 609.6 (1.1 to 24.0)
④ Media length		10 to 607.6 (0.4 to 23.9)	25.4 to 152.4 (1.1 to 6.0)	25.4 to 607.6 (1.1 to 23.9)
⑤ Gap length		Min. 2 (0.08)		Min. 6 (0.2)
⑥ Black mark length		Min. 2 (0.08)		
Thickness		0.06 to 0.19 (0.002 to 0.007)		
Max. outer roll diameter		Ø127 (5) Ø214 (8.4): When the optional External Media Roll Hanger is used.		
Roll direction		Outside		
Inner core diameter		25.4, 38.1, or 76.2 (1, 1.5, or 3) ^(See NOTE 2.)		

NOTES:

1. To ensure print quality and print head life use only TOSHIBA TEC approved media.
2. When using a media roll of 76.2-mm (3") inner core diameter, the 3"-Diameter Media Shaft included in the optional External Media Roll Hanger is required.

A1.3.2 Detection Area of the Transmissive Sensor

The Transmissive Sensor is positioned at 6 mm from the right edge of media.
The Transmissive Sensor detects a gap between labels, as illustrated below.

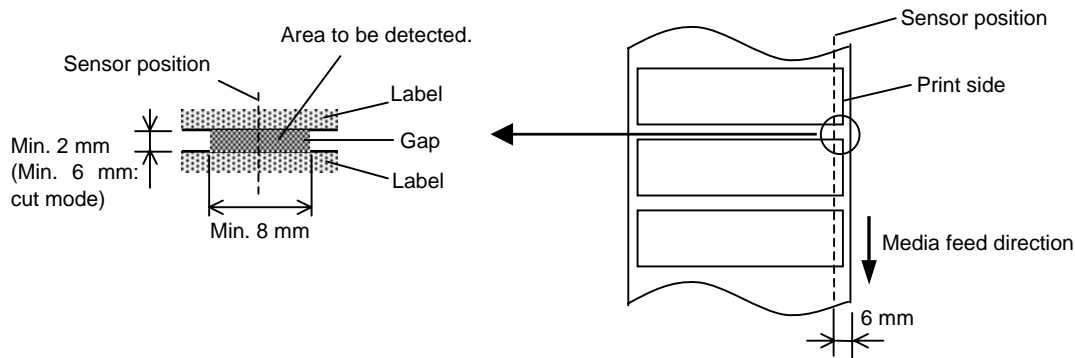

A1.3.3 Detection Area of the Reflective Sensor

The Reflective Sensor is movable within the full range of the media width.
 The reflection factor of the Black Mark must be 10% or lower with a waveform length of 950 nm.
 The Reflective Sensor should be aligned with the centre of the Black Mark.

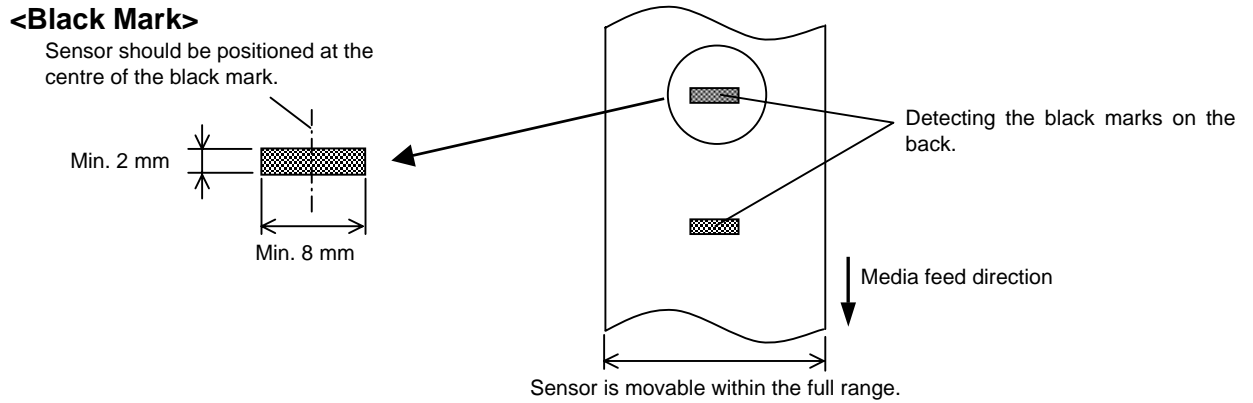

Rectangular holes or oval holes are also acceptable only if they are positioned at the centre of the media. In that case, nothing must be printed on the reverse side of the media.

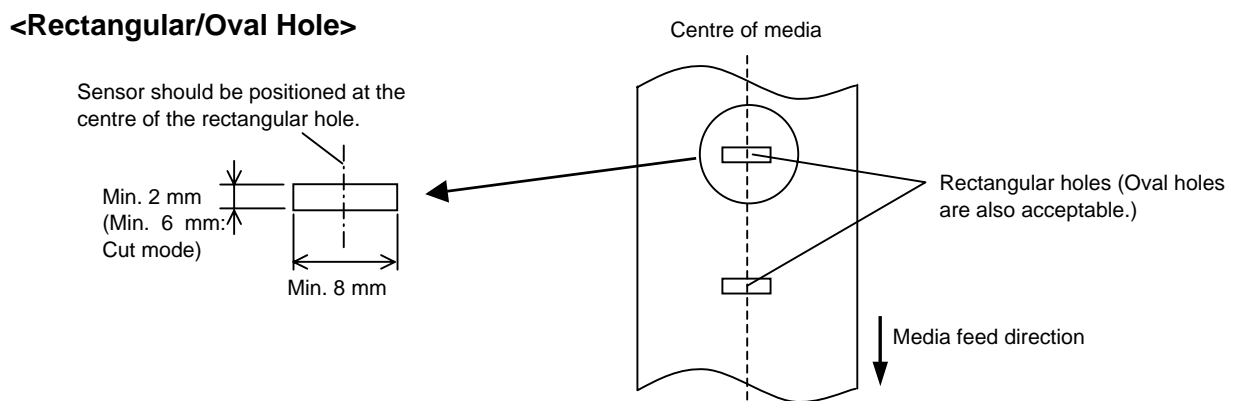

A1.3.4 Effective Print Area

The figure below illustrates the relation between the head effective print width and media width.

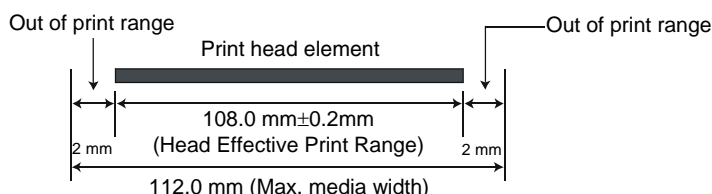

The figure below shows the effective print area on the media.

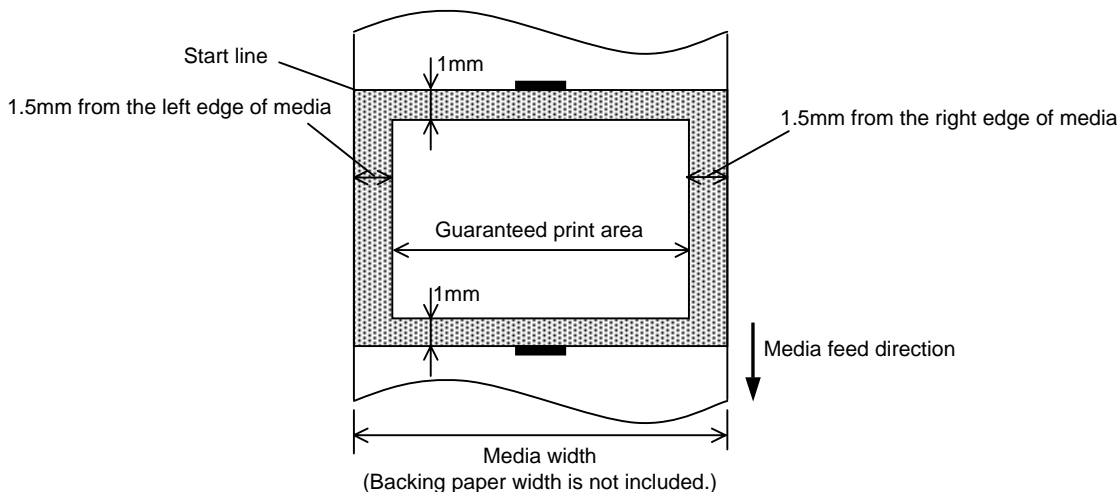

NOTES:

1. Be sure not to print on the 1.5-mm wide area from the media edges (shaded area in the above figure).
2. The centre of media should be positioned at the centre of the print head.
3. Print quality is not guaranteed within 3 mm from the print head stop position (including 1-mm slow-up.)
4. Average print (black) rate should be 15% or less. For bar code print area, the print rate should be 30% or less.
5. Line weight should be 3 to 12 dots.

A1.4 Ribbon

Please make sure that the ribbon being used is approved by TOSHIBA TEC. The warranty does not apply to any problem caused by using non-approved ribbons.

For information regarding TOSHIBA TEC approved ribbon, please contact a TOSHIBA TEC service representative.

Type	Spool type
Width	40 mm to 110 mm
Length	Depends on its thickness and outside diameter of core.
Max. outside diameter	Ø67 mm
Outside diameter of core	25.7 ± 0.3 mm
Roll direction	Outside
End tape	Polyester film (transparent) or silver film (opaque) 250 ± 5 mm long

NOTES:

1. To ensure print quality and print head life use only TOSHIBA TEC specified ribbons.
2. Too much difference in width between media and ribbon may cause ribbon wrinkles. To avoid ribbon wrinkles use a ribbon for proper media width shown in the above table. Do not use a ribbon that is narrower than media.
3. When discarding ribbons, please follow the local rule.

APPENDIX 2 INTERFACE

■ Interface Cables

To prevent radiation and reception of electrical noise, the interface cables must meet the following requirements:

- Fully shielded and fitted with metal or metallized connector housings.
- Keep as short as possible.
- Should not be bundled tightly with power cords.
- Should not be tied to power line conduits.

■ RS-232C Cable description

The serial data cable used to connect the printer to a host computer should be one of the following two types (9-pin or 25-pin connector):

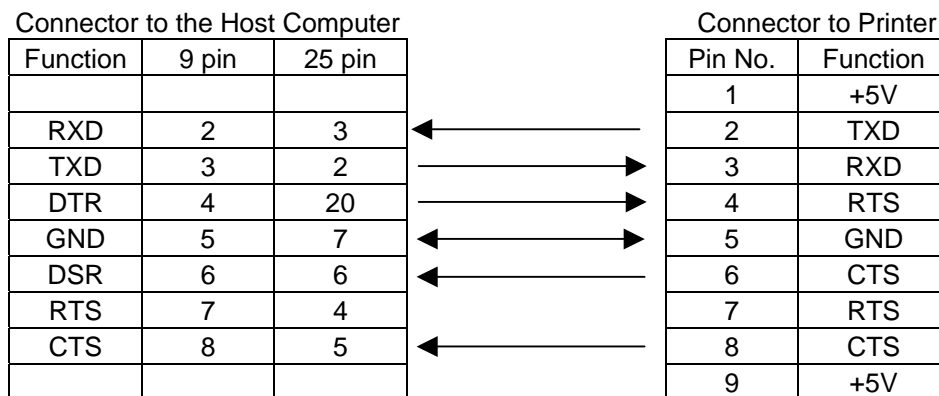

NOTE:
Use an RS-232C cable with a connector with inch type securing screws.

GLOSSARIES

Bar code

A code which represents alphanumeric characters by using a series of black and white stripes in different widths. Bar codes are used in various industrial fields: Manufacturing, Hospitals, Libraries, Retail, Transportation, Warehousing, etc. Reading bar codes is a fast and accurate means of capturing data while keyboard entry tends to be slow and inaccurate.

Batch mode

Issue mode that continuously prints media until the required number has been printed.

Black mark

A mark printed on the media enabling the printer to detect the correct start position of the media, helping to maintain constant print position.

Black mark sensor

A reflective sensor that detects the difference between a black mark and the print area to find the print start position.

Cut mode

Printer mode of operation where an (optional) cutter module is installed to automatically cut media from the supply roll after they are printed. The print command can specify to cut every media or to cut after a set number of media have been printed.

Direct thermal printing

A printing method using no ribbon, but thermal media which reacts to heat. The thermal print head heats the thermal media directly, causing print image to be printed on the media.

DPI

Dots Per Inch

A unit used to express print density or resolution.

Feed gap sensor

A transmissive sensor that detects the difference between the gap between labels and the label itself, to find the print start position of the label.

Font

A complete set of alphanumeric characters in one style of type. E.g. Helvetica, Courier, Times

Gap

Distance from the bottom of one label to the top of the next label.

IPS

Inch per second

A unit used to express print speed.

Label

A type of media with adhesive backing supplied on a backing paper.

Media

Material on which images are printed by the printer. Label, tag paper, fanfold paper, perforated paper, etc.

Printer driver

A software program that will convert the application program's printing request into the language that the printer understands.

Print head element

The thermal print head consists of a single line of tiny resistive elements which when current is allowed to flow through them it heats up causing a small dot to be burned onto thermal paper or a small dot of ink to be transferred from a thermal ribbon to ordinary paper.

Printing speed

The speed at which printing occurs. This speed is expressed in units of IPS (inches per second).

Resolution

The degree of detail to which an image can be duplicated. The minimum unit of divided image is called a pixel. As the resolution becomes higher, the number of pixels increases, resulting in a more detailed image.

Ribbon

An inked film used to transfer an image onto the media. In the thermal transfer printing, it is heated by the thermal print head, causing an image to be transferred onto the media.

Strip mode

One of the printer modes of operation where an optional strip module is installed to separate printed labels from the backing paper one by one.

Supply

Media and ribbon

Tag

A type of media having no adhesive backing but black marks to indicate the print area. Usually tags are made of cardboard or other durable material.

Thermal print head

A print head using thermal transfer or thermal direct printing method.

Thermal transfer printing

A printing method that the thermal print head heats an ink or resin coating on the ribbon against the media, causing the ink/resin to transfer onto the media.

INDEX

B

Backing paper 2-10, A1-3
Bar code A1-1
Batch mode 2-6
Black mark 2-9, 2-15, A1-2, A1-4
Black mark length A1-3
Black mark sensor 1-4, 2-8, 2-9, 2-15, 3-2

C

Centronics 1-3, 2-2, 2-3, A1-1
Cover open sensor 1-4
Cut mode 2-11, A1-1, A1-3
Cutter module A1-2

D

Dimensions 1-3, A1-1
Direct thermal A1-1

E

Effective print range A1-5
External media roll hanger 2-7, 2-12, A1-2, A1-3

F

Feed gap sensor 1-4, 2-9, 2-15, 3-2
FEED/PAUSE button 1-3, 1-4, 2-15, 4-1

G

Gap between labels A1-3
Gap length A1-3
Guaranteed print area A1-5

I

Indicator lamp 1-3, 1-4, 2-2, 2-15, 4-1
Interface 2-3, A1-1, A2-1
Issue mode 2-9, A1-1

J

Jammed media 4-1

K

Keyboard display unit A1-2

L

Label 2-10, A1-2
LAN A1-1
LAN adapter A1-2

M

Media 2-7, 3-3, A1-2
Media guide 1-4, 2-8, 2-9
Media holder 1-1, 2-7
Media length A1-3
Media pitch A1-3
Media sensor 2-9, 2-15
Media shaft 1-1, 2-7, 2-8
Media width A1-3

P

Parallel interface 1-3, 2-3, A1-1
Parallel port 2-3
Platen 1-4, 2-8, 2-10, 3-2
Power adapter 1-1, 2-4
Power consumption A1-1
Power cord 1-2, 2-4
Power jack 1-3, 2-3, 2-4
Power switch 1-3, 2-2, 2-3
Printer driver 2-2
Print head 1-4, 2-14, 3-1
Print head cleaner 3-1
Print head element 2-5, 2-7, 2-13, 3-1
Printing method A1-1
Printing speed A1-1

R

Rear media guide 1-3, 2-12
Resolution A1-1
Ribbon 2-13, 3-3, 4-1, A1-5
Ribbon access cover 1-3, 1-4, 2-13
Ribbon sensor 1-4, 3-2
Ribbon spindle 1-1, 2-13
Rotations A1-1
RS-232C 1-3, 2-2, 2-3, A1-1, A2-1

S

Serial interface 1-3, 2-3, A1-1

Strip mode 2-10, A1-3

Supply voltage A1-1

T

Tag paper A1-2

Thermal transfer A1-1

Top cover support 1-4, 2-5, 2-6

3"-diameter media shaft 2-12, A1-3

Two-dimensional code A1-1

U

USB interface 1-3, 2-3, A1-1

W

Weight A1-1



Free Manuals Download Website

<http://myh66.com>

<http://usermanuals.us>

<http://www.somanuals.com>

<http://www.4manuals.cc>

<http://www.manual-lib.com>

<http://www.404manual.com>

<http://www.luxmanual.com>

<http://aubethermostatmanual.com>

Golf course search by state

<http://golfingnear.com>

Email search by domain

<http://emailbydomain.com>

Auto manuals search

<http://auto.somanuals.com>

TV manuals search

<http://tv.somanuals.com>