

TOSHIBA

TOSHIBA POS Terminal

ST-7000C SERIES

Owner's Manual



CE Compliance (for EU only)

This product complies with the requirements of EMC and Low Voltage Directives including their amendments.

WARNING

This is a Class A product. In a domestic environment this product may cause radio interference in which case the user may be required to take adequate measures.

Warnung

Dies ist ein Klasse A Produkt. In einer örtlichen Umgebung kann dieses Gerät Funkstörungen verursachen.

ATTENTION

Ce produit est de classe A. Dans un environnement domestique, il peut causer des interférences radio. Auquel cas, l'utilisateur sera amené à prendre les mesures adéquates.

Atención

Este es un producto de la clase A. En ambientes domésticos éste producto puede causar radio interferencias en cuyo caso el usuario deberá tomar las medidas oportunas.

VERWITTIGING

Dit is een klasse A produkt. Het gebruik hiervan kan radio interferenties veroorzaken die de gebruiker ertoe kunnen dwigen sommige maatregelen te moeten treffen.

Avviso

Questo è un apparecchio di Classe A. In un ambiente residenziale questo apparecchio può provocare radiodisturbi. In questo caso può essere richiesto all'utilizzatore di prendere misure adeguate.

Schallemission: unter 70dB (A) nach DIN 45635 (ISO7779)

FCC Notice

This equipment has been tested and found to comply with the limits for a Class A digital device, pursuant to Part 15 of the FCC Rules. These limits are designed to provide reasonable protection against harmful interference when the equipment is operated in a commercial environment. This equipment generates, uses, and can radiate radio frequency energy and, if not installed and used in accordance with the instruction manual, may cause harmful interference to radio communications. Operation of this equipment in a residential area is likely to cause harmful interference in which case the user will be required to correct the interference at this own expense.

Changes or modifications not expressly approved by manufacturer for compliance could void the user's authority to operate the equipment.

Microsoft and Windows are registered trademarks of Microsoft Corporation.
Celeron is a registered trademark of Intel Corporation.

English

Waste Recycling information for users:

Following information is only for EU-member states:

The crossed out wheeled bin symbol is used to indicate that the product must not be treated as general household waste. By ensuring that this product is disposed of correctly you will be helping to prevent potentially negative consequences for the environment and human health, which could otherwise be caused by incorrect waste handling of this product. For more detailed information about the take-back and recycling of this equipment, please contact the supplier that provided you with the product in question.



French

Information aux utilisateurs concernant le recyclage des déchets:

Les informations suivantes sont uniquement destinées aux pays membres de l'Union Européenne:

L'utilisation du symbole de "poubelle à roulettes barrée" indique que ce produit ne doit pas être traité comme un déchet ménager classique.

En vous assurant que ce produit est correctement mis au rebut, vous participerez à la prévention de l'environnement et de la santé publique, contre des conséquences négatives potentielles qui pourraient résulter d'un traitement inapproprié des déchets de ce produit. Pour obtenir des informations complémentaires concernant la récupération et le recyclage de ce produit, veuillez contacter le fournisseur auprès duquel vous avez acheté le produit.

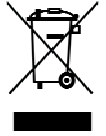

German

Wiederverwertungsinformationen für Verbraucher:

Die folgenden Informationen gelten nur für EU-Mitgliedsstaaten:

Das durchgestrichene Mülltonnensymbol weist darauf hin, dass dieses Produkt nicht wie allgemeiner Haushaltsmüll behandelt werden darf.

Indem Sie aktiv mitwirken, dieses Produkt ordnungsgemäß zu entsorgen, helfen Sie mit, mögliche negative Auswirkungen auf die Umwelt sowie die menschliche Gesundheit zu vermeiden, die sonst durch die unsachgemäße Entsorgung dieses Produktes beeinträchtigt werden könnten.

Für nähere Informationen zur Rücknahme und Wiederverwertung dieses Produktes wenden sie sich bitte an den Lieferanten, von dem Sie dieses Produkt erworben haben.



Spanish

Información para usuarios sobre el reciclaje de residuos:

La siguiente información sólo concierne a los Estados Miembros de la UE:

El uso del símbolo de un contenedor con ruedas tachado indica que este producto no puede ser tratado como si fuera un residuo doméstico.

Asegurando que nos deshacemos de este producto de forma correcta, ayudaremos a evitar potenciales consecuencias negativas tanto para el medio ambiente como para la salud pública, que podrían producirse debido a un tratamiento inapropiado de este producto. Para obtener una información más detallada sobre la recogida y reciclaje de su producto, por favor, póngase en contacto con el proveedor donde lo compró.



Dutch

Gebruikersinformatie over het recycleren van afval:

De volgende informatie geldt enkel in EU-lidstaten:

Het symbool met de doorkruiste afvalbak geeft aan dat dit product niet mag worden behandeld als algemeen huishoudelijk afval.

Door dit product op de juiste manier van de hand te doen beschermt u het milieu en de volksgezondheid tegen mogelijke negatieve gevolgen, die anders zouden kunnen voortvloeien uit het onjuist verwerken van de resten van dit product. Voor gedetailleerde informatie over het terugnemen en recycleren van dit product, gelieve contact op te nemen met de leverancier van dit product.



Italian

Informazioni sul riciclo del prodotto:

Le seguenti informazioni riguardano gli stati membri EU:

Il simbolo con il bidone sbarrato indica il non poter smaltire questo prodotto come rifiuto domestico.

L'accertamento che questo prodotto sia smaltito correttamente contribuirà ad impedire le potenziali conseguenze negative per l'ambiente e la salute umana che potrebbero essere causati, al contrario, dall'errato smaltimento dello stesso. Per informazioni più dettagliate sulle modalità di resa e riciclaggio di questo prodotto mettetevi in contatto con il fornitore da cui l'avete acquistato.



Portuguese

Informação sobre reciclagem:

A informação que se segue é apenas dirigida a países membros da CEE:

A utilização deste símbolo indica que este produto não pode ser tratado como lixo comum.

Ao assegurar-se que este produto é tratado correctamente está a ajudar a prevenir potenciais consequências negativas para o ambiente e para a saúde humana, que poderiam ser causadas pelo inapropriado tratamento deste produto. Para mais informação sobre a reciclagem e tratamento deste produto, contacte o seu fornecedor.



Safety Summary

Personal safety in handling or maintaining the equipment is extremely important. Warnings and Cautions necessary for safe handling are included in this manual. All warnings and cautions contained in this manual should be read and understood before handling or maintaining the equipment.

Do not attempt to effect repairs or modifications to this equipment. If a fault occurs that cannot be rectified using the procedures described in this manual, turn off the power, unplug the machine, then contact your authorized TOSHIBA TEC representative for assistance.

Meanings of Each Symbol



This symbol indicates warning items (including cautions). Specific warning contents are drawn inside the Δ symbol. (The symbol on the left indicates a general caution.)



This symbol indicates prohibited actions (prohibited items). Specific prohibited contents are drawn inside or near the \odot symbol. (The symbol on the left indicates “no disassembling”.)



This symbol indicates actions which must be performed. Specific instructions are drawn inside or near the symbol. (The symbol on the left indicates “disconnect the power cord plug from the outlet”.)



WARNING

This indicates that there is the risk of **death** or **serious injury** if the machines are improperly handled contrary to this indication.



Prohibited

Do not plug in or unplug the power cord plug with wet hands as this may cause **electric shock**.



Any other than the specified AC voltage is prohibited.

Do not use voltages other than the voltage (AC) specified on the rating plate, as this may cause **fire** or **electric shock**.

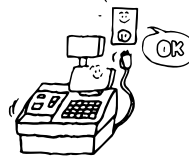

Prohibited

If the machines share the same outlet with any other electrical appliances that consume large amounts of power, the voltage will fluctuate widely each time these appliances operate. Be sure to provide an exclusive outlet for the machine as this may cause **fire** or **electric shock**.

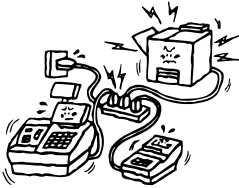

Prohibited

Do not place metal objects or water-filled containers such as flower vases, flower pots or mugs, etc. on top of the machines. If metal objects or spilled liquid enter the machines, this may cause **fire** or **electric shock**.



Prohibited

Do not insert or drop metal, flammable or other foreign objects into the machines through the ventilation slits, as this may cause **fire** or **electric shock**.



Prohibited

Do not scratch, damage or modify the power cords. Also, do not place heavy objects on, pull on, or excessively bend the cords, as this may cause **fire** or **electric shock**.



Disconnect the plug.



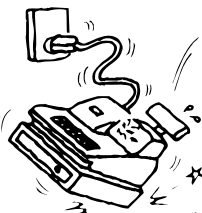



If the machines are dropped or their cabinets damaged, first turn off the power switches and disconnect the power cord plugs from the outlet, and then contact your authorized TOSHIBA TEC representative for assistance. Continued use of the machine in that condition may cause **fire** or **electric shock**.



Disconnect the plug.

Continued use of the machines in an abnormal condition such as when the machines are producing smoke or strange smells may cause **fire** or **electric shock**. In these cases, immediately turn off the power switches and disconnect the power cord plugs from the outlet. Then, contact your authorized TOSHIBA TEC representative for assistance.

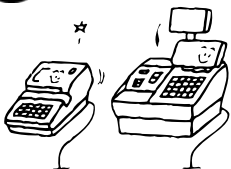

 <p>Disconnect the plug.</p> 	<p>If foreign objects (metal fragments, water, liquids) enter the machines, first turn off the power switches and disconnect the power cord plugs from the outlet, and then contact your authorized TOSHIBA TEC representative for assistance. Continued use of the machine in that condition may cause fire or electric shock.</p>	 <p>Disconnect the plug.</p> 	<p>When unplugging the power cords, be sure to hold and pull on the plug portion. Pulling on the cord portion may cut or expose the internal wires and cause fire or electric shock.</p>
 <p>Connect a grounding wire.</p> 	<p>Ensure that the equipment is properly grounded. Extension cables should also be grounded. Fire or electric shock could occur on improperly grounded equipment.</p>	 <p>No disassembling.</p> 	<p>Do not remove covers, repair or modify the machine by yourself. You may be injured by high voltage, very hot parts or sharp edges inside the machine. Unauthorized modification is prohibited.</p>



CAUTION

This indicates that there is the risk of personal **Injury** or **damage** to objects if the machines are improperly handled contrary to this indication.

Precautions

The following precautions will help to ensure that this machine will continue to function correctly.

Try to avoid locations that have the following adverse conditions:

- * Temperatures out of the specification
- * Direct sunlight
- * High humidity
- * Shared power source
- * Excessive vibration
- * Dust/Gas

Do not subject the machine to sudden shocks.

Do not press the keys too hard. Keys will operate correctly if they are touched lightly.

Clean the cover and keyboard, etc. by wiping with a dry cloth or a cloth soaked with detergent and wrung out thoroughly. Never use thinner or other volatile solvent for cleaning.

At the end of the day, turn the power OFF, then clean and inspect the exterior of the machine.

Try to avoid using this equipment on the same power supply as high voltage equipment or equipment likely to cause mains interference.

USE ONLY TOSHIBA TEC SPECIFIED consumables.

DO NOT STORE the consumables where they might be exposed to direct sunlight, high temperatures, high humidity, dust, or gas.

When moving the machine, take hold of the drawer and lift the machine.

Do not place heavy objects on top of the machines, as these items may become unbalanced and fall causing **injury**.

Do not block the ventilation slits of the machines, as this will cause heat to build up inside the machines and may cause **fire**.

Do not lean against the machine. It may fall on you and could cause **injury**.

Place the machine on a stable and level surface.

Request Regarding Maintenance

Utilize our maintenance services.

After purchasing the machine, contact your authorized TOSHIBA TEC representative for assistance once a year to have the inside of the machine cleaned. Otherwise, dust will build up inside the machines and may cause a **fire** or a **malfunction**. Cleaning is particularly effective before humid rainy seasons.

Our preventive maintenance service performs the periodic checks and other work required to maintain the quality and performance of the machines, preventing accidents beforehand.

For details, please consult your authorized TOSHIBA TEC representative for assistance.

Using insecticides and other chemicals

Do not expose the machines to insecticides or other volatile solvents. This will cause the cabinet or other parts to deteriorate or cause the paint to peel.

TABLE OF CONTENTS

	Page
1. INTRODUCTION -----	1- 1
1.1 Accessories-----	1- 1
2. APPEARANCE -----	2- 1
3. CONNECTORS -----	3- 1
4. INSTALLATION PROCEDURE -----	4- 1
4.1 Environment for Installation-----	4- 1
4.2 Attaching the Cable Cover-----	4- 1
5. HOW TO LOCK/UNLOCK THE FRONT PANEL -----	5- 1
6. GENERAL MAINTENANCE -----	6- 1
6.1 Cleaning-----	6- 1
7. TROUBLESHOOTING -----	7- 1
8. SPECIFICATIONS -----	8- 1
8.1 Basic Specifications-----	8- 1
8.2 Options-----	8- 2

CAUTION!

1. *This manual may not be copied in whole or in part without prior written permission of TOSHIBA TEC.*
2. *The contents of this manual may be changed without notification.*
3. *Please refer to your local Authorised Service representative with regard to any queries you may have in this manual.*

1. INTRODUCTION

Thank you for choosing the TOSHIBA POS Terminal. This POS Terminal contains all the high performance register function necessary for a POS Terminal and enables the user oriented system configuration. By adopting a high-speed CPU, Memory with large capacity, this POS Terminal flexibly accepts the modification corresponding to the future system environment as the user expects. This manual describes the functions and handling of this POS terminal and should be read carefully to help gain maximum performance and life from your POS terminal. For most queries please refer to this manual and keep it safe for future reference.

1.1 Accessories

Confirm that all the following accessories are contained in the carton. If any accessories are missing or damaged, contact your TOSHIBA TEC service representative.

Cable Cover (1 pc.)

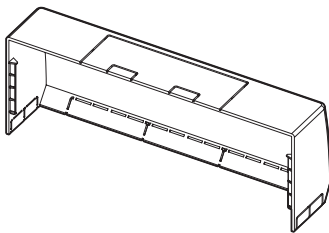

Front Panel Key (2 pcs.)



Cable Clamp (2 pcs.)
(Used to secure the USB Cable, etc.
to the POS terminal)

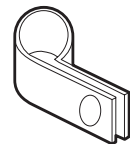

Ferrite Core (2 pcs.)
(For the Drawer Cable)

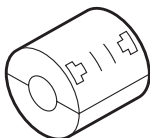

Ferrite Core (1 pc.)
(For the Audio Cable)

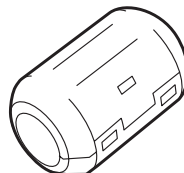

Ferrite Core (2 pcs.)
(For the TFT Monitor Cable)

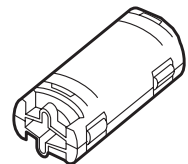

Bind Unify Screw
N0.6x4.5 (8 pcs.)
(Used to secure the HDDs)



Double Sems Screw
M-3x8 (2 pcs.)
(Used to secure the Cable Clamp)



NOTE: The power cord is not included in the carton. Please prepare it separately from a local dealer.

2. APPEARANCE

< Front View >

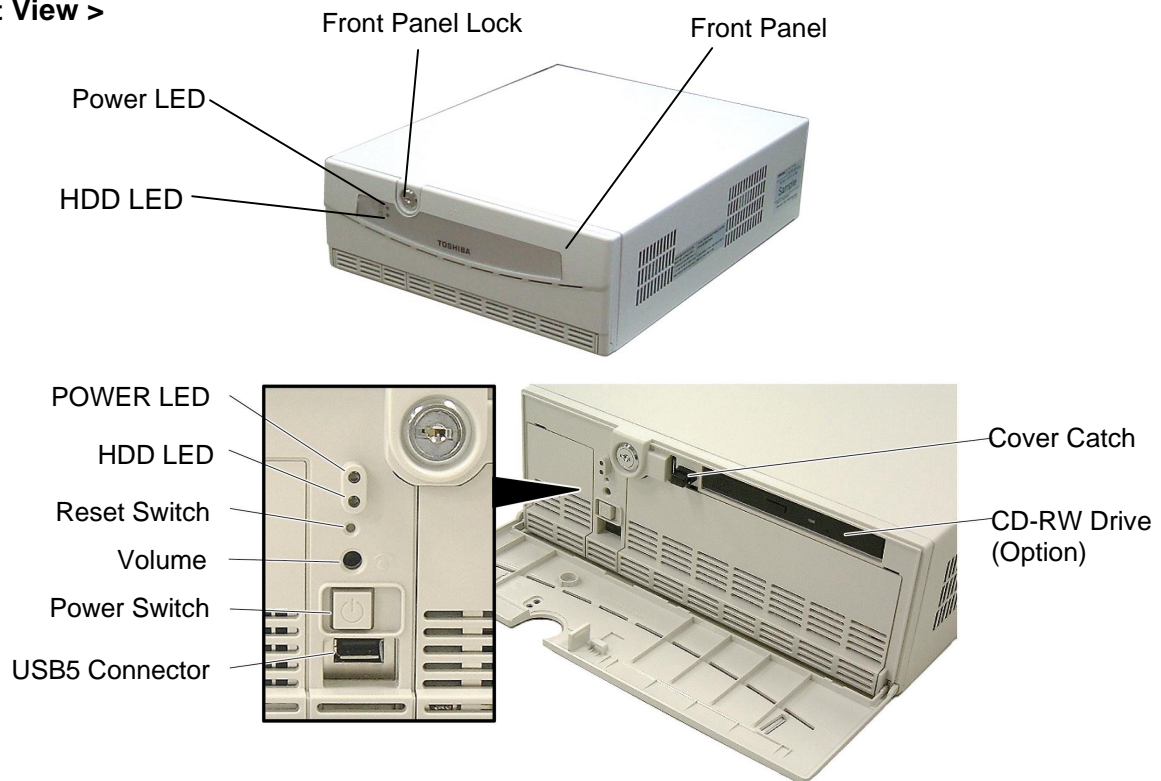

- (1) Power Switch
This is the switch to turn the power of the POS terminal ON or OFF. The Power LED is illuminated when turning the power on.
- (2) Power LED (Green)
This is the LED to indicate the power ON/OFF status of the POS terminal. Green LED is illuminated when turning the power ON.
- (3) HDD LED (Yellow)
This is the LED for a model with the Hard Disk Drive installed. Yellow LED is illuminated during the access to the Hard Disk Drive.
- (4) Front Panel Lock
This is the lock of the front panel. To lock the front panel, insert the front panel key to the front panel lock, then turn it clockwise. To unlock the front panel, turn the front panel key counterclockwise.
- (5) Reset Switch
Pressing this switch when the POS terminal hangs up resets the unit.

CAUTION!

Do not press the Reset Switch unnecessarily. Doing so may cause an error.

- (6) Volume
Used to adjust the internal speaker volume.
When it is turned to left, the sound volume turns down.
When it is turned to right, the sound volume turns up.
- (7) USB5 Connector
Connector for the USB (Universal Serial Bus) interface conforming to USB V2.0/1.1. A USB Mouse, USB keyboard, etc. can be connected to this connector.

3. CONNECTORS

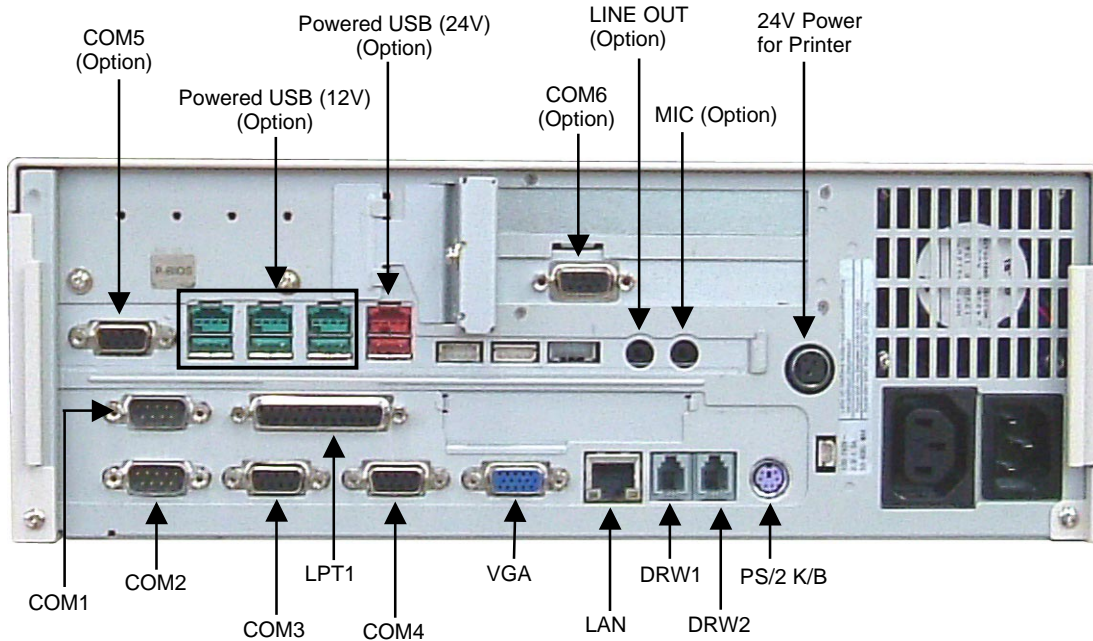

Connector	Description
AC Inlet	A connector for the AC inlet
AC Outlet	A connector to supply AC power to the CRT. AC power is output in synchronization with the ON/OFF status of the POS terminal.
P24V DC Outlet	A terminal of a DC24V line to which the power cable of the Receipt/Journal printer is connected.
PS/2 (Keyboard)	Mini-DIN 6-pin female type connector. Connector for the PS/2 type keyboard.
USB0, 1, 2, 3 (Powered USB) (Option)	Connector for the USB (Universal Serial Bus) interface USB V2.0/1.1 and UHCI (conforming to Universal Hub Controller Interface V2.0/1.1) NOTE: USB functions may not be supported depending on the Operating System. USB0 to USB3 are powered USB sockets, which are 3 ports of 12V USB (USB0 to USB2) and 1 port of 24V USB (USB3). The lower part of these sockets can be used as general 5V USB connectors.
LAN	Modular type connector for the 10BASE-T/100BASE-TX LAN interface
DRW1, DRW2	A 24V type drawer is connectable.
VGA	A 15-pin VGA connector to the CRT
COM1, 2	D-sub 9-pin male type connector (without power supply) A slot scanner, modem, serial Interface type scale, EFT, etc. are connectable.
COM3, 4, 5, 6 (COM5, 6: Option)	D-sub 9-pin female type connector (with +5V, +12V output) A line display unit or RS-232C type hand scanner is connectable. NOTES: 1 COM6 cannot be used when the touch panel TFT is connected to the POS terminal. 2. COM6 is available only when the optional kit is installed.
LPT1	D-sub 25-pin female connector Printer, etc. having a Centronics interface or equivalent are connectable.
Line-out (Option)	Used for connecting an external speaker via the stereo mini jack terminal
Mic-in (Option)	Used for connecting a monophonic microphone via the mono mini jack terminal

*: COM6 is installed on the PCI slot.

4. INSTALLATION PROCEDURE

4.1 Environment for Installation

1. Provide a space of minimum 80 mm to the left, right, front, rear, and top of the main unit for proper cooling. (The main unit has air vents on the front, rear, right and left, and a fan. Spaces should be provided to prevent the air vents in the main unit from being closed and the air flow from being obstructed.)
2. Attaching the cable cover:
The cable cover must be attached to protect the interface cables or connectors. Be sure to turn off the power before connecting or disconnecting the cables.
3. Notes on installing the display unit on the top of the enclosure:
When installing the display unit on the top of the enclosure, the following conditions must be satisfied. (Except for the standard display unit)
 - 1) Display unit weighing 12Kg or under
 - 2) The base of the display unit has no projections that might damage the enclosure.
 - 3) The base of the display unit does not protrude beyond the steel plate at the top of the main unit.

4.2 Attaching the Cable Cover

1. Insert the guides on both sides of the cable cover into the slits provided on the POS terminal, then slide down the cable cover to the bottom.

NOTE: Be sure to attach the cable cover for protecting the cables.

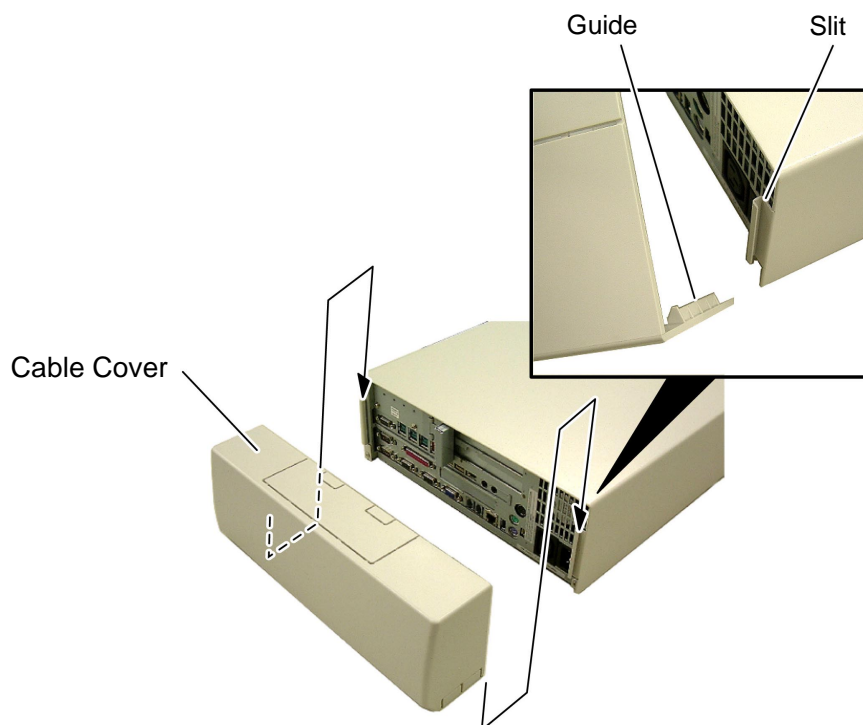

2. When detaching the cable cover, hold both sides by hands, then pull it up.

5. HOW TO LOCK/UNLOCK THE FRONT PANEL

<< How to unlock the front panel >>

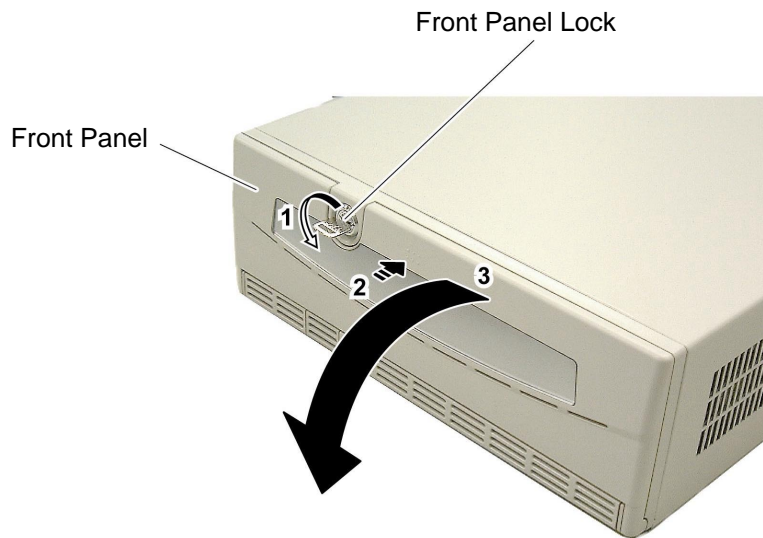

1. Insert the front panel key into the front panel lock, and turn it counterclockwise to unlock the front panel.
2. Push the upper center of the front panel until it clicks.
3. Gently open the front panel holding it by hand.

<< How to lock the front panel >>

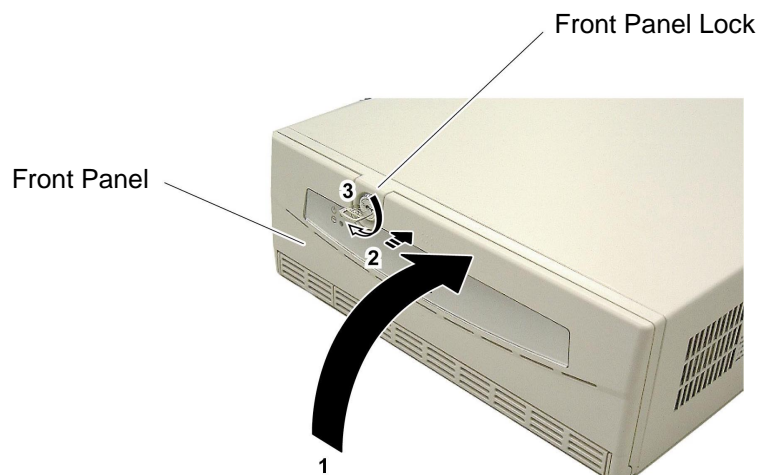

1. Gently close the front panel.
2. Push the upper center of the front panel until it clicks.
3. Turn the front panel key clockwise to lock the front panel.

6. GENERAL MAINTENANCE

6.1 Cleaning

WARNING!

1. *Be sure to disconnect the power cord prior to performing any maintenance.*
2. *Do not pour water directly on the POS Terminal or wipe it with a soaked cloth, as this may cause fire, electric shock, or machine failure.*

CAUTION!

Never use an organic solvent like thinners or benzene for cleaning. Using such solvents may discolor the covers.

To help retain the high quality and performance of your POS Terminal, it should be cleaned regularly. The greater the usage on the POS Terminal, the more frequent the cleaning. (i.e. low usage = weekly: high usage = daily)

- **Cleaning the Covers**

Wipe the covers with a soft dry cloth or soft cloth slightly moistened with mild detergent. After using detergent for cleaning, be sure to wipe it off with a slightly moistened cloth.

7. TROUBLESHOOTING

WARNING!

If you cannot solve a problem with the following solutions, do not attempt to repair it by yourself. Turn the power off, unplug the POS Terminal, then contact the nearest TOSHIBA TEC service representative for assistance.

Symptom	Check point	Solution
The power does not turn on.	<ul style="list-style-type: none"> • Is the power cord plugged in correctly? • Is the power supplied to the AC outlet? • Has the circuit breaker blown? 	<ul style="list-style-type: none"> • Plug in correctly. • If it is not a power failure, check for the power supply to the AC outlet with another electric appliance. When the power is not supplied, contact your nearest power company. • Check the circuit breaker.

8. SPECIFICATIONS

8.1 Basic Specifications

Item		Description
Input voltage		AC 100V-240V +10%, -10% 50/60Hz 4.8A-2.3A
DC output voltage		DC24V +5%, -5%
AC output voltage		AC 100V-240V +10%, -10% 50/60Hz 2.0A-1.0A
Operating temperature		5°C to 35°C
Relative humidity		10% to 80%RH (no condensation)
Dimensions		315 mm (W) x 466 mm (D) x 112.5 mm (including the rubber feed and cable cover)
Weight		9.5 Kg (without 2 HDDs, CD, UPS battery, PCI, and packing materials)
Power cord		A power cord is not included in this product. Please use one complied with each country's safety standard. For details, please contact the nearest TOSHIBA TEC service representative.
CPU		Intel Celeron® 1.2 GHz with 256 KB secondary cache
BIOS ROM		1MB Flash ROM
RAM	Capacity	Standard 128MB (Max. 2GB) Max. 1GB/slot can be equipped.
	Type	DDR SDRAM PC2100, 2.5V unbuffered type, non ECC 184-pin DDR SDRAM DIMM connector, 2 slots installed
Interface		RS-232C x 4, Parallel x 1, USB x 1, Drawer x 2 (24V type), PS/2 x 1, PCI (Half size slot) x 2, +24V OUT (DIN 3-pin) x 1
Display interface		RGB x 1 channel (on-board, standard)
Hard Disk Drive (HDD)		Max. 2 units of 3.5-inch HDD (option) can be connected.
CD-RW drive		1 drive (local purchase is required), CD connection kit required (option)
LAN interface		10 BASE-T, 100 BASE-TX (Wake on LAN support)
Floppy Disk Drive (FDD)		USB interface type (local purchase is required.)
Support OS		Windows 2000, Windows XP, DOS

8.2 Options

Option name	Type	Description					
Drawer unit	DRWST-51A-4MV-QM DRWST-51A-8MV-QM	24V-drive standard drawer Size and Weight: 460(W) x 400(D) x 115(H) mm, 10Kg Money Case Type: MC4,8					
	DRWST-56-EMV-QM	24V-drive flip top drawer Size and Weight: 460(W) x 170(D) x 100(H) mm, 6Kg Money Case Type: EURO case					
	Drawer type	Type	Bill holder	Coin tray	Mini coin case	CDC	Remarks
		4MV-QM	5	5	No	Yes	With media slot
8MV-QM		4	6	1	Yes	With media slot	
	EMV-QM	5	8	No	Yes	With media slot	
Line display unit	LIUST-51-1AF-QM	20 characters x 2 lines dot display					
Printer Unit	TRST-56-P-1W-QM	Parallel interface single thermal printer for 80 mm wide paper Cabinet color: FW-2					
	TRST-56-S-1W-QM	Serial interface single thermal printer for 80 mm wide paper Cabinet color: FW-2					
	TRJST-52-3S-QM	Serial interface 2-station thermal printer for 58-mm wide paper					
	TRJST-52-3P-QM	Parallel interface 2-station thermal printer for 58-mm wide paper					
POS keyboard unit	PKBST-50-3-QM	81 keys POS keyboard with PS/2 interface					
TFT monitor	TFTST-56T-3V-QM	12.1-inch TFT monitor equipped with the touch panel (with VGA board)					
Operation Unit	LKBST-65 TT11-QM	12.1-inch TFT monitor equipped with the 40 keys keyboard (The magnetic card reader is provided as an option.)					
Mounting kit	KIT-7000-COM-QM-R	COM6 connector kit for attaching the PCI slot					
	KIT-7000-CD-QM-R	Mounting kit for attaching the CD drive					
	KIT-7000-CBL-QM-R	COM relay cable kit for connecting the option TFT monitor (TFTST-56T) or the operation unit (LKBST-65) to the ST-7000.					
	KIT-7000-2COM-QM-R	Expansion I/O PC board that contains two COM ports and a powered USB port (24V).					
	KIT-7000-PUSB-QM-R	Expansion I/O PC board that contains two COM ports, four powered USB ports (12V x 3 and 24V x 1), a MICIN, and a LINEOUT.					

NOTE: Model name with an "R" attached to the end indicates that the product complies with RoHS directive.



Free Manuals Download Website

<http://myh66.com>

<http://usermanuals.us>

<http://www.somanuals.com>

<http://www.4manuals.cc>

<http://www.manual-lib.com>

<http://www.404manual.com>

<http://www.luxmanual.com>

<http://aubethermostatmanual.com>

Golf course search by state

<http://golfingnear.com>

Email search by domain

<http://emailbydomain.com>

Auto manuals search

<http://auto.somanuals.com>

TV manuals search

<http://tv.somanuals.com>