

TOSHIBA

**COMBINATION COLOR
TELEVISION AND VIDEO CASSETTE
RECORDER**

**MV13Q41
MV20Q41**

OWNER'S MANUAL

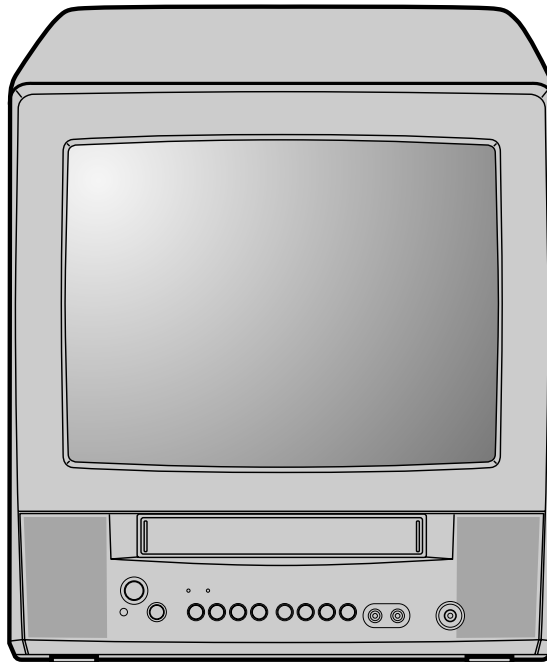

Illustration of MV13Q41

Introduction	2
Connections	11
Basic setup	13
TV operation	18
Playback	27
Recording	32
Others	37

©2005 Toshiba Corporation
Before operating the unit, please read this manual thoroughly.

IMPORTANT SAFEGUARDS



The lightning flash with arrowhead symbol, within an equilateral triangle is intended to alert the user to the presence of uninsulated dangerous voltage within the product's enclosure that may be of sufficient magnitude to constitute a risk of electric shock.



The exclamation point within an equilateral triangle is intended to alert the user to the presence of important operating and maintenance (servicing) instructions in the literature accompanying the appliance.

WARNING: TO PREVENT FIRE OR SHOCK HAZARD, DO NOT EXPOSE THIS APPLIANCE TO RAIN OR MOISTURE.

WARNING: This equipment has been tested and found to comply with the limits for a Class B digital device, pursuant to Part 15 of the FCC Rules. These limits are designed to provide reasonable protection against harmful interference in a residential installation. This equipment generates, uses and can radiate radio frequency energy and, if not installed and used in accordance with the instructions, may cause harmful interference to radio communications. However, there is no guarantee that interference will not occur in a particular installation. If this equipment does cause harmful interference to radio or television reception, which can be determined by turning the equipment off and on, the user is encouraged to try to correct the interference by one or more of the following measures:

- Reorient or relocate the receiving antenna.
- Increase the distance between the equipment and receiver.
- Connect the equipment into an outlet on a circuit different from that to which the receiver is connected.
- Consult the dealer or an experienced radio/TV technician for help.

CAUTION: Changes or modifications not expressly approved by the party responsible for compliance with the FCC (Federal Communications Commission) Rules could void the user's authority to operate this equipment.

COPYRIGHT: It is permissible to record television programs, films, video tapes and other material only in the event that third party copyrights and other rights are not violated.

1. READ INSTRUCTIONS

All the safety and operating instructions should be read before the unit is operated.

2. RETAIN INSTRUCTIONS

The safety and operating instructions should be retained for future reference.

3. HEED WARNINGS

All warnings on the unit and in the operating instructions should be adhered to.

4. FOLLOW INSTRUCTIONS

All operating and use instructions should be followed.

5. CLEANING

Unplug this unit from the wall outlet before cleaning. Do not use liquid cleaners or aerosol cleaners. Use a damp cloth for cleaning the exterior cabinet only.

6. ATTACHMENTS

The manufacturer of this unit does not make any recommendations for attachments, as they may cause hazards.

7. WATER AND MOISTURE

Do not use this unit near water. For example, near a bathtub, washbowl, kitchen sink, laundry tub, in a wet basement, or near a swimming pool.



8. ACCESSORIES

Do not place this unit on an unstable cart, stand, tripod, bracket, or table. The unit may fall, causing serious injury, and serious damage to the unit.

- 8A.** An appliance and cart combination should be moved with care. Quick stops, excessive force, and uneven surfaces may cause the appliance and cart combination to overturn.

9. VENTILATION

Slots and openings in the cabinet back or bottom are provided for ventilation, and to ensure reliable operation of the unit, and to protect it from overheating. These openings must not be blocked or covered. The openings should never be blocked by placing the unit on a bed, sofa, rug, or other similar surface. This unit should never be placed near or over a radiator or heat source. This unit should not be placed in a built-in installation such as a bookcase or rack unless proper ventilation is provided or the manufacturer's instructions have been adhered to.

10. POWER SOURCE

This unit should be operated only from the type of power source indicated on the rating plate. If you are not sure of the type of power supply to your home, consult your appliance dealer or local power company. For units intended to operate from battery power, or other sources, refer to the respective pages on this Owner's Manual for their operating instructions.

11. GROUNDING OR POLARIZATION

This unit is equipped with a polarized alternating-current line plug (a plug having one blade wider than the other). This plug will fit into the power outlet only one way. This is a safety feature. If you are unable to insert the plug fully into the outlet, try reversing the plug. If the plug should still fail to fit, contact your electrician to replace your obsolete outlet. Instead of the polarized alternating-current line plug, your unit may be equipped with a 3-wire grounding-type plug (a plug having a third (grounding) pin). This plug will only fit into a grounding-type power outlet. This too, is a safety feature. If you are unable to insert the plug into the outlet, contact your electrician to replace your obsolete outlet.

Do not defeat the safety purpose of the grounding-type plug.

12. POWER-CORD PROTECTION

Power-supply cords should be routed so that they are not likely to be walked on or pinched by items placed upon or against them, paying particular attention to cords at plugs, convenience receptacles, and the point where they exit from the appliance.

13. LIGHTNING

To protect your unit from a lightning storm, or when it is left unattended and unused for long periods of time, unplug it from the wall outlet and disconnect the antenna or cable system. This will prevent damage to the unit due to lightning and power line surges.

14. POWER LINES

An outside antenna system should not be located in the vicinity of overhead power lines or other electric light or power circuits, or where it can fall onto or against such power lines or circuits. When installing an outside antenna system, extreme care should be taken to keep from touching such power lines or circuits, as contact with them might be fatal.

15. OVERLOADING

Do not overload wall outlets and extension cords, as this can result in a risk of fire or electric shock.

16. OBJECT AND LIQUID ENTRY

Do not push objects through any openings in this unit, as they may touch dangerous voltage points or short out parts that could result in fire or electric shock. Never spill or spray any type of liquid into the unit.

17. OUTDOOR ANTENNA GROUNDING

If an outside antenna or cable system is connected to the unit, be sure the antenna or cable system is grounded to provide some protection against voltage surges and built-up static charges, Section 810 of the National Electrical Code (NEC), ANSI/NFPA 70, provides information with respect to proper grounding of the mast and supporting structure, grounding of the lead-in wire to an antenna discharge unit, size of grounding conductors, location of antenna discharge unit, connection to grounding electrodes, and requirements for the grounding electrode.

PORTABLE CART WARNING
(symbol provided by RETAC)



S3126A



IMPORTANT SAFEGUARDS

(Continued)

18. SERVICING

Do not attempt to service this unit yourself as opening or removing covers may expose you to dangerous voltage or other hazards. Refer all servicing to qualified service personnel.

For example:

- a. When the power-supply cord or plug is damaged.
- b. If liquid has been spilled, or objects have fallen into the unit.
- c. If the unit has been exposed to rain or water.
- d. If the unit does not operate normally by following the operating instructions. Adjust only those controls that are covered by the operating instructions, as an improper adjustment of other controls may result in damage and will often require extensive work by a qualified technician to restore the unit to its normal operation.
- e. If the unit has been dropped or the cabinet has been damaged.
- f. When the unit exhibits a distinct change in performance, this indicates a need for service.

19. REPLACEMENT PARTS

When replacement parts are required, be sure the service technician uses replacement parts specified by the manufacturer or those that have the same characteristics as the original part.

Unauthorized substitutions may result in fire, electric shock or other hazards.

20. SAFETY CHECK

Upon completion of any service or repairs to this unit, ask the service technician to perform safety checks to determine that the unit is in proper operating condition.

21. HEAT

The product should be situated away from heat sources such as radiators, heat registers, stoves, or other products (including amplifiers) that produce heat.

22. NOTE TO CABLE TV SYSTEM INSTALLER

This reminder is provided to call the Cable TV system installer's attention to Article 820-40 of the NEC that provides guidelines for proper grounding and, in particular, specifies that the cable ground shall be connected to the grounding system of the building, as close to the point of cable entry as practical.

EXAMPLE OF ANTENNA GROUNDING AS PER THE NATIONAL ELECTRICAL CODE

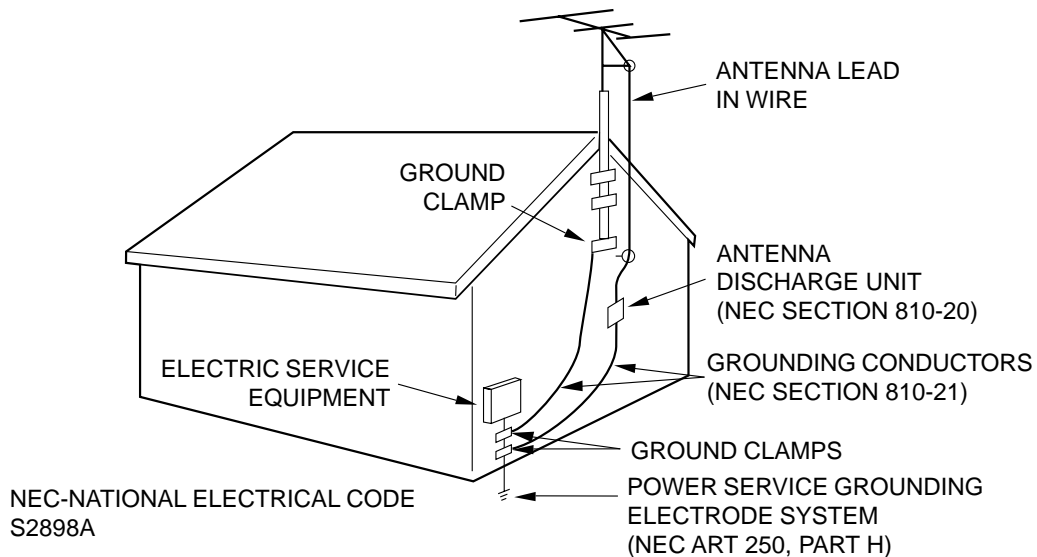

Power source

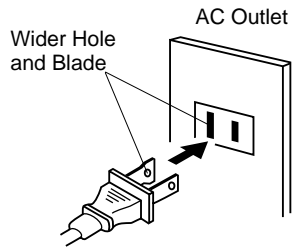

Polarized AC Cord Plug
(One blade is wider than the other.)

TO USE AC POWER SOURCE

Use the AC polarized line cord provided for operation on AC. Insert the AC cord plug into a standard 120V 60Hz polarized AC outlet.

Notes:

- Never connect the AC line cord plug to other than the specified voltage (120V 60Hz). Use the attached power cord only.
- If the polarized AC cord does not fit into a non-polarized AC outlet, do not attempt to file or cut the blade. It is the user's responsibility to have an electrician replace the obsolete outlet.
- If you cause a static discharge when touching the unit and the unit fails to function, simply unplug the unit from the AC outlet and plug it back in. The unit should return to normal operation.
- If the AC cord plug is plugged in for the first time, wait for approx. 5 seconds before pressing the POWER button.

IMPORTANT RECYCLING INFORMATION

This product uses both Cathode Ray Tube (CRT) and other components that contain lead. In your community there might be regulations that require you to dispose these materials properly under environmental considerations. Please contact your local authorities, or the Electronic Industries Alliance (<http://www.eiae.org>) for disposal or recycling information.

Precautions

Notes on handling

- When shipping the unit, the original shipping carton and packing materials come in handy. For maximum protection, repack the unit as it was originally packed at the factory.
- Do not use volatile liquids, such as insect spray, near the unit. Do not leave rubber or plastic products in contact with the unit for a long time. They will leave marks on the finish.
- The top and rear panels of the unit may become warm after a long period of use. This is not a malfunction.
- When the unit is not in use, be sure to remove the video cassette turn off the power.
- If you do not use the unit for a long period, the unit may not function properly in the future. Turn on and use the unit occasionally.

Notes on locating

- Place the unit on a level surface. Do not use it on a shaky or unstable surface such as a wobbling table or inclined stand. The loaded video tape may come off the proper position and cause damage to the unit.
- When you place this unit near a TV, radio, or VCR, the playback picture may become poor and the sound may be distorted. In this case, place the unit away from the TV, radio, or VCR.

Notes on cleaning

Use a soft, dry cloth for cleaning.

- For stubborn dirt, soak the cloth in a weak detergent solution, wring well and wipe. Use a dry cloth to wipe it dry.
Do not use any type of solvent, such as thinner and benzene, as they may damage the surface of the unit.
- If you use a chemical saturated cloth to clean the unit, follow that product's instructions.

To obtain a clear picture

The unit is a high technology, precision device. If the video head and the head drum are dirty or worn down, the picture quality becomes poor. To obtain a clear picture, we recommend regular inspection and maintenance (cleaning or parts replacement) every 1,000 hours of use depending on the operating environment. For details, contact your nearest dealer.

Notes on moisture condensation

Moisture condensation damages the unit. Please read the following carefully.

Moisture condensation occurs, for example, when you pour a cold drink into a glass on a warm day. Drops of water form on the outside of the glass. In the same way, moisture may condense on the head drum inside this unit, one of the most crucial internal parts of the unit.

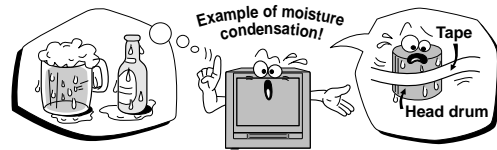

■ **Moisture condensation occurs during the following cases.**

- When you bring the unit directly from a cold place to a warm place.
- When you use the unit in a room where you just turned on the heater, or a place where the cold wind from the air conditioner directly hits the unit.
- In summer, when you use the unit in a hot and humid place just after you move the unit from an air conditioned room.
- When you use the unit in a humid place.

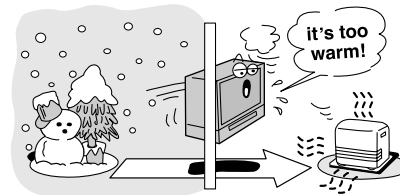

■ **Do not use the unit when moisture condensation may occur.**

If you use the unit in such a situation, it may damage tapes and internal parts. Remove the video tape, connect the power cord of the unit to the wall outlet, turn on the unit, and leave it for two or three hours. After two or three hours, the unit will have warmed up and evaporated any moisture. Keep the unit connected to the wall outlet and moisture condensation will seldom occur.

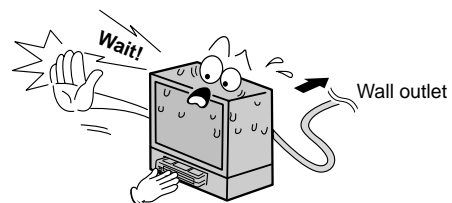

Contents

Introduction

IMPORTANT SAFEGUARDS	2
Power source	5
Precautions	6
Contents	7
Identification of controls	8

Others

Reception disturbances	37
Troubleshooting	38
Video head cleaning	39
Specifications	40
Limited warranty	41

Introduction

Connections

Antenna connections	11
Cable TV connections	12

Basic setup

Starting setup	13
Clock setting	14
Setting the language	17
TV/VCR operation status	17

TV operation

TV operation	18
Closed captions	20
To memorize channels	21
Setting the V-Chip	22
To set the on timer	24
To set the off timer	25
Picture control adjustment	26
Adjusting the picture preference	26

Playback

Loading and unloading a cassette tape	27
Cassette tape playback	28
Special playback	29
Convenient function	30

Recording

Recording a TV program	32
One-touch Timer Recording (OTR)	33
Timer recording	34
Duplicating a video tape	36

Identification of controls

See the page in for details.

Front panel

Illustration of MV13Q41

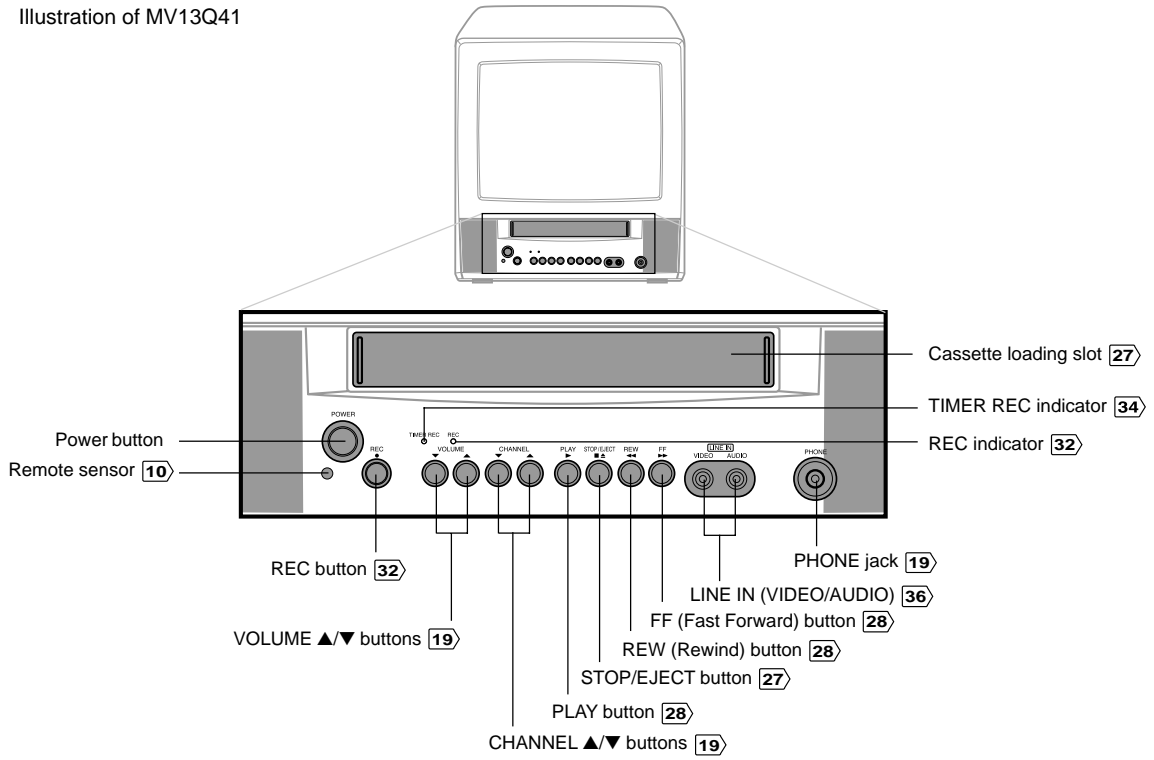

Rear panel

Illustration of MV13Q41

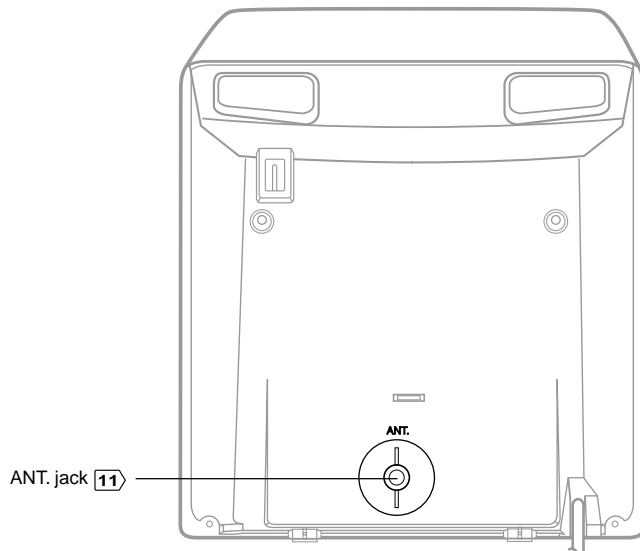

Remote control

The instructions in this manual describe the functions on the remote control. See the page in for details.

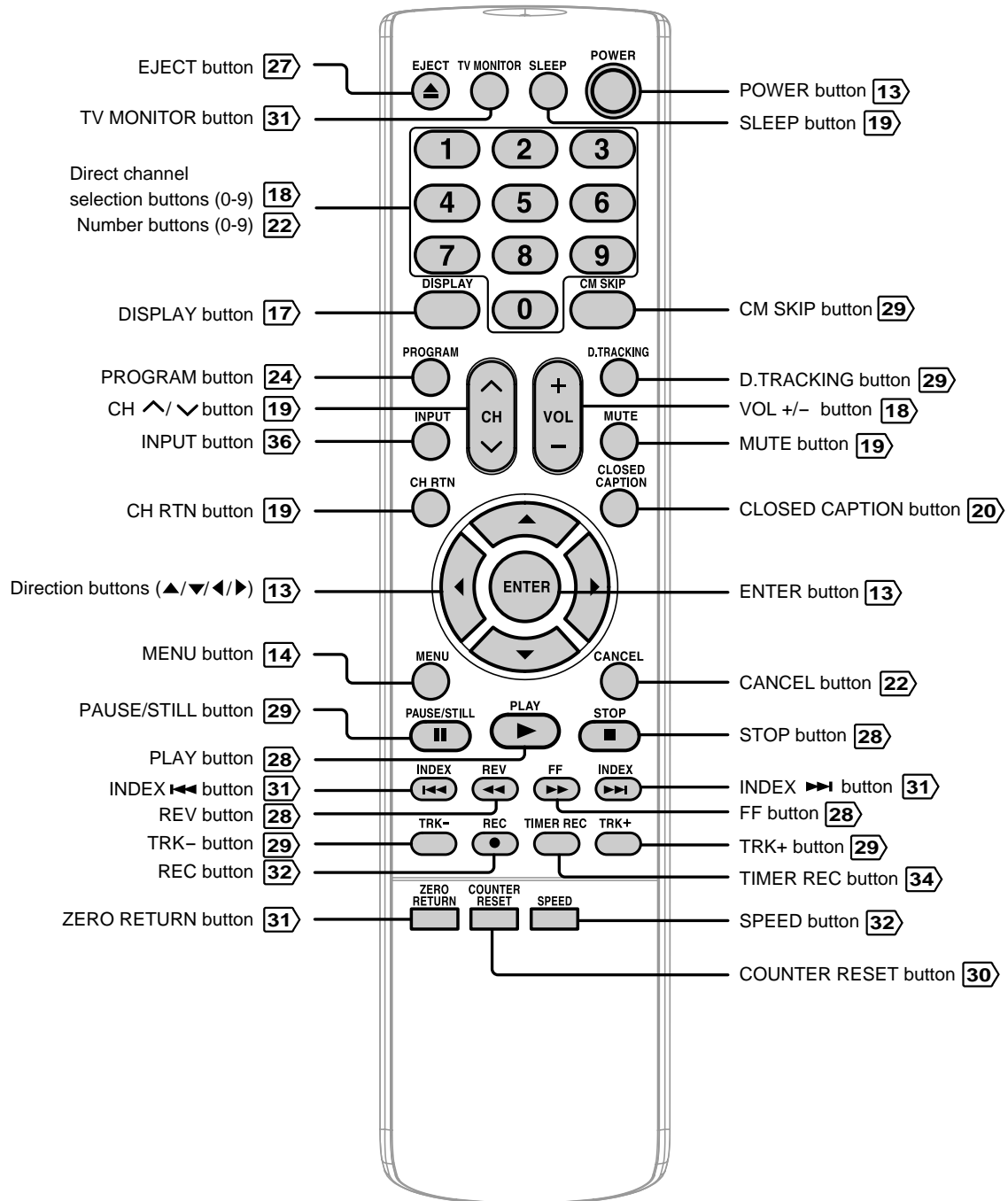

Identification of controls (continued)

Inserting batteries

- 1** Open the battery compartment cover in the direction of the arrow.

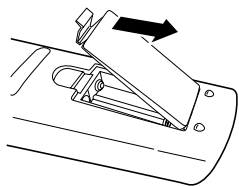

- 2** Install two "R03/AAA" batteries (supplied), paying attention to the polarity diagram in the battery compartment.

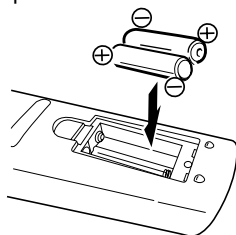

- 3** Replace the compartment cover.

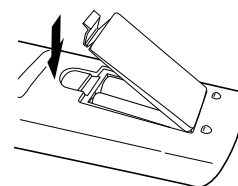

The precautions below should be followed when using batteries in this device:

1. Use only the size and type of batteries specified.
2. Be sure to follow the correct polarity when installing the batteries as indicated in the battery compartment. Reversed batteries may cause damage to the device. To avoid a potential short circuit, insert the "-" end first.
3. Do not mix different types of batteries together (e.g. Alkaline and Carbon-zinc) or old batteries with fresh ones.
4. If the device is not to be used for a long period of time, remove the batteries to prevent damage or injury from possible battery leakage.
5. Do not try to recharge batteries not intended to be recharged; they can overheat and rupture. (Follow battery manufacturer's directions.)

Remote control basics

- Press **POWER** to turn the unit on or off.
- Tap **CH** \wedge or \vee to move through the channels one channel at a time.
- The **Direction** buttons (\blacktriangle / \blacktriangledown / \blacktriangleleft / \blacktriangleright) are also used to navigate on-screen menu system.
- You can directly access specific channels using **Direct channel selection** buttons.

Operation:

- Aim the remote control at the remote sensor and press control buttons to operate.
- Operate the remote control within 30° angle on either side of the remote sensor, up to a distance of approx. 5 meters.

Illustration of MV13Q41

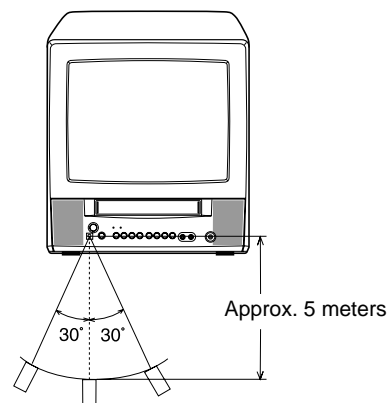

Antenna connections

If you are using an indoor or outdoor antenna, follow the instructions below that correspond to your antenna system. If you are using a cable TV service (CABLE), see page 12 for Cable TV connections.

Combination VHF/UHF antenna (Single 75 ohm cable or 300 ohm twin-lead wire)

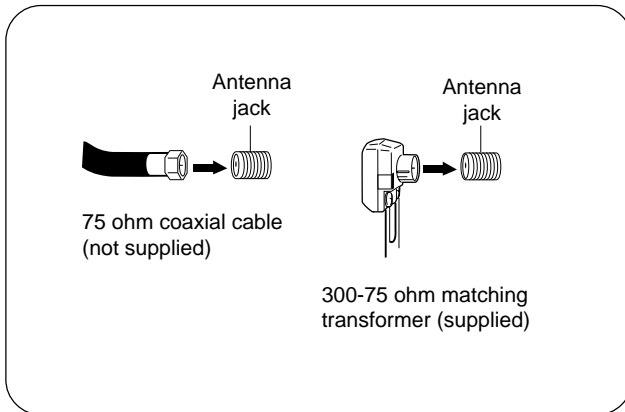

Connect the 75 ohm cable from the combination VHF/UHF antenna to the antenna jack.

If your combination VHF/UHF antenna has a 300 ohm twin-lead wire, the use of the 300-75 ohm matching transformer may be necessary.

Connections

Combination VHF/UHF antenna (Separate VHF and UHF 300 ohm twin-lead wires)

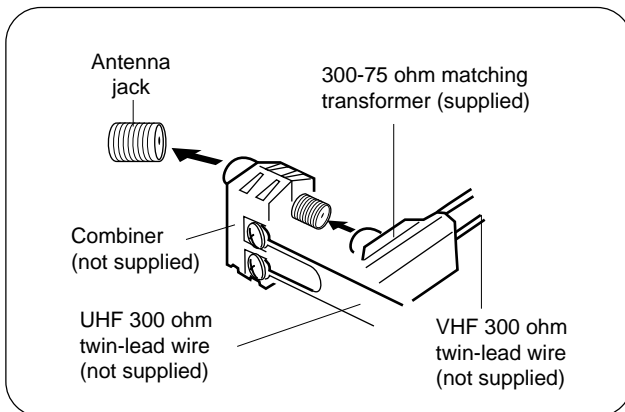

Connect the UHF 300 ohm twin-lead wire to the combiner (not supplied). Connect the VHF 300 ohm twin-lead wire to the 300-75 ohm matching transformer. Attach the transformer to the combiner, then attach the combiner to the antenna jack.

Separate VHF/UHF antennas (75 ohm VHF cable and 300 ohm UHF twin-lead wires)

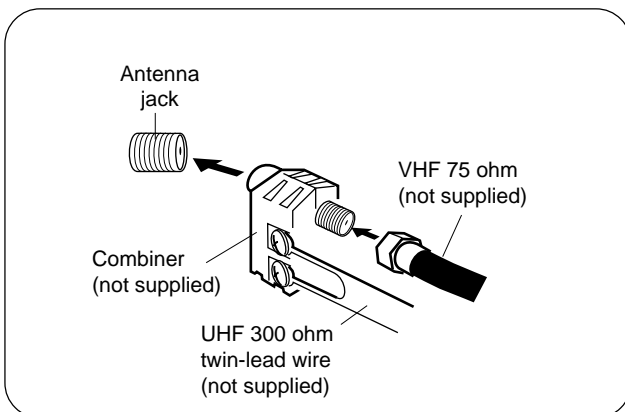

Connect the VHF 75 ohm cable and UHF 300 ohm twin-lead wire to the combiner (not supplied). Attach the combiner to the antenna jack.

Cable TV connections

This unit has an extended tuning range and can tune most cable channels without using a Cable TV converter box. Some cable companies offer "premium pay channels" in which the signal is scrambled. Descrambling these signals for normal viewing requires the use of a descrambler device which is generally provided by the cable company.

For subscribers to basic cable TV service

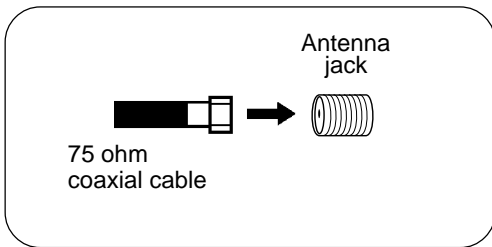

For basic cable service not requiring a converter/descrambler box, connect the Cable TV 75 ohm coaxial cable directly to the Antenna jack on the back of the unit.

For subscribers to scrambled cable TV service

If you subscribe to a cable TV service which requires the use of a converter/descrambler box, connect the incoming 75 ohm coaxial cable to the converter/descrambler box. Using another 75 ohm coaxial cable, connect the output jack of the converter/descrambler box to the antenna jack on the unit. Follow the connections shown below. Set the unit to the output channel of the converter/descrambler box (usually channel 3 or 4) and use the converter/descrambler box to select channels.

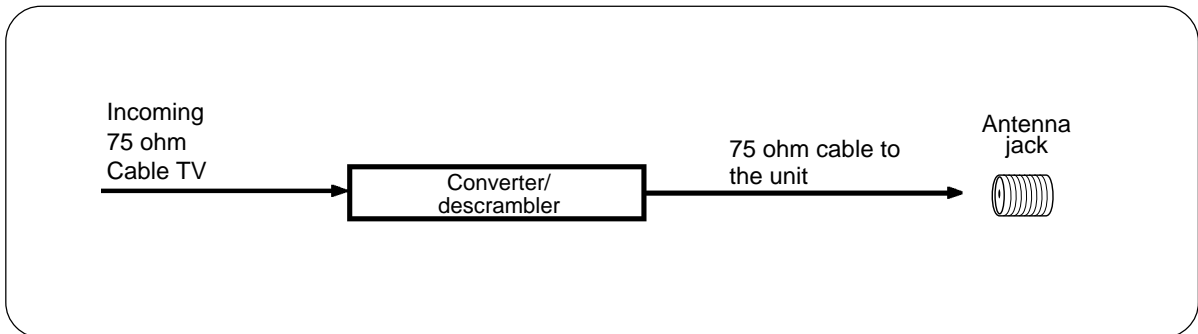

For subscribers to unscrambled basic cable TV service with scrambled premium channels

If you subscribe to a cable TV service in which basic channels are unscrambled and premium channels require the use of a converter/descrambler box, you may wish to use a signal splitter and an A/B Switch box (available from the cable company or an electronics supply store). Follow the connections shown below. With the switch in the "B" position, you can directly tune any unscrambled channels on your unit. With the switch in the "A" position, tune your unit to the output of the converter/descrambler box (usually channel 3 or 4) and use the converter/descrambler box to tune scrambled channels.

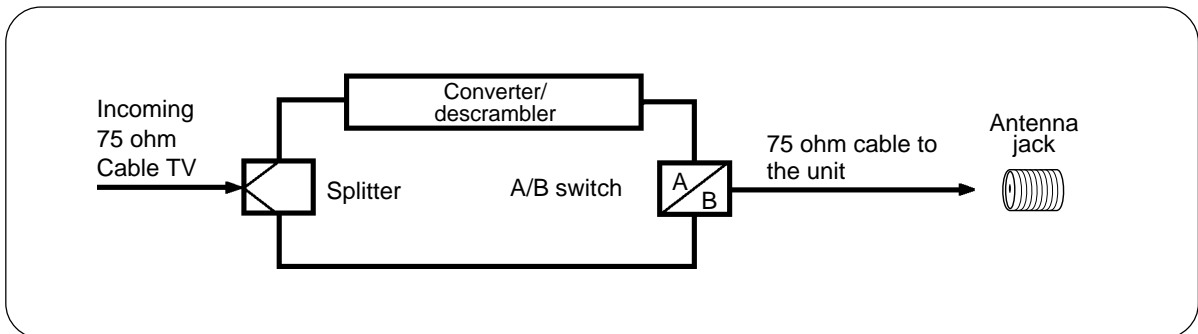

Starting setup

The STARTING SETUP function makes installing your unit easily. It leads you the Language selection, TV/CABLE selection and auto channel memory automatically.

IMPORTANT: Make sure that the antenna or cable TV system connection is made!

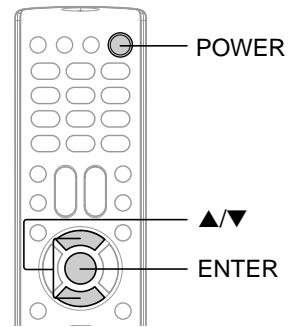

Starting setup

- 1** Press **POWER**.
The starting setup function begins and the Language setup menu appears on the screen. Press **▲** or **▼** to select your desired language, then press **ENTER**.

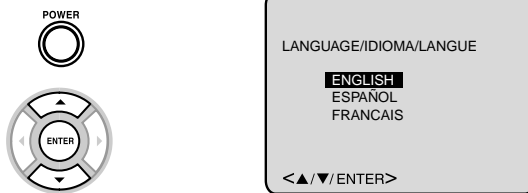

- 2** Press **▲** or **▼** to select "TV" or "CABLE", then press **ENTER**.

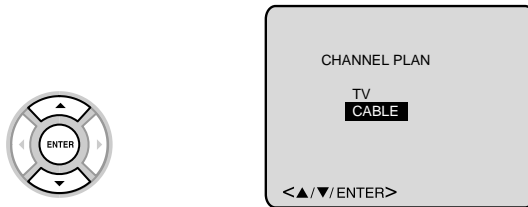

- 3** Press **▲** or **▼** to select "START", then press **ENTER**.
If you select "CANCEL" and press **ENTER**, the STARTING SETUP stops and changes to the TV screen.

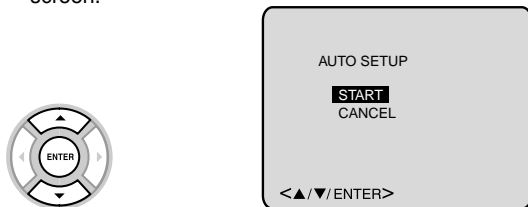

- 4** Now the "AUTO CH MEMORY" and "AUTO CLOCK" starts.
After the starting setup is completed, the TV channel appears on the screen.

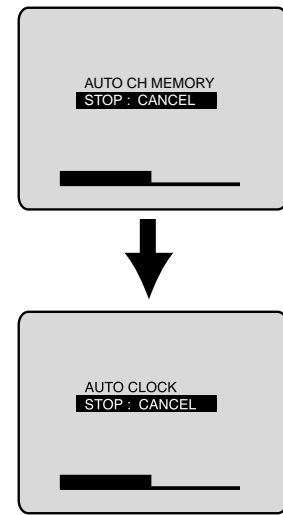

Notes:

- The starting setup function will work only when you press **POWER** for the first time.
- In "AUTO CLOCK" setting, it may take more than 10 minutes to read the EDS signal for one channel, which has only "Time of day" or "Local time zone".

Clock setting

The auto clock function will automatically set the built-in clock (Month, Day, Year and Time) when the unit is connected to an antenna or cable system and it is turned off. As the unit searches for a receivable station in your area and it receives a broadcast signal for auto clock, the auto clock needs several minutes to set itself.

Auto clock setting

Preparation:

- Connect the antenna or cable system.
- If you use a cable box, turn it on.
- Plug the AC power cord to the AC outlet.

- 1 Make sure the unit is turned off.**
 - If you press **POWER**, the Auto Clock set is not effective.

- 2 Wait at least three minutes and press POWER.**
 - Depending on the reception condition, it may take approx. thirty minutes.



- 3 Press DISPLAY to check the clock on the screen.**

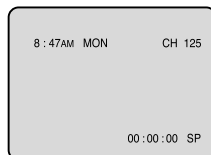

- 4 If the clock is not set, check the antenna condition. The auto clock may not function properly if the reception condition is not good.**

Auto clock adjustment

The auto clock adjustment will be performed at 12:00 PM everyday if you turn off the unit.

- If you use a cable box and you want auto clock adjustment to be performed, the cable box must be left on.
- The auto clock adjustment is not effective when there is a difference of more than 5 minutes exists between the built-in clock time and the actual time.

To set auto clock to OFF

When shipped from factory the AUTO CLOCK is set to "ON". But if you do not want auto clock set (Adjustment):

- 1 Press MENU, then press ◀ or ▶ to select option.**



- 2 Press ▲ or ▼ to select "AUTO CLOCK".**

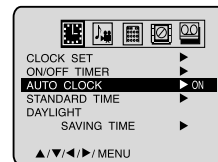

- 3 Press ◀ or ▶ to select "OFF".**

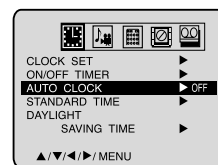

- 4 Press MENU repeatedly until the menu screen is cleared.**



- When the AUTO CLOCK is set to "OFF", the auto clock adjustment does not function.
- Set the clock manually .

Notes:

- **If the unit does not operate properly, or No key operation (by the unit and/or the remote control):** Static electricity, etc., may affect the player's operation. Disconnect the AC power cord once, then connect it again.
- If no buttons are pressed for more than 60 seconds, the menu screen will return to normal TV operation automatically.

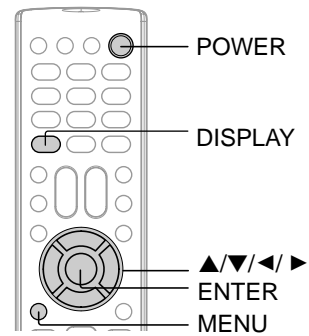

To set standard time

In the rare event that you live within broadcast range of two stations in two different time zones, the unit may recognize the wrong station for the auto clock set. To correct the situation:

- 1** Press MENU, then press ◀ or ▶ to select option.
- 2** Press ▲ or ▼ to select "STANDARD TIME", then press ▶.
- 3** Press ▲/▼/◀/▶ to select your time zone, then press ENTER.

ATLANTIC	: GMT-4hours
EASTERN	: GMT-5hours
CENTRAL	: GMT-6hours
MOUNTAIN	: GMT-7hours
PACIFIC	: GMT-8hours
ALASKA	: GMT-9hours
HAWAII	: GMT-10hours
AUTO	: AUTO SET

(GMT: Greenwich Mean Time)
- 4** Press MENU repeatedly until the menu screen is cleared.

Note:
To be able to select the standard time, the clock must first be set by "AUTO CLOCK" once.

To set daylight saving time

You can set the daylight saving time automatically or manually.

- 1** Press MENU, then press ◀ or ▶ to select option.
- 2** Press ▲ or ▼ to select "DAYLIGHT SAVING TIME", then press ▶.
- 3** Press ▲ or ▼ to select one of the options, then press ENTER.
- 4** Press MENU repeatedly until the menu screen is cleared.

Notes:

- When shipped from factory, the DAYLIGHT SAVING TIME is set to "AUTO" position.
- When the clock is not set, daylight saving time setting is not available.
- When there is no daylight saving time in your area, always select "OFF" position in step 3.

Clock setting (continued)

Manual clock setting

You must set the date and time manually for timer recordings, ON/OFF timer and daylight saving time if the auto clock process did not set them correctly.

EXAMPLE: Setting the clock to "8:30 AM", 26th. (SAT) March, 2005.

1 Press MENU, then press ◀ or ▶ to select option.

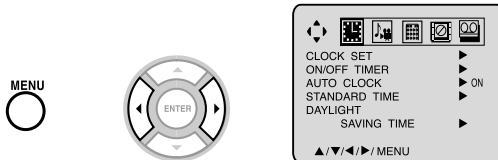

2 Press ▲ or ▼ to select "CLOCK SET", then press ▶.



3 Press ◀ or ▶ to set the month, then press ▼.



4 Set the day, year and time as in step 4, then press ENTER.

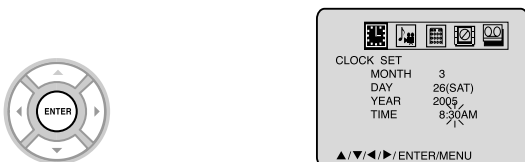

5 After setting the clock, date and time starts functioning automatically.



■ To make corrections any time during the process

Press ▲ or ▼ repeatedly until the item you want to change blinks, then set the item again.

Notes:

- After a power failure or disconnection of the power, the timer settings will be lost. In this case, reset the present time.
- When you set the minute, you can change in 10-minutes step by holding down ◀ or ▶.

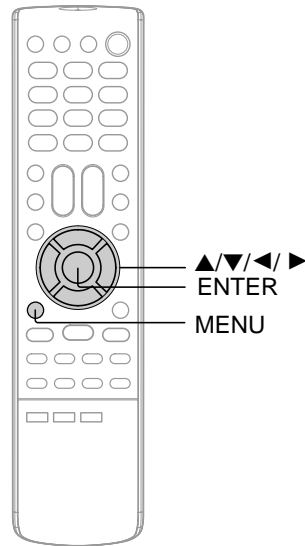

Setting the language/ TV/VCR operation status

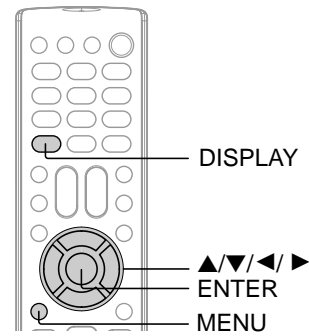

Setting the language

This unit can display the on screen language in English, Spanish or French.

1 Press **MENU**, then press **◀** or **▶** to select option.

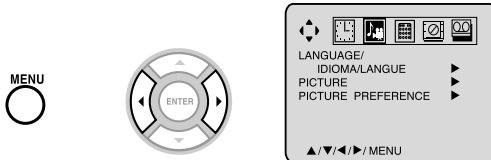

2 Press **▲** or **▼** to select "LANGUAGE/IDIOMA/LANGUE", then press **▶**.

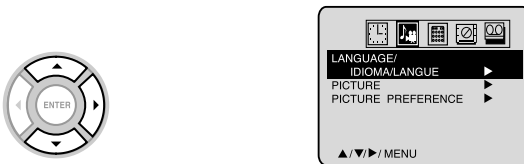

3 Press **▲** or **▼** to select the desired language: English (ENGLISH), Spanish (ESPAÑOL) or French (FRANCAIS), then press **ENTER**.

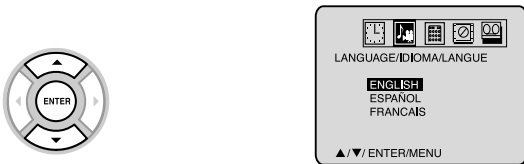

4 Press **MENU** repeatedly until the menu screen is cleared.



TV/VCR operation status

Press **DISPLAY** to display the information on the screen. To cancel the display, press **DISPLAY** again.

While watching TV

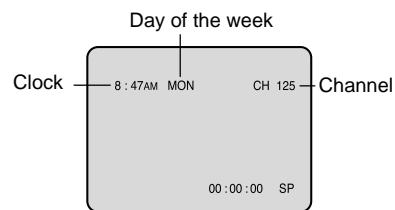

While operating a tape

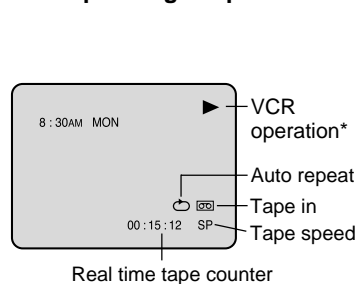

VCR operation*

- Recording : ●
- Rec/Pause : ||
- Play : ▶
- Fast-forward : ▶▶
- Rewind : ◀◀
- Stop : ■
- Eject : ▲

Basic setup

TV operation

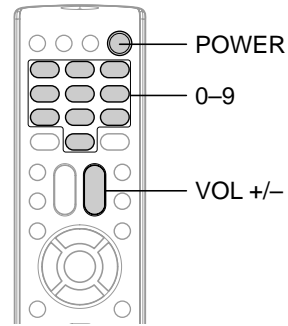

TV operation

1 To turn on the unit, press **POWER**.



2 Adjust the volume level by pressing **VOL +** or **-**. The volume level will be indicated on the screen by green bars. As the volume level increases, so do the number of bars. If the volume decreases, the number of green bars also decreases.

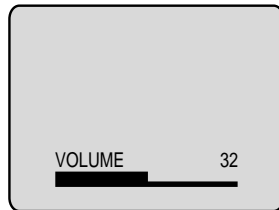
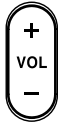

3 Set the **TV/CABLE** selection to the appropriate position **[21]**.

TV - VHF/UHF channels
CABLE - Cable TV channels

4 Press direct channel selection (**0-9**) to select the channel.

TV mode direct channel selection

When the TV/CABLE selection is in the TV position, all channels can be instantly selected by using two buttons. (for example, to select channel 2, press "0", then "2". If you press only "2", channel selection will be delayed for a few seconds.) For channels 10 and above, press the 2 digits in order.

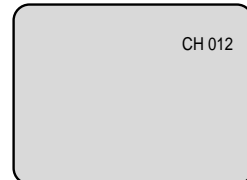

CABLE mode direct channel selection

When the TV/CABLE selection is in the CABLE position, channels can be selected as follows:

TO SELECT CABLE TV CHANNELS:

- 1-9: Press "0" twice, then 1-9 as needed. Example, to select channel 2, press "002".
- 10-12: Press "0", then the remaining 2 digits. Example, to select channel 12, press "012".
- 13-99: Press the 2 digits in order. Example, to select channel 36, press "36".
- 100-125: Press the 3 digits in order. Example, to select channel 120, press "120".

NOTE FOR CHANNELS 1-12:

If only 1 or 2 buttons are pressed, the corresponding channel will be selected in 2 seconds.

TV	CABLE
VHF 2-13	VHF 2-13
UHF 14-69	STD/HRC/IRC 14-36 (A) (W) 37-59 (AA) (WW) 60-85 (AAA) (ZZZ) 86-94 (86) (94) 95-99 (A-5) (A-1) 100-125 (100) (125) 01 (5A)

Notes:

- If a channel with no broadcast is selected, the sound will automatically be muted.
- If a station being viewed stops broadcasting, the TV will automatically shut itself off after 15 minutes.

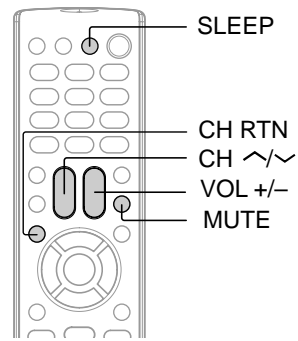

TV operation

■ CHANNEL UP/DOWN

Press and release **CH** \wedge or \vee . The channel automatically stops at the next channel set into memory. For proper operation, before selecting channels, they should be set into the memory. See page 21 "To memorize channels".

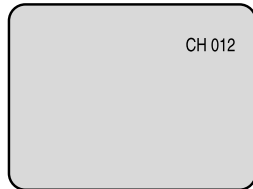
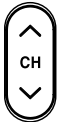

■ CHANNEL RETURN

This button allows you to go back to the last channel selected by pressing **CH RTN**. Press **CH RTN** again to return to the last channel you were watching.

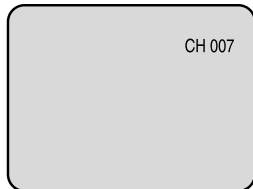

■ MUTE

Press **MUTE** to switch off the sound. The unit's sound will be silenced and "MUTE" will briefly appear on the screen. The sound can be switched back on by pressing this button again or one of **VOL +/-**.

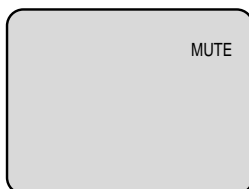

■ SLEEP

To set the unit to turn off after a preset amount of time, press **SLEEP** on the remote control. The clock will count down 10 minutes for each press of **SLEEP** (120, 110, ...10, 0). After the sleep time is programmed, the display will appear briefly every ten minutes to remind you that the sleep timer is operating. To confirm the sleep timer setting, press **SLEEP** and the remaining time will be displayed for a few seconds. To cancel the sleep timer, press **SLEEP** repeatedly until the display turns to 0.

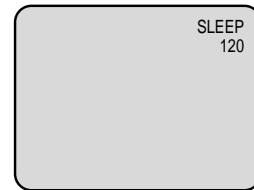

■ HEADPHONES

Insert a monaural headphones (not supplied) with a 1/8" mini plug into the PHONE jack on the front panel. If you connect headphones, the sound from TV speakers is muted.

Illustration of MV13Q41

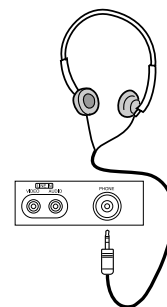

TV operation

Closed captions

WHAT IS CLOSED CAPTIONING?

This television has the capability to decode and display closed captioned television programs. Closed captioning will display text on the screen for hearing impaired viewers or it will translate and display text in another language.

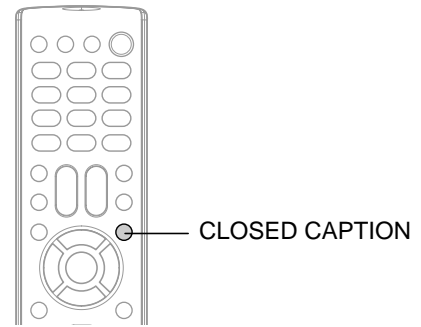

Closed captions

Captions: This closed caption mode will display text on the screen in English or another language (depending on the setting of the closed captions CH 1/2).

Generally, closed captions in English are transmitted on captions channel 1 and closed captions in other languages are transmitted on captions channel 2.

Text: The text closed caption mode will usually fill the screen with a programming schedule or other information. After selecting a closed caption mode, it will stay in effect until it is changed, even if the channel is changed.

If the captions signal is lost due to a commercial or a break in the signal, the captions will reappear when the signal is received again. If the channels are changed, the captions will be delayed approximately 10 seconds. The captions will appear in places on the screen where they will least interfere with the picture, usually on the bottom of the screen. News programs will usually show three-line closed captions which scroll onto the screen. Most other shows provide two or three lined captions placed near the character who is speaking so the viewer can follow the dialogue. Words in italics or underlined describe titles, words in foreign languages or words requiring emphasis. Words that are sung usually appear enclosed by musical notes.

For television programs broadcasting with closed captions, look in your TV guide for the closed captions symbol (CC).

TO VIEW CLOSED CAPTIONS

Press **CLOSED CAPTION** to switch between normal TV and the two closed caption modes (captions and full screen text). Closed captioning will display text on the screen for hearing impaired viewers.

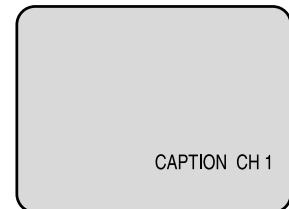

Notes:

- When selecting closed captions, the captioning will be delayed approximately 10 seconds.
- If no caption signal is received, no captions will appear, but the television will remain in the caption mode.
- Misspellings or unusual characters may occasionally appear during closed captioning. This is normal with closed captioning, especially with live programs. This is because during live programs, captions are also entered live. These transmissions do not allow time for editing.
- When captions are being displayed, on-screen displays, such as volume and mute may not be seen or may interfere with closed captions.
- Some cable systems and copy protection systems may interfere with the closed captioned signal.
- If using an indoor antenna or if TV reception is very poor, the closed caption decoder may not appear or may appear with strange characters or misspelled words. In this case, adjust the antenna for better reception or use an outdoor antenna.

To memorize channels

This unit is equipped with a channel memory feature which allows channels to skip up or down to the next channel set into memory, skipping over unwanted channels. Before selecting channels, they must be programmed into the unit's memory. In addition to normal VHF and UHF channels, this unit can receive up to 113 cable TV channels. To use this unit with an antenna, set the TV/CABLE selection to the TV position. When shipped from the factory, this selection is in the CABLE position.

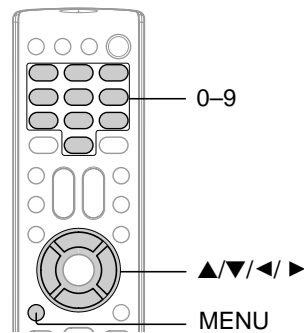

TV/CABLE selection

1 Press MENU, then press ◀ or ▶ to select option.

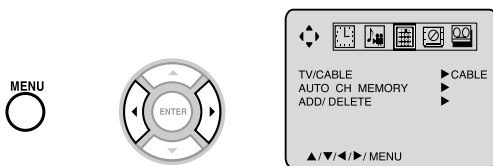

2 Press ▲ or ▼ to select "TV/CABLE".



3 Press ◀ or ▶ to select "TV" or "CABLE".

TV - VHF/UHF channels
CABLE - Cable TV channels



4 Press MENU repeatedly until the menu screen is cleared.



Automatic memory tuning

Press ▲ or ▼ to select the "AUTO CH MEMORY", then press ▶.

The TV will begin memorizing all the channels available in your area.



To ADD/DELETE channels

1 Press ▲ or ▼ to select "ADD/DELETE", then press ▶.



2 Select the desired channel to be added or deleted using Direct channel selection (0-9) or ▲ / ▼.

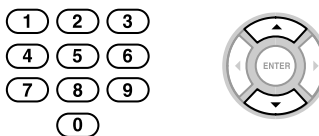

3 Press ◀ or ▶ to select "ADD" or "DELETE", whichever function you want to perform.

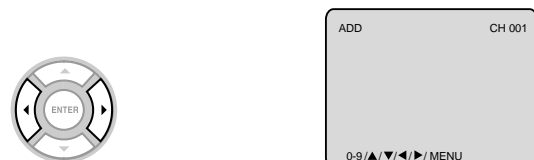

Note: You cannot select option if you set the channel to "LINE".

TV operation

Cable TV chart

The chart below is typical of many cable system channel allocations.

Number on this TV	14	15	16	17	18	19	20	21	22
Corresponding Cable TV channel	A	B	C	D	E	F	G	H	I
23	24	25	26	27	28	29	30	31	32
J	K	L	M	N	O	P	Q	R	S
41	42	43	44	45	46	47	48	49	50
EE	FF	GG	HH	II	JJ	KK	LL	MM	NN
59	60	61	62	63	64	65	66	67	68
WW	AA	BB	CC	DD	EE	FF	GG	HH	II
77	78	79	80	81	82	83	84	85	86
RRR	SS	TT	UU	VV	WW	XX	YY	ZZ	86
95	96	97	98	99	100	101	102	103	104
A+S	A+4	A+3	A+2	A+1	100	101	102	103	104
113	114	115	116	117	118	119	120	121	122
113	114	115	116	117	118	119	120	121	122

Setting the V-Chip

An age limitation can be set to forbid children to watch programs according to "TV RATING" and "MOVIE RATING" level set. To use the V-Chip function, you must register a password.

Notes:

- If you forget the password, you cannot set the V-Chip.
- To avoid forgetting the password, write it down and keep in the safe place.

To register password

1 Press MENU, then press ◀ or ▶ to select  option.

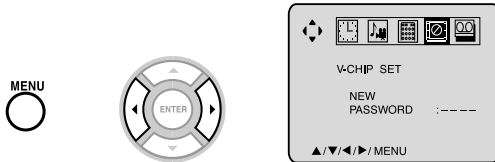

2 Press ▲ or ▼ to select "PASSWORD".

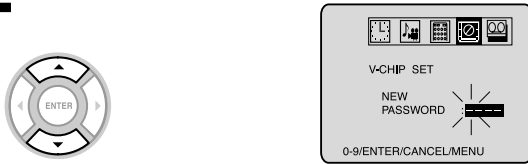

3 Enter the password (4 digits) using Number buttons (0–9), then press ENTER.

- If you put a wrong number, press CANCEL.

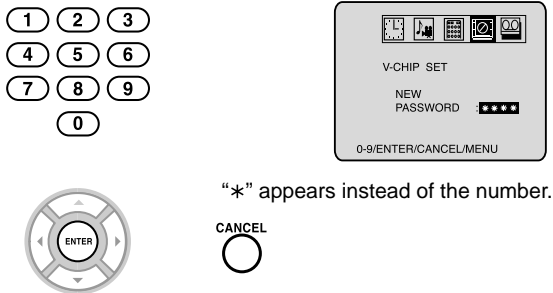

4 Enter the same password again using Number buttons (0–9) for safety, then press ENTER.

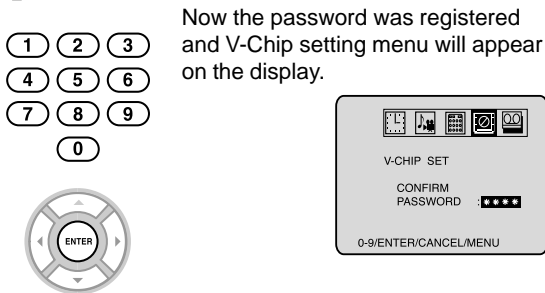

To change password

1 In the V-CHIP menu, press ▲ or ▼ to select "CHANGE PASSWORD", then press ▶.

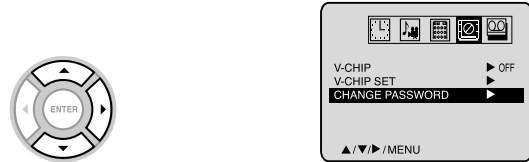

2 Enter the new password using Number buttons (0–9), then press ENTER.



3 Enter the same password again using Number buttons (0–9) for safety, then press ENTER.



4 Press MENU repeatedly until the menu screen is cleared.



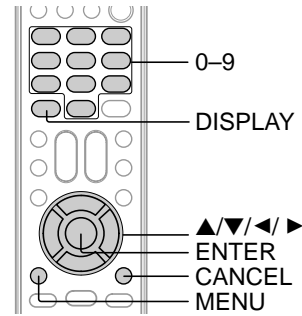

To set the V-Chip

1 In the V-CHIP menu, press ▲ or ▼ to select “V-CHIP SET”, then press ►.

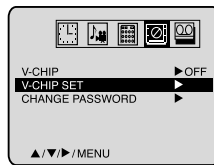

2 Press ▲ or ▼ to select “TV RATING”, then press ◀ or ▶ to display the desired setting. After setting, press ENTER.

- OFF** : TV RATING is not set
- TV-Y** : All children
- TV-Y7** : 7 years old and above
- TV-G** : General audience
- TV-PG** : Parental guidance
- TV-14** : 14 years old and above
- TV-MA** : 17 years old and above

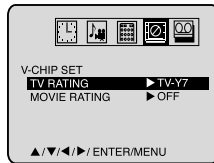

When you select TV- Y7, TV-PG, TV-14 or TV-MA, press **DISPLAY** to show the contained rating. Press ▲/▼/◀/▶ to select the desired item you want.



3 Press ▲ or ▼ to select “MOVIE RATING”.

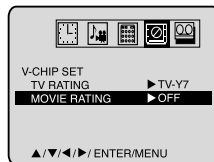

4 Press ◀ or ▶ to select desired rating. After setting, press ENTER.

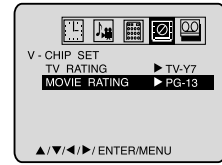

- OFF** : MOVIE RATING is not set
- G** : All ages
- PG** : Parental guidance
- PG-13** : Parental guidance less than 13 years old
- R** : Under 17 years old
- NC-17** : 17 years old and above
- X** : Adult only

5 Press ▲ or ▼ to select “V-CHIP”.

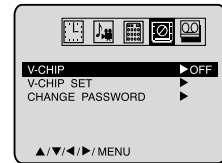

6 Press ◀ or ▶ to display “ON”. Now your settings were set into the memory.

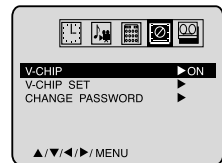

7 Press MENU repeatedly until the menu screen is cleared.



To use after the TV is protected

When the program applied to the V-Chip setting is received, enter the password, then press **ENTER**. Protection can be canceled.

Note:

The V-Chip function is activated only on programs that have the rating signal.

TV operation

To set the on timer

This feature allows you to have the unit automatically turn on at a predetermined time. If you program the ON TIMER once, the unit will turn on the programmed day (daily/weekly) at the same time to the same channel.

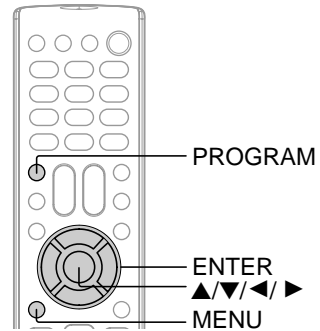

To set the on timer

EXAMPLE: Turning on the TV to channel 12 at 7:00 AM, MONDAY-FRIDAY.

1 Press **MENU**. Press **◀** or **▶** to select option. You can also select ON/OFF TIMER by pressing **PROGRAM** twice.

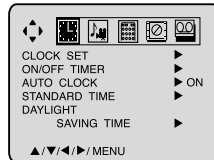

2 Press **▲** or **▼** to select “ON/OFF TIMER”, then press **▶**.



3 Press **▲** or **▼** to select “ON TIMER”, then press **▶**.

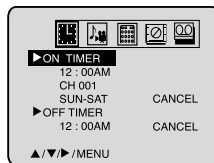

4 Press **◀** or **▶** to set the desired hour, then press **▼**.

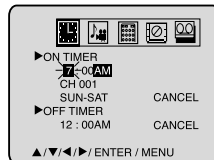

5 Set the desired minute, channel and daily or weekly timer date as in step 4.

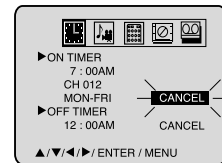

6 Press **◀** or **▶** to select “SET”, then press **ENTER**. Now the ON TIMER is set.

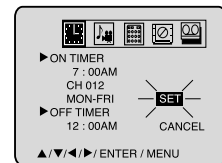

7 Press **MENU** repeatedly until the menu screen is cleared.



Notes:

- The unit will automatically turn off approximately 1 hour later after the ON TIMER turns on if no OFF TIMER has been set. To continue watching the TV, press any button to cancel the one hour automatic shut off.
- To cancel the ON TIMER, follow above steps 1~5, then press **◀** or **▶** to select “CANCEL”. Press **MENU** repeatedly until the menu screen is cleared.
- After setting the ON TIMER, “▶ OFF TIMER” will be highlighted. If you wish to set the OFF TIMER, press **▶** then follow the steps 4~6 on page 25.
- If you want to correct the digits while setting, press **▲** or **▼** until the item you want to correct, then press **◀** or **▶** to correct the desired setting.

To set the off timer

This feature allows you to have the unit turn off automatically at a predetermined time. If you program the OFF TIMER once, the unit will automatically turn off at the same time everyday.

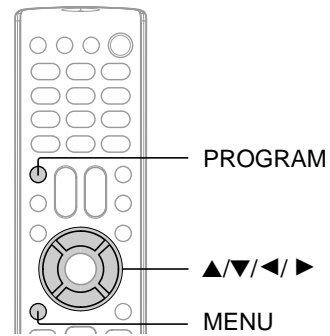

To set the off timer

EXAMPLE: Turning off the TV at 11:30 PM.

- 1** Press **MENU**. Press **◀** or **▶** to select option. You can also select ON/OFF TIMER by pressing **PROGRAM** twice.

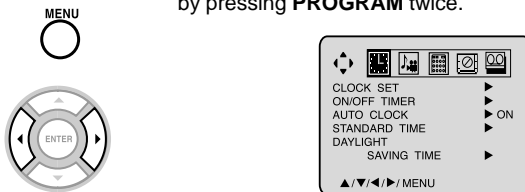

- 2** Press **▲** or **▼** to select “ON/OFF TIMER”, then press **▶**.



- 3** Press **▲** or **▼** to select “OFF TIMER”, then press **▶**.



- 4** Press **◀** or **▶** to set the desired hour, then press **▼**.



- 5** Press **◀** or **▶** to set the desired minute, then press **▼**.



- 6** Press **◀** or **▶** to select “SET”. Now the OFF TIMER is set.



- 7** Press **MENU** repeatedly until the menu screen is cleared.



Notes:

- **To cancel the OFF TIMER function:**
To cancel OFF TIMER, follow above steps 1~5, then press **◀** or **▶** to select “CANCEL”. Press **MENU** repeatedly until the menu screen is cleared.
- **To confirm the ON/OFF TIMER:**
Press **PROGRAM** twice to indicate the programs on the screen.

TV operation

Picture control adjustment/ Adjusting the picture preference

Picture controls are factory preset but you can adjust them individually as follows:
And also you can select four picture modes—Standard, Sports, Movie, and Memory—as described in the following table:

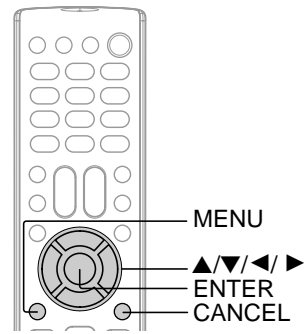

Picture control adjustment

1 Press MENU, then press ◀ or ▶ to select

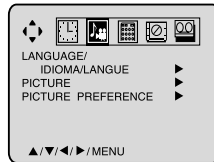

2 Press ▲ or ▼ to select "PICTURE", then press ▶.

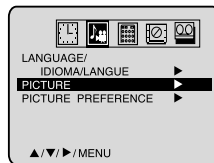

3 Press ▲ or ▼ to select the item you want to adjust, then press ◀ or ▶ to adjust the setting.

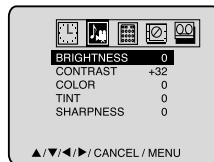

Selection	◀ Pressing ▶	
BRIGHTNESS	darker	lighter
CONTRAST	lower	higher
COLOR	paler	deeper
TINT	reddish	greenish
SHARPNESS	softer	sharper

Note:
The CONTRAST default setting is set to maximum (+32) at the factory.

4 After your desired setting press MENU repeatedly until the menu screen is cleared.



Adjusting the picture preference

1 Press MENU, then press ◀ or ▶ to select

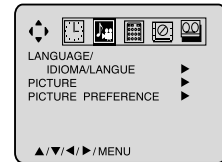

2 Press ▲ or ▼ to select "PICTURE PREFERENCE", then press ▶.

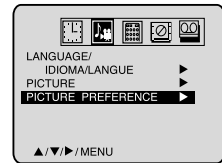

3 Press ▲ or ▼ to select the desired picture mode, then press ENTER.



Mode	Picture quality
STANDARD	Standard picture quality (factory-set)
SPORTS	Bright and dynamic picture (factory-set)
MOVIE	Movie-like picture setting (factory-set)
MEMORY	Your personal preferences (set by you; see "Picture control adjustment" as left)

4 After your desired setting press MENU repeatedly until the menu screen is cleared.



■ To return all adjustments to the factory preset levels
Press CANCEL while making picture adjustments.

Loading and unloading a cassette tape

Use only video cassette tapes marked **VHS**.

Loading

Push the center of the tape until it is automatically inserted.



Insert the cassette tape with its labeled side facing up and the erase prevention tab positioned at your left. An inverted cassette tape cannot be inserted.

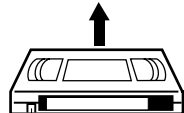

Erase prevention tab

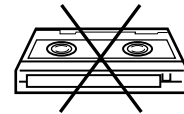

Automatic power ON

When you insert a cassette tape the unit power will turn ON automatically.

Automatic playback

When loading a cassette tape without an erase prevention tab, playback will start automatically.

Unloading

1 Press **STOP/EJECT** on the front panel or press **EJECT** on the remote control.

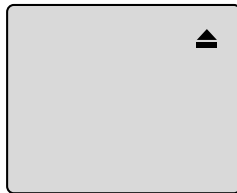
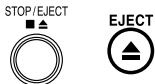

2 Remove the cassette tape.

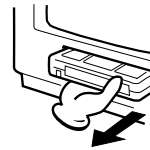

Automatic tape eject

This unit will automatically rewind the tape when the tape has ended. And when the tape is rewinded to its beginning, the cassette tape will be ejected automatically.

Notes:

- Always eject the tape when not in use.
- The cassette tape can be ejected even if the POWER is "OFF".

To prevent accidental erasure

To prevent accidental erasure

Remove the erase prevention tab with a screwdriver.

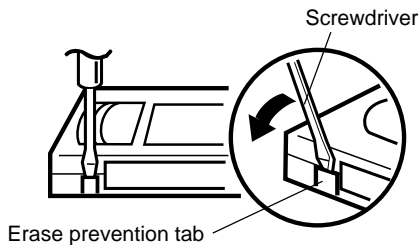

To record again

Cover the hole with a piece of adhesive tape.

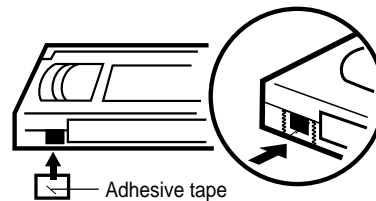

Tape speed and maximum recording time

Tape Speed	Video cassette tape				
	T-160	T-120	T-90	T-60	T-30
SP (Standard Play)	2-2/3 hours	2 hours	1-1/2 hours	1 hour	30 minutes
SLP (Super Long Play)	8 hours	6 hours	4-1/2 hours	3 hours	1-1/2 hours

Cassette tape playback

To play a prerecorded tape.

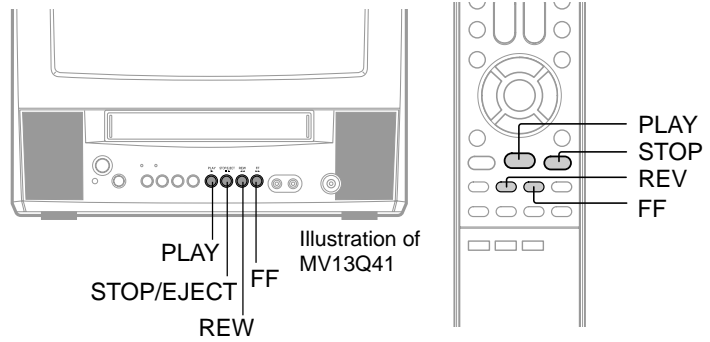

Playback

1 Load a prerecorded tape:
 (When loading a cassette tape without the erase prevention tab, playback will start automatically).

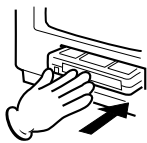

2 To start playback:
 Press **PLAY** on the front panel or on the remote.
 Playback will start. "▶" will appear on the screen for about 4 seconds.



To stop playback:
 Press **STOP/EJECT** once on the front panel or press **STOP** on the remote.
 The tape will stop but remain fully loaded and ready to play.
 "■" will appear on the screen for about 4 seconds.

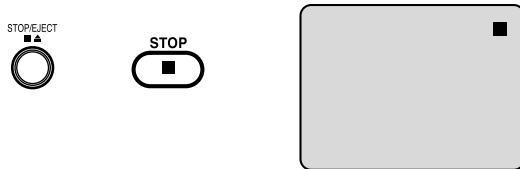

Note:
 This unit selects the playback tape speed SP or SLP automatically.

Rewind or forward the tape

Stop the playback or recording with **STOP**.

To rewind the tape:
 Press **REW** on the front panel or press **REV** on the remote.

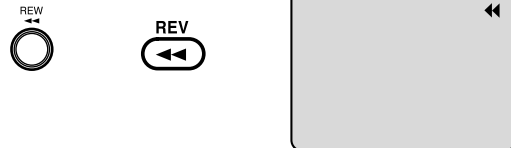

To forward the tape:
 Press **FF** on the front panel or on the remote.

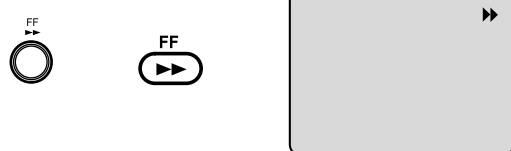

To stop the tape-winding, press **STOP**. To switch to playback directly (without **STOP**), press **PLAY**.

■ Forward/Reverse picture search mode
 When the tape is being wound, you can switch to picture search mode (see next page). To do this, press **REV** or **FF** again and hold it down. The unit will resume the tape winding as soon as the button is released.

Special playback

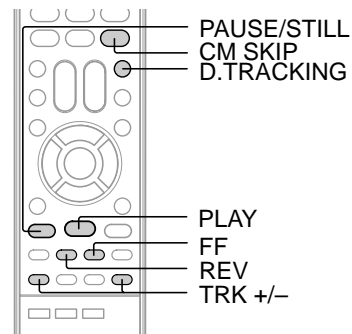

Picture search

Reverse picture search function

Press **REV** once or twice during the playback.

Forward picture search function

Press **FF** once or twice during the playback.

To return to playback, press **PLAY**.

SPEED SEARCH TIMES

TAPE SPEED	PICTURE SEARCH SPEED	
	PRESS ONCE	PRESS TWICE
SP (Standard Play)	3 X	5 X
SLP (Super Long Play)	9 X	15 X

Still picture

Press **PAUSE/STILL** during playback.

To resume normal playback, press **PLAY** or **PAUSE/STILL**.

If the still picture jitters excessively, press **TRK +/-** to stabilize the still picture.

CM skip

Press **CM SKIP** during playback. The unit will search forward through approximately 30 seconds of the tape (e.g. unwanted commercial time) for each press of **CM SKIP** (maximum six presses) and then resume normal playback.

For example : 1 press: 30 seconds of tape
2 press: 60 seconds of tape
3 press: 90 seconds of tape

Digital tracking controls

When a tape is played, the Digital Auto Tracking system automatically adjusts the tracking to obtain the best possible picture. If noise bars appear during playback, adjust the tracking manually as follows:

- Press **TRK +/-** to obtain the best possible picture. "MANUAL TRACK" will appear for 4 seconds on the screen. To resume automatic tracking, press **D.TRACKING**. "DIGITAL TRACK" will appear for 4 seconds on the screen.

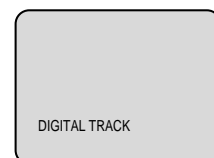
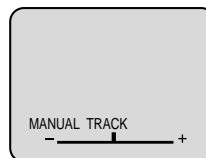

Playback

Notes:

- "SP" is more appropriate as less noise appeared during search and still playback for tape recorded in SP.
- The audio output is muted during PICTURE SEARCH and STILL.
- During picture search mode there will be noise bars which are caused by the system.
- The Special Playback will automatically change to playback after approx. 5 minutes to protect the video tape against excessive wear.

Convenient function

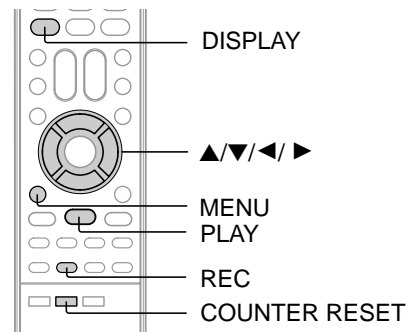

Repeat playback

The entire video tape will be played until its end. The tape will automatically rewind to the beginning and the playback will be repeated.

1 Press MENU, then press ◀ or ▶ to select option.



2 Press ▲ or ▼ to select "AUTO REPEAT".



3 Press ◀ or ▶ to select "ON" or "OFF".

If "ON" is selected, the playback will be repeated endlessly.



4 Press MENU repeatedly until the menu screen is cleared.

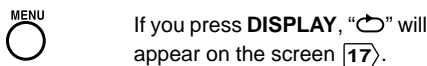

5 To start the playback, press PLAY.

The playback will be repeated endlessly.



■ To cancel repeat mode:

In step 3 above, press ◀ or ▶ to select "OFF" position. Press MENU repeatedly until the menu screen is cleared. The repeat function is canceled automatically when the unit is switched off.

Using the real time tape counter

The on-screen real time tape counter shows the tape running time in hours, minutes and seconds. You can easily determine how long the tape has been running or how much time is left on the tape.

1 Press DISPLAY.

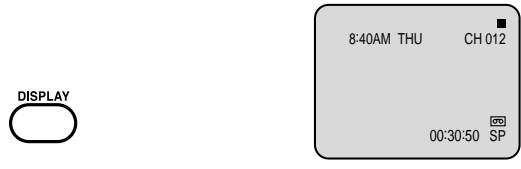

2 Press COUNTER RESET to set the counter to "00:00:00".

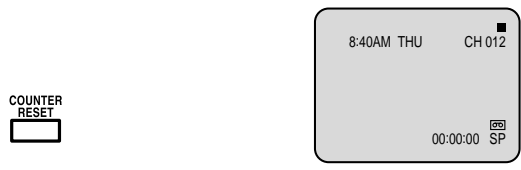

3 Begin Playback or Recording to start the tape, the counter will display the elapsed time.



4 When you wish to make the counter disappear, press DISPLAY once again.



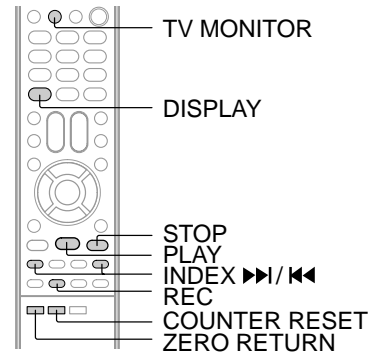

Zero return function

The zero return function provides a convenient method of rapidly returning to the starting point of recording or playback. The starting point can be indexed for any location on the tape by pressing COUNTER RESET and ZERO RETURN.

1 Press DISPLAY.

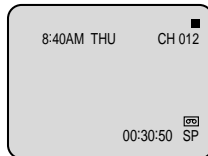

2 Before playback or recording, press COUNTER RESET to set the counter to "00:00:00".

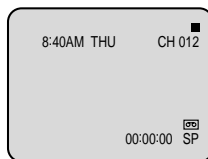

3 Begin playback or recording.



4 Press STOP.

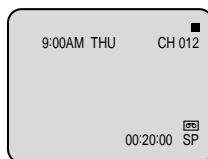

5 Press ZERO RETURN. The tape will rewind and automatically stop at the "00:00:00" position.

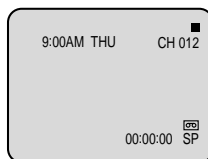

Video index search system

This function enables you to locate the beginning of any recording made on the VCR.

Recording an INDEX mark

The Index Search function automatically records an INDEX mark on the tape whenever a recording is initiated.

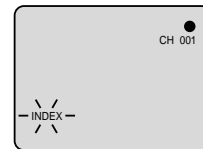

Index search

Press INDEX ►► or ◄◄ during stop or play mode. For Succeeding programs: Press INDEX ►►.

For Preceding programs: Press INDEX ◄◄.

(As many as 9 index points can be accessed via this method.)

When the INDEX ►► or ◄◄ is pressed, the unit starts searching the INDEX NO. selected and finds the portion, then playback starts automatically. To stop the Index Search, press STOP.



►► or ◄◄ is displayed



INDEX NO. (up to 9)

Notes:

- When you record an INDEX mark at the very beginning of the tape, the mark may not be found.
- During INDEX search, the tape may stop and begin to play at a slightly different location.
- INDEX may not function properly with old or worn out video tapes.
- INDEX marks may not be found if it is extremely close to the point where the search began.
- In recording, if you stop recording temporarily, the INDEX mark is not recorded on the tape.

To monitor a TV program

Press TV MONITOR while in the playback mode. The video tape will continue to play while the picture switches to the TV channel selected on the unit. Press the button to return to the playback picture.



Playback

Recording a TV program

Recording and viewing the same TV program.

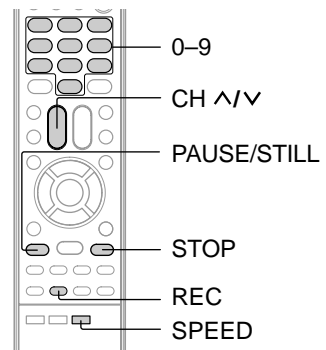

Recording a TV program

1 Load a cassette tape with the erase prevention tab intact.
The unit will automatically turn on.

2 Press SPEED to select the desired tape speed SP or SLP.
The tape counter and SP or SLP will appear on the screen for about 4 seconds.

3 Select "TV" or "CABLE" to the appropriate position 21.

TV	- VHF/UHF channels
CABLE	- Cable TV channels

4 Press Direct channel selection (0-9) or CH ^/v to select the channel to be recorded.

5 Press REC to start recording.
"●" will appear on the screen for about 4 seconds and the REC indicator on the front panel will light.

- Notes:**
- The unit channel cannot be changed during recording.
 - If power is switched off during recording, the TV goes off and the VCR continues to record. Press **STOP** to halt the recording and turn off the VCR.

To stop recording

Press STOP to stop recording.
"■" will appear on screen for about 4 seconds.

To stop recording temporarily

Press PAUSE/STILL to avoid recording unwanted material.
"||" will appear on the screen and the REC indicator will blink on and off. Press **PAUSE/STILL** or **REC** to continue the recording.

Note:
The pause function will be released after 5 minutes to prevent damage to the tape or the unit. The unit will change to the STOP mode.

- Auto Rewind feature**
This VCR will automatically rewind the tape when the tape has ended (except during OTR and timer recording). It will also eject the tape.
- Note:**
If the erase prevention tab is removed, the tape will eject when **REC** is pressed for recording.

One-touch Timer Recording (OTR)

The One-touch timer recording feature provides a simple and convenient way to make a timed recording.

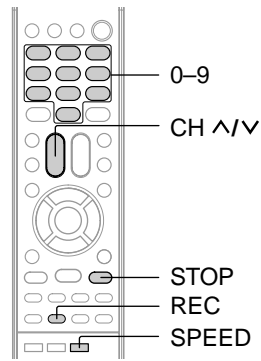

One-touch timer recording (OTR)

Example: One-touch timer recording for 30 minutes.

- 1 Load a cassette tape with the erase prevention tab intact.**



The unit will automatically turn on.

- 2 Press SPEED to select the desired tape speed SP or SLP.**

The tape counter and SP or SLP will appear on the screen for about 4 seconds.

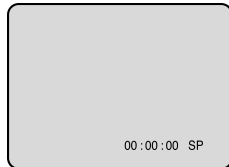

- 3 Set "TV" or "CABLE" option to the appropriate position [21].**

TV - VHF/UHF channels
CABLE - Cable TV channels

- 4 Press Direct channel selection (0-9) or CH ^/v to select the channel to be recorded.**

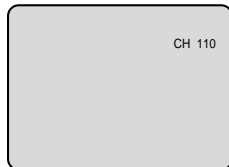
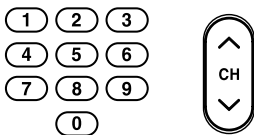

- 5 Press REC to begin recording. Press the button again to stop recording after 30 minutes. Each additional press of REC will increase recording time as shown below, up to a maximum of 6 hours. "OTR" will appear on the screen.**

Press	Recording time	Press	Recording time
once	NORMAL REC	6 times	3:00
twice	0:30	7 times	4:00
3 times	1:00	8 times	5:00
4 times	1:30	9 times	6:00
5 times	2:00	10 times	NORMAL REC

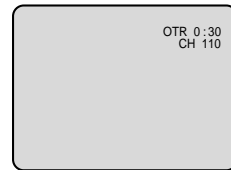

Recording

To cancel OTR

Press **STOP**.



"■" will appear on screen for about 4 seconds.

Note:

The channel cannot be changed during recording.

Timer recording

Timer recording can be programmed on-screen with the remote control. The built-in timer allows automatic unattended recording of up to 8 programs within 1 month.

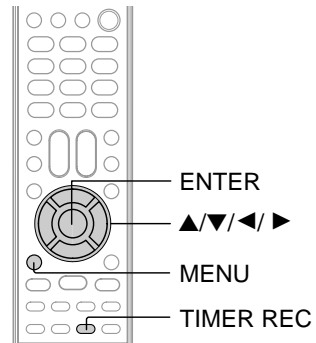

Timer recording

Preparation:

- Load a cassette tape with the erase prevention tab intact.
- Check the time and date are correct [16].

Example:

Program a timer recording for 23rd day, channel 125 (Cable TV), 7:00 - 9:30 PM (Tape speed : SLP).

1 Press MENU, then press ◀ or ▶ to select option.

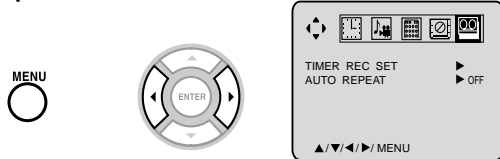

2 Press ▲ or ▼ to select "TIMER REC SET", then press ▶.



3 Press ▲ or ▼ to select one of the program line, then press ENTER.

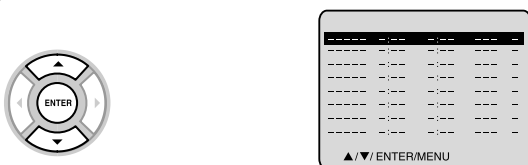

4 Press ◀ or ▶ to select the date, then press ▼.

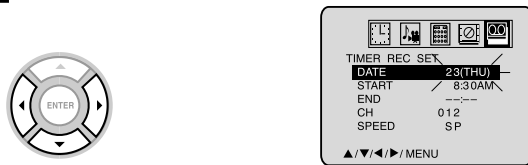

5 Set the start time, end time, channel and tape speed as in step 4. Then press ENTER.

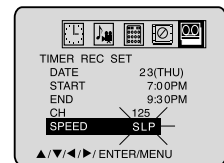

Notes:

- Press ▲ to move cursor backward for correction.
- To record from external source set the channel to "L".

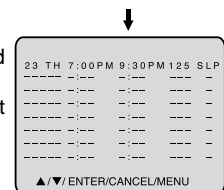

6 To set the timer for another program, repeat steps 3 to 5 to set another program.

7 Press TIMER REC. The TIMER REC indicator will light. The Timer is programmed, when the programmed time is reached, the recording is automatically started.

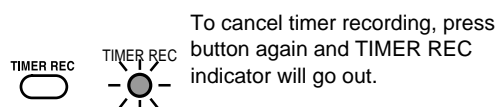

To cancel timer recording, press button again and TIMER REC indicator will go out.

Notes:

- The VCR section cannot be used while the TIMER REC indicator is lit. If you want to use the VCR operation, press **TIMER REC** to deactivate the timer.
- When the clock is not set, you cannot select "TIMER REC". In this case, set the clock (see pages 14~16).
- After a power failure or disconnection of the power plug, all programmed recording setting and time display will be lost upon resumption of power. In this case, reset the clock (see pages 14~16) and reprogram any timer recordings.
- If you want to correct the digits while setting, press ▲ or ▼ until the item you want to correct, then press ◀ or ▶ to correct the desired setting.
- If programming is performed without a tape in the unit, or with a tape without an erase prevention tab, the Timer Recording is not possible. If a tape without an erase prevention tab is in the unit, the tape will be ejected.

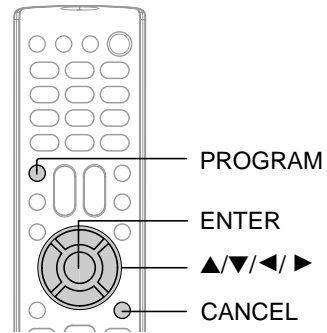

To set daily/weekly timer

Weekly (e.g. WKL-TUE: each Tuesday) or daily (e.g. MON-SAT: Monday to Saturday) Timer recording

Follow the procedure of timer recording on the previous page. At picture 4 press ◀ or ▶ repeatedly until the desired setting appears. Then press ENTER.

When you press ◀ repeatedly, the indicator at DATE will change as follows, in this case the day is Friday.

The current day (Friday) → SUN-SAT (Sunday to Saturday)

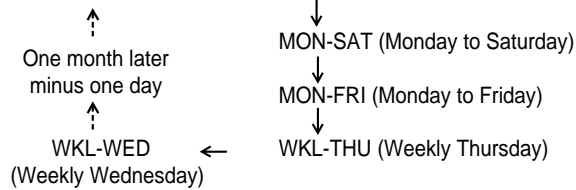

If the programs overlap another

Do not overlap timer programs as portions of the conflicting programs will be lost. The first recording time has priority over the next recording time as shown in the diagram below.

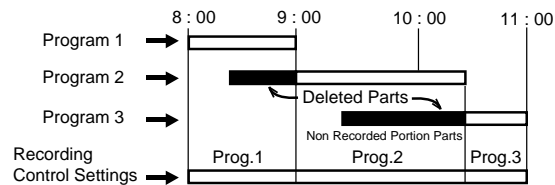

Notes:

- The daily/weekly recording can be made continuously until the recording is canceled or the tape reaches the end.
- During timer recording the automatic rewinding mechanism does not function.
- You can correct or cancel the programmed setting in program confirm mode.

To confirm the settings

Press PROGRAM once. The TV screen displays the timer program list. Press PROGRAM again. The TV screen displays the ON/OFF timer setting.



Press PROGRAM 3 times. The menu screen is cleared.

(once)

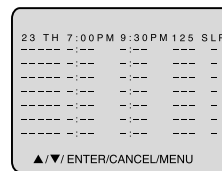

(twice)

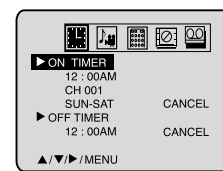

To cancel a program

Press PROGRAM once. The TV screen displays the timer program list.

Press ▲ or ▼ to select the unnecessary program, and press CANCEL to cancel the program.

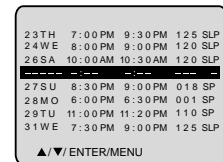

Recording

Duplicating a video tape

If you connect the unit to another VCR or Camcorder, you can duplicate a previously recorded tape. Make all connections before turning on the power.

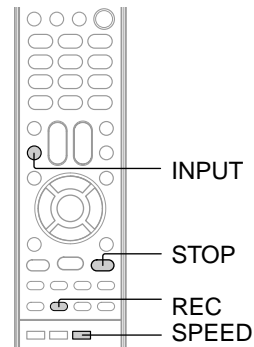

Duplicating a video tape

Preparation:

- Load a cassette tape with the erase prevention tab intact.
- Load a previously recorded tape into the playback VCR or Camcorder.

1 Press SPEED to select the desired tape speed SP or SLP.



It is recommended that you set the Speed to the SP mode on the recording VCR for best results.

2 Press INPUT to select AUDIO/VIDEO input position.

"LINE" will appear on the screen.



3 Press REC to start recording.



4 Press PLAY on the playback VCR or camcorder.

5 Press STOP after duplicating a video tape.



Note:

Unauthorized recording of copyrighted television programs, films, video cassettes and other materials may infringe the rights of copyright owners and be contrary to copyright laws.

Connection with second video recorder

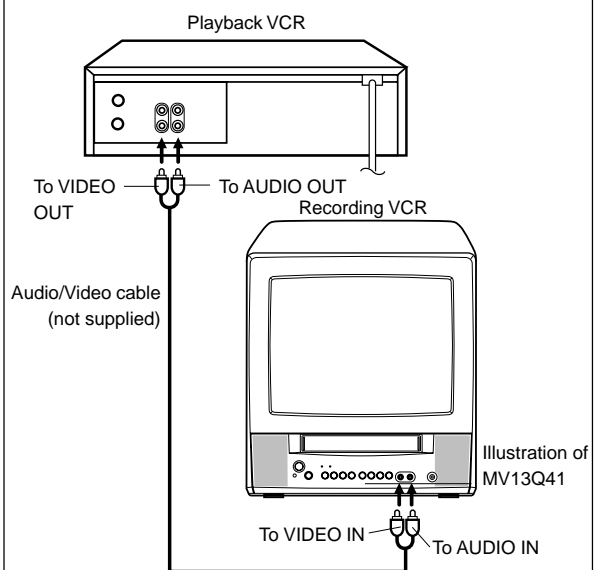

Connection with Camcorder

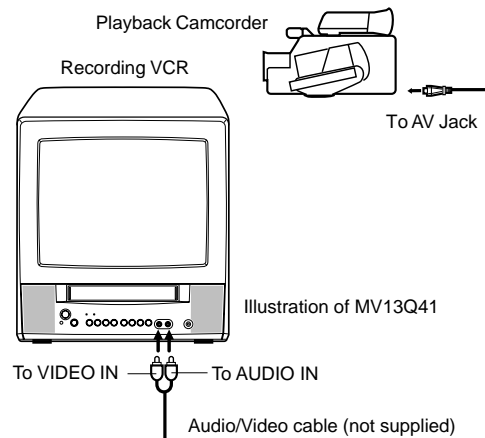

For duplicating a previously recorded tape from a camcorder, follow the camcorder manufacturer's instructions. A typical camcorder dubbing hookup is shown above.

Reception disturbances

Most types of television interference can be remedied by adjusting the height and position of the VHF/UHF antenna. Outdoor antennas are recommended for best results. The most common types of television interference are shown below. If one of these symptoms appear when the unit is connected to a Cable TV system, the disturbance may be caused by the local Cable TV company broadcast.

IGNITION

Black spots or horizontal streaks may appear, the picture may flutter or drift. Usually caused by interference from automobile ignition systems, neon lamps or AC powered tools and appliances such as drills or hair dryers.



GHOSTS

Ghosts are caused by the television signal following two paths. One is the direct path and the other is reflected by tall buildings, hills or other large objects. Changing the direction or position of the antenna may improve the reception.



SNOW

If the unit is located far from the TV station, in a fringe reception area where the signal is weak, small dots may appear in the picture. If the signal is extremely weak, the installation of a larger external antenna may be necessary.



RADIO FREQUENCY INTERFERENCE (RFI)

Caused by two-way radios, this type of interference produces moving ripples or diagonal streaks in the picture. Some cases may cause a loss of contrast in the picture. Changing the direction and position of the antenna or installing an RFI filter may improve the picture.



PICTURE SIZE VARIATION

A slight picture size variation is normal when you adjust the CONTRAST or BRIGHTNESS settings.



CARE AND MAINTENANCE

To prevent fire or shock hazard, disconnect the unit from the power source before cleaning. The finish on the cabinet may be cleaned with mild soap and a soft, damp cloth and cared for as other furniture. Use caution when cleaning or wiping the plastic parts.

Troubleshooting

Check the following guide for the possible cause of a problem before contacting service.

SYMPTOMS	CAUSE	POSSIBLE SOLUTIONS	PAGE
POWER			
No power.	The AC power cord is not connected.	Connect the AC power cord to the AC outlet.	5
Although the power is on, the unit does not operate.	Cassette is not inserted.	Insert a video cassette.	27
	The TIMER REC button is depressed.	Press the TIMER REC button.	34
TV BROADCAST RECEPTION			
Poor or no picture.	TV station experiencing problems.	Try another channel.	18
	Picture control is not adjusted.	Check picture control adjustments.	26
	Possible local interference.	Check for source of reception disturbance.	37
	Antenna (CABLE) connector is not connected or possible local interference.	Check CABLE connection or VHF/UHF antenna, reposition or rotate antenna.	11,12
Poor or no color.	TV station experiencing problems.	Try another channel.	18
	Picture control is not adjusted.	Check picture control adjustments.	26
	Possible local interference.	Check for source of reception disturbance.	37
	Antenna (CABLE) connector is not connected or possible local interference.	Check CABLE connection or VHF/UHF antenna, reposition or rotate antenna.	11,12
Picture wobbles or drifts.	TV station experiencing problems.	Try another channel.	18
	Antenna (CABLE) connector is not connected or possible local interference.	Check CABLE connection or VHF/UHF antenna, reposition or rotate antenna.	11,12
	Cable TV channel is scrambled.	Try another channel.	18
No CATV reception.	CABLE connector is not connected.	Check all CABLE connections.	12
	TV/CABLE selection is set to the TV position.	Set the selection to the CABLE position.	21
	Cable TV service interrupted.	Contact your Cable TV company.	12
No reception above channel 13.	TV/CABLE selection is not set to the appropriate position.	Make sure selection is in the appropriate position.	21
	UHF antenna is not connected.	Check UHF antenna.	11
Poor or no sound.	TV station experiencing problems.	Try another channel.	18
	Antenna (CABLE) connector is not connected or possible local interference.	Check CABLE connection or VHF/UHF antenna, reposition or rotate antenna.	11,12
	Possible local interference.	Check for source of reception disturbance.	37
	The MUTE button is depressed.	Check the MUTE button has not been pressed.	19
TV shuts off.	TV station stopped broadcasting.	Tune new channel.	18
	Sleep timer is set.	Set Sleep Timer to "0".	19
Closed caption is not activated.	TV station experiencing problems or program tuned is not closed captions.	Try another channel.	18
	TV signal is weak.	Check CABLE connection of VHF/UHF antenna, reposition or rotate antenna.	11,12
	The CLOSED CAPTION button is not depressed.	Press the CLOSED CAPTION button to turn on the closed caption.	20



SYMPTOMS	CAUSE	POSSIBLE SOLUTIONS	PAGE
RECORDING			
TV recording does not work.	The video cassette's erase prevention tab is broken off.	Place a piece of adhesive tape over the hole.	27
Timer recording does not work.	The time is not set correctly.	Reset the present time.	16
	The recording start/end time is not set correctly.	Reset the start/end time.	34
	The TIMER REC button have not been pressed (the TIMER REC indicator is not lit).	Press the TIMER REC button (the TIMER REC indicator is lit).	34
PLAYBACK			
Noise bars appear on the screen.	Tape is old or worn.	Replace the tape.	-
	Tracking adjustment is beyond range of automatic tracking circuit.	Adjust tracking manually using the TRK +/- buttons on the remote control.	29
	Video heads are dirty.	Clean the video heads.	39
REMOTE CONTROL			
Remote control does not operate.	The remote control is not aimed at the sensor.	Aim the remote control at the remote sensor.	10
	Distance is too far or too much light in the room.	Operate within 5 m or reduce the light of the room.	10
	There is an obstacle in the path of the beam.	Clear the path of the beam.	10
	The batteries are weak.	Replace the batteries.	10
	The batteries are not inserted correctly.	Insert correctly.	10

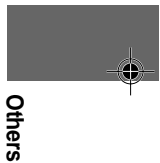

Others

Video head cleaning

VIDEO HEAD CLOGGING

The video heads are the means by which the unit reads the picture from the tape during playback. In the unlikely event that the heads become dirty enough to be clogged, no picture will be played back. This can easily be determined if, during playback of a known good tape, there is good sound, but no picture (picture is extremely snowy). If this is the case, have the unit checked by qualified service personnel.



Good picture



Snowy picture

VIDEO HEAD CLEANING

Video head cleaning is needed when the playback picture becomes unclear. This signifies that the heads are getting dirty and can occur when playing poor quality or damaged tapes. If the heads require cleaning, use an equivalent high quality chemical non-abrasive (wet) head cleaning tape or have them cleaned professionally. If playing a head cleaning tape in the unit once does not improve the picture, play it several times before requesting service.

DO NOT ATTEMPT TO CLEAN THE VIDEO HEADS OR SERVICE THE UNIT BY REMOVING THE REAR COVER.

Notes:

- Video heads may eventually wear out and should be replaced when they fail to produce clear pictures.
- To help prevent video head clogging, use only good quality VHS tapes. Discard worn out tapes.

Specifications

TELEVISION	MV13Q41	MV20Q41
Picture tube:	13 inches* (335.4 mm diagonal)	20 inches* (508.0 mm diagonal)
Tuner type:	Quartz PLL frequency synthesized	
Receiving channels:	VHF 2-13 UHF 14-69 Cable TV 14-36 (A)-(W) 37-59 (AA)-(WW) 60-85 (AAA)-(ZZZ) 86-94 (86)-(94) 95-99 (A-5)-(A-1) 100-125 (100)-(125) 01 (5A)	
Antenna input:	VHF/UHF In 75 ohms coaxial	
Speaker:	1-1/2 x 2-11/16 inches (38 x 69 mm), 8 ohm	3 inches (76.2 mm), 8 ohm x 2
Audio output power:	1.5W	0.75W + 0.75W
VCR		
Video system:	VHS, 2 rotary heads helical scanning system	
Video signal:	NTSC color	
Cassette tape:	VHS	
Audio track:	1 track	
Tape speed:	SP: 33.35 mm/sec. SLP: 11.12 mm/sec.	
F.FWD/REW time:	F.FWD: Approx. 4 minutes 50 seconds (T-120 cassette) at 25°C (77°F) REW: Approx. 2 minutes 30 seconds (T-120 cassette) at 25°C (77°F)	
Speed search:	SP 3 & 5 x normal speed SLP 9 & 15 x normal speed	
GENERAL		
Power source:	AC 120V 60Hz	
Power consumption:	65 Watts	86 Watts
Dimensions:	Width: 14-1/4 inches (362 mm) Height: 15-1/16 inches (382 mm) Depth: 14-3/8 inches (365 mm)	Width: 19-3/4 inches (502 mm) Height: 20-3/16 inches (513 mm) Depth: 19-1/4 inches (489 mm)
Weight:	24.3 lbs. (11 kg)	48.5 lbs. (22 kg)
Terminals:	Video In: (RCA) 1 Vp-p/75 ohm Audio In: (RCA) -8 dBm/50k ohm	
Storage temperature:	-20°C to 60°C (-4°F to 140°F)	
Operating temperature:	5°C to 40°C (41°F to 104°F)	
Remote control:	Infrared, direct access, 2 x AAA batteries	
Accessories:	300-75 ohm matching transformer Remote control Batteries (2 x AAA)	

*Screen size is approximate.

- Designs and specifications are subject to change without notice.
- Tape Speed shown is approximate.



Limited warranty

Toshiba America Consumer Products, L.L.C. ("TACP") makes the following limited warranties. These limited warranties extend to the original consumer purchaser or any person receiving this set as a gift from the original consumer purchaser and to no other purchaser or transferee.

Limited Ninety (90) Day Warranty

TACP warrants this product and its parts against defects in materials or workmanship for a period of ninety (90) days after the date of original retail purchase. During this period, TACP will repair a defective product or part, without charge to you. You must deliver the entire set to an Authorized TACP Service Station. You pay for all transportation and insurance charges for the set to and from the Service Station.

Limited One (1) Year Warranty

TACP further warrants the parts in this product against defects in materials or workmanship for a period of one year after the date of original retail purchase. During this period TACP will replace a defective part without charge to you, except that if a defective part is replaced after ninety (90) days from the date of original retail purchase you pay labor charges involved in the replacement. You must also deliver the entire product to a TACP Authorized Service Station. You are responsible for all transportation for the set to and from the Service Station.

Limited Two (2) Year Warranty of Picture Tube

TACP further warrants the picture tube in this product against defects in materials or workmanship for a period of two (2) years after the date of original retail purchase. During this period, TACP will replace a defective picture tube without charge to you except that if a defective picture tube is replaced after ninety (90) days from the date of the original retail purchase, you pay labor charges involved in the replacement. You are responsible for all charges involved in the replacement. You are responsible for all transportation and insurance charges for the set to and from the Service Station.



Rental Units

The warranty for rental units begins with the first rental or thirty (30) days from the date of shipment to the rental firm, whichever comes first.

Commercial Units

Products sold and used for commercial use have a limited ninety (90) day warranty for all parts, labor and picture tube.

Owner's Manual and Demographic Card

You should read this owner's manual thoroughly before operating this product. You should complete and mail the enclosed Demographic card within ten days after you, or the person who has given you this product as a gift, purchased this product. This is one way to enable TACP to provide you with better customer service and improved products. Failure to return the Demographic card will not affect your rights under this warranty.

Your Responsibility

The above warranties are subject to the following conditions:

- (1) You must retain your bill of sale or provide other proof of purchase.
- (2) All warranty servicing of this product must be made by an Authorized TACP Service Station.
- (3) These warranties are effective only if the product is purchased and operated in the U.S.A. or Puerto Rico.
- (4) Labor service charges for set installation, set up, adjustment of customer controls and installation or repair of antenna systems are not covered by this warranty. Reception problems caused by inadequate antenna systems are your responsibility.
- (5) Warranties extend only to defects in materials or workmanship as limited above and do not extend to any product or parts which have been lost or discarded by you or to damage to products or parts caused by misuse, accident, damage caused by Acts of God, such as lightning or fluctuations in electric power, improper installation, improper maintenance or use in violation of instructions furnished by us; or to units which have been altered or modified without authorization of TACP.



Others

Limited warranty (continued)

How to Obtain Warranty Service

If after following all of the operating instructions in this manual and checking the section "Troubleshooting" and you still find that service is needed;

- (1) Call the TACP toll free number 1-800-631-3811 after you find a defective product or part to find the nearest Toshiba Authorized Service Station.
- (2) Please present your bill of sale or other proof to the Authorized Service Station.

"TACP Authorized Service Station personnel will come to your home when warranty service is required. Depending on the type of repair required, the service will either be performed in your home or the set will be taken to the TACP Authorized Service Station for repair and returned to your home at no cost to you".

In the Continental United States contact:



All warranties implied by state law, including the implied warranties of merchantability and fitness for a particular purpose, are expressly limited to the duration of the limited warranties set forth above. With the exception of any warranties implied by state law as hereby limited, the foregoing warranty is exclusive and in lieu of all other warranties, guarantees, agreements and similar obligations of manufacturer or seller with respect to the repair or replacement of any parts. In no event shall TACP be liable for consequential or incidental damages.

No person, agent, distributor, dealer or company is authorized to change, modify or extend the terms of these warranties in any manner whatsoever. The time within which action must be commenced to enforce any obligation of TACP arising under this warranty or under any statute, or law of the United States or any state thereof, is hereby limited to 90 days from the date you discover or should have discovered, the defect. This limitation does not apply to implied warranties arising under state law.

This warranty gives you specific legal rights and you may also have other rights which may vary from state to state. Some states do not allow limitation on how long an implied warranty lasts, when an action may be brought, or the exclusion or limitation of incidental or consequential damages, so the above provisions may not apply to you.

Memo

Dotted lines for writing.



Others



TOSHIBA

TOSHIBA AMERICA CONSUMER PRODUCTS, L.L.C.



J5S20101A

05/01 K

Printed in Thailand

Free Manuals Download Website

<http://myh66.com>

<http://usermanuals.us>

<http://www.somanuals.com>

<http://www.4manuals.cc>

<http://www.manual-lib.com>

<http://www.404manual.com>

<http://www.luxmanual.com>

<http://aubethermostatmanual.com>

Golf course search by state

<http://golfingnear.com>

Email search by domain

<http://emailbydomain.com>

Auto manuals search

<http://auto.somanuals.com>

TV manuals search

<http://tv.somanuals.com>