

TOSHIBA HDD & DVD / Video Cassette Recorder RD-XV48DTKF

TOSHIBA



HDD & DVD / Video Cassette Recorder

RD-XV48DTKF

OWNER'S MANUAL

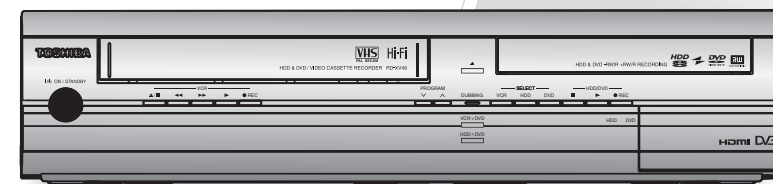

Introduction

Connections

Basic Setup

Recording

Playback

Editing

Function Setup

VHS Functions

Others

TOSHIBA

Printed in China

1VMN24753 / E3NG0FD ★★★★★

© 2008 Toshiba Corporation

Introduction

Precautions

WARNING: TO REDUCE THE RISK OF FIRE OR ELECTRIC SHOCK, DO NOT EXPOSE THIS APPLIANCE TO RAIN OR MOISTURE.



CAUTION:
TO REDUCE THE RISK OF ELECTRIC SHOCK, DO NOT REMOVE COVER (OR BACK). NO USER SERVICEABLE PARTS INSIDE. REFER SERVICING TO QUALIFIED SERVICE PERSONNEL.

The important note is located on the rear of the cabinet.

The lightning flash with arrowhead symbol, within an equilateral triangle, is intended to alert the user to the presence of uninsulated "dangerous voltage" within the product's enclosure that may be of sufficient magnitude to constitute a risk of electric shock to persons.

The exclamation point within an equilateral triangle is intended to alert the user to the presence of important operating and maintenance (servicing) instructions in the literature accompanying the appliance.

Laser Safety

This unit employs a laser. Only a qualified service personnel should remove the cover or attempt to service this unit, due to the possibility of eye injury.

CAUTION: USE OF CONTROLS OR ADJUSTMENTS OR PERFORMANCE OF PROCEDURES OTHER THAN THOSE SPECIFIED HEREIN MAY RESULT IN HAZARDOUS RADIATION EXPOSURE.

CAUTION: VISIBLE AND INVISIBLE LASER RADIATION WHEN OPEN AND INTERLOCK DEFEATED. DO NOT STARE INTO BEAM.

LOCATION: INSIDE, NEAR THE DECK MECHANISM.

Power Supply

The power supply is connected and the unit is live when the mains cable is plugged into a 220 - 240 V~, 50 Hz AC outlet. To operate the unit, press [I/O] ON/STANDBY].

WARNING: LIVE PARTS INSIDE.
DO NOT REMOVE ANY SCREWS.

Caution

- Do not attempt to open the cabinet. There are no parts inside you can service. Refer all servicing to qualified service personnel.
- Slots and openings in the cabinet at the sides and underneath are provided for ventilation. To ensure reliable operation and to protect the unit from overheating, these openings must not be blocked or covered.
Avoid installation in enclosed spaces such as bookcases unless suitable ventilation is provided.
- Keep the unit away from radiators and other heat sources.
- Avoid use near strong magnetic fields.
- Do not push objects of any kind into the unit through the cabinet slots or openings as they could touch electrically live parts or short circuit parts resulting in a fire or electric shock.
- Do not spill liquid on the unit. If liquid is spilled and enters the unit, consult qualified service personnel.
- Do not stand the unit vertically. Use the unit in a horizontal (flat) position only.
- Before attempting to operate the unit, make sure that the timer recording mode is off.
- This product is in Stand-by mode when turned off while the mains cable is connected.
- Do not place any combustible objects on the device (candles, etc.).
- Before moving the unit, be sure to remove any discs and unplug the mains cable from the AC outlet.
- Disconnect the mains plug to shut off when find troubles or not in use.
- The mains plug shall remain readily operable.
- Read both manual instructions to ensure correct and safe installation and interconnection of the unit in multimedia systems.
- Keep the distances 20 cm around apparatus of ventilation openings.

A NOTE ABOUT RECYCLING

This product's packaging materials are recyclable and can be reused. Please dispose of any materials in accordance with your local recycling regulations.

This product consists of materials which can be recycled and reused if disassembled by a specialised company.

Batteries should never be thrown away or incinerated but disposed of in accordance with your local regulations concerning chemical wastes.



Make your contribution to the environment!!!

- Exhausted batteries do not belong in the dustbin.
- You can dispose of them at a collection point for exhausted batteries or special waste.
- Contact your council for details.



For Customer Use:
Carefully read the Model No. and Serial No. located at the back of the unit and enter the information below. Retain this information for future reference.

Model No. _____
Serial No. _____

Installation Location

For safety and optimum performance of this unit:

- Install the unit in a horizontal and stable position.
- Do not place anything directly on top of the unit.
- Do not place the unit directly on top of the TV.
- Shield the unit from direct sunlight and keep away from sources of intense heat. Avoid dusty or humid locations. Avoid locations with insufficient ventilation for suitable heat dissipation. Do not block the ventilation holes on the sides of the unit. Avoid locations subject to strong vibration or strong magnetic fields.

Avoid the Hazards of Electrical Shock and Fire

- Do not handle the mains cable with wet hands.
- Do not pull on the mains cable to disconnect it from AC outlet. Grasp it by the plug.
- If, by accident, water is spilled on the unit, unplug the mains cable immediately and take the unit to an authorised service centre for servicing.

Moisture Condensation Warning

Moisture condensation may occur inside the unit when it is moved from a cold place to a warm place, after heating a cold room, or under conditions of high humidity. Do not use the unit for at least 2 hours to allow the inside to dry.

About Copyright

Unauthorised copying, broadcasting, public performance and lending of discs are prohibited. This product incorporates copyright protection technology that is protected by U.S. patents and other intellectual property rights. Use of this copyright protection technology must be authorised by Macrovision, and is intended for home and other limited viewing uses only unless otherwise authorised by Macrovision. Reverse engineering or disassembly is prohibited.

Introduction

Connections

Basic Setup

Recording

Playback

Editing

Function Setup

VHS Functions

Others

Notice for the Progressive Scan Outputs

Consumers should note that not all high definition television sets are fully compatible with this product and may cause artifacts to be displayed in the picture. In case of picture problems with 480 or 576 progressive scan output, it is recommended that the user switch the connection to the 'standard definition' output. If there are questions regarding your TV set compatibility with this 480p or 576p product, please contact our customer service centre.



Manufactured under license from Dolby Laboratories. Dolby and the double-D symbol are trademarks of Dolby Laboratories.

"Dolby® Digital Stereo Creator enables consumers to create stereo DVD-Videos with stunning Dolby Digital sound tracks at home. The technology, when utilised instead of PCM recording, also saves recordable disc space, allowing for higher video resolution or extended recording time on each DVD. DVDs mastered using Dolby Digital Stereo Creator will play back on all DVD-Video players."

Note: This is true when the players are compatible with actual recordable DVD discs.



Manufactured under license under U.S. Patent #: 5,451,942 & other U.S. and worldwide patents issued & pending. DTS and DTS Digital Out are registered trademarks and the DTS logos and Symbol are trademarks of DTS, Inc. © 1996-2007 DTS, Inc. All Right Reserved.



HDMI, the HDMI logo and High-Definition Multimedia Interface are trademarks or registered trademarks of HDMI Licensing LLC.



DivX, DivX Certified, and associated logos are trademarks of DivX, Inc. and are used under license.



DVB is a registered trademark of the DVB project

EU Conformity Statement



"This product is marked with "CE" and complies therefore with the applicable harmonized European standards listed under the Low Voltage Directive 2006/95/EC and the EMC Directive 2004/108/EC."

Responsible for CE-marking is
TOSHIBA INFORMATION SYSTEMS (U.K.) LTD,
Toshiba Court, Weybridge Business Park,
Addlestone Road, Weybridge,
Surrey, KT15 2UL, United Kingdom

Maintenance

CLEANING THE UNIT

Use a soft cloth slightly moistened with a mild detergent solution. Do not use solutions containing alcohol, spirits, ammonia or abrasive.

CLEANING DISCS

If a disc becomes dirty, clean it with a cleaning cloth. Wipe the disc from the centre out. Do not wipe in a circular motion.

Do not use solvents such as benzene, thinner, commercially available cleaners, detergent, abrasive cleaning agents or antistatic spray intended for analogue records.

DISC HANDLING

Handle the discs so that fingerprints and dust do not adhere to the disc surfaces.

Always store the disc in its protective case when it is not in use.

HDD HANDLING

• HDD is a precision apparatus that is susceptible to vibration, strong impact or dirt. Depending on the installation environment or handling, the unit may become partially damaged or in the worst case, recording or replaying may not be available.

Especially while the HDD is in motion, do not subject it to vibration or strong impact or pull out the power plug. And if a power failure occurs, the content of the recording / replaying programme may be lost.

• HDD rotates at high speed when in operation. Be sure that rotation has stopped and then move the unit without subjecting it to strong impact or vibration.

SERVICING

If the unit becomes inoperative, do not try to correct the problem by yourself. There are no user serviceable parts inside. Turn the unit off, unplug the mains cable, and consult your dealer or an authorised service centre.

CLEANING THE DISC LENS

If the unit does not perform correctly even though you have referred to "Troubleshooting" and the relevant sections in the Owner's Manual, the laser optical pickup unit may be dirty. Consult your dealer or an authorised service centre for inspection and cleaning of the laser optical pickup unit.

AUTO HEAD CLEANING

- Automatically cleans video heads as you insert or remove a cassette, so you can see a clear picture.
 - Playback picture may become blurred or interrupted while the TV programme reception is clear. Dirt accumulated on the video heads after a long period of use, or the usage of rental or worn tapes can cause this problem. If a streaky or snowy picture appears during playback, the video heads in the unit may need to be cleaned.
- 1 Please visit your local Audio / Video store and purchase a good quality VHS Video Head Cleaner.
 - 2 If a Video Head Cleaner does not solve the problem, please consult your dealer or an authorised service centre.

Note

- Remember to read the instructions along with the video head cleaner before use.
- Clean video heads only when problems occur.

Accessories Supplied

- Remote control with two R6 (AA) batteries



- RF cable

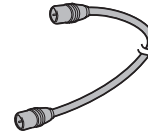

- Owner's Manual

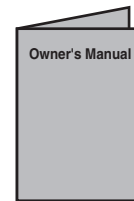

- Quick Setup Guide

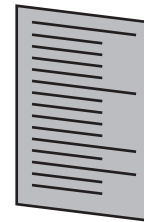

Introduction

Connections

Basic Setup

Recording

Playback

Editing

Function Setup

VHS Functions

Others

Table of Contents

Introduction	2	Playback	60
Precautions	2	Basic Playback	60
Features	7	PBC Function for Video CDs	65
Guide to the Owner's Manual	8	Special Playback	66
Functional Overview	11	Search	70
Installing Batteries in the Remote Control	14	Repeat / Random / Programme Playback / Slide Show	72
Switching HDD / DVD / VHS mode	15	Selecting the Format of Audio and Video	73
Guide to On-Screen Displays	15		
Front Panel Display Guide	19		
		Editing	75
Connections	20	Guide to a Title List	75
Connections	20	Editing Discs	75
		Deleting Selected Titles	77
		Deleting All Titles in HDD	83
Basic Setup	24	Function Setup	84
Initial Setting	24	Playback	86
Channel Setting	25	Display	89
TV View Operation	32	Video	90
DVB Menu Setting	34	DivX®	91
Selecting the On-Screen Display (OSD) Language	35	HDMI	91
Setting the Clock	36	Reset All	92
Recording	37	VHS Functions	93
Information on DVD Recording	37	Playback	93
Formatting a Disc	39	Recording and One-touch Timer Recording (OTR)	93
Selecting the Sound Mode	41	Search	94
Basic Recording	43	Other Operations	95
One-touch Timer Recording (OTR)	44	Changing the Video Colour System	95
Timer Recording	44	Hi-Fi Stereo Sound System	95
Timer Recording (EPG)	48		
Satellite Link	49		
Settings for External Equipment	50		
Information on DV Dubbing	51	Others	96
DVC to HDD / DVD Dubbing	52	Troubleshooting	96
Information on Dubbing	53	Language Code	101
Setting a Disc to Protect	58	Glossary	102
Finalising Discs	59	Specifications	103

Features

The following features are available with this unit.

Recording

This unit allows you to record on the HDD, a DVD-RW/+RW (rewritable) and a DVD-R/+R (one-time write). Also, this unit allows you to record to a videotape. You can choose either one for your convenience.

HDD

DVD

VHS

Recording up to 36 programmes (HDD/DVD):

You can programme the unit to record up to 36 programmes, up to a month in advance. Daily or weekly programme recordings are also possible.

One-touch Timer Recording:

[Page 44] (HDD/DVD) or [Page 94] (VHS)

You can set your required recording time easily. Every time [REC] is pressed during recording, the recording time will be increased by 30 minutes up to 8 hours. It will be turned off automatically when the recording time you set is finished.

Left channel stereo recording:

This unit can record the sound of the Left channel monaural input as Left and Right channels automatically (available only for AV3 jacks on the front panel).

HDD

DVD

Automatic Chapter mark setting: [Page 40]

Chapter marks will be added to recordings as you set them in "Setup" menu before starting to record.

Automatic Playlist making:

The unit creates a Playlist automatically after recording.

HDD

160 GB hard disc:

This unit is equipped with a 160GB hard disc which allows you to record up to 267 hours (with SLP mode).

VPS/PDC: [Page 46]

This system assures that the TV programme you want to record using timer recording will be recorded exactly from beginning to end even if the actual broadcasting time differs. This feature is only available for analogue channels.

DVD

Alternate recording: [Page 45]

If there is no recordable disc in the unit, if the disc does not have enough space to complete the recording, or if the material is "copy-once" programme and prohibited to be recorded on a DVD in the unit, the unit will detect it and automatically record to the HDD even when DVD is selected as the recording media. This feature is available only for timer recording. Not available for one-touch timer recording.

Automatic finalising: [Page 59]

You can finalise discs automatically at the end of the disc space if you set this in "Setup" menu.

Automatic Title menu making: [Page 59]

The unit creates Title menus automatically when finalising discs.

Dubbing

With this unit, you can enjoy bi-directional dubbing with HDD, DVD or VHS.

HDD

DVD

High speed dubbing: [Page 53]

This feature offers you the dubbing speed of 32 times the SLP mode dubbing at the maximum.

Auto recording mode dubbing: [Page 53]

When dubbing, if you set the recording mode to "Auto", the recording mode will automatically be adjusted so the titles will fit nicely in the remaining space of the disc.

HDD

DVD

VHS

DV dubbing:

[Pages 51 - 52] (HDD/DVD) or

[Page 94] (VHS)

This function helps you to easily dub the contents of the DVC (digital video camcorder) to HDD/DVD/VHS.

Playback

HDD

DVD

Theatre surround sound: [Page 23]

When the unit is connected to an amplifier or a decoder compatible with Dolby Digital or DTS, you can enjoy theatre-quality surround sound from discs recorded with the surround sound system.

Quick search: [Pages 70 - 71]

You can easily find the part you want to watch using the search function. Search for a desired point on a disc by title, chapter / track or time.

Variable skip: [Page 67]

You can skip forward a certain time, which is specified in "Playback" menu in advance, with one-touch during playback.

Variable replay: [Page 67]

You can skip back a certain time, which is specified in "Playback" menu in advance, with one-touch during playback.

Playback from Original or a Playlist:

You can play back titles using either the Original list or a Playlist.

Virtual Surround System: [Page 74]

You can enjoy stereophonic space through your existing 2 channel stereo system.

HDD

Chasing Playback during Recording and Simultaneous Playback and Recording:

[Pages 69 - 70]

You can play the already recorded part of the current recording or another title during recording.

Pausing a TV broadcast to resume later (Pause TV): [Pages 69 - 70]

With [TIME SLIP], you can virtually pause and resume the live TV broadcast.

DVD

Playing back MP3 / JPEG / DivX® files:

[Pages 61 - 64]

You can enjoy MP3 / JPEG / DivX® files which are recorded on CD-RW/-R.

DivX® files can also be recorded on DVD-RW/-R and DVD+RW/+R discs.

Introduction

Connections

Basic Setup

Recording

Playback

Editing

Function Setup

VHS Functions

Others

VHS**Quick search:** [➔ Pages 94 - 95]

You can easily find the part you want to watch using the Index or Time search functions. An index mark will be assigned at the beginning of each recording you make. For Time search function, you can go to a specific point on a tape by entering the exact amount of time you want to skip.

Editing**HDD****DVD****Adding or Deleting Chapter Marks Manually:**

[➔ Pages 78 - 79]

You can add or delete chapter marks manually.

Creating Titles to a Playlist: [➔ Page 81]

You can create a title to the Playlist.

Deleting Titles: [➔ Page 76]

You can delete titles which you do not need anymore.

Deleting a Scene of a Title: [➔ Pages 82 - 83]

You can delete a specific scene of a title.

Editing title name: [➔ Pages 77 - 78]

You can name titles or change the title name.

Combining Titles: [➔ Page 81]

You can combine two titles into a single title.

Dividing Titles: [➔ Pages 80 - 81]

You can divide a title into two new titles.

Protecting titles: [➔ Page 80]

To avoid accidental editing or erasing of titles, the protect function is useful when set to "ON" in the Original list.

DVD**Adding or Deleting chapter marks at once (Video mode DVD-RW only)**

[➔ Page 79]

You can easily add chapter marks at every selected time interval or delete all chapter marks at once for easy editing.

Hiding chapters: [➔ Pages 79 - 80]

To keep others from playing back some chapters without permission, you can hide chapters.

Compatibility**DVD****Playing back discs recorded in Video mode in any regular DVD player:** [➔ Page 59]

Discs recorded in Video mode can be played back in regular DVD players, including computer DVD drives compatible with DVD-Video playback. You will need to finalise the discs recorded in Video mode to play back in other DVD players.

Although DVD+RW / +R discs are playable in other units without finalisation in most cases, it is recommended to finalise in order to stabilise the performance.

* DVD-Video Format (Video mode) is a new format for recording on DVD-RW/-R discs that was approved by the DVD Forum in 2000. Adoption of this format is optional for manufactures of DVD playback devices and there are DVD-Video players, DVD-ROM drives and other DVD playback devices available that cannot play back DVD-RW/-R discs recorded in the DVD-Video Format.

Others**HDD****DVD****Progressive scan system:** [➔ Pages 21, 90]















Unlike conventional interlace scanning, the progressive scan system provides less flickering and images in higher resolution than that of traditional television signals.

HDMI: [➔ Pages 21, 91 - 92]**(High-Definition Multimedia Interface)**

You can enjoy clearer audio/video output when connecting this unit to a display device with an HDMI-compatible port.

Guide to the Owner's Manual**Symbols Used in the Owner's Manual**

To show what recording mode or disc type applies to each function, the following symbols appear at the beginning of each operating item.











Symbol	Description
	Available to (internal) HDD
	Available to DVD-Videos
	Available to DVD-RW discs in Video mode
	Available to DVD-RW discs in VR mode
	Available to DVD-R discs in Video mode
	Available to DVD+RW discs
	Available to DVD+R discs
	Available to Audio CDs
	Available to Video CDs
	Available to CD-RW/-R discs with MP3 files
	Available to CD-RW/-R discs with JPEG files
	Available to DVD-RW/-R, DVD+RW/+R and CD-RW/-R discs with DivX® files
	Available to VHS tapes Use only cassettes marked VHS 

Symbols for Tuner Setting

The following is the description for the symbols for tuner setting used in this manual.

ANALOG : Settings only for the Analogue mode

DVB : Settings only for the DVB mode

		Medias for Recording / Playing						
Disc Type		DVD-RW		DVD-R	DVD+RW	DVD+R	HDD	
Logo								
Format		Can be formatted in VR or Video mode		Automatically formatted in Video mode	Automatically formatted in +VR mode	Automatically formatted in +VR mode	-	
Icon		Video Mode 	VR Mode 					
Maximum Record Time		480 min (12 cm) 144 min (8 cm)	480 min (12 cm) 144 min (8 cm)	480 min (12 cm) 144 min (8 cm)	480 min (12 cm) 144 min (8 cm)	480 min (12 cm) 144 min (8 cm)	267 hrs (with SLP mode)	
Recordable/Playable Versions		Ver. 1.1, 1.2 Ver. 1.1/2x CPRM compatible Ver. 1.2/4x CPRM compatible		Ver. 2.0 Ver. 2.0/4x Ver. 2.0/8x Ver. 2.0/16x	1x-4x	1x-16x	-	
Compatibility		Playable on most DVD players. Finalisation necessary. (Title menu will be created)	Playable only on VR mode compatible unit. Finalisation recommended.	Playable on most DVD players. Finalisation necessary. (Title menu will be created)	Playable on DVD+RW compatible players. Finalisation recommended. (Title menu will be created)	Playable on most DVD players. Finalisation recommended. (Title menu will be created)	-	
Available Features	Recording Features							
	Record TV Programmes	✓	✓	✓	✓	✓	✓	✓
	Reuse by Deleting the Current Contents	✓	✓	Gray	✓	Gray	✓	✓
	Record 16:9 Size Pictures	✓	✓	✓	Gray	Gray	✓	✓
	Record Copy-once Programmes	Gray	✓*	Gray	Gray	Gray	✓	✓
	Create Chapters at Fixed Intervals (auto chapter)	✓	✓	✓	✓	✓	✓	✓
	Editing Features							
			Playlist	Original			Playlist	Original
	Scene Delete	Gray	✓	✓	Gray	Gray	✓	✓
	Edit Title Name	✓	✓	✓	✓	✓	✓	✓
	Create Chapters Wherever You Like (chapter mark)	Gray	✓	✓	Gray	✓	✓	✓
	Divide a Title	Gray	✓	Gray	Gray	✓	✓	✓
	Combine Titles	Gray	✓	Gray	Gray	Gray	✓	Gray
	Hide Chapters	Gray	Gray	Gray	Gray	✓	✓	Gray
Delete a Title	✓	✓	✓	✓	✓	✓	✓	
Deleting Selected Titles	Gray	Gray	Gray	Gray	Gray	✓	✓	
Create a Playlist	Gray	Gray	✓	Gray	Gray	Gray	✓	
Protect a Title	Gray	Gray	✓	Gray	Gray	Gray	✓	

✓: Available

Gray: Not available

* CPRM compatible disc only.

Because of problems and errors that can occur during the creation of DVD and CD software and/or the manufacture of DVD and CD discs, Toshiba cannot guarantee that product will play every feature of every DVD bearing the DVD logo and/or every CD bearing the CD logo. As one of the creators of DVD technology, Toshiba DVD players are manufactured using the highest standards of quality, and as a result, such incompatibilities are rare.

DVD players with  are capable of playing DVD-RW recorded in VR mode.

Introduction

Connections

Basic Setup

Recording

Playback

Editing

Function Setup

VHS Functions

Others

Discs for Playing					
Disc Type	DVD-VIDEO	CD-DA	Video CD	CD-RW	CD-R
Logo					
Icon					
Files for Playing					
Type of title	MP3	JPEG	DivX®		
Icon					
Media	CD-RW/-R	CD-RW/-R	CD-RW/-R DVD-RW/-R DVD+RW/+R		

DVD is a trademark of DVD Format/Logo Licensing Corporation.

- Official DivX® Certified product
- Plays all versions of DivX® video (including DivX® 6) with standard playback of DivX® media files.
- Discs containing the DivX® files with the DivX® GMC (Global Motion Compensation) playback feature, which is DivX® supplemental function, cannot be played back on this unit.

Unplayable Discs

The following discs will not play back on this unit.

- CD-ROM
 - Compact Disc-Interactive (CD-I)
- Video Single Disc (VSD)
- DVD-ROM
 - Unfinalised disc
- DVD contains MP3, Windows Media™ Audio or JPEG files
- DVD-RW/-R recorded in non compatible recording format
- Blu-ray Disc
 - HD DVD

On the following disc, the sound may not be heard.

- Super audio CD - Only the sound on the CD layer can be heard. The sound on the high-density super audio CD layer cannot be heard.

Colour Systems

DVDs are recorded using different colour systems throughout the world. The most common colour system, used primarily in the U.K. and other EU countries, is PAL.

This unit uses the PAL system. However, it is also possible to play back DVDs using other colour systems, such as NTSC.

Region Codes

This unit has been designed to play DVD with region 2. DVD must be labelled for ALL regions or for region 2 in order to play on the unit. You cannot play back DVD that are labelled for other regions. Look for the symbols on the right on your DVD, if these region symbols do not appear on your DVD, you cannot play back the DVD in this unit. The number inside the globe refers to region of the world.



A DVD labelled for a specific region can only play back on the unit with the same region code.

Following discs are recommended for good recording quality and are proven to be compatible with this unit. However, depending on the media condition the unit may not read the disc properly.

- | | |
|----------|--|
| Verbatim | DVD+R 8x, DVD+RW 4x, DVD-R 8x, DVD-RW 2x |
| JVC | DVD-RW 4x |
| Maxell | DVD+R 4x/8x/16x, DVD-R 8x/16x |
| SONY | DVD+R 4x/8x/16x, DVD+RW 4x |
| TDK | DVD+R 4x/8x/16x |

Performance of any other discs are not guaranteed.

- Toshiba is not liable for any damage or loss caused directly or indirectly by the malfunction of this recorder, including, without limitation, any one of the following:
 - Failure to record contents intended to be recorded by the consumer.
 - Failure to edit contents as intended by the consumer.
 - When a DVD-RW/-R, DVD+RW/+R disc created on this recorder is used (e.g., insertion, playback, recording or editing) in another DVD player, recorder or personal computer drive.
 - When a DVD-RW/-R, DVD+RW/+R disc that is used in the manner described in the immediately preceding bullet point is used again in this recorder.
 - When a DVD-RW/-R, DVD+RW/+R disc that was recorded in another DVD recorder, or in a personal computer drive is used in this recorder.
- Some functions may not work with personal computer discs.
- Discs recorded in this recorder may not operate as expected on other DVD players, recorders or personal computer drives.

Functional Overview

Front Panel

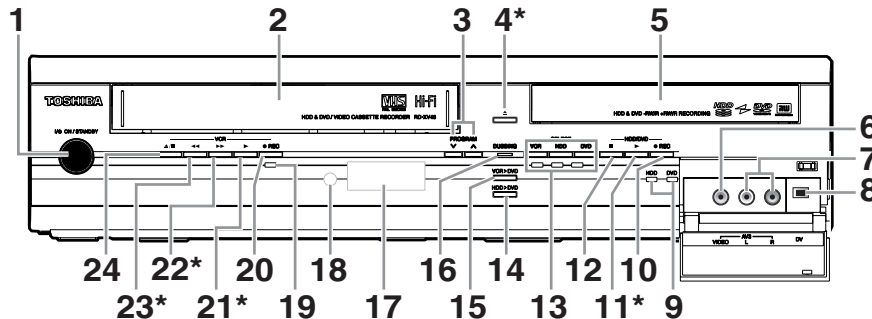

(*) You can also turn on the unit by pressing these buttons.

- 1 I/O ON/STANDBY button**
 - Press to turn the unit on and off.
- 2 Cassette compartment**
 - Insert a tape here.
- 3 PROGRAM \wedge / \vee buttons**

HDD/DVD: Press to change the channel up or down.

VHS : Press to change the channel up or down. Press to adjust the tracking during playback or in slow motion of the tape. While playback is in still mode, you can adjust the vertically blurred picture.
- 4 \blacktriangle (OPEN/CLOSE) button* (DVD)**
 - Press to open or close the disc tray.
- 5 Disc tray**
 - Place a disc when the disc tray is opened.
- 6 VIDEO input jack (AV3)**
 - Connect the video output of an external device here using a commercially available Video cable.
- 7 AUDIO input jacks (AV3)**
 - Connect the audio output of an external device here using a commercially available Audio (L / R) cable.
- 8 DV input jack (AV4)**
 - Use to connect the DV output of external device with a DV cable.
- 9 REC indicators (HDD/DVD)**
 - Lights up during HDD/DVD recording.
- 10 \bullet REC button (HDD/DVD)**
 - Press once to start a recording. Press repeatedly to start one-touch timer recording. Each press increases the recording time by 30 minutes up to 8 hours.
- 11 \blacktriangleright (PLAY) button* (HDD/DVD)**
 - Press to start or resume playback.
- 12 \blacksquare (STOP) button (HDD/DVD)**
 - Press to stop playback, recording or dubbing.
- 13 Device Select Buttons / Indicators**

VHS: Press to activate the VCR. Lights up when VCR is selected.

HDD: Press to activate the HDD. Lights up when HDD is selected.

DVD: Press to activate the DVD. Lights up when DVD is selected.
- 14 DUBBING HDD \blacktriangleright DVD button**
 - Press to start One Touch Dubbing from HDD to DVD.
- 15 DUBBING VCR \blacktriangleright DVD button**
 - Press to start One Touch Dubbing from VCR to DVD.
- 16 DUBBING indicator**
 - Lights up during dubbing
- 17 Display**
 - Shows information and messages. Refer to "Front Panel Display Guide" on page 19.
- 18 Infrared sensor window**
 - Receive signals from your remote control so that you can control the unit from a distance.
- 19 REC indicator (VHS)**
 - Lights up during VCR recording.
- 20 \bullet REC button (VHS)**
 - Press once to start a recording. Press repeatedly to start one-touch timer recording. Each press increases the recording time by 30 minutes up to 8 hours.
- 21 \blacktriangleright (PLAY) button* (VHS)**
 - Press to start playback. Press to turn on the unit to start playback.
- 22 $\blacktriangleright\blacktriangleright$ (FWD) button* (VHS)**
 - Press to fast forward or fast search. Press to turn on the unit to fast forward.
- 23 $\blacktriangleleft\blacktriangleleft$ (REV) button* (VHS)**
 - Press to rewind or rewind search.
 - Press to turn on the unit to rewind.
- 24 \blacktriangle / \blacksquare (EJECT/STOP) button (VHS)**
 - Press to stop playback, recording or dubbing.
 - Press to eject the videotape.

Button names described in the Owner's Manual

The instructions in this manual are described mainly with the operations using the remote control. Some operations can be carried out using the buttons on the front panel.

Rear Panel

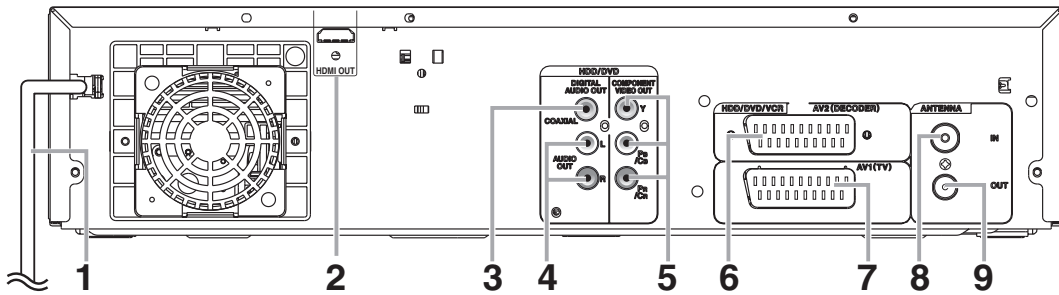

- 1 Mains cable**
 - Connect to a standard AC outlet.
- 2 HDMI OUT jack (HDD/DVD)**
 - Connect to a display with an HDMI compatible port. Use a commercially available HDMI cable.
- 3 DIGITAL AUDIO OUT (COAXIAL) jack (HDD/DVD)**
 - Connect to an amplifier with a digital input jack such as a Dolby Digital decoder, DTS decoder or MPEG decoder. Use a commercially available Coaxial cable.
- 4 AUDIO OUT (L/R) jacks (HDD/DVD)**
 - Connect to the audio input jacks on your TV. Use a commercially available Audio cable.
- 5 COMPONENT VIDEO OUT jacks (HDD/DVD)**
 - Connect to the component video input jacks on your TV. Use a commercially available Component Video cable.
- 6 AV2 (DECODER) socket (HDD/DVD/VHS)**
 - Connect to VCR, camcorder, or other Audio-Video equipment. Use a commercially available Scart cable.
- 7 AV1 (TV) socket (HDD/DVD/VHS)**
 - Connect to the Scart socket on your TV. Use a commercially available Scart cable.
- 8 ANTENNA IN**
 - Connect to an antenna or a cable.
- 9 ANTENNA OUT**
 - Connect to the Aerial jack on your TV, cable box or direct broadcast system to output the signal received at ANTENNA IN. Use the supplied RF cable.

Note

- Do not touch the inner pins of the jacks on the rear panel. Electrostatic discharge may cause permanent damage to the unit.
- **This unit does not have an RF modulator.**

Remote Control

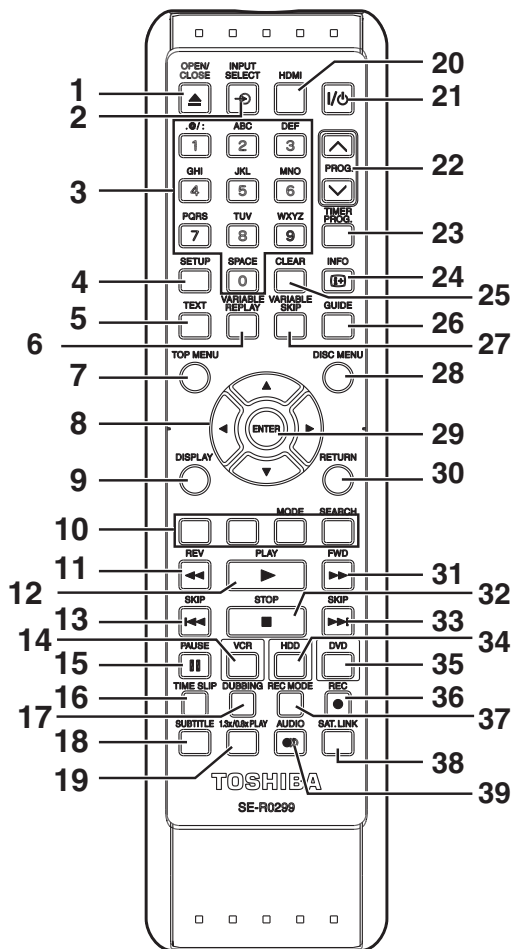

- 1 OPEN/CLOSE \blacktriangle button (DVD/VHS)**
 - Press to open or close the disc tray.
 - Press to remove the videotape from the unit.
- 2 INPUT SELECT \curvearrowright button**
 - Press to select the DVB, analogue mode or appropriate input.
- 3 Number buttons**
 - Press to select channel numbers.
 - Press to select a title / chapter / track on the display.
 - Press to enter values for settings in "Setup" menu.
 - Press to enter the characters in edit function.
- 4 SETUP button**
 - Press to display "Setup" menu in stop mode.
- 5 TEXT button**
 - Press to switch Teletext on or off.
- 6 VARIABLE REPLAY button (HDD/DVD)**
 - Replays by the amount of time set in advance.
- 7 TOP MENU button (HDD/DVD)**
 - Press to display the Title list.
- 8 Direction \blacktriangle / \blacktriangledown / \blacktriangleleft / \blacktriangleright buttons**
 - Press to move the cursor and determine items or settings.
- 9 DISPLAY button**
 - Press to display the On-Screen Display.

- 10 RED/GREEN/YELLOW/BLUE button**
 - Press to follow the DVB instruction displayed on-screen.
- MODE (YELLOW) button (VHS)**
 - Press to change the video colour system.
- SEARCH (BLUE) button (VHS)**
 - Press to call up the index or time search menu.
- 11 REV \blacktriangleleft button (HDD/DVD)**
 - During playback, press to fast reverse.
 - When playback is paused, press to reverse slowly.
- (VHS)**
 - Press to rewind the videotape.
 - Press to view the picture rapidly in reverse during the playback mode.
- 12 PLAY \blacktriangleright button**
 - Press to start or resume playback.
- 13 SKIP \blacktriangleleft button (HDD/DVD)**
 - During playback, press twice in quick successions to skip to the previous chapter or track.
 - When playback is paused, press to play reverse step by step.
- 14 VCR button**
 - Press to select the VCR output mode.
- 15 PAUSE \parallel button**
 - Press to pause playback or recording.
- 16 TIME SLIP button (HDD)**
 - Press to virtually pause and resume the live TV broadcast.
- 17 DUBBING button**
 - During playback, press to start dubbing right away.
 - In stop mode, press to display "Dubbing" menu.
- 18 SUBTITLE button**
 - During playing back DVD or watching a DVB channel which has subtitle information, press to call up the Subtitle menu.
- 19 1.3x/0.8x PLAY button (HDD/DVD)**
 - During playback, press to playback in a slightly faster/slower speed.
- 20 HDMI button**
 - Press to set the HDMI connector's video signal output mode.
- 21 I/O ON/STANDBY button**
 - Press to turn on or off the unit.
- 22 PROG. \wedge / \vee buttons**
 - Press to change the channel up or down.
- 23 TIMER PROG. button**
 - Press to display the timer programme setting menu.
- 24 INFO $\text{i}+$ button**
 - Press to display the DVB programme information.
- 25 CLEAR button (HDD/DVD)**
 - Press to clear the password once entered.
 - Press to cancel the programming for a disc.
 - Press to clear the selecting marker number in the marker setup mode.
 - Press to clear the programme once entered in the CD programme playback mode.
- (VHS)**
 - Press to reset the tape counter.
- 26 GUIDE button**
 - Press to call up the EPG list in DVB mode.

27 VARIABLE SKIP button (HDD/DVD)

- Skips by the amount of time set in advance.

28 DISC MENU button (HDD/DVD)

- Press to display the Disc menu during playback.
- Press to change the Original and Playlist on the TV screen.

29 ENTER button

- Press to acknowledge or approve a menu selection.
- While watching a DVB channel, press to display the "Quick select" menu.

30 RETURN button

- Press to return to the previously displayed menu screen.

31 FWD ►► button

- When playback is paused, press to forward slowly. (HDD/DVD)
- During playback, press to fast forward. (VHS)
- Press to advance the videotape rapidly.
- Press to view the picture rapidly in forward during playback.

32 STOP ■ button

- Press to stop playing back or recording.

33 SKIP ►►| button (HDD/DVD)

- During playback, press to skip to the next chapter or track.
- When playback is paused, press to advance step by step.

34 HDD button

- Press to select the HDD output mode.

35 DVD button

- Press to select the DVD output mode.

36 REC ● button

- Press once to start a recording.
- Press repeatedly to start a One-touch Timer Recording.

37 REC MODE button

- Press to switch the recording mode.

38 SAT.LINK button (HDD)

- Press to activate the Satellite Link Timer Recording.

39 AUDIO ◯ button

- For analogue channels when receiving a bilingual broadcast, press to change the audio out setting to "Main", "Sub" or "Main/Sub".
- Press to change the bilingual audio source of an external equipment to "Main", "Sub" or "Main/Sub". (Available only when the "External Input Audio" in "Setup" menu is set to "Bilingual" in advance.)
- Press to select the sound mode for DVB channels. (HDD/DVD)
- Press to display the audio menu during playback. (VHS)
- During playback of Hi-Fi videotape, press to change the audio out setting to "STEREO", "LEFT", "RIGHT" and "MONO".

Button names described in the Owner's Manual
The instructions in this manual are described mainly with the operations using the remote control. Some operations can be carried out using the buttons on the front panel.

Note

- If you turn off this unit, [OPEN/CLOSE ▲] on the remote control is not available. Be sure to use [▲ OPEN/CLOSE] or [▲ / ■ EJECT/STOP] on the unit.

Installing Batteries in the Remote Control

Install two R6 (AA) batteries (supplied) into the remote control, carefully match with the polarity indicated inside the battery compartment.

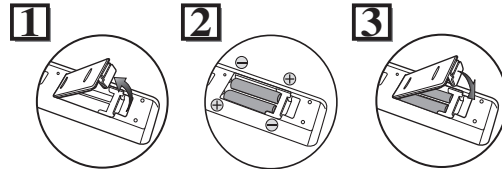
**Caution**

- Incorrect use of batteries can result in hazards such as leakage and bursting.
- Do not mix new and old batteries together.
- Do not use different kinds of batteries together.
- Make sure that the plus (+) and minus (-) ends of each battery match the indications inside the battery compartment.
- Remove batteries if the equipment will not be used for a month or more.
- When disposing used batteries, please comply with governmental regulations or the public instructions for environmental protection that apply in your country or area.
- Do not recharge, short-circuit, heat, burn or disassemble batteries.

About the Remote Control

- Make sure there is no obstacle between the remote control and the remote control sensor on the unit.
- Use within the operating range and angle as shown.

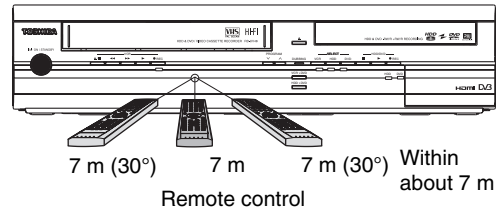

- The maximum operable range as follows:

Line of sight: approximately 7 m
Either side of centre: approximately 7 m within 30 degrees

- Remote control operation may become unreliable if the remote control sensor of the unit is being exposed by the strong sunlight or fluorescent light.
- Remote controls for different devices can interfere with each other. Be careful when using remote controls for other equipment located close to the unit.
- Replace the batteries when the operating range of the remote control reduces.

Switching HDD / DVD / VHS mode

Because this unit is a combination of an HDD, a DVD and a VHS recorder, you must select which component you want to operate first.

Device Select Indicators

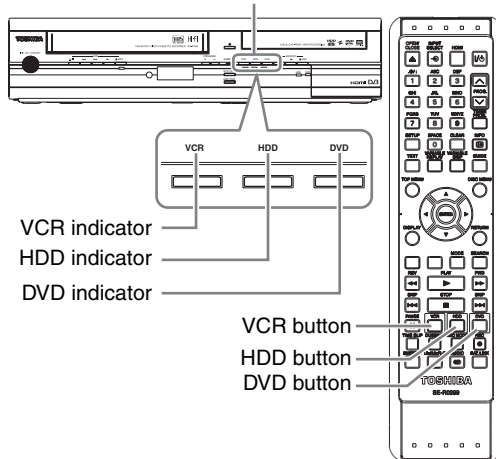

VCR indicator
HDD indicator
DVD indicator

VCR button
HDD button
DVD button

HDD

Press **[HDD]** on the remote control or the front panel. (Verify that the HDD indicator is lit in blue.)

DVD

Press **[DVD]** on the remote control or the front panel. (Verify that the DVD indicator is lit in green.)

VHS

Press **[VCR]** on the remote control or the front panel. (Verify that the VCR indicator is lit in orange.)

Guide to On-Screen Displays

DISPLAY Menu

HDD

DVD

With a disc inserted into the unit, press **[DISPLAY]** to display the On-Screen Display. The menu shows information about what is recorded on the disc.

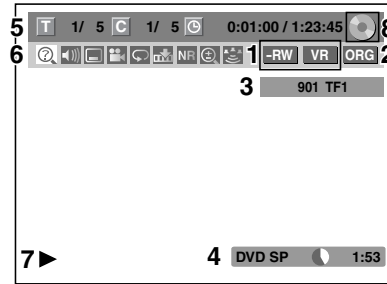

This is an example screen for explanation. Displayed items vary depending on the actual mode.

- 1 Indicates a disc type and format mode. (DVD mode only)**
- 2 Indicates a type of titles for HDD and VR mode DVD-RW disc.**
- 3 Indicates a channel number, station name (analogue channel only) or selected external input mode.**
- 4 Indicates a media, recording mode and possible recording time left.**
- 5 Indicates the current title number/total number of titles, the current chapter number/total number of chapters, and time lapse of the current title playback/total duration of the title.**
- 6 Each icon means:**
 - : Search
 - : Audio
 - : Subtitle
 - : Angle
 - : Repeat
 - : Marker
 - : Noise Reduction
 - : Zoom
 - : Surround
- 7 Indicates an operation status.**
- 8 Indicates the component in use.**
 - : HDD
 - : DVD

Note

- For some descriptions on this manual, only one disc type is indicated as an example.

Introduction

Connections

Basic Setup

Recording

Playback

Editing

Function Setup

VHS Functions

Others

Press **[DISPLAY]** while the On-Screen Display is displayed to display the following information.

<Title / File Name Information>

File name information

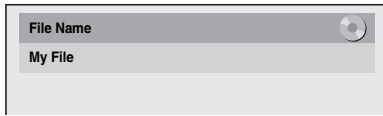

(only when a CD with MP3/JPEG/DivX® files is in playback)

Title name information

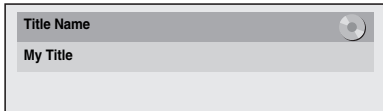

(only when DVD+RW/+R, VR mode DVD-RW/-R, unfinalised Video mode DVD-RW/-R disc or HDD is in playback)

<MP3 Tag Information>

(only when a CD with MP3 files is in playback)

Title name information

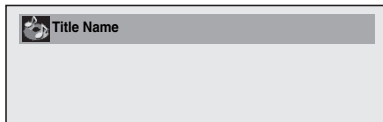

Artist name information

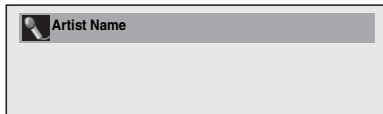

Album name information

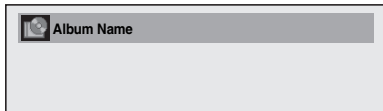

<HDMI Information>

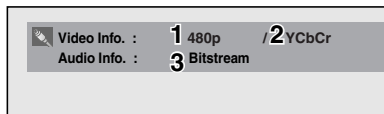

(only for the images output through the HDMI output)

- 1 Indicates the resolution of the HDMI output image.**
- 2 Indicates the HDMI video format.**
- 3 Indicates the HDMI audio format.**
- “- -” will be displayed, when it does not have any information.

VHS

Press **[VCR]** first.

Press **[DISPLAY]** to display the On Screen Display.

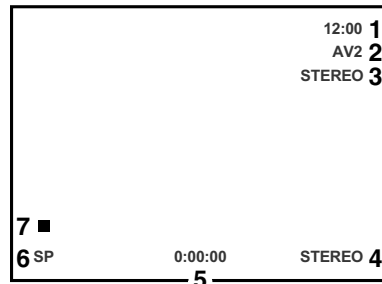

This is an example screen for explanation. Displayed items are depending on the actual mode.

- 1 Current time**
- 2 Position number**
- 3 Audio status of the receiving broadcast or external equipment**
- 4 Audio status of the currently playing back videotape**
- 5 Tape counter**
- 6 Recording or playing back speed**
- 7 Status of the current tape**

While in the VHS mode, the On Screen Display of the VHS mode is displayed.

INFO Menu

DVB

Press **[INFO]** while viewing a DVB programme to display the programme information.

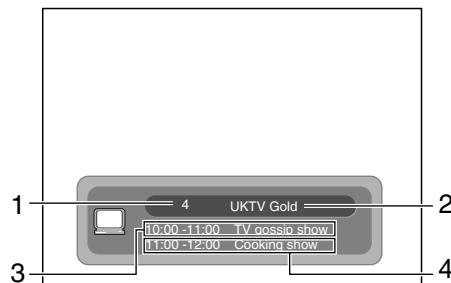

- 1 Channel number**
- 2 Channel name**
- 3 Current programme information**
- 4 Next programme information**

The window will automatically exit after 3 seconds, or press **[INFO]** to exit.

Main Menu

Press **[SETUP]** to display the main menu. Then use **[▲ / ▼]** to select a menu and press **[ENTER]** to display the sub menu. These menus provide entries to all main functions of the unit.

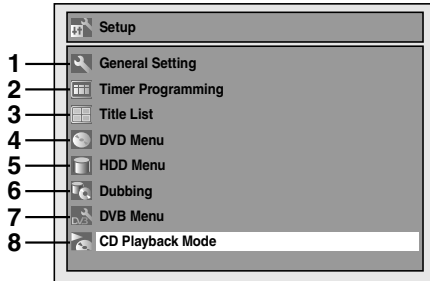

1 General Setting:

To go to General Setting menu.

2 Timer Programming:

To programme a timer recording.

3 Title List:

To call up the title list.

4 DVD Menu:

To set up the DVD disc setting.

5 HDD Menu:

To set up the HDD setting.

6 Dubbing:

- To dub the content of the HDD to DVD or vice versa.
- To dub the content of the HDD to VHS or vice versa.
- To dub the content of the DVD to VHS or vice versa.
- "Dubbing" is available only when a recordable disc or videotape is loaded.

7 DVB Menu:

To set up the DVB setting.

8 CD Playback Mode:

To set up the CD playback setting.

- "CD Playback Mode" is available only when an audio CD, a video CD, a CD-RW/-R with MP3 / JPEG / DivX® files is inserted into the unit.

General Setting

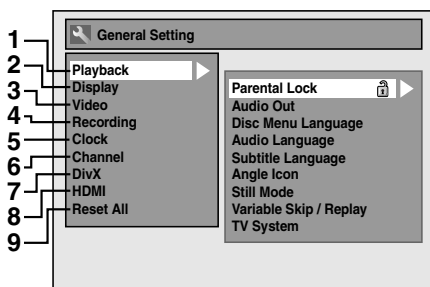

1 Playback:

To set up the unit to play discs as you prefer.

2 Display:

To set up the OSD screen as you prefer.

3 Video:

To set up the video setting.

4 Recording:

To set up the unit to record to discs as you prefer.

5 Clock:

To set up the clock of the unit as you need.

6 Channel:

To adjust the channel setting of the unit as you prefer.

7 DivX:

To set up the setting for the DivX® playback.

8 HDMI:

To set up the HDMI connection setting.

You cannot select if the HDMI cable is not connected.

9 Reset All:

To reset the setting to the factory default.

DVB Menu

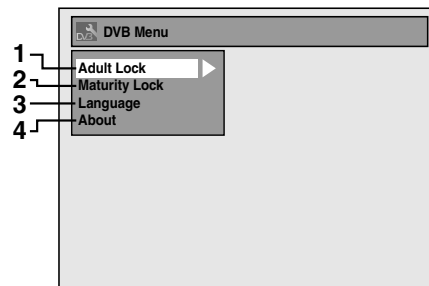

1 Adult Lock:

To set up the Pincode for "Adult Lock".

2 Maturity Lock:

To set the age restriction for DVB programmes.

3 Language:

To set up the language for audio and subtitle.

4 About:

To check the current DVB system software version of this unit.

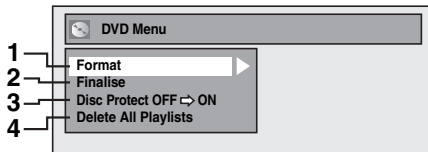
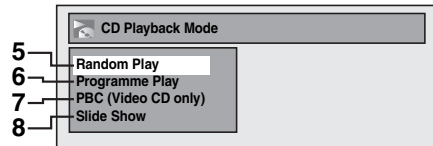
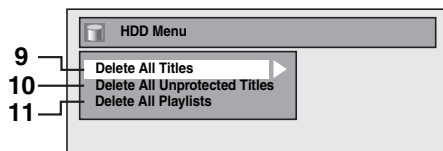
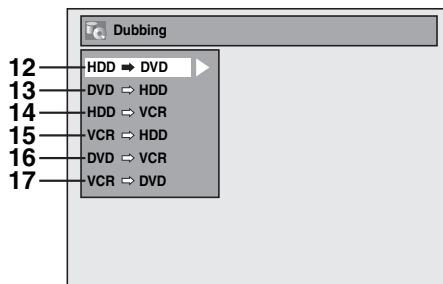
DVD Menu / CD Playback Mode / HDD Menu / Dubbing**<DVD Menu menu>****<CD Playback Mode menu>****<HDD Menu menu>****<Dubbing menu>****1 Format (DVD-RW, DVD+RW only):**

Allows you to format the disc.

2 Finalise:

Allows you to finalise a disc containing recorded titles.

3 Disc Protect (VR mode DVD-RW, DVD+RW/+R disc only):

Allows you to protect a disc from accidental editing or recording.

4 Delete All Playlists (VR mode DVD-RW disc only):

Allows you to delete all Playlists.

5 Random Play:

Allows you to activate the random playback feature.

6 Programme Play (Audio CD/Video CD only):

Allows you to activate the programme playback feature.

7 PBC (Video CD only):

Allows you to select images or information on the menu screen by activating PBC (playback control) function.

8 Slide Show (JPEG files only):

Allows you to select the display time of the slide show mode.

9 Delete All Titles:

Allows you to delete all titles, including the protected titles in the HDD title list.

10 Delete All Unprotected Titles:

Allows you to delete all unprotected titles in the HDD title list.

11 Delete All Playlists:

Allows you to delete all Playlists for HDD.

12 HDD → DVD:

Allows you to dub from HDD to DVD.

13 DVD → HDD:

Allows you to dub from DVD to HDD.

14 HDD → VCR:

Allows you to dub from HDD to VHS.

15 VCR → HDD:

Allows you to dub from VHS to HDD.

16 DVD → VCR:

Allows you to dub from DVD to VHS.

17 VCR → DVD:

Allows you to dub from VHS to DVD.

Front Panel Display Guide

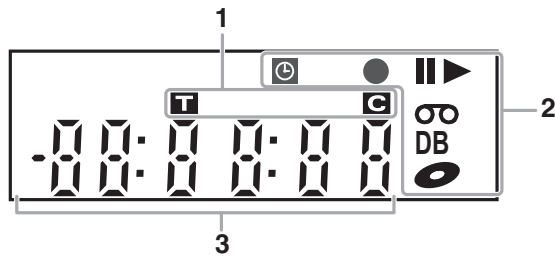

1 Title / Track and Chapter number

- T** : Title / track number
C : Chapter number

2 Current status of the unit

- ||** : Appears when disc playback is paused.
 Appears during step by step playback.
- ▶** : Appears when playing back a disc.
- ||▶** : Appears during slow forward / reverse playback.
- ⏻** : Appears when the timer programming or One-touch Timer Recording (OTR) is set and is operating.
 Appears when the unit goes into the Satellite Link standby mode.
 Flashes when timer programming was not executed because of some error.
- : Appears when recording.
 Flashes when recording being paused.

Ⓛ : Appears when a videotape is in this unit.

Ⓛ : Appears when a disc is in this unit.

DB : Appears during dubbing.

3 Displays the following

- Playing back time
- Current title / chapter / track number
- Recording time / remaining time
- Clock
- Channel number
- One-touch Timer Recording (OTR) remaining time
- Selected HDMI output mode

Display Messages

	The disc tray is opening.		Appears when HDMI output mode (480p) is selected.
	The PBC function of the Video CD is activated.		Appears when HDMI output mode (576p) is selected.
	The disc tray is closing.		Appears when HDMI output mode (720p) is selected.
	A disc is loading.		Appears when HDMI output mode (1080i) is selected.
	Data is being recorded on a disc.		Appears when HDMI output mode (1080p) is selected.
	Appears when the Satellite Link Recording is in standby.		

Connections

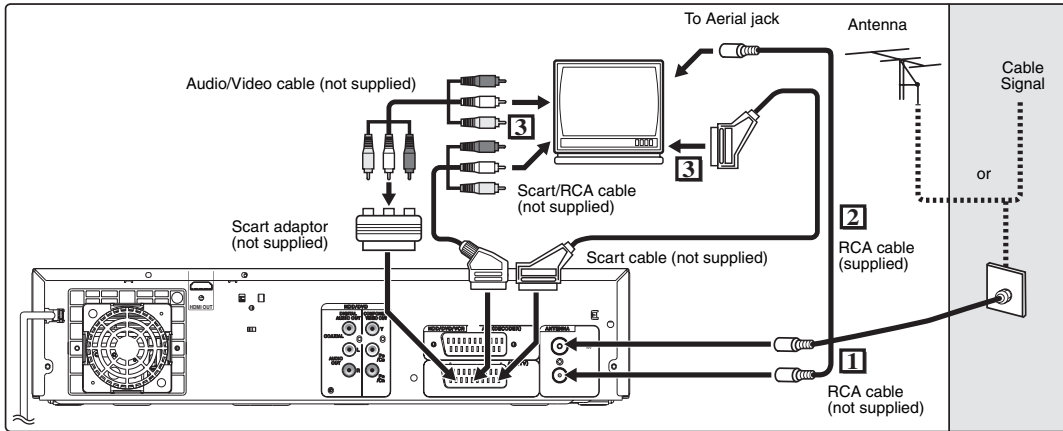

Connections

Connecting to a TV

Connect the unit to a TV after considering the capabilities of your existing equipment.

Before installation, unplug your TV and this unit.

- 1 Connect the antenna or cable to the **ANTENNA IN** jack of this unit.
- 2 Connect the **ANTENNA OUT** jack of this unit to the **Aerial** jack of your TV. Use the supplied RF cable.

Using the Scart socket

- 3 Connect **AV1 (TV) Scart** socket of this unit to the **Scart** socket of your TV. Use a commercially available **Scart** cable.

Note

- If your TV does not have a Scart socket, use a commercially available Scart adaptor or Scart/RCA cable to connect.
- Connect this unit directly to the TV. If the AV cables are connected to a VCR, pictures may be distorted due to the copy protection system.
- When changing the "Video Out" setting ("SCART (RGB)", "Component (Interlace)" or "Component (Progressive)"), connect to the corresponding jack on the TV. If the setting is changed, for example, to "Component (Interlace)" or "Component (Progressive)" while the scart cable is connected to the TV, a distorted video signal may be output.

Using the COMPONENT VIDEO OUT jacks and the AUDIO OUT (L/R) jacks

If your TV has Component Video input jacks, use a Component Video cable and an Audio cable (to connect the AUDIO OUT (L/R) jacks).

- Component connection provides the better quality picture.
- 3 Connect the **COMPONENT VIDEO OUT** jacks of this unit to the **Component Video** input jacks of your TV. Use a commercially available **Component** video cable.
 - 4 Connect the **AUDIO OUT (L/R)** jacks of this unit to the **analogue Audio** input jacks of your TV. Use a commercially available **Audio** cable.

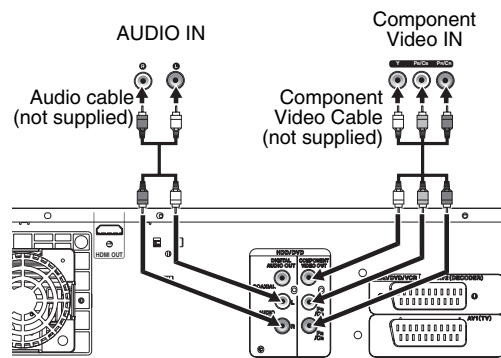

- After you have made the connections, set the "Video Out" setting. (See page 90.)

Selecting Progressive Scan (576p/480p or Interlaced 576i/480i) Playback

- If your TV is compatible with progressive scanning (576p/480p), connect the TV to the COMPONENT VIDEO OUT jacks of this unit and set "Video Out" setting to "Component (Progressive)" in "Setup" menu (See page 90.). Next, set your TV to the progressive scan mode.
- If your TV is not compatible with progressive scan, set "Video Out" setting to "Component (Interlace)".
- Use a commercially available adaptor if the Video input jacks of your TVs or monitors are the BNC type.
- Only component and HDMI connections are compatible with the Progressive Scan.

Connecting to a TV with an HDMI Compatible Port

[HDMI CONNECTION]

A simple 1-cable connection with a device having an HDMI (high-definition multimedia interface) connector allows digital transfer of both digital video signals and multi-channel audio signals. This is the best method to connect this unit. It can minimise the deterioration of image quality.

Use the HDMI cable (commercially available) for connection.

Connect the HDMI output jack of this unit to the HDMI input jack of TV.

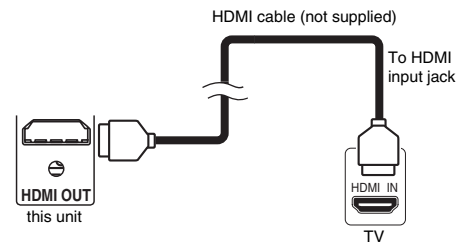

Selecting HDMI mode

Press **[HDMI]** to select the HDMI output mode. The output mode changes as follows every time **[HDMI]** is pressed. 576p (PAL) / 480p (NTSC) → 720p → 1080i → 1080p (An HDMI mode that is not supported by the display device will be skipped.)

Actual Output Modes by Media

Audio recording format of the disc		Dolby Digital / DTS / MPEG setting of this unit	Actual output
DVD-video	Dolby Digital	PCM	2channel PCM
		Stream	Dolby Digital
	LPCM	PCM	2channel PCM
		Stream	MPEG
	DTS	ON	DTS
		OFF	-
MPEG	PCM	2channel PCM	
	Stream	MPEG	
DivX®	Dolby Digital	PCM	2channel PCM
		Stream	Dolby Digital
	MP3	PCM	2channel PCM
		Stream	MPEG
	MP2	PCM	2channel PCM
		Stream	MPEG

For Audio CD, Video CD and MP3 files, 2 channel PCM will be output regardless of the "Dolby Digital" setting.

If the connected device is not compatible with HDMI BITSTREAM, audio will be output as PCM even if you select "Stream" in "Dolby Digital" setting. (See page 87.)

Copyright protection system

To play back the digital video images of a DVD via an HDMI connection, it is necessary that both the player and the display device (or an AV amplifier) support a copyright protection system called HDCP (high-bandwidth digital content protection system). HDCP is copy protection technology that comprises data encryption and authentication of the connected AV device. This unit supports HDCP. Please read the operating instructions of your display device (or AV amplifier) for more information.

* HDMI: High Definition Multimedia Interface

Note

- Because HDMI is an evolving technology, it is possible that some devices with an HDMI input may not operate properly with this unit.
- When using an HDCP-incompatible display device, the image will not be viewed properly.
- Among the devices that support HDMI, some devices can control other devices via the HDMI connector; however, this unit cannot be controlled by another device via the HDMI connector.
- The audio signals from the HDMI connector (including the sampling frequency, the number of channels and bit length) may be limited by the device that is connected.
- Among the monitors that support HDMI, some do not support audio output (for example, projectors). In connections with device such as this unit, audio signals are not output from the HDMI output connector.
- When this unit's HDMI connector is connected to a DVI-D compatible monitor (HDCP compatible) with an HDMI-DVI conversion cable, the signals are output in digital RGB.
- If the connected equipment is not compatible with HDMI BITSTREAM, DTS sound will not be output.
- When the power failure occurs, or when you unplug the unit, some problems in the HDMI setting might occur. Please check and set the HDMI setting again.

Connecting to an External Equipment

This unit has three input terminals which can be selected using [INPUT SELECT \rightarrow] on the remote control, AV1 or AV2 on the rear panel and AV3 on the front panel. Be sure that all the units are switched off before making connections.

Recording from a DVD player, Satellite Box or other Audio-Video equipment with a Scart output socket (AV2)

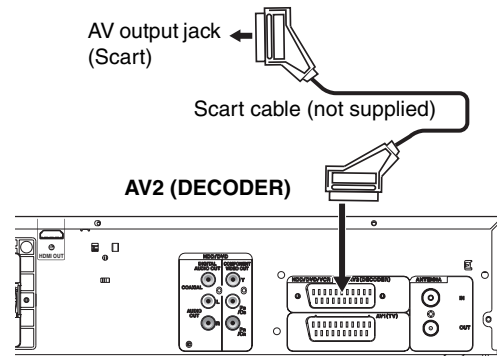

Note

- When you record a TV programme from a Satellite Box, you must connect a Scart cable to AV2 (DECODER). (See page 49.)
- When AV2 is connected, the signal from the AV2 will be output automatically. If you want to monitor the signal from other input, you must press [DISPLAY] first. Then, select the desired input to monitor with [INPUT SELECT \rightarrow].

Recording from a camcorder or other Audio-Video equipment with no Scart output socket (AV3)

Connect to AUDIO / VIDEO input jacks on the front panel using an RCA Audio/Video cables. When connecting a DV-camcorder, use DV input jack of AV4 (Front).

AV3 (Front)

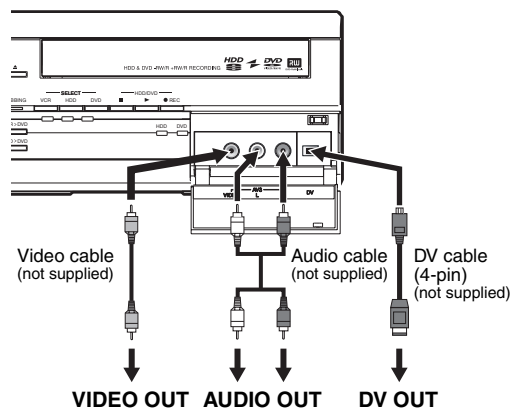

Note

- When connecting an external device of monaural output to this unit, use AUDIO L jack of AV3.

Digital Audio for Better Sound Quality

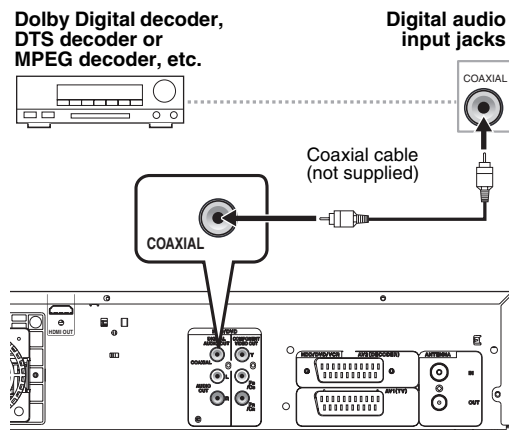

The connections illustrated above are optional for better sound.

1 For clear digital sound quality, use the DIGITAL AUDIO OUT (COAXIAL) jack to connect your digital audio equipment.

If the audio format of the digital output does not match the capabilities of your receiver, the receiver will produce a strong, distorted sound or no sound at all.

Connecting a Dolby Digital™ decoder, DTS decoder or MPEG decoder

- Connecting multi-channel Dolby Digital decoder allows you to enjoy the Multi-channel Dolby Digital surround system as well as DTS decoder, Multi-channel surround system.
- After connecting to a Dolby Digital decoder, set "Dolby Digital" to "Stream" in "Audio Out" menu. (See pages 86 - 87.)
- After connecting to a DTS decoder, set "DTS" to "ON" in "Audio Out" menu. (See pages 86 - 87.)
- After connecting to a MPEG decoder, set "MPEG" to "Stream" in "Audio Out" menu. (See pages 86 - 87.)

Connecting to an MD deck or DAT deck

- The audio source recorded in Dolby Digital Multi-channel surround format cannot be recorded using an MD or DAT deck as a digital sound.
- If not connected to a Dolby Digital decoder, set "Dolby Digital" to "PCM" in "Audio Out" menu. Playing back a DVD using incorrect settings may generate noise distortion and damage speakers.
- Set "Dolby Digital" and "MPEG" to "PCM" and set "DTS" to "OFF" in "Audio Out" menu for connecting to an MD or DAT deck.
- You can use AUDIO OUT (L/R) jacks for the connection of your audio system.

After You Have Completed Connections

Switch the input selector on your TV to an appropriate external input channel. For details, refer to the Owner's Manual of your TV.

Note

- Connect this unit directly to the TV. If the AV cables are connected to a VHS, pictures may be distorted due to the effects of the copy protection system.

Introduction

Connections

Basic Setup

Recording

Playback

Editing

Function Setup

VHS Functions

Others

Basic Setup

Initial Setting

When you turn on this unit for the first time, you need to follow these steps.

- 1 Press [I/⏻ ON/STANDBY].
- 2 Turn the TV on. Select the input to which the unit is connected.
"Réglage initial" will automatically appear.
- 3 Select your desired language for the OSD using [▲ / ▼]. Then press [ENTER] to go to the next step.

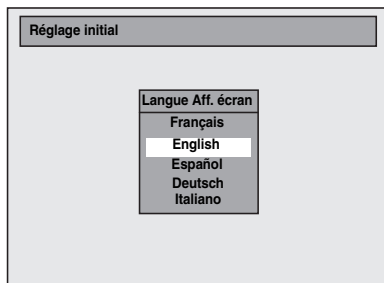

- 4 Select your desired country to the channel plan using [▲ / ▼]. Then press [ENTER] to go to the next step.

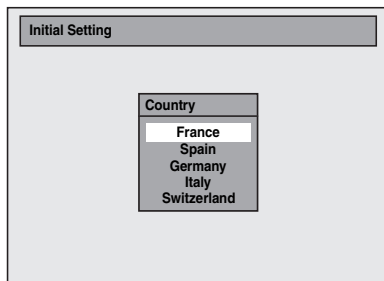

- 5 Select your desired channel preset type using [▲ / ▼]. Then press [ENTER].

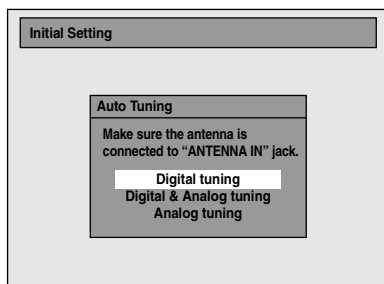

The unit will start getting channels available in your area.

Digital tuning:

Only the DVB channels receivable in your area are automatically scanned and memorised.

Digital & Analog tuning:

Both analogue and DVB channels receivable in your area are scanned and memorised automatically.

Analog tuning:

Only the analogue channels receivable in your area are automatically scanned and memorised.

- If no channel has been memorised, the antenna confirmation display will appear. Press [ENTER] to start auto scanning again or press [RETURN] to cancel the initial settings.

- 6 After finishing channel setting, "Clock Setting" will appear. Then press [ENTER].

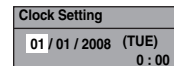

- If you want to adjust the clock, follow to step 5 on page 36 in "Manual Clock Setting".

- 7 Press [ENTER] to exit.

Channel Setting

You can retune this unit or edit the channel setting with following methods.

Auto Tuning (DVB & ANALOG)

Programme the tuner to scan both analogue and DVB channels you can receive in your area.

- 1 In stop mode, press [SETUP]. Select “General Setting” using [▲ / ▼], then press [ENTER].**

General Setting menu will appear.

- 2 Select “Channel” using [▲ / ▼], then press [ENTER].**

- 3 Select “Auto Tuning (DVB & ANALOG)” using [▲ / ▼], then press [ENTER].**

The unit will start storing channels available in your area.

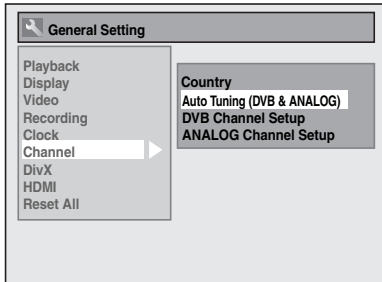

Wait for several minutes to finish channel storing.

- Analogue channels will be stored in channel 901-999 after it is scanned by this unit.

- 4 Press [SETUP] to exit.**

You can select only the channels memorised in this unit by using [PROG. ▲ / ▼].

To cancel auto tuning

Press [RETURN] or [SETUP] during scanning.

Note

- The selection will be affected by how you receive TV channels in your local area.
- If the auto tuning is cancelled during scanning, some channels not yet tuned may not be received.
- You cannot change the channel when this unit is in any recording mode (normal recording, One-touch Timer Recording or timer recording).

Auto Tuning (ANALOG)

ANALOG

Programme the tuner to scan only the analogue channels you can receive in your area.

- 1 In stop mode, press [SETUP]. Select “General Setting” using [▲ / ▼], then press [ENTER].**

- 2 Select “Channel” using [▲ / ▼], then press [ENTER].**

- 3 Select “ANALOG Channel Setup” using [▲ / ▼], then press [ENTER].**

- 4 Select “Auto Tuning” using [▲ / ▼], then press [ENTER].**

The unit will start storing channels available in your area.

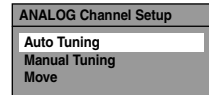

Wait for several minutes to finish channel storing.

- Analogue channels will be stored in channel 901-999 after it is scanned by this unit.

- 5 Press [SETUP] to exit.**

You can select only the channels memorised in this unit by using [PROG. ▲ / ▼].

To cancel auto tuning

Press [RETURN] or [SETUP] during scanning.

Note

- The selection will be affected by how you receive TV channels in your local area.
- If the auto tuning is cancelled during scanning, some channels not yet tuned may not be received.
- You cannot change the channel when this unit is in any recording mode (normal recording, One-touch Timer Recording or timer recording).
- Sorting of TV channels from 901 to 906 will be performed automatically as follows.
901: TF1 902: F2 903: F3
904: CANAL+ 905: F5/ARTE 906: M6

Introduction

Connections

Basic Setup

Recording

Playback

Editing

Function Setup

VHS Functions

Others

Manual Tuning (ANALOG)

ANALOG

You can preset an analogue channel manually and individually.

- 1** In stop mode, press [SETUP]. Select "General Setting" using [▲ / ▼], then press [ENTER].
- 2** Select "Channel" using [▲ / ▼], then press [ENTER].
- 3** Select "ANALOG Channel Setup" using [▲ / ▼], then press [ENTER].
- 4** Select "Manual Tuning" using [▲ / ▼], then press [ENTER].
- 5** Select "Position" using [▲ / ▼], then press [▶].

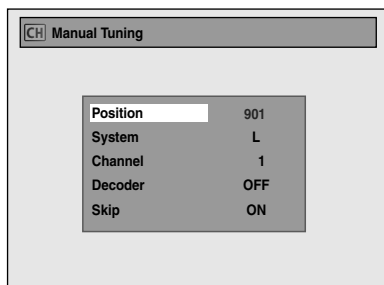

- 6** Select the position number you want to use using [the Number buttons] or [▲ / ▼], then press [◀].
 - You can select position number 901-999.
 - With [the Number buttons], you only need to enter the last 2-digit numbers.
- 7** Select "System" using [▲ / ▼], then press [▶].
- 8** Select "L" or "BG" using [▲ / ▼], then press [◀].
 - If your system is SECAM-L, select "L".
 - If your system is PAL-B/G, select "BG".
- 9** Select "Channel" using [▲ / ▼], then press [▶].
- 10** Press [▲ / ▼] to start scanning.
 - The tuner will begin to search up or down automatically. When a channel is found, the unit will stop searching and the picture will appear on the TV screen.
 - You can select a desired channel number using [the Number buttons]. Refer to the following Channel Plan table and press the three digits to select the channel number. (To select channel 4, press [0] first and then press [0] and [4]. Or press [4] and then "-- 4" appears and wait for 2 seconds.)
 - If this is the channel you want, press [◀].

[L (SECAM-L)]

Channel Plan	
CH Indication	TV Channel
01 – 10	F1 – F10
21 – 69	E21 – E69
74 – 86	B – Q
90 – 106	S4 – S20
121 – 141	S21 – S41

[BG (PAL-B/G)]

Channel Plan	
CH Indication	TV Channel
02 – 12	E2 – E12
13 – 20	A – H (only ITALY)
21 – 69	E21 – E69
74 – 78	X, Y, Z, Z+1, Z+2
80 – 99, 100	S1 – S20, GAP
121 – 141	S21 – S41

This unit can receive the Hyper and Oscar frequency bands.

- If "Skip" is set to "ON", select "Skip" using [▲ / ▼], then press [▶]. Select "OFF" using [▲ / ▼], then press [◀].
- If you want to decode scrambled signals, select "Decoder" using [▲ / ▼], then press [▶]. Select "ON" using [▲ / ▼], then press [◀].
- To store another channel, repeat steps 5 to 10.

11 Press [SETUP] to exit.

Skip a Preset Channel

ANALOG

You can set the unit to skip channels. You can no longer receive or watch when you access channels using [PROG. ^ / v].

- 1** Follow steps 1 to 4 in "Manual Tuning (ANALOG)" on this page.
- 2** Select "Position" using [▲ / ▼], then press [▶].
- 3** Select the position number you want to skip using [the Number buttons] or [▲ / ▼], then press [◀].
- 4** Select "Skip" using [▲ / ▼], then press [▶].
- 5** Select "ON" using [▲ / ▼], then press [◀].
 - To skip another channel, repeat steps 2 to 5.
- 6** Press [SETUP] to exit.

Move

ANALOG

You can replace two channels.

- 1** In stop mode, press [SETUP]. Select "General Setting" using [▲ / ▼], then press [ENTER].
- 2** Select "Channel" using [▲ / ▼], then press [ENTER].
- 3** Select "ANALOG Channel Setup" using [▲ / ▼], then press [ENTER].
- 4** Select "Move" using [▲ / ▼], then press [ENTER].
- 5** Select the position number of which you want to change the channel using [▲ / ▼], then press [ENTER].
You cannot select a position number where "—" appears next to the number, because "Skip" is set to "ON" for that position number.
- 6** Move the channel to another position number using [▲ / ▼], then press [ENTER].

- To move another channel, repeat steps 5 to 6.

- 7** Press [SETUP] to exit.

Auto Tuning (DVB)

DVB

You can programme the tuner to scan only the DVB channels that you can receive in your area.

- 1** In stop mode, press [SETUP]. Select "General Setting" using [▲ / ▼], then press [ENTER].
- 2** Select "Channel" using [▲ / ▼], then press [ENTER].
- 3** Select "DVB Channel Setup" using [▲ / ▼], then press [ENTER].
- 4** Select "Auto Tuning" using [▲ / ▼], then press [ENTER].

The unit will start storing channels available in your area.

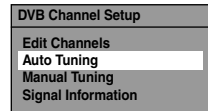

The tuner scans and memorises all the active DVB channels (TV / Radio) in your area.

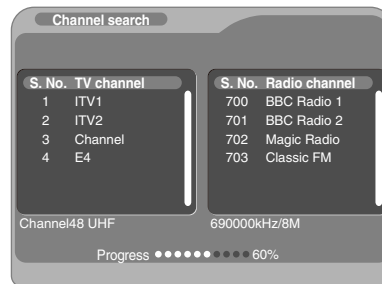

- Press [ENTER] after Auto Tuning is completed, then the lowest memorised DVB channel appears on the screen.

- 5** Press [SETUP] to exit.

You can use [PROG. ▲ / ▼] for the memorised DVB channels.

Note

- If you press [RETURN] during the scanning, the screen will return to the previous displayed menu, and Auto Tuning will be cancelled.
- If you press [SETUP] during the scanning, this operation will stop and the lowest memorised DVB channel will appear on the TV screen.

Introduction

Connections

Basic Setup

Recording

Playback

Editing

Function Setup

VHS Functions

Others

Manual Tuning (DVB)

DVB

You can preset a DVB channel manually and individually.

- 1 Follow steps 1 to 3 in “Auto Tuning (DVB)” on page 27.
- 2 Select “Manual Tuning” using [**▲** / **▼**], then press [**ENTER**].
- 3 Select your desired position number using [**▲** / **▼**], then press [**ENTER**].

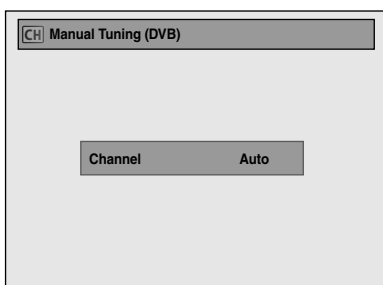

- The tuner will begin to search up or down automatically. When a DVB channel is found, the unit will stop searching.
- When “Auto” is selected the unit will search for the channels which have not been stored in channels memory.

- 4 Press [**SETUP**] to activate the setting.

Country Setting

DVB

You can set the DVB channels to Channel Plan of each country.

- 1 In stop mode, press [**SETUP**]. Select “General Setting” using [**▲** / **▼**], then press [**ENTER**].
- 2 Select “Channel” using [**▲** / **▼**], then press [**ENTER**].
- 3 Select “Country” using [**▲** / **▼**], then press [**ENTER**].
- 4 Select your desired country using [**▲** / **▼**], then press [**ENTER**].

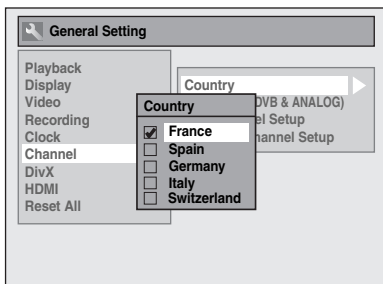

- 5 Press [**SETUP**] to exit.

Select a Channel

You can select memorised channels by using [**PROG.** **▲** / **▼**].

You can select a channel using [**PROG.** **▲** / **▼**] or directly enter the channel using [**the Number buttons**].

Notes on using [the Number buttons]:

- For one or two-digit number channels, the channels will be identified 2 seconds after you press the channel number, or right after you press [**ENTER**]. For example, if you want to select channel 6, press [**6**] and wait for 2 seconds or press [**ENTER**]. You can only select channels 1 to 999.
- Analogue channels will be stored in channel 901-999 and DVB channels will be stored in channel 1-900 after it is scanned by this unit.

To switch DVB, analogue and external input (AV1/AV2/AV3/DV(AV4)) mode.

You can switch between DVB, analogue and external input (AV1/AV2/AV3/DV(AV4)) mode by pressing [**INPUT SELECT** **↻**] repeatedly. The mode changes as follows:

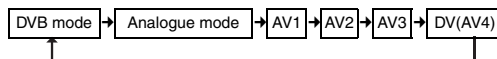

- You can also switch the mode by using [**PROG.** **▲** / **▼**].
- You can select any DVB channels using [**the Number buttons**] when you are in analogue or external input (AV1/AV2/AV3/DV(AV4)) mode.
- You can select any analogue channels using [**the Number buttons**] when you are in DVB mode.

Quick Select

DVB

With "Quick select" menu, you can select your favourite DVB channel quickly. Refer to "Edit Group Lists" on page 30.

1 Press [ENTER] while watching a DVB channel.

- "Quick select" menu will appear.

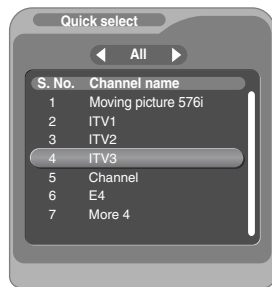

2 Press [◀ / ▶] to select your favourite group list. ("All", "Group1" - "Group8")

- "All" shows a list of all the memorised DVB channels.
- If the favourite group does not have any channels, the group will be skipped.

3 Select the DVB channel you want to watch using [▲ / ▼], then press [ENTER].

4 Press [RETURN] to exit.

Edit Channels (DVB)

DVB

With "Edit Channels" menu, you can see all the memorised DVB channels and sort them into the group lists ("Quick select") or set the viewer limitation ("Adult Lock"), etc.

1 Follow steps 1 to 3 in "Auto Tuning (DVB)" on page 27.

2 Select "Edit Channels" using [▲ / ▼], then press [ENTER].

- "Edit Channels" menu will appear..

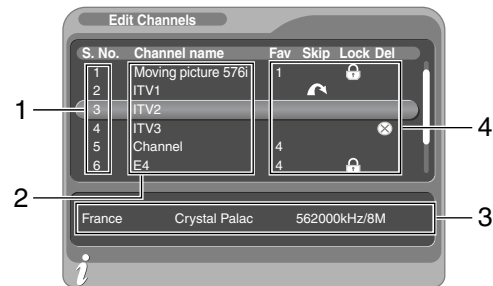

- 1 Channel numbers
- 2 Channel names
- 3 Channel information
- 4 Channel setting

3 Press [SETUP] to exit.

Note

- Press [INFO] to display the using guide. You can see each explanation of the buttons which can be used in "Edit Channels" menu. Press [RETURN] to return to "Edit Channels" menu.

Introduction

Connections

Basic Setup

Recording

Playback

Editing

Function Setup

VHS Functions

Others

Edit Group Lists

DVB

You can sort each DVB channel into 8 different favourite group lists ("Group1"-"Group8"). With "Quick select" menu, you can select your favourite DVB channel quickly. Refer to "Quick Select" on page 29.

- 1 Follow steps 1 to 2 in "Edit Channels (DVB)" on page 29.
- 2 Select the DVB channel you want to add to the favourite group list using [\blacktriangle / \blacktriangledown], then select the number of the favourite group list you want to add to using [the Number buttons] ([1] - [8]).

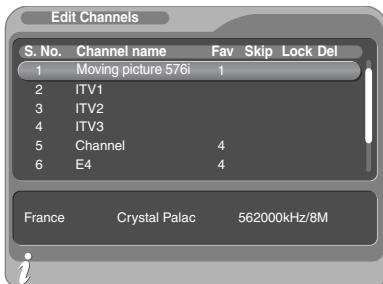

- The number you selected will appear.
- Press [0] to cancel from the favourite group list.

- 3 Press [SETUP] to exit.

Skip Channels

DVB

You can set the unit to skip the unwanted DVB channels when you use [PROG. \wedge / \vee].

- 1 Follow steps 1 to 2 in "Edit Channels (DVB)" on page 29.
- 2 Select the DVB channel you want to skip using [\blacktriangle / \blacktriangledown], then press [GREEN].

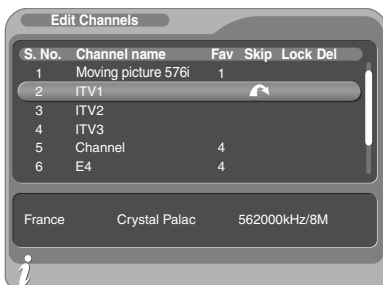

- " $\text{\textcircled{X}}$ " will appear.
- Press [GREEN] to cancel. " $\text{\textcircled{X}}$ " will disappear.

- 3 Press [SETUP] to exit.

Adult Lock

DVB

You can set the unit to limit the access to the DVB channels.

- 1 Follow steps 1 to 2 in "Edit Channels (DVB)" on page 29.
- 2 Select the DVB channel you want to limit the access to using [\blacktriangle / \blacktriangledown], then press [YELLOW].

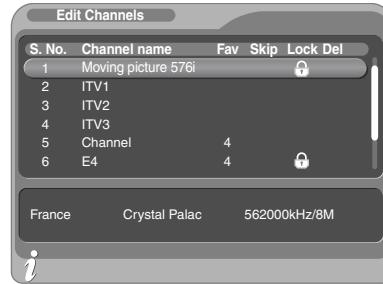

- " $\text{\textcircled{L}}$ " will appear.
- Press [YELLOW] to cancel. " $\text{\textcircled{L}}$ " will disappear.

- 3 Press [SETUP] to exit.

- Once you turn off the unit, Pincode will be required to view the locked channels.
- To set the Pincode, refer to "Pincode Setting for Adult Lock" on page 34.

Delete Channels

DVB

You can delete the DVB channels from the memorised DVB channels.

- 1 Follow steps 1 to 2 in "Edit Channels (DVB)" on page 29.
- 2 Select the DVB channel you want to delete using [\blacktriangle / \blacktriangledown], then press [BLUE].

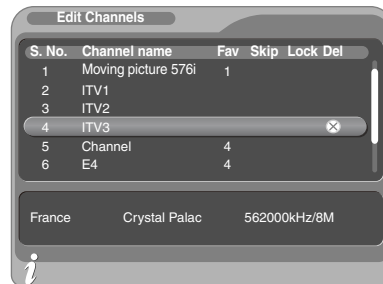

- " $\text{\textcircled{X}}$ " will appear.
- Press [BLUE] to cancel. " $\text{\textcircled{X}}$ " will disappear.

- 3 Press [SETUP] to exit.

- The channel has been deleted from the "Edit Channels" menu.

Channel Move

DVB

You can change the order of the DVB channels when you use [PROG. ^ / ▽].

- 1 Follow steps 1 to 2 in “Edit Channels (DVB)” on page 29.
- 2 Select the DVB channel of which you want to change the position using [▲ / ▼], then press [ENTER].
- 3 Select the channel you want to replace with using [▲ / ▼], then press [ENTER].
 - The channel will be replaced.
- 4 Press [SETUP] to exit.

Edit Channel Names

DVB

You can edit the DVB channel names as you want.

- 1 Follow steps 1 to 2 in “Edit Channels (DVB)” on page 29.
- 2 Select the DVB channel of which you want to edit the name to using [▲ / ▼], press [RED].
 - Name editing display will appear.



- 3 Edit the name using [the Number buttons].
 - Press [the Number buttons] repeatedly until the desired letter appears.
 - Press [◀ / ▶] to move the cursor left or right.
 - Press [RED] to select alphabet or numbers.
 - Press [GREEN] to select capital or small letters.
 - Press [YELLOW] to move the letter on the cursor to the right.
 - Press [BLUE] to delete the letter on the cursor, and move the cursor to the left.
- 4 After completion, press [ENTER].
- 5 Press [SETUP] to exit.

Note

- You can enter up to 19 letters.

Signal Information

DVB

You can check the detailed information of the current DVB channel.

- 1 Follow steps 1 to 3 in “Auto Tuning (DVB)” on page 27.
- 2 Select “Signal Information” using [▲ / ▼], then press [ENTER].
 - “Signal Information” display will appear.



- 3 Press [SETUP] to exit.
 - “Signal Information” is not available for analogue channel and external input (AV1/AV2/AV3/DV(AV4)).
 - “Signal Information” is also not available while the Pincode input field for locked DVB channel is displayed.

Introduction

Connections

Basic Setup

Recording

Playback

Editing

Function Setup

VHS Functions

Others

TV View Operation

The following operations are available while viewing TV channels through this unit's tuner.

Selecting the TV Aspect Ratio

You can select the TV aspect ratio to match the format of the programme you are playing back with the unit and that of your TV screen (4:3 standard or 16:9 wide screen TV).

- 1** In stop mode, press [SETUP]. Select "General Setting" using [▲ / ▼], then press [ENTER].
- 2** Select "Video" using [▲ / ▼], then press [ENTER].
- 3** Select "TV Aspect" using [▲ / ▼], then press [ENTER].

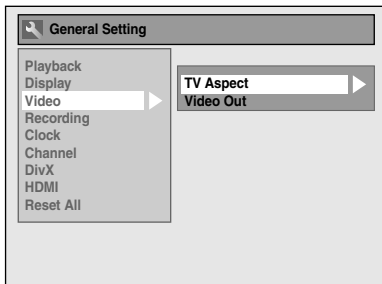

- 4** Select the desired option using [▲ / ▼], then press [ENTER].

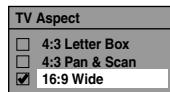

- 5** Press [SETUP] to exit.

Hint

If you have a standard TV:

- Select "4:3 Letter Box" for a full width picture with black bars at the top and bottom.
- Select "4:3 Pan & Scan" for a full height picture with both sides trimmed.

If you have a wide screen TV:

- Select "16:9 Wide".

Selecting the Audio Mode

ANALOG

You can switch between TV audio modes by pressing [AUDIO ⏮]. Each mode is indicated on the TV screen.

- During reception of analogue bilingual broadcasts

Mode	Audio output	Display on the TV screen
Main	Main audio from both speakers	Main
Sub	Sub audio from both speakers	Sub
Main / Sub	<ul style="list-style-type: none"> • Main audio from the left speaker • Sub audio from the right speaker 	Main/Sub

- If the programme does not have more than one sound track, [AUDIO ⏮] is not effective.

Digital Teletext Reception

DVB

Many broadcasters provide a DVB Teletext service in the form of a dedicated Teletext channel. This Digital service includes high quality text and graphics along with advanced navigation options.

- 1** Press [TEXT] to display Teletext screen.
 - Teletext for the TV channel you have selected will be displayed.
- 2** Use [RED] / [GREEN] / [YELLOW] / [BLUE] to follow the instructions on screen.
- 3** Press [TEXT] to switch the Teletext display off.

Note

- [TEXT] is not available during recording.

EPG (Electronic Programme Guide)

Electronic programme guide (EPG) gives you a list of the DVB programmes and detailed information about the programmes. To call up EPG while viewing DVB/analogue channel or external input (AV1/AV2/AV3/DV(AV4)), press [GUIDE]. You can also call up EPG by following steps.

- 1** In stop mode, press [SETUP]. Select "Timer Programming" using [▲ / ▼], then press [ENTER].
- 2** Select "EPG" using [▲ / ▼], then press [ENTER].
 - Select the TV programme using [▲ / ▼ / ◀ / ▶], then press [SETUP] or [GUIDE] to exit.
 - From the EPG screen, you can also set the timer recording. Select the TV programme using [▲ / ▼ / ◀ / ▶], then press [ENTER] or [BLUE] to go to "Timer Programming" menu. Refer to "Timer Recording (EPG)" on page 48.



- 1 EPG menu mode
- 2 Date / Time
- 3 Date
- 4 Channel number / name
- 5 Channel programme
- 6 Programme you select now

- Press **[GUIDE]** to exit.
- Press **[RED]** or **[GREEN]** to change "Daily mode" or "Weekly mode".
- Press **[YELLOW]** to see more detailed information of the selected programme.
- Press **[INFO]** to display the using guide.

Multiaudio

DVB

Many DVB channels transmit Multi audio information along with their DVB channels. You can select the desired audio mode and audio language.

- 1 While viewing a DVB programme, press **[AUDIO]**.



- 2 Select "Stereo", "Right" or "Left" using **[◀ / ▶]**.
- 3 Select your desired audio language using **[▲ / ▼]**.
 - The available audio language varies depending on the DVB programmes.
- 4 Press **[ENTER]** to activate the settings.

Note

- If the programme is changed, the audio language will be switched back to the default language you set in the "DVB Menu". Refer to "Language Setting" on pages 34 to 35.

Subtitle

DVB

Many DVB channels transmit Subtitle information along with their DVB channels. You can retrieve and display it on the TV screen.

- 1 While viewing a DVB programme, press **[SUBTITLE]**.

- If the programme has no subtitle information, "No information" will appear.



- 2 Select "On" using **[◀ / ▶]**.

- If you do not want to display the subtitle, select "Off" using **[◀ / ▶]**.

- 3 Select your desired subtitle language using **[▲ / ▼]**.

- The available subtitle language varies depending on the DVB programmes.

- 4 Press **[ENTER]** to activate the settings.

Note

- If the programme is changed, the subtitle language will be switched back to the default language you set in the "DVB Menu". Refer to "Language Setting" on pages 34 to 35. If the default subtitle language is not available on the new programme, no subtitle will be displayed.

Introduction

Connections

Basic Setup

Recording

Playback

Editing

Function Setup

VHS Functions

Others

DVB Menu Setting

You can make settings of the digital tuner from the DVB Menu.

Pincode Setting for Adult Lock

DVB

You can set "Adult Lock" to "ON" or "OFF" and also change Pincode.

- 1 In stop mode, press [SETUP].
- 2 Select "DVB Menu" using [▲ / ▼], then press [ENTER].
- 3 Select "Adult Lock" using [▲ / ▼], then press [ENTER].

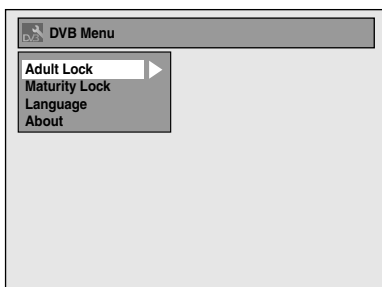

- 4 Select "ON" or "OFF" using [▲ / ▼], then press [ENTER].

5 To set "Adult Lock" to "ON":

- 1) Enter your desired Pincode using [the Number buttons], then press [ENTER].
- 2) For confirmation, enter the Pincode again using [the Number buttons] then press [ENTER].

To set "Adult Lock" to "OFF":

- Enter the Pincode using [the Number buttons].
- While entering the Pincode, use [◀] or [CLEAR] to clear the numbers once entered.

- 6 Press [SETUP] to exit.

Note

- Once "Adult Lock" has been set to "ON", Pincode will be required in order to view the locked channels or make the timer recording of them, and when you try to execute the "Auto Tuning" for DVB or "Edit Channels".
- If you forget the Pincode, press [4], [7], [3], [7] to cancel the Pincode.

Maturity Lock

DVB

According to the age rating signal which comes with each DVB programme, you can lock each programme.

- 1 Follow steps 1 to 2 in "Pincode Setting for Adult Lock" on this page.

- 2 Select "Maturity Lock" using [▲ / ▼], then press [ENTER].

- If "Adult Lock" is set to "ON", enter the Pincode to proceed to next step.

- 3 Select the desired rating using [▲ / ▼], then press [ENTER].

- Select "OFF" to disable "Maturity Lock".

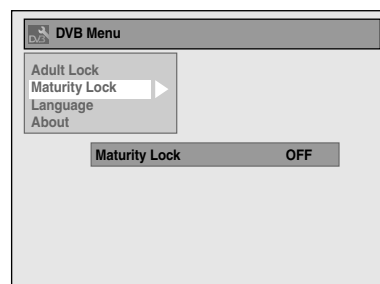

- 4 Press [SETUP] to exit.

- Once "Maturity Lock" has been set, Pincode will be required in order to view the programme that exceeds the age restriction.
- In order to activate "Maturity Lock", "Adult Lock" has to be set to "ON". To set "Adult Lock", refer to "Pincode Setting for Adult Lock" on this page.

Language Setting

DVB

- 1 Follow steps 1 to 2 in "Pincode Setting for Adult Lock" on this page.

- 2 Select "Language" using [▲ / ▼], then press [ENTER].

- 3 Select the item by which you want to change the language using [▲ / ▼], then press [ENTER].

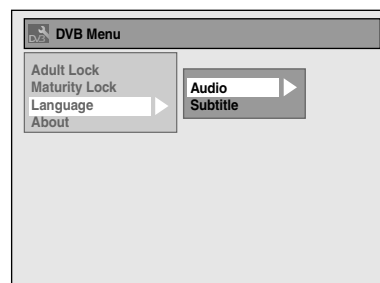

- Audio : Set the Audio language
 Subtitle : Set the Subtitle language

4 Select a language using [**▲** / **▼**], then press [**ENTER**].

5 Press [**SETUP**] to exit.

Note

- The Audio and Subtitle setting may not be available for some broadcast.
- To change the audio language, refer to “Multiaudio” on page 33.
- To display the subtitle or choose the subtitle language, refer to “Subtitle” on page 33.

About

DVB

You can check the current DVB system software version of this unit.

1 Follow steps 1 to 2 in “Pincode Setting for Adult Lock” on page 34.

2 Select “About” using [**▲** / **▼**], then press [**ENTER**].

3 Press [**SETUP**] to exit.

Selecting the On-Screen Display (OSD) Language

1 In stop mode, press [**SETUP**]. Select “General Setting” using [**▲** / **▼**], then press [**ENTER**].

2 Select “Display” using [**▲** / **▼**], then press [**ENTER**].

3 Select “OSD Language” using [**▲** / **▼**], then press [**ENTER**].

4 Select the appropriate OSD language using [**▲** / **▼**], then press [**ENTER**].

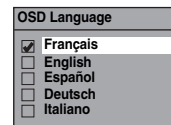

5 Press [**SETUP**] to exit.

Introduction

Connections

Basic Setup

Recording

Playback

Editing

Function Setup

VHS Functions

Others

Setting the Clock

Auto Clock Setting

This unit receives time signals from the analogue / DVB channels, and set the clock automatically. Set the channel tuning before setting Auto Clock.

- 1** In stop mode, press [SETUP]. Select “General Setting” using [▲ / ▼], then press [ENTER].
- 2** Select “Clock” using [▲ / ▼], then press [ENTER].

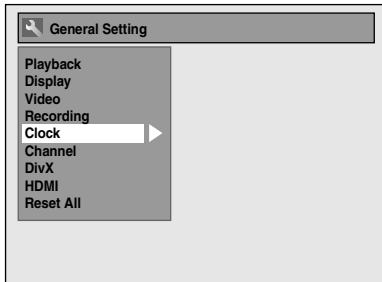

- 3** Select “Auto Clock Setting” using [▲ / ▼], then press [ENTER].
- 4** Select “ON” using [▲ / ▼], then press [ENTER].
- 5** Press [SETUP] to exit.
- 6** Press [I/⏻ ON/STANDBY] to turn the unit off.
 - The Auto clock function is activated.
 - This unit will search for the time every time when the power is turned off.
 - Leave the unit off for about 10 seconds to give it time to set the clock.

Hint

- If you want to cancel “Auto Clock Setting”, select “OFF” using [▲ / ▼], and then press [ENTER] at step 4.

Note

- The default setting of “Auto Clock Setting” is “ON”.
- The clock may set itself automatically after you connect the antenna cable to the unit and plug in the mains cable. In this case, the current time will appear on the front panel display.
- If there are only analogue channels memorised in this unit:
 - The channel assigned to “901” must receive the PDC signal in order to set the clock automatically.
 - The unit will correct the current time by receiving PDC broadcasts whenever the power is turned off.
 - Between 23:00 and 1:00, the Auto Clock function will not operate even when the power is turned off.
- The clock cannot be set automatically if you are not receiving a channel in your area that carries a time signal. In this case, set the clock manually.
- The unit will also correct the current time automatically at 8:00 and 1:10 if the unit is in standby mode or if you are watching DVB channel.

Manual Clock Setting

- 1** In stop mode, press [SETUP]. Select “General Setting” using [▲ / ▼], then press [ENTER].
- 2** Select “Clock” using [▲ / ▼], then press [ENTER].
- 3** Select “Clock Setting” using [▲ / ▼], then press [ENTER].
Default date will appear.
- 4** Press [ENTER] again.

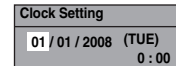

- 5** Enter the date (day / month / year) using [▲ / ▼].

Press [▶] to move the cursor to the next field. If you want to go back to the previous field, press [◀].

- 6** Enter the time (hours / minutes) using [▲ / ▼], then press [ENTER].

The clock will start.

- Although seconds are not displayed, they will be counted from zero.

- 7** Press [SETUP] to exit.

Note

- Your clock setting will be lost if either there is a power failure or the unit is unplugged for more than 30 seconds.

Recording

Information on DVD Recording

Type of Discs

This unit can record on DVD-RW/-R discs and DVD+RW/+R discs.

DVD-R/+R discs allow you to record programmes only once, and the recorded contents can be erased although the space left on the disc does not change. DVD-RW/+RW discs allow you to record programmes repeatedly, and the recorded contents can be erased. There are 3 recording formats: VR mode, Video mode and +VR mode. VR and Video modes are available for DVD-RW discs while as only Video mode is available for DVD-R discs. +VR mode is available for DVD+RW/+R discs.

Video mode is the same recording format as used on the pre-recorded DVD-Videos you purchase in local shops. You can play back the discs recorded in this format in most of the DVD players. You will need to finalise such discs (see page 59) before playing them back in other DVD players. Unless finalised, you can record additional materials or edit discs recorded in Video mode with this unit. VR (Video Recording) mode is a basic recording format for DVD-RW discs. VR mode offers advanced editing, and you can record and edit material repeatedly, however it is playable only on VR mode compatible unit. Finalisation is recommended before playing them back in other unit. +VR mode is a recording format for DVD+RW/+R disc. +VR mode offers basic editing, and it is playable in most DVD players. Finalisation is recommended before playing them back in other unit.

Recording Mode

You can select a recording mode from 5 options. The recording time will vary depending on the recording mode you select as follows.

Recording mode	Recording time			Video / Sound Quality
	DVD 12 cm	DVD 8 cm	HDD	
XP	60 min	18 min	33 hrs	☆☆☆☆☆
SP	120 min	36 min	66 hrs	☆☆☆☆
LP	240 min	72 min	133 hrs	☆☆☆
EP	360 min	108 min	200 hrs	☆☆
SLP	480 min	144 min	267 hrs	☆

- The recording times are estimates and actual recording time may differ.
- The audio and video quality becomes poorer as the recording time gets longer.

Restrictions on Recording

You cannot record copy-protected video using this unit. Copy-protected video includes DVD-Videos and some satellite broadcasts.

If copy-protected material is detected, recording will pause or stop automatically and an error message appears on the screen.

You can only record "Copy-once only" video using a DVD-RW disc in VR mode with Content Protection for Recordable Media (CPRM) or internal HDD.







When recording a TV broadcast or an external input, you can display copy control information on the screen.

CPRM is a scrambling copy protection system for the protection of "copy-once" broadcast programmes.

This unit is CPRM compatible, which means that you can record copy-once broadcast programmes, but you cannot then make a copy of those recordings. CPRM recordings can only be played back on DVD players that are specifically compatible with CPRM.

Information on Copy Control

Some satellite broadcasts include copy-protected information. If you want to record them, refer to the following.

Disc type / format	Copy-free	Copy-once	Copy-prohibited
 HDD	☆	☆	—
 VR DVD-RW ver. 1.1 / ver. 1.2	☆	—	—
ver. 1.1 / ver. 1.2 CPRM compatible	☆	☆	—
 Video DVD-RW ver. 1.1 / ver. 1.2	☆	—	—
ver. 1.1 / ver. 1.2 CPRM compatible	☆	—	—
 DVD-R ver. 2.0	☆	—	—
 DVD+RW	☆	—	—
 DVD+R	☆	—	—
 VHS	☆	☆	☆

☆ : Recordable

— : Not recordable

Note

- This unit cannot record on CD-RW or CD-R discs.
- DVD-RW/-R, DVD+RW/+R and CD-RW/-R discs recorded on a personal computer or a DVD or CD recorder may not be played back if the disc is damaged or dirty or if there is condensation on the recorder's lens.
- If you record a disc using a personal computer, even if it is recorded in a compatible format, it may not be played back because of the settings of the application software used to create the disc. (Check with the software publisher for more detailed information.)

Introduction

Connections

Basic Setup

Recording

Playback

Editing

Function Setup

VHS Functions

Others

- Discs recorded in Video mode on this unit cannot record additional information using other DVD recorders.
- Since recording is performed using the Variable Bit Rate (VBR) method, the actual remaining time for recording may be a little shorter than the remaining time displayed on the OSD, depending on the picture you are recording.

Making Discs Playable in Other DVD Players (Finalise)

After recording, you must finalise the disc to play it back in other players. (See page 59.)
You cannot finalise discs in other DVD recorders.

After finalising

- After DVD-R discs are finalised:
 - A Title menu is created automatically.
 - Undo finalising is not possible.
 - Additional recording or editing is not possible.
- After DVD-RW (Video mode) discs are finalised:
 - A Title menu is created automatically.
 - Undo finalising is possible. (See page 59.)
 - Additional recording or editing is possible if you undo finalise. (See page 59.)
- After DVD-RW (VR mode) discs are finalised:
 - A Title menu is not created.
 - Undo finalising is possible. (See page 59.)
 - Additional recording or editing is possible if you undo finalise. (See page 59.)
- After DVD+RW discs are finalised:
 - A Title menu is created automatically.
 - Undo finalising is possible. (See page 59.)
 - Additional recording or editing is possible even without undo finalising.
- After DVD+R discs are finalised:
 - A Title menu is created automatically.
 - Undo finalising is not possible.
 - Additional recording or editing is not possible.

About HDD

HDD is a special device which has high recording density and is suited for long-time recording or high-speed cueing but by contrast, has many factors which can cause breakage. Use HDD on the premise that you should dub the recorded programmes to a DVD disc to protect your precious videos.

HDD is a temporary storage location:

HDD is not a permanent storage location of the recorded contents. Be sure to use it as a temporary storage location until you watch the programmes once, edit them, or dub them to a DVD disc.

Be sure to dub (back up) data promptly if you find abnormalities in HDD:

If there is mechanical trouble with the HDD, grinding or other sounds may be heard or blocky noise may appear on the image. If you continue to use as it is, deterioration may continue and eventually the HDD may not be used at all. If you notice these symptoms of a failing HDD, promptly dub the data to a DVD disc. When an HDD fails, recovery of recorded content (data) may be impossible.

About the remaining capacity of HDD recording time:

In recording to HDD, the Remaining Capacity Display may differ from the actual recordable time as this unit adopts Variable Bit Rate encoding, which varies the recording (storage) amount of data in conformity with the information amount of video. Before recording to the HDD, ensure there is sufficient space on the HDD by deleting unnecessary titles in advance. (Remaining capacity will not increase if you only delete Playlists.)

Maximum Recordable Numbers of Title / Chapters

HDD:

600 Original titles
600 Playlists
99 chapters per Original/Playlist title

VR mode DVD:

99 titles per each Playlist and Original
999 chapters per each Playlist and Original

Video mode DVD:

99 titles per disc
99 chapters per title

+VR mode DVD:

49 titles per discs
254 chapters per disc
99 chapters per title

Formatting a Disc

Choosing the Recording Format of a Blank DVD-RW Disc



When inserting a brand-new DVD-RW/+RW disc, the unit automatically starts to initialise the disc. DVD+RW disc will always be formatted in +VR mode, and DVD-RW disc will be formatted either Video or VR mode according to the recording format mode setting of the unit. Before insert a brand-new DVD-RW disc, you need to set the recording format to the desired mode. You can also manually format a DVD-RW disc once it has been used.

- 1** In stop mode, press [SETUP].
- 2** Select “DVD Menu” using [▲ / ▼], then press [ENTER].
- 3** Select “Format” using [▲ / ▼], then press [ENTER].
- 4** Select “Format Mode” using [▲ / ▼], then press [ENTER].
- 5** Select “Video mode” or “VR mode” using [▲ / ▼], then press [ENTER].

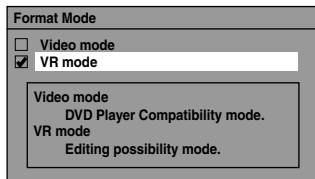

- 6** Press [SETUP] to exit.
- 7** Insert a blank disc.
Formatting will start.
- 8** Formatting is complete.
“100%” is indicated.

Note

- The recording format setting is effective only for DVD-RW discs. You cannot change the recording format for a DVD-R disc and DVD+RW/+R disc.
- You cannot mix two formats on one DVD-RW disc. If you insert a disc that has been recorded before, the recording format cannot be changed even if you change it in “Setup” menu.

Make Recording Compatible



Use this feature to make the unfinalised +VR mode discs recorded on other unit recordable on this unit. When you make an additional recording on this unit with “Make Recording Compatible” set to “ON”, the title list is automatically converted to this unit’s style.

- 1** In stop mode, press [SETUP]. Select “General Setting” using [▲ / ▼], then press [ENTER].
- 2** Select “Recording” using [▲ / ▼], then press [ENTER].
- 3** Select “Make Recording Compatible” using [▲ / ▼], then press [ENTER].
- 4** Select “ON” or “OFF” using [▲ / ▼], then press [ENTER].

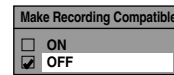

- ON: Title list will be replaced when you make additional recordings to the discs recorded by other units.
- OFF: Prohibiting additional record to the disc that has a title list created by other units.

- 5** Press [SETUP] to exit.

Introduction

Connections

Basic Setup

Recording

Playback

Editing

Function Setup

VHS Functions

Others

Setting Aspect Ratio for Video Mode Recording



You can set aspect ratio for video mode recording.

- 1** In stop mode, press [SETUP]. Select “General Setting” using [▲ / ▼], then press [ENTER].
- 2** Select “Recording” using [▲ / ▼], then press [ENTER].
- 3** Select “Aspect Ratio (Video mode)” using [▲ / ▼], then press [ENTER].
- 4** Select your desired setting using [▲ / ▼], then press [ENTER].

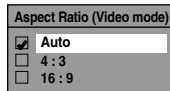

Auto (default): It will be recorded with whichever the ratio that the programme you started to record is broadcasted with.

4:3 : Recorded in the aspect ratio of 4:3.
16:9 : Recorded in the aspect ratio of 16:9.

- 5** Press [SETUP] to exit.

Note

- For HDD and VR mode DVD-RW disc, the image will be recorded in whichever the ratio that the programme you record is broadcasted with, regardless of the “Aspect Ratio (Video mode)” setting.
- For DVD+RW/+R disc, the image will always be recorded in aspect ratio of 4:3.

Setting Auto Chapter



The unit inserts a chapter mark periodically (every 15 minutes by default) during recording. Using the Auto Chapter menu, you can set this function off or change the time period.

- 1** In stop mode, press [SETUP]. Select “General Setting” using [▲ / ▼], then press [ENTER].
- 2** Select “Recording” using [▲ / ▼], then press [ENTER].
- 3** Select “Auto Chapter” using [▲ / ▼], then press [ENTER].

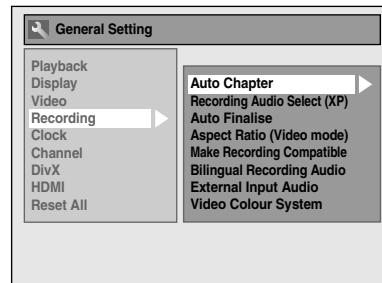

- 4** If you want to set “Auto Chapter” off, select “OFF” using [▲ / ▼], then press [ENTER].

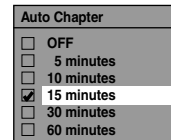

If you want to change the time period for “Auto Chapter”, select the required time period using [▲ / ▼], then press [ENTER].

- 5** Press [SETUP] to exit.

Note

- The interval for auto chapter may be up to 2 minutes different from the time option you set.
- While recording, no more chapter mark will be added after coming up to the maximum chapter mark number.

Reformatting a Disc Manually



If you are using a DVD-RW/+RW disc, you can format the disc by performing "Format". You can format DVD-RW disc for either Video mode recording or VR mode recording. DVD+RW disc can be formatted in order to erase all content of the disc.

Note

- When you reformat the disc, the contents of the disc are erased.
- Make sure that the recording format is set to the desired mode. (Refer steps 1 to 6 in "Choosing the Recording Format of a Blank DVD-RW Disc" on page 39.)

Insert a recordable disc.

- 1 In stop mode, press [SETUP].
- 2 Select "DVD Menu" using [▲ / ▼], then press [ENTER].
- 3 Select "Format" using [▲ / ▼], then press [ENTER].
- 4 Select "Start" using [▲ / ▼], then press [ENTER].
For DVD+RW, use [▲ / ▼] to select "Yes", then press [ENTER].

A pop up window will appear and prompt you to confirm.

- 5 Select "Yes" using [▲ / ▼], then press [ENTER].

e.g.) VR mode DVD-RW

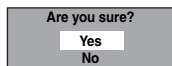

Formatting will start.
If you want to cancel formatting, select "No".

- 6 Formatting is complete.

Note

- It is not possible to use a disc formatted with this unit in other DVD recorder. When you use a disc with another DVD recorder, format a disc using that DVD recorder.

Selecting the Sound Mode

This unit can receive bilingual broadcasts.

You can switch between modes by pressing [AUDIO]. Each mode is indicated on the TV. When you record a DVB channel, only output sound channel will be recorded.

Setting External Input Audio



When the external input audio is a bilingual broadcast, you can choose "Stereo" or "Bilingual" to record on an HDD/DVD. This setting is only for recording external input (AV1/AV2/AV3).

- 1 In stop mode, press [SETUP]. Select "General Setting" using [▲ / ▼], then press [ENTER].
- 2 Select "Recording" using [▲ / ▼], then press [ENTER].
- 3 Select "External Input Audio" using [▲ / ▼], then press [ENTER].

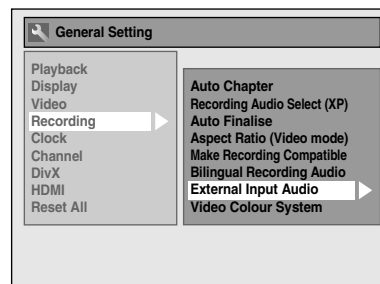

- 4 Select "Stereo" or "Bilingual" using [▲ / ▼], then press [ENTER].

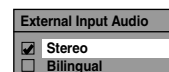

- 5 Press [SETUP] to exit.

Hint

- If you select "Stereo":
The audio will be recorded as "stereo audio".
- If you select "Bilingual":
The audio will be recorded as "bilingual audio". (See "Setting Bilingual Recording Audio" on page 42 for more detail.)

Introduction

Connections

Basic Setup

Recording

Playback

Editing

Function Setup

VHS Functions

Others

Setting Bilingual Recording Audio



You can select either "Main" or "Sub" audio to record a bilingual broadcast in Video mode or +VR mode. This setting is only for recording analogue channel.

- 1** In stop mode, press [SETUP]. Select "General Setting" using [▲ / ▼], then press [ENTER].
- 2** Select "Recording" using [▲ / ▼], then press [ENTER].
- 3** Select "Bilingual Recording Audio" using [▲ / ▼], then press [ENTER].
- 4** Select "Main" or "Sub" using [▲ / ▼], then press [ENTER].

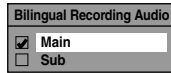

- 5** Press [SETUP] to exit.

Note

- If you are recording onto an HDD or VR mode disc, both "Main" and "Sub" will be recorded regardless of your setting here. And when you play back, you can choose either audio format or a combination of both as your playback audio.

Recording Audio Select (XP)



You can enjoy high quality sound recording. This function works only when the recording mode is set at XP.

- 1** In stop mode, press [SETUP]. Select "General Setting" using [▲ / ▼], then press [ENTER].
- 2** Select "Recording" using [▲ / ▼], then press [ENTER].
- 3** Select "Recording Audio Select (XP)" using [▲ / ▼], then press [ENTER].
- 4** Select "PCM" or "Dolby Digital" using [▲ / ▼], then press [ENTER].

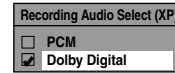

- PCM: Records PCM audio for the best quality sound.
- Dolby Digital: Records Dolby Digital audio for good quality sound.

- 5** Press [SETUP] to exit.

Note

- "PCM" stands for Pulse Code Modulation. It changes analogue sound to digital sound without compressing audio data.
- When the recording mode is set at other than XP, the unit records "Dolby Digital" audio automatically even if you selected "PCM".

Basic Recording



Follow the steps below to record a TV programme.
(See page 93 for VHS recording.)

1 Press [I/ON] ON/STANDBY] to turn on the unit.

Turn on the TV and be sure to select the input to which the unit is connected.

If you are recording to the HDD, press [HDD], then proceed to step 5.

If you are recording to a disc, press [DVD].

2 Press [OPEN/CLOSE ▲] to open the disc tray.

3 Place the disc on the disc tray with its label facing up. Be sure to align the disc with the disc tray guide.

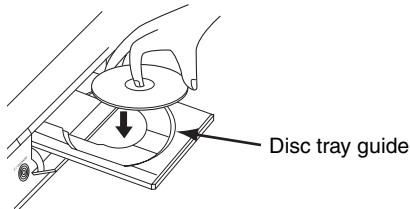

4 Press [OPEN/CLOSE ▲] to close the disc tray.

5 Select the recording mode using [REC MODE]. (See page 37.)

6 Press [INPUT SELECT ↻] to select DVB, analogue or external input mode, then select the desired channel to record using [PROG. ^ / ∨] or [the Number buttons].

7 Press [REC ●] to start recording.

The “● HDD” or “● DVD” mark will be displayed on the TV screen briefly.

To pause the recording, press [PAUSE II]. Press [PAUSE II] or [REC ●] again to restart the recording.

8 Press [STOP ■] to stop the recording.

This operation may take a few moments to complete.

Hint

- You can change the channel while in the REC pause mode.

Note

- Recording starts immediately and continues until the disc is full or you stop recording.
- You cannot change the recording mode in the REC or REC pause mode.
- Even if the broadcasting you are recording is in the SECAM system, this unit automatically converts it to the PAL system when recording.
- If the external equipment is connected to AV2, the picture of the external equipment will be output except during the DVD playback of this unit. Turn off the external equipment or press [DISPLAY] to output the picture of this unit.
- You can play back a title on one component while making a recording on the other component. To do so, simply select the component (HDD or DVD) you want to use for the playback by pressing [HDD] or [DVD] during HDD / DVD recording. And then follow the normal playback procedure.
- If playback and recording are in progress at the same time, select the appropriate component by pressing [HDD] or [DVD] before you press [PAUSE II] or [STOP ■] to pause or stop the operation.
- NTSC recording is prohibited in this unit.

Introduction

Connections

Basic Setup

Recording

Playback

Editing

Function Setup

VHS Functions

Others

One-touch Timer Recording (OTR)



This is a simple way to set the recording time in blocks of 30 minutes. Check that the disc you are recording onto has enough space remaining for the time you set. (See page 94 for VHS recording.)

- 1 Follow steps 1 to 6 in “Basic Recording” on page 43.
- 2 Press [REC ●] repeatedly until the desired recording time (30 minutes to 8 hours) appears on the TV screen.

One-touch Timer Recording will start.

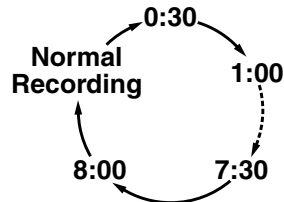

- When the unit reaches the specified time, it will be turned off automatically.
- To change the recording length during One-touch Timer Recording, press [REC ●] repeatedly until the desired length appears.
- To cancel One-touch Timer Recording within the specified time, press [STOP ■].

Hint

- The remaining recording time will appear on the TV screen during One-touch Timer Recording. Press [DISPLAY] to see it on the TV screen.
- The remaining recording time will be displayed on the front panel display during One-touch Timer Recording.
- Unlike the timer recording, you can perform the following operations during One-touch Timer Recording.
 - Turn off the power. (One-touch timer recording will be cancelled.)
 - Use [REC ●] on the remote control.

Note

- You cannot use the pause function during One-touch Timer Recording.
- The unit will be turned off automatically under the following conditions.
 - No space remains on the disc.
 - If a power failure occurs.
- If the external equipment is connected to AV2, the picture of the external equipment will be output except during the DVD playback of this unit. Turn off the external equipment or press [DISPLAY] to output the picture of this unit.

Timer Recording



You can set the unit to record up to 36 programmes, up to a month in advance. Daily or weekly programme recordings are also available.

- Be sure to set the clock before entering a timer programming.

Insert a recordable disc.

- 1 In stop mode, press [TIMER PROG.].
“Timer Programming” list will appear.
- 2 Select “New Programme” using [▲ / ▼], then press [ENTER].

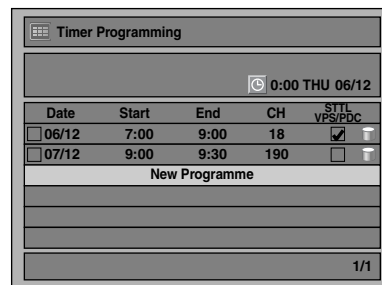

- If there are 7 programmes or more, use [SKIP ◀◀ / ▶▶] to turn the page.

- 3 Enter the date using [▲ / ▼], then press [▶].

Each time you press [▼] at the current date, the timer recording date will change as follows.

e.g., 1st January

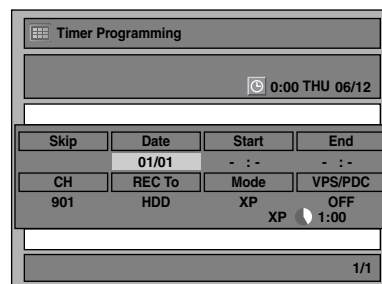
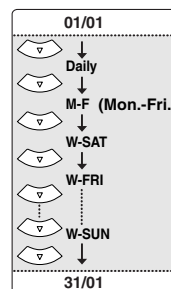

- 4 Enter the time to start and to end using [▲ / ▼], then press [▶].

5 Select the channel number to record using [\blacktriangle / \blacktriangledown], then press [\blacktriangleright].

To record from the external input, select "AV1", "AV2", or "AV3".

6 Select the recording media ("HDD" or "DVD") using [\blacktriangle / \blacktriangledown], then press [\blacktriangleright].

7 Select the recording mode using [\blacktriangle / \blacktriangledown], then press [\blacktriangleright].

Refer to "Recording Mode" on page 37.

8 For DVB channel recording: Select "STTL" to "ON" or "OFF" using [\blacktriangle / \blacktriangledown].

If you set "STTL" to "ON", subtitle will be recorded too.

- When analogue channel is selected, "VPS/PDC" will be displayed instead of "STTL".

For analogue channel recording:

Select "VPS/PDC" to "ON" or "OFF" using [\blacktriangle / \blacktriangledown].

Refer to "VPS (Video Programme System) / PDC (Programme Delivery Control)" on page 46.

- When DVB channel is selected, "STTL" will be displayed instead of "VPS/PDC".
- VPS/PDC system is only available for HDD.
- VPS/PDC system is not available for "Daily" and "M-F" timer programme.

9 Press [ENTER] when all information required is entered.

Your programme setting is stored.

- To set another programme, repeat steps 2 to 9.
- To exit, press [TIMER PROG.].
- When 2 or more programmes are overlapped, "Timer programme overlapped" appears, and the overlapped programme will be displayed in blue. To correct the timer programme, refer to "Checking, Cancelling or Correcting the Timer Programming Information" on page 46.

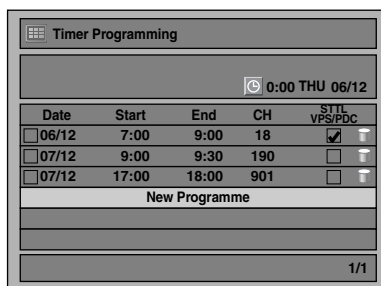

Date	Start	End	CH	STTL VPS/PDC	
0:00 THU 06/12					
<input type="checkbox"/> 06/12	7:00	9:00	18	<input checked="" type="checkbox"/>	\blacktriangleright
<input type="checkbox"/> 07/12	9:00	9:30	190	<input type="checkbox"/>	\blacktriangleright
<input type="checkbox"/> 07/12	17:00	18:00	901	<input type="checkbox"/>	\blacktriangleright
New Programme					
1/1					

The  icon will appear on the front panel display.

Note

- If you have not set the clock, the clock setting window will appear instead of the Timer Programming list. Continue from step 4 in "Manual Clock Setting" on page 36 before programming the timer.
- Press [\blacktriangle / \blacktriangledown] to move the cursor in "Timer Programming" list.
- If you have a timer programme with VPS/PDC function, and if you are watching different channel from the timer programme, confirmation message to change the channel will appear 15 minutes before the programme starts (the message will also re-appear 30 seconds before the programme starts). The channel will automatically be changed to the programmed channel 15 seconds before the programme starts.

Alternate recording (DVD only)...

If there is no recordable disc in the unit, if the disc does not have enough space to complete the recording, or if the material is "copy-once" programme and prohibited to be recorded on a DVD in the unit, the unit will detect it and automatically record to the HDD even when DVD is selected as the recording media. If the available space on the HDD is less than that of DVD, the unit will not perform the alternate recording. This feature is available only for timer recording. Not available for one-touch timer recording.

Introduction

Connections

Basic Setup

Recording

Playback

Editing

Function Setup

VHS Functions

Others

VPS (Video Programme System) / PDC (Programme Delivery Control)

The Video Programme System (VPS) or Programme Delivery Control (PDC) assures that the TV programmes you have programmed for timer recording are recorded exactly from beginning to end, even if the actual broadcasting time differs from the scheduled time due to a delayed start or extension of the programme duration. Furthermore, if a programme is interrupted, the recording will also be interrupted automatically and resumed when the programme starts again.

If the VPS/PDC signal drops out because the broadcast signal is weak, or if a broadcasting station does not transmit a regular VPS/PDC signal, the timer recording is performed in normal mode (without VPS/PDC) even if it was programmed for VPS/PDC. If the starting time of the VPS/PDC timer recording is between 0:00 and 3:59 on a given day, the VPS/PDC function will operate from 20:00 on the previous day to 4:00 on the next day. If the starting time of the VPS/PDC timer recording is between 4:00 and 23:59 on a given day, the VPS/PDC function will operate from 0:00 on the given day to 4:00 on the next day. This means that if the relevant programme is broadcasted within this period, it is recorded correctly. If the timer is not programmed correctly, the incorrect timer setting stays in effect unless you cancel it. To cancel an incorrect timer setting, refer to "Checking, Cancelling or Correcting the Timer Programming Information" on this page.

Note

- This feature is only available for analogue channels.

Checking, Cancelling or Correcting the Timer Programming Information

1 Press [TIMER PROG.].

2 A) To delete the timer programme:

- 1) Select the programme you want to delete using [▲ / ▼], then press [ENTER].
- 2) Select "Delete" using [▲ / ▼], then press [ENTER].
Confirmation window will appear.
- 3) Select "Yes" using [▲ / ▼], then press [ENTER].

B) To correct the timer programme:

- 1) Select the programme you want to correct using [▲ / ▼], then press [ENTER].
- 2) Select "Programme Change" using [▲ / ▼], then press [ENTER].
- 3) Correct the timer programme by using [▲ / ▼ / ◀ / ▶], then press [ENTER].

3 Press [TIMER PROG.] to exit.

To check the timer programming in progress
Press [TIMER PROG.].

Skip the Periodical Timer Recording

You can deactivate the periodical (Daily, Mon-Fri or Weekly) timer recording temporarily.

- 1 In stop mode, press [TIMER PROG.].
- 2 Select the periodical timer recording programme you want to skip using [▲ / ▼], then press [ENTER].
- 3 Select "Programme Change" using [▲ / ▼], then press [ENTER].
- 4 Move the cursor to the "Skip" field using [◀ / ▶], then select "ON" using [▲ / ▼] and then press [ENTER] to activate the setting.

- "✓" will be displayed on the left side of the timer programme.
- The setting will go back to "OFF" after the programme is skipped once.

Stop the Timer Recording in Progress

On the front panel of the unit, press [■ STOP] to stop the recording, or press and hold [STOP ■] on the remote control for 2 seconds.

- You can also stop the timer recording in progress by deleting the timer programme. Press [TIMER PROG.] while the timer recording is in progress, then follow steps 2-A) and 3 of the "Checking, Cancelling or Correcting the Timer Programming Information" on this page.

If the Timer Programming Did Not Complete Correctly

The error number appears on "Timer Programming" list.

Date	Start	End	CH	S TTL VPS/PDC
E40	06/12	7:00	9:00	901
New Programme				

The error programme will be displayed in gray with an error number.

The error numbers indicate:

- E1–E22, E37–E39 : Recording error
 E23–E24 : Unrecordable disc
 E25/E51 : • Copy prohibited programme
 : • Cannot record because of the NTSC / PAL-60 signal is received.
 E26–E28 : Copy prohibited programme
 E29 : Disc protected
 E30 : Disc full
 E31 : Already recorded 99 titles (Video mode)
 E32 : Already recorded 99 titles (VR mode)
 E33 : Already recorded 999 chapters
 E34 : No space for Control Information
 E35 : PCA (Power Calibration Area) full
 E36 : Already finalised Video format disc
 E40 : • There are some unrecorded parts due the overlapped timer programmes.
 : • Recording did not start at the start time.
 E41 : Power failure
 E42 : No disc
 E43 : Already 49 titles recorded (+VR mode)
 E44 : Already 254 chapters recorded (+VR mode)
 E45 : Copy prohibited programme
 E46 : It is impossible to record additionally on a disc recorded by other units when setting "Make Recording Compatible" to "OFF". (+VR mode)
 E47 : Already 600 titles recorded on the HDD.
 E49–E50 : HDD recording is cancelled due to the insufficiency of the disc space on the HDD.
- Timer programme with an error number will be cleared once the entry screen for the programme is displayed.

Hints for the Timer Recording

- If there is a power failure or the unit is unplugged for more than 30 seconds, the clock setting and all timer settings will be lost.
- If a disc is not inserted or if a inserted disc is not recordable (finalised DVD-RW/-R, finalised DVD+R, a fully recorded disc, etc.), the unit will perform the alternate recording to the HDD. (See page 45.)
- When a timer recording is completed, the unit will ask you whether to turn off the unit if there is no timer recording which starts within 4 minutes, except under conditions listed below.
 - During playback of HDD or DVD.
 - While displaying menus or information on the screen.
- The unit will be turned off automatically if you select "Yes" or if you do not reply in 1 minute.
- When the programmed starting and ending time are earlier than the current time, the setting will not be accepted.
- The audio language which is selected in the "DVB Menu" will be recorded for the timer recording of digital TV broadcasting.
- Timer recording whose recording time exceeds 12 hours cannot be made.
- It is prohibited to turn off the unit from 4 minutes before the programmed starting time.
- It is prohibited to change channel from 15 seconds before the programmed starting time.
- **[REC ●]** does not work from 2 minutes before the programmed starting time. If it comes to 2 minutes before the starting time during regular or one-touch timer recording, the recording in progress will be stopped.
- Playback of DVD/CD is prohibited from 2 minutes before the programmed starting time when the recording media is DVD. If it comes to 2 minutes before the programmed starting time during DVD/CD playback, the playback will be stopped.
- When 2 or more programmes are overlapped, "Timer programme overlapped" appears, and the overlapped programme will be displayed in blue. To correct the timer programme refer to "Checking, Cancelling or Correcting the Timer Programming Information" on page 46.
- If the Start time is earlier and the End time is later than the current time, the recording will start immediately after you press **[ENTER]** at step **9** on page 45.

Introduction

Connections

Basic Setup

Recording

Playback

Editing

Function Setup

VHS Functions

Others

Priority of overlapped settings

The unit records programmes according to priority if the timer programmes overlap.

If the starting time is same:

- The timer programming set first (PROG. 1) has priority.

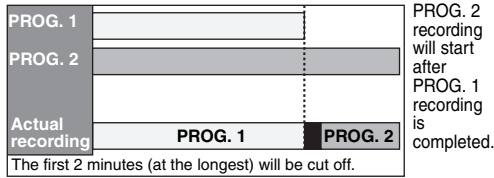

When the starting time and the ending time for each programmes are different:

- A programme that has earlier start time has priority.

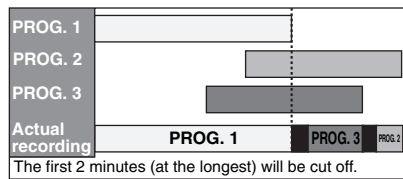

If the recording time is partially overlapped:

- The timer programming with the earlier start time (PROG. 2) has priority. PROG. 1 will start after PROG. 2 recording is complete.

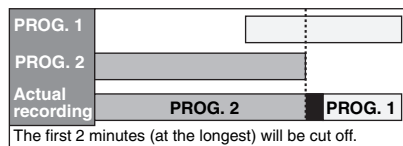

If the recording time entirely overlaps:

- The shorter timer programming (PROG. 1) is not recorded.

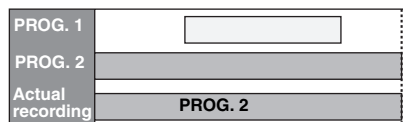

Note for DVD recording

- If the recording time of two programmes are overlapped, or the End time of a programme and the Start time of another is same, the first 2 minutes (at the longest) of the subsequent programme will be cut off.

If the End time of the programme currently being recorded and the Start time of the subsequent programme are same:

- The beginning of the PROG. 2 may be cut off.

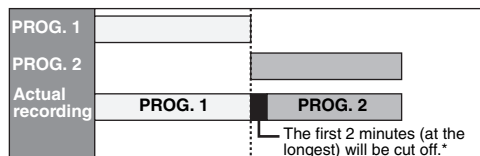

* If the cut off time exceeds 3 minutes, the error number "E40" will appear in "Timer Programming" list.

Timer Recording (EPG)



With EPG system, you can programme DVB channel recording much easier. You can only choose one programme and enter the selection.

1 While viewing a DVB programme, press [GUIDE].

List of DVB programmes will be displayed.

e.g.) Weekly mode

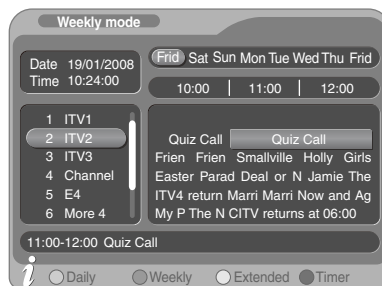

Press [RED] or [GREEN] to change "Daily mode" or "Weekly mode".

2 Select a desired programme using [▲ / ▼ / ◀ / ▶], then press [ENTER] or [BLUE].

3 Set "End", "REC To", "Mode" and "STTL" using [▲ / ▼ / ◀ / ▶], then press [ENTER].

Satellite Link



You can set the unit to start recording whenever it detects the video scart control from the external tuner.

Preparing for the Satellite Link Timer Recording:

[Preparation of the external tuner]

- The external tuner should be equipped with some kind of timer function. Using timer function of the tuner, set it to be turned on when it comes to the time you want to start recording, and off when it comes to the time you want to finish recording. (Refer to the tuner's manual on how to set the timer.)
- Make sure to turn off the external tuner when you finish setting.

[Preparation of this unit]

- Make sure to select the desired Recording mode beforehand.

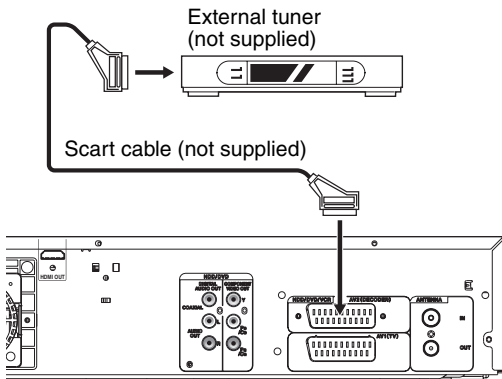

1 In stop mode, press [HDD] then select the recording mode for HDD using [REC MODE].

2 Press [SAT.LINK].

- "Sat" will appear on the front panel display and the unit goes into the Satellite Link standby mode.



To cancel the Satellite Link function in the Satellite Link standby mode:

Press [I/ψ ON/STANDBY] or [SAT.LINK] to turn on the unit.

To cancel the Satellite Link function while the Satellite Link Recording is in progress:

Press [■ STOP] on the front panel of the unit, or press and hold [STOP ■] on the remote control for 2 seconds.

Note

- Recording picture will be distorted if the copy protection signal is being detected during Satellite Link Timer Recording.
- [SAT.LINK] does not work under the following circumstances:
 - Setup menus are displayed.
 - "Timer Programming" menu is displayed.
 - Title list or any file list is displayed.
- When a regular Timer Recording and the Satellite Link Timer Recording are overlapped, the examples are given below.

	Example 1
Timer Recording	
Satellite Link	
Actual Recording	

	Example 2
Timer Recording	
Satellite Link	
Actual Recording	

	Example 3
Timer Recording	
Satellite Link	
Actual Recording	

Introduction

Connections

Basic Setup

Recording

Playback

Editing

Function Setup

VHS Functions

Others

Settings for External Equipment

Video Colour System

When you record from external equipment or copy a videotape to a DVD disc, you can set the format Auto, PAL or SECAM.

- 1 In stop mode, press [SETUP]. Select "General Setting" using [▲ / ▼], then press [ENTER].
- 2 Select "Recording" using [▲ / ▼], then press [ENTER].
- 3 Select "Video Colour System" using [▲ / ▼], then press [ENTER].
- 4 Select "Auto", "PAL" or "SECAM" using [▲ / ▼], then press [ENTER].

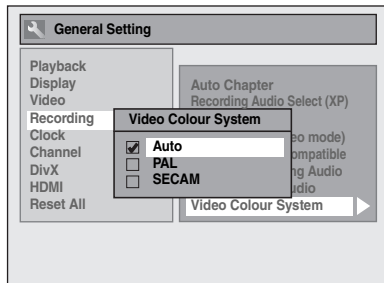

- Auto : The video colour system will be set automatically according to the recording material.
- PAL : The video colour system will be set to PAL.
- SECAM: The video colour system will be set to SECAM.

- 5 Press [SETUP] to exit.

Note

- During recording, when a signal other than PAL or SECAM is detected, an error message appears on the screen and recording will be paused. Recording will be resumed when a PAL or SECAM signal is detected.

Recording from External Equipment



Before recording from external equipment, see page 22 for connection instructions.

- 1 Turn the TV and the unit on, and select the input of the TV to which the unit is connected.
If you are recording to the HDD, press [HDD].
If you are recording to a disc, press [DVD] and insert a recordable disc.
If you are recording to a videotape, press [VCR] and insert a recordable videotape.
- 2 Select the input terminal to which the external equipment is connected (AV1, AV2, or AV3).
To use the input jacks on the rear of the unit, select "AV1" or "AV2" position by pressing [INPUT SELECT ->] or [PROG. ^ / v].
To use the input jacks on the front of this unit, select "AV3" position by pressing [INPUT SELECT ->] or [PROG. ^ / v].
- 3 Select a recording mode using [REC MODE]. (See page 37.)
- 4 Press [● REC] on the unit to start recording.
- 5 Press the [PLAY] button on the external equipment.
- 6 Press [■ STOP] (HDD/DVD) or [▲ / ■ EJECT/STOP] (VHS) on the unit to stop recording.

Note

- During recording, recording will be paused when a signal other than PAL or SECAM is detected. (See "Video Colour System" on this page for details.)
- If the external equipment is connected to AV2, the picture of the external equipment will be output except during the DVD playback of this unit. Turn off the external equipment or press [DISPLAY] to output the picture of this unit.

Information on DV Dubbing

This function helps you to dub the contents in the DVC (digital video camcorder) to HDD, DVD or VHS easily. (See page 94 for "DVC to VHS Dubbing".) You can control basic operations of the DVC from the remote control of this unit if the DVC is in video mode.

Guide to DV and On-Screen Display

- 1 Connect your DVC to the DV input jack on the front panel using a DV cable. (Use the DV cable that has 4-pin input jack and is compliance with the IEEE 1394 standards.)**
- 2 Press [INPUT SELECT \rightarrow] repeatedly to select the appropriate external input channel for DV input jack (AV4).**
- 3 Press [DISPLAY] to display the DVC information on the screen.**

When the DVC is in video mode...

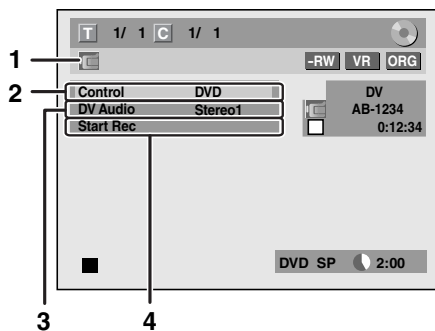

When the DVC is in camera mode...

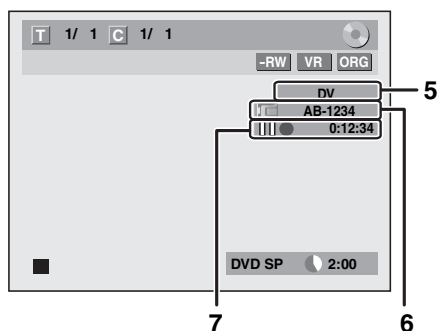

















The menu changes according to the mode of DVC. Switch the mode on the DVC to video mode for the dubbing information.

The following instructions are described with the operations using the remote control of this unit.

- DV icon**
- Indicator of active device**
 - With "Control" highlighted, press [ENTER] to display the available devices to control with the remote control of this unit. Select the device you want to operate using [▲ / ▼], then press [ENTER].
 - Select "HDD" / "DVD" to control this unit with the remote control of this unit.
 - Select "DVC" to control your DVC with the remote control of this unit.
- Recording audio mode**
 - "DV Audio" can be changed. With "DV Audio" selected, press [ENTER] to display "DV Audio" menu. Select the audio you want to output using [▲ / ▼], then press [ENTER].
 - Select "Stereo1" to dub the stereo sound.
 - Select "Stereo2" to dub the sound that was added after the recording.
 - Select "Mix" to dub the stereo1 and stereo2.
- Command menu**
 - "Start Rec" or "Pause Rec" will appear.
- External input channel**
- Product name of your DVC**
 - If the unit cannot recognise the input signal from the DVC or if it is the unknown product, "No Device" or "*****" will appear instead.
- Status of the current operation and the time counter**

Each icon means (Available icons may vary depending on the DVC):

- DVC is in stop mode.
-  DVC is in playback mode.
-  DVC is in pause mode.
-  DVC is fast forwarding. (standard speed)
-  DVC is fast forwarding. (faster than above)
-  DVC is fast forwarding. (faster than above)
-  DVC is slow forwarding. (standard speed)
-  DVC is slow forwarding. (faster than above)
-  DVC is slow forwarding. (faster than above)
-  DVC is fast forwarding. (in stop mode)
-  DVC is fast reversing. (in stop mode)
-  DVC is fast reversing. (standard speed)
-  DVC is fast reversing. (faster than above)
-  DVC is fast reversing. (faster than above)
-  DVC is in slow reverse playback.
-  DVC is in recording.
-  DVC is in recording pause mode.

Please also read the operating instructions of your DVC for more information.

Introduction

Connections

Basic Setup

Recording

Playback

Editing

Function Setup

VHS Functions

Others

DVC to HDD / DVD Dubbing



Before recording from DVC, see page 22 for connection instructions. (See page 94 for DVC to VHS Dubbing.)

Preparing for DV dubbing (DVC to HDD):

- Make sure your DVC is in video mode.

Preparing for DV dubbing (DVC to DVD):

- Insert a recordable DVD.
- Make sure your DVC is in video mode.

If you are dubbing to the HDD, press [HDD] first.
If you are dubbing to a disc, press [DVD] first.

- 1 Select “DV” channel using [INPUT SELECT \rightarrow] or [PROG. \wedge / \vee].

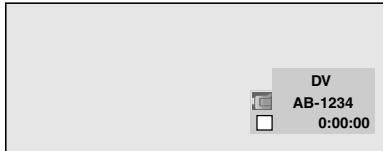

- 2 Press [REC MODE] to select a recording mode. (See page 37.)

- 3 Press [DISPLAY].

- 4 With “Control” highlighted, press [ENTER] to display the available devices to control with the remote control of this unit. Select “DVC” using [\blacktriangle / \blacktriangledown], then press [ENTER].

e.g.) DVC to DVD dubbing

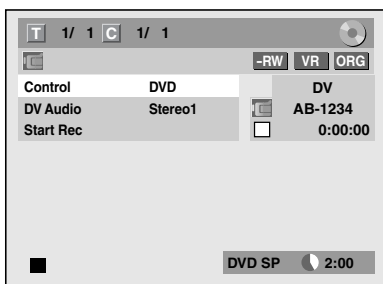

Now you can operate your DVC with the remote control of this unit.

- 5 Press [PLAY \blacktriangleright] to start playing back the DVC, and find where you want to start dubbing.

Press [STOP \blacksquare] when it comes to the desired start point.

- 6 Select “Start Rec” using [\blacktriangle / \blacktriangledown], then press [ENTER].

The dubbing will start.

To stop dubbing;

- 1 Select “Control” using [\blacktriangle / \blacktriangledown], then press [ENTER].
- 2 Select “HDD” / “DVD” using [\blacktriangle / \blacktriangledown] (whichever the recording component you are using), then press [ENTER].
- 3 Press [STOP \blacksquare].

Note

- The tape will rewind a few seconds when you press [ENTER] at step 6 so that the dubbing starts exactly where you press [PAUSE \parallel] instead of [STOP \blacksquare] at step 5.
- The unit does not send out the output signal to DVC.
- For the proper operation, connect DVC to the unit directly. Do not connect this unit and DVC via any other unit.
- Do not connect more than one DVC.
- The unit can only accept DVC. Other DV device such as cable/satellite box or D-VHS VCR cannot be recognised.
- If no video signal is detected from the DVC during DVC to HDD or DVD dubbing, the recording will be paused and “●” will flash on the TV screen. The recording will resume when the unit detects the video signal again.
- When the DVC is in camera mode, refer to “Guide to DV and On-Screen Display” on page 51.
- Date / time and cassette memory data will not be recorded.
- Pictures with a copy-guard signal cannot be recorded.
- A DV terminal is a terminal that can use the transmission mode conforming to the IEEE 1394 standards called “Fire Wire”. It serves as the interface that connects the PC and peripheral device such as “i.Link” (registered trademark of SONY). It enables digital dubbing between DV devices with little degradation.
- You cannot dub from DVC to both HDD and DVD at the same time.

Information on Dubbing

You can copy an HDD / DVD disc to a videotape or copy a videotape to an HDD / DVD disc. This function will be possible only if the DVD or the videotape is not copy protected.

Before dubbing, prepare for the recording on the DVD-RW / R disc, DVD+RW / +R disc or the videotape. See pages 37 to 38 (HDD / DVD) or page 93 (VHS).

Difference between "Copy" and "Move":

- Copy:** After dubbing the programme, the original programme will remain.
- Move:** After dubbing the programme, the original programme will not remain.

Available dubbing direction for copy-once programme:

From	To	
HDD (Internal)	DVD-RW (VR) (CPRM-compatible)	○ ^{*1,*2}
	DVD-RW (VR) (Not CPRM-compatible)	×
	DVD-RW (Video)	×
	DVD-R / +RW / +R	×
	Videotape	○ ^{*2}
DVD-RW (VR)	HDD (Internal)	×
	Videotape	○ ^{*2}
Videotape	HDD (Internal)	○
	DVD-RW (VR) (CPRM-compatible)	○ ^{*2}
	DVD-RW (VR) (Not CPRM-compatible)	×
	DVD-R / +RW / +R	×

○: Available
×: Not available

- *1 The programme (recorded) moves. (It will be deleted from HDD.)
- *2 You cannot dub the recorded programme to HDD or DVD-RW again. (Copy control signal will be recorded to the videotape.) (Refer to page 37 for details about CPRM.)

Guide to Dubbing Menu Display

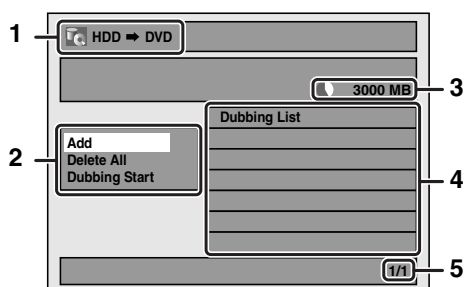

- 1 Dubbing direction
- 2 Dubbing menu
- 3 Remaining recordable space
- 4 Dubbing list
- 5 Current page number / total number of pages

Recording Mode for Dubbing

"High"

This unit is compatible with the high speed dubbing from HDD to DVD or VR mode DVD-RW disc to HDD. With the high speed dubbing, you can dub a title much faster than the normal speed dubbing without changing the quality of the picture and sound. (e.g. If you dub a title recorded in SLP mode to DVD-R or DVD+R, dubbing speed will be 32 times faster than the normal dubbing speed.) To perform the high speed dubbing, set the recording mode to "High".

- Duration of high speed dubbing will vary depending on the recording mode or the title amount.
- High speed dubbing is not available when;
 - recording mode is set to other than "High".
 - dubbing from a video mode DVD-RW/-R or DVD+RW/+R disc to the HDD.
 - there is not enough space in the disc.
 - dubbing a title recorded in EP or SLP mode to DVD+RW / +R discs.
- High speed dubbing of an HDD title which has bilingual audio is only available to VR mode DVD-RW disc.

"Auto"

When "Auto" is selected as a recording mode, the unit calculates how much time is available on the disc and selects the best recording mode available automatically.

- The recording may be cut short when the available recording space of the disc is too limited.

Note

- During normal dubbing, you can watch the playback picture of the title being dubbed (the audio cannot be changed). During high speed dubbing, the playback picture will not appear.
- When you dub an HDD title that has bilingual audio to Video mode DVD-RW / -R or DVD+RW / +R disc, select an appropriate audio format in the "Bilingual Recording Audio" menu. Refer to "Setting Bilingual Recording Audio" on page 42.
- In order to dub a DVD recorded with the NTSC, set the "TV System" to "PAL". Refer to "9. TV System" on page 88.
- If you stop the dubbing halfway, the contents will be dubbed up to where you stop the dubbing (except for the high speed dubbing). With high speed dubbing, nothing will be dubbed if you stop it halfway.
- To stop the dubbing in progress, press **[STOP]** on the front panel or press **[STOP]** for 2 seconds on the remote control. If you stop the high speed dubbing or stop the dubbing copy-once programmes, confirmation message appears. Select "Yes" using **[▲ / ▼]**, then press **[ENTER]** to proceed.

Other recording modes

Refer to page 37 for the information on other recording modes.

Before Starting Dubbing

HDD to DVD / DVD to HDD

You can copy the contents between HDD and DVD.

Limitation (DVD to HDD):

- If a copy control signal is detected during dubbing, the dubbing will be stopped.

Preparing for dubbing (HDD to DVD):

- Insert a recordable DVD.

Preparing for dubbing (DVD to HDD):

- Insert a disc to be dubbed.
- Discs dubbed with other devices may not be dubbed.

VHS to HDD / DVD

You can copy the contents of a videotape to HDD or DVD disc.

Limitation:

- If a copy control signal is detected during dubbing, the dubbing will be stopped.
- Copy-once programmes which are recorded directly from the TV can be dubbed to the HDD and CPRM compatible VR mode DVD-RW.
- Copy-once programmes which are copied from the HDD / DVD to a videotape cannot be dubbed further from the videotape to the HDD / DVD.

Limitation (VHS to HDD):

- With VHS to HDD dubbing, the unit recognise the HDD's remaining time as the dubbing duration. The maximum possible duration is 12 hours.

Limitation (VHS to DVD):

- You cannot dub to the finalised Video mode DVDs.
- You cannot dub to the protected VR mode DVDs.

Preparing for dubbing:

- Insert a videotape to be dubbed.

Preparing for dubbing (VHS to HDD):

- Make sure there is enough space on the HDD.

Preparing for dubbing (VHS to DVD):

- Insert a recordable DVD.
- Make sure there is enough space on the DVD.

HDD / DVD to VHS

You can copy the contents of the HDD / DVD to a videotape.

Limitation:

- If a copy control signal is detected during dubbing, the dubbing will be stopped.

Limitation (DVD to VHS):

- The contents of DVDs made on this unit can be dubbed. Other discs may not be dubbed.

Preparing for dubbing:

- Insert a recordable videotape with a record tab intact.
- Make sure that the videotape has enough space to record the contents.

Preparing for dubbing (DVD to VHS):

- Insert a disc to be dubbed.

One Touch Dubbing



You can start dubbing right away with just one touch.

One Touch Dubbing between HDD and DVD

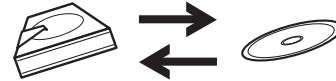

If you are dubbing a title in the HDD, press [HDD] first.

If you are dubbing a title in a disc, press [DVD] first.

During playback of the title you want to dub, press [DUBBING].

If you are playing back an HDD, HDD to DVD dubbing will start right away.

If you are playing back a DVD, DVD to HDD dubbing will start right away.

(HDD to DVD only)

During playback of the title you want to dub, press [DUBBING HDD > DVD] on the front panel. HDD to DVD dubbing will start right away.

To stop the dubbing in progress:

Press [■ STOP] on the front panel.

Press [STOP ■] for 2 seconds on the remote control.

Note

- When dubbing from DVD to HDD, only One Touch Dubbing will be available for finalised DVD-R, Video mode DVD-RW or DVD+R.
- The dubbing will start from the beginning of the title being played back.
- The unit will dub only the title being played back.
- If the title was in the resume stop mode, the dubbing will start from the beginning to the end of the resume stopped title.
- When dubbing from HDD to DVD or VR mode DVD-RW to HDD, recording mode will automatically be set to "High" whenever the conditions are met. (See page 53.)
- If the high speed dubbing is not available, the title will be dubbed in normal speed with the recording mode of the title.
- If the title is recorded in other brand's DVD recorder, the title will be dubbed in normal speed with the recording mode that you set with [REC MODE].
- If there is not enough space left on the disc for high/normal speed dubbing with the title's recording mode, the title will be dubbed in normal speed with "Auto" mode. If there is not enough space left on the disc for normal speed dubbing with SLP mode, the title will be dubbed in normal speed with SLP mode until the space of the disc runs out.
- If you press [DUBBING HDD > DVD] on the front panel in stop mode without selecting any title, the unit will start dubbing the last title in the Original List or the Playlist. It will start dubbing the title in the Original List if the Original List was the last selected list. It will start dubbing the title in the Playlist if the Playlist was the last selected list.

One Touch Dubbing from VHS to DVD



If you are dubbing a title in the videotape, press [VCR] first.

- 1 Press [PLAY ►] to start the playback of the videotape you want to dub.
- 2 Press [STOP ■] or [PAUSE II] where you want to start dubbing.
- 3 Press [DUBBING VCR > DVD] on the front panel.

The dubbing will start from there to the end.

To stop the dubbing in progress:

Press [STOP ■] on the front panel.

Press [STOP ■] for 2 seconds on the remote control.

Note

- When dubbing starts, the video image may be distorted because of the Digital Tracking function. This is not a malfunction. Play the videotape until the image clears up and then start the dubbing.
- Dubbing takes as much time as the playback does.

One-Title Dubbing between HDD and DVD



This function lets you select one specific title from the title list for dubbing.

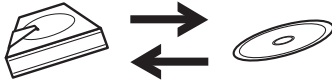

If you are dubbing a title in the HDD, press [HDD] first.

If you are dubbing a title in a disc, press [DVD] first.

- 1 Press [TOP MENU].
- 2 Select a desired title to be dubbed using [▲ / ▼ / ◀ / ▶], then press [ENTER].
- 3 Select "Dubbing" using [▲ / ▼], then press [ENTER].
e.g.) HDD Original

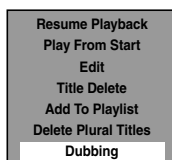

- 4 Select "Yes" using [▲ / ▼], then press [ENTER].

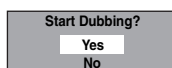

Dubbing of the selected title will start.

To stop the dubbing in progress:

Press [STOP ■] on the front panel.

Press [STOP ■] for 2 seconds on the remote control.

Selected Title Dubbing



- 1 In stop mode, press [SETUP].
- 2 Select "Dubbing" using [▲ / ▼], then press [ENTER].

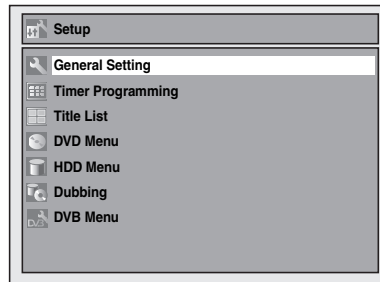

HDD to DVD / DVD to HDD



- 3 **HDD → DVD**
Select "HDD → DVD" using [▲ / ▼], then press [ENTER].
- DVD → HDD**
Select "DVD → HDD" using [▲ / ▼], then press [ENTER].

e.g.) HDD → DVD

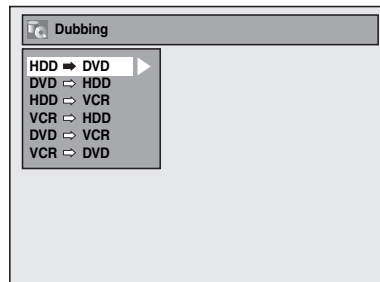

- 4 Select "Add" using [▲ / ▼], then press [ENTER].

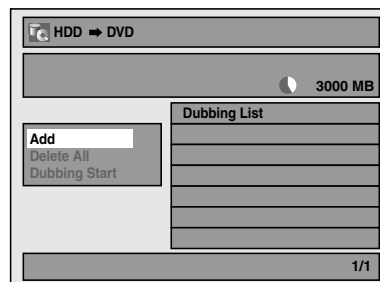

- If you have registered any dubbing before, they will be listed in the dubbing title list.

Introduction

Connections

Basic Setup

Recording

Playback

Editing

Function Setup

VHS Functions

Others

- 5 Select a desired title using** [▲ / ▼ / ◀ / ▶], then press [ENTER].
e.g.) HDD

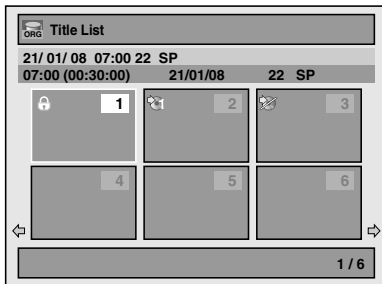

The title is now registered in the dubbing list.

- 6 Repeat steps 4 to 5 until you register all the titles to be dubbed.**
e.g.) HDD → DVD

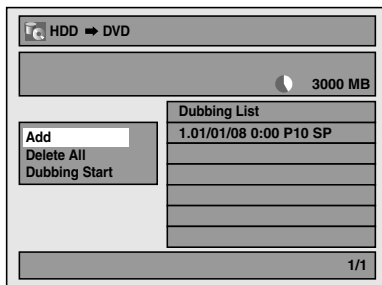

To delete a title:

- 1 Go to the dubbing list, then select a title using [▲ / ▼]. Then press [ENTER].
- 2 Select "Delete" using [▲ / ▼], then press [ENTER].
- 3 Select "Yes" using [▲ / ▼], then press [ENTER].

To move a title:

- 1 Go to the dubbing list, then select a title using [▲ / ▼]. Then press [ENTER].
- 2 Select "Move" using [▲ / ▼], then press [ENTER].
- 3 Select a desired insert point using [▲ / ▼], then press [ENTER].

To erase all the titles in the dubbing title list:

- 1 Select "Delete All" in the dubbing menu using [▲ / ▼], then press [ENTER].
- 2 Select "Yes" using [▲ / ▼], then press [ENTER]. Final confirmation message will appear.
- 3 Select "Yes" using [▲ / ▼], then press [ENTER].
 - To go back and forth between dubbing menu and dubbing list, use [◀ / ▶].

- 7 After adding all the titles you want, select "Dubbing Start" in the dubbing menu using [▲ / ▼], then press [ENTER].**

- 8 Select a desired recording mode using [◀ / ▶], then press [ENTER].**
e.g.) HDD → DVD

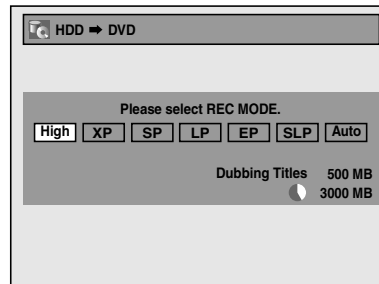

Confirmation message will appear.

- Depending on the dubbing direction, the available recording mode varies.
- When dubbing from HDD to DVD, you can select "High" to perform the high speed dubbing (refer to "Recording Mode for Dubbing" on page 53 for more details).

- 9 Select "Yes" using [▲ / ▼], then press [ENTER].**

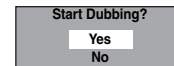

If dubbing continues when timer recording starts, the next display will appear.

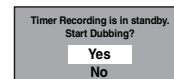

Dubbing will start.

- It may take awhile to prepare for the dubbing.

To stop the dubbing in progress:

Press [■ STOP] on the front panel.
Press [STOP ■] for 2 seconds on the remote control.

Note

- The device mode change is available only between HDD and DVD during the videotape to the HDD / DVD dubbing.
- Dubbing will be cancelled 2 minutes before starting timer recording.

VHS to HDD / DVD

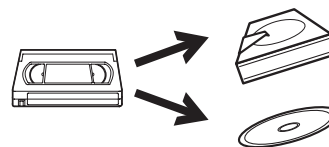

3 VHS → HDD

Select "VCR → HDD" using [▲ / ▼], then press [ENTER].

VHS → DVD

Select "VCR → DVD" using [▲ / ▼], then press [ENTER].

e.g.) VCR → HDD

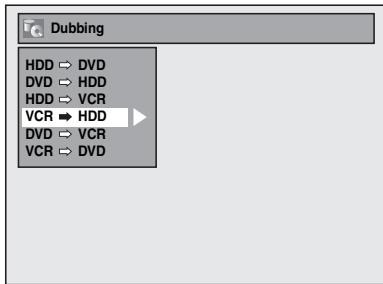

4 Select a desired recording mode using [▲ / ▼], then press [ENTER].

e.g.) VCR → HDD

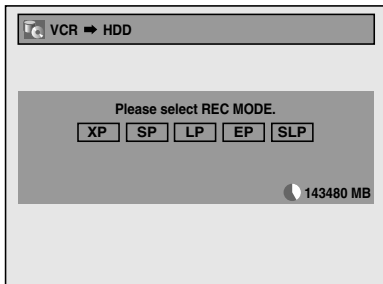

Confirmation message will appear.

5 Select “Yes” using [▲ / ▼], then press [ENTER].

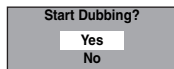

If dubbing continues when timer recording starts, the next display will appear.

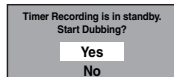

Dubbing will start.

- It may take awhile to prepare for the dubbing.

To stop the dubbing in progress:

Press [■ STOP] on the front panel.
Press [STOP ■] for 2 seconds on the remote control.

Note

- Dubbing will start where the tape is stopped.
- After starting dubbing, the picture may be distorted because of the digital tracking function. This is not a malfunction. Be advised to play back the videotape until the picture is stabilised, then set the starting point at which you want to start recording, and start dubbing.
- Dubbing will be cancelled 2 minutes before starting timer recording.

HDD / DVD to VHS

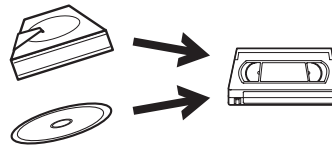

3 HDD → VHS

Select “HDD → VCR” using [▲ / ▼], then press [ENTER].

DVD → VHS

Select “DVD → VCR” using [▲ / ▼], then press [ENTER].

e.g.) HDD → VCR

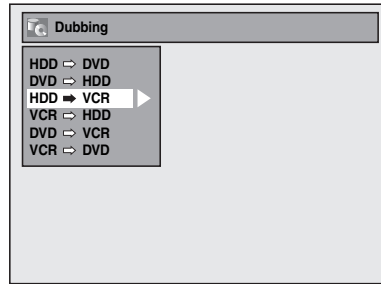

4 Select “Add” using [▲ / ▼], then press [ENTER].

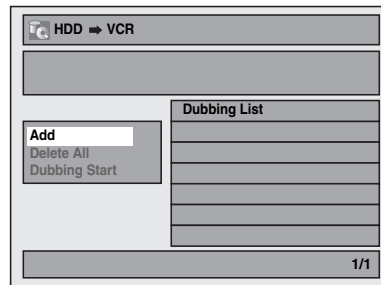

- If you have registered any dubbing before, they will be listed in the dubbing title list.

5 Select a desired title using [▲ / ▼ / ◀ / ▶], then press [ENTER].

e.g.) HDD

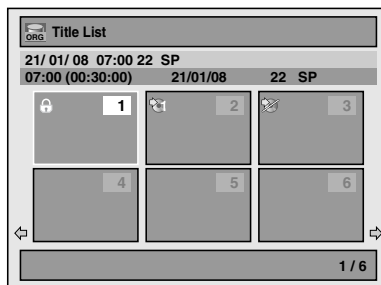

The title is now registered in the dubbing list.

Introduction

Connections

Basic Setup

Recording

Playback

Editing

Function Setup

VHS Functions

Others

6 Repeat steps 4 to 5 until you register all the titles to be dubbed.

e.g.) HDD → VCR

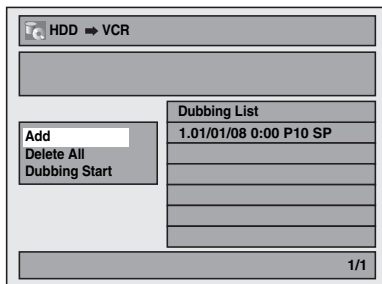

To delete a title:

- 1 Go to the dubbing list, then select a title using [▲ / ▼]. Then press [ENTER].
- 2 Select "Delete" using [▲ / ▼], then press [ENTER].
- 3 Select "Yes" using [▲ / ▼], then press [ENTER].

To move a title:

- 1 Go to the dubbing list, then select a title using [▲ / ▼]. Then press [ENTER].
- 2 Select "Move" using [▲ / ▼], then press [ENTER].
- 3 Select a desired insert point using [▲ / ▼], then press [ENTER].

To erase all the titles in the dubbing title list:

- 1 Select "Delete All" in the dubbing menu using [▲ / ▼], then press [ENTER].
- 2 Select "Yes" using [▲ / ▼], then press [ENTER]. Final confirmation message will appear.
- 3 Select "Yes" using [▲ / ▼], then press [ENTER].

• To go back and forth between dubbing menu and dubbing list, use [◀ / ▶].

7 After adding all the titles you want, select "Dubbing Start" in the dubbing menu using [▲ / ▼], then press [ENTER].

8 Select a desired recording mode using [◀ / ▶], then press [ENTER].

e.g.) HDD → VCR

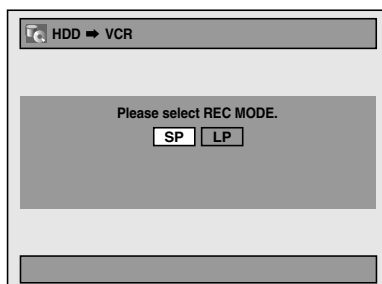

Confirmation message will appear.

- Depending on the dubbing direction, the available recording mode varies.

9 Select "Yes" using [▲ / ▼], then press [ENTER].

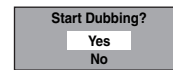

If dubbing continues when timer recording starts, the next display will appear.

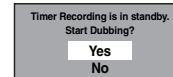

Dubbing will start.

- It may take awhile to prepare for the dubbing.

To stop the dubbing in progress:

Press [■ STOP] on the front panel.

Press [STOP ■] for 2 seconds on the remote control.

Note

- Dubbing will be cancelled 2 minutes before starting timer recording.

Setting a Disc to Protect



To prevent accidental over-recording, editing or erasing of recordings, you can protect them using "Setup" menu.

Insert a recordable disc.

- 1 In stop mode, press [SETUP].
- 2 Select "DVD Menu" using [▲ / ▼], then press [ENTER].
- 3 Select "Disc Protect OFF → ON" using [▲ / ▼], then press [ENTER].
- 4 Select "Yes" using [▲ / ▼], then press [ENTER].

The disc is protected.

5 Press [SETUP] to exit.

Note

- The Disc Protect setting is available only when a disc recorded in VR or +VR mode is inserted.
- You can select only "Disc Protect ON → OFF" when a protected disc is inserted.

To cancel the disc protect:

- Select "Disc Protect ON → OFF" at step 3, then select "Yes".
- If you insert a disc protected with this unit, "Disc Protect ON → OFF" will appear instead of "OFF → ON".

Finalising Discs



You will need to finalise discs to play them back in other units.

Finalising may take from several minutes up to an hour.

A shorter recording period on the disc will require a longer time period for finalisation. Do not unplug the mains cable during finalisation.

Insert a recordable disc before finalising.

- 1** In stop mode, press [SETUP].
- 2** Select "DVD Menu" using [▲ / ▼], then press [ENTER].
- 3** Select "Finalise" using [▲ / ▼], then press [ENTER].
- 4** Select "Yes" using [▲ / ▼], then press [ENTER].

e.g.) VR mode DVD-RW disc

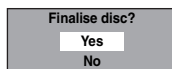

Finalising will start.

To cancel finalising (DVD-RW disc only):

At step 4, press [STOP ■]. Select "Yes" using [▲ / ▼], then press [ENTER]. Finalising is cancelled and the unit switches to stop mode.

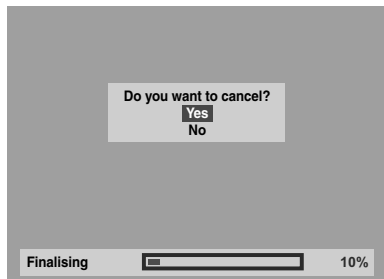

If "⊙" appears when [STOP ■] is pressed, you cannot cancel finalising because the finalising has already reached at a critical point in its process.

If "No" is selected and [ENTER] or [RETURN] is pressed, finalising is continued.

You cannot cancel finalising a DVD-R and DVD+RW/+R disc once it has started.

5 Finalising is complete.

Hint

- Finalising a disc in Video mode and +VR mode automatically creates a Title menu.
- After you finalise the DVD+RW disc, you can call up the title list by pressing [TOP MENU], or you can call up the Title menu by pressing [DISC MENU].
- Even after DVD+RW disc is finalised, you can still record or edit. After you finalise DVD-RW/-R or DVD+R disc, you cannot edit or record anything else on that disc.
- To release the finalisation of the disc, select "Undo Finalise" at step 3.
- To release the finalisation of the DVD+RW disc, make an additional recording to the disc.
- For DVD+RW disc, if you have added or deleted chapters, or made chapters hidden, you must finalise the disc before being able to see those effects on other units. To play back discs other than DVD+RW disc in other DVD players, you will need to finalise.

Note

- If you insert a DVD-RW disc finalised with this unit, "Undo Finalise" will appear instead of "Finalise".
- DO NOT power off during finalising. This may result in a malfunction.

Auto Finalise



You can finalise discs automatically when the disc space runs out if you set this in "Setup" menu.

- 1** In stop mode, press [SETUP]. Select "General Setting" using [▲ / ▼], then press [ENTER].
- 2** Select "Recording" using [▲ / ▼], then press [ENTER].
- 3** Select "Auto Finalise" using [▲ / ▼], then press [ENTER].
- 4** Select "ON" using [▲ / ▼], then press [ENTER].

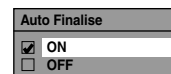

5 Press [SETUP] to exit.

Note

- Auto finalise function is not available for discs formatted in VR mode or a DVD+RW disc.

Introduction

Connections

Basic Setup

Recording

Playback

Editing

Function Setup

VHS Functions

Others

Playback

Basic Playback

Hint for HDD / DVD Playback

The contents of an HDD / DVD are generally divided into titles. Titles are sometimes further subdivided into chapters.

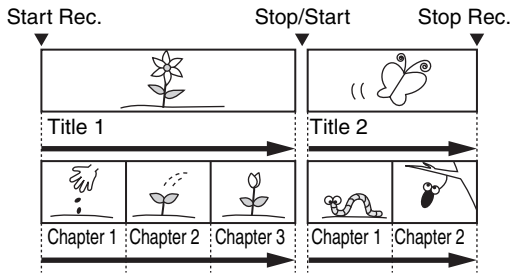

Playing Back an HDD / DVD-RW / DVD-R / DVD+RW / DVD+R Disc



1 Press [I/ON] ON/STANDBY] to turn on the unit.

Turn on the TV and be sure to select the input to which the unit is connected.

If you are playing back the titles in HDD, press [HDD] first, then proceed to step 5.

If you are playing back the titles in DVD, press [DVD] first.

2 Press [OPEN/CLOSE ▲] to open the disc tray.

3 Place the disc on the disc tray with its label facing up. Be sure to align the disc with the disc tray guide.

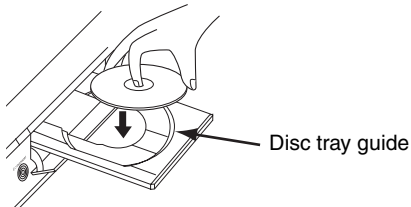

4 Press [OPEN/CLOSE ▲] to close the disc tray.

5 Press [TOP MENU] to display the Title list.

You can switch between the "Original" and "Playlist" in the HDD or VR mode DVD-RW disc using [DISC MENU].

6 Select the desired title using [▲ / ▼ / ◀ / ▶], then press [ENTER].

Pop up window will appear.

7 Select "Play From Start" using [▲ / ▼], then press [ENTER].

Playback will start.

For title in the HDD, you can also select "Resume Playback" to play from the resume points.

8 Press [STOP ■] to stop playback.

To eject the disc, press [OPEN/CLOSE ▲] to open the disc tray, then remove the disc. Press [OPEN/CLOSE ▲] to close the disc tray before turning off the unit.

Hint

- For DVD-R (Video mode), DVD-RW (Video mode) and DVD+R discs that are already finalised, a Title menu will be displayed instead of thumbnails.
- After you finalise the DVD+RW, you can call up the Title list by pressing [TOP MENU], or you can call up the title menu by pressing [DISC MENU].
- You can resume playback from where you stopped playing back the disc (Resume playback). See page 66 for details.
- You can also start playback by pressing [PLAY ▶] instead of [ENTER] at steps 6 and 7.

Note

- Some discs may start playback automatically.

Playing Back a DVD-V / Video CD (without PBC Function)



1 Follow steps 1 to 4 in "Playing Back an HDD / DVD-RW / DVD-R / DVD+RW / DVD+R Disc".

2 Press [PLAY ▶] to start playback.

Playback will start.

If you are playing back a DVD-Video, a menu may appear.

See pages 64 - 65 for details.

3 Press [STOP ■] to stop playback.

Note

- Some discs may start playback automatically.
- For playing back a Video CD with PBC function, see page 65.

Playing Back an Audio CD, MP3 or JPEG



1 Follow steps 1 to 4 in “Playing Back an HDD / DVD-RW / DVD-R / DVD+RW / DVD+R Disc” on page 60.

The “File List” will appear.

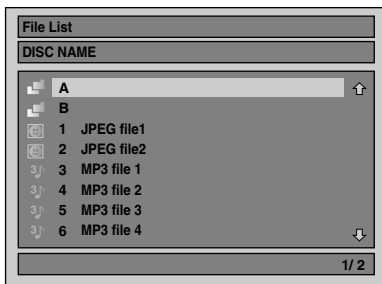

To exit the File List, press [TOP MENU] or press [STOP ■].

To resume the File List, press [TOP MENU].

2 Press [▲ / ▼] to select the desired folder or track / file, then press [ENTER].

If a track / file is selected:

Playback will start.

If a folder is selected:

The files in the folder will appear.

Press [▲ / ▼] to select the folder you want, then press [ENTER].

- Press [PLAY ►], [ENTER] or [▶] to move to any lower folders.
- Press [◀] or [RETURN] to move back to the folder above.

Hints for Audio CD tracks and MP3 / JPEG files:

- Folders are shown with the icon.
- Audio CD tracks are shown by .
- MP3 files are shown with the icon. Playback will start from the selected track and continue with each one after.
- JPEG files are shown with the .
- The unit can recognise up to 255 folders and up to 99 tracks / 999 files.
- Letters of a file / folder name overflowing the given space will be displayed as “...”.
- Unplayable folders and tracks / files may be displayed depending on the recording conditions.
- For MP3 file recorded in Variable Bit Rate (VBR), the unit may not display the actual elapsed time.
- If there are no files in the folder, “No Files” is displayed.
- High resolution or large-size JPEG files take a few moments to be displayed.
- It is not possible to play back progressive JPEGs (JPEG files saved in progressive format) on this unit.
- It is not possible to play back JPEG files of 12 MB or more.

It is recommended that files to be played back in this unit are recorded under the following specifications:

[MP3]

- Sampling frequency : 44.1 kHz or 48 kHz
- Constant Bit Rate : 112 kbps to 320 kbps

[JPEG] Size of picture

- Upper limit : 6,300 x 5,100 dots
- Lower limit : 32 x 32 dots
- Capacity limit : less than 12 MB

Note

- MP3 files cannot be recorded as digital sound using an MD or DAT deck.
- Files with extensions other than “.mp3 (MP3)” or “.jpg / .jpeg (JPEG)” will not be listed in the File List.
- Some folders or tracks listed in the File List may be unplayable due to their recording status.
- The File List displays only up to 8 folders and file names.

Notes on JPEG:

After file is displayed for 5 seconds or 10 seconds (set in the “Slide Show” on page 73), the display moves to the next file.

During JPEG playback, press [▶] or [◀] to rotate a picture 90 degrees clockwise or counterclockwise respectively. (Not available when the display menu appears.)

Playing Back a DivX®



1 Follow steps 1 to 4 in “Playing Back an HDD / DVD-RW / DVD-R / DVD+RW / DVD+R Disc” on page 60.

The “File List” will appear.

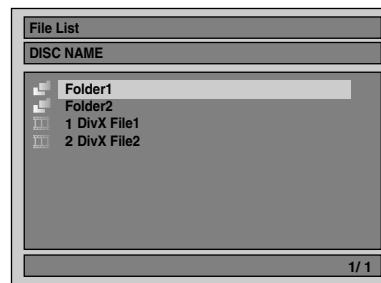

To exit the File List, press [TOP MENU] or press [STOP ■].

To resume the File List, press [TOP MENU].

2 Press [▲ / ▼] to select the desired folder or file, then press [ENTER].

If a file is selected:

Playback will start.

If a folder is selected:

The files in the folder will appear.

Press [▲ / ▼] to select the file or folder you want, then press [ENTER].

- Press [PLAY ►], [ENTER] or [▶] to move to any lower folders.
- Press [◀] or [RETURN] to move back to the folder above.

Introduction

Connections

Basic Setup

Recording

Playback

Editing

Function Setup

VHS Functions

Others

DivX® Subtitle

The subtitle created by the user can be displayed during DivX® playback.

1 After the DivX® file is selected, "Subtitle List" will appear.

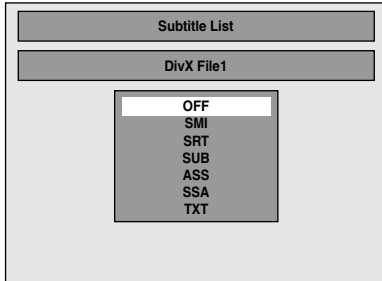

2 Select the desired extension you want to display using [▲ / ▼], then press [ENTER]. DivX® with the subtitle starts playback. The subtitle cannot be displayed when the setting is "OFF".

- If there is more than one extension, the extension selection will appear in "Subtitle List".

Note

- "DivX Subtitle" must be activated in the DivX Menu. (Refer to "DivX Subtitle" on page 91.)
- Playback file and the subtitle file must have the same name.
- Playback file and the subtitle file must locate in the same folder.
- Only the subtitle files with the following extensions are supported; .smi (.SMI), .srt (.SRT), .sub (.SUB), .ass (.ASS), .ssa (.SSA), .txt (.TXT). (.sub (.SUB) and .txt (.TXT) files may not be recognised.)
- The subtitles that exceed the playback time of the DivX® file will not be displayed.

DivX® VOD



This unit allows you to play back the files purchased or rented from DivX® Video-On-Demand (VOD) services. The files are available on the internet. When you purchase or rent DivX® VOD files on the internet, you will be asked to enter a registration code. This menu item provides you with the registration code.

- 1 Press [SETUP].
- 2 Select "General Setting" using [▲ / ▼], then press [ENTER].
- 3 Select "DivX" using [▲ / ▼], then press [ENTER].
- 4 Select "DivX® VOD" using [▲ / ▼], then press [ENTER].

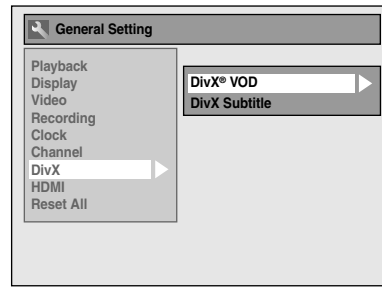

Your registration code will appear.



Note

- One registration code is only valid for one DivX® VOD file.
- You must first download the file from the internet and play it back on this unit before you are able to get another code.
- You must follow this step every time you purchase or rent a DivX® VOD file from the internet.
- For more information for DivX®, please visit <http://www.divx.com/vod>.

It is recommended that files to be played back in this unit are recorded under the following specifications:

[DivX®]

- Official DivX® Certified product
- Playable Codec of AVI files : DivX®3.x,
DivX®4.x,
DivX®5.x,
DivX®6.x
- Maximum size of image : 720 x 480 @30 fps
720 x 576 @25 fps
- Sampling frequency of audio : 8 kHz - 48 kHz
- Audio type : MPEG1 audio layer 3 (MP3), MPEG1 audio layer 2, Dolby Digital

Hint for the purchased or rental official DivX® Certified product

- When you purchased or rental a DivX® file through the official site of DivX® Video which is called DivX® Video-On-Demand (VOD) services, a registration code is required every time you get the new file from the DivX® VOD services. Refer to "DivX® VOD" on page 62.
- Some DivX® VOD files are restricted with the limited playable times (you cannot play them back beyond the limit). If your DivX® VOD file has such limit, the playback confirmation screen will appear.

Use [◀ / ▶] to select "Yes" if you want to play back the file, or to select "No" if you do not want to play it back. Then press [ENTER] to confirm the selection.

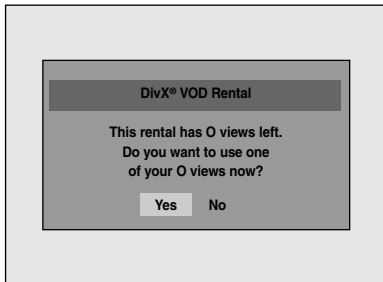

- You cannot play back the DivX® VOD files of which rental period has been expired. In such case, press [TOP MENU] and select other files that can be played back.

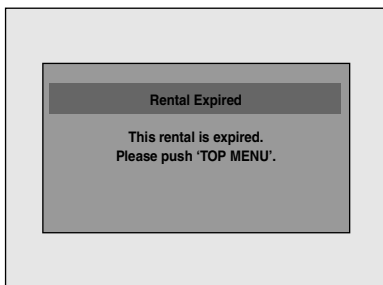

Hint

- DivX® is a codec (compression/decompression) that can compress images to a very small amount of data. The software can compress video data from almost any sources to the size that can be sent on the Internet without compromising visual quality of the images.
- A file with an extension of ".avi" and ".divx" is called an DivX® file. All files with the ".avi" extension are recognised as MPEG4.
- Files whose extension other than ".avi" and ".divx" will not be listed on the DivX® menu. However, unplayable groups or tracks may be displayed, depending on the recording conditions.
- Even if the file has an extension of either ".avi" and ".divx", this unit cannot play it back if it is recorded in the format other than DivX®.
- Folders are known as Groups; files are known as tracks.
- A symbol of  is shown on the top of the file name.
- A maximum of 255 folders or 999 files may be recognised in one disc.
- Up to 8 hierarchies can be recognised in one folder. Files in the 9th or deeper hierarchies cannot be played back.
- If the track extends beyond the scope of screen, a down arrow "↓" appears, indicating that the user can view another part on the next page. The current page number and the number of total pages are shown on the right of the down arrow "↓".
- Letters of a file / folder name overflowing the given space will be displayed as "...".
- You can play back the disc recorded in multi-session.
- It may take awhile for audio and images to be output after you inserted a disc and pressed [PLAY ▶].
- When playing back the files recorded in high bit rates, the images can be interrupted in some occasions.
- Although DivX® logo has been obtained for this unit, it may not be able to play back some data, depending on the characteristics, bit rates, or audio format settings, etc.
- Use the software recognised by the DivX, Inc. when you make DivX® files.
- A DivX® file whose file size exceeds 2 GB cannot be played back.
- If you try to play back the DivX® file that has the screen resolution which this unit does not support, the playback will be stopped and error message will appear.
- If a large-sized DivX® file is selected, it may take awhile to start the playback (over 20 seconds sometimes).
- If DivX® files written on CD discs cannot be played back, rewrite them on a DVD disc and try to play back.
- For more information for DivX®, please visit <http://www.divx.com>.

Introduction

Connections

Basic Setup

Recording

Playback

Editing

Function Setup

VHS Functions

Others

- If you insert a CD-RW/-R with DivX® files that are mixed with MP3 and JPEG files, the Playback Media Selection screen will be displayed. Please select "Video" and proceed to next step.

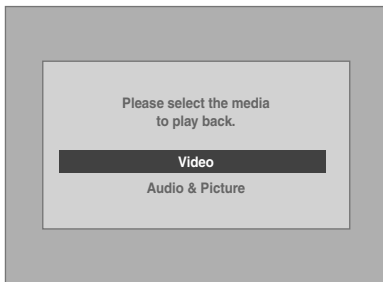

- Press **[DISC MENU]** to call up the Playback Media Selection screen in stop mode.
- If you select "Audio & Picture" instead of "Video" on the Playback Media Selection screen, this unit can play back MP3/JPEG files.
- You cannot play back the DivX® VOD files obtained with different registration codes on this unit. Press **[TOP MENU]** and select other files that can be played back.
- This unit does not support the DivX® file with UDF format.



Playing Back Discs Using the Disc Menu



A DVD contains a disc menu, which lists the contents and enables you to customise playback. The menu may offer choices for subtitle languages, special features, and chapter selection. Usually this information appears automatically when you start playback, but sometimes you need to press **[DISC MENU]** to display the menu.

1 Press **[DISC MENU]**.

If the feature is not available, "⊘" may appear on the TV screen.

2 Select an item using **[▲ / ▼ / ◀ / ▶]**, then press **[ENTER]**.

Repeat this step until all the features you want are set up or to start playing back the disc from the menu. The following operations are available.

[DISC MENU] button:

Displays the disc menu, which will vary among discs, and may be same with the Title menu.

[▲ / ▼ / ◀ / ▶] buttons:

Move the cursor from item to item on the screen.

[ENTER] button:

Selects the currently highlighted menu option.

[the Number buttons]:

Selects a numbered menu option (available on certain discs).

3 Press **[DISC MENU]** to exit the disc menu.

Note

- Menus vary among discs. Refer to the information accompanying the disc for details.

Playing Back a Disc Using the Title Menu



Some DVDs have a Title menu, which lists the titles available on the DVD. You can start playing back such discs at a specific title.

On this unit, if you finalise video mode or +VR mode discs, a Title Menu will be created automatically.

1 Press [TOP MENU].

The Title Menu will appear.

- For some discs, the Title Menu appears automatically.

If the feature is not available, “” may appear on the TV screen.

2 Select a desired item using [▲ / ▼ / ◀ / ▶], then press [ENTER].

The disc will start playing back at the title you selected. The following operations are available.

[TOP MENU] button:

Displays the DVD “Title Menu” which will vary between discs.

[▲ / ▼ / ◀ / ▶] buttons:

Move the cursor from item to item on the screen.

[ENTER] button:

Selects the currently highlighted menu option.

[the Number buttons]:

Selects a numbered menu option (available on certain discs).

3 Press [TOP MENU] to exit.

Note

- [TOP MENU] will not be available for some DVDs.
- Menus vary among discs. Refer to the information accompanying the disc for details.
- For DVD+RW discs finalised on this unit, press [DISC MENU] to display the Title Menu.

PBC Function for Video CDs



This unit conforms to ver.1.1 and ver.2.0 of the Video CD standard playback control (PBC) function. This enables you to play back interactive software using menu screens. Refer to the information accompanying the Video CD.

Ver.1.1 (without PBC function): You can still enjoy playback of pictures and music from the CD.

Ver.2.0 (with PBC function): “Pbc” will appear on the screen and display when playing back a Video CD with the PBC function.

Hint

- When playing back Video CDs with the PBC function, “Pbc” is displayed instead of the playing back time and current track indications on the front panel display.

Note

- Some operations cannot be performed unless the function is cancelled either automatically or intentionally by you.
- Operations that are not available when the PBC function is set to “ON” are indicated by the following symbol in this manual:



Playing Back a Video CD Using the Title Menu



1 When playing back a Video CD with the PBC function, the Title Menu will appear automatically.

2 Press [the Number buttons] to select the desired title.

Playback will start at the selected title.

3 Press [RETURN] to go back to the Title menu.

Note

- While the On-Screen Display appears, you cannot perform steps 2 and 3.

Introduction

Connections

Basic Setup

Recording

Playback

Editing

Function Setup

VHS Functions

Others

Cancelling and Recalling the PBC Function



Insert a Video CD.

- 1 In stop mode, press [SETUP].
- 2 Select "CD Playback Mode" using [▲ / ▼], then press [ENTER].
- 3 Select "PBC (Video CD only)" using [▲ / ▼], then press [ENTER].

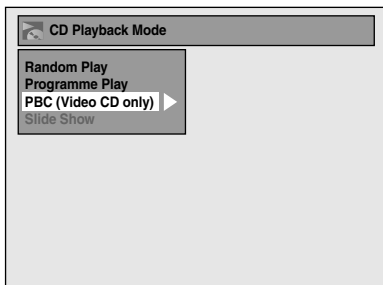

- 4 Select "OFF" using [▲ / ▼], then press [ENTER].
- 5 Press [SETUP] to exit.

To recall the PBC function, select "ON" at step 4 above.

Note

- The default setting of "PBC (Video CD only)" is "ON".

Special Playback

Resume Playback



You can resume playback from the point where you stopped it before.

- 1 During playback, press [STOP ■].

The resume message will appear.

- 2 Press [PLAY ▶].

In a few seconds, playback will resume from the point at which you stopped it before. Even if you turn off the unit, you can resume playback at the same point after turning back on the unit.

For title in the HDD, you can also play from the resume point by selecting "Resume Playback" at step 7 of "Playing Back an HDD / DVD-RW / DVD-R / DVD+RW / DVD+R Disc" on page 60.

To cancel the resume playback and start playing back the disc from the beginning:

Press [STOP ■] while playback is stopped.

For HDD:

You can set a resume point per every title.

For DVD-Videos, DVD+RW/+R, DVD-RW/-R, Video CD, Audio CD, MP3 files, JPEG files, and DivX® files:

You can set only one resume point per disc.

Note

- For Video CDs, if you turn PBC on using "Setup" menu, the resume function is cancelled.
- For MP3 and JPEG files, playback will resume from the beginning of the track at which playback was stopped.

Fast Forward / Fast Reverse



1 During playback, press [FWD ►►] or [REV ◀◀].

Each time you press [FWD ►►] or [REV ◀◀], the approximate speed will change as follows.

Fast forward or fast reverse playback across titles (for DVDs) or tracks / files (for Video CD / MP3 / DivX®) is not possible.

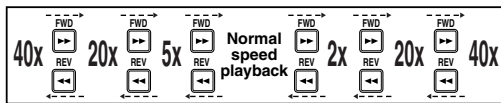

- For Audio CDs and MP3 files approximate speed is fixed at 8x with sound.
- For Video CDs, approximate forward / reverse speeds are 2x, 8x and 16x.
- For DivX® files, approximate forward speeds are 2x, 20x and 40x, and approximate reverse speeds are 5x, 20x and 40x.
- To return to playback at normal speed, press [PLAY ►].
- Picture quality of DivX® files in fast reverse is lower than that in fast forward.
- For some DivX® files, Fast forward/Fast reverse may not function.

Hint

- Forward / reverse speeds are indicated with icons as follows.

Forward (Approx. Speed):

2x: ►►

20x: ►►►

40x: ►►►►

Reverse (Approx. Speed):

5x: ◀◀

20x: ◀◀◀

40x: ◀◀◀◀

Variable Skip / Variable Replay



During playback, you can skip forward or backward by the amount of time you set in "Playback" menu. To set the time amount, refer to "8. Variable Skip / Replay" on page 88.

During playback, press [VARIABLE SKIP] if you want to skip forward. Press [VARIABLE REPLAY] if you want to skip backward.

Pause



1 During playback, press [PAUSE II].

Playback will pause with the sound muted.

2 Press [PLAY ►] to resume playback.

Rapid Playback



Rapid Playback function is available only during playback.

Available only on discs recorded in the Dolby Digital format, Rapid Playback plays back in a slightly faster/slower speed while keeping the sound output.

1 During playback, press [1.3x/0.8x PLAY].

- x0.8 : Press [1.3x/0.8x PLAY] once during playback. Plays back approximately at 0.8 times of normal playback.
- x1.3 : Press [1.3x/0.8x PLAY] twice during playback. Plays back approximately at 1.3 times of normal playback.
- : Press [1.3x/0.8x PLAY] thrice to play back in normal speed. No effects.

2 Press [PLAY ►] to resume playback.

Note

- Audio (language) setting cannot be changed while using this mode.
- This feature may not work at some point in a disc.
- Audio is PCM during Rapid Playback mode.
- When you select "PAL" in "TV System" (see page 88), this function is not available with discs recorded using the NTSC system.

Introduction

Connections

Basic Setup

Recording

Playback

Editing

Function Setup

VHS Functions

Others

Step by Step Playback



1 During playback, press [PAUSE ■].

2 Press [SKIP ◀◀ / ▶▶] repeatedly.

Each time you press [SKIP ▶▶], playback will go forward one frame (or step) at a time with the sound muted.

To go backward one frame (or step), press [SKIP ◀◀].

Press and hold [SKIP ▶▶] to continue going forward.

To continue going backward, press and hold [SKIP ◀◀].

3 Press [PLAY ▶] to resume playback.

Note

- Only step by step forward is available when playing back Video CDs and discs with DivX® files.

Slow Forward / Slow Reverse Playback



1 During playback, press [PAUSE ■], then press [FWD ▶▶] or [REV ◀◀].

Each time you press [FWD ▶▶] or [REV ◀◀], the approximate speed changes as follows. (The sound will remain muted.)

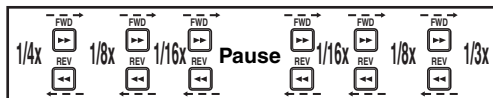

To return to normal playback, press [PLAY ▶].

Hint

- Forward / reverse speeds are indicated with icons as follows.

Forward (Approx. Speed):

1/16x: ▶▶▶

1/8x: ▶▶▶▶

1/3x: ▶▶▶▶▶

Reverse (Approx. Speed):

1/16x: ◀◀◀

1/8x: ◀◀◀◀

1/4x: ◀◀◀◀◀

Note

- For some DivX® files, Slow forward may not function.
- Only slow forward is available when playing back Video CDs and discs with DivX® files.

Zoom



1 During playback, press [DISPLAY].

2 Select the  icon using [◀ / ▶], then press [ENTER].

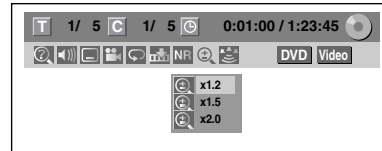

Four options are available, “x1.0”, “x1.2”, “x1.5” and “x2.0”. These are displayed excluding the current zoom rate.

3 Select the desired zoom factor to zoom using [▲ / ▼], then press [ENTER].

The zoom area is displayed.

4 Select the desired zoom position using [▲ / ▼ / ◀ / ▶], then press [ENTER].

Zoom playback will start.

Hint

- To cancel the zoom function, select “x1.0” using [▲ / ▼], then press [ENTER].

Note

- If selecting a smaller factor than that currently selected, the zoom area is not displayed.
- You cannot slide the zoomed picture on some JPEG files.

Marker Setup



You can assign a specific point on a disc to return later.

- 1 During playback, press [DISPLAY].
- 2 Select the icon using [◀ / ▶], then press [ENTER] within 1 second, or wait for 1 second to display the marker list.

e.g.) Marker setup menu for DVD-Video

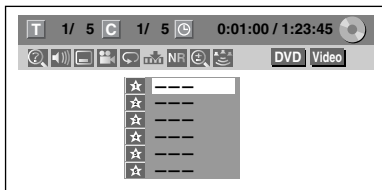

- 3 Select the desired marker number using [▲ / ▼]. When the disc reaches the desired point, press [ENTER].

The title (track) number and the time are displayed.

- 4 To return to the marker, select the desired marker number using [▲ / ▼], then press [ENTER].

Hint

- To clear a marker, select the marker number you want to clear, then press [CLEAR].
- You can mark up to 6 points.

Note

- All markers are erased when you perform the following operations.
 - Opening the disc tray (CD/DVD only)
 - Turning off the power (CD/DVD only)
 - Making additional recording on the disc (DVD only)
 - Editing any title (DVD only)
 - Dividing the title (HDD only)
 - Deleting a scene of the title (HDD only)
 - Changing the mode between Original and Playlist. (VR mode DVD-RW disc only)
- Marker setting is not available when you play back the Video CD with PBC function.

Chasing Playback during Recording



You can play back a title being recorded from the beginning while recording continues.

- 1 During recording, press [PLAY ▶].
Playback of the title you are recording will start from the beginning.
 - Elapsed playback time will be displayed on the front panel display.
- 2 To stop the playback, press [STOP ■] once.

The front panel display will switch back to show the elapsed recording time.

If you press [STOP ■] twice, it will stop the recording.

Using the [TIME SLIP] button

With [TIME SLIP], even if you leave your couch while you are watching TV through this unit, you can come back and watch the rest of the programme right from where you left at any the convenient time with just one button.

- 1 When you leave the TV, press [TIME SLIP] twice. (When you are recording the TV programme to HDD, press once.)

Unless the unit is in HDD recording mode, the unit will start recording the TV broadcast with the first press. With the second press, or the first press when the unit is in HDD recording mode, the image will be paused while the recording continues. (It is as if you have paused the live TV broadcast.)

- 2 When you come back, press [TIME SLIP] again.

The pause will be cancelled, and the playback will start from the point where the image is paused in step 1.

- While viewing the recorded content, you can pause and resume the playback by pressing [TIME SLIP].

- 3 Press [STOP ■] once to resume live TV.
Press [STOP ■] twice to stop the recording.

Introduction

Connections

Basic Setup

Recording

Playback

Editing

Function Setup

VHS Functions

Others

Note

- **[TIME SLIP]** is not available during DVD recordings.
- If you press **[TIME SLIP]** when the unit is in DVD mode, the output mode will automatically be switched to HDD, and the unit will start chasing playback of the title being recorded.
- You can also use the special playback functions such as **[REV ◀◀]**, **[FWD ▶▶]** etc. during chasing playback mode.
- The programs you recorded with **[TIME SLIP]** will be stored in the title list.
- **[REC ●]** is invalid during chasing playback.
- You can no longer fast forward the playback when it comes to a few seconds before the current recording point.

Simultaneous Playback and Recording



With regard to HDD, you can continue recording a programme while playing back another title in the same component (HDD).
To do so, press **[TOP MENU]** during recording and select a title you like to play back, and then press **[PLAY ▶]**.
(You can also start the playback from the title list menu.)

To playback a title being recorded while continuing to record, refer to “Chasing Playback during Recording” on page 69 (available only with HDD).

Note

- Video CD, Audio CD, MP3/JPEG files recorded on a disc and DivX® files can also be played back during HDD recording.

Search

Title / Chapter Search



Using **[SKIP ◀◀ / ▶▶]** buttons

- 1 During playback, press **[SKIP ▶▶]** to skip the current title or chapter and move to the next.



The unit moves to the next title or chapter one after another.

To go back to the previous title or chapter, press **[SKIP ◀◀]** twice in quick successions.

Note

- With regard to HDD, chapter search using **[SKIP ◀◀ / ▶▶]** is available only within the same title.

Using the **[DISPLAY]** button

- 1 During playback, press **[DISPLAY]**.
- 2 Select the  icon using **[◀ / ▶]**, then press **[ENTER]**.
 for the title number is highlighted.

Searching for a Title:

- 3 Enter the desired title number to search for using **[▲ / ▼]** or **[the Number buttons]**, then press **[ENTER]**.

Title search will start.

Hint

- Total number of chapters and playback time of the selected title are also displayed.

Searching for a Chapter:

- 3 Press **[◀ / ▶]** to highlight the number displayed in the right side of the  icon.
- 4 Enter the desired chapter number to search for using **[▲ / ▼]** or **[the Number buttons]**, then press **[ENTER]**.

Chapter search will start.

Hint

- The title number and playback time of the selected chapter are also displayed.

Track Search



Using [SKIP ◀◀ / ▶▶] buttons

- 1 During playback, press [SKIP ▶▶] to skip the current track and move to the next.

The unit moves to the next track one after another.

To go back to the previous track, press [SKIP ◀◀] twice in quick successions. The unit moves backward one track at a time.

Using the [DISPLAY] button

For audio CD, skip to step 2.

- 1 During playback, press [DISPLAY].
- 2 Select the icon using [◀ / ▶], then press [ENTER].
 T for the track number is highlighted.
- 3 Enter the desired track number to search for using [▲ / ▼] or [the Number buttons], then press [ENTER].

Track search will start.

Hint

- For Video CDs, you can perform the track search function in stop mode without turning PBC off manually.

Note

- During Random playback or Programme playback, you cannot search the desired track.

Direct Search



You can search the desired track directly.

Using [the Number buttons]

- 1 During playback, if the display menu is not displayed, press [the Number buttons] to enter the desired track number.

Note

- During Random playback or Programme playback, you cannot search the desired track directly.

Time Search



For audio CD, skip to step 2.

- 1 During playback, press [DISPLAY].
- 2 Select the icon using [◀ / ▶], then press [ENTER].
 T for the title or track number is highlighted.
- 3 Press [◀ / ▶] to highlight .
- 4 Enter the desired time to search for using [▲ / ▼] or [the Number buttons], then press [ENTER].

Time search will start.

Note

- During Random playback or Programme playback, you cannot search the desired time.
- The title number and chapter number of the setting time are also displayed.
- Time search function is available only in the same track or title.

Introduction

Connections

Basic Setup

Recording

Playback

Editing

Function Setup

VHS Functions

Others

Repeat / Random / Programme Playback / Slide Show

Repeat Playback



For audio CD or MP3, skip to step 2.

- 1 During playback, press [DISPLAY].
- 2 Select the  icon using [◀ / ▶], then press [ENTER] within 1 second, or wait for 1 second to display the selection menu.
- 3 Select the desired option to repeat using [▲ / ▼], then press [ENTER].

The selected repeat playback will start.
The following operations are available.

Title:

The current title will be played back repeatedly. (HDD, DVD only)

Chapter:

The current chapter will be played back repeatedly. (HDD, DVD only)

All:

The current disc will be played back repeatedly. (DVD-RW (VR mode), Audio CD, Video CD, MP3, JPEG and DivX® only)

A-B:

The A-B point will be played back repeatedly. (HDD, DVD, Audio CD, Video CD and DivX® only)
When pressing [ENTER] while A-B is highlighted, A-B repeat is set.

- Press [ENTER] again to decide the starting point (A).
- Press [ENTER] after setting point (A) to select the ending point (B).

Track:

The current track will be played back repeatedly. (Audio CD, Video CD, MP3, JPEG and DivX® only)

Group:

The current group will be played back repeatedly. (MP3, JPEG and DivX® only)

Hint

- To cancel the repeat playback, select "OFF" at step 3. The repeat setting is also cancelled when you stop playback.

Note

- Point B for the repeat A-B playback should be set within the same title or track as point A.
- You cannot select "Group" during the random playback of MP3 and JPEG files.
- Chapter / Track repeat will be cancelled whenever a Chapter / Track is skipped forward or backward.
- For some DivX® files, A-B Repeat playback may not function.
- For Video CDs with PBC function, repeat playback does not work while the PBC function is on.

Random Playback



You can use this function to play back a disc randomly instead of in the recorded order.

- 1 In stop mode, press [SETUP].
- 2 Select "CD Playback Mode" using [▲ / ▼], then press [ENTER].
"CD Playback Mode" menu will appear.
- 3 Select "Random Play" using [▲ / ▼], then press [ENTER].
Random playback will start.

Hint

- To cancel random playback, press [STOP ■] twice during random playback. "OFF" appears on the screen.
- For Video CDs with PBC function, the PBC setting will be switched to off automatically when you start random playback.

Note

- During random playback, if you forward the track to the end, the playback speed of the next track will be normal.
- During random playback, you cannot use the search function except for the search with [SKIP ◀◀ / ▶▶]. By pressing [SKIP ◀◀], you can return only to the beginning of the current track.

Programme Playback



You can programme the disc to play back in your desired order.

- 1 Follow steps 1 to 2 in "Random Playback" on this page.
- 2 Select "Programme Play" using [▲ / ▼], then press [ENTER].

- 3** Select the desired track using [▲ / ▼], then press [ENTER] or [▶].

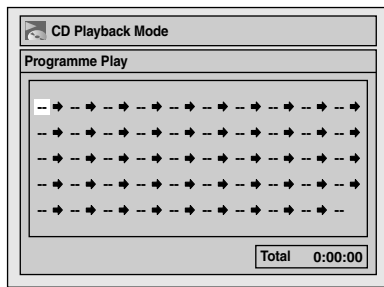

- 4** Press [PLAY ▶] to start programme playback.

Hint

- To erase tracks you selected, press [CLEAR].
- You can make up to 50 track settings.
- To cancel programme playback, press [STOP ■] twice during programme playback. "OFF" appears on the screen.
- You may also select the desired track using [the Number buttons] at step 3.
- For Video CDs with PBC function, the PBC setting will be switched to off automatically when you start programme playback.

Note

- During programme playback, if you forward the track to the end, the playback speed of the next track will be normal.
- During programme playback, you cannot use the search function except for the search with [SKIP ◀◀ / ▶▶].

Slide Show



You can select the display time between 5 seconds and 10 seconds.

- 1** Follow steps 1 to 2 in "Random Playback" on page 72.
- 2** Select "Slide Show" using [▲ / ▼], then press [ENTER].
- 3** Select the display time using [▲ / ▼], then press [ENTER].
- 4** Press [SETUP] to exit.

Note

- Large-size JPEG files take a few moments to be displayed.

Selecting the Format of Audio and Video

You can select the format of audio and video to suit the content of the disc you are playing back.

Switching Subtitles



Many DVD-Videos have subtitles in one or more languages. The available languages are usually printed on the disc case. You can switch subtitle languages at any time during playback.

- 1** During playback, press [DISPLAY].

Or press [SUBTITLE] during playback and follow from step 3.

- 2** Select the  icon using [◀ / ▶], then press [ENTER] within 1 second, or wait for 1 second to display the selection menu.

- 3** Select the desired subtitle language using [▲ / ▼], then press [ENTER].

Subtitles are displayed in the selected language. If you select "OFF", subtitles will disappear.

Note

- With some discs it is only possible to change the subtitle language from the disc menu. Press [TOP MENU] or [DISC MENU] to display the disc menu.
- If a 4-digit language code appears in the subtitle menu at step 3, refer to the "Language Code" on page 101.
- For discs with DivX® files, the screen only displays the number of subtitle languages.

Switching Audio Soundtrack



When playing back a DVD-Videos recorded with two or more soundtracks (often in different languages), you can switch among them during playback.

When playing back the titles in HDD or VR mode DVD-RW discs recorded with bilingual audio, you can switch to main audio (L), sub audio (R) or a combination of both (L / R).

When playing back Audio CDs or Video CDs, you can switch among the left, the right channel and stereo. For audio CD, skip to step 2 or press [AUDIO ⏏] and skip to step 3.

- 1** During playback, press [DISPLAY].

Or press [AUDIO ⏏] during playback and follow from step 3.

Introduction

Connections

Basic Setup

Recording

Playback

Editing

Function Setup

VHS Functions

Others

- 2** Select the  icon using [**◀** / **▶**], then press [**ENTER**] within 1 second, or wait for 1 second to display the selection menu.

- 3** Select a desired audio soundtrack or audio channel using [**▲** / **▼**], then press [**ENTER**].

With a DVD-Video, VR mode DVD-RW, or DivX® files:

Audio soundtrack will switch.

Example:

English → Spanish → French

If the title contains both main and sub audio, you can further select L (main), R (sub), L/R (mixed of main and sub).

With an Audio CD or Video CD:

The Audio channel will switch.

Example:

L/R → L → R

Note

- For some discs, it is only possible to change the soundtrack from the disc menu. Press [**TOP MENU**] or [**DISC MENU**] to display the disc menu.

Switching Virtual Surround System



You can enjoy stereophonic virtual space through your existing 2 channel stereo system.

For audio CD or MP3, skip to step 2.

- 1** During playback, press [**DISPLAY**].
Display menu will appear.
- 2** Select the  icon using [**◀** / **▶**], then press [**ENTER**] within 1 second, or wait for 1 second to display the selection menu.

Virtual Surround menu will appear.
e.g.) DVD-Video

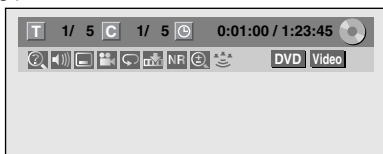

- 3** Select "OFF", "Type 1" or "Type 2" using [**▲** / **▼**], then press [**ENTER**].
e.g.) DVD-Video

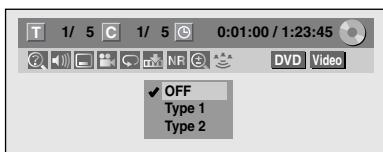

- OFF: No effect
- Type 1: Natural effect
- Type 2: Emphasised effect

Note

- Select Virtual Surround to "OFF" in case the sound is distorted.
- The setting will be kept "OFF" when the unit is turned off.



Switching Camera Angles



Some DVD-Videos feature scenes shot from two or more angles. The disc case is usually marked with an angle icon if the disc has multi-angle scenes.

- 1** During playback, press [**DISPLAY**].
The angle icon appears when a switching camera angle is available. (Available only when the angle icon appears in bottom right on the TV screen.)
- 2** Select the  icon using [**◀** / **▶**], then press [**ENTER**].
The angle will switch each time you press [**ENTER**].

Note

- If the Angle Icon setting is "OFF" in "Setup" menu, the  icon will appear only when the disc is played back and the Display menu appears. (See page 88.)
- Even when the  icon is not displayed, you can select the angle if the currently played back title has at least two multi-angle scenes.

Reducing Block Noise



- 1** During playback, press [**DISPLAY**].
- 2** Select the **NR** icon using [**◀** / **▶**], then press [**ENTER**] within 1 second, or wait for 1 second to display the selection menu.
Noise Reduction menu will appear.

- 3** Select the desired option using [**▲** / **▼**], then press [**ENTER**].

This function reduces noise in the playback picture. When playing back discs recorded in long time modes such as EP or SLP, select "Type 1" or "Type 2". "Type 2" is more effective. When playing back discs with a little noise, such as DVD-Videos, select "OFF".

Editing

Guide to a Title List

Title list allows you to check the titles recorded on the disc easily. You can choose a title to play back from this list and easily edit the titles as you prefer.

Press [HDD] or [DVD], then press [TOP MENU].

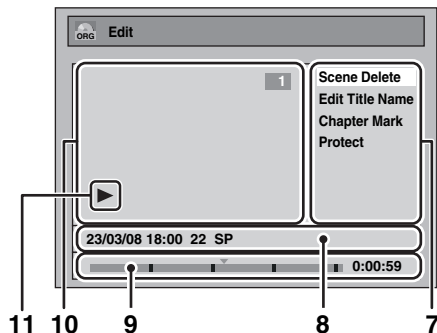
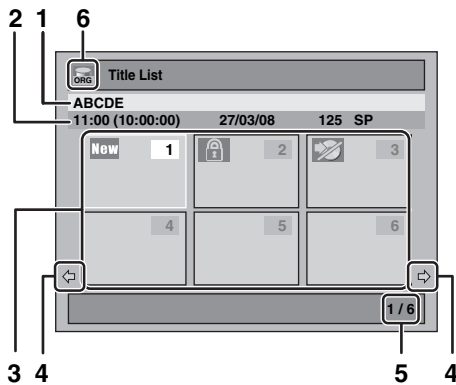

- 1 Title name.
- 2 Title information, which displays recorded time, length of the title, date / month / year, recorded CH, and the recording mode.
- 3 Title list: List of titles recorded on the HDD or disc. Each title is indicated by its index picture. Index picture for the selected title can be seen in motion. Following icons may be displayed on the index picture.

: Indicating the title has never been played back yet.

: Indicating the title is protected.

: Indicating the title is a copy-protected title.

: Indicating the title is a copy-once programme.

: If you call up the title list while recording, "●" will be displayed on the index picture of the title currently being recorded.

For DVD+RW/+R, empty title always appears at the last of the title list.

4 Arrow: Indicating there is a previous / next page.

5 Title list page number: Current page / total pages.

6 Title list icon, which indicates a type of the displayed title list.

: HDD (Original) mode

: HDD (Playlist) mode

: VR (Original) mode

: VR (Playlist) mode

: +VR mode

: Video mode

7 Submenu: Submenus for the selected menu are displayed here.

8 Title name (editable): If you do not name the title, the recorded date, time, channel, and the recording mode are displayed here.

9 Progress bar: Indicating the progress of the playback.

10 Preview window: Preview of the selected title is displayed here.

11 Playback status: Indicating the current playback status of the selected title.

Press [RETURN] to exit the title list.

Editing Discs

You will find editing discs is easy. This unit offers convenient edit functions.

You can edit the following from a title list.

- Assigning a name to a title
- Dividing a title
- Combining titles
- Adding titles to a Playlist
- Erasing all Playlist
- Setting or releasing the title protection
- Adding or deleting chapter marks
- Deleting titles or parts of titles

(Possible editing functions depend on the recording format and editing method.)

What "Original" or "Playlist" is for?

There are 2 types for the title list: Original and Playlist.

Original:

Original is the list of the recorded programmes (titles) when they are recorded. Original is available for HDD and DVD-RW. Please note that editing the titles in the Original is like editing the original data. For example, if you erase a title in the Original, the title cannot be recovered.



: Available to edit in the HDD Original



: Available to edit in the VR mode DVD-RWs Original

Playlist:

Playlist is the copy of the Original. You can edit the titles in the Playlist as you like without affecting the original data in the Original. It works like a backup for the Original. Delete a Playlist does not delete the corresponding Original. But if you delete an Original, the corresponding Playlists will be deleted. Playlist is available only for the HDD and the VR mode DVD-RWs.



: Available to edit in the HDD Playlist



: Available to edit in the VR mode DVD-RWs Playlist

About Edit Mark:

Edit marks will be added automatically where title is edited, for example where a title is divided or combined. These marks work as chapter marks when you search for a chapter, but cannot be deleted like chapter marks. Also, when a title with chapter marks are dubbed from DVD to the HDD, those marks become edit marks once they are dubbed to the HDD.

Using these editing functions to modify copyrighted content for any purpose other than your private viewing may be prohibited under the Copyright Laws of the United States and other countries, and may subject you to civil and criminal liability.

Note

- A Playlist is not available for DVD-R or Video mode DVD-RW and DVD+RW/+R discs.
- It is not possible to edit a disc recorded in another video system other than PAL, such as NTSC.
- After finalising a DVD-RW/-R or DVD+R disc, you cannot edit any information that is on that disc.

Deleting Titles

You can delete titles you do not want to keep. When an Original is deleted from HDD or VR mode DVD-RW disc, the recordable disc space will increase. Even when a Playlist is deleted, the original of the Playlist will remain, and recordable disc space will not increase. Recordable disc space of Video mode DVD-RW and DVD+RW disc will increase when the last title on the title list is deleted. However, deleting the title will not change recordable disc space for DVD-R and DVD+R disc.

Note

- It is not possible to retrieve deleted titles.

If you edit the HDD, press [HDD] first.
If you edit a disc, press [DVD] first.

1 In stop mode, press [TOP MENU].

Title List will appear.

For HDD and VR mode DVD-RW disc, press [DISC MENU] to switch between “Original” and “Playlist”.

2 Press [ENTER] at the desired title with [▲ / ▼ / ◀ / ▶].

e.g.) VR mode DVD-RW disc

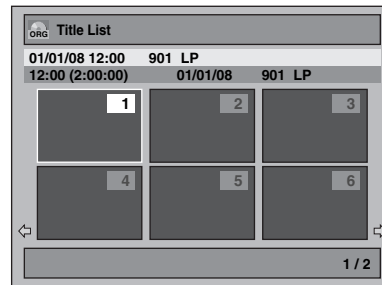

Pop up window will appear.

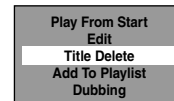
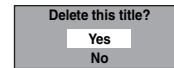
3 Select “Title Delete” using [▲ / ▼], then press [ENTER].**4 Select “Yes” using [▲ / ▼], then press [ENTER].**

“Are you sure?” will appear. Select “Yes” using [▲ / ▼], and then press [ENTER].
Title is deleted.

5 Press [RETURN] or [STOP ■] to exit.

Writing onto the disc starts.

It may take awhile to write the data on a disc.

Note

- If you delete the title in DVD+RW disc, deleted title will be displayed as “Empty”.
- You cannot overwrite on the “Empty”.

Deleting Selected Titles



You can delete titles which you do not need anymore. Please be advised that the titles once deleted cannot be brought back.

- 1 Press [HDD], then press [TOP MENU].
- 2 Select the title you want to delete using [\blacktriangle / \blacktriangledown / \blacktriangleleft / \blacktriangleright], then press [ENTER].
- 3 Select “Delete Plural Titles” using [\blacktriangle / \blacktriangledown], then press [ENTER].

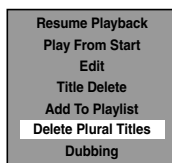

- 4 Select other title you want to delete using [\blacktriangle / \blacktriangledown / \blacktriangleleft / \blacktriangleright], then press [ENTER].

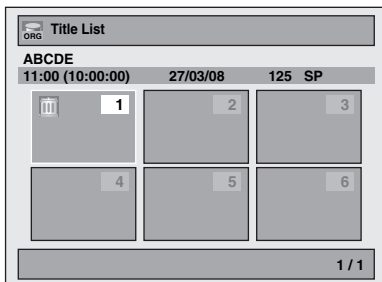

Trash mark will appear whose title number is highlighted for deletion.

- 5 Repeat step 4 until you select all the titles you want to delete.

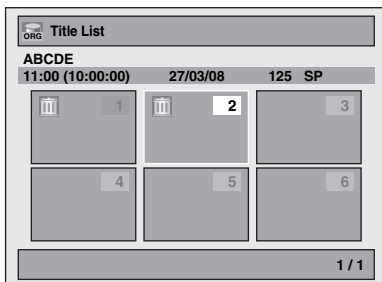

To remove the trash mark from the title:
Select the title with the trash mark, then press [ENTER].

- 6 Press [CLEAR].
Confirmation message will appear.

- 7 Select “Yes” using [\blacktriangle / \blacktriangledown], then press [ENTER].

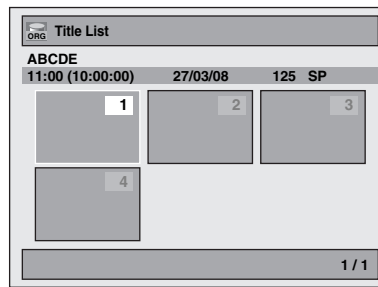

Final confirmation message will appear. Select “Yes”, then press [ENTER].

Editing Title Name



You can edit the title names from this menu. The title names you edit will appear on the title list.

If you edit the HDD, press [HDD] first.
If you edit a disc, press [DVD] first.

- 1 In stop mode, press [TOP MENU].
Title List will appear.
For HDD and VR mode DVD-RW disc, press [DISC MENU] to switch between “Original” and “Playlist”.
- 2 Press [ENTER] at the desired title with [\blacktriangle / \blacktriangledown / \blacktriangleleft / \blacktriangleright].
e.g.) VR mode DVD-RW disc

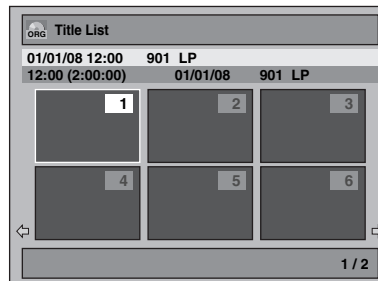

Pop up window will appear.

- 3 Select “Edit” with [\blacktriangle / \blacktriangledown], then press [ENTER].
Edit menu will appear.
- 4 Select “Edit Title Name” using [\blacktriangle / \blacktriangledown], then press [ENTER].
A window for entering the title name will appear.

Introduction

Connections

Basic Setup

Recording

Playback

Editing

Function Setup

VHS Functions

Others

- 5** To enter the title name, refer to “Guide to Editing Title Names” on this page.

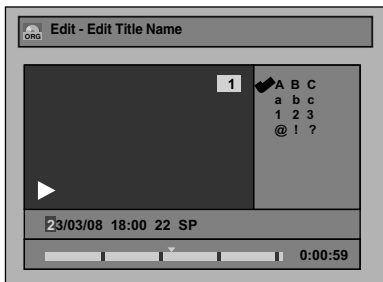

When you finish entering the title name, press [ENTER].

- 6** Select “Yes” using [▲ / ▼], then press [ENTER].

The name you edited becomes the title.

- 7** Press [RETURN] and then [RETURN] or [STOP ■] to exit.

Writing onto the disc starts.

It may take awhile to write the data on a disc.

Guide to Editing Title Names

Step 1 : Select the desired character set using [▲ / ▼], then press [ENTER].

Step 2 : Using the list below as a guide, press [the Number buttons] repeatedly until the desired letter appears.

Select Press	ABC	abc	123	@ ! ?
[0]	<space>	<space>	0	<space>
[1]	-	-	1	! " # \$ % & ' () * + , - . / : ; < = > ? @ [] ^ _ { }
[2]	ABC	abc	2	-
[3]	DEF	def	3	-
[4]	GHI	ghi	4	-
[5]	JKL	jkl	5	-
[6]	MNO	mno	6	-
[7]	PQRS	pqrs	7	-
[8]	TUV	tuv	8	-
[9]	WXYZ	wxyz	9	-

- Characters set will be changed to the “@!?” automatically if you press [1] after you selected the “ABC” or “abc” mode.

Note

- To delete letters, press [CLEAR] repeatedly. Press and hold [CLEAR] to delete all letters.
- Press [◀ / ▶] to move the cursor to the left or right.
- You can enter up to 30 letters.
- Unrecognisable characters will be replaced with asterisks (*). If you delete them, adjoining characters may change to asterisks (*) or other.

Adding or Deleting Chapter Markers Manually



You can add chapter marks to a title. After a title is marked with chapters, you can use the chapter search feature.

You can set a chapter mark anywhere you want.

If you edit the HDD, press [HDD] first.

If you edit a disc, press [DVD] first.

- 1** Follow the steps 1 to 3 in “Editing Title Name” on page 77.

- 2** Select “Chapter Mark” using [▲ / ▼], then press [ENTER].

- 3** Use [SKIP ◀◀ / ▶▶], [REV ◀◀], [FWD ▶▶], [PLAY ▶] and [PAUSE II] to find where you want to create a new chapter mark.

Or, use [SKIP ◀◀ / ▶▶] to find a chapter mark that you want to delete.

- 4** Select “Add” or “Delete” accordingly using [▲ / ▼], then press [ENTER].

e.g.) VR mode DVD-RW disc Original

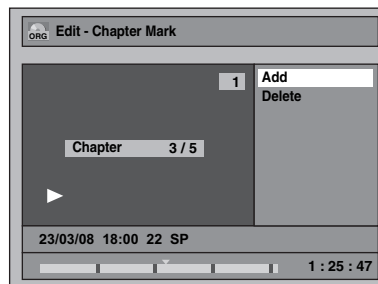

You cannot delete the first chapter of a title.

- 5** Select “Yes” using [▲ / ▼], then press [ENTER].

e.g.) VR mode DVD-RW disc Original

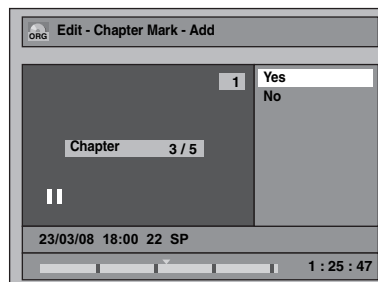

A chapter mark is added.

Adding a chapter mark:

If you select “Add” at step 4, a new chapter mark is created at the point you specified.

Deleting a chapter mark:

If you select “Delete” at step 4, the chapter mark you selected is deleted.

6 Press [RETURN].**7** Press [RETURN] again and then [RETURN] or [STOP ■] to exit.

For DVD, the data will be written onto the disc momentarily.

This operation may take awhile to be completed.

Note

- Maximum numbers of chapter for each media:
HDD : 99 chapters per title
VR mode DVD : 999 chapters per entire Playlist and Original
+VR mode DVD : 254 chapters per disc, 99 chapters per title
- Only with regard to DVD editing, you may not be able to add chapter marks depending on the duration of the title or the number of chapters.
- Only with regard to DVD editing, remaining time of the disc may decrease when adding chapter marks or increase when clearing chapter marks depending on the recording time or edited contents.

Adding or Deleting Chapter Marks at once for Video Mode DVD-RW disc



For titles in Video mode DVD-RW disc, you can set or edit chapter at every selected time interval at once. You can also clear all the chapter marks at once. You can only specify the interval of chapter marks that last for more than 5 minutes.

Press [DVD] first.

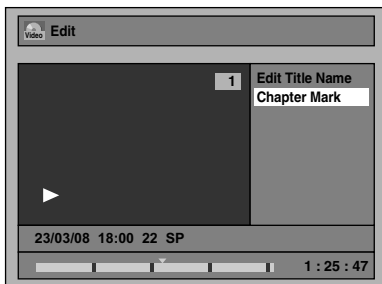
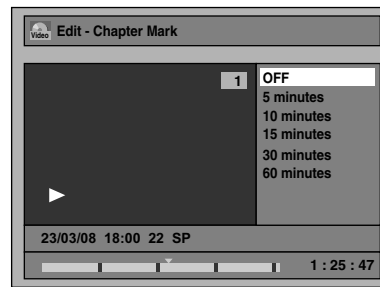
1 Follow the steps 1 to 3 in “Editing Title Name” on page 77.**2** Select “Chapter Mark” using [▲ / ▼], then press [ENTER].**3** Select the desired interval using [▲ / ▼], then press [ENTER].**4** Select “Yes” using [▲ / ▼], then press [ENTER].

Chapter marks are added.
If you select “OFF” at step 3, all the chapter marks are erased.

5 Press [RETURN] and then [RETURN] or [STOP ■] to exit.

Writing onto the disc starts.
It may take awhile to write the data on a disc.

Note

- You cannot select the chapter mark the title of which is less than 5 minutes.
- You cannot select a chapter mark interval that exceeds the length of a title.
- The length of chapters may slightly deviate from the one specified at the step 3.
- A chapter mark may be delayed depending on the recording content.
- Maximum number of chapter for Video mode DVD is 99 chapters per disc and title.
- You may not add any chapter marks to the title dubbed from HDD.

Hiding Chapters



You can hide chapters from the title list.
Hidden chapters are skipped during playback.

Press [DVD] first.

1 Follow the steps 1 to 3 in “Editing Title Name” on page 77.**2** Select “Hide Chapter” using [▲ / ▼], then press [ENTER].**3** Use [SKIP ◀◀ / ▶▶], [PLAY ▶] and [PAUSE II] to decide the chapter to be hidden.

Introduction

Connections

Basic Setup

Recording

Playback

Editing

Function Setup

VHS Functions

Others

- 4** Select “Hidden” using [\blacktriangle / \blacktriangledown], then press [ENTER].

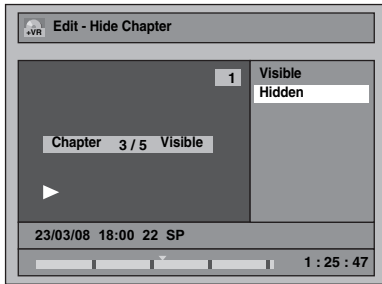

- 5** Press [RETURN].

- 6** Press [RETURN] again and then [RETURN] or [STOP ■] to exit.

Writing onto the disc starts.
It may take awhile to write the data on a disc.

If you want hidden chapters to be “Visible”, select the chapter to be shown. Then use [\blacktriangle / \blacktriangledown] to select “Visible” at the step 4 on this page.

Data will be written onto the disc momentarily.

Note

- “Hidden” will be displayed in the preview window while previewing the hidden chapter.
- When you make all chapters in the title “Hidden”, “Hidden” is displayed in a thumbnail of the title list.

Protecting Titles



To prevent the accidental editing or erasing of the titles, you can protect them in the Original menu.

If you edit the HDD, press [HDD] first.
If you edit a disc, press [DVD] first.

- 1** Follow the steps 1 to 3 in “Editing Title Name” on page 77.
- 2** Select “Protect” using [\blacktriangle / \blacktriangledown], then press [ENTER].

e.g.) VR mode DVD-RW disc Original

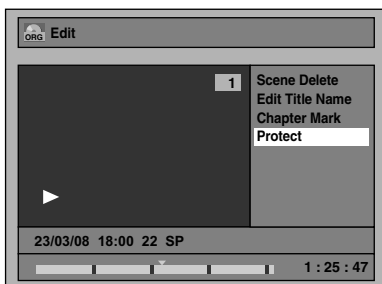

- 3** Press [ENTER] again.

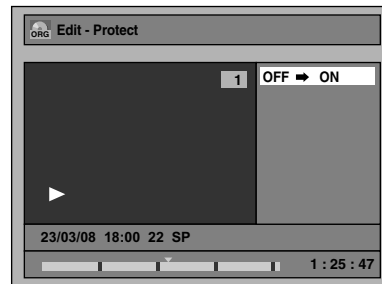

For DVD, writing onto the disc starts.
It may take awhile to write the data on a disc.

- If the title is already protected, “ON → OFF” will appear instead. Press [ENTER], to release the title from protection.
- The protected title will be marked with icon.

- 4** Press [RETURN] and then [RETURN] or [STOP ■] to exit.

For DVD, writing onto the disc starts.
It may take awhile to write the data on a disc.

To protect a whole disc
(VR mode DVD-RW and DVD+RW/+R discs only):

Select “Disc Protect OFF → ON” from the Disc Menu, then select “Yes”. Refer to “Setting a Disc to Protect” on page 58.

Dividing a Title



You can divide a title into two new titles.

If you edit the HDD, press [HDD] first.
If you edit a disc, press [DVD] first.

- 1** Follow steps 1 to 3 in “Editing Title Name” on page 77.
- 2** Use [SKIP \lll / \ggg], [REV \lll], [FWD \ggg], [PLAY \blacktriangleright] and [PAUSE II] to find where you want to divide the title.
- 3** Select “Title Dividing” using [\blacktriangle / \blacktriangledown], then press [ENTER].
- 4** Select “Yes” using [\blacktriangle / \blacktriangledown], then press [ENTER].

e.g.) VR mode DVD-RW disc Playlist



The title is divided into two new titles with the same title names.

For DVD+RW : Writing onto the disc starts. It may take awhile to write the data on a disc.

For HDD and VR mode DVD-RW disc : Proceed to step 5.

5 Press [RETURN] or [STOP ■] to exit.

For DVD, writing onto the disc starts. It may take awhile to write the data on a disc.

Note

- You cannot divide a title of the disc when the number of recording titles reaches the maximum of 600 (HDD), 99 (-RW) or 49 (+RW), or the number of recording chapters reaches the maximum of 999 (-RW) or 254 (+RW).
- If there is not enough recordable space left in HDD, you cannot divide a title of the HDD Original.

Combining Titles



You can combine two titles into a single title.

If you edit the HDD, press [HDD] first.
If you edit a disc, press [DVD] first.

- Follow steps 1 to 3 in “Editing Title Name” on page 77.
- Select “Title Combining” using [▲ / ▼], then press [ENTER].
- Select another title to combine using [▲ / ▼ / ◀ / ▶], then press [ENTER].
- Select “Yes” using [▲ / ▼], then press [ENTER].

The two titles will combine into a single title.
e.g.) VR mode DVD-RW disc Playlist

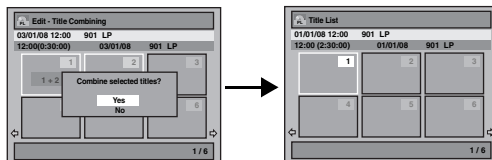

5 Press [RETURN] or [STOP ■] to exit.

For DVD, writing onto the disc starts. It may take awhile to write the data on a disc.

Note

- You cannot select the same title twice and combine it into a single title.
- If either one of the two original titles is deleted, the combined new title is also deleted.

Adding Titles to a Playlist



For HDD and VR mode DVD-RW disc, you can add a title to the Playlist as you want.

If you edit the HDD, press [HDD] first.
If you edit a disc, press [DVD] first.

- Follow the steps 1 to 2 in “Deleting Titles” on page 76.
- Select “Add To Playlist” using [▲ / ▼], then press [ENTER].



3 Select “Yes” using [▲ / ▼], then press [ENTER].

The title is added to Playlist.

4 Press [RETURN] or [STOP ■] to exit.

For DVD, writing onto the disc starts. It may take awhile to write the data on a disc.

Hint

- To delete a title from the Playlist, refer to “Deleting Titles” on page 76.
- When the number of the Playlist reaches its maximum (refer to page 38), or when the number of the total chapter marks of the Playlists reaches 999 (only for VR mode DVD-RW), “Add To Playlist” cannot be selected.

Introduction

Connections

Basic Setup

Recording

Playback

Editing

Function Setup

VHS Functions

Others

Deleting All Playlists



All Playlists can be deleted if it is no longer needed.

- 1** Press [SETUP].
- 2** Select “DVD Menu” (for DVD) or “HDD Menu” (for HDD) using [▲ / ▼], then press [ENTER].
- 3** Select “Delete All Playlists” using [▲ / ▼], then press [ENTER].
e.g.) DVD

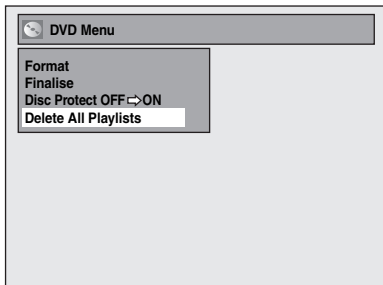

- 4** Select “Yes” using [▲ / ▼], then press [ENTER].

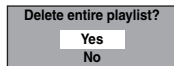

“Are you sure?” will appear. Select “Yes” using [▲ / ▼], and then press [ENTER].
Playlist is deleted.

For DVD, writing onto the disc starts.
It may take awhile to write the data on a disc.

Note

- Deleting a Playlist will not increase the available recording time on the disc.

Deleting Parts of Titles



You can delete a specific part of a title.
Even when a title is deleted from the Playlist, the original title will remain as it is.

If you edit the HDD, press [HDD] first.
If you edit a disc, press [DVD] first.

- 1** Follow the steps 1 to 3 in “Editing Title Name” on page 77.
- 2** Select “Scene Delete” using [▲ / ▼], then press [ENTER].
e.g.) VR mode DVD-RW disc Playlist

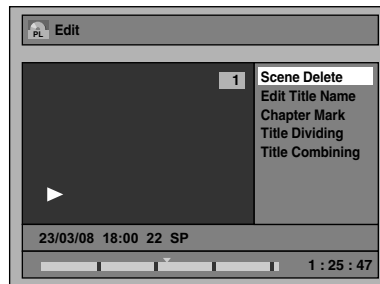

- 3** Use [SKIP ◀◀ / ▶▶], [REV ◀◀], [FWD ▶▶], [PLAY ▶] and [PAUSE II] to find the start point, then press [ENTER].

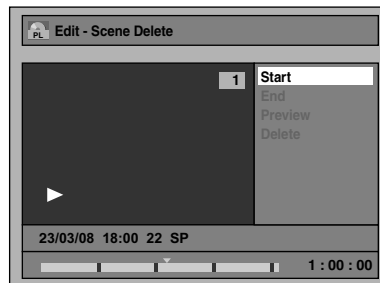

Then use [SKIP ◀◀ / ▶▶], [REV ◀◀], [FWD ▶▶], [PLAY ▶] and [PAUSE II] again to move to the end point, and press [ENTER].

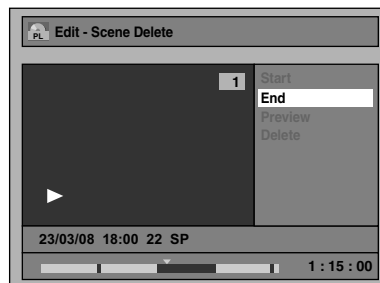

The cursor will move to "Preview".
The bar at the bottom of the screen indicates the total and the elapsed time of the title, and the area selected for deletion is indicated in red.
You can check the preview by pressing [ENTER].

- Before and after 5 seconds of the deleted point will be playback for preview.

- 4** Select "Delete" using [▲ / ▼], then press [ENTER].

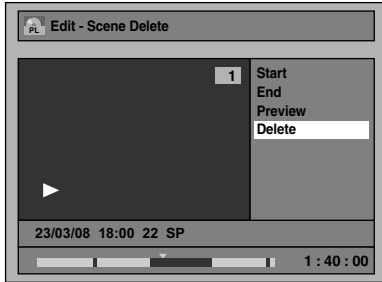

- 5** Select "Yes" using [▲ / ▼], then press [ENTER].

"Are you sure?" will appear. Select "Yes" using [▲ / ▼], and then press [ENTER].

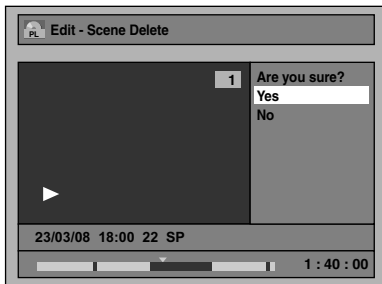

The part of the title is deleted.

- 6** Press [RETURN] and then [RETURN] or [STOP ■] to exit.

For DVD, writing onto the disc starts.
It may take awhile to write the data on a disc.

Note

- For VR mode DVD-RW disc, you cannot select "Scene Delete" if the number of chapter marks in the Original or Playlist is 999. (Depends on the content, there is a case that you cannot select "Scene Delete" before the number of chapter marks reaches 999.)
- When a scene is deleted from an original, the scene on the Playlist will also be deleted.

Deleting All Titles in HDD



Press [STOP ■] if you are playing back a disc.

- 1** Press [SETUP].
- 2** Select "HDD Menu" using [▲ / ▼], then press [ENTER].
- 3** Select the desired type of deletion using [▲ / ▼], then press [ENTER].

Select "Delete All Titles" if you want to delete all titles including the ones protected.
Select "Delete All Unprotected Titles" if you want to delete only the unprotected titles.
Select "Delete All Playlists" if you want to delete all Playlists.

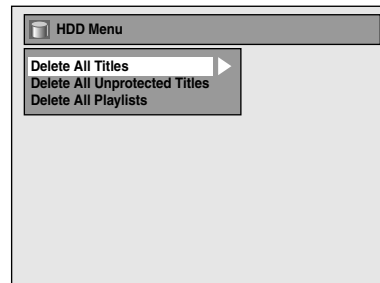

- 4** Select "Yes" using [▲ / ▼], then press [ENTER].

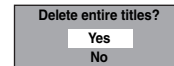

"Are you sure?" will appear. Select "Yes" using [▲ / ▼], and then press [ENTER].
Titles are deleted.

Introduction

Connections

Basic Setup

Recording

Playback

Editing

Function Setup

VHS Functions

Others

Function Setup

The following table is the contents which you can set and the default settings.
Refer to the following table for useful operation.

Setup	Items (highlight is the default)	Contents		
General Setting	Playback			
	Parental Lock ▶ Page 86	All level 1 to 8	Set the parental level for DVD disc playback.	
	Audio Out ▶ Pages 86-87	Dynamic Range Control PCM	ON OFF	Compressing the range of sound volume.
		Dolby Digital	48kHz 96kHz	Set whether the sound recorded in 96kHz will be down sampled to 48kHz.
		MPEG	PCM	Set whether to convert Dolby Digital into PCM or to output Dolby Digital signals.
		DTS	Stream PCM	Set whether to convert MPEG into PCM or to output MPEG signals.
			Stream ON OFF	Set whether DTS signal is output or not.
	Disc Menu Language ▶ Page 87		French English Spanish German Italian Other	Set the language for Disc Menu.
	Audio Language ▶ Page 87		Original French English Spanish German Italian Other	Set the language for audio.
	Subtitle Language ▶ Page 88		OFF French English Spanish German Italian Other	Set the language for subtitles.
	Angle Icon ▶ Page 88		ON OFF	Set whether or not to display the angle icon.
	Still Mode ▶ Page 88		Auto Field Frame	Set the type of still image in pausing playback.
	Variable Skip / Replay ▶ Page 88		Variable Skip 5 seconds 15 seconds 30 seconds 1 minute 5 minutes	Set the amount of skip time when you press [VARIABLE SKIP].
		Variable Replay 5 seconds 15 seconds 30 seconds 1 minute 5 minutes	Set the amount of rewind time when you press [VARIABLE REPLAY].	
TV System ▶ Page 88		PAL Auto	Set the TV system.	
Display				
OSD Language ▶ Page 89		Français English Español Deutsch Italiano	Set the language for OSD (on-screen display).	
Screen Saver ▶ Page 89		OFF 5 minutes 10 minutes 15 minutes 30 minutes	Set the idling time before the screen saver starts.	
FL Dimmer ▶ Page 89		Auto Bright Dark	Set the brightness of the Front Panel Display.	
Video				
TV Aspect ▶ Page 90		4:3 Letter Box 4:3 Pan & Scan 16:9 Wide	Set a picture size according to aspect ratio of your TV.	
Video Out ▶ Page 90		SCART (RGB) Component (Progressive) Component (Interlace)	Set the video output mode.	

Setup	Items (highlight is the default)	Contents		
General Setting	Recording	Auto Chapter ➔ Page 40 Recording Audio Select (XP) ➔ Page 42 Auto Finalise ➔ Page 59 Aspect Ratio (Video mode) ➔ Page 40 Make Recording Compatible ➔ Page 39 Bilingual Recording Audio ➔ Page 42 External Input Audio ➔ Page 41 Video Colour System ➔ Page 50	OFF 5 minutes 10 minutes 15 minutes 30 minutes 60 minutes PCM Dolby Digital ON OFF 4:3 16:9 ON OFF Main Sub Stereo Bilingual Auto PAL SECAM	Insert chapter marks periodically. Set the recording audio type. (Only when the recording mode is set to "XP".) Set the unit to finalise the disc automatically. Set a aspect ratio for Video mode recording. Set to prohibiting additional recording (OFF) or to replace the title list after recording (ON). Set the audio type for recording. Set the external input audio type for recording. Set the video colour system to "PAL" or "SECAM" automatically. Set the video colour system to "PAL". Set the video colour system to "SECAM".
	Clock	Auto Clock Setting ➔ Page 36 Clock Setting ➔ Page 36	ON OFF	Set the clock automatically. Set the clock manually.
	Channel	Country ➔ Page 28 Auto Tuning (DVB & ANALOG) ➔ Page 25 DVB Channel Setup Edit Channels ➔ Page 29 Auto Tuning ➔ Page 27 Manual Tuning ➔ Page 28 Signal Information ➔ Page 31 ANALOG Channel Setup Auto Tuning ➔ Page 25 Manual Tuning ➔ Page 26 Move ➔ Page 27	France Spain Germany Italy Switzerland	Set the DVB channels to Channel Plan of each country. Tune the DVB and analogue channels automatically. Lock the DVB channels, edit the favourite lists. Tune the DVB channels automatically. Tune the DVB channels manually. Display the detailed information of the current DVB channel. Tune the analogue channels automatically. Tune the analogue channels manually. Move the analogue channels to different position.
	DivX	DivX® VOD ➔ Page 62 DivX Subtitle ➔ Page 91	OFF English French Spanish German Italian Swedish Dutch Russian1 Russian2 Hungarian Polish Czech Hebrew	Provide DivX® VOD registration code. Set the language for DivX® Subtitle.
	HDMI	Format ➔ Page 91 HDMI Audio ➔ Page 91 RGB Range ➔ Page 92	RGB YCbCr ON OFF Normal Enhanced	Set the colour space for the HDMI output. Set whether to output the HDMI audio signal or not. Set the black-white contrast level for HDMI RGB output.
	Reset All ➔ Page 92		Set to the default setting.	

Note

- Your change to each settings stays on even when the power is switched off.
- An item which is not currently available is grayed in the settings.

Introduction

Connections

Basic Setup

Recording

Playback

Editing

Function Setup

VHS Functions

Others

Playback

- 1 In stop mode, press [SETUP]. Select "General Setting" using [▲ / ▼], then press [ENTER].
- 2 Select "Playback" using [▲ / ▼], then press [ENTER].

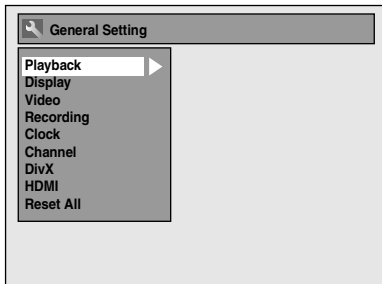

- 3 Select a desired item using [▲ / ▼], then press [ENTER].

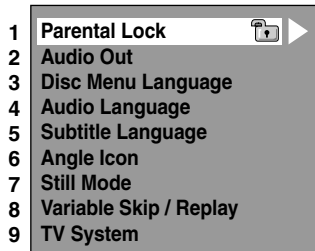

- 4 Refer to 1. to 9. on pages 86 to 88 and set the selected item.
- 5 When you finish with the setting, press [SETUP] to exit.

1. Parental Lock (Default: All) (DVD only)
Set "Parental Lock" level.

Change "Parental Lock" level using [▲ / ▼], then press [ENTER].

Proceed to either of the following steps.

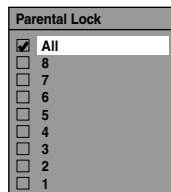

Parental level

- All: All parental locks are cancelled.
- 8: DVD software of any grade (adult / general / children) can be played back.
- 7 to 2: Only DVD software intended for general use and children can be played back.
- 1: Only DVD software intended for children can be played back.

Note

- "Parental Lock" function may not be available on some discs.
- It may be difficult to determine if some DVDs support the parental lock function. Be sure to confirm that "Parental Lock" function operates in the way that you have set.
- Record the password in case you forget it.

A password is not yet set

Select "Yes" using [▲ / ▼], then press [ENTER]. Enter a new password using [the Number buttons], then press [ENTER].



Your setting is activated.

If you select "No", press [SETUP] to exit.

A password is already set

Enter the current password using [the Number buttons].



If you want to change the password, select "Yes" using [▲ / ▼], then press [ENTER].

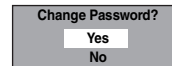

Enter a new password using [the Number buttons], then press [ENTER].



Your setting is activated.

Note

- Press [CLEAR] to erase numbers entered incorrectly.
- If you forget your password or you want to clear all settings in "Parental Lock", enter [4], [7], [3], [7] using [the Number buttons] at the option window. Your password is cleared and parental levels are set to "All".

2. Audio Out

Choose the appropriate audio setting for your external device.

It will only affect a disc playback.

Select a desired item using [▲ / ▼], then press [ENTER].

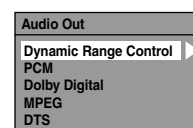

Dynamic Range Control (Default: ON) (DVD only)

Set to "ON" to make the dynamic range narrower.
Select a setting using [▲ / ▼], then press [ENTER].

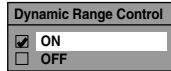

Your setting is activated.
 "Dynamic Range Control" function is effective only with analogue audio connection.

Note

- "Dynamic Range Control" function is available only on discs recorded in the Dolby Digital format.

PCM sampling (Default: 48kHz)

Select a setting using [▲ / ▼], then press [ENTER].

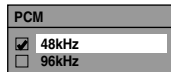

Your setting is activated.

- 48kHz: If your amplifier / decoder is NOT compatible with 96 kHz PCM, select "48kHz". Sound recorded at 96 kHz is down sampled to 48 kHz.
- 96kHz: If your amplifier / decoder is compatible with 96 kHz PCM, select "96kHz". Sound is sampled at 96 kHz.

Note

- When playing back a disc with copyright protection:
- Even if you select "96kHz", the sound is down sampled to 48 kHz.

Dolby Digital conversion (Default: Stream)

Select a setting using [▲ / ▼], then press [ENTER].

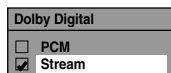

Your setting is activated.

- PCM: Converts the Dolby Digital into PCM (2 channel).
 If your amplifier / decoder is NOT compatible with Dolby Digital, set to "PCM".
- Stream: Outputs Dolby Digital signals.
 If your amplifier / decoder is compatible with Dolby Digital, set to "Stream".

Hint

- When playing back a DVD-RW disc recorded in VR mode:
- If the audio source on a disc is in Dolby Digital format, set "Dolby Digital" to "PCM" so that you can switch to main audio (L), sub audio (R), or a combination of both (L / R) using your amplifier / decoder.

Settings for MPEG (Default: PCM) (DVD only)

Select a setting using [▲ / ▼], then press [ENTER].

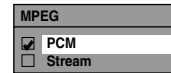

Your setting is activated.

- PCM: Converts MPEG into PCM.
 If your amplifier / decoder is NOT compatible with MPEG, set to "PCM".
- Stream: Outputs MPEG Audio signals.
 If your amplifier / decoder is compatible with MPEG, set to "Stream".

Settings for DTS (Default: ON) (DVD only)

Select a setting using [▲ / ▼], then press [ENTER].

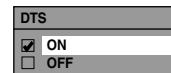

Your setting is activated.

- ON: Outputs DTS signals.
 If your amplifier / decoder is compatible with DTS, set to "ON".
- OFF: No DTS signal is output.
 If your amplifier / decoder is NOT compatible with DTS, set to "OFF".

3. Disc Menu Language (Default: French) (DVD only)

Set "Disc Menu Language".

Select a setting using [▲ / ▼], then press [ENTER].



Your setting is activated.

4. Audio Language (Default: Original) (DVD only)

Set "Audio Language".

Select a setting using [▲ / ▼], then press [ENTER].

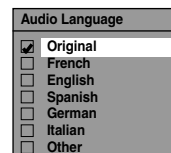

Your setting is activated.

If "Original" is selected, the audio language is the default of the inserted disc.

Introduction

Connections

Basic Setup

Recording

Playback

Editing

Function Setup

VHS Functions

Others

5. Subtitle Language (Default: OFF) (DVD only)

Set "Subtitle Language".

Select a setting using [▲ / ▼], then press [ENTER].

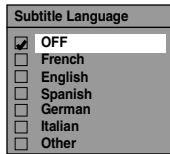

Your setting is activated.

If "Other" is selected, enter the appropriate 4-digit code using [the Number buttons].

Refer to "Language Code" on page 101.

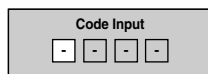

When you finish entering the code, press [ENTER].

Hint

- You can also change or switch off the subtitles on a DVD from the disc menu if it is available.
- Press [CLEAR] or [◀] to erase numbers entered incorrectly.

Note

- You can only select the languages supported by the inserted disc.
- "Audio Language" setting may not be available for some discs.

6. Angle Icon (Default: ON) (DVD only)

Set "Angle Icon".

Select a setting using [▲ / ▼], then press [ENTER].

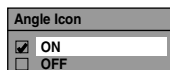

Your setting is activated.

7. Still Mode (Default : Auto) (DVD only)

Select a setting using [▲ / ▼], then press [ENTER].

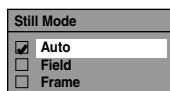

Your setting is activated.

- Auto: Automatically select the best resolution setting ("Frame" or "Field") based on the data characteristics of the pictures.
- Field: Select "Field" when the pictures are still unstable even if "Auto" is selected. "Field" stabilises the pictures, although the picture quality may become coarse due to the limited amount of data.

Frame: Select "Frame" to display relatively motionless pictures in higher resolution. "Frame" improves the picture quality, although it may unbalance the pictures due to simultaneous output of two Field data.

Note

- An individual picture on TV screen is called as Frame, which consists of two separate images called as Field. Some pictures may be blurred at the "Auto" setting in still mode due to their data characteristics.

8. Variable Skip / Replay

Assign [VARIABLE SKIP] or [VARIABLE REPLAY] to skip or rewind by a certain amount of time when they are pressed. Select a desired item using [▲ / ▼], then press [ENTER].

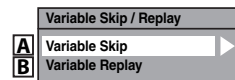

Refer to the explanations below and set the selected item.

A : Variable Skip (Default: 30 seconds)
Sets the amount of skip time for [VARIABLE SKIP].

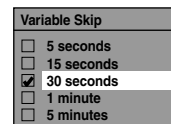

B : Variable Replay (Default: 30 seconds)
Sets the amount of rewind time for [VARIABLE REPLAY].

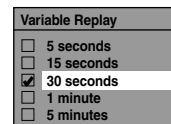

9. TV System (Default : PAL) (DVD only)

Select a setting using [▲ / ▼], then press [ENTER].

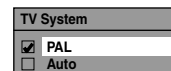

Your setting will be activated.

- PAL: Outputs a modified PAL signal for viewing discs recorded with the NTSC system on a PAL system TV.
- Auto: Changes the video system (PAL / NTSC) automatically according to the format of the inserted disc.

Note

- With discs recorded using the PAL system, a PAL signal is output for viewing on a PAL system TV.
- Discs recorded with the PAL system cannot be viewed on an NTSC system TV.
- With discs recorded using the NTSC system, an NTSC signal is output for viewing on an NTSC or Multi system TV.
- With discs recorded using the NTSC system, select PAL to view on a PAL system TV.

Display

- 1** In stop mode, press [SETUP]. Select "General Setting" using [▲ / ▼], then press [ENTER].
- 2** Select "Display" using [▲ / ▼], then press [ENTER].

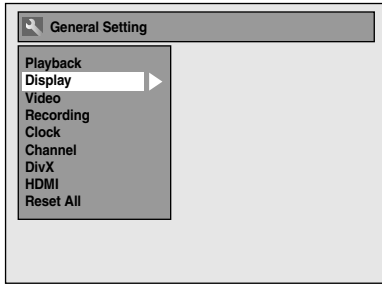

- 3** Select the desired item using [▲ / ▼], then press [ENTER].

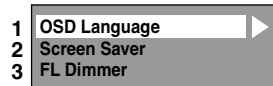

- 4** Refer to 1. to 3. on this page and set the selected item.
- 5** When you finish with the setting, press [SETUP] to exit.

- 1. OSD Language (Default: Français)**
Set the OSD language.
Select a language using [▲ / ▼], then press [ENTER].



- 2. Screen Saver (Default: 10 minutes)**
Set the screen saver time delay.
Select a setting using [▲ / ▼], then press [ENTER].

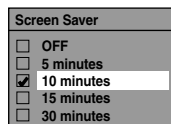

Your setting is activated.

- 3. FL Dimmer (Default: Bright)**

Set the front panel display brightness.

Select a setting using [▲ / ▼], then press [ENTER].



You can choose one from "Auto", "Bright" or "Dark".

If "Auto" is selected, the display gets dark when the power is off.

Introduction

Connections

Basic Setup

Recording

Playback

Editing

Function Setup

VHS Functions

Others

Video

- 1 In stop mode, press [SETUP]. Select "General Setting" using [▲ / ▼], then press [ENTER].
- 2 Select "Video" using [▲ / ▼], then press [ENTER].

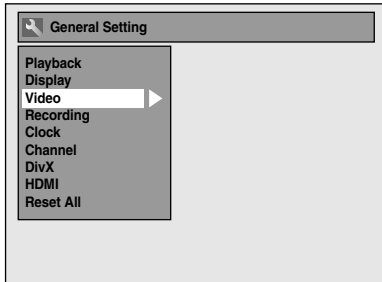

- 3 Select the desired item using [▲ / ▼], then press [ENTER].

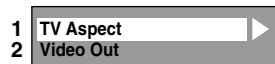

- 4 Refer to 1. and 2. on this page and set the selected item.
- 5 When you finish with the setting, press [SETUP] to exit.

1. TV Aspect (Default: 16:9 Wide)

You can select the TV aspect ratio to match the formats of what you are playing back with the unit and your TV screen (4:3 standard or 16:9 widescreen TV).

Select the desired setting using [▲ / ▼], then press [ENTER].

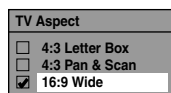

If you have a standard TV:

Select "4:3 Letter Box", so that black bars appear on the top and bottom of the TV screen when playing back a wide-screen picture. Select "4:3 Pan & Scan" for a full height picture with both sides trimmed when playing back wide-screen picture.

If you have a widescreen TV:

Select "16:9 Wide".

2. Video Out (Default: SCART (RGB))

This unit is compatible with the Progressive Scan System. The feature provides you with the higher definition images than the traditional output system does. You can enjoy Progressive Scan image by using HDMI OUT or COMPONENT VIDEO OUT. To utilise the Progressive Scan system through the COMPONENT VIDEO OUT, you must set Video Output mode in "Setup" menu by following the steps on right. "SCART (RGB)" is selected as the default.

- When you set the "Video Out" setting, make sure that the AV1 (TV) Scart socket is connected to your TV with Scart cable.

- 1 Select the desired setting using [▲ / ▼], then press [ENTER].

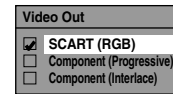

- If your TV is compatible with progressive scanning (576p/480p), connect the TV to the COMPONENT VIDEO OUT jacks of this unit and select "Component (Progressive)" and set your TV to the progressive scan mode.
- If your TV is not compatible with progressive scan, select "Component (Interlace)" for component connection, or select "SCART (RGB)" for Scart cable connection.
- Refer to pages 20 to 21 for more details.

Only if you select the "Component (Progressive)", proceed to step 2. If you select "Component (Interlace)" or "SCART (RGB)", your setting is activated.

- 2 Use [◀ / ▶] to select "Yes". Press [ENTER].

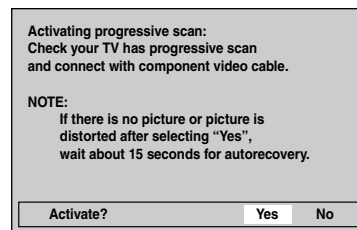

Final confirmation window will appear.

- 3 Use [▲ / ▼] to select "Yes". Press [ENTER] within 15 seconds.

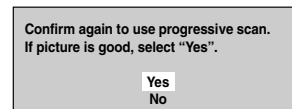

Your setting is activated.

Note

- When changing "Video Out" setting ("SCART (RGB)", "Component (Interlace)" or "Component (Progressive)"), connect to the corresponding jack on the TV. If the setting is changed, for example, to "SCART (RGB)" while the COMPONENT VIDEO OUT jacks are used to connect to the TV, a distorted video signal may be output.

DivX®

- 1 In stop mode, press [SETUP]. Select "General Setting" using [▲ / ▼], then press [ENTER].
- 2 Select "DivX" using [▲ / ▼], then press [ENTER].

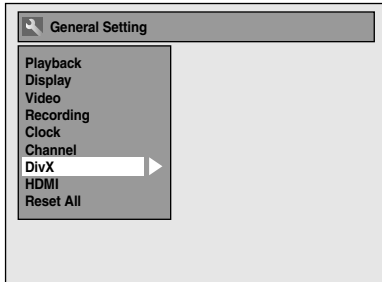

- 3 Select the desired item using [▲ / ▼], then press [ENTER].

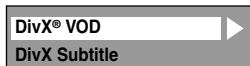

For "DivX® VOD", refer to page 62 in details.

DivX Subtitle (Default: OFF)

Select the desired setting using [▲ / ▼], then press [ENTER].

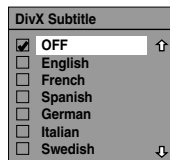

- 4 When you finish with the setting, press [SETUP] to exit.

HDMI

- 1 In stop mode, press [SETUP]. Select "General Setting" using [▲ / ▼], then press [ENTER].
 - Make sure that the HDMI cable is connected and the TV input is set to HDMI.
- 2 Select "HDMI" using [▲ / ▼], then press [ENTER].

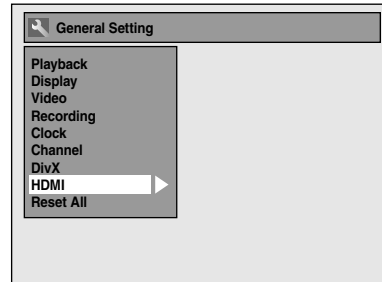

- 3 Select the desired item using [▲ / ▼], then press [ENTER].

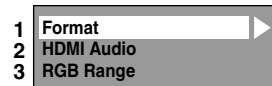

- 4 Refer to 1. to 3. on pages 91 to 92 and set the selected item.
- 5 When you finish with the setting, press [SETUP] to exit.

1. Format (Default: RGB)

You can select the colour space for HDMI output. Set the appropriate colour space for your display device.

Select a setting using [▲ / ▼], then press [ENTER].

- When the connected device is not compatible with the Y/Cb/Cr, HDMI signal is output as RGB regardless of the setting.

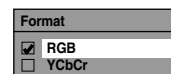

Your setting is activated.

2. HDMI Audio (Default: ON)

If you do not want to output the audio through HDMI (when you digitally output the audio through the DIGITAL AUDIO OUT (COAXIAL) jack to your audio system, etc.), you can set the HDMI audio output off.

Select a setting using [▲ / ▼], then press [ENTER].

- Set to "OFF" when the HDMI sound is not output.

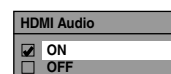

Your setting is activated.

Introduction

Connections

Basic Setup

Recording

Playback

Editing

Function Setup

VHS Functions

Others

3. RGB Range (Default: Normal)

You can adjust the RGB range to make the dark areas of the HDMI images brighter.

Select a setting using [**▲** / **▼**], then press [**ENTER**].

- Select “Enhanced” if the black-white contrast is not clear.
- This setting is effective only for HDMI RGB output.

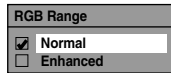

Your setting is activated.

Reset All

1 In stop mode, press [**SETUP**]. Select “General Setting” using [**▲** / **▼**], then press [**ENTER**].

2 Select “Reset All” using [**▲** / **▼**], then press [**ENTER**].

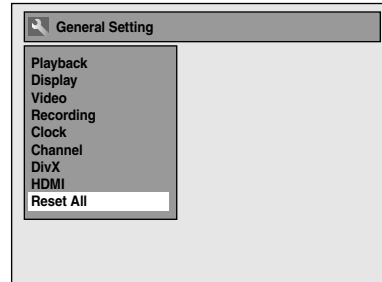

3 Select “Yes” using [**▲** / **▼**], then press [**ENTER**].

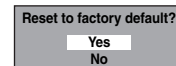

“Are you sure?” will appear. Select “Yes” using [**▲** / **▼**], and then press [**ENTER**].

4 When you finish with the setting, press [**SETUP**] to exit.

Note

- The settings listed below will remain unchanged even after resetting to the factory default.
 - Clock setting
 - Channel setting
 - Parental lock setting
 - DivX® VOD code
 - Timer Programmes

VHS Functions

Playback



- 1** Press [I/⏻ ON/STANDBY] to turn on the unit.
To play back a tape, turn on the TV and be sure to select the input to which the unit is connected.
- 2** Press [VCR].
- 3** Insert a pre-recorded tape, then press [PLAY ▶] to begin playback.
- 4** During playback, press [PAUSE II].
Playback will be paused and sound will be muted.
- 5** Press [PLAY ▶] to resume playback.
- 6** Press [STOP ■] to stop playback.
- 7** Press [OPEN/CLOSE ▲] to eject the tape.

Note

- When a tape without record tab is inserted, the unit will start playback automatically.
- Tracking will be automatically adjusted upon playback. To adjust the tracking manually, press [PROG. ^ / v].

Recording and One-touch Timer Recording (OTR)

Basic Recording



Before recording, make sure:

- The desired channel is selected by pressing [the Number buttons] or [PROG. ^ / v] on the remote control.
- There is a tape with a record tab in the unit.

Tape speed	Recording / Playback Time			
	Type of tape	E60	E120	E180
SP mode	1 hour	2 hours	3 hours	4 hours
LP mode	2 hours	4 hours	6 hours	8 hours

- 1** Turn on the unit and insert a recordable videotape.
Make sure that the TV input is set on the unit.
- 2** Press [VCR].
- 3** Select the recording mode using [REC MODE].
• The desired recording mode is selected in SP (standard play) or LP (long play) mode by pressing [REC MODE].
- 4** Select the desired channel to record using [PROG. ^ / v] or [the Number buttons].
- 5** Press [REC ●] to start recording.
To temporarily stop recording or to resume it, press [PAUSE II].



After the unit has been in pause mode for 5 minutes, it will stop automatically to protect the tape and the video head from damage.

- 6** Press [STOP ■] when the recording is completed.

Introduction

Connections

Basic Setup

Recording

Playback

Editing

Function Setup

VHS Functions

Others

Accidental erasure prevention

To prevent accidental recording on a recorded cassette, remove its record tab. To record on it later, cover the hole with cellophane tape.

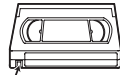

Record tab

One-touch Timer Recording



This feature allows you to set the recording length simply by pressing [REC ●].

- 1 Turn on the unit and insert a recordable videotape.**
Make sure that the TV input is set on the unit.
- 2 Press [VCR].**
- 3 Select the recording mode using [REC MODE]. (See page 93.)**
- 4 Select the desired channel to record using [PROG. ^ / v] or [the Number buttons].**
- 5 Press [REC ●] repeatedly until the desired recording time (30 minutes to 8 hours) appears on the TV screen.**

One-touch Timer Recording will start.

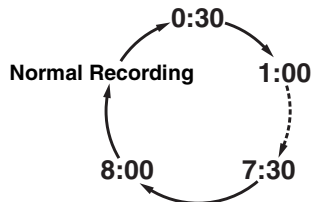

- When the unit reaches the specified time, it will be turned off automatically.
- To change the recording length during One-touch Timer Recording, press [REC ●] repeatedly until desired length appears.
- To cancel One-touch Timer Recording within the specified time, press [STOP ■].

Hint

- The remaining recording time will appear on the TV screen during One-touch Timer Recording. Press [DISPLAY] to see it on the TV screen.

Note

- If VHS One-touch Timer Recording is completed during HDD/DVD playback or recording, the VHS will be in stop mode and the HDD/DVD keeps the current mode.
- You cannot use the pause function during One-touch Timer Recording.
- When One-touch Timer Recording is finished and the power is turned off, the unit will switch to the timer-standby mode automatically if a timer recording has been programmed.

DVC to VHS Dubbing



This function helps you to dub the contents in the DVC (digital video camcorder) to VHS.

Preparing for DV dubbing (DVC to VHS):

- Insert a recordable videotape.
- Make sure your DVC is in video mode.

- 1 Press [VCR].**
- 2 Select “DV” channel using [INPUT SELECT ⇄] or [PROG. ^ / v].**
- 3 Select the recording mode using [REC MODE]. (See page 93.)**
- 4 Stop or pause the DVC where you want to start dubbing.**
- 5 Play back the DVC.**
- 6 Press [REC].**
The dubbing will start.

Note

- Dubbing will start from where the tape is stopped.

Search

Index Search



- 1 Press [VCR].**
- 2 Press [SEARCH] so that the index search menu appears.**
- 3 Enter the number of recordings you want to skip using [the Number buttons] within 30 seconds.**
- 4 Press [FWD ►►] or [REV ◀◀] to start index search.**
If you want to go in the forward direction, press [FWD ►►].
If you want to go in the reverse direction, press [REV ◀◀].
After index search, the VHS will play back the tape automatically.

Note

- This function is not available during recording.
- Every time a tape is recorded, an index mark is written on the tape.
- You can make the index mark up to 20.

Time Search



This feature allows you to go to a specific point on a tape by entering the exact amount of time you want to skip in order to reach the point.

- 1 Press [VCR].**
- 2 Press [SEARCH] repeatedly until the time search menu appears.**
- 3 Enter your desired time to skip using [the Number buttons] within 30 seconds.**
- 4 Press [FWD ►►] or [REV ◄◄] to start time search.**

If you want to go in the forward direction, press [FWD ►►].

If you want to go in the reverse direction, press [REV ◄◄].

After index search, the unit will play back the tape automatically.

Note

- This function is not available during recording.
- Press [STOP ■] to stop the search.
- If the tape reaches the end during the search, this unit will cancel it and rewind the tape.
- You can set the time up to 9:59.

Other Operations



Press [VCR] first.

To cue or review picture during playback (Picture Search):

Press [FWD ►►] or [REV ◄◄] during playback. Press it again and the unit will search in super high speed (in the LP mode only).

To freeze the picture on TV screen during playback (Still mode):

Press [PAUSE II]. Each time you press the button, the picture will be forwarded frame by frame. If the picture begins to vibrate vertically during the still mode, stabilise the picture by pressing the [PROG. ▲ / ▼]. If the picture is distorted or rolling vertically, adjust the vertical hold control on your TV, if equipped.

To reset the tape counter:

Press [CLEAR].

To play back in slow forward motion:

During playback, press [PAUSE II], then press [FWD ►►].

If the noise bars appear on the TV screen, you can reduce it by pressing [PROG. ▲ / ▼]. Slow reverse is not available in VHS mode.

Note

- Still / Slow / Pause mode will be automatically cancelled after 5 minutes to prevent damage to the tape and the video head.
- To return to normal play back from the Picture Search / Still / Slow mode, press [PLAY ►].

Changing the Video Colour System

Different countries use different television colour systems.

This unit will distinguish the video colour system (SECAM, PAL or MESECAM) automatically according to the format of a pre-recorded video tape during playback or the input signal from the tuner or external devices.

To change the video colour system manually, press [MODE].

Each time you press [MODE], the colour system will change as follows.

→ AUTO → SECAM → PAL → MESECAM

Note

- If the playback picture on the TV screen is black and white, change the video colour system manually.
- When you change the video colour system manually, be sure to change it before recording. If you select the wrong video colour system for recording, the colour of the picture may be deteriorated.

Hi-Fi Stereo Sound System

This unit will record and playback Hi-Fi stereo sound. In addition, it has an A2 and NICAM stereo sound decoder. This unit will receive stereo and bilingual broadcasts and it is possible to record in several ways and to play back the sound.

Selecting the Sound Mode

You can select each mode by pressing [AUDIO ◯] on the remote control. Each mode is indicated on the TV screen as following.

- During playback of the recorded tape in Hi-Fi mode

Mode	Audio output	Display on the TV screen
Stereo	Stereo	STEREO
L	L audio from both speakers	LEFT
R	R audio from both speakers	RIGHT
Normal	Monaural	MONO

- During reception of bilingual broadcasts

Mode	Audio output	Display on the TV screen
Main	Main audio from the both speakers	Main
Sub	Sub audio from the both speakers	Sub
Main / Sub	<ul style="list-style-type: none"> • Main audio from the left speaker • Sub audio from the right speaker 	Main Sub

Note

- If you play back non-Hi-Fi tapes, the unit will play back automatically in monaural even if you select any mode.
- If the stereo signal becomes weak, the broadcast is automatically recorded in monaural.

Introduction

Connections

Basic Setup

Recording

Playback

Editing

Function Setup

VHS Functions



Others

Others

Troubleshooting

Before requesting service for this unit, check the table below for a possible cause of the problem you are experiencing. Some simple checks or a minor adjustment on your part may eliminate the problem and restore proper operation.

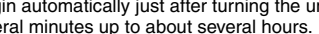
	Symptom	Remedy
POWER	The power does not turn on.	<ul style="list-style-type: none"> Check that the AC power cord is connected securely. Batteries of the remote control are weak.
	The unit turns on automatically without any operation.	<ul style="list-style-type: none"> The unit turns on automatically 2 seconds before the timer recording.
GENERAL	The unit does not function.	<ul style="list-style-type: none"> "⊙" or error message appears if the operation is prohibited. Batteries of the remote control are weak or exhausted.
	No picture, sound or menu appears on the screen.	<ul style="list-style-type: none"> Check if the connections are made securely and correctly. Check if the cables are damaged. Check if a correct external input channel is selected on your TV. (See page 22.) Check if you have completed "Channel" setting. (See pages 25-31.)
	"Clock" setting and "Channel" setting cannot be performed.	<ul style="list-style-type: none"> If a recording is in progress, these operations cannot be performed.
	The unit does not operate properly.	<ul style="list-style-type: none"> Moisture has condensed inside the unit. Remove the disc and leave the unit turned on for about 2 hours until the moisture evaporates. (See page 3.)
	The clock display does not appear on the front panel display.	<ul style="list-style-type: none"> Check that the AC power cord is connected securely. (In case of power failure) Check the breaker and "Clock" setting.
	When you forget the password for parental lock.	<ul style="list-style-type: none"> Please cancel the password and the set level. (See page 86.)
	DV signal cannot be input.	<ul style="list-style-type: none"> Before connection, turn on the power supplies for both this unit and the DVC, and make sure that these units have stopped. Only a "DVC-SD" signal can be input from the DVC to this unit. Other types of signals are not supported. Do not connect any device other than the DVC. Even if a recorder or PC with another DV terminal is connected, the DV function will not operate. If the DVC is not recognised after connection, turn off the power supply for the unit and re-connect the DVC.
	The DVC cannot be operated with this unit.	<ul style="list-style-type: none"> Signal input or DVC operation from this unit may be disabled depending on the type of DVC. If a DVC signal cannot be input, use an external input (AV2/AV3) for analogue connection via audio/video cables. Use Scart adaptor for connecting to AV2. DVC control may be disabled depending on the type of DVC, even in a mode other than camera mode. In this case, switch to DVD control and execute the normal recording procedure while operating the DVC.
	Certain functions of the DVC cannot operate.	<ul style="list-style-type: none"> Some functions may not operate depending on the type of DVC. For example, if the DVC does not support slow playback mode, the slow playback function is disabled. With DV (AV4), the disc display menu does not appear unless disc playback is executed.
	DV audio signal cannot be switched.	<ul style="list-style-type: none"> For recording with the DVC, the recording audio signal can be set to 12 bits or 16 bits. However, when 16-bit recording mode is selected, audio signal cannot be switched. To record an audio signal, set it to 12 bits.
No image from HDMI connection.	<ul style="list-style-type: none"> Check the HDMI connection. (Check the status of the HDMI related indications.) Check whether the connected monitor device or other device supports HDCP. (This unit will not output a video signal unless the other device supports HDCP.) Check the setting of HDMI. Check whether the output format of this unit (HDMI FORMAT) matches the supported input format of other connected device. If the unit is connected to the unauthorised display device with an HDMI cable, the audio and video signals may not be output when playing back a commercial DVD-video. 	

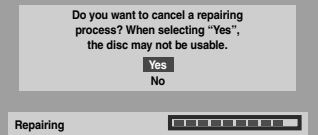
	Symptom	Remedy
CHANNEL	TV channels cannot be changed.	<ul style="list-style-type: none"> • Check if the connections are made securely and correctly. • Check if the cables are damaged. • Try "Channel" setting by following the steps on pages 25-31.
	Only specific channels do not appear.	<ul style="list-style-type: none"> • The channels may be set to be skipped. (See page 26.)
	The external input channels (such as AV2 or AV3) cannot be skipped.	<ul style="list-style-type: none"> • This unit does not skip the external input channels. This is not a malfunction.
GENERAL	The image from the external device cannot be displayed.	<ul style="list-style-type: none"> • Try pressing [INPUT SELECT -⊖] repeatedly. • Turn on all connected devices. • Check if the connections are made securely and correctly.
	Recording is impossible.	<ul style="list-style-type: none"> • It is prohibited to make a recording from 2 minutes before the programmed start time of a timer recording. • This unit cannot record programmes that contain copy protection signal. This is not a malfunction. • The space of the recording media may be used up. Try deleting unnecessary titles, or exchange it with the recordable media. • The maximum number of titles or chapters has exceeded. Delete the unnecessary titles to make enough space or insert a new recordable media. • Check if the connections are made securely and correctly.
HDD / DVD	Timer recording cannot be performed.	<ul style="list-style-type: none"> • The internal clock of the unit may have been stopped due to a power failure that lasted for more than 30 seconds. Reset the clock. (See page 36.)
	Recording is impossible.	<ul style="list-style-type: none"> • Check if the disc is CPRM compatible. Copy-once programmes can only be copied onto the disc which is CPRM compatible. • Check if the disc is protected or finalised. Undo the protection or the finalisation. • Video mode DVD-RW once formatted in other unit cannot be recorded in this unit unless formatted in this unit. • Check if the connections are made securely and correctly.
RECORDING	"Repairing" appears on the TV screen.	<ul style="list-style-type: none"> • If there is a power failure or unplugging during recording, finalising, formatting or editing (even after "Repairing" disappears), a repairing process will begin automatically just after turning the unit on again. • It may take several minutes up to about several hours.
	In a case you intend to cancel the repairing process.	<ul style="list-style-type: none"> • If you intend to cancel the repairing process, press [▲ OPEN/CLOSE] on the front panel, then select "Yes" and press [ENTER]. After that, press [OPEN/CLOSE ▲] to take out the disc. The disc cancelled during the repairing process MAY NOT work.
	The indication "Writing to Disc"  does not disappear.	<ul style="list-style-type: none"> • "Writing to Disc"  may remain on screen for the maximum of 20 seconds even after it reached 100%. This is not a malfunction.
DVD		
		
VHS	Recording does not start immediately after pressing [REC ●] .	<ul style="list-style-type: none"> • Make sure the videotape has a recorded tab when you record to a videotape. If needed, cover the hole with cellophane tape.
	TV aspect ratio does not match your TV screen.	<ul style="list-style-type: none"> • Check "TV Aspect" setting. (See page 90.) • A different aspect ratio will be used when the aspect ratio specified by the disc is not supported by this unit.
PLAYBACK	Playback picture is distorted. Colour of the picture is abnormal.	<ul style="list-style-type: none"> • During fast forward or fast reverse, playback picture may be distorted. This is not a malfunction. • Connect to TV directly. When you connect this unit with the television via VCR or other devices, the picture may be distorted due to the copy-protection signal. • Check if the cables are damaged. • Keep the equipment which may cause electrical disturbances, such as a cellular phone, away.
	There is no sound, or no subtitle.	<ul style="list-style-type: none"> • Turn on all connected devices. • Check if the external input channel is set correctly. • Check if the connections are made securely and correctly. • If using the HDMI connection, sound is not output when "HDMI Audio" is set to "OFF". • Check the RCA audio cable connection. If you are using HDMI-DVI conversion cable, you must connect the RCA audio cable, too. • If using the HDMI connection, check whether the output format of this unit (HDMI FORMAT) matches the supported input format of other connected device.
GENERAL		

Introduction

Connections

Basic Setup

Recording

Playback

Editing

Function Setup

VHS Functions

Others

	Symptom	Remedy	
PLAYBACK	HDD/DVD Playback does not start from the beginning.	<ul style="list-style-type: none"> Resume function may be activated. Refer to page 66 to cancel the resume point. 	
	HDD HDD playback suddenly stops.	<ul style="list-style-type: none"> When DVD recording finishes during HDD playback, the unit will stop the HDD playback, and start writing data to the DVD. This is not a malfunction. 	
	DVD	Playback cannot be performed.	<ul style="list-style-type: none"> Check if the playable disc is inserted. Check if the disc is loaded correctly with the labelled side facing up. Discs made on other devices or on personal computers cannot be played back on this unit unless it is finalised on the device. Even if it is finalised, the performance of those discs are not guaranteed on this unit. The disc may be dirty or flawed. Clean the disc. Check if all the connections are made correctly. Check "Parental Lock" setting. (See page 86.) Playback of DVD is prohibited from 2 minutes before the programmed start time of a timer recording when the recording media is DVD.
		There is no sound, or no subtitle.	<ul style="list-style-type: none"> Check if all the connections are made correctly. Check if the "Audio Out" is set correctly. (See pages 86-87.) There is a possibility that the selected subtitle language is not supported by the disc.
		Digital audio setting cannot be changed to main audio (L), sub audio (R) or combination of both.	<ul style="list-style-type: none"> If the audio source is in the Dolby Digital format, set "Dolby Digital" setting to "PCM" in "Playback" menu. (available only for DVD) (See page 87.)
		Audio language or the subtitle language of the DVD cannot be changed.	<ul style="list-style-type: none"> Multilingual subtitles are not supported by the disc. Some audio languages or the subtitle languages can be changed only from the disc menu. Please refer to the disc's manual.
		Angles cannot be changed.	<ul style="list-style-type: none"> Even though the multi-angle feature is supported by the disc, that does not mean all the scenes are shot from multi-angles. Changing angles is available only for those scenes shot from the multi-angle.
	VHS	The disc cannot be played back on other player even though it is finalised properly.	<ul style="list-style-type: none"> Some DVD players do not play back the disc made on other recorder. Refer to the manual of the unit.
	VHS	Picture noise appears.	<ul style="list-style-type: none"> Adjust tracking control for better picture by pressing [PROG. ^ / v] while you are playing back a videotape. Head cleaning for VHS may be necessary. Refer to "AUTO HEAD CLEANING" on page 5.
		The unit does not play back the videotape.	<ul style="list-style-type: none"> Check if a videotape is in this unit.
The motor rotates even when playback / recording is stopped.		<ul style="list-style-type: none"> The motor may rotate for the duration of approximately 5 minutes for efficient operation. This is not a malfunction. 	
EDITING	HDD / DVD	Titles cannot be edited or deleted.	<ul style="list-style-type: none"> The titles or the disc itself may be protected. Cancel the protection by following the steps on page 80 for title protection and page 58 for disc protection.
	DVD	Dubbing cannot be executed.	<ul style="list-style-type: none"> When the number of the titles or the chapters exceeds the maximum recordable number, the dubbing will not be executed.
		Titles cannot be edited or deleted.	<ul style="list-style-type: none"> The titles in the DVD+R/-R cannot be edited or deleted if they are finalised. If it is DVD-RW, undo the finalisation by following the steps on page 59.
		The capacity of the disc doesn't increase even if the recorded programme is deleted.	<ul style="list-style-type: none"> With DVD+RW and video mode DVD-RW, the disc space will increase only when the last title is deleted. With DVD-R/+R, deleting a title will not increase the disc space.
		Dubbing cannot be executed.	<ul style="list-style-type: none"> Check if the disc is compatible for recording. (See page 37.)
REMOTE CONTROL	The remote control does not function.	<ul style="list-style-type: none"> No batteries in the remote control or the batteries may be weak. Replace the batteries. Make sure there is no obstacle between the remote control and the unit. Try getting closer to the unit. (See page 14.) If above solutions do not solve the problem, please call an Authorised Service Centre. 	

Error message	Cause	Solution
Disc Error — Please eject the disc. — Playback feature may not be available on this disc.	<ul style="list-style-type: none"> An unplayable disc is inserted in the unit. The disc is upside down. 	<ul style="list-style-type: none"> Insert a standard disc. (See pages 9-10.) Insert the disc with the labelled side facing up.
Region Error — Please eject the disc. — Playback is not authorized in your region.	<ul style="list-style-type: none"> Playback is not authorised in the region of the DVD-Video that you inserted in the unit. 	<ul style="list-style-type: none"> Insert a DVD-Video with region codes 2 or ALL.
Parental Lock On The current selected parental level prohibits playback.	<ul style="list-style-type: none"> The current selected parental level in "Setup" menu prohibits playback. 	<ul style="list-style-type: none"> Check the "Parental Lock" setting. (See page 86.)
Recording Error This programme is not allowed to be recorded.	<ul style="list-style-type: none"> The recording function encountered a copy prohibited programme. Original source is in NTSC system. 	<ul style="list-style-type: none"> You cannot record copy prohibited programmes.
Recording Error This programme is not recordable in Video mode.	<ul style="list-style-type: none"> You are trying to record a copy-once programme onto a DVD-RW disc in Video mode. 	<ul style="list-style-type: none"> Set "Format Mode" to "VR mode". (See page 39.)
Recording Error Can not record on this disc.	<ul style="list-style-type: none"> You are trying to record onto a disc that is unrecordable, or the disc status does not satisfy recording requirements. The disc is dirty. The disc is damaged. You are trying to record onto a VR mode DVD-RW disc which contained recordings from another recorder. 	<ul style="list-style-type: none"> Insert a recordable disc, and ensure the disc status satisfies the recording requirements. (See page 37.) Clean the disc with a cleaning cloth. Replace the disc. Disc may need formatting.
Recording Error This programme is not allowed to be recorded on this disc.	<ul style="list-style-type: none"> You are trying to record a copy-once programme onto a DVD disc that is not compatible with CPRM. 	<ul style="list-style-type: none"> Insert a ver. 1.1 or ver. 1.2 DVD-RW disc (compatible with CPRM.)
Recording Error This disc is protected and not recordable.	<ul style="list-style-type: none"> You are trying to record onto the VR mode DVD-RW, DVD+RW / +R disc that is set as protected in "Setup" Menu. 	<ul style="list-style-type: none"> Remove the disc protect setting in "DVD Menu" menu. (See page 58.)
Recording Error Disc is full. (No area for new recording)	<ul style="list-style-type: none"> You are trying to record onto the VR mode DVD-RW disc that has no space for recording. 	<ul style="list-style-type: none"> Insert a recordable disc with enough recording space. Delete unnecessary original titles. (See page 76.)
Recording Error You cannot record more than 99 titles on one disc. (The maximum is 99)	<ul style="list-style-type: none"> You are trying to record onto the DVD-RW / -R disc on which the number of recorded titles has reached the maximum (99). 	<ul style="list-style-type: none"> Delete unnecessary original titles. (See page 76.)
Recording Error You cannot record more than 999 chapters on one disc. (The maximum is 999)	<ul style="list-style-type: none"> You are trying to record onto the VR mode DVD-RW disc on which the number of recorded chapters has reached the maximum (999). 	<ul style="list-style-type: none"> Delete unnecessary chapter mark from an Original list. (See pages 78 - 79.)
Recording Error You cannot record more than 49 titles on one disc. (The maximum is 49)	<ul style="list-style-type: none"> You are trying to record onto the DVD+RW/+R disc on which the number of recording titles comes up to the maximum (49). 	<ul style="list-style-type: none"> Delete unnecessary titles. (See page 76.)
Recording Error You cannot record more than 254 chapters on one disc. (The maximum is 254)	<ul style="list-style-type: none"> You are trying to record onto the DVD+RW disc on which the number of recording chapters comes up to the maximum (254). 	<ul style="list-style-type: none"> Delete unnecessary chapter marks. (See pages 78 - 79.)
Recording Error You cannot record on this disc as Control Information is full.	<ul style="list-style-type: none"> This disc has no space to write Control Information when recording or deleting contents. When editing has been repeatedly performed, the control information area may become full even though the recording area has enough space. 	<ul style="list-style-type: none"> Delete unnecessary original titles. (See page 76.)
Recording Error You cannot record on this disc as Power Calibration Area is full.	<ul style="list-style-type: none"> When recordings are performed repeatedly onto an unstable disc, this area may become full. Every time you insert a disc for recording, part of the disc's working area will be used. If you repeat this frequently, it will be used up quicker and you may not be able to record maximum number of titles for the disc. 	<ul style="list-style-type: none"> Insert a new disc.
Recording Error This disc is already finalised.	<ul style="list-style-type: none"> You are trying to record onto a disc that is already finalised. 	<ul style="list-style-type: none"> Release the finalising for the disc. (See page 59.)

Introduction

Connections

Basic Setup

Recording

Playback

Editing

Function Setup

VHS Functions

Others

Error message	Cause	Solution
Recording Error The disc has no recording compatibility. Set "Make Recording Compatible" to "ON" to convert the disc.	<ul style="list-style-type: none">You are trying to record onto the unfinalised +VR mode discs recorded on other unit.	<ul style="list-style-type: none">Set "Make Recording Compatible" to "ON" to rewrite the menu, after that you will record to disc. (See page 39.)
Recording Error You cannot record more than 600 titles on HDD. (The maximum is 600).	<ul style="list-style-type: none">You are trying to record onto the HDD when total title number is already at its limit.	<ul style="list-style-type: none">Delete unnecessary titles. (See page 76.)
Recording Error HDD is full. (No area for new recording)	<ul style="list-style-type: none">There is not enough space on the internal HDD.	<ul style="list-style-type: none">Delete unnecessary titles. (See page 76.)

* If you are still having trouble with the unit after checking all the Troubleshooting points, write down the error code and the error description and consult your dealer or an authorised service centre.

Language Code

Language	Code	Language	Code	Language	Code	Language	Code
Abkhazian	4748	French	5264	Lithuanian	5866	Sindhi	6550
Afar	4747	Frisian	5271	Macedonian	5957	Singhalese	6555
Afrikaans	4752	Galician	5358	Malagasy	5953	Siswat	6565
Albanian	6563	Georgian	5747	Malay	5965	Slovak	6557
Amharic	4759	German	5051	Malayalam	5958	Slovenian	6558
Arabic	4764	Greek	5158	Maltese	5966	Somali	6561
Armenian	5471	Greenlandic	5758	Maori	5955	Spanish	5165
Assamese	4765	Guarani	5360	Marathi	5964	Sundanese	6567
Aymara	4771	Gujarati	5367	Moldavian	5961	Swahili	6569
Azerbaijani	4772	Hausa	5447	Mongolian	5960	Swedish	6568
Bashkir	4847	Hebrew	5569	Nauru	6047	Tagalog	6658
Basque	5167	Hindi	5455	Nepali	6051	Tajik	6653
Bengali; Bangla	4860	Hungarian	5467	Norwegian	6061	Tamil	6647
Bhutani	5072	Icelandic	5565	Occitan	6149	Tatar	6666
Bihari	4854	Indonesian	5560	Oriya	6164	Telugu	6651
Bislama	4855	Interlingua	5547	Oromo (Afan)	6159	Thai	6654
Breton	4864	Interlingue	5551	Panjabi	6247	Tibetan	4861
Bulgarian	4853	Inupiak	5557	Pashto; Pushto	6265	Tigrinya	6655
Burmese	5971	Irish	5347	Persian	5247	Tonga	6661
Byelorussian	4851	Italian	5566	Polish	6258	Tsonga	6665
Cambodian	5759	Japanese	5647	Portuguese	6266	Turkish	6664
Catalan	4947	Javanese	5669	Quechua	6367	Turkmen	6657
Chinese	7254	Kannada	5760	Rhaeto-Romance	6459	Twi	6669
Corsican	4961	Kashmiri	5765	Romanian	6461	Ukrainian	6757
Croatian	5464	Kazakh	5757	Russian	6467	Urdu	6764
Czech	4965	Kinyarwanda	6469	Samoan	6559	Uzbek	6772
Danish	5047	Kirghiz	5771	Sangho	6553	Vietnamese	6855
Dutch	6058	Kirundi	6460	Sanskrit	6547	Volapuk	6861
English	5160	Korean	5761	Scots Gaelic	5350	Welsh	4971
Esperanto	5161	Kurdish	5767	Serbian	6564	Wolof	6961
Estonian	5166	Laothian	5861	Serbo-Croatian	6554	Xhosa	7054
Faroese	5261	Latin	5847	Sesotho	6566	Yiddish	5655
Fiji	5256	Latvian; Lettish	5868	Setswana	6660	Yoruba	7161
Finnish	5255	Lingala	5860	Shona	6560	Zulu	7267

Introduction

Connections

Basic Setup

Recording

Playback

Editing

Function Setup

VHS Functions

Others

Glossary

Analogue audio

An electrical signal that directly represents sound. In contrast, digital audio can also be an electrical signal, but is an indirect representation of sound. See also "Digital audio".

Aspect ratio

The width of a TV screen relative to its height. Conventional TVs are 4:3 (i.e., the screen is almost square). Widescreen models are 16:9 (the screen is almost twice as wide as its height).

Chapter

Just as a book is split up into several chapters, a title on an HDD/DVD is usually divided into chapters. See also "Title".

Component video output

Each signal of luminance (Y) and component (P_B/C_B , P_R/C_R) is independent to output so that you can experience picture colour as it is.

Also, due to compatibility with progressive video (576p/480p), you can experience higher-density picture than that in interlace (576i/480i).

CPRM

(Content Protection for Recordable Media)

CPRM is a scrambling copy protection system for the protection of "copy-once" broadcast programmes (e.g. some satellite broadcasts).

Digital audio

An indirect representation of sound using numbers. During recording, the sound is measured at discrete intervals (44,100 times a second for CD audio) by an analogue-to-digital converter, generating a stream of numbers. On playback, a digital-to-analogue converter generates an analogue signal based on these numbers. See also "Sampling frequency" and "Analogue audio".

Dolby Digital

A system developed by Dolby Laboratories that compresses digital sound. It works with stereo (2ch) or multi-channel audio.

DTS

(Digital Theater System)

DTS is a multi channel surround sound system. By connecting to DTS decoder, you can enjoy dynamic and realistic sound like movie theatre. DTS surround sound technologies were developed by DTS, Inc.

Finalise

To make DVDs that have been recorded playable in DVD players. It is possible to finalise DVD-RW/-R and DVD+RW/+R discs with this unit.

HDMI

(High Definition Multimedia Interface)

A digital interface between audio and video source. It can transmit component video, audio, and control signal with one cable connection.

JPEG

(Joint Photographic Experts Group)

JPEG is a method of compressing still image files. You can copy JPEG files on CD-RW/-R discs from a computer and play back the files on this unit.

MP3

(MPEG Audio Layer 3)

MP3 is a method of compressing files. You can copy MP3 files on CD-RW/-R discs from a computer and play back the files on this unit.

PBC (Video CD only)

(Playback Control)

This function enables you to play back interactive software using a menu screen. See also "Title".

PCM

(Pulse Code Modulation)

PCM is a format that converts audio into digital data. It is mainly used for Audio CDs and DAT. This unit can play back sounds as realistic as possible by converting even compressed Dolby Digital and MPEG audio to PCM.

Playlist

From this list, you can play back contents of a disc in your desired order or in sequence. It is also possible to directly search for a specific scene.

Progressive Scan (576p/480p)

A type of display that does not split each frame into fields, and instead scans directly through all the scanlines of each frame in order. Progressive Scan provides less flickering and higher image resolution than traditional (576i/480i) TV signals. Refer to pages 20 to 21 and 90 for instructions on the Progressive Scan mode selection.

Region code

Regions associate discs and players with particular areas of the world. This unit will only play back discs that have compatible region codes. You can find the region code of your unit by looking on the rear panel. Some discs are compatible with more than one region (or all regions).

Sampling frequency

The rate at which sound is measured by a specified interval to turn it into digital audio data. The number of samples in one second is defined as the sampling frequency. The higher the rate is, the better the possible sound quality.

Title

(HDD/DVD)

A collection of chapters on an HDD/DVD. See also "Chapter".

(Video CD)

The contents of a Video CD. When playing back a Video CD with the PBC function, the Title Menu will appear automatically.

Track

Audio CDs and Video CDs use tracks to divide the contents of a disc. The DVD equivalent is called a chapter. See also "Chapter".

Video mode

Video mode is the same recording format as used on the DVD-Videos you purchase in local shops. You can play back the discs recorded in this format in most DVD players, however it offers only limited editing. You will need to finalise discs recorded in Video mode before playing them back on other unit.

VR mode

A basic recording format for DVD-RW. VR mode offers advanced editing, and you can record and edit material repeatedly, however it is playable only on VR mode compatible unit. Finalisation is recommended before playing them back on other unit.

+VR mode

A recording format for DVD+RW/+R. +VR mode offers basic editing, and it is playable on most DVD players. Finalisation is recommended before playing them back in other unit.

Specifications

General

System	HDD, DVD-Video, DVD-RW/-R, DVD+RW/+R, Video CD, CD-DA, CD-RW/-R, Videotape
VHS video heads	Four heads
HDD	Internal 3.5 inch HDD 160 GB
Power requirements	220–240 V \sim \pm 10%, 50 Hz \pm 0.5%
Power consumption	48 W (standby: 8.0 W)
Weight	5.8 kg
Dimensions (width x height x depth)	435 x 99.5 x 388 mm
Operating temperature	5°C to 40°C
Operating humidity	Less than 80% (no condensation)
TV format	PAL-B/G, SECAM-LL'

Recording

Recording format	Video Recording (VR) format (DVD-RW only), Video format (DVD-RW, DVD-R), +VR format (DVD+RW, DVD+R)
Recordable discs	DVD-ReWritable, DVD-Recordable, DVD+ReWritable, DVD+Recordable
Video recording format	
Sampling frequency	13.5 MHz
Compression format	MPEG
Audio recording format	
Sampling frequency	48 kHz
Compression format	Dolby Digital

Tuner

Analogue channels	
L (SECAM L)	F1 - E69
BG (PAL B/G)	E2 - E69
DVB-T channels	
VHF	F5 - F10
UHF	E21 - E69

Input/Output

Front Panel : (AV3)

Video input	One RCA connector
Input level	1 Vp-p (75 Ω)
Audio input	Two RCA connectors
Input level	2 Vrms (input impedance: more than 10 k Ω)
DV input	IEEE 1394
DV 4-pin jack	

Rear Panel :

VHF/UHF antenna input/output terminal	75 Ω
Audio input /output	Two 21-pin scart sockets (AV1, AV2)
Video input /output	Two 21-pin scart sockets (AV1, AV2)
Input /output level	1 Vp-p (75 Ω) each
Component video output	Three RCA connectors
Output level	Y: 1.0 Vp-p (75 Ω) P _B /C _B , P _R /C _R : 0.7 Vp-p (75 Ω) each
Audio output	Two RCA connectors
Output level	2 Vrms (output impedance: 680 Ω)
Digital audio output	One Coaxial pin jack
Output level	500 mVp-p (75 Ω)
HDMI output	HDMI jack

Note

The specifications and design of this product are subject to change without notice.

Introduction

Connections

Basic Setup

Recording

Playback

Editing

Function Setup

VHS Functions

Others

Free Manuals Download Website

<http://myh66.com>

<http://usermanuals.us>

<http://www.somanuals.com>

<http://www.4manuals.cc>

<http://www.manual-lib.com>

<http://www.404manual.com>

<http://www.luxmanual.com>

<http://aubethermostatmanual.com>

Golf course search by state

<http://golfingnear.com>

Email search by domain

<http://emailbydomain.com>

Auto manuals search

<http://auto.somanuals.com>

TV manuals search

<http://tv.somanuals.com>