

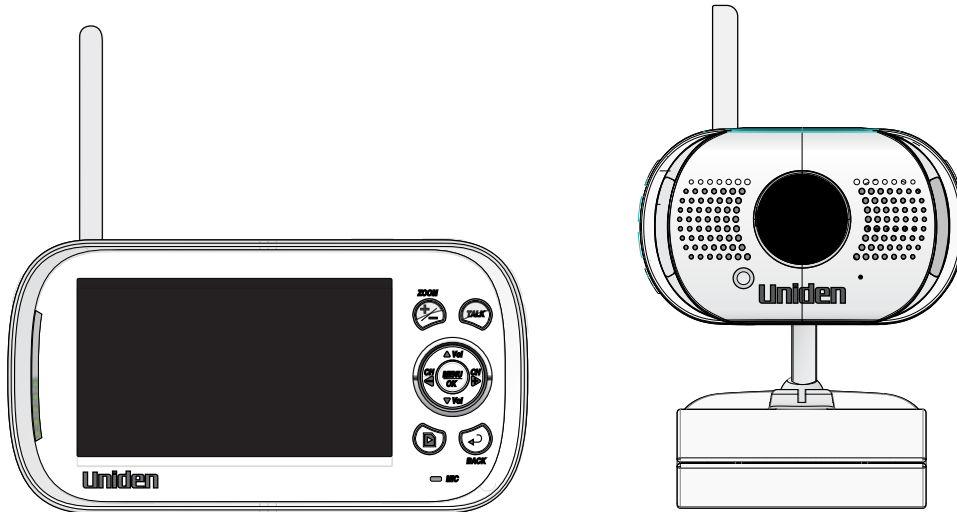

# Portable Digital Wireless Baby Monitor UBR243 User's Guide



## CUSTOMER CARE

At Uniden®, we care about you!

If you need assistance, please do NOT return this product to your place of purchase. Our customer care specialists are available to serve you.

Quickly find answers to your questions by:

1. Reading your owner's manual, included with this product.
2. Visiting our customer support website at [www.uniden.com](http://www.uniden.com).
3. Calling our customer care specialists at 1-800-297-1023.

## IMPORTANT SAFETY PRECAUTIONS

***This manual contains important information about this product's operation. If you are installing this product for others, you must leave this manual or a copy with the end user.***

When using your equipment, always follow basic safety precautions to reduce the risk of fire, electric shock and injury to persons, including the following:

- The camera is NOT weatherproof. It is an indoor camera
- To avoid any risk of electric shock from lightning, avoid handling any electronic devices (except battery-powered ones) during an electrical storm.
- Use only the power cord indicated in this manual.
- Never tug or pull on any power cord; be sure to leave some slack in the cord when placing your equipment, and always use the plug to unplug cord from the wall outlet.
- Never leave power cords where they can become crushed, cut, or frayed; when running power cords, avoid letting them rub against any sharp edges or lie across any high traffic areas where people might trip over them.
- Do not use the device if the adapter cords or plugs have been damaged, the monitor has been exposed to liquids, or the monitor/camera has been dropped or is damaged.



## **WARNING TO PARENTS AND OTHER USERS**

Failure to follow these warnings and the assembly instructions could result in serious injury or death. This product is not designed or intended for use as a medical monitor, nor should this product be used as a substitution for medical or parental supervision. Always be sure that both the transmitter and receiver are working properly, and are within range of each other.

- **STRANGULATION HAZARD.** Keep the adapter cords out of the reach of children.
- **WARNING: KEEP OUT OF THE REACH OF CHILDREN.** This product is not a toy and is not intended for use by any children under the age of 13. If you are between the ages of 13 and 18, review these terms, conditions and safety warnings with your parents or guardian to make sure that you and your parent or guardian understand these terms, conditions, and safety warnings.
- Allow for proper ventilation when units are in use. Do not cover the camera or receiver with any object such as a blanket. Do not place it in a drawer or in any location which would muffle the sound or interfere with the normal flow of air.

---

***SAVE THESE INSTRUCTIONS!***

---

## **FOR BEST RESULTS**

To avoid damage to your equipment, follow these simple precautions:

- Do not drop, puncture or disassemble any part of the equipment. There are no user-serviceable parts inside.
- Do not expose the equipment to high temperatures, and avoid leaving the equipment in direct sunlight for more than a few minutes. Heat can damage the case or electrical parts.
- Do not place heavy items on top of the equipment or expose the equipment to heavy pressure.
- Remove the power adapter during long periods between usages.
- Clean only with a dry cloth.

Failure to follow the instructions in this operating manual will void the warranty. Uniden assumes no liability for damages to property or injury to persons caused by improper handling or failure to comply with these safety instructions.

# CONTENTS

## OVERVIEW .....5

FEATURES.....	5
Camera .....	5
Monitor.....	6
USING THE MANUAL.....	6

## GETTING STARTED.....8

WHAT'S INCLUDED .....	8
MONITOR INSTALLATION.....	9
CAMERA INSTALLATION.....	9
Placement Considerations .....	9
Wall Mount.....	10
Suction Mount.....	10
Connect Power .....	11

## BASIC OPERATION ..... 12

WIRELESS CAMERA .....	12
WIRELESS MONITOR.....	14
LCD DISPLAY .....	17
USING THE UBR243.....	19
Viewing Modes.....	19
Common Operations.....	20

## SYSTEM MENU DESCRIPTIONS ..... 21

SYSTEM .....	21
Date/Time.....	22
Brightness.....	23
AV Out.....	23
Format Storage.....	24
Factory Reset.....	24
Language.....	25
Temperature Display Unit .....	25
Temperature Alert Range .....	26
ALERT.....	27
RECORD.....	28
Quality.....	28
Record Time.....	29

Vox.....	29
Overwrite .....	30
CAMERA.....	30
Pair .....	31
On/Off.....	32
POWER SAVE.....	32

## SPECIAL FEATURES..... 34

RECORDING VIDEO .....	34
Recording .....	34
Viewing Recorded Video.....	34
Deleting Folders and Video Files .....	35
VIEWING LIVE VIDEO .....	35
Viewing On Your TV.....	35
Viewing on Your Remote PC or Wireless Decice .....	36
Viewing Recorded Video on your Computer.....	36
ZOOM.....	37
NIGHT LIGHT .....	37
LULLABIES.....	37
USING THE INTERCOM.....	38
CAMERA PAIRING.....	38

## MAINTAINING YOUR SYSTEM ..... 40

MONITOR.....	40
CAMERA.....	40

## SOLVING PROBLEMS ..... 41

## SPECIFICATIONS ..... 42

GENERAL.....	42
CAMERA.....	42
MONITOR.....	43

## FCC Notices ..... 43

## IC Compliance Information..... 44

## THREE-YEAR LIMITED WARRANTY ..... 44

Uniden surveillance products are not manufactured and/or sold with the intent to be used for illegal purposes. Uniden expects consumer's use of these products to be in compliance with all local, state and federal law. For further information on video surveillance and audio recording legal requirements, please consult your local, state and federal law enforcement agency.

# OVERVIEW

## FEATURES

- Digital wireless technology provides excellent image quality and clarity
- Interference free, secure, and private signal
- Up to 500 ft. transmission range

***Maximum open space transmission range. The actual range varies depending on building materials and other obstructions in wireless signal path.***

- Exceptional sound clarity
- Out of range notification
- Four lullaby selections
- Monitor/Camera-controlled night light
- System expandable up to 4 cameras (one camera included; additional cameras sold separately)
- Two-way audio communication
- Camera room temperature display on monitor; temperature range alert
- Recording to microSD card (supports up to 32 GB microSD card - not included)
- Play back recorded video
- Monitor live video from wired and wireless devices.

## Camera

- VGA resolution camera
- Built-in microphone
- Night light control
- Lullaby control

- Built-in battery for true portable wireless operation
- Night vision allows for low light viewing up to 15 feet / 4.5 meters

***IR illumination range of 15ft./4.5m under ideal conditions. Objects at or beyond this range may be partially or completely obscured, depending on the camera application.***

## **Monitor**

- 4.3" color LCD monitor with superior image quality
- Rechargeable lithium polymer battery for true portability
- Audio level indicator
- Intercom
- Room temperature display
- Remote night light control
- Remote lullaby control
- Recorded video playback controls

## **USING THE MANUAL**

This manual is set up in eight sections:

- Overview. This general section lists the system's features. It also tells you how to use this manual.
- Getting Started. This section lists the hardware you should have in your box and how to set it up.
- Basic Operations. This section describes your equipment's function keys in detail. It also provides a list of basic operations in an abbreviated format, referencing screen details in the next section.
- Uniden UBR243 Screen Descriptions. Here you will find detailed descriptions of each screen and how it is used.
- Special Features. This section tells you about the UBR243 special features.

- **Maintaining Your System.** This section provides tips on how to keep your UBR243 hardware clean and in excellent working condition.
- **Solving Problems.** Troubleshooting tips are located here.
- **Specification.** This last section contains hardware and software specifications.

# GETTING STARTED

## WHAT'S INCLUDED

The system comes with the following components:



Digital Wireless Monitor (1)

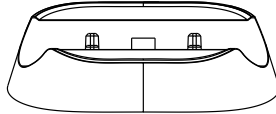

UBR243 Charger Cradle (1)

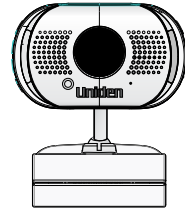

Digital Wireless Camera (1)

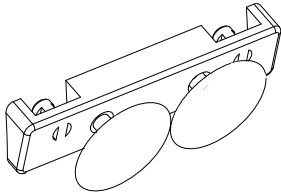

Suction Cup Adapter Bar (1)



Screws and Anchors

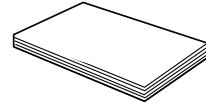

Owner's Manual

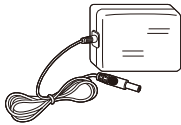

AC Power Adapter (2)

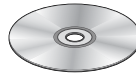

CD

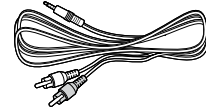

AV Cable

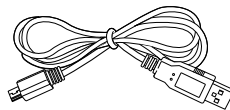

USB cable



***If any items are missing or damaged, contact our Customer Care Line immediately.  
Never use damaged products!***

## **MONITOR INSTALLATION**

1. Place the monitor in a location with clear reception from your camera(s).
2. If you are using the monitor as a stand-alone unit, flip out the stand on the back of the monitor and extend the antenna. Connect an AC adapter to the power input on the side of the receiver. If you are using the monitor in the cradle, insert it into the cradle and connect an AC adapter to the input jack on the back of the cradle.
3. Plug the power plug into a 120 volt AC (standard indoor) power outlet or surge protector.
4. Press and hold the power button to turn the unit on or off. Let the monitor charge for 6 hours prior to first time use so the built-in rechargeable monitor battery is fully charged. **DO NOT** remove the power cable from the monitor/cradle during the initial charge process. After the initial charge, recharge the monitor as needed.
5. *Out of range* displays until you turn on the camera.

## **CAMERA INSTALLATION**

The UBR243 camera and mounting clip are a complete unit. The UBR243 camera does come with a separate suction cup bar. With it installed, you can mount the camera on glass or smooth metallic surfaces.

### **Placement Considerations**

- The camera included with your monitor is **NOT** weatherproof; it is an indoor camera.
- The clearest line-of-sight between the camera and monitor is best. Walls, especially brick and concrete, can affect reception quality.
- Avoid having a direct light source in view of the camera (ceiling or floor lamps).
- Carefully plan where and how the camera will be positioned, and where you will route the cable that connects the camera to the power adapter.

- When you are positioning the camera, bring the monitor along; it's much easier to get the camera into the right position when you have the display handy. Check the image on the monitor before you install the camera.
- *Out of range* displays when the camera is out of range, turned off, or unsuccessfully paired to the monitor. It also displays when the monitor is out of range.

***You can install additional cameras (maximum of 4 cameras). When adding cameras that were not included in the original box, you will need to pair the cameras with the monitor. Refer to page 38.***

## Wall Mount

The UBR243 camera mounting clip has two slots that fit over screws to mount the unit on the wall.

1. Mark the position of the screw holes on the wall.
2. Drill holes and insert the anchors and screws provided.  
Be sure to leave room for the mounting clip to fit over the screw heads.
3. Place the mounting clip over the installed screws and push it downwards, locking it into place.
4. Adjust the camera as needed.

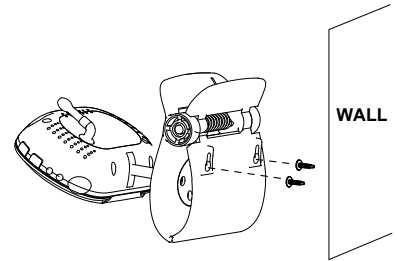

## Suction Mount

1. Insert the suction base into the mounting clip as shown.
2. Firmly press the camera with the suction base attached onto glass or metallic surfaces.
3. Adjust the camera as needed.

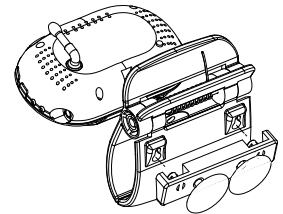

#### 4. Clip-Mount

Clip the UBR243 on ledges and shelves.

1. Press the mounting clip as shown.
2. Place the unit over the mounting surface and release.
3. Adjust the camera as needed.

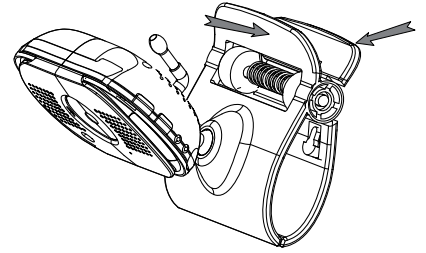

#### Connect Power

1. Insert the AC adapter power plug into the camera's DC adapter input jack.
2. Plug the other end into a 120 volt AC (standard indoor) power outlet or surge protector. The red charging LED turns on.
3. Press **POWER**. The green power LED turns on and the monitor now displays camera video. If it doesn't, try reconnecting the AC adapter, making sure the power outlet isn't controlled by a wall switch.

# BASIC OPERATION

## WIRELESS CAMERA

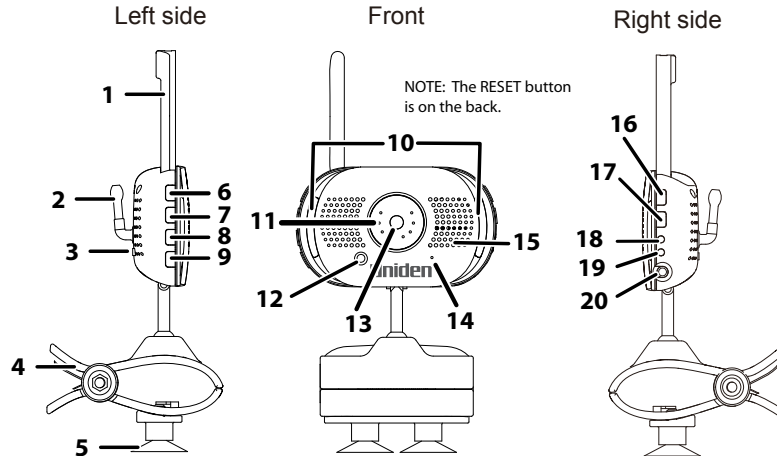

Item	What it is
1	Camera Antenna: Sends and receives signals to or from the monitor.
2	Temperature sensor: Detects temperature at camera side and displays it on the monitor LCD.
3	<b>PAIR:</b> Pairs the camera to the monitor.
4	Clip: This fastener can attach the camera to shelves or ledges.
5	Suction base: Attach to mount the camera on glass or metallic surfaces.
6	<b>▲Vol:</b> Increase speaker volume.
7	<b>▼Vol:</b> Decrease speaker volume.
8	<b>LULLABY PLAY/STOP:</b> Press this button to play lullabies. See page 37 for details.
9	<b>LULLABY SKIP:</b> Press to play next lullaby. See page 37 for details.
10	LED night light bars.
11	IR LEDs (Covered): Infrared LEDs provide viewing in no/low light conditions.

Item	What it is
12	Light sensor: Measures light intensity on the camera side.
13	Lens: Camera lens.
14	Microphone: Receives sounds for the area near the camera, and transmits sound from the camera to the monitor.
15	Speaker: Produces the sound transmitted from the monitor.
16	<b>POWER:</b> Turns the camera ON or OFF.
17	<b>NIGHT LIGHT:</b> Press to turn the night light on or off.
18	Charging LED: Red = Charging Green = Fully charged Off = Camera and power adapter are disconnected or power adapter is disconnected from power source.
19	Power LED: Green = Camera is turned on. Green (Blinking) = Battery is low.
20	DC 5V Power: Connects the DC 5V power adapter to the camera.

# WIRELESS MONITOR

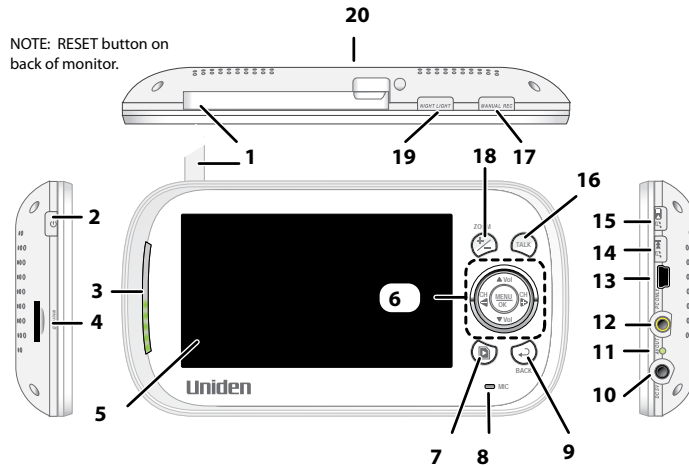

Item	What it is
1	Monitor Antenna: Sends & receives signals to or from the camera.
2	<b>POWER:</b> Turns the camera on and off.
3	LED light bar. The bottom LED indicates power and the remaining LEDs indicate sound.
4	MicroSD card slot: Insert microSD card to record video.
5	4.3 inch LCD screen.
6	<p><b>▲ Vol:</b></p> <ul style="list-style-type: none"> <li>• Increase speaker volume.</li> <li>• In Menu: Scroll up.</li> <li>• In Lullaby: Increase volume.</li> <li>• In Zoom: Scroll up.</li> <li>• In Video Playback - Restart playback.</li> </ul>

Item	What it is
	<p><b>CH◀ :</b></p> <ul style="list-style-type: none"> <li>• In Menus: Scroll left.</li> <li>• In Zoom: Scroll left.</li> <li>• In Live view: Switch between available cameras.</li> <li>• In Video Playback - Reverse.</li> </ul> <p><b>▼Vol:</b></p> <ul style="list-style-type: none"> <li>• Decrease speaker volume.</li> <li>• In Menus: Scroll down.</li> <li>• In Lullaby: decrease volume.</li> <li>• In Zoom: Scroll down.</li> <li>• In Video Playback - Pause playback.</li> </ul> <p><b>CH▶ :</b></p> <ul style="list-style-type: none"> <li>• In Menus: Scroll right.</li> <li>• In Zoom: Scroll right.</li> <li>• In Live view: Switch between available cameras</li> <li>• In Video Playback - Fast forward.</li> </ul>
	<p><b>MENU/OK:</b> Select a menu option or accept a setting.</p>
7	<b>PLAY RECORD</b>
8	Microphone
9	<p><b>BACK:</b></p> <ul style="list-style-type: none"> <li>• In Menus: Back one level.</li> <li>• In Video Playback: Back out of Video Playback function one screen at a time.</li> </ul>
10	DC 5V: Connects the DC 5V power adapter to the monitor.
11	<p>Charge LED</p> <ul style="list-style-type: none"> <li>• Green = Battery is fully charged.</li> <li>• Orange = Battery is almost charged.</li> <li>• Red = Battery is charging.</li> </ul> <p><b><i>If the monitor becomes unplugged from the adapter, this LED turns off.</i></b></p>







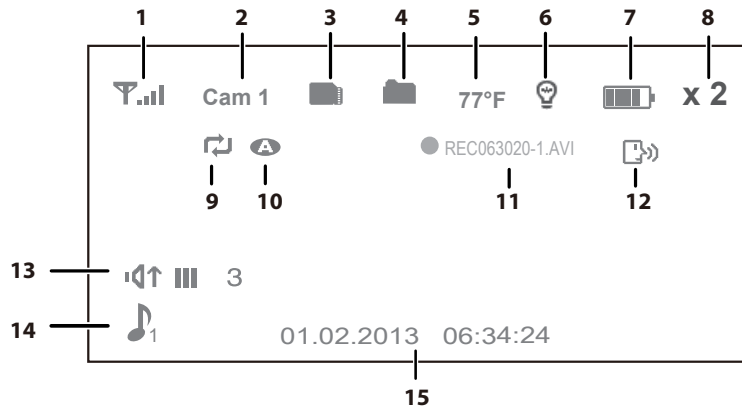

Item	What it is
12	<b>AV Out jack:</b> Connect the included A/V cable to view video from the TV or computer monitor.
13	<b>PC Only (USB Port):</b> Use the included USB cable to connect your computer to the UBR243 monitor to view video remotely or from your PC
14	<b>LULLABY SKIP:</b> Skips to the next lullaby in the series. See page 37 for details.
15	<b>LULLABY PLAY/STOP:</b> Press this button to remotely play lullabies. See page 37 for details.
16	<b>TALK:</b> Activate Intercom function (see page 38).
17	<b>MANUAL REC:</b> Press to start recording manually. Press again to stop.
18	<b>ZOOM:</b> Displays the camera image in double size (see page 34).
19	<p><b>NIGHT LIGHT</b> – Remotely turn the night light ON or OFF for the camera currently being displayed.</p> <p><b><i>The monitor's night light function is only available when the camera is paired to the monitor.</i></b></p>
20	Stand







# LCD DISPLAY



Item	Icon	What it is																		
1		Signal Indicator (displays in full screen mode only). The number of bars in the signal indicator shows the strength of the signal received from the camera. One or no bars indicates the signal is poor, and 4 bars indicate a very strong signal.																		
		<table border="1"> <thead> <tr> <th>Signal Strength</th> <th>Indicator</th> <th>Warning</th> </tr> </thead> <tbody> <tr> <td>Strong</td> <td></td> <td>None</td> </tr> <tr> <td>Good</td> <td></td> <td>None</td> </tr> <tr> <td>Fair</td> <td></td> <td>None</td> </tr> <tr> <td>Low</td> <td></td> <td>None</td> </tr> <tr> <td>No Signal</td> <td></td> <td>Out of Range</td> </tr> </tbody> </table>	Signal Strength	Indicator	Warning	Strong		None	Good		None	Fair		None	Low		None	No Signal		Out of Range
Signal Strength	Indicator	Warning																		
Strong		None																		
Good		None																		
Fair		None																		
Low		None																		
No Signal		Out of Range																		

Item	Icon	What it is
2	Cam1	<p>Camera Indicator. indicates which camera is displaying. Press <b>CH▶</b> or <b>CH◀</b> on the monitor to switch between available cameras. It will cycle in the following order:</p> <p><b>CH▶</b> : CAM1—CAM2—CAM3—CAM4—QUAD—AUTO SCAN — CAM1</p> <p><b>CH◀</b> : CAM1—Auto SCAN—QUAD—CAM4—CAM3—CAM2—CAM1</p>
3		microSD Card: This icon displays when there is a microSD card inserted into the card slot.
4		New Record Indicator. This icon indicates when a new video record is available.
5	77°F	Temperature indicator (displays in full screen mode only). Displays the temperature on the camera side.
6		Night light indicator (displays in full screen mode only). Displays when the night light is turned on. (See page 37)
7		Battery level. Indicates the amount of power left in the battery. The  icon displays when the battery is charging. The icon flickers when charging is nearly complete.
8	x 2	ZOOM indicator. The zoomed image displays as the background image.
9		Overwrite indicator. When this icon displays, the overwrite function is enabled; the video monitor will overwrite old video files when the microSD card is full.
10		Auto recording indicator. This icon displays when the motion triggers automatic recording. You can set how long the camera will record from the <i>RECORD</i> screen.
11		<p>Recording indicator. This grouping displays when video is recording.</p> <p> REC 063020-1.AVI - 06 = hour; 30 = minute; 20 = second; -1 = recording camera</p>

Item	Icon	What it is
12		Intercom (Talk). Displays in full screen mode only when you press and hold <b>TALK</b> on the monitor (see page 38).
13		Volume indicator. Displays when <b>▲Vol</b> or <b>▼Vol</b> is pressed on the monitor. If the volume is muted,  displays.
14		Lullaby (displays in full screen mode only). Displays when a lullaby is playing. The number indicates which melody is playing (see page 37).
15		Date and Time (displays in full screen mode only). Displays the time as set through the monitor.  01.02.2013 12:26:00 = month.day.year hour:minute:second

## USING THE UBR243

### Viewing Modes

Live view displays live images from the cameras in the following modes:

- Quad mode: Monitor displays video from all cameras on a single screen in 4 quadrants. Any channel that does not have a camera is blank.
- Single mode: Monitor displays video from one camera at a time.
- Scan mode: Monitor displays video from one camera at a time, but cycles through all cameras one by one.

Use **CH▶** or **CH◀** to cycle through these modes.

***Your system comes with a single camera; therefore, it only displays in Single mode in Live view or a single quadrant in Quad view.***

## Common Operations

To...	Do This...
Change between quad view, single view, and scan for Live view	Press <b>CH▶</b> to cycle through the Live modes in the following order: CAM1—CAM2—CAM3—CAM4—QUAD—AUTO Scan — CAM1
Check the temperature	The temperature displays on the monitor screen when the camera is in full screen mode. See page 25.
Turn on the night light	Press <b>NIGHT LIGHT</b> on the side of the camera (page 12) or on the monitor (page 14). See page 37 for details.
Set the date and time	See page 22.
Set the room temperature range for the temperature alert	See page 27.
Use the Lullaby function	See page 37.
Record Video	See page 34.
Play back video	See page 34.
Delete video	See page 35.
Set the room temperature range for the temperature alert	See page 27.
Adjust UBR243 volume	Press <b>▲Vol</b> (increase volume) or <b>▼Vol</b> (decrease volume) on either the camera or the monitor.
Use the Intercom	<ol style="list-style-type: none"> <li>1. Press and hold <b>TALK</b> on the monitor.</li> <li>2. Speak into the microphone.</li> <li>3. Release to hear reply.</li> </ol>
Watch video from TV	See page 35.
Watch video from remote device through Skype	See page 36

# SYSTEM MENU DESCRIPTIONS

Press **MENU/OK** to access system menus. Use the navigating buttons to navigate up (**▲Vol**), down (**▼Vol**), left (**CH◀**), and right (**CH▶**) in the menus, then press **MENU/OK** to confirm a setting. Use **CH▶** or **CH◀** to focus on the 5 different system menu selections on the clothesline.

- System
- Power Save
- Camera
- Record
- Alert

## SYSTEM

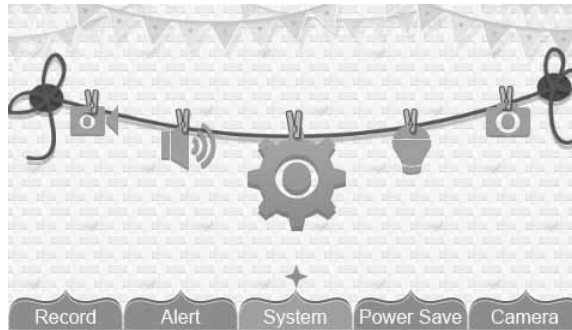

Move the focus to the System option and press **MENU/OK** to access the eight System options:

- Date/Time
- Brightness
- AV Out
- Format Storage

- Factory Reset
- Language
- Temp. display unit
- Temp. alert range

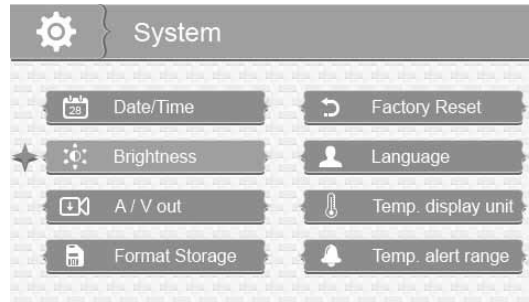

## Date/Time

This option allows you to set the system date and time. The display format is Month.Day.Year Hour:Minute (Default = 01.02.2013 12:26)

1. From the *System* menu, select *Date/Time* and press **MENU/OK**. The *Date/Time* screen displays.

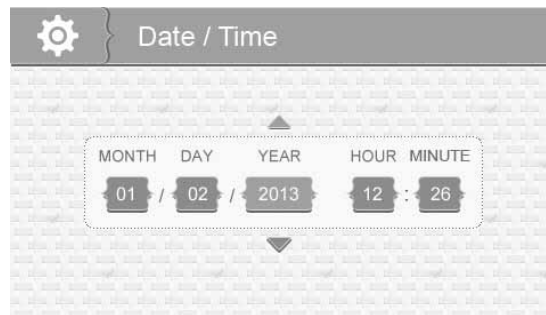

2. Press **▲Vol** or **▼Vol** to increase/decrease the number for that setting.
3. Press **CH▶** or **CH◀** to save the current setting and move to the next setting.

4. Press **MENU/OK** to save the completed date and time setting and return to the main System options. Press **BACK** to step backwards one level until you are out of the menu system.

## Brightness

This option allows you to adjust the brightness level for each camera. (Default = 3)

1. From the *System* menu, select *Brightness* and press **MENU/OK**. The *Brightness* screen displays.

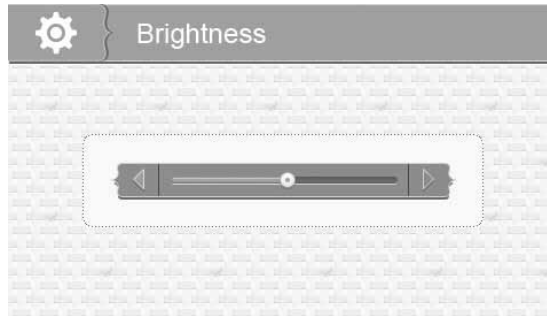

2. Press **CH▶** or **CH◀** to increase or decrease the brightness level (6 levels).
3. Press **MENU/OK** to save the setting and return to the main System options. The new brightness level displays the next time you are in Live view.

## AV Out

This option allows you to select the TV standard. (Default = NTSC)

1. From the *System* menu, select *AV Out* and press **MENU/OK**. The *AV Out* screen displays.

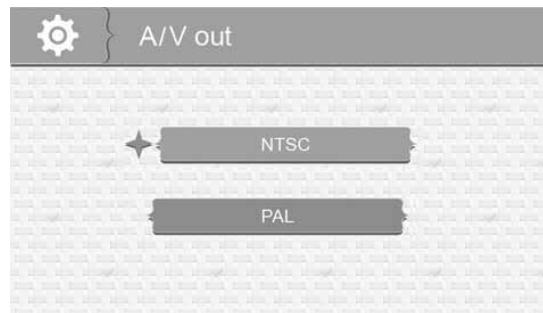

2. Press **▲Vol** or **▼Vol** to select *NTSC* or *PAL*
3. Press **MENU/OK** to save the setting and return to the main System options

## Format Storage

Turning on Format Storage allows you to delete the files on your memory card. (Default = No)

1. From the *System* menu, select *Format Storage* and press **MENU/OK**. The *Format Storage* screen displays.



2. Press **▲Vol** or **▼Vol** to toggle between accepting or canceling the microSD card reformat.
3. Press **MENU/OK** to save the setting and return to the main System options.

## Factory Reset

This option allows you to restore your system to factory setting. (Default = No)

1. From the *System* menu, select *Factory Reset* and press **MENU/OK**. The *Factory Reset* screen displays.





2. Press **▲Vol** or **▼Vol** to select or cancel a reset to factory defaults.
3. Press **MENU/OK** to save the setting and return to the main System options.

**All menu settings except Camera Pairing settings and the Date/Time Setting WILL be affected by a reset. Cameras will remain paired with the monitor.**

## Language

This option allows you to select the system's display language from English, Español, or Français. (Default = English)

1. From the *System* menu, select *Language* and press **MENU/OK**. The *Language* screen displays.



2. Press **▲Vol** or **▼Vol** to select a language.
3. Press **MENU/OK** to save the setting and return to the main System options.

## Temperature Display Unit

This option allows you to set the temperature to display in Celsius (C) or Farenheit (F). (Default = F)

1. From the *System* menu, select *Temp. display unit* and press **MENU/OK**. The *Temp. display unit* screen displays.

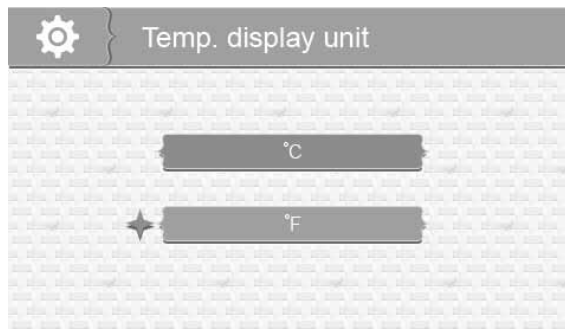

2. Press **▲Vol** or **▼Vol** to select °C or °F.
3. Press **MENU/OK** to save the setting and return to the main System options.

### Temperature Alert Range

Your UBR243 measures the ambient room temperature where the camera is. If the temperature falls outside of a preset range, the system alerts you. *Temp. alert range* lets you set that range. [Default = Low Temperature: 61 °F ; High Temperature: 77 °F; Off]

1. From the *System* menu, select *Temp. alert range* and press **MENU/OK**. The *Temp. alert range* screen displays.

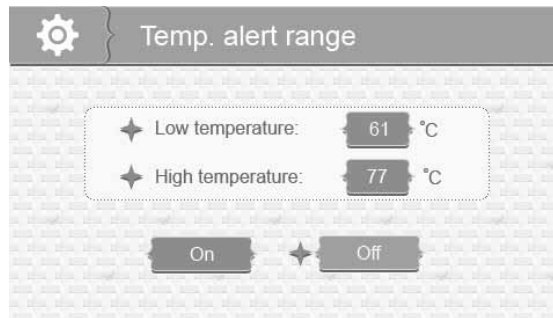

2. Press **CH▶** or **CH◀** to select *Low temperature* or *High temperature*
3. Press **▲Vol** or **▼Vol** to increase or decrease the temperature value.
4. After setting the temperature range, press **CH▶** or **CH◀** to select the *On/Off* row.

5. Press **CH▶** or **CH◀** to toggle between *On* (Enable) or *Off* (disable). Either button will work.
6. Press **MENU/OK** to save the settings and return to the main System options.

## ALERT

Temperatures out of range or a camera out of range triggers alerts. This option allows you to set the alert volume. There are 6 levels available. [Default = Zero (Mute)]

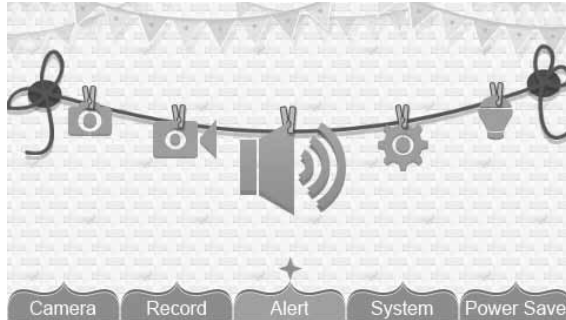

1. From the main menu selections, select *Alert* and press **MENU/OK**. The *Alert Volume* screen displays.

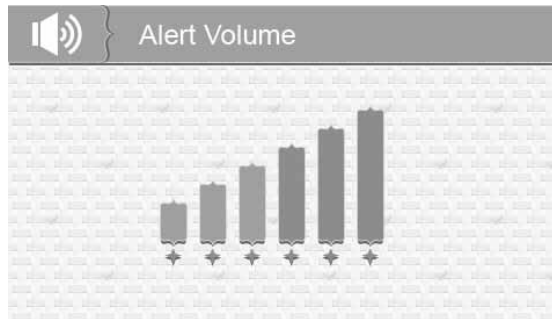

2. Press **CH▶** or **CH◀** to adjust the volume.
3. Press **MENU/OK** to save the selection and return to the main menu selections.

## RECORD

This option allows you to set the parameters for your recorded files. The RECORD options are:

- Quality
- Record Time
- Vox
- Overwrite



### Quality

This option allows you to choose between a high or low resolution recording quality. (Default = Low 320 x 240)

1. From the Record menu, select *Quality* and press **MENU/OK**. The *Quality* screen displays.



2. Press **▲Vol** or **▼Vol** to select a level (*High or Low*).
3. Press **MENU/OK** to save the selection and return to the main *RECORD* options.

## Record Time

This option allows you to select how long the camera will record when the motion sensitivity function is activated. (Default = 30 secs.)

1. From the Record menu, select *Record Time* and press **MENU/OK**. The *Record Time* screen displays.



2. Press **▲Vol** or **▼Vol** to select a recording time block.
3. Press **MENU/OK** to save the selection and return to the main *RECORD* options.

## Vox

VOX allows you to set the sound sensitivity for the camera. (Default = High)

1. From the *Record* menu, select *VOX* and press **MENU/OK**. The *VOX* sensitivity screen displays.

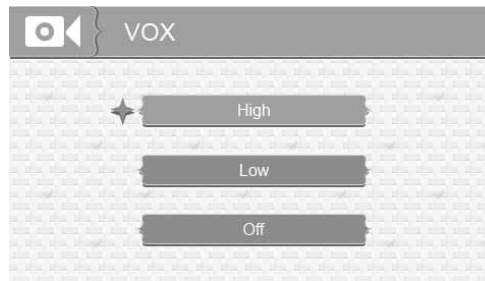

2. Press **▲Vol** or **▼Vol** to select a level (*High*, *Low*, or *Off*).

3. Press **MENU/OK** to save the selection and return to the main *RECORD* options.

## Overwrite

Activating this function allows the oldest files to be deleted when you want to record but the memory card is full.

1. From the Record menu, select *Overwrite* and press **MENU/OK**. The *Overwrite* screen displays. (Default = No)



2. Press **▲Vol** or **▼Vol** to toggle between *Yes* and *No* to activate or deactivate this feature.
3. Press **MENU/OK** to save the selection and return to the main *RECORD* options.

***Please use well-known brands of microSD cards to avoid operation errors. The UBR243 supports up to 32GB microSD cards.***

## CAMERA

This option allows you to pair the monitor with cameras (up to 4 cameras supported) or to turn on/off individual camera. The cameras are still powered on but no longer visible to the monitor.

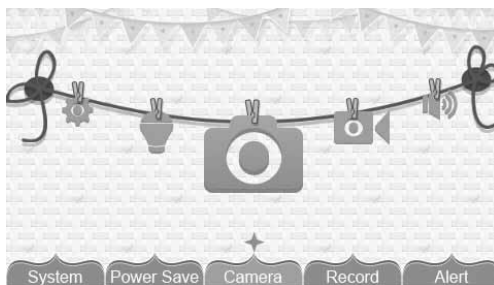

1. From the main menu selections, select *Camera* and press **MENU/OK**.
2. The *Camera* options screen displays. Two options display: *Pair* and *On/Off*. (Default =Pair)

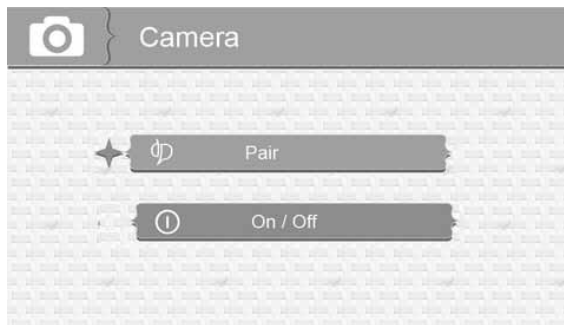

## Pair

Pairing allows you to introduce additional cameras to the monitor. The monitor can then recognize and display video from them. The camera that comes with this system is already paired. (Default = Camera 1)

***Before pairing additional cameras, be sure they are powered and turned on. See page 11.***

1. Select *Pair* from the *Camera* options screen. The camera selection screen displays.



2. Press **▲Vol** or **▼Vol** to select the camera you want to pair, then press **MENU/OK**. The monitor prompts you to press **PAIR** on the back of the camera within 30 seconds.
3. Press **PAIR** on the back of the camera within 30 seconds.
4. That camera's video displays on the monitor when pairing is successful.

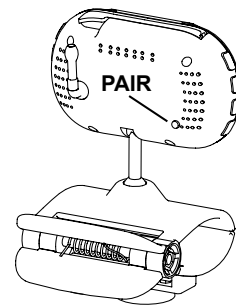

***Pair the cameras to the monitor before mounting them.***

## **On/Off**

This option allows you to turn individual cameras on/off so their video is not visible through the monitor. (Default = Camera one - On; Cameras 2 - 4 - Off)

1. Select *On / Off* from the *Camera* options screen. The *On / Off* screen displays.



2. Press **▲Vol** or **▼Vol** to select a camera.
3. Press **CH▶** or **CH◀** to toggle between *On* and *Off* for that camera. Either button will work.
4. Press **▲Vol** or **▼Vol** to select another camera.
5. Press **MENU/OK** to accept that setting and return to the *Camera* options screen.

## **POWER SAVE**

Activating the Power Save feature turns off the LCD after two minutes of inactivity. Be sure that VOX is activated, however (see page 29). If VOX is deactivated, press any button on the monitor to turn the LCD back on. This option allows you to enable or disable this function. (Default = Off)



Voice Activation (VOX) will turn the LCD back on. Even with the LCD off, the LED light bar is still active.

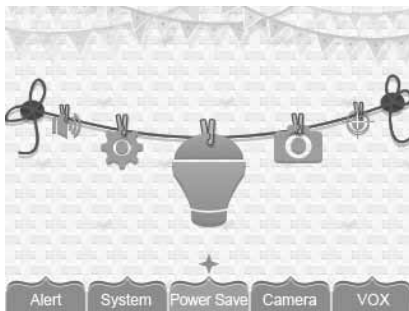

1. From the main menu selections, select *Power Save* and press **MENU/OK**. The *Power Save* screen displays.

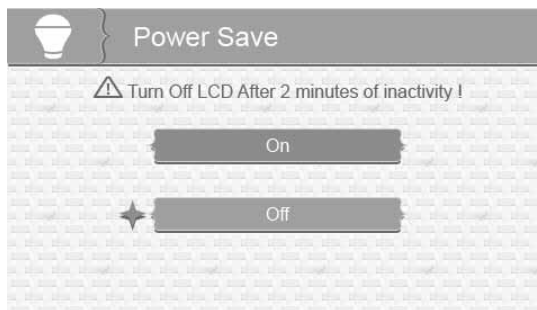

2. Press **▲Vol** or **▼Vol** to toggle between turning the Power Save feature on or off.
3. Press **MENU/OK** to accept that setting and return to the main menu selections.

# SPECIAL FEATURES

## RECORDING VIDEO

You can manually record video to a microSD card (not included). The UBR243 supports up to 32GB microSD card. The system records video in 10 minute blocks; however, you can manually stop recording at any time.

***During recording, only TALK is active. All other buttons are disabled.***

### Recording

***Be sure a microSD card is inserted into the microSD card slot.***

1. Press **MANUAL REC** on the monitor. The New Record icon flashes yellow to indicate a new file has recorded. The recording indicator also displays.
2. Press **MANUAL REC** again to cancel manual recording.

***The New Record icon flashes red when the microSD card is full. Either manually delete video records (page 35), enable Overwrite (page 30), or reformat the microSD card to delete all records (page 24).***

### Viewing Recorded Video

1. Press **PLAY RECORD** to enter the *PLAY FILE* list.
2. Select the Video folder and press **MENU/OK**
3. That folder contains other folders sorted by date (Format = MMDDYYYY). For example: 03302013 means the videos in this folder are recorded on March 30th, 2013. Press **▲ Vol** or **▼ Vol** to select a folder you want to view and press **MENU/OK** to open that folder and browse the files inside. Scroll down to see a complete list of folders or recorded files if needed.
4. Inside that folder are record files, sorted by time. For example: 123030-1 means the video is recorded at 12:30:30 and from camera 1.
5. Select the video you want to view and press **MENU/OK**. The video plays on the LCD screen.
6. Use the following buttons to manage the video:
  - **▲ Vol** - Pause, resume video

- ▼Vol - Stop
- CH▶ - Fast forward (up to x16 speed)
- CH◀ - Reverse (up to x16 speed)
- BACK - Back out of the video playback function, one screen at a time.

## Deleting Folders and Video Files

You can delete a specific video record or an entire folder of records. As you scroll through folders, you will see a red "X" to the right of folders and video records on the *PLAY FILE* screen.

1. Press CH▶ to highlight the red "X" beside the folder or record you want to delete. Press MENU/OK.
2. A confirmation screen displays. Use CH▶ or CH◀ to select Yes. Press MENU/OK.
3. The system returns to the same screen where you can see that the folder or record has been deleted.

## VIEWING LIVE VIDEO

The UBR243 lets you view live video from your system on your television. You can also use Skype™ to view your system on a remote PC or wireless devices such as an iPhone®, iPad®, or Android™ smartphone or tablet.

### Viewing On Your TV

1. Connect the monitor to your television using the AV Output cable (included).
2. The monitor screen goes blank and the TV screen displays the camera output.

***The monitor controls still operate while the system is connected to the TV. You can change cameras, set the cameras to scan through each in sequence, etc.***

## Viewing on Your Remote PC or Wireless Device

### Setup

1. Set up a Skype™ account linked to your UBR243. Please refer to Appendix A for details on setting up this free account.

***Be sure the Skype™ account is set to "Auto Answer."***

2. Set up a Skype™ account on your wireless device or remote computer.
3. Invite the other Skype™ account into your contacts; accept the invitation from the invited account.

### Remote Viewing

1. Determine which camera you want to be available for remote viewing. Set it as the Live view camera (see page 19).
2. Connect the UBR243 to your home computer using the USB cable. If the USB driver is not installed, you will be prompted to install it from the CD provided. Follow the installation prompts and then continue with these procedures.
3. Activate Skype™ on your home computer.
4. From your wireless device or remote computer, call the Skype™ account for the UBR243. Because that account was set up with Auto Answer, you should see live video from the camera you set up in Step 1.

***You must have a separate Skype™ account to call the home computer. You cannot use your home computer's Skype™ account to call itself.***

## Viewing Recorded Video on your Computer

The microSD card saves UBR243 video records in AVI format. You can take that card and play it on your computer. You will need a microSD card and adapter (not included) or an SD card reader for other systems (not included)

1. Remove microSD card from the UBR243. Place it in the adapter and insert adapter into your PC.
2. Navigate to the SD card on your system.

3. Select the files you want to view and click *Open*.
4. The files begin playing, in order, through your default media player.

## ZOOM

Press **ZOOM** to display the camera image in double size. Press **▲Vol**, **▼Vol**, **CH▶**, or **CH◀** to see the parts of the image not displayed on the LCD screen. Press **ZOOM** again to return to normal view.

## NIGHT LIGHT

You can control the UBR243 night light using the **NIGHT LIGHT** button on the top of the monitor or the right side of the camera. However, if you want to control it from the monitor, you must place that camera in full screen mode.

1. To turn the night light on from the monitor, place the night light camera in full screen mode.
2. Press **NIGHT LIGHT** on the side of the monitor or the camera. The camera's night light turns on and a night light icon displays on the monitor.
3. Press **NIGHT LIGHT** again to turn it off.

## LULLABIES

Your system comes with four preprogrammed lullabies. You can control the lullabies from either the monitor or the camera. However, if you want to control them from the monitor, the camera you want to play them through must be in full screen mode.

When you press **LULLABY PLAY/STOP** to turn on the lullaby feature, Lullaby #1 begins playing. It will repeat until you press **LULLABY SKIP** to move to the next lullaby.

The Lullaby feature can also play all lullabies one after the other. Press **LULLABY PLAY/STOP** to turn on the Lullaby system and begin playing Lullaby #1. Press **LULLABY SKIP** four (4) times after Lullaby #1 begins playing. Lullaby #1 restarts and then cycles through the rest of the lullabies.

1. To control the lullabies from the monitor, decide which camera you want to play lullabies and make it the full screen live view camera.
2. Press **LULLABY PLAY/STOP** on the monitor or camera. The system plays Lullaby #1 then repeats it.

3. Press **LULLABY SKIP** to skip to Lullaby #2. The system plays Lullaby #2 then repeats it.
4. Press **LULLABY SKIP** to skip to Lullaby #3. The system plays Lullaby #3 then repeats it.
5. Press **LULLABY SKIP** to skip to Lullaby #4. The system plays Lullaby #4 then repeats it.
6. Press **LULLABY SKIP** to skip to Lullaby #1. The system plays Lullaby #1 then cycles through all lullabies.
7. Press **▲Vol** and **▼Vol** on the monitor or camera to adjust the volume. Press **▼Vol** all the way down on the monitor to mute the lullaby playing through the monitor.

## USING THE INTERCOM

The Intercom feature lets you talk to whomever is within camera range.

1. Decide which camera you want to establish an intercom link with, and make it the full screen live view camera.
2. Press and hold **TALK** the monitor.
3. Speak clearly into the microphone.
4. Release **TALK** to listen to the response.

## CAMERA PAIRING

The system comes with one camera that has already been paired. It will communicate with the monitor when it is powered on.

The pairing function lets you add up to 3 additional cameras to your system. It also lets you re-pair your first camera if needed.

### ***Pair the cameras to the monitor before mounting the cameras.***

1. Verify that the monitor is powered on (see page 11).
2. Install and power on the accessory cameras according to the procedures beginning on page 9.
3. Pair the accessory cameras according to the procedures on page 31.
4. Once the camera has been paired, it will be immediately viewable on the monitor.

# MAINTAINING YOUR SYSTEM

## MONITOR

As you use your monitor, keep the screen clean by wiping it with a microfiber cloth to remove fingerprints, dust, etc.

## CAMERA

When dust and grime builds up on the camera lens and glass, it affects the camera's "vision." Use a microfiber cloth to regularly clean the cameras or when night vision video is cloudy or unclear.

# SOLVING PROBLEMS

If you have problems with the system, there is often a quick and simple solution. Please try the following:

If	Try
There is no picture from the camera	<ul style="list-style-type: none"><li>• checking all connections to the camera. Make sure the adapter is plugged in.</li><li>• making sure that the cameras and monitor are both ON.</li><li>• making sure that the camera is in range of the monitor.</li></ul>
The picture is dropping	<ul style="list-style-type: none"><li>• moving the camera closer to the monitor.</li><li>• repositioning the camera, monitor or both to improve the reception.</li><li>• adjusting the monitor and camera antennas to vertical position.</li></ul>
There are audio problems	<ul style="list-style-type: none"><li>• making sure that there is sound within range of the camera microphone.</li><li>• moving the camera or monitor farther apart if the unit emits a loud screeching noise (feedback).</li></ul>
There is an irregular beeping coming from the monitor	That is the Alert tone. Go to the Alert screen to turn the alert volume down or off (see page 27).
The picture has become choppy	The picture may become choppy when experiencing a lower frame rate. Try: <ul style="list-style-type: none"><li>• moving the camera closer to the monitor.</li><li>• removing obstructions between the monitor and camera.</li><li>• adjusting the monitor and camera antennas to vertical position.</li></ul>
The monitor picture has frozen	Use a blunt object like an unbent paper clip to press <b>RESET</b> and reset the monitor. The monitor turns off. Press <b>POWER</b> to turn it back on again.



<b>If</b>	<b>Try</b>
You can't record video (the New File icon is flashing red)	The New Record icon flashes red when the microSD card is full. Either manually delete video records (see page 35), enable Overwrite (see page 30), or reformat the microSD card to delete all records (see page 24).

# SPECIFICATIONS

## GENERAL

	Camera	Monitor
Operating Frequency Range	2.400 ~ 2.4835GHz	
TX Power	15dBm	NA
RX Sensitivity	NA	-81dBm
Type of Spread Spectrum Used	FHSS	
Type of Modulation Used	GFSK	
Communication Range	500ft. Line of Sight	

## CAMERA

Image Sensor Type

Manufacturer/ Model # 1/6.5" Color CMOS Image sensor

Effective Pixel	640 x 480
Image Processing	MJPEG
Lens	3.0mm / F2.8
Exposure	Auto
White Balance	Auto
Power Requirement	5.0VDC +/-5%
Power Consumption	150mA Max (IR OFF) 730mA Max (IR ON) 440mA Max (Charging)
Operating Temperature Range	14° F ~ 104° F ( -10° C ~ 40° C )
Operating Humidity Range	Within 80% RH
RoHS Compliance	Yes
Housing Material	Plastic

## MONITOR

Display Size/Type	4.3" TFT LCD
Resolution	480 x 272
Power Requirement	5.0VDC +/-5%
Power Consumption	350mA Max (Normal) 900mA Max (Charging)
Operating Temperature Range	14° F ~ 104° F ( -10° C ~ 40° C )
Operating Humidity Range	Within 85% RH
RoHS Compliance	Yes
Battery Life	4.5 hours
Housing Material	Plastic

# APPENDIX A: HOW TO SET UP YOUR UBR243 FOR REMOTE VIEWING VIA SKYPE™

## REQUIREMENTS

- Two Skype™ accounts
- A PC computer
- A second computer OR separate Skype™-ready device (i.e. Android or iPhone/tablet)
- Uniden Model UBR243, Wireless Video Surveillance Camera

## PROCEDURES

1. Follow the owner's manual instructions for viewing video on your computer (see page 34). Insert the CD included in your package into your PC. Select the USB Driver file and double-click to run the program.



- Follow the instructions from the InstallShield Wizard. Select *Finish*, completing the installation.

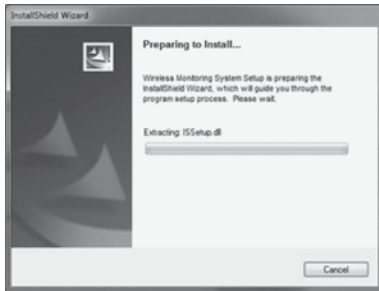

- Connect your home computer to the monitor with the USB cable (included). The monitor screen goes blank. Your UBR243 system is now connected to your PC.
- Setup a NEW Skype™ account specifically for your UBR243. DO NOT USE AN EXISTING ACCOUNT. A second personal Skype account is required to view camera video. (Simplified instructions can be found on page 36 of the owner's manual).  
Go to [www.skype.com](http://www.skype.com) and click on **Join Us** in the top right corner.

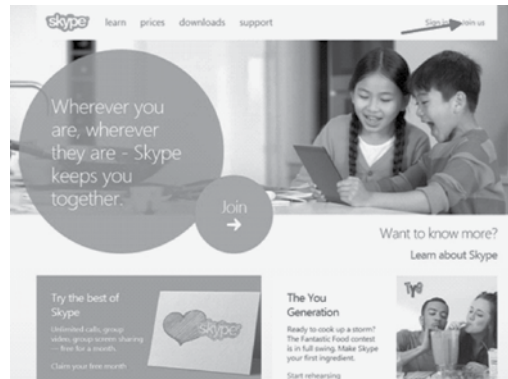

Fill out the profile information requested by Skype™ and click *I agree – Continue* at the bottom of the page. *Skype Name* is the name you create for your UBR243 system.

Choose your phone number or use any other:

Select

Skype Name\*

Note: only choose a name you have a right to use.

Password\*

Repeat password\*

Between 6-20 characters, include Latin letters and numbers. Note: no-one else can see your password.

Inform me about new products, features, and special offers. When you sign up for SMS notifications, our first SMS will allow you to get Skype on your mobile (where applicable, your operator may charge you for receiving SMS messages).

By SMS

By email

iron anisato

Can't read the text in the box?

Refresh Listen Help

Type the text above here\*

Yes, I have read and I accept the [Skype Terms of Use](#) and the [Skype Privacy Statement](#)

I agree - Continue

***If you have a Windows 8 machines, you must download Skype for Windows desktop. The native Skype app is not compatible.***

**Select** Download a different version **and then select** Skype for Windows desktop.

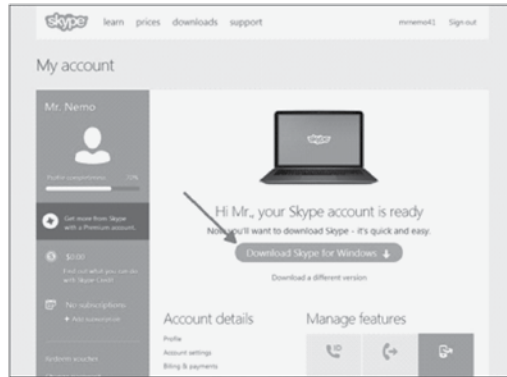

Install Skype™ using the Install Wizard.

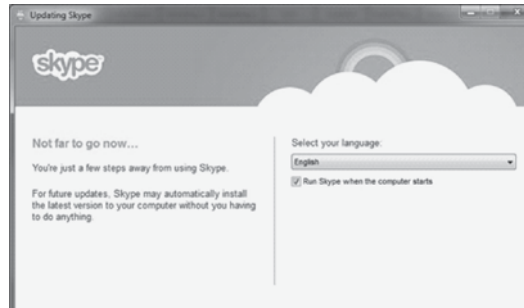

Once installed and logged in, Skype™ should have setup the camera automatically (as long as the camera was still plugged into your computer as mentioned in Step 3 on page 45). If your computer already has a web cam setup or you don't see video from your UBR243, you will have to go into *Tools/Options/Video settings* to select the correct camera.

Click the *Tools* menu and select *Options*.

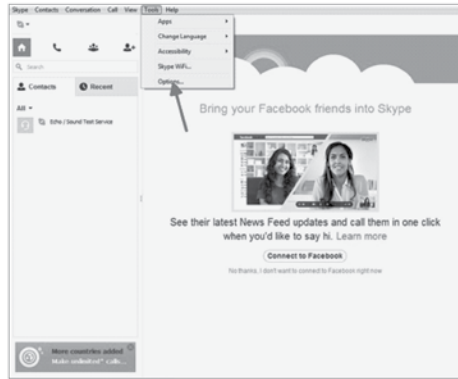

Select *Video settings* and then select *Wireless Monitoring System* in the **Select webcam** dropdown box.

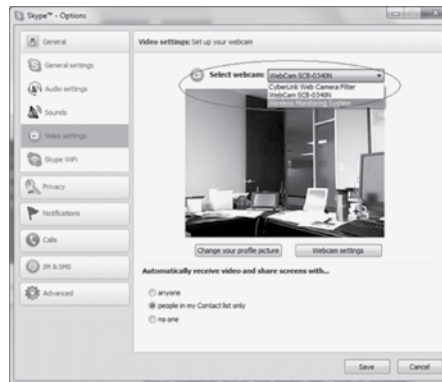



Next, you will need to set Skype™ to answer automatically under certain circumstances. In the *Call settings* screen, select **Answer incoming calls automatically** and **Start my video automatically when I am in a call** options.

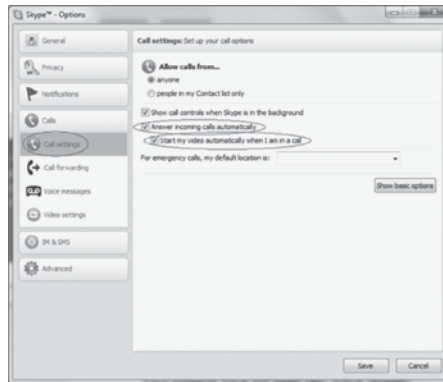

5. Invite your second Skype™ account into your contacts by clicking the **Add Contact** button.

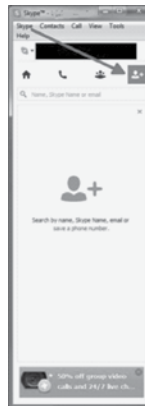

6. On another device, log into the second Skype™ account and accept the invitation.

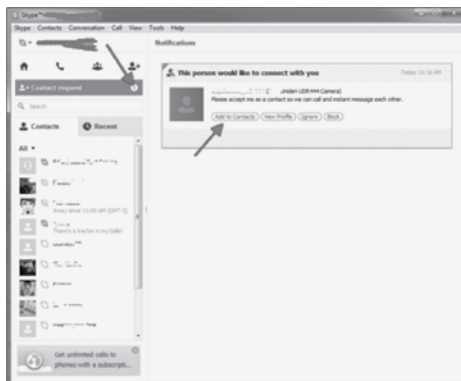

7. If you do not have a second Skype™ account, you will have to create one by following the previous instructions in this Appendix (beginning on page 45).
8. From your second Skype™ account on a different device, call your first Skype™ account that you just added to your contacts list.

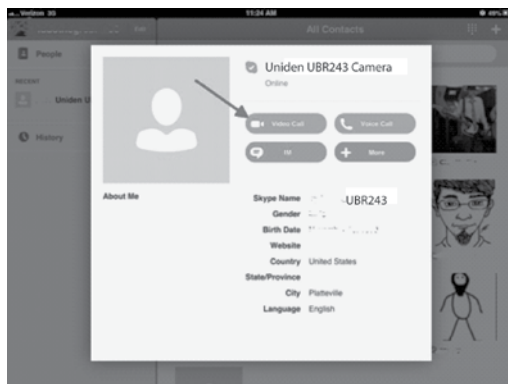

# FCC Notices

## FCC Compliance Information

### *Part 15 Compliance Statement*

This device complies with Part 15 of the FCC Rules. Operation is subjected to the following two conditions: (1) this device may not cause harmful interference, and (2) this device must accept any interference received, including interference that may cause undesired operation. Privacy of communication may not be ensured when using this device.

This equipment has been tested and found to comply with limits for a Class B digital device, pursuant to Part 15 of the FCC rules and ETSI (EN) 300328. These limits are designed to provide reasonable protection against harmful interference in residential installations. This equipment generates, uses, and can radiate radio frequency energy, and if not installed and used in accordance with the instructions, may cause harmful interference to radio communications.

However, there is no guarantee that interference will not occur in a particular installation. If this equipment does cause interference to radio or television equipment reception, which can be determined by turning the equipment off and on, the user is encouraged to try to correct the interference by one or more of the following measures:

- Reorient or relocate the receiving antenna.
- Move the equipment away from the monitor.
- Plug the equipment into an outlet on a circuit different from that to which the monitor is connected.
- Consult the dealer or an experienced radio/television technician for additional suggestions.

**CAUTION! Any changes or modifications to this equipment not expressly approved by the party responsible for compliance could void your authority to operate the equipment.**

## RF Exposure Information

The antenna used for this transmitter must be installed to provide a separation distance of at least 20 cm (7.9") from all persons and must not be collocated or operating in conjunction with any other antenna or transmitter.

## IC Compliance Information

### Radio Equipment Notice

The term "IC:" before the radio certification number only signifies that Industry Canada technical specifications were met. Operation is subject to the following two conditions: (1) this device may not cause interference, and (2) this device must accept any interference, including interference that may cause undesired operation of the device. Privacy of communications may not be ensured when using this device..

## THREE-YEAR LIMITED WARRANTY

**Important: Evidence of original purchase is required for warranty service.**

WARRANTOR: UNIDEN AMERICA CORPORATION ("Uniden") ELEMENTS OF WARRANTY: Uniden warrants, for three years, to the original retail owner, this Uniden Product to be free from defects in materials & craftsmanship with only the limitations or exclusions set out below.

**WARRANTY DURATION:** This warranty to the original user shall terminate & be of no further effect 36 months after the date of original retail sale. The warranty is invalid if the Product is (A) damaged or not maintained as reasonable or necessary, (B) modified, altered, or used as part of any conversion kits, subassemblies, or any configurations not sold by Uniden, (C) improperly installed, (D) serviced or repaired by someone other than an authorized Uniden service center for a defect or malfunction covered by this warranty, (E) used in any conjunction with equipment or parts or as part of any system not manufactured by Uniden, or (F) installed or programmed by anyone other than as detailed by the owner's manual for this product.

**STATEMENT OF REMEDY:** In the event that the product does not conform to this warranty at any time while this warranty is in effect, warrantor will either, at its option, repair or replace the defective unit & return it to you without charge for parts, service, or any other cost (except shipping & handling) incurred by warrantor or its representatives in connection with the performance of this warranty. Warrantor, at its option, may replace the unit with a new or refurbished unit.

**THE LIMITED WARRANTY SET FORTH ABOVE IS THE SOLE & ENTIRE WARRANTY PERTAINING TO THE PRODUCT & IS IN LIEU OF & EXCLUDES ALL OTHER WARRANTIES OF ANY NATURE WHATSOEVER, WHETHER EXPRESS, IMPLIED OR ARISING BY OPERATION OF LAW, INCLUDING, BUT NOT LIMITED TO ANY IMPLIED WARRANTIES OF MERCHANTABILITY OR FITNESS FOR A PARTICULAR PURPOSE. THIS WARRANTY DOES NOT COVER OR PROVIDE FOR THE REIMBURSEMENT OR PAYMENT OF INCIDENTAL OR CONSEQUENTIAL DAMAGES.** Some states do not allow this exclusion or limitation of incidental or consequential damages so the above limitation or exclusion may not apply to you.

**LEGAL REMEDIES:** This warranty gives you specific legal rights, & you may also have other rights which vary from state to state. This warranty is void outside the United States of America & Canada.

**PROCEDURE FOR OBTAINING PERFORMANCE OF WARRANTY:** If, after following the instructions in the owner's manual you are certain that the Product is defective, pack the Product carefully (preferably in its original packaging). Disconnect the battery from the Product & separately secure the battery in its own separate packaging within the shipping carton. The Product should include all parts & accessories originally packaged with the Product. Include evidence of original purchase & a note describing the defect that has caused you to return it. The Product should be shipped freight prepaid, by traceable means, to warrantor at:

Uniden America Service  
743 Henrietta Creek Rd.  
Roanoke, TX 76262

(800) 297-1023, 8 a.m. to 5 p.m., Central, Monday through Friday

## Free Manuals Download Website

<http://myh66.com>

<http://usermanuals.us>

<http://www.somanuals.com>

<http://www.4manuals.cc>

<http://www.manual-lib.com>

<http://www.404manual.com>

<http://www.luxmanual.com>

<http://aubethermostatmanual.com>

Golf course search by state

<http://golfingnear.com>

Email search by domain

<http://emailbydomain.com>

Auto manuals search

<http://auto.somanuals.com>

TV manuals search

<http://tv.somanuals.com>