

Start
Here!



Quick Start Guide - next page



DSS
2155/
2165

Digital Spread Spectrum
provides the longest range,
the clearest sound
and the best privacy.

QUICK START
GUIDE

Uniden

INSTALLATION & SAFETY



This symbol indicates important operating and servicing instructions.

Choosing the best location for your DSS2155/DSS2165

When choosing a location for your phone there are a number of appliances the phone should not be near, and areas you should avoid.

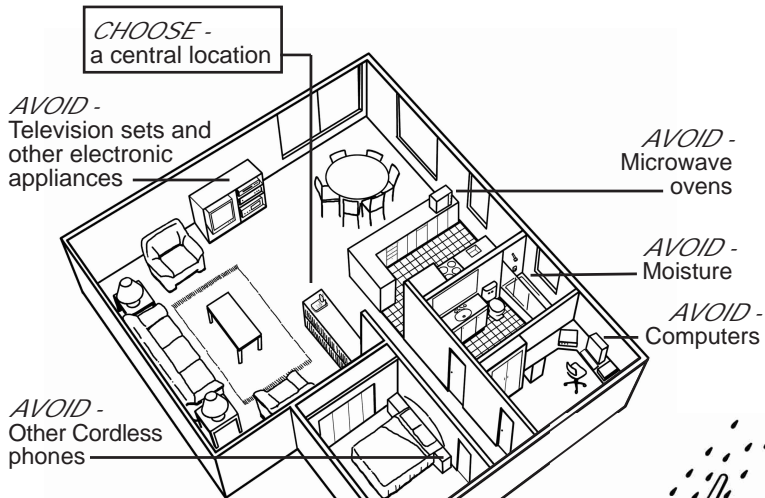

CHARGE -
the new phone
for 14 - 20 hrs
and raise the
antenna before
making a call.



AVOID -
moisture



DON'T -
overload the
power outlet.

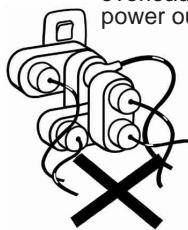

AVOID -
multi
power boards

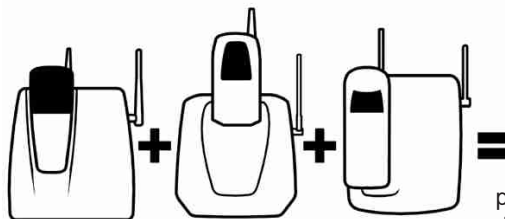

AVOID -
connecting
more than

3
phones as Ringing
may be impaired.

PRECAUTIONS

This page is a very condensed version of the Owners Manual. It is designed to allow you to get your phone installed and operating as quickly as possible - however it does not attempt to explain any of the advanced features of the DSS2155/DSS2165

Start Here!

1 2 3

Quick Start Guide

1

Installing the Base Unit (DSS2155/DSS2165)

- Plug the telephone cord into the Base Unit, then into the telephone socket on the wall.
- Plug the AC Adaptor cord into the Base Unit, then plug the AC Adaptor into the wall power point.
- Press the AC Adaptor cord into the curved recess under the Base Unit.
- Raise the antenna.



Make sure the AC Adaptor remains switched ON at all times.
Use only the Uniden AC Adaptor supplied with this unit.

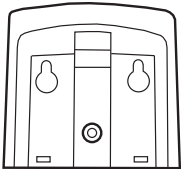
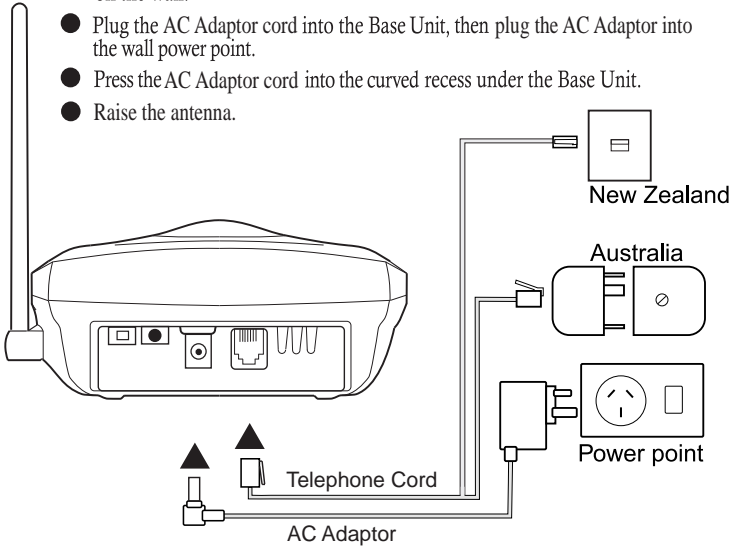

Charge Cradle (DSS2165 only)

- Plug the AC adaptor cord into the Charge Cradle, then plug the AC Adaptor into the wall power point.

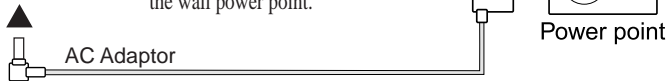

2

Installing the Batteries in the Handset/s

- Press the battery cover and slide it off.

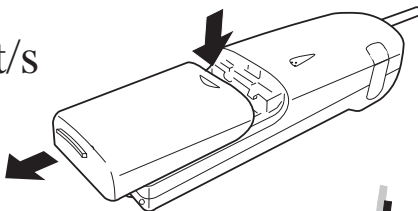

- Connect the battery plug to the socket at the rear of the battery compartment.

Make sure the plug is the right way round.

Press firmly until it clicks into place.

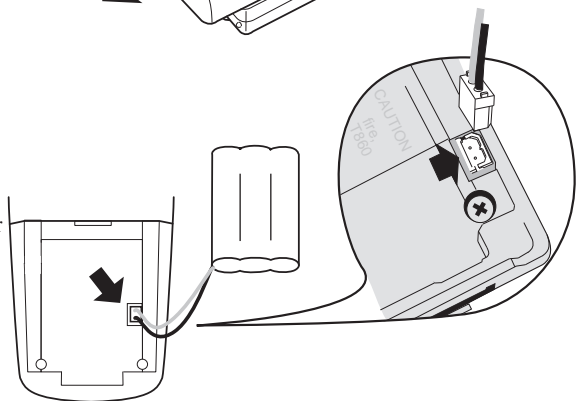

- Position the battery in the compartment and slide the cover into place.

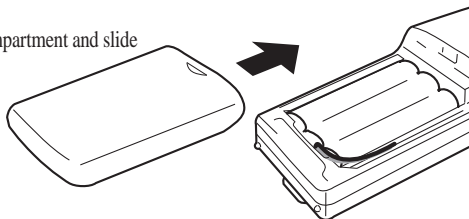

NOTE

DSS2165 only - Place the handsets on either the Base Unit or the Charge Cradle and charge them uninterrupted for 12 hours.

(iii)



3

Making a Call

- Pick up the Handset and press **talk** to low/off line
Dial the phone number
OR
Dial the phone number - then press **talk**
- **To hang up** - press **talk**
OR
Place the Handset on the base Unit.

Answering a Call

- **Handset on Base Unit:**
Remove the Handset from the base and speak (Auto Talk).
- **Handset off the Base Unit:**
Pick up the Handset, press **talk** and speak.
- **To hang up** - press **talk** again OR
place the Handset on the base unit.



4

Setting Up the Answering System

To Turn the Answering System On

- Press **ans on/off** - the pre-recorded greeting will play and your system is ready to accept calls.

To Record Your Outgoing Message.

- Press and hold **greeting**.
After you hear a short tone, release the key.
- Record your greeting while speaking within 15cm of the base.
- When finished, press **greeting** again.



Quick Start Guide

Initial Settings

- **Ring Time** - the number of rings before the Answering System answers the call
Set Ring Time to T/S (= 9 rings)
- **Record Time** - the length of time a caller may record a message
Set Record Time to 1 minute

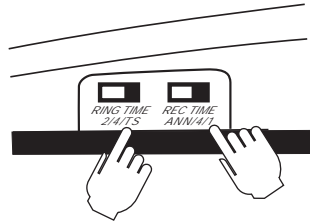

Using the Answering System

To Play Your Message

- Press  - new messages play first

To Repeat a Message



- Press  during playback of messages

To Skip a Message

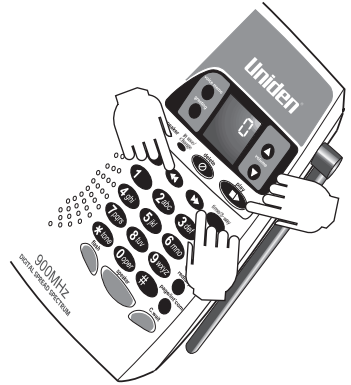
- Press  anytime during playback to skip to the next message
The system beeps and begins to play the next message.



To Delete Messages

- Delete one message:
Press  during a message.
The system beeps and begins to play the next message.
- Delete all messages:
After reviewing all messages - press and hold  more than 4 seconds. A tone sounds indicating messages have been deleted.

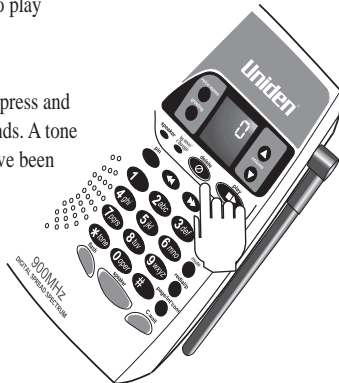

CONTENTS

OF YOUR OWNERS MANUAL

Installation & Safety	i
Quick Start Guide	
Installing the Base Unit	ii
Installing the Handset Batteries	iii
Making a Call	iv
Setting up the Answering System	iv
Using the Answering System	v
Contents	1
Controls & Functions	2-3
Welcome	4
Features	4
Setting Up your Telephone	
Accessories Included in Your Package	5
Installing the Belt Clip	5
Headset Installation	5
Battery Maintenance	6
Adjusting Ringer & Earpiece Volume	6
Using Your Phone	
Making and Receiving Calls	7
Call Transfer	8
Redialing a Call	8
Travelling Out of Range	9
Key Lock/Unlock	9
Call Waiting/Flash	9
Storing Phone Numbers & Names	10
Making Calls with Memory Dialing	11
Editing a Stored Name & Phone Number	12
Rocket Dial	12
Storing and Editing Rocket Dial	12
Making Calls with Rocket Dial	13
Erasing a Stored Name & Phone Number	13
Paging/Intercom	13
3-Way Conversation	14
Registration	15
Caller ID	16
Name Tagging	16
Viewing Caller ID Message List	17
Deleting Information from Caller ID	17
Using the Caller ID list	18
Using Your Answering System	19
Setting Up Your Answering System	19
Using Your Answering System	20
Deleting Messages	21
Setting Date and Time	22
Remote Access	23
Troubleshooting	24
Warranty	25

CONTROLS & FUNCTIONS

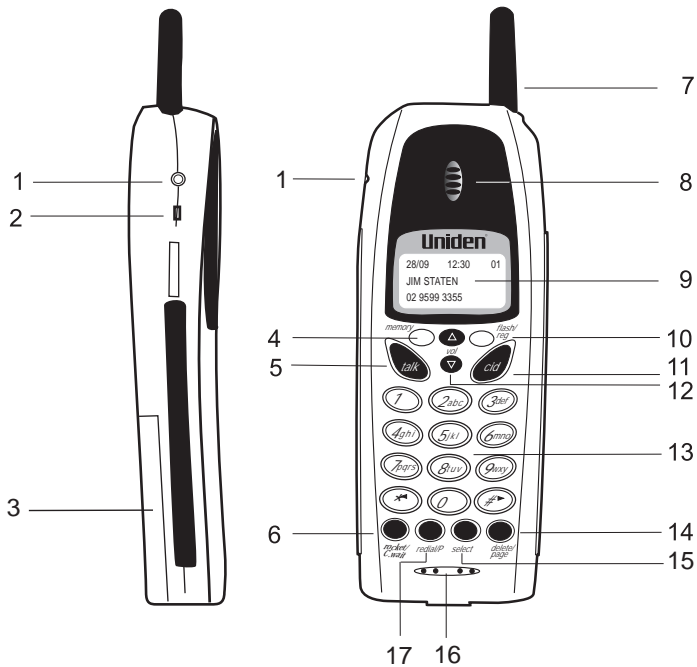

- 1 Headset jack
- 2 Belt clip slot
- 3 Battery compartment
- 4 Memory key
- 5 Talk key
- 6 Rocket/C.wait key
- 7 Handset aerial
- 8 Handset speaker
- 9 Display screen
- 10 Flash/Registration key
- 11 CID key
- 12 Volume control keys
- 13 Alpha Numeric keypad
- 14 Delete/Page key
- 15 Select key
- 16 Handset Microphone
- 17 Redial/Pause key
- 18 Ring time switch
- 19 Record time switch

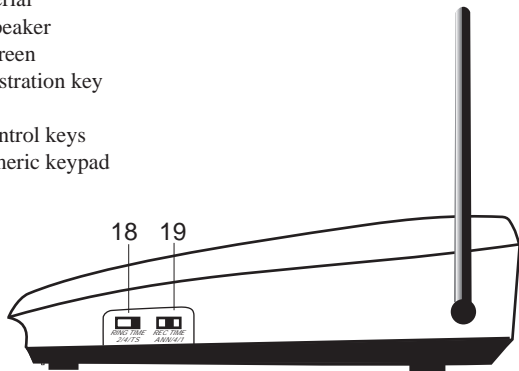

- 20 Aerial
- 21 Telephone Line input
- 22 AC Adaptor input
- 23 Registration button
- 24 Ringer Off/On
- 25 Voice memo key
- 26 Message display
- 27 Volume control keys
- 28 Delete key
- 29 Play key
- 30 Time/3-way
- 31 Answer On/Off key
- 32 Mute
- 33 Redial/Pause key
- 34 C.wait key
- 35 Speaker key
- 36 Hands free microphone
- 37 Flash key
- 38 Speaker
- 39 Alpha numeric keypad
- 40 Repeat/Skip keys
- 41 Pin key
- 42 Speaker LED
- 43 In use/charge LED
- 44 Greeting key
- 45 Handset charge contacts
- 46 Charge Cradle AC Adaptor input (DSS2165 only)

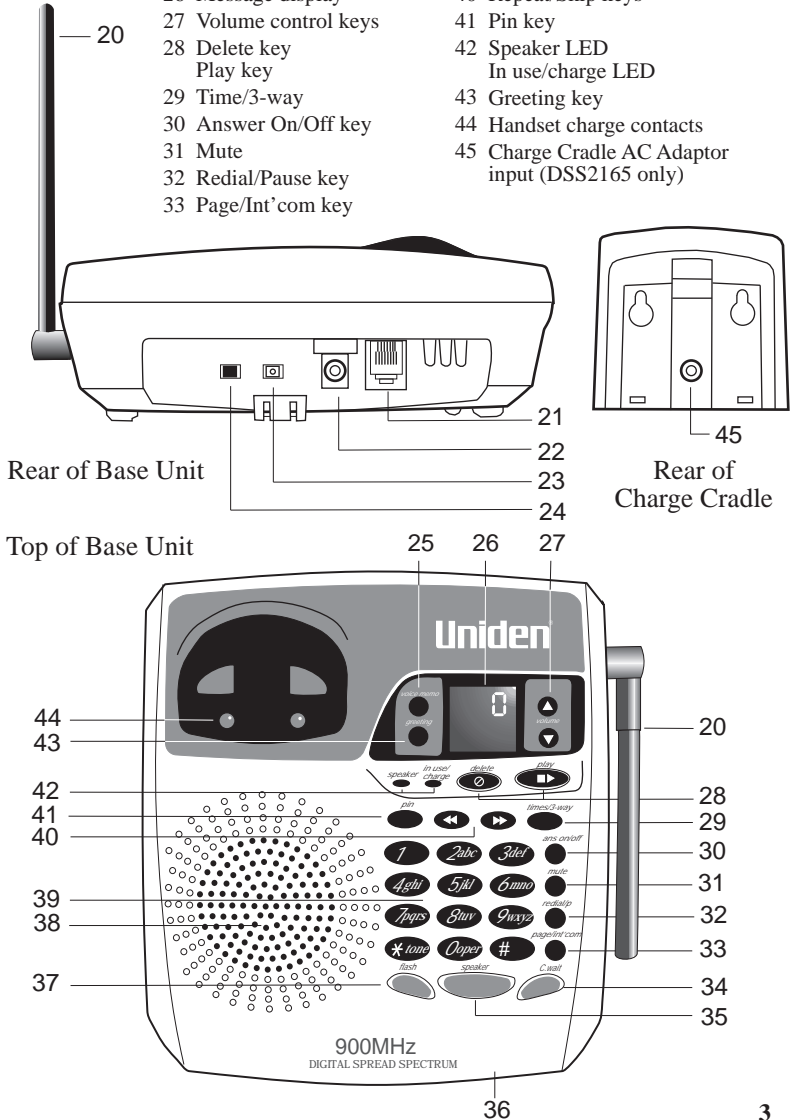

INTRODUCTION

TO YOUR NEW PHONE

WELCOME

Congratulations on your purchase of the Uniden **DSS2155/DSS2165** digital cordless telephone. This phone is designed for reliability, long life and outstanding performance utilising the latest in 900 MHz Digital Spread Spectrum Technology.

COMPANY PHILOSOPHY

To bring outstanding wireless communication products to people's lives throughout the world.

FEATURES

- 1 900MHz Digital Spread Spectrum Technology
- 1 Integrated Digital Answering Machine
- 1 Alpha display Caller ID
- 1 Multi Handset (capable of up to 7 handsets)
- 1 2 way Communication: Handset to Handset, without base
- 1 3 way Communication: Handset to Base to Outside Caller
- 1 Digital Speakerphone
- 1 Backlit LCD
- 1 Backlit Keypad on the Handset
- 1 POP ID - Caller Name Identification
- 1 60 Caller ID Memories
- 1 59 Alpha Memory Dialing
- 1 Maxi-Sound - Extra Loud Handset Volume Control
- 1 Rocket Dial - One Touch VIP Dial
- 1 One Touch Call Waiting
- 1 Handset Capable
- 1 Date and Time Stamp

Digital Spread Spectrum Technology utilises a digital transmission and a "wider frequency band" compared to a "single narrow band" 30/39 Standard Analogue transmission. The result is a more secure conversation with the clarity of digital sound, extended range and minimal interference from other cordless phones.

Random Code™ digital security automatically selects one of over 16 million codes for the Handset and base. This feature prevents unauthorised calls as a result of your phone being activated by other equipment.

ACCESSORIES INCLUDED IN YOUR PACKAGE

TIP

To get the most from your phone, please read this Owner's Manual thoroughly. Be sure to complete and mail the product consumer support card.

NOTE

If any of these items are missing or damaged, contact your place of purchase.

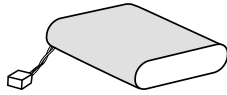

Rechargeable Battery
DSS2155 (1) DSS2165 (2)

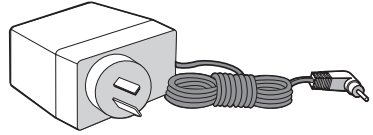

AC Adaptor
DSS2155 (1) DSS2165 (2)

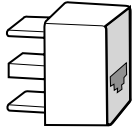

Telephone Cord Adaptor (1)
(Australia Only)



Telephone Cord (1)

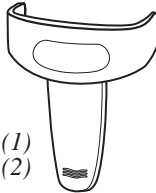

Belt Clip
*DSS2155 (1)
DSS2165 (2)*

Plus - This Owner's Manual
Consumer Support Card
and other printed materials

INSTALLING THE BELT CLIP

To attach the belt clip

- 1 Press the beltclip against the rear of the Handset until it clicks into place.

To remove the belt clip

- 1 Gently pull one side of the beltclip to release.

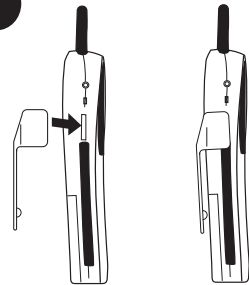

HEADSET INSTALLATION

Your phone may be used with an optional headset.

To use this feature, simply plug the headset into the headset jack.

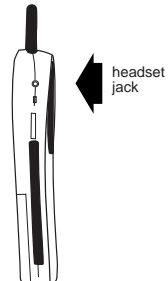

If you are using an optional headset, you must still use the handset keypad for phone operations.

BATTERY MAINTENANCE

NOTE

Use only the genuine Uniden Battery supplied with your phone. Replacement batteries are also available through the Uniden Parts Department.

NOTE

The built-in memory backup can hold numbers and names stored in the memory even if the battery pack is completely discharged.

Battery use time (per charge)

From fully charged -

- 7.5 hours continuous use.
- 4 days when the Handset is in the standby mode.
- A full charge will take at least 12 hours if Low Battery is displayed - however the phone will be ready for a short call after one hour.

When the battery charge becomes low

If the phone is not in use, Low Battery flashes and the keys will not operate. If the phone is in use, Low Battery flashes and the Handset beeps. Complete your conversation as quickly as possible and return the Handset to the base unit for charging.

Low Battery

- You cannot over charge the battery.
- You may return the handset to the charger after each call or when the battery is low.

Genuine handset batteries

The high quality rechargeable batteries supplied with your phone perform for up to two years or more. In order to enjoy the best performance from your phone, we recommend you replace your batteries every two years with a genuine Uniden Battery. Simply order a replacement battery from:

Uniden Australia PTY Limited

Service Division
Ph: 1300 366 895
www.uniden.com.au

Uniden New Zealand Limited

Service Division
Ph: 0800 4 UNIDEN (0800 4 864 336)
www.uniden.co.nz

Cleaning the battery contacts





To maintain a good charge, clean the battery contacts on the handset and base unit monthly with a dry cloth or pencil eraser. **Do not use any liquids or solvents.**

ADJUSTING THE RINGER AND EARPIECE VOLUME

Ringer tone and volume



The phone has four ringer tone and volume combinations.

In the standby mode, press  or  on the Handset repeatedly. The display shows the setting.

A HIGH  A LOW  B HIGH  B LOW  OFF

RINGER A HIGH

Earpiece volume

Pressing  or  during a call will change the earpiece volume of the Handset. The telephone will keep this setting for all calls and display the setting for each call.



LOUD  HIGH  MID  LOW

TALK LOUD 1

Base Ringer Switch

You can turn the base ringer on or off with the base ringer switch.

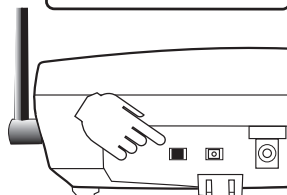

Base Speaker Volume

To control the speaker volume of the base, press  or  as desired.



MAKING AND RECEIVING CALLS

Basic phone operation

	When Handset On Base	When Handset Off Base	Using the Base
			
To answer a call (phone ringing)	<ol style="list-style-type: none"> INCOMING CALL Pick up Handset. TALK LOUD 1 <p>Auto talk answers the call as soon as the Handset is picked up.</p>	<ol style="list-style-type: none"> INCOMING CALL Press talk. TALK LOUD 1 	<ol style="list-style-type: none"> Press speaker. Speak into the Base.
To make a call	<ol style="list-style-type: none"> Pick up handset. Enter the phone number. <p>9599 3355 (example)</p> <ol style="list-style-type: none"> Press talk. TALK LOUD 1 9599 3355 	<ol style="list-style-type: none"> Pick up Handset Enter the phone number. <p>9599 3355 (example)</p> <ol style="list-style-type: none"> Press talk. TALK LOUD 1 9599 3355 	<ol style="list-style-type: none"> Press speaker. Enter the phone number.
To hang up	<p>Return the Handset to the base (Auto Standby) or Press talk on the Handset.</p>	<p>Return the Handset to the base (Auto Standby) or Press talk on the Handset.</p>	<p>Press speaker.</p>

CALL TRANSFER

NOTE

If the called handset is not answered within 20 seconds, the call will return to the original Handset.

NOTE

If the base is not answered within 30 seconds the call will return to the original Handset.

NOTE

If any button is pressed before pressing **redial/p**, the last number dialed will not redial.

NOTE

Calls can only be redialed from the Handset they were originally called from.

During a call, you can transfer the call to another optional handset
(maximum 7 handsets).

1. Press **delete/page**.
2. Press [handset No. (1-7)].
The Handset number is shown on the right side of the display.
3. Press **talk**.
4. Called second Handset rings.
5. Press **talk** on the second Handset and Call Transfer is completed.

TRANSFER TO
HAND

TRANSFER TO
HAND 1

To transfer from handset to base unit.

1. Press **delete/page** → 0 → **talk**
2. The caller is put on hold and the base rings.
3. Press the **speaker** key on the base and Call Transfer is completed.

TALK MID 1

-

To transfer from base unit to handset.

When the phone is in Speaker Phone mode, you can transfer the call to the Handset.

1. Press **page/int'** → handset No. (1-7)
→ **speaker**.
2. The called Handset rings.
3. Press the **talk** key on the called Handset and the transfer is completed.

INCOMING CALL

-

TALK MID 1

-

REDIALLING A CALL

The last three phone numbers dialed can be quickly redialed.

Redial from standby

1. Press **redial/p**.
The most recent phone number that was dialed will be displayed on the screen.
2. Press **redial/p** again and the 2nd most recent number dialed will be displayed.
3. Press **redial/p** again and the 3rd most recent number dialed will be displayed.
4. Press **redial/p** again to return to standby.

Example: Press **redial/p**

REDIAL 1
95993355

Most recent number dialed is displayed.



Press **redial/p** again

REDIAL 2
95979012

2nd 'most recent number dialed' is displayed.



Only the last number dialed can be accessed after talk has been pressed.



Only numbers dialed from the Base Unit keypad will be redialed from the Base redial key.

Press **redial/p** again



3rd 'most recent number dialed' is displayed.

4. Press **talk** and the number will be dialed.



Redial from talk mode

1. Press **talk**.
2. Press **redial/p** - the last number dialed will be displayed and redialed.

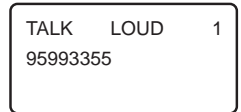

Redial from the Base Unit

1. To call the last number dialed from the Base Unit, press **speaker**.
2. Press **redial/p** - the last number dialed will be redialed.
3. To hang up, press **speaker**.

TRAVELLING OUT OF RANGE

During a call, noise will increase if you move your handset too far from your base unit. If the range limit of your base unit is exceeded, your call will terminate within 10 seconds.

KEY LOCK / UNLOCK

When the handset is in the standby mode, press and hold **flash/reg** for 5 seconds, a beep confirms and the screen displays KEY LOCKED.

During the 'Key Locked' condition, the buttons will only operate on an incoming call. To unlock the keys, press and hold **flash/reg** for 5 seconds again.

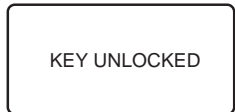
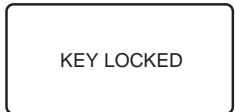

CALL WAITING/FLASH

If the Call Waiting tone sounds during a call -

Australia: Press **rocket/c.wait** or **flash/reg**, then **2** to switch between callers.

New Zealand: Press **flash/reg** to switch between callers.

STORING PHONE NUMBERS AND NAMES



Numbers stored in one handset cannot be accessed from additional handsets.



When storing a number, always include your area code (eg: 02), so name tagging will operate. (refer page 16)



The pause feature is useful for long distance calling, credit card dialing, or sequences that require a pause between digits.

With the Handset

Memory Dialing allows you to dial a number using just a few key strokes. You can store up to 59 phone numbers in the memory.

Since each step must be completed within 10 seconds, it may be advisable to review these instructions before starting.

1. Press and hold **memory** until MEMORY STORE is displayed.
2. Press **▲** or **▼** to select the memory location where you would like to store the number.
3. Press **select** - STORE NAME is displayed. If this screen appears, the selected memory location has a number already stored.
4. Use alpha numeric keys to enter the name. The name cannot exceed 16 characters. Use **# ▶** and *** ◀** to move the cursor to the next letter - or to create a space. Use **delete/page** to delete characters as needed.
5. Press **select** - STORE NUMBER is displayed.
6. Use the number keypad to enter the phone number. It cannot exceed 24 digits. Use **redial/p** to enter a pause. The screen displays P. Each pause counts as one digit and represents one and half second delay in time between digits. Use **delete/page** to delete digits as needed.
7. Press **select** - the Handset beeps and displays the confirmation screen.
8. Press **memory** to return to standby mode or select another location to programme.

MEMORY STORE

01 ► EMPTY

02 EMPTY

STORE NAME 01

STORE NUMBER 01

STORE NUMBER 01
0295993355

MEMORY 01 STORE

MEMORY STORE

01 ► FRED

02 JOHN SMITH

MAKING CALLS WITH MEMORY DIALLING



Numbers stored in one handset cannot be accessed from additional handsets.



When the stored phone number has 14 or more digits, + is displayed next to the 12th digit. Press **#** to see the extra digits and ***<** to return.

Memory Dialling from Standby

1. Press **memory** once, the handset displays your programmed memory locations.
2. Press **▲** and **▼** or enter a two-digit number (**01**-**59**) to select the memory location you would like to dial.
3. Press **talk** - the displayed number is dialed.

```
01▶FRED
02 JOHN SMITH
03 KAY JONES
```

```
TALK LOUD 1
0295993355
```

Display a Memory Number or Name

Use **#>** and ***<** to toggle between the names display and the numbers display.

Program name

```
01 FRED
02▶JOHN SMITH
03 KAY JONES
```

Program number

```
01▶0295993355
02 0295738645
03 0205477631
```

Memory dialling from talk mode

1. Press **talk**.
2. Press **memory**.
3. Enter a two-digit number (**01**-**59**) to select the memory location of the desired phone number. The selected phone number is displayed. Then the number is dialed.

```
TALK LOUD 1
-
```

```
TALK LOUD 1
00182326634488-
```

Chain Dialing

On certain occasions after dialing a number, you may be requested to enter an access code, such as your account number for phone banking. You can enter this number into a memory location for later use by doing the following:

1. Store the access code into one of the memory locations (**01**-**59**) following the steps **STORING PHONE NUMBERS AND NAMES**.
2. Dial the party or service main number.
3. When you need to enter the special number, press **memory** followed by the two digit memory location (**01**-**59**).

EDITING A STORED NAME AND PHONE NUMBER

1. Press and hold **memory** until MEMORY STORE is displayed.
2. Press **▲** and **▼** or enter a two-digit number **(0) (1) - (5) (9)** to select the memory location you would like to edit.
3. Press **select** - the screen displays the memory location number you have selected.
4. Press **▲** or **▼** to select 'Edit Memory', then press **select**.
5. Press ***◀**, **#▶**, or **delete** **⊘** to edit the name.
To edit only the phone number, skip this step.
6. Press **select** - STORE NUMBER is displayed.
7. Use ***◀** **#▶** and the number keypad to edit the phone number. The phone number cannot exceed 24 digits. If you don't want to change the phone number, skip this step.
8. Press **select** - the Handset beeps and displays the confirmation screen.
9. Press **memory** to return to standby mode or select another memory location to edit.

MEMORY STORE
01▶ FRED
02 JOHN SMITH

▶ EDIT MEMORY 01
DELETE MEMORY 01
GO BACK

STORE NAME 01
FRED

STORE NUMBER 01
0295993355

MEMORY 01 STORED

MEMORY STORED
01▶ FRED
02 JOHN SMITH



NOTE

Memory location for the Rocket Dial is independent from memory location for Memory Dial.



NOTE

You cannot store a name to the Rocket Dial location.

ROCKET DIAL

You can share your most frequently dialed number in the Rocket Dial location on each Handset. The Rocket Dial allows you to dial a number with one key press (there is no need to press **talk**). The phone will automatically dial the number stored.

STORING AND EDITING THE ROCKET DIAL

1. When the phone is in standby mode, press and hold **rocket** until a short beep is sounded.
2. Use the number keypad to enter the Rocket Dial number. It cannot exceed 24 digits.
3. Press **rocket** to save.



If the Rocket Dial does not have a stored number, the Handset will beep rapidly and the phone will not dial.



Press and hold **rocket** until a short beep, press **rocket** again for delete Stored Number.



When an incoming call is received during paging from the Base, paging is cancelled and the telephone is switched to the incoming call.
Handset to Handset paging is not cancelled.

MAKING CALLS WITH ROCKET DIAL

When the phone is in the standby mode, simply press **rocket**. The number stored in the Rocket Dial memory location is instantly dialed.

ERASING A STORED NAME AND PHONE NUMBER

1. Press and hold **memory** until MEMORY STORE is displayed.
2. Press **▲** and **▼** or enter a two-digit number (01-59) to select the memory location you would like to edit.
3. Press **select** - the memory location number that you have selected in the display
4. Press **▲** to move the pointer down to DELETE MEMORY.
5. Press **select** - the confirmation screen is displayed.
6. Press **▲** to move the pointer to YES.
7. Press **select** - MEMORY DELETED is displayed.
8. After a few seconds the display returns to the MEMORY STORE screen. You may select another number to delete (return to step 2) or press **memory** to return to standby.

```

MEMORY STORE
01 FRED
02▶ JOHN SMITH
  
```

```

▶EDIT MEMORY 02
DELETE MEMORY 02
GO BACK
  
```

```

EDIT MEMORY 02
▶DELETE MEMORY 02
GO BACK
  
```

```

DELETE MEMORY ?
▶YES
NO
  
```

```

MEMORY 02
DELETED
  
```

```

MEMORY STORE
02▶EMPTY
03 KAY JONES
  
```

PAGING/INTERCOM

Pressing the **page** button will help to locate a Handset's whereabouts.

Paging from base unit to the Handset

1. Press **page/int'** on the base.
2. The Handset beeps for 60 seconds.
3. Press the **delete/page** button on the Handset to end the page.

DSS2165 - Both Handsets will beep when **paged**. You can end the page by pressing **delete/page** on either Handset

```

PAGING
  
```

```

PAGING BASE
  
```



NOTE

If additional Handsets have been registered to the base, all Handsets will beep when paged.



NOTE

Pressing **talk** on the Handset will leave a 2-way conversation between the Handset and the outside caller.

Pressing **time/3-way** on the Base Unit will leave a 3-way conversation between the Handset and Base Unit and the outside caller.

When you are using the Speaker Phone on the Base Unit, you can not make a 3-way conversation.

From handset to Base Unit

1. Press **delete/page** ⇨ **0** on the Handset (If there is no answer, press **delete/page** again to disconnect).
2. At the Base Unit, press **page/int'** to answer. Speak into the Base Unit microphone.
3. To turn off the intercom, press **page/int'** on the Base Unit or **delete/page** on the Handset.

INTERCOM

From Handset to an optional Handset

1. Press **delete/page** ⇨ [handset No. (1-7)] on the Handset.
2. The paged Handset beeps for 20 seconds.
3. Press **delete/page** key on the paged Handset to talk to each other.
4. To end the intercom, press **delete/page** again.
5. Both Handsets go to standby.

2 way radio feature (using an optional handset)

2 way communications between the Handsets using the intercom feature, can be achieved **without the base** anywhere, anytime.

3 WAY CONVERSATION

Between one Handset, the Base Unit and an outside caller; you are able to have a 3 way conversation.

To make a call:

1. While talking on the handset to an outside caller, press **time/3-way** on the Base Unit.
2. 3-way conversation is activated.

To hang up:

1. Press **talk** on the Handset.
2. Press **time/3-way** on the Base Unit.

REGISTRATION

NOTE

If a Handset is registered at any time as Handset 1, all other Handsets will need to be registered again from Step 1.

TIP

If you have additional Handsets, repeat the same process, but at Step 2 select a number from 3 - 7 to register the next handset.

TIP

The Registration process needs to be completed within 15 seconds, 5 beep tones will indicate that the time has been exceeded. Please start the process again.

TIP

After Registration the Handset number is shown on the Display screen either during a call or while the Handset is charging (Fig 4).

The Handset/s supplied with your DSS2155/DSS2165 have already been registered. For additional Handsets it is very important to allocate each Handset a different number to enable functions such as Call Transfer.

Registration Process

Follow this process for each additional Handset (DSS2105) that needs to be registered to the Main Base or for registering your Main Handset.

1. Remove the Handset from its charger
2. Press flash/reg on the Handset (Fig 1).
3. For Handset DSS2155 - Press the number 2 (Fig.2) to register as Handset 2 (Handset numbers 2-7 are available).

For Handset DSS2165 - Press the number 3 to register Handset 3 (Handset numbers 3-7 are available).

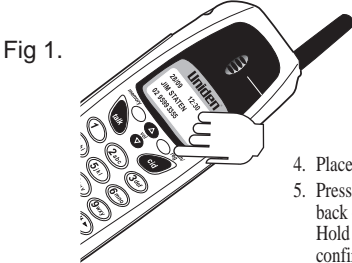

Fig 1.

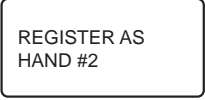

Fig 2.

4. Place the handset in the Main Base Unit (Fig 3).
5. Press and hold the Registration button located on the back of the Main Base unit near the DC power jack (Fig 3). Hold the Registration button in until a long beep confirms the handset has been registered.

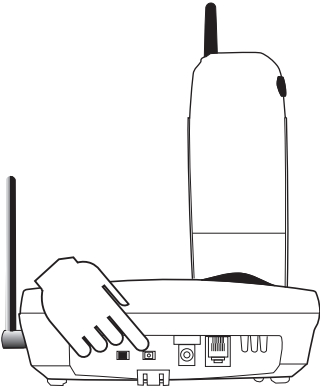

Fig 3.

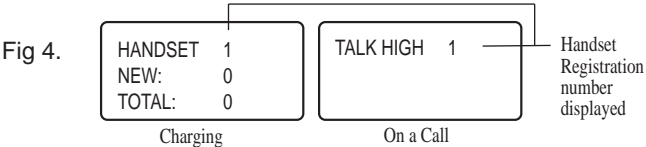

Fig 4.

CALLER ID



Caller ID information may not be displayed immediately.

You must subscribe to the Caller ID service from your local telephone company to use these features.

When the telephone rings, the Caller ID feature allows you to view the caller's name and phone number on the display before you answer the phone. The handset displays the phone number of the incoming call, the name, time and the number of calls. Additionally, you can dial the displayed number and store the information for memory dialing.

When the Telephone Rings

When the Caller ID message is received, the display shows the caller's phone number along with the date and time.

The incoming call information is stored in the Caller ID record. If the Caller ID service included the caller's name, the caller's name appears on the display (up to 15 letters).

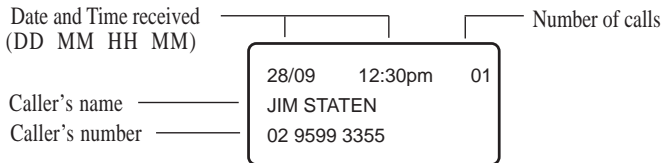

Some typical Displays:

When the phone number, name and date are received

28/09	12:30pm	01
FRED		
02 9599 3355		

When invalid data is received

INCOMING CALL		
---------------	--	--

When a private number is received

28/09	12:30pm	01
PRIVATE		

When an unknown number is received

28/09	12:30pm	01
UNAVAILABLE		

When a call is coming from overseas (New Zealand only)

28/09	12:30pm	01
OVERSEAS CALL		
0000		

When a call is coming from a payphone (Australia only)

28/09	12:30pm	01
PAYPHONE		
UNAVAILABLE		



Private numbers will not be recorded in the Caller ID List.

Name Tagging

If the displayed Caller ID telephone number is **exactly** the same as a number stored in memory, then the stored name will also be displayed with the incoming Caller ID telephone number. Overseas calls cannot be Name Tagged.



Caller ID information will need to be deleted from each handset separately.

Viewing the Caller ID Message List

The Caller ID list stores information for up to 60 incoming calls—even unanswered calls.

1. Press **(cid)** - the summary screen is displayed. The screen shows the number of new messages and total messages.
2. Press **(v)** to display the latest Caller ID message.
3. Press **(v)** to see the next message, or press **(u)** to see the previous message.
4. Press **(cid)** again to return to standby.

HANSET 1
NEW: 1
TOTAL: 3

5/11 12:30 pm
FRED
02 9599 3355

Deleting Information from the Caller ID List

The DSS2155/DSS2165 stores up to 60 messages. If the phone receives the 61st message, the oldest one in the list is automatically deleted. Caller ID data can also be deleted manually.

Deleting a Caller ID message

1. Press **(cid)** - display the message to be deleted from the Caller ID list by pressing **(u)** or **(v)**.
2. Press **(delete/page)**.
3. Press **(u)** or **(v)** to indicate “Yes” or “No”.
4. Press **(select)**.

5/11 12:30 pm
FRED
02 9599 3355

DELETE MESSAGE?
YES
▶ NO

When you indicate ‘Yes’ -

a tone sounds and the Caller ID message is deleted. The screen displays the next Caller ID message.

When you indicate ‘No’ -

a tone sounds and the display returns to the Caller ID screen.

Deleting all Caller ID names/numbers

1. Press **(cid)**.
2. Press **(delete/page)**.
3. Press **(u)** or **(v)** to indicate ‘Yes’ or ‘No’.
4. Press **(select)**.

NEW: 01
TOTAL: 03

DELETE ALL?
YES
▶ NO

When you indicate ‘Yes’ -

a tone sounds and all stored Caller ID messages are deleted.

When you indicate ‘No’ -

a tone sounds and the display returns to the Summary screen.

TOTAL: 00



If a message has already been stored in the selected memory number location, a confirmation screen is displayed.

Press **▲** to indicate "Yes".

Press **select** to overwrite.

Using the Caller ID List

Calling a party from the Caller ID list

You can place a call from the Caller ID list. The DSS2155/DSS2165 stores up to 60 messages.

1. Press **cid** - select the phone number that you want to dial by pressing **▲** or **▼**.
2. Press **talk** - the displayed phone number will be dialed automatically.

Storing Caller ID messages in Memory dialing

The phone number of the party on the Caller ID list can be stored in memory dialing.

1. Press **cid** - select the phone number to be stored from the Caller ID list by pressing **▲** or **▼**.
2. Press **memory**.
3. Press **▲** or **▼** or enter a two-digit number (**01**-**59**) to select the memory location.
4. Press **select** - a confirmation tone will sound. The number is stored in memory, and the screen displays the Caller ID list.
5. To add a name to the stored number refer to page 10.

5/11 12:30 pm
FRED
02 9599 3355

TALK LOUD 1
0295993355

5/11 12:30 pm
FRED
0295993355

SELECT LOCATION
01 ► FRED
02 JOHN SMITH

5/11 12:30 pm
FRED
02 9599 3355

REPLACE MEMORY
YES
► NO

ANSWER SYSTEM

You can use your answering system to leave a voice memo message for others who use the phone, or to announce a special message to callers when you're away from your phone.

Features

Digital Tapeless Recording

15 minutes of Recording Time

Selective Greeting (Outgoing Message)

Remote Message Retrieval and Room Monitor

Toll Saver

Digital Tapeless Recording allows you to quickly review, save or delete the messages. You'll never have to worry about a tape wearing out, jamming or resetting improperly.

The Integrated answering system is easy and convenient to use, but please read through all of the instructions carefully.

Setting Up Your Answering System

Turning the answering system on/off:

1. To turn the answering system on, press **ans on/off**.
The current greeting message will be played.
2. To turn the answering system off, press **ans on/off**.
"Answering System Off" is announced.

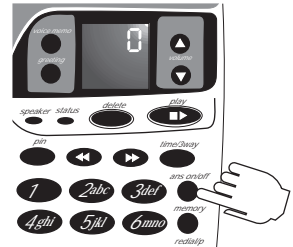

Setting your greeting:

When you receive a call, the answering system automatically plays either a preset message or your own greeting.

Preset message:

The following message is pre-recorded -

"Hello, no one is available to take your call. Please leave a message after the tone"

Recording a personal outgoing message (Greeting):

1. Press and hold **greeting** until you hear a tone.
Start recording your message immediately after you hear the tone end.
2. When you finishing recording your message, press **greeting** or **▶▶**. A tone sound and your message play back on the phone. You can record a greeting of up to 30 seconds.

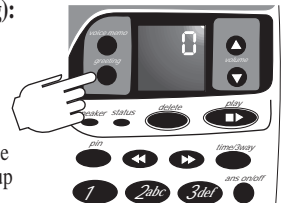

Choosing between the two outgoing messages:

1. Press **greeting** to play the outgoing message.
2. Press **greeting** again while the message is playing. This switches between the two options.

Selecting the message record time:

You can set your answering system to record a message up to one or four minutes long.

One minute option : move the **REC TIME** switch to **1**.

Four minutes option : move the **REC TIME** switch to **4**.



Announce only feature:

The announce only feature plays an outgoing message, but it will not allow the caller to leave a message. Move the **REC TIME** switch to the **ANN** position.

The message counter LED displays **A** when the system is on standby.

Pre-recorded outgoing message for Announce only feature is: "Hello, no one is available to take your call." (twice)

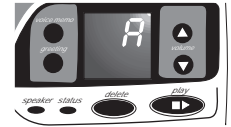

Selecting a PIN code:

To play your messages from a remote location, you will need to enter a two digit Personal Identification Number (PIN) code (00-99). To select a PIN, perform the following steps.

1. On the base, press and hold **pin** until a tone sounds and the LED displays 00.
2. To set the first number, press **◀** or **▶** repeatedly to scroll from 0 to 9. When the desired number appears in the display, press **pin**.
3. To set the second number, press **◀** or **▶** to scroll from 0 to 9. When the desired number appears in the display, press **pin**. Then the entered PIN code is announced.

Selecting Ring Time Switch:

The ring time/toll saver switch allows you to set the number of rings the caller hears before the answering system plays your outgoing message.

You can set the switch to answer after two rings or after four rings. Once the greeting has started, you can stop it when you pick up the call at the handset or base. In the **TS** (toll saver) position, the answering system picks up after 6 rings if you have new messages, and after 9 rings if there are none.

This way, if you call long distance to check your messages, you can hang up after the seventh ring to avoid billing charges.

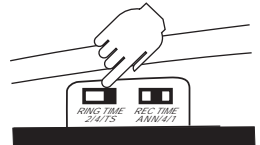



Using Your Answering System

Playing your messages



The base LED shows the number of total messages on the display. If the display is blinking, then there are new messages waiting for you. After you play your new messages you can then play old messages.

1. Press **▶**. The system announces the number of new and old messages, then the incoming messages are played.
2. When all new messages have played, a tone is heard. The message counter LED stops flashing to indicate that all of the new messages have been reviewed.
3. After you have reviewed all your messages, you can play your old messages again. Press **▶** and follow the instructions above.

Repeating a message

1. Press  to review the message. The number of stored messages is announced.
2. After a message has played for a few seconds, press  to repeat the message.
3. Press  at any time to stop reviewing messages and return to standby. The message counter LED shows the total number of messages still on the system.



Skipping a message:

1. Press  to review the message. The number messages is announced.
2. Press  at anytime to skip to the next message.
3. Press  at any time to stop reviewing your messages and return to standby. The message counter LED shows the total number of messages on the system.



Deleting Messages

Deleting individual messages:





1. Press  to review your message.
2. If you decide to delete a message, press  anytime during the message. The system beeps and immediately goes to the next message.

Deleting all messages:

Press and hold  while the system is in standby. A tone sounds when all messages are deleted. If there are any messages you have not reviewed, you cannot delete all messages at once. An error tone occurs.

Voice memo:

The voice memo function allows the user to record a message (up to 10 minutes) on the base.

1. Press and hold  until you hear a tone, the message counter LED blinks.
2. Speak into the microphone.
3. When you have finished, press  or  to stop recording. The system returns to standby.
4. To play voice memo, press .



Setting the Date and Time

1. Press **time/3-way** for 2 seconds until a confirmation beep sounds and the current day is announced.
2. Press **◀** or **▶** to select the required day.
3. Press **time/3-way** to store the selected day. The current hour is then announced.
4. Press **◀** or **▶** to select the required hour.
5. Press **time/3-way** to store the selected hour. The current minute is then announced.
6. Press **◀** or **▶** to select the required minute.
7. Press **time/3-way** to store the selected minute. The current AM/PM setting is then announced.
6. Press **◀** or **▶** to select the required AM/PM setting.
7. Press **time/3-way** to store the selected AM/PM setting.

Checking the Date and Time

Press **▶** in Standby mode. The current date and time is announced through the speaker.

Setting the Time Stamp On/Off

1. Press **time/3-way**, the current setting is displayed.
2. Press **◀** to set OFF.
3. Press **▶** to set ON.
4. Press **time/3-way** to store the selected ON/OFF setting.

Remote access away from home:

You can operate your answering system from a remote location using any touch-tone telephone. Use this function to check for recorded messages, play or delete messages, record a new outgoing message - or - monitor sounds in the room.

1. Call your telephone number.
2. While the greeting message is played, press **#** and your PIN code within 2 seconds. If the answering system is off, let it ring 10 times. When the tone sounds, press **#** and your PIN code within 2 seconds.
3. The answering system announces the number of messages stored in memory. Then the message playback automatically begins.
4. You may continue to listen to your message, or you may select a command from the following chart.

Command	Function
Press # then 1	Repeat a message
Press # then 2	Play the messages
Press # then 3	Skip a message
Press # then 4	Delete a message
Press # then 5	Stop message playback
Press # then 6	Answering system ON
Press # then 7	Voice memo record / stop (up to 4 minutes recording time)
Press # then 8	Greeting message record / stop
Press # then 9	Answer system OFF
Press # then *	Room monitor

5. After all of your messages have played, or the playback time exceeds 4 minutes, you will hear intermittent beeps indicating that the system is in the command waiting mode. You may enter another command at this time from the chart above.
6. When you finish, hang up to exit the system. The answering system automatically returns to standby.

Remote room monitor:

You can call your answering system from any touch-tone phone and monitor sound in the room where your base is installed.

1. Call your telephone number.
2. While the greeting message is played, press **#** and your PIN code. If the Answering System is off, let it ring 10 times. The tone sounds. Press **#** and your PIN code.
3. The answering system announces the number of messages stored in memory. Then the message playback automatically begins.
4. Press **#** then **5** to stop the messages.
5. Press **#** then *****. You hear sounds in the room where your phone is installed. After 15 seconds, the answering system returns to the Command Waiting mode.
6. Press **#** then ***** to monitor the room for another 15 seconds. Or select another remote function. Or hang up to exit the system. The answering system automatically returns to standby.

TROUBLE SHOOTING

If your phone is not performing to your expectations, please try these simple steps first before calling Uniden customer service -

PROBLEM	SUGGESTION
No dial tone	Check that the phone line cord connectors at both ends are pushed in until they click.
Talk flashes No dial tone	Re-register the handset - see page 15.
Does not ring	You may have exceeded the limit of the number of phones that can be connected to the same line, at the one time. Disconnect some telephones.
No power on the handset	Check the battery pack plug, inside the battery compartment of the handset, is fully pushed in. The Handset rechargeable battery pack may need to be charged. Check the AC Adaptor is plugged in at both ends and switched On.
Does not charge	Make sure the charging contacts on both the handset and the base unit are in contact during charging. The charging contacts may need to be cleaned with a dry cloth or pencil eraser. Check the AC Adaptor is plugged in at both ends and switched On.
Range is limited	Make sure the base antenna is vertical. Move the base unit so that it is centrally located in your residence or office and make sure that the base unit is not located near electrical appliances.
Calls received, flutter or fade	The Handset rechargeable battery pack may need charging. You may be out of normal operating range. Move closer to the base unit.



Please check our Website for the latest, up to date problem solving and frequently asked questions - Australia: www.uniden.com.au New Zealand: www.uniden.co.nz

WARRANTY

One Year Limited Warranty

Important: Evidence of original purchase is required for warranty service.

Warrantor: Uniden Australia Pty Limited A.B.N. 58 001 865 498
Uniden New Zealand Limited

ELEMENT OF WARRANTY: Uniden warrants to the original retail owner for the duration of this warranty, its DSS2155/DSS2165 (herein after referred to as the Product), to be free from defects in materials and craftsmanship with only the limitations or exclusions set out below. Warranty only available in the original country of sale.

WARRANTY DURATION: This warranty to the original retail owner only, shall terminate and be of no further effect 12 months after the date of original retail sale. This warranty will be deemed invalid if the product is; (A) Damaged or not maintained as reasonable and necessary, (B) Modified, altered or used as part of any conversion kits, subassemblies or any configurations not sold by Uniden, (C) Improperly installed, (D) Repaired by someone other than an authorised Uniden Repair Agent for a defect or malfunction covered by this warranty, (E) Used in conjunction with any equipment or parts or as part of a system not manufactured by Uniden.

PARTS COVERED: This warranty covers for one (1) year, the Base/Charging Unit and Handset only. All accessories (AC Adaptor, battery etc.) are covered for 90 days only.

STATEMENT OF REMEDY: In the event that the product does not conform to this warranty at any time while this warranty is in effect, the warrantor at its discretion, will repair the defect or replace the product and return it to you without charge for parts or service. **THIS WARRANTY DOES NOT COVER OR PROVIDE FOR THE REIMBURSEMENT OR PAYMENT OF INCIDENTAL OR CONSEQUENTIAL DAMAGES. THIS GUARANTEE IS IN ADDITION TO AND DOES NOT IN ANY WAY AFFECT YOUR RIGHTS UNDER THE CONSUMER GUARANTEE ACT.**

PROCEDURE FOR OBTAINING PERFORMANCE OR

WARRANTY: In the event that the product does not conform to this warranty, the Product should be shipped or delivered, freight pre-paid, with evidence of original purchase (eg. a copy of the sales docket), to the warrantor at:

UNIDEN AUSTRALIA PTY LIMITED
SERVICE DIVISION
345 Princes Highway,
Rockdale NSW 2216
Ph (02) 9599 3577 Fx (02) 9599 3278
Ph: 1300 366 895

www.uniden.com.au

UNIDEN NEW ZEALAND LIMITED
SERVICE DIVISION
150 Harris Road,
East Tamaki, Auckland
Ph (09) 273 8377 Fx (09) 274 4253
Ph: 0800 4 UNIDEN
(864 336)

www.uniden.co.nz

Customers in other States should ship or deliver the Product freight pre-paid to their nearest Uniden Authorised Repair Centre. See Unidens Website for the nearest Repair Centre.

WARRANTY

THANK YOU

FOR PURCHASING A UNIDEN PHONE!

Uniden

© 2003 Uniden Australia Pty Limited
Uniden New Zealand Limited

Free Manuals Download Website

<http://myh66.com>

<http://usermanuals.us>

<http://www.somanuals.com>

<http://www.4manuals.cc>

<http://www.manual-lib.com>

<http://www.404manual.com>

<http://www.luxmanual.com>

<http://aubethermostatmanual.com>

Golf course search by state

<http://golfingnear.com>

Email search by domain

<http://emailbydomain.com>

Auto manuals search

<http://auto.somanuals.com>

TV manuals search

<http://tv.somanuals.com>