

Uniden



2.4GHz

TRU546
DIGITAL
CORDLESS

Owner's Manual

www.uniden.com

Welcome

Congratulations on your purchase of the Uniden TRU546 cordless telephone. This phone is designed and engineered to exacting standards for reliability, long life, and outstanding performance utilizing the latest in 2.4 GHz Spread Spectrum technology.

Note: Some illustrations in this manual may differ from the actual unit for explanation purposes.

Features

- 2.4 GHz Spread Spectrum Technology
- Caller ID and Call Waiting Caller ID
- 50 Number Caller ID Memory
- Advanced Caller ID with Call Waiting Options
- Lighted Keypad
- 3-Line, 16 Character Backlit Handset Display
- 20 Enhanced Memory Dial Locations
- 32 Digit Redial
- 3 Redial Memories
- Flash and Pause
- Bilingual Language, option
- Pulse/Tone Dialing
- Page/Find
- 10 Day Standby Battery Life
- 6 Hour Talk Time
- Handset Earpiece and Ringer Volume Control
- Hearing Aid Compatible

The TRU546 features include *AutoTalk™* and *AutoStandby™*. AutoTalk allows you to answer a call by just removing the handset from the base so you don't have to waste time pushing buttons or flipping switches. AutoStandby allows you to hang up by simply returning the handset to the base.

To protect you against misbilled calls which might result from your phone being activated by other equipment, the TRU546 has *Random Code™* digital security which automatically selects one of over 65,000 digital security codes for the handset and base. Also, the *AutoSecure™* feature electronically locks your phone when the handset is in the base.

Be sure to visit our web site: www.uniden.com

Uniden® is a registered trademark of Uniden America Corporation.

AutoTalk, AutoStandby, Random Code, and AutoSecure are trademarks of Uniden America Corporation.



Contents

Welcome/Features

Controls and Functions

2, 3

Getting Started

Read this first	4
Step 1: Checking the package contents	5
Step 2: Setting up the phone	6
Step 3: Preparing the battery pack	7
Step 4: Setting Caller ID and options/Language	13

Basics

Making and receiving calls	15
Terminology	16
Adjusting the ringer and earpiece volume	17
Redialing a call	18
Tone dial switch-over	19
Traveling out-of-range	19
Selecting a different channel	19
Paging	20
Flash and Call Waiting	20

Memory Dialing

Storing phone numbers and names	21
Steps for entering names and special characters	23
Making calls with memory dialing	25
Chain dialing	26
Editing a stored name and/or phone number	27
Erasing a stored name and phone number	30

Caller ID Features

Caller ID	31
When the telephone rings	31
Viewing the Caller ID Message list	32
Deleting information from the Caller ID list	33
Using the Caller ID list	35
Using "Caller ID on Call Waiting" service	37
Call Waiting features	38



Additional Information

Changing the digital security code	39
Beltclip installation	40
Headset installation	40
Note on power sources	41
Maintenance	41
Troubleshooting	42
General Information	44
Technical Information	45
Precautions & Warranty	47
Index	49

Controls and Functions

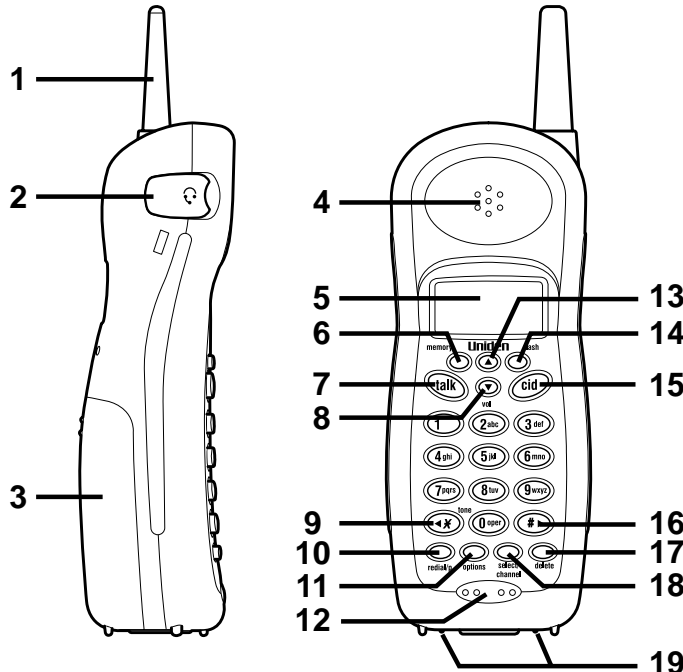

1. Handset antenna
2. Headset jack cover
3. Handset battery compartment
4. Handset earpiece
5. LCD display
6. Memory key
7. Talk key
8. Vol (volume)/▼(cursor down) key
9. * / ◀(left cursor)/tone key
10. Redial/p (redial/pause) key
11. Options key
12. Handset microphone
13. Vol (volume)/▲(cursor up) key
14. Flash key
15. Cid (Caller ID) key
16. # / ▶(right cursor) key
17. Delete key
18. Select/Channel key
19. Handset charging contacts

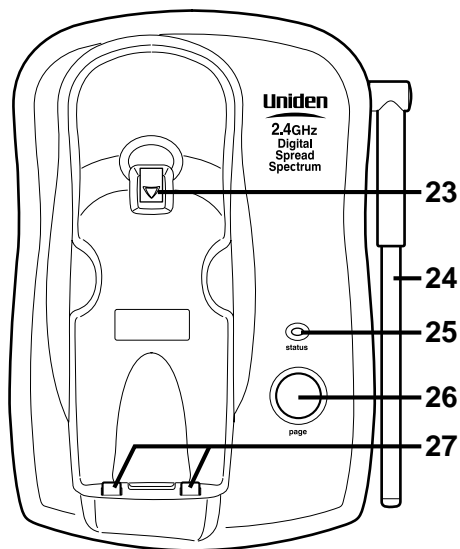
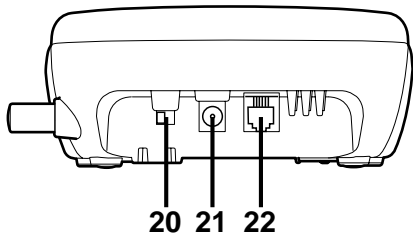

- 20. Pulse-Tone switch
- 21. DC power input
- 22. Phone jack
- 23. Handset retainer clip
- 24. Base antenna
- 25. Status LED
- 26. Page key
- 27. Base charging contacts

Read This First

This cordless telephone must be set up before use. Follow these steps:

Step 1 (page 5)

Unpack and check the telephone and accessories.

Step 2 (page 6)

Next, choose the best location to set up the base unit.

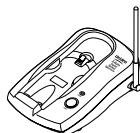

Base

Step 3 (page 7 to 10)

Then, insert the battery pack into the handset. You must charge the battery pack for **15-20 hours before plugging into the phone line and using the phone.**



Handset

Step 4 (page 13 to 14)

Finally, set the Caller ID options and store your area code in the memory to use the Caller ID service.

Note: Skip the area code setting if your calling area requires 10-digit dialing.

About the digital security code

This cordless telephone uses a digital security code to prevent unauthorized access to your base unit. This security code prevents other cordless handsets from making calls through your base unit. A random security code will be assigned automatically between your base unit and handset when you charge the battery pack for the first time. If you want to reset the security code, see page 39.

Checking the Package Contents

Make sure you have received the following items in the package. If any of these items are missing or damaged, contact the Uniden Parts Department.

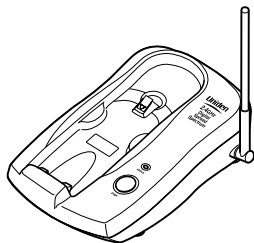

• Base unit



• Handset

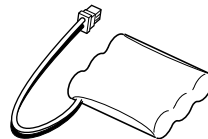

• Rechargeable battery

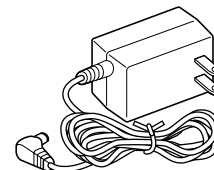

• AC adapter

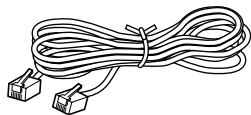

• Telephone cord

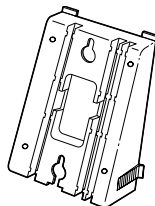

• Wall mount adapter

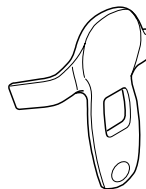

• Beltclip

Also included:

- This Owner's Manual
- Quick Reference Guide
- Registration Card

Uniden Parts Department

(800) 554-3988

Hours: M-F 7:00 AM to 5:00 PM CST.

We can also be reached on the web at www.uniden.com

Setting up the Phone

Do the following steps:

- A. Choose the best location
- B. Install the battery pack
- C. Connect the base unit
- D. Choose the dialing mode

A. Choose the best location

Before choosing a location for your new phone, read the “Installation Considerations” included in the “Precaution & Warranty”. Here are some important guidelines you should consider:

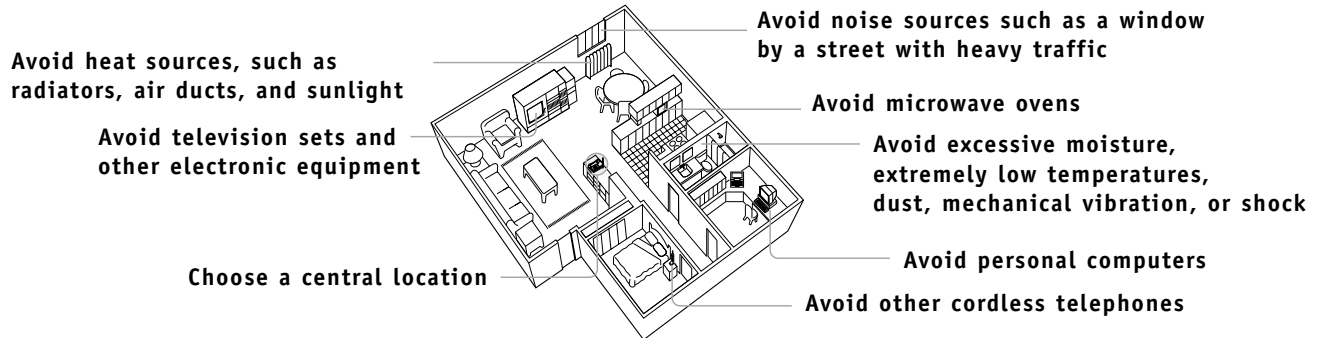

- The location should be close to both a phone jack and a continuous power outlet which is not switchable.
- Keep the base and handset away from sources of electrical noise such as motors and fluorescent lighting.
- Be sure there is sufficient space to raise the base antenna to a vertical position.
- The base can be placed on a desk, tabletop, or mounted on a standard wall plate.

B. Install the battery pack

Charge the battery pack for at least 15-20 hours before plugging the phone line into your phone.

- 1) Press in on the battery cover release and slide the cover down until it comes off.
- 2) Connect the battery pack connector observing correct polarity (black and red wires) to the jack inside the battery compartment.

Do not exert any force on this connection. It could cause damage to the battery or to the handset. The plastic connectors will fit together in only one way. Once you are certain that you have made a good connection, then insert the battery pack into the battery compartment. Do not pinch the wires.

- 3) Securely close the battery compartment cover by sliding it up until it snaps into place.
- 4) Place the handset on the base. Remove the beltclip, if attached, for face up charging.

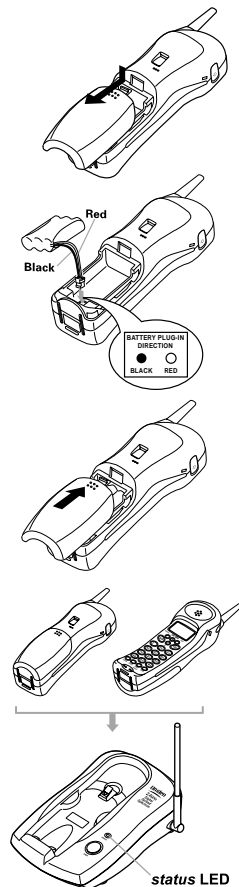

Use only the Uniden battery (BT-800) supplied with your phone. Replacement batteries are also available through the Uniden Parts Department. (See page 5.)



- Even when the battery pack is not being used, it will gradually discharge over a long period of time. For optimum performance, be sure to return the handset to the base unit after a telephone call.
- If you must replace the battery pack during a telephone call, complete the replacement of the battery pack within 30 seconds, and you can return to the original call.

Battery use time (per charge)

From fully charged

- Six hours continuous use
- Ten days when the handset is in the standby mode

Low Battery Alert

When the battery pack is very low and needs to be charged, the phone is programmed to eliminate functions in order to save power. If the phone is not in use, "Low Battery" appears on the LCD and none of the keys will operate.

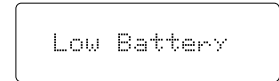

If the phone is in use, "Low Battery" flashes and the handset beeps. Complete your conversation as quickly as possible and return the handset to the base unit for charging.



The last number dialed in the redial memory, the names and the numbers stored in the memory locations are retained for up to 2 minutes while you replace the battery pack.

Cleaning the Battery Charging Contacts

To maintain a good charge, it is important to clean the battery contacts on the handset and base unit with a dry cloth or a pencil eraser about once month.

Do not use any liquids or solvents.

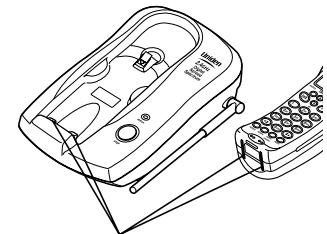

contacts

C. Connect the base unit

- 1) Connect the AC adapter to the **DC IN 9V** jack and to a standard 120V AC wall outlet.
- 2) Set the base on a desk or tabletop, and place the handset on the base unit as shown. Remove the beltclip, if attached, for face up charging. (See “Mounting the Base Unit on a Wall”, on page 11.)

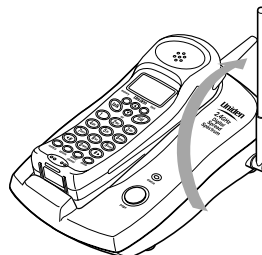
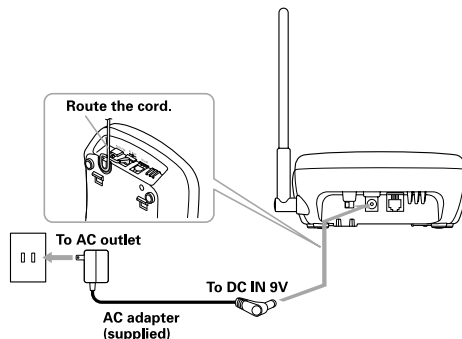

- 3) Then raise the antenna to a vertical position.
- 4) Make sure that the **status** LED lights. If the LED does not light, check to see that the AC adapter is plugged in and that the handset makes good contact with the base charging contacts.

note

- Use only the supplied AD-312 AC adapter. Do not use any other AC adapter.
- Connect the AC adapter to a continuous power supply.
- Place the base unit close to the AC outlet so that you can unplug the AC adapter easily.

note

- The handset can be placed up or face down in the base for charging.
- You have to remove the beltclip, if attached for face up charging.



Place the power cord so that it does not create a trip hazard or where it could become chafed and create a fire or electrical hazard.

- After installing the battery pack in the handset, charge your handset at least **15-20 hours before plugging into the phone line**. Once the handset battery pack is fully charged, connect the telephone line cord to the base and telephone wall outlet.

5) Connect the telephone line cord to the **TEL LINE** jack and to a telephone outlet once the handset is fully charged.



If your telephone outlet isn't modular, contact your telephone company for assistance.



Modular

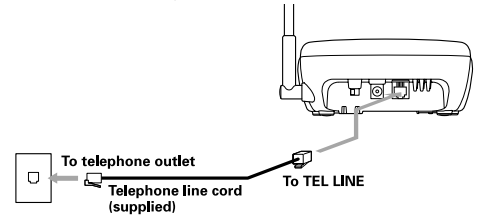

D. Choose the dialing mode

Most phone systems use tone dialing which sends DTMF tones through the phone lines. However some phone systems still use pulse dialing such as in rural areas. The default setting is tone dialing. Depending on your dialing system, set the mode as follows:

If your dialing system is	Set the switch to
Tone	TONE
Pulse	PULSE

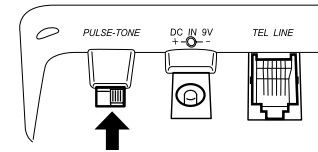

- If you are not sure of your dialing system, set for tone dialing. Make a trial call. If the call connects, leave the setting as is, otherwise set for pulse dialing.
- If your phone system requires pulse dialing and you need to send the DTMF tones for certain situations during a call, you may “switch-over” to tone dialing. (Refer to “Tone Dialing Switch-over” on page 19.)

Mounting the base unit on a wall

Setting the handset retainer clip for wall mounting

- 1) On the base unit, pull the handset retainer out of the slot. Rotate it clockwise 180 degrees.
- 2) Flip the retainer from front to back. Slide it back into the slot so that the lip of the retainer is up and the oval is down. The retainer holds the handset in place.

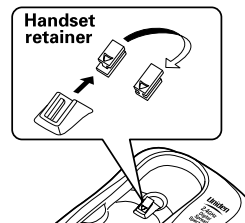

Standard wall plate mounting

This phone can be mounted on any standard telephone wall plate.

- 1) Snap the wall mount adapter into the notches on the base.
- 2) Plug the AC adapter to the **DC IN 9V** jack. Route the AC adapter cord inside the molded wiring channel as shown.
- 3) Plug the AC adapter into a standard 120V AC wall outlet.
- 4) Plug the telephone line cord into the **TEL LINE** jack. Route the cord inside the molded wiring channel as shown.
- 5) Plug the telephone line cord into the telephone outlet.
- 6) Raise the antenna to a vertical position.
- 7) Align the mounting slots on the base with the mounting posts on the wall. Push in and down until the phone is firmly seated.

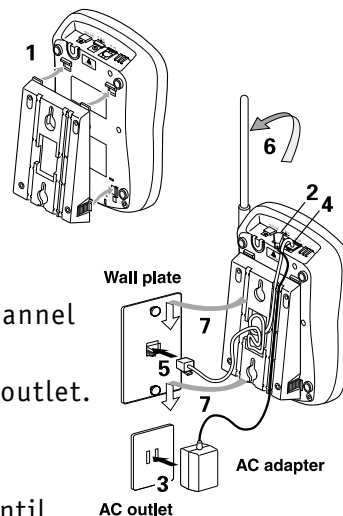

DO NOT use an outlet controlled by a wall switch.

Direct wall plate mounting

If you don't have a standard wall plate, you can mount your phone directly to the wall. Before doing this, consider the following:

- Avoid electrical cables, pipes, or other items behind the mounting location that could cause a hazard when inserting screws into the wall.
- Try to mount your phone within 10 - 15 feet of a working phone jack to avoid excessive cord lengths.
- Make sure the wall material is capable of supporting the weight of the base and handset.
- Use #10 screws (minimum length of 1-3/8 inches) with anchoring devices suitable for the wall material where the base unit will be placed.

1) Insert two mounting screws into the wall, (with their appropriate anchoring device), 1/8 inches apart. Allow about 3/16 of an inch between the wall and screwheads for mounting the phone.

2) Set the retainer clip if necessary.

3) Refer to steps 1 through 7 on page 11 to mount the telephone.

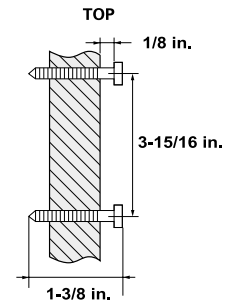

Setting Caller ID Options/Language

There are three Caller ID setup options available: AutoTalk, CIDCW (Caller ID on Call Waiting), and Area Code. (See page 14 for Area Code setup instructions.)

AutoTalk™ allows you to answer the phone without pressing the **(talk)** button. If the phone rings when AutoTalk is on, simply remove the handset from the base and the phone automatically answers the call. Or if the handset is not on the base, press any key to answer the call. If the phone rings when AutoTalk is off, you must press **(talk)** to answer the call.

Caller ID on Call Waiting (CIDCW) performs the same as regular Caller ID on a call waiting number. Call waiting options allow you to handle call waiting calls in seven different ways. (See page 38.)

You must subscribe to CIDCW from your local phone company in order to use this feature. The Call Waiting options are a separate service available through your phone company.

Language option can be used to choose the language of your display. You can select either English or French.

To change your Caller ID options/Language:

- 1) Press **(options)** in the standby mode.

The following screen appears.

```

1 Auto Talk: Off
2 CIDCW      : On
3 Area Code:
  
```

- 2) Use **(▲)** and **(▼)** or a number key (1-3) to move the pointer to the selection that you would like to change. Press **(select/channel)** to toggle between "On" and "Off" for "Auto Talk". For "CIDCW", choose "On", "Off", or "Off" depending upon the type of service to which you subscribe.

- 3) To set up the language of your display, press **(▼)** or the number key **(4)** to move the pointer to "Language".

```

2 CIDCW      : On
3 Area Code:
4 Language  : Eng
  
```

Press **(select/channel)** to select "Eng" (English) or "Fr." (French).

- 4) After you have made your Caller ID selections, press **(options)** and return the handset to the base.



If you calling area requires 10-digit dialing, do not program this option.

Entering Your Area Code

If you enter a 3-digit area code number in the Area Code option, your local area code does not appear in Caller ID messages. Do not program this option, if your calling area requires 10-digit dialing.

When reviewing Caller ID messages, you will see only the local seven digit number. For calls received from outside your local area code, you will see a full 10-digit number.

1) When the phone is in the standby mode, press **(options)**. The Caller ID setting screen appears.

```
1 Auto Talk: Off
2 CIDCW      : On
3 Area Code:
```

2) Press 3 to select "Area Code" or press **(v)** twice.

```
1 Auto Talk: Off
2 CIDCW      : On
3 Area Code:
```

3) Press **(select/channel)**.

```
1 Auto Talk: Off
2 CIDCW      : On
3 Area Code: █
```

4) Use the number keys (0 to 9) to enter the 3-digit area code.

5) Press **(select/channel)**. A tone sounds and the displayed area code is entered.

6) Press **(options)** to complete the setting. Or return the handset to the base unit to complete the setting. The handset returns to the standby mode.



When the area code has already been stored in memory, the stored area code will be displayed. To change it, use the **(delete)** and number keys to enter the new area code. Then press **(select/channel)**. A confirmation tone sounds. To complete the setting, press **(options)** or return the handset to the base unit.

```
1 Auto Talk: Off
2 CIDCW      : On
3 Area Code: 817
```

Making and Receiving Calls

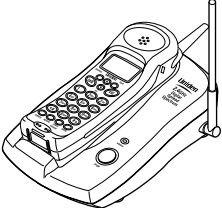
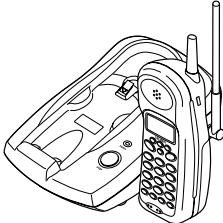
	Handset On Base 	Handset Off Base 
To answer a call	Pick up the handset (AutoTalk), or pick up the handset and press (talk) .	Press any key (Any Key Answer).
To make a call	1) Pick up the handset. 2) Press (talk) . 3) Listen for the dial tone. 4) Dial the number. OR 1) Pick up the handset. 2) Dial the number, then press (talk) .	1) Press (talk) . 2) Listen for the dial tone. 3) Dial the number. OR Dial the number, then press (talk) .
To hang up	Press (talk) , or return the handset to the base (AutoStandby).	Press (talk) .



Refer to page 13 "Setting Caller ID Options/Language" to turn on the AutoTalk feature if desired.

Terminology

Throughout this manual, terms such as Standby and Talk Mode are used. Below is the terminology explanation.

- **Standby Mode** -The handset is not in use, off the base, and *(talk)* has not been pressed. A dial tone is not present.
- **Talk Mode** -The handset is off the base and *(talk)* has been pressed enabling a dial tone.

Adjusting the Ringer and Earpiece Volume



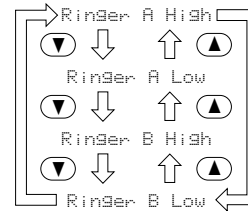

Handset ringer tone and volume

Press **▲** or **▼** in standby mode to select one of four ringer tone and volume combinations.



Earpiece volume

Pressing **▲** or **▼** during a call will change the earpiece volume of the handset. This setting will remain in effect after the telephone call has ended.

Volume Maximum  Volume High  Volume Medium  Volume Low 



When you press **▲** in Maximum mode or **▼** in Low mode, an error tone sounds.

Ringer off

During the standby mode or tone/volume setting, press and hold **▼** until the phone beeps and "Ringer Off" appears.

To turn the ringer back on, simply press **▲** or **▼**. "Ringer A High" appears.

Ringer Off



- If the number exceeds 32 digits, only the first 32 digits are retained for redialing.
- Press and hold **(delete)** to delete the displayed redial number.
- Refer to terminology explanation on page 16, if necessary.
- Only the last number dialed can be accessed after **(talk)** has been pressed.

Redialing a Call

The last three phone numbers dialed can be quickly redialed.

Redialing from Standby Mode

From the Handset

- 1) Press **(redial/p)**.
The phone number that was last dialed appears on the display.
- 2) Press **(redial/p)** again.
Each press of **(redial/p)** will display one of the last three numbers dialed.
- 3) Press **(talk)**. "Talk" appears on the display, then the volume setting is displayed.
- 4) The selected number is dialed. After about 5 seconds, the call-time display appears.
- 5) To hang up, press **(talk)** or place the handset on the base. The call-time will be displayed for about 5 seconds.

Redial from Talk Mode

- 1) Press **(talk)**.
"Talk" and the volume setting appears on the display.
- 2) Press **(redial/p)**.
The last number dialed will be displayed and redialed.
- 3) To hang up, press **(talk)** or place the handset on the base. The call-time will be displayed for about 5 seconds.



If you set the ringer to off, "<Ringer Off>" appears on the display.

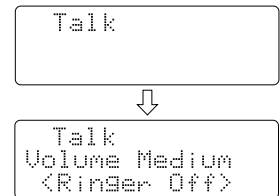
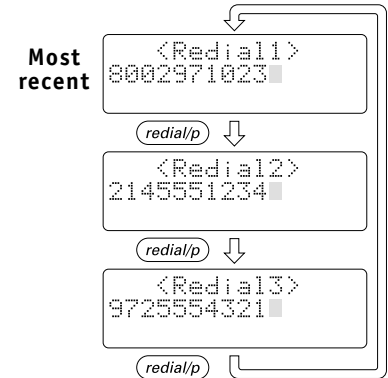

Tone Dialing Switch-over

Some telephone companies use equipment that require pulse dialing (sometimes referred to as rotary dialing). If you need to enter tone dialing digits, you can switch-over to tone dialing during the call. An example of this could be entering your bank account number after you have called your bank. The digits of your bank account can be sent using DTMF tones.

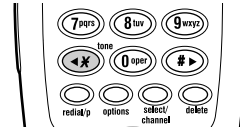

Initially make your call with the pulse dialing mode. Once your call connects, press ***/*tone**. Enter the desired number (like in the example above, the bank account number). These digits will be sent as tone dialing. This special number can be stored in a memory location. This is referred to as Chain Dialing (See page 26). Once the call ends, the tone mode is canceled and pulse dialing mode resumes.

Traveling Out-of-Range

During a call, as you begin to move your handset too far from your base unit, noise increases. If you pass the range limits of the base unit, your call will terminate within 30 seconds.

Selecting a Different Channel

If you encounter interference while using your phone, you can manually change the phone's channel for clear operation. Interference can come from appliances or other phones in your home. This function works only when the phone is in use. During the course of a conversation, if you hear static or noise which makes it difficult to hear, press **select/channel**. "Scanning" appears on the display, indicating the phone is changing to another channel. For more information on interference, refer to "Technical Information" on page 45.



The tone feature only applies when the dial mode is set to pulse.

Paging

To locate the handset

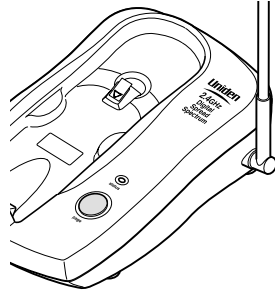

- 1) Press **page** on the base.
- 2) The handset beeps for 60 seconds.
The following screen appears:
- 3) Press any key on the handset or **page** on the base, or return the handset to the base to end the page.



When an incoming call is received during paging, paging is canceled and the telephone is switched to the incoming call.

Flash and Call Waiting

If you have “Call Waiting” service and a call waiting tone sounds while you are on a call, press **flash** to accept the waiting call. There is a short pause, then you will hear the new caller. To return to the original caller, press **flash** again.

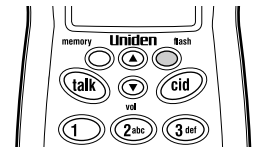

You must subscribe through your local telephone company to receive Call Waiting Service.

Storing Phone Numbers and Names

Memory Dialing allows you to dial a number using just a few key presses. Your TRU546 stores up to 20 names/numbers in the memory.



1) Press and hold **memory** until "Memory Store" is displayed.

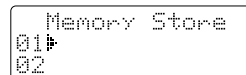

2) Press **▲** and **▼** or enter a two-digit number (01 - 20) to select the memory location where you would like to store the number.

3) Press **select/channel**.

The following screen appears and a cursor flashes indicating that the display is ready for the name to be entered.

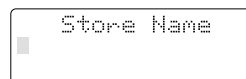

If this screen appears, the selected memory location is already stored. Then, you must either change the entry in this location, clear the location, or select "Go Back" to choose another location.

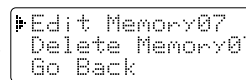

4) To enter a name (up to 13 characters), use the number keys.

- See the "Steps for entering names and special characters". (See pages 23-24)
- Use **#>** and ***←/tone** to move the cursor to the desired location.
- Use **delete** to delete characters as needed.
- Press and hold **delete** to delete all the characters.
- If a name is not required, go to step 5.



- In memory dialing operation, you must press a key within 20 seconds or the phone will return to standby. If you return the handset to the base, the phone will return to standby also.
- You have 20 seconds after pressing **memory** to enter the number you wish to store. Otherwise, an error tone sounds.



The pause feature is useful for long distance calling, credit card dialing, or sequences that require a pause between digits.

5) Press **(select/channel)**.

“Store Number” is displayed. The cursor flashes indicating that the display is ready for the number to be entered.

```
Store Number
█
```

6) Use the number keypad to enter the phone number. The phone number cannot exceed 20 digits.

```
Store Number
8002971023█
```

- Use **(redial/p)** to enter a pause in the dialing sequence. The display shows a “P”. Each pause counts as one digit and represents a two second delay in time between digits.
- Use **(delete)** to delete digits as needed.

7) Press **(select/channel)**.

The handset beeps and displays the confirmation screen. Memory storage is complete.

For example, if you store a name and number into memory location number 07, the display shows “Memory07 Stored”.

After about 2 seconds, “Memory Store” is displayed.

```
Memory07 Stored
```

```
Memory Store
07 UNIDEN CORP
08
```

8) Press **(memory)** to return to standby mode.

Steps for Entering Names and Special Characters

Refer to the letters on the number keys to select the desired characters. With each press of a numeric key, the displayed character appears in the following order: Upper case letters first, lower case letters next and finally the number corresponding to the key.

	Number of times key is pressed								
keys	1	2	3	4	5	6	7	8	9
1	1								
2abc	A	B	C	a	b	c	2		
3def	D	E	F	d	e	f	3		
4ghi	G	H	I	g	h	i	4		
5jkl	J	K	L	j	k	l	5		
6mno	M	N	O	m	n	o	6		
7pqrs	P	Q	R	S	P	q	r	s	7
8tuv	T	U	V	t	u	v	8		
9wxyz	W	X	Y	Z	w	x	y	z	9
0	*	#	-	&	()	(blank)	0	

If you make a mistake while entering a name

Use **(←/tone)** or **(#→)** to move the cursor to the incorrect character. Press **(delete)** to erase the wrong character, then enter the correct character. To delete all characters, press and hold **(delete)**.

For example, to enter **Uniden**:

- 1) Pick up the handset and press and hold *memory*.
 - 2) Enter a number or press ▲, ▼ to select a memory location number.
 - 3) Press *select/channel*.
 - 4) Press 8 twice.
 - 5) Press 6 five times.
 - 6) Press 4 six times.
 - 7) Press 3 four times, then press #➡ to move the cursor to the right.
-  If the next character uses the same number key, you must press #➡ to move the cursor over. Otherwise the next time you press the number key, it changes the character that was previously set.
- 8) Press 3 five times.
 - 9) Press 6 five times.
 - 10) When finished, Press *select/channel*.

To continue to store the telephone number, proceed to step 6 on page 22.

Making Calls with Memory Dialing

Memory dialing from Standby Mode

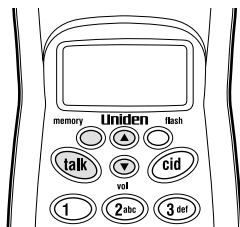

- 1) Press **memory**.
The handset displays your programmed memory locations.
- 2) Press **▲** and **▼** or enter a two-digit number (01 - 20) to select the memory location you would like to dial.
- 3) Press **talk**. "Talk" and the volume setting appear on the display. Then the displayed number is dialed.

```

01 UNIDEN CORP
02 JOHN DOE
03 MOM AND DAD
    
```

```

>Talk<
0123456789012
    
```



- If you press **select/channel** before **talk**, you can confirm the name and number stored in the selected memory location. To exit this mode, press and hold **delete**. The handset returns to standby.
- To exit the memory function without dialing, press **memory**. The handset returns to standby.

Display a Programmed Number

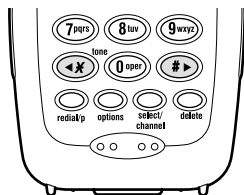

Use **#>** and ***/←/tone** to toggle between the names display and the numbers display.

Program name		Program number
01 UNIDEN CORP	→	01 8002971023
02 JOHN DOE		02 5452930
03 MOM AND DAD	←	03 8175551212



When the stored phone number has 14 or more digits, "→" is displayed next to the 12th digit. Press **#>** to see the extra digits and ***/←/tone** to return.

```

05 012345678901
06 011813554329+
07
    
```



If you select a memory location that does not have a stored number, the handset will beep rapidly and the phone will not dial.

Memory dialing from Talk Mode

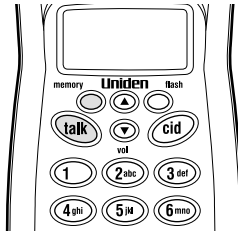

- 1) Press **talk**.
"Talk" and the volume setting appear on the display.



If you set the ringer to off, "<Ringer Off>" appears on the display.

- 2) press **memory**.
- 3) Enter a two-digit number (01 - 20) to select the memory location of the desired phone number.
The selected phone number is displayed.
Then the number is dialed.

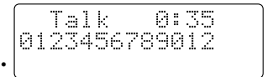
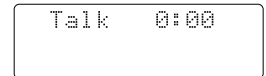
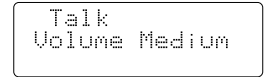

Chain Dialing

The 20 memory locations on the handset are not limited to phone numbers. You may want to store in memory a group of numbers (up to 20 digits) that you need to enter once your call connects. This is referred to as Chain Dialing.

An example of this is a bank account number. Once you have called your bank, when you are prompted to enter the account number, simply press **memory** and then the location where the special number has been stored.

Store your special number with identifying name in memory as you would a phone number. (Refer to "Storing Phone Numbers and Names" on page 21.) Enter a pause as necessary in the sequence.

A pause counts as one digit and represents a two second delay in time between digits as they are sent.

Editing a Stored Name and/or Phone Number

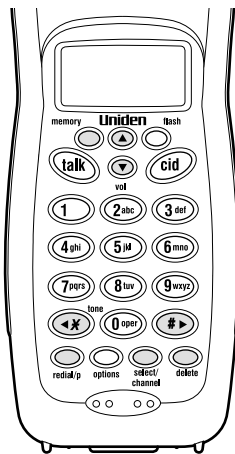

1) Press and hold memory until "Memory Store" is displayed.

```
Memory Store
01 UNIDEN CORP
02 JOHN DOE
```

2) Press ▲ and ▼ or enter a two-digit number (01 - 20) to select the memory location you would like to edit.

3) Press select/channel.

The following screen appears with the memory location number that you have selected in the display.

```
Edit Memory01
Delete Memory01
Go Back
```

4) Press ▲ or ▼ to select "Edit Memory", then press select/channel.

The following screen appears.

The cursor flashes indicating that the display is ready for the name to be edited. When a name has not been stored, the cursor appears at the beginning of the second line.

```
Store Name
UNIDEN CORP
```

5) Press number keypad, #>, */-/tone, or delete to edit the name. (See page 23.) To edit only the phone number, skip this step.

6) Press **(select/channel)**.

The following screens appears.

The cursor flashes indicating that the display is ready for the number to be edited.

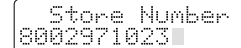

```
Store Number
0002971023
```

7) Use the number keypad, **(redial/p)** or **(delete)** to edit the phone number.

The phone number cannot exceed 20 digits.

(See page 22.)

If you don't want to change the phone number, skip this step.

8) Press **(select/channel)**. The handset beeps and displays the confirmation screen. The memory storage is complete.

For example, if you store a name and number into memory location number 01, the display shows "Memory01 Stored".

After about 2 seconds,

"Memory Store" is displayed.

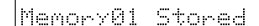

```
Memory01 Stored
```



```
Memory Store
01 UNIDEN CORP
02 JOHN DOE
```

9) Press **(memory)** to return to standby mode.

Display a Programmed Number

Use **#>** and ***/</tone** to toggle between the names display and the numbers display.

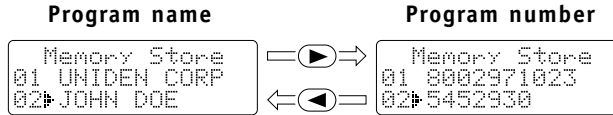

- When the stored phone number has 14 or more digits, “➔” is displayed next to the 12th digit. Press **#>** to see the extra digits and ***/</tone** to return.

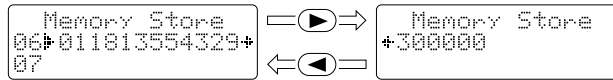

Erasing a Stored Name and Phone Number

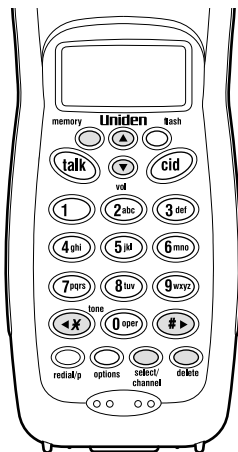

- 1) Press and hold memory until "Memory Store" is displayed.
- 2) Press ▲ and ▼ or enter a two-digit number (01 - 20) to select the memory location you would like to erase.

```
Memory Store
01 UNIDEN CORP
02 JOHN DOE
```

- 3) Press select/channel.
The following screen appears with the memory location number that you have selected in the display.

```
Edit Memory02
Delete Memory02
Go Back
```

- 4) Press ▼ to move the pointer down to the "Delete Memory" command line.

```
Edit Memory02
Delete Memory02
Go Back
```

- 5) Press select/channel. The following confirmation screen appears.

```
Delete Memory02?
Yes
Delete
```

- 6) Press ▲ to move the pointer to "Yes".
- 7) Press select/channel or delete.

There is a confirmation tone and the entry is deleted. The following screen appears.

```
Memory02 Deleted
```

- 8) After a few seconds the display returns to the "Memory Store" screen. You may select another number to delete (return to step 2) or press memory to return to standby.

```
Memory Store
02
03 MOM AND DAD
```

Caller ID

You must subscribe to Caller ID service to use this feature.

When the telephone rings, the Caller ID feature allows you to view the caller's name and phone number on the display before you answer the phone.

The handset displays the incoming call phone number, name, time, and the number of calls. Additionally, you can dial the displayed number and store the information for memory dialing.

Make sure you have turned on the Caller ID/Call Waiting feature (AutoTalk Feature is set to on).



- If you answer a call before the Caller ID message is received (Example: before the second ring), the Caller ID message will not appear.
- When the call is received via a telephone company that does not offer Caller ID service, the caller's phone number and name do not appear. (This includes international calls.)
- When the call is via a private branch exchange (PBX), the caller's phone number and name may not appear.

When the Telephone Rings

- 1) When the Caller ID message is received, the display shows the caller's phone number. The incoming call information is stored in the Caller ID record. If the Caller ID service includes the caller's name, the caller's name appears on the display (up to 15 letters).

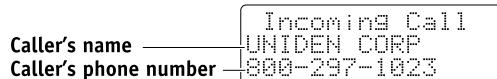

Here are some typical displays;

When the phone number and name data are received

```
Incoming Call
UNIDEN CORP
800-297-1023
```

When invalid data is received

```
Incoming Call
Incomplete Data
```

When a private name is received **When a private number is received**

```
Incoming Call
Private Name
800-297-1023
```

```
Incoming Call
UNIDEN CORP
Private Number
```



- In Caller ID operation, if no key is pressed within 20 seconds, an error tone sounds and the telephone returns to the standby mode.
- If a call comes in via a telephone system that does not offer Caller ID service, no information is stored.
- Each message can be up to 15 characters for the phone number and the name.

When an unknown name is received When an unknown number is received

```
Incoming Call
Unknown Name
800-297-1023
```

```
Incoming Call
UNIDEN CORP
Unknown Number
```



When the ringer is set off, "<Ringer Off>" appears.

2) When you pick up the phone, the display changes to "Talk". (AutoTalk feature is set to on.)



Data errors appear as "■".

```
Incoming Call
UNIDEN CORP
800-2■■-1023
```

Viewing the Caller ID Message List

The Caller ID list stores information for up to 50 incoming calls - even unanswered calls.

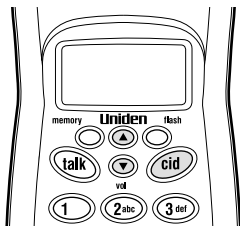

1) Press **cid**.

The summary screen appears.

The screen shows the number of new messages and total messages.

```
New :01
Total:02
```

2) Press **▼** to display the latest Caller ID message.

```
5/17 12:30PM 03
UNIDEN CORP
800-297-1023
```

3) Press **▼** to see the next message, or press **▲** to see previous message.

4) Press **cid** to return to standby.

Deleting Information from the Caller ID List

The TRU546 stores up to 50 messages. If the phone receives the 51st message, the oldest one in the list is automatically deleted. Caller ID data can also be deleted manually.

Deleting a Caller ID message

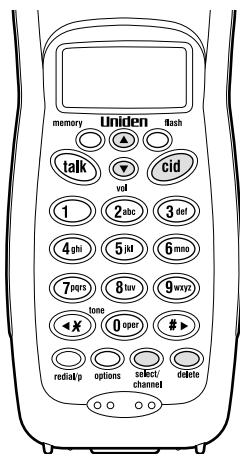

- 1) Press **(cid)**.
Display the message to be deleted from the Caller ID list by pressing **(▲)** or **(▼)**.
- 2) Press **(delete)**.
- 3) Press **(▲)** or **(▼)** to select "Yes" or "No".
- 4) Press **(select/channel)** or **(delete)**.

When the pointer is at "Yes":

A tone sounds and the Caller ID message is deleted. The Caller ID message is then displayed.

When the pointer is at "No":

The display returns to the Caller ID display.

```
5/17 12:30PM 03
UNIDEN CORP
800-297-1023
```

```
Delete Message?
▶ Yes
No
```



- While using the "Delete All?" or "Delete Message?" screen if no key is pressed for more than 20 seconds, an error tone sounds and the telephone returns to standby.
- If you get an incoming call or page, the deleting operation is canceled. The telephone is set to receive the incoming call or page.



If you get an incoming call or page, the deleting operation is canceled and the telephone is set to receive the incoming call or page.

Deleting all Caller ID names/numbers



1) Press **cid**.

2) Press **delete**.

3) Press **▲** or **▼** to select "Yes" or "No".

4) Press **select/channel** or **delete**.

```
New :01
Total:02
```

```
Delete All?
Yes
#No
```

When the pointer is at "Yes":

A tone sounds and all stored Caller ID messages are deleted.

```
Total:00
```

When the pointer is at "No":

The display returns to the summary screen.

```
New :01
Total:02
```

Using the Caller ID List

Calling a party from the Caller ID list

You can place a call from the Caller ID list. The TRU546 stores up to 50 messages.

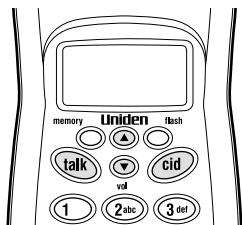

1) Press **cid**.

Select the phone number that you want to dial by pressing **▲** or **▼**.

```
5/17 12:30PM 03
UNIDEN CORP
800-297-1023
```

2) Press **talk**.

The displayed phone number will be dialed automatically.

```
Talk
8002971023
```

Long Distance call and Area Code setting/Cancellation

Pressing **1** while the incoming call information is displayed (in step 1) will set or cancel a long distance call. Pressing **3** will set or cancel the area code setting.

Dial edit

You can temporarily edit the Caller ID number that is displayed by pressing **select/channel**. A cursor appears in the display. Press **delete** to move the cursor left, make your changes and then press **talk**. This will not change the number in the Caller ID list memory.



- You cannot make a call from the Caller ID list if your TRU546 is connected to a private branch exchange (PBX).
- When a long distance call has been set, "1" appears in the display.
- In Caller ID operation, if no key is pressed within 20 seconds, an error tone sounds and the telephone returns to the standby mode.



- You can not store a Caller ID message if no phone number appears in the message.
- If there is an incoming call or page, memory storage is canceled and the telephone is set to receive the incoming call or page.

Storing Caller ID messages in Memory dialing

The phone number of the party on the Caller ID list can be stored in memory dialing.

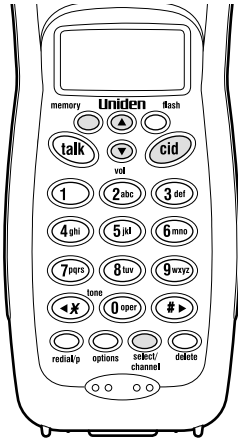

- 1) Press **cid**.
Select the phone number to be stored from the Caller ID list by pressing **▲** or **▼**.
- 2) Press **memory**.
- 3) Press **▲** and **▼** or enter a two-digit number (01 - 20) to select the memory location.
- 4) Press **select/channel**.
A confirmation tone will sound.
The number is stored in memory, and the display returns to the Caller ID list.

```
5/17 12:30PM 03  
UNIDEN CORP  
800-297-1023
```

```
Select Location  
01 UNIDEN CORP  
02 JOHN DOE
```

```
5/17 12:30PM 03  
UNIDEN CORP  
800-297-1023
```



If a message has already been stored in the selected memory number location, a confirmation screen is displayed. Press **▲** to select "Yes". Press **select/channel** to overwrite. The display returns to the Caller ID list.

```
Replace Memory?  
Yes  
No
```

Using “Caller ID on Call Waiting” Service

“Caller ID” and “Call Waiting” are separate services. CIDCW (Caller ID on Call Waiting) performs the same as regular Caller ID on a call waiting number. You must subscribe to the “Caller ID on Call Waiting (CIDCW) services” before you can use the following features. The “Call Waiting” service can also be used independently. Please contact your local telephone company for details.

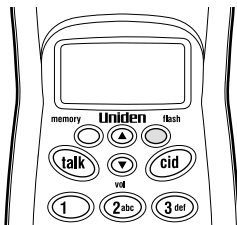

1) When a new incoming call is received during your current telephone call, the phone number and the name of the caller are displayed.

```
Talk 10:30
UNIDEN CORP
800-297-1023
```

2) Press flash.

You will be able to talk with the second caller. The first caller will be put on hold.

3) To return to the first caller, press flash again.

note

When CIDCW is set to **OFF** in the Caller ID options (see page 38), you can press the Options key after receiving a call waiting call and view a list of ways to handle the new call. Choose an option using the ▲ and ▼ keys or a number key (1-7), and press select/channel to activate.



You can also answer a call waiting call immediately by pressing the **(flash)** key. The first caller will be placed on hold. To return to the original caller, press **(flash)** again.

Call Waiting Features

Your TRU546 gives you new options for call waiting. At the touch of a button, you can ask the caller to hold, send them to your voice mail service, or conference them into your current call. You may be required to subscribe to a voice mail service, call waiting, and call waiting options to use these features. Not all features are available in all areas. Check with your local telephone company for details.

Selecting an Option

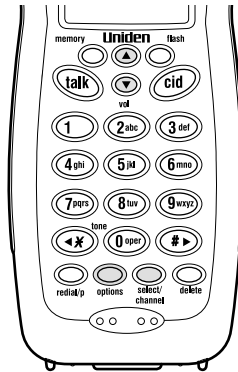

- 1) When you receive a call waiting call, press **(options)** for a list of options.
- 2) Press **(▲)** and **(▼)** keys or a number key (1-7) to select an option.
- 3) Press **(select/channel)** .
A confirmation screen will appear.

```
1 Ask to Hold
2 Tell Busy
3 Take Message
```

Your TRU546 is pre-programmed with seven call waiting options. You may select to ask the calling party to **hold**, send them a **busy** message, **forward** them to your voice mail service or **conference** them into the current call. You may also select to **answer and drop** the first caller or, at any time, choose to **drop the first** or **drop the last** caller. Check with your local telephone company for a full list of options.

Changing the Digital Security Code

The digital security code is an identification code used to connect the handset and the base unit. Normally, setting the code is not necessary. The first time you charge your handset, the security code is automatically set. (See "About the digital security Code", page 4)
In the rare situation that you suspect another cordless telephone is using the same security code, you can change the code.

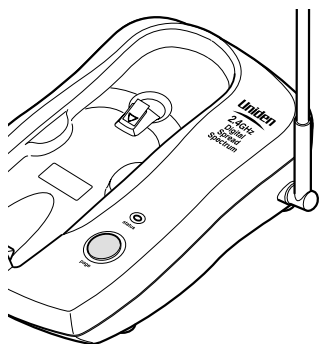

- 1) Remove the handset from the base unit. Press and hold **page**.
- 2) While the handset is emitting the paging sound, replace the handset on the base unit. The paging tone stops. Leave the handset on the base for more than 3 seconds. A random, new security code is set.



If the handset battery pack is completely discharged or the battery pack is removed, the digital security code will be lost. If this happens, a new security code is set automatically next time the battery pack is charged.

Beltclip Installation

To attach the beltclip

Insert the beltclip into the holes on each side of the handset. Press down until it clicks.

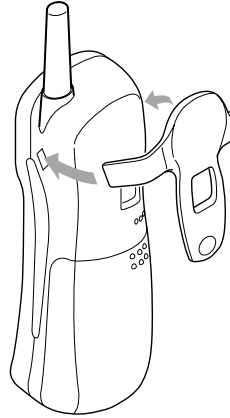

To remove the beltclip

Pull both sides of the beltclip to release the tabs from the holes.

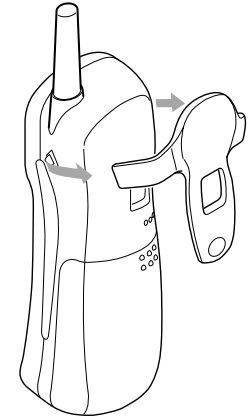

Headset Installation

Your phone may be used with an optional headset, the Uniden HS910. To use this feature, simply plug the headset plug into the headset jack. Your phone is ready for hands-free conversation. (Headsets may be purchased by calling the Uniden Parts Department or visiting the website. See page 5.)

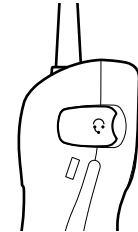

Note on Power Sources

Battery replacement and handling

When the operating time becomes short, even after a battery is recharged, please replace the battery. With normal usage, your battery should last about one year. Please contact your place of purchase or the Uniden Parts Department for a replacement battery.

Power Failure

During the period that the power is off, you will not be able to make or receive calls with the telephone.

Caution

- Use the specified battery pack.
- Do not remove the battery from the handset to charge it.
- Never throw the battery into a fire, disassemble it, or heat it.
- Do not remove or damage the battery casing.

Maintenance

When slightly dirty

Wipe with a soft, dry cloth.

When very dirty

Wipe with a soft cloth that has been dampened with diluted, neutral detergent. Dry with a dry cloth.

When the charging terminals become dirty

Wipe with a dry cloth or a pencil eraser, if necessary.



RECYCLING NICKEL-CADMIUM BATTERIES

Nickel-cadmium cells are used in the battery pack. Please take your used nickel-cadmium battery packs to a store that recycles nickel-cadmium batteries.

Caution

Do not use paint thinner, benzene, alcohol, or other chemical products. Doing so may discolor the surface of the telephone and damage the finish.

Troubleshooting

If your phone is not performing to your expectations, please try these simple steps first.

Symptom	Suggestion
The <i>status</i> LED won't light when the handset is placed in the base unit.	<ul style="list-style-type: none">• Make sure the AC adapter is plugged into the base unit and wall outlet.• Make sure the handset is properly seated in the base unit.• Make sure the charging contacts on the handset and base unit are clean.
The audio sounds weak and/or scratchy.	<ul style="list-style-type: none">• Press <i>(select/channel)</i> during a call to help eliminate background noise.• Make sure that the base unit antenna is in a vertical position.• Move the handset and or base unit to a different location away from metal objects or appliances and try again.• Make sure that you are not too far from the base.
Can't make or receive calls.	<ul style="list-style-type: none">• Check both ends of the base unit telephone line cord.• Make sure the AC adapter is plugged into the base unit and wall outlet.• Disconnect the AC adapter for a few minutes, then reconnect it.• Reset the digital security code (See page 39).• Make sure <i>(talk)</i> is pressed.

Symptom	Suggestion
The handset doesn't ring or receive a page.	<ul style="list-style-type: none"> • The battery pack may be weak. Charge the battery on the base unit for 15-20 hours. • The handset may be too far away from the base unit. • Place the base unit away from appliances or metal objects. • Reset the digital security code (See page 39).
The Caller ID does not display.	<ul style="list-style-type: none"> • The handset was picked up before the second ring. • The call was placed through a switch board. • Call your local telephone company to verify your Caller ID service is current. • Charge the handset.
Severe noise interference.	<ul style="list-style-type: none"> • Keep the handset away from microwave ovens, computers, remote control toys, wireless microphones, alarm systems, intercoms, room monitors, fluorescent lights, and electrical appliances. • Move to another location or turn off the source of interference.
If you still have a problem.	<ul style="list-style-type: none"> • Call our customer hotline at 1-800-297-1023.

General Information

The TRU546 complies with FCC Parts 15 and 68.

Operating Temperature: 0 °C to +50 °C (+32 °F to +122 °F)

AC Adapter Information

AC Adapter part number: AD-312

Input Voltage: 120V AC 60Hz

Output Voltage: 9V DC 350 mA

Battery Information

Battery part number: BT-800

Capacity: 800 mAH, 3.6V

Battery Use Time (per charge)

From fully charged:

Talk Mode duration 6 hours

Standby Mode duration 10 days



If the handset is left off of the base, the actual Talk mode duration will be reduced respective to the amount of time the handset is off the base.

Recharge your phone on a regular basis about once a week by placing the handset on the base for 15-20 hours. When the operating time becomes short, even after the battery is recharged, please replace the battery. With normal usage, the battery should last about one year.

Replacement batteries may be purchased at your local Uniden dealer or by contacting the Uniden Parts Department (800) 554-3988. Hours are from 7:00 a.m. to 5:00 p.m. Central Time, Monday through Friday. We can also be reached on the web at www.uniden.com

Specifications, features, and availability of optional accessories are all subject to change without prior notice.

Technical Information

The FCC wants you to know!

Changes or modifications to this product not expressly approved by Uniden, or operation of this product in any way other than as detailed by the owner's manual, could void your authority to operate this product. The equipment cannot be used on public coin phone service provided by the telephone company. Connection to party line service is subject to state tariffs. (Contact the state public utility commission, public service commission or corporation commission for information.)

Below is some information that might concern you while using your new phone.

Range

Your new phone is designed to achieve the maximum possible range by transmitting and receiving according to the highest specifications set forth by the FCC. We have rated this phone to operate at a maximum distance with the qualification that the range depends upon the environment in which the

telephone is used. Many factors limit range, and it would be impossible to include all the variables in our rating. The Maximum Range rating of this phone is meant to be used as a means of comparison against other range claims.

Telephone Line Problems

The FCC has granted the telephone company the right to disconnect service in the event that your phone causes problems on the telephone line. Also, the telephone company may make changes in facilities and services which may affect the operation of your unit. However, your telephone company must give adequate notice in writing prior to such actions to allow you time for making necessary arrangements to continue uninterrupted service.

If you are having trouble with your telephone service, you must first disconnect your phone to determine if it is the cause of your problem. If you determine that it is the cause, you must leave it disconnected until the trouble has been corrected.

Radio Interference

Radio interference may occasionally cause buzzing and humming in your cordless handset, or clicking noises in the base. This interference is caused by external sources such as TV, refrigerator, vacuum cleaner, fluorescent lighting, or electrical storm. Your unit is NOT DEFECTIVE. If these noises continue and are too distracting, please check around your home to see what appliances may be causing the problem. In addition, we recommend that the base not be plugged into a circuit that also powers a major appliance because of the potential for interference. Be certain that the antenna on the unit is fully extended when needed.

In the unlikely event that you consistently hear other voices or distracting transmissions on your phone, you may be receiving radio signals from another cordless telephone or other source of interference. If you cannot eliminate this type of interference, you need to change to a different channel.

Finally, it should be noted that some cordless telephones operate at frequencies that may cause interference to nearby TVs and VCRs. To

minimize or prevent such interference, the base of the cordless telephone should not be placed near or on top of a TV or VCR. If interference is experienced, moving the cordless telephone farther away from the TV or VCR will often reduce or eliminate the interference.

More Than One Cordless Telephone

If you want to use more than one cordless telephone in your home, they must operate on different channels. Press the channel key to select a channel that provides the clearest communication.

Cordless Telephone Privacy

Cordless telephones are radio devices. Communications between the handset and base of your cordless telephone are accomplished by means of radio waves which are broadcasted over the open airways. Because of the inherent physical properties of radio waves, your communications can be received by radio receiving devices other than your own cordless telephone unit. Consequently, any communications using your cordless telephone may not be private.

Precautions!

Before you read anything else, please observe the following:

Warning!

Uniden America Corporation DOES NOT represent this unit to be waterproof. To reduce the risk of fire, electrical shock, or damage to the unit, DO NOT expose this unit to rain or moisture.

Rechargeable Nickel-Cadmium Battery Warning

- This equipment contains a rechargeable nickel-cadmium battery.
- Cadmium is a chemical known to the State of California to cause cancer.
- The rechargeable nickel-cadmium battery contained in this equipment may explode if disposed of in a fire.
- **Do not** short-circuit the battery.
- Do not charge the rechargeable nickel-cadmium battery used in this equipment in any charger other than the one designed to charge this battery as specified in the owner's manual. Using another charger may damage the battery or cause the battery to explode.

Rechargeable Nickel-Cadmium Batteries Must Be Recycled or Disposed of Properly



- Uniden voluntarily participates in an RBRC® industry program to collect and recycle nickel-cadmium batteries at the end of their useful life, when taken out of service within the United States. The RBRC® program provides a convenient alternative to placing used nickel-cadmium batteries into the trash or municipal waste stream, which is illegal in some areas.
- Through the RBRC® program, Uniden makes it easy for you to drop off the used battery at local retailers of replacement nickel-cadmium batteries. You may also contact your local recycling center for information on where to return the used battery. Please call 1-800-8-BATTERY for information on Ni-Cd battery recycling in your area. Uniden's involvement in this program is part of its commitment to protecting our environment and conserving natural resources.
- RBRC® is a registered trademark of the Rechargeable Battery Recycling Corporation.



The exclamation point within an equilateral triangle is intended to alert the user to the presence of important operating and maintenance (servicing) instructions in the literature accompanying the appliance.

Important Safety Instructions

When using your telephone equipment, these basic safety precautions should always be followed to reduce the risk of fire, electrical shock, and injury to persons:

1. Read and understand all instructions.
2. Follow all warnings and instructions marked on the product.
3. Unplug this product from the wall outlet before cleaning. Use a dry cloth for cleaning without liquid or aerosol cleaners.
4. Do not use this product near water; for example, near a bath tub, wash bowl, kitchen sink or laundry tub, in a wet basement, or near a swimming pool.
5. Do not place this product on an unstable cart, stand, or table. The telephone may fall, causing serious damage to the unit.
6. Slots and openings in the cabinet and the back or bottom are provided for ventilation. To protect the product from overheating, these openings must not be blocked or covered. This product should never be placed near or over a radiator or heat register. This product should not be placed in a built-in installation unless proper ventilation is provided.
7. This product should be operated only from the type of power source indicated on the marking label. If you are not sure of the type of power supply to your home, consult your dealer or local power company.
8. Do not allow anything to rest on the power cord. Do not locate this product where the cord will be damaged by persons walking on it.
9. Do not overload wall outlets and extension cords, as this can result in the risk of fire or electrical shock.
10. Never push objects of any kind into this product through cabinet slots, as they may touch dangerous voltage points or short out parts that could result in a risk of fire or electric shock. Never spill liquid of any kind on the product.
11. To reduce the risk of electric shock, do not disassemble this product. Take it to qualified service personnel when service or repair work is required. Opening or removing covers may expose you to dangerous voltages or other risks. Incorrect reassembly can cause electric shock when the appliance is subsequently used.
12. Unplug this product from the wall outlet and refer servicing to qualified service personnel under the following conditions:
 - A. When the power supply cord is damaged or frayed.
 - B. If liquid has been spilled into the product.
 - C. If the product has been exposed to rain or water.
 - D. If the product does not operate normally when following the operating instructions. (Adjust only those controls that are covered by the operating instructions. Improper adjustment of other controls may result in damage and will often require extensive repair work by a qualified technician.)
 - E. If the product has been dropped or the cabinet has been damaged.
 - F. If the product exhibits a distinct change in performance.
13. Do not use the telephone to report a gas leak in the vicinity of the leak.

Additional Battery Safety Precautions

Caution! To reduce the risk of fire or injury to persons by the battery, read and follow these instructions:

1. Use only the appropriate type and size battery pack specified in the owner's manual.
2. Do not dispose of the battery pack in a fire. The cell may explode. Check the nickel-cadmium battery disposal package insert for disposal instructions.
3. Do not open or mutilate the battery pack. Released electrolyte is corrosive and may cause damage to the eyes or skin. It may be toxic if swallowed.
4. Exercise care in handling the battery in order not to short the battery with conducting materials such as rings, bracelets, and keys. The battery or conductor may overheat and cause burns.
5. Charge the battery pack provided with or identified for use with this product only in accordance with the instructions and limitations specified in the owner's manual provided for this product.
6. Observe proper polarity orientation between the battery pack and battery charger.

SAVE THESE INSTRUCTIONS!

Important Electrical Considerations

Unplug all electrical appliances when you know an electrical storm is approaching. Lightning can pass through your household wiring and damage any device connected to it. This phone is no exception.

Warning!

Please do not attempt to unplug any appliance during an electrical storm.

The FCC Wants You To Know

Changes or modifications to this product not expressly approved by Uniden, or operation of this product in any way other than as detailed by the owner's manual, could void your authority to operate this product. The equipment cannot be used on public coin phone service provided by the telephone company. Connection to party line service is subject to state tariffs. (Contact the state public utility commission, public service commission or corporation commission for information.)

Range

Your new phone is designed to achieve the maximum possible range by transmitting and receiving according to the highest specifications set forth by the FCC. We have rated this phone to operate at a maximum distance with the qualification that the range depends upon the environment in which the telephone is used. Many factors limit range, and it would be impossible to include all the variables in our rating. The Maximum Range rating of this phone is meant to be used as a means of comparison against other range claims.

Telephone Line Problems

The FCC has granted the telephone company the right to disconnect service in the event that your phone causes problems on the telephone line. Also, the telephone company may make changes in facilities and services which may affect the operation of your unit. However, your telephone company must give adequate notice in writing prior to such actions to allow you time for making necessary arrangements to continue uninterrupted service.

If you are having trouble with your telephone service, you must first disconnect your phone to determine if it is the cause of your problem. If you determine that it is the cause, you must leave it disconnected until the trouble has been corrected.

Radio Interference

Radio interference may occasionally cause buzzing and humming in your cordless handset, or clicking noises in the base. This interference is caused by external sources such as TV, refrigerator, vacuum cleaner, fluorescent lighting, or electrical storm. Your unit is NOT DEFECTIVE. If these noises continue and are too distracting, please check around your home to see what appliances may be causing the problem. In addition, we recommend that the base not be plugged into a circuit that also powers a major appliance because of the potential for interference. Be certain that the antenna on the unit is fully extended when needed. In the unlikely event that you consistently hear other voices or distracting transmissions on your phone, you may be receiving radio signals from another cordless telephone or other source of interference. If you cannot eliminate this type of interference, you need to change to a different channel. Finally, it should be noted that some cordless telephones operate at frequencies that may cause interference to nearby TVs and VCRs. To minimize or prevent such interference, the base of the cordless telephone should not be placed near or on top of a TV or VCR. If interference is experienced, moving the cordless telephone farther away from the TV or VCR will often reduce or eliminate the interference.

More Than One Cordless Telephone

If you want to use more than one cordless telephone in your home, they must operate on different channels. Press the channel key to select a channel that provides the clearest communication.

Cordless Telephone Privacy

Cordless telephones are radio devices. Communications between the handset and base of your cordless telephone are accomplished by means of radio waves which are broadcast over the open airways. Because of the inherent physical properties of radio waves, your communications can be received by radio receiving devices other than your own cordless telephone unit. Consequently, any communications using your cordless telephone may not be private.

Installation Considerations

Selecting a Location

Before choosing a location for your new phone, there are some important guidelines you should consider:

- The location should be close to both a phone jack and continuous power outlet. (A continuous power outlet is an AC outlet which does not have a switch to interrupt its power.)
- Keep the base and handset away from sources of electrical noise such as motors or fluorescent lighting.
- Be sure there is sufficient space to fully extend the base antenna.
- The base can be placed on a desk or tabletop or mounted on a standard telephone wall plate.
- You should charge your new phone for 15-20 hours before completing the installation or using the handset.

Telephone Line Outlets

There are two types of phone outlets:

Modular Jack

Most phone equipment available now uses modular jacks. Phone cords are fitted with a molded plastic connector which plugs into this type of jack. If you do not have modular phone jacks, contact your local telephone company for information about their installation.

Hardwired Jack

Some equipment is wired directly to a phone jack, and these types of installations require a modular jack converter. This type of installation is not difficult; however, you should contact your Uniden telephone dealer or a telephone supply store for advice about the proper adapter or converter for your particular situation.

Connecting the Telephone Cords

Consider these safety guidelines before connecting the telephone cords:

Caution!

- Never install telephone wiring during a lightning storm.
- Never touch uninsulated telephone wires or terminals unless the telephone line has been disconnected.
- Use caution when installing or modifying telephone lines.

Applying Power to the Base

This phone requires an AC outlet, without a switch to interrupt power, and the included AC adapter. To relieve strain on the DC plug when the phone is placed on a desk or table, wrap the power cord around the strain relief notch on the bottom of the base.

NOTE: Place the power cord so that it does not create a trip hazard, or where it could become chafed and create a fire or other electrical hazards.

Adapter Safety Features

If the AC adapter furnished with this phone has a polarized line plug (a plug having one blade wider than the other), this plug will fit into the power outlet only one way. If you are unable to insert the plug fully into the outlet, try reversing the plug.

Do not alter the shape of the blades of the polarized plug!

NOTE: If you cannot plug the AC adapter into the outlet, contact someone about replacing the outlet.

Plug the AC Adapter into a standard 120 VAC wall outlet.

Do not use an outlet controlled by a wall switch.



Use only the Uniden AC Adapter supplied with this phone.

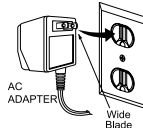

One Year Limited Warranty

Important: Evidence of original purchase is required for warranty service.

WARRANTOR: UNIDEN AMERICA CORPORATION ("Uniden")

ELEMENTS OF WARRANTY: Uniden warrants, for one year, to the original retail owner, this Uniden Product to be free from defects in materials and craftsmanship with only the limitations or exclusions set out below.

WARRANTY DURATION: This warranty to the original user shall terminate and be of no further effect 12 months after the date of original retail sale. The warranty is invalid if the Product is (A) damaged or not maintained as reasonable or necessary, (B) modified, altered, or used as part of any conversion kits, subassemblies, or any configurations not sold by Uniden, (C) improperly installed, (D) serviced or repaired by someone other than an authorized Uniden service center for a defect or malfunction covered by this warranty, (E) used in any conjunction with equipment or parts or as part of any system not manufactured by Uniden, or (F) installed or programmed by anyone other than as detailed by the owner's manual for this product.

STATEMENT OF REMEDY: In the event that the product does not conform to this warranty at any time while this warranty is in effect, warrantor will either, at its option, repair or replace the defective unit and return it to you without charge for parts, service, or any other cost (except shipping and handling) incurred by warrantor or its representatives in connection with the performance of this warranty. Warrantor, at its option, may replace the unit with a new or refurbished unit. THE LIMITED WARRANTY SET FORTH ABOVE IS THE SOLE AND ENTIRE WARRANTY PERTAINING TO THE PRODUCT AND IS IN LIEU OF AND EXCLUDES ALL OTHER WARRANTIES OF ANY NATURE WHATSOEVER, WHETHER EXPRESS, IMPLIED OR ARISING BY OPERATION OF LAW, INCLUDING, BUT NOT LIMITED TO ANY IMPLIED WARRANTIES OF MERCHANTABILITY OR FITNESS FOR A PARTICULAR PURPOSE. THIS WARRANTY DOES NOT COVER OR PROVIDE FOR THE REIMBURSEMENT OR PAYMENT OF INCIDENTAL OR CONSEQUENTIAL DAMAGES. Some states do not allow this exclusion or limitation of incidental or consequential damages so the above limitation or exclusion may not apply to you.

LEGAL REMEDIES: This warranty gives you specific legal rights, and you may also have other rights which vary from state to state. This warranty is void outside the United States of America.

PROCEDURE FOR OBTAINING PERFORMANCE OF WARRANTY: If, after following the instructions in the owner's manual you are certain that the Product is defective, pack the Product carefully (preferably in its original packaging). The Product should include all parts and accessories originally packaged with the Product. Include evidence of original purchase and a note describing the defect that has caused you to return it. The Product should be shipped freight prepaid, by traceable means, to warrantor at:

Uniden America Corporation
Parts and Service Division
4700 Amon Carter Blvd.
Fort Worth, TX 76155

(800) 297-1023, 7 a.m. to 7 p.m. Central, Monday through Friday

Index

A

Adjusting ringer and earpiece volume.....17

B

Battery pack

 Preparing and charging 7

 Replacement and handling 41

Beltclip installation 40

C

Caller ID

Caller ID service 31

 Call Waiting..... 37

 Deleting 33

 Setting Caller ID options/Language 13

 Using 35

 Viewing 32

Connection 9

D

Dialing mode 10

Digital security code..... 4,39

E, F, G

Earpiece volume 17

H, I, J, K, L

Headset installation 40

Language13

M, N, O

Maintenance 41

Making a call 15

Memory dialing

 Erasing a stored name

 and phone number 30

 Making calls with memory dialing 25

 Storing phone numbers and names 21

Mounting the base unit on a wall11

P, Q

Package contents 5

Paging 20

Precautions.....47

R

Receiving a call 15

Redialing a call 18

Ringer tone and volume 17

S

Setting up the base unit 6

Setting up the handset 7

T, U, V, W, X, Y, Z

Technical information 45

Troubleshooting 42

Warranty48

Memo

At Uniden, we'll take care of you!

If you need any assistance with this product, please call our Customer Hotline at

1-800-297-1023

PLEASE DO NOT RETURN THIS PRODUCT TO THE PLACE OF PURCHASE.

Our Uniden representatives will be happy to help you with any matters regarding the operation of this unit, available accessories, or any other related matters.

Thank you for purchasing a Uniden product.
Hours: M-F 7:00 AM to 7:00 PM CST.

Thank you for purchasing a Uniden Cordless Phone.

A World Without Wires | **Uniden**[®]

Covered under one or more of the following U.S. patents:

4,511,761	4,523,058	4,595,795	4,797,916	5,381,460	5,426,690
5,434,905	5,491,745	5,533,010	5,574,727	5,650,790	5,660,269
5,661,780	5,663,981	5,671,248	5,717,312	5,754,407	5,768,345
5,787,356	5,838,721	5,864,619	5,893,034	5,912,968	5,915,227
5,929,598	5,930,720	5,960,358	5,987,330	6,044,281	6,070,082
6,125,277					

© 2001 Uniden America Corporation, Fort Worth, TX
All rights reserved.

Printed in China
UCZZ01757ZZ

Free Manuals Download Website

<http://myh66.com>

<http://usermanuals.us>

<http://www.somanuals.com>

<http://www.4manuals.cc>

<http://www.manual-lib.com>

<http://www.404manual.com>

<http://www.luxmanual.com>

<http://aubethermostatmanual.com>

Golf course search by state

<http://golfingnear.com>

Email search by domain

<http://emailbydomain.com>

Auto manuals search

<http://auto.somanuals.com>

TV manuals search

<http://tv.somanuals.com>