

ANA 9500

Spread Spectrum Analog PBX Cordless Telephone



Operating Guide

PRECAUTIONS

Before you read anything else,
please observe the following:

WARNING!

Uniden America Corporation **DOES NOT** represent this unit to be waterproof. To reduce the risk of fire, electrical shock, or damage to the unit, **DO NOT** expose this unit to rain or moisture.

RECHARGEABLE NICKEL-CADMIUM BATTERY WARNING

- This equipment contains a Rechargeable Nickel-Cadmium Battery.
- Cadmium is a chemical known to the State of California to cause cancer.
- The Rechargeable Nickel-Cadmium Battery contained in this equipment may explode if disposed of in a fire.
- **Do not** short circuit the battery.
- **Do not** charge the Rechargeable Nickel-Cadmium Battery used in this equipment in any charger other than the one designed to charge this battery as specified in this Guide . Using another charger may damage the battery, or cause the battery to explode.

RECHARGEABLE NICKEL-CADMIUM BATTERIES MUST BE RECYCLED OR DISPOSED OF PROPERLY

- Residents Of Minnesota should contact 1-800-225-PRBA for information concerning reclamation and disposal of Rechargeable Nickel-Cadmium batteries.
- Residents outside of Minnesota should contact their local authorities for information concerning reclamation and disposal of Rechargeable Nickel-Cadmium batteries.

One Year Limited Warranty

WARRANTOR: UNIDEN AMERICA CORPORATION (“Uniden”)

ELEMENTS OF WARRANTY: Uniden warrants, for one year, to the original retail owner, this Uniden Product to be free from defects in materials and craftsmanship with only the limitations or exclusions set out below.

WARRANTY DURATION: This warranty to the original user shall terminate and be of no further effect 12 months after the date of original retail sale. The warranty is invalid if the Product is (A) damaged or not maintained as reasonable or necessary, (B) modified, altered, or used as part of any conversion kits, subassemblies, or any configurations not sold by Uniden, (C) improperly installed, (D) serviced or repaired by someone other than an authorized Uniden service center for a defect or malfunction covered by this warranty, (E) used in any conjunction with equipment or parts or as part of any system not manufactured by Uniden, or (F) installed or programmed by anyone other than as detailed by the Operating Guide for this product.

STATEMENT OF REMEDY: In the event that the product does not conform to this warranty at any time while this warranty is in effect, warrantor will repair the defect and return it to you without charge for parts, service, or any other cost (except shipping and handling) incurred by warrantor or its representatives in connection with the performance of this warranty. THE LIMITED WARRANTY SET FORTH ABOVE IS THE SOLE AND ENTIRE WARRANTY PERTAINING TO THE PRODUCT AND IS IN LIEU OF AND EXCLUDES ALL OTHER WARRANTIES OF ANY NATURE WHATSOEVER, WHETHER EXPRESS, IMPLIED OR ARISING BY OPERATION OF LAW, INCLUDING, BUT NOT LIMITED TO ANY IMPLIED WARRANTIES OF MERCHANTABILITY OR FITNESS FOR A PARTICULAR PURPOSE. THIS WARRANTY DOES NOT COVER OR PROVIDE FOR THE REIMBURSEMENT OR PAYMENT OF INCIDENTAL OR CONSEQUENTIAL DAMAGES. Some states do not allow this exclusion or limitation of incidental or consequential damages so the above limitation or exclusion may not apply to you.

LEGAL REMEDIES: This warranty gives you specific legal rights, and you may also have other rights which vary from state to state. This warranty is void outside the United States of America.

PROCEDURE FOR OBTAINING PERFORMANCE OF WARRANTY: If, after following the instructions in this Operating Guide you are certain that the Product is defective, pack the Product carefully (preferably in its original packaging). Include evidence of original purchase and a note describing the defect that has caused you to return it. The Product should be shipped freight prepaid by traceable means, or delivered, to warrantor at:

Uniden America Corporation
BCS Divison
4700 Amon Carter Blvd.
Fort Worth, TX 76155
(800) 297-1023
8 a.m. to 5 p.m. Central, Monday through Friday

Base Unit Controls & Functions

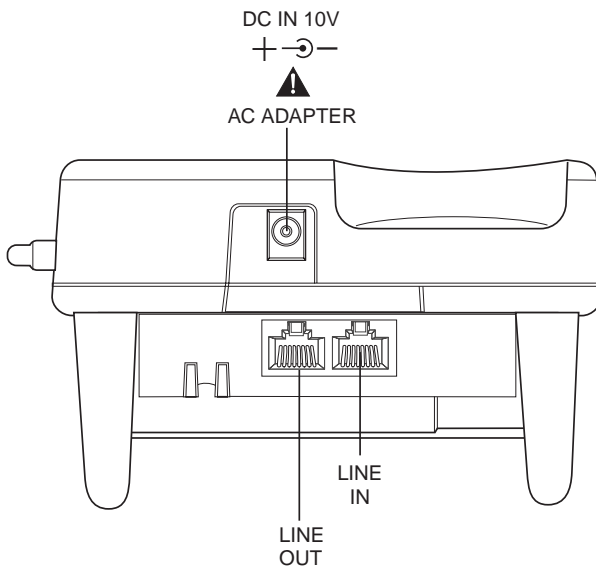
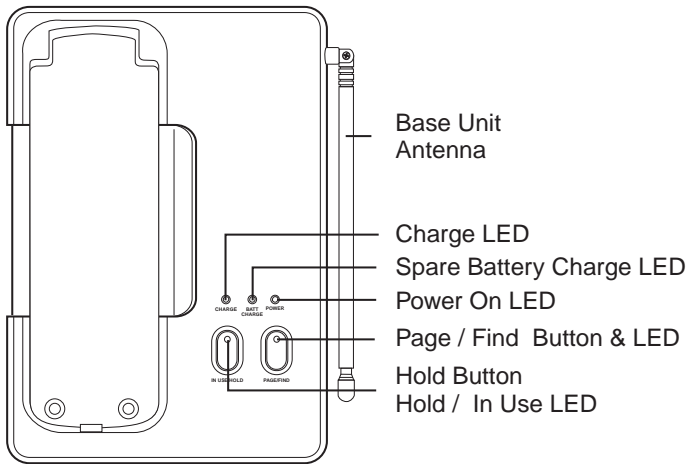

Handset Controls & Functions

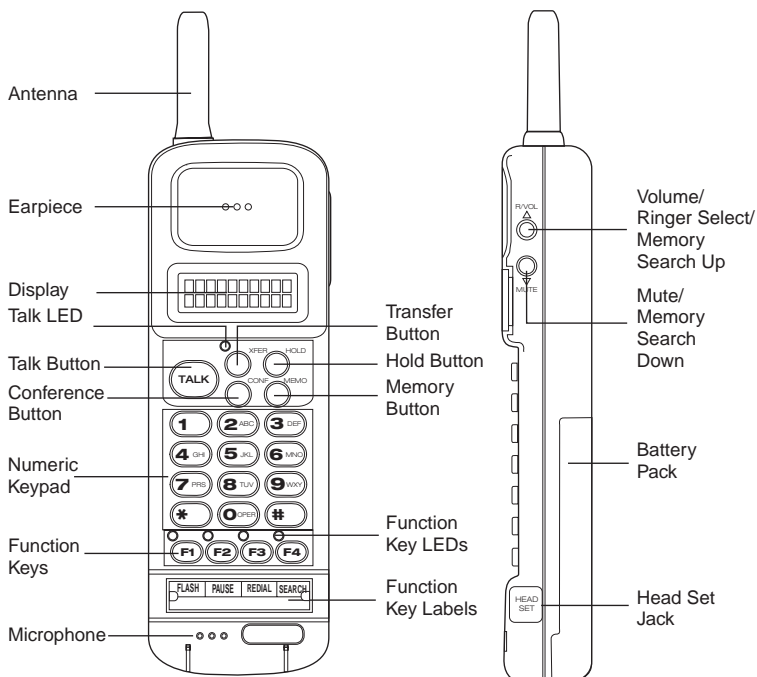

Table of Contents

Handset Controls & Functions	Inside Front Cover
Base Unit Controls & Functions	Inside Back Cover
Important Safety Instructions	2
About Your ANA 9500	4
ANA 9500 Features	5
Installing Your ANA 9500	6
Selecting the Installation Location	6
Connecting the Telephone Line	6
Connecting the Telephone Cords	7
Tone/Pulse Switch	8
Applying Power to the Base Unit	8
Attaching the Belt Clip to the Handset	10
Installing the Handset Battery Pack	10
Removing the Handset Battery Pack	11
Charging the Handset Battery Pack	11
Low Battery Indicator	12
Cleaning the Battery Contacts	13
Using Your ANA 9500 Handset	14
ANA 9500 Handset Controls	14
Using the Handset	15
Answering a Call	16
Making a Call	16
Feature Buttons	17
Placing a call "on hold"	17
Transferring a Call	17
Connecting a Conference Call	17
Programming the Feature Buttons	18
Function Keys	19
FLASH (F1)	19
PAUSE (F2)	19
REDIAL (F3)	19
SEARCH (F4)	19
Using Your ANA 9500 Memory	20
Storing a Number	20
Erasing a Stored Number	21
Dialing with a Stored Number	21
Memory Search	22
Chain Dialing	23
Using Your ANA 9500 Base Unit	24
Placing a Call On Hold	24
Paging the Handset	24
Optional Head Set (EXP9530)	25
Optional Backup AC Adapter (EXP9505)	26
Using an Optional Second 2500-type Analog Telephone.	27
Typical Applications	28
Optional Accessories and Replacement Parts	29
Trouble Shooting	30
Specifications	31

Uniden® is a registered trademark of Uniden America Corporation.
AutoStandby™ and AutoTalk are trademarks of Uniden America Corporation.
AutoStandby is a patented invention of Uniden America Corporation.

Important Safety Instructions

When using your telephone equipment, basic safety precautions should always be followed to reduce the risk of fire, electrical shock, and injury to persons, including the following:

1. Read and understand all instructions.
2. Follow all warnings and instructions marked on the product.
3. Unplug this product from the wall outlet before cleaning.
Do not use liquid cleaners or aerosol cleaners. Use a dry cloth for cleaning.
4. **Do not** use this product near water; for example, near a sink or in a wet area.
5. **Do not** place this product on an unstable cart, stand, or table. The telephone may fall, causing serious damage to the unit.
6. To protect the product from overheating, do not block or cover any slots or openings in the base Unit. This product should never be placed near or over a radiator or heat register. This product should not be placed in a built-in installation unless proper ventilation is provided.
7. This product should be operated only from the type of power source indicated on the marking label.
8. **Do not** allow anything to rest on the power cord. Do not locate this product where the cord will be damaged by persons walking on it.
9. **Do not** overload wall outlets and extension cords, as this can result in the risk of fire or electrical shock.
10. Never push objects of any kind into this product through the Base Unit slots, as they may touch dangerous voltage points or short out parts that could result in a risk of fire or electric shock. Never spill liquid of any kind on the product.
11. To reduce the risk of electric shock, do not disassemble this product. Contact qualified service personnel when some service or repair work is required. Opening or removing covers may expose you to dangerous voltages or other risks. Incorrect reassembly can cause electric shock when the appliance is subsequently used.
12. Unplug this product from the wall outlet and refer servicing to qualified service personnel under the following conditions:
 - A. When the power supply cord is damaged or frayed.
 - B. If liquid has been spilled into the product.
 - C. If the product has been exposed to rain or water.

- D. If the product does not operate normally when following the operating instructions. Adjust only those controls that are covered by the operating instructions. Improper adjustment of other controls may result in damage, and will often require extensive work by a qualified technician to restore the product to normal operation.
 - E. If the product has been dropped, or the cabinet has been damaged.
 - F. If the product exhibits a distinct change in performance.
13. **Do not** use the telephone to report a gas leak in the vicinity of the leak.

CAUTION: To reduce the risk of fire or injury to persons by the battery, read and follow these instructions:

1. Use only the appropriate type and size Battery Pack specified in this Operating Guide.
2. **Do not** dispose of the Battery Pack in a fire. The cell may explode. Check the Nickel-Cadmium Battery Disposal information at the beginning of this Guide for disposal instructions.
3. **Do not** open or mutilate the Battery Pack. Released electrolyte is corrosive and may cause damage to the eyes or skin. It may be toxic if swallowed.
4. Exercise care in handling the battery in order not to short the battery with conducting materials such as rings, bracelets, and keys. The battery or conductor may overheat and cause burns.
5. Charge the Battery Pack provided with or identified for use with this product only in accordance with the instructions and limitations specified in the instruction manual provided for this product.
6. Observe proper polarity orientation between the Battery Pack and battery charger.

SAVE THESE INSTRUCTIONS

About Your ANA 9500

Congratulations on your purchase of the Uniden **ANA 9500** Cordless Telephone. The **ANA 9500** is designed and engineered to exacting standards for reliability, long life, and outstanding performance. It is designed to work with a PBX system. To get the most from your **ANA 9500**, please read this Operating Guide thoroughly. To help familiarize you with the features of your cordless phone, refer to the Handset illustration foldout from the front cover, and the Base Unit illustration foldout from the rear cover.

Your **ANA 9500** includes the following items:

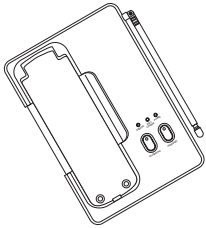

Base Unit
EXP950B



Handset
EXP950H

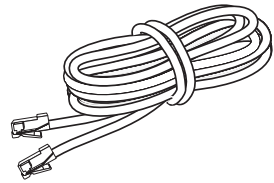

Telephone Cord

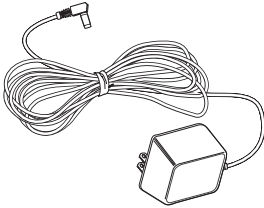

AC Adapter
EXP9504

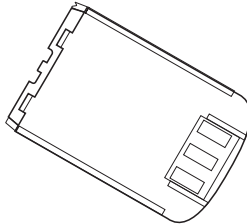

Rechargeable Battery
EXP9580

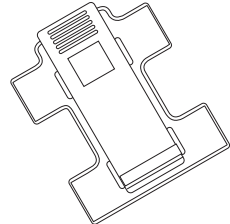

Belt Clip
EXP9502



Operating Guide
OMUNIDEXP9500

If any of these items are missing or damaged, contact your PBX Administrator. If your **ANA 9500** is not performing to your expectations, please try the simple steps listed in the Trouble Shooting Section of this Guide. If you are still unable to resolve the problem, contact your PBX Administrator.

ANA 9500 Features

- Super Long Range 900MHz Spread Spectrum
- 2-line, 10-digit LCD Display
- Headset Jack
- Ringer Volume Control
- Handset Volume Control
- Single button access to: CONFERENCE, HOLD, and TRANSFER features
- Four Function Keys: PAUSE, FLASH, REDIAL, SEARCH
- 20 Number Memory Store and Search
- Battery Charging System for Optional Standby Battery
- AutoStandby
- AutoTalk
- 2-Way Handset Mounting
- Vibrator Ringer Alert
- Easy Installation
- Compact Handset Design

Installing Your ANA 9500

Selecting the Installation Location

Select a location for the **ANA 9500** to avoid excessive heat or humidity. The Base Unit of your **ANA 9500** can be placed on a desk or tabletop near a standard 120V AC outlet and telephone line jack. The Base Unit can also be mounted on a standard AT&T or GTE wall plate using the optional Wall Mount Adapter. If you will use the **ANA 9500** with a Standard 2500 type Telephone Desk Unit, place the **ANA 9500** near that phone. Keep the Base Unit and Handset away from sources of electrical noise (motors, fluorescent lighting, computers).

Connecting the Telephone Line

There are two types of phone outlets:

1) Modular Jack

Plug the telephone line cord from the Base Unit into a standard modular telephone jack. (Note: If you do not have a modular jack, contact your local telephone company for information on the installation of these jacks.)

2) Hard-wired Jack

A modular jack converter (not included) is required. You may need to rewire when connecting the converter (making color-coded connections).

Note: Your Uniden Telephone Dealer or a telephone supply store can advise you on the proper adapter or converter.

Connecting the Telephone Cords

The **ANA 9500** must be connected to an analog PBX port or a standard analog telephone line.

CAUTION:

- Never install telephone wiring during a lightning storm.
- Never touch uninsulated telephone wires or terminals unless the telephone line has been disconnected at the network interface.
- Use caution when installing or modifying telephone lines.

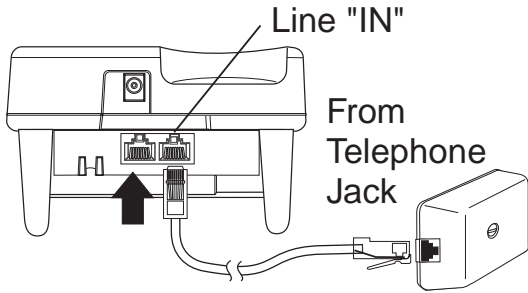

You can also connect a standard 2500-type desk phone to the **ANA 9500**:

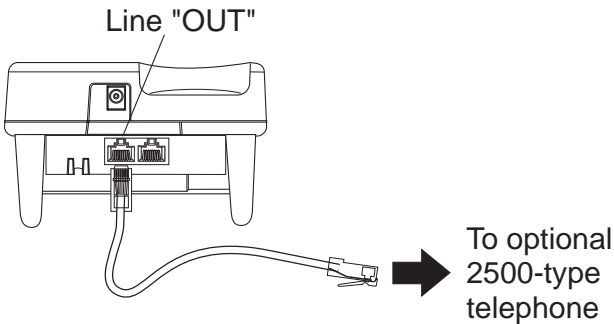

Connect to the Line OUT Jack

Tone/Pulse Switch

Be sure the TONE/PULSE switch is in the TONE position.

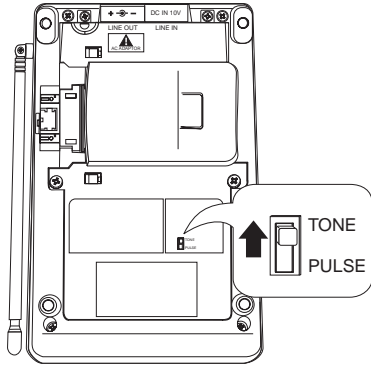

Note: Most systems are Tone dialing. Check with your PBX Administrator if you are not sure whether your system is Tone or Pulse dialing.

Applying Power to the Base Unit

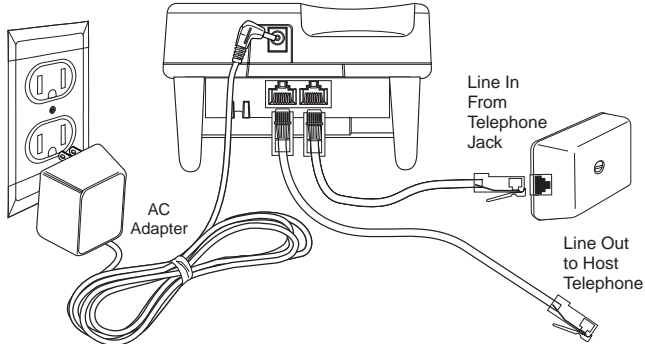

Use only the supplied AC Adapter: EXP9504

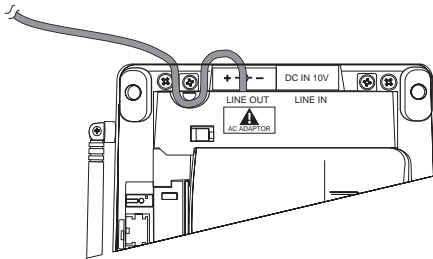

Wrap the Power Cord around the convenient notch on the bottom.

IMPORTANT! Route the power cord where it will not create a trip hazard, or where it could become chafed and create a fire or other electrical hazards.

Note: The AC Adapter furnished with this phone may be equipped with a polarized line plug (a plug having one blade wider than the other.) This plug will fit into the power outlet only one way. If you are unable to insert the plug fully into the outlet, try reversing the plug.

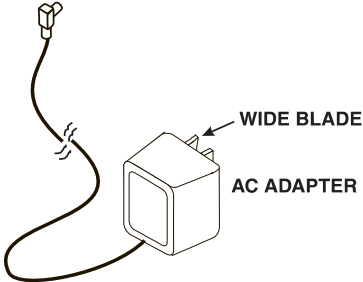

Do not alter the shape of the blades of the polarized plug.

Note: If you cannot plug the AC Adapter into the outlet, contact someone about replacing the outlet.

The unique design of your **ANA 9500** allows you to place the Handset on the Base Unit either face down or face up, with or without the Belt Clip attached. The Battery Pack in the Handset automatically recharges in either position.

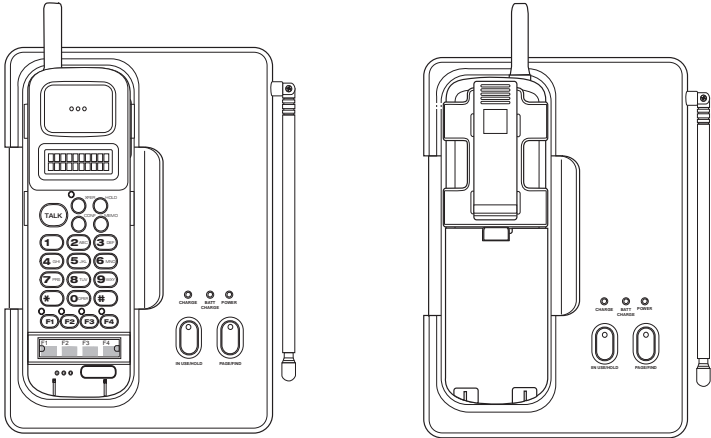

Before using your **ANA 9500**, be sure to raise the antenna to the vertical position.

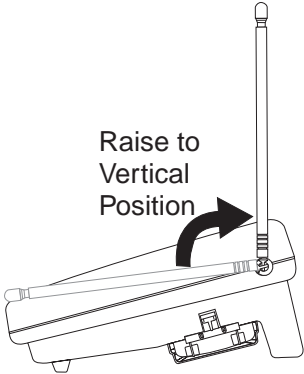

Attaching the Belt Clip to the Handset

You can use the Belt Clip to attach the Handset to your belt or pocket for convenient portability.

Snap the tabs of the Belt Clip into the notches on the sides of the Handset.

To remove the Belt Clip, pry one tab at a time from the notch on the side of the Handset. Carefully lift the Belt Clip off.

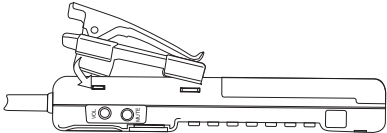

(CAUTION: The Belt Clip is designed to fit snugly onto the Handset.)

Installing the Handset Battery Pack

1. Place the Battery Pack onto the Handset so that it slides easily along the ridges.
2. Slide the Battery Pack up onto the Handset until it clicks into place.

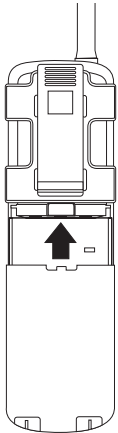

Removing the Handset Battery Pack

1. Press in on the Battery Pack Release Latch
2. Slide the Battery Pack off the Handset

*Note: You may have to pull **hard** to slide the Battery Pack off.*

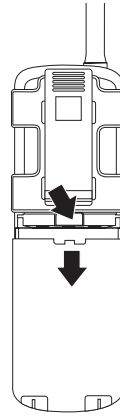

Charging the Handset Battery Pack

The Rechargeable Nickel-Cadmium Battery Pack must be fully charged before using your **ANA 9500** for the first time. (Note: Charge the Standard 400 maH Battery Pack without interruption for 6-8 hours.)

1. Place the Handset on the Base Unit.
2. Make sure the LED lights. If the LED doesn't light, check to see that the AC Adapter is plugged in, and that the Handset is making good contact with the Base Unit Charging Contacts.

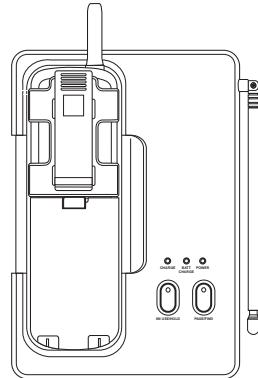

Charging Spare Battery Packs

The Base Unit of your **ANA 9500** is equipped with a Battery Charger for charging an Optional Spare Battery Pack.

1. Position the Battery Pack so the inner side is facing toward the top of the Base Unit.
2. Slide the Battery Pack into the Charging Compartment until it clicks into place.
(*Note: The Battery Pack Charging Compartment has a latch that keeps the Battery Pack in place during charging.*)

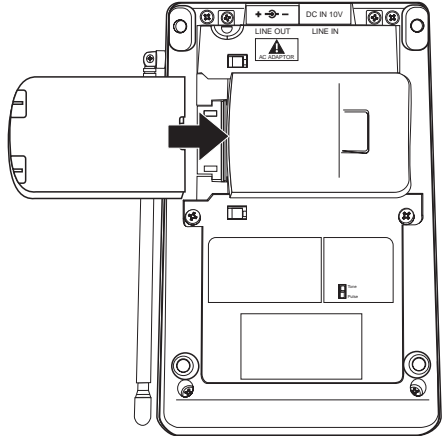

Make sure the BATTERY CHARGE LED lights. If the BATTERY CHARGE LED does not light, check to see that the AC Adapter is plugged in, and that the Battery Pack is seated into the Charging Compartment.

Note: Charge the Standard 400 maH Battery Pack without interruption for 6-8 hours. Charge the optional 730 maH maH Battery Pack without interruption for 8-10 hours.

When charging is complete, press down on the latch to remove the Battery Pack for use. Or, if you don't need the Battery pack immediately, leave it in the Charging Compartment (It will not overcharge.)

Low Battery Indicator

When the Battery Pack in the Handset is low and needs to be charged, you will see a message on the display.



On a Call	In Standby Mode
Only the TALK button operates.	None of the buttons operate.
Handset beeps once every 3 seconds	Handset beeps once.
Complete your call as quickly as possible	Cannot make call.
Replace Battery pack within 20 seconds to continue call.	Replace Battery Pack before making a call.

Return the Handset to the Base Unit for charging or replace the Handset Battery Pack with another charged Battery Pack.

Cleaning the Battery Contacts

To maintain a good charge, it is important to clean all charging contacts on the Handset and Base Unit about once a month. Use a pencil eraser or other contact cleaner. Do not use any liquids or solvents.

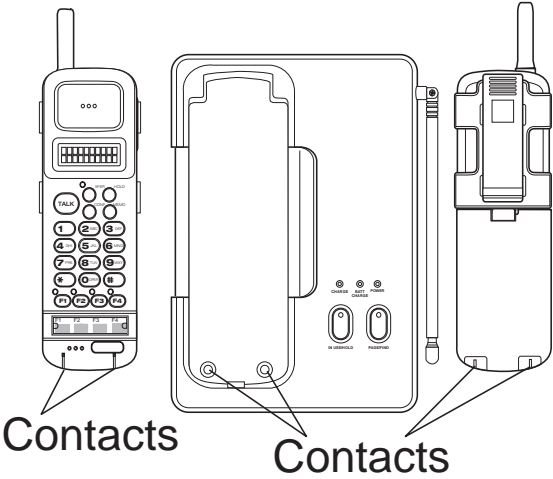

Using Your ANA 9500 Handset

Note: Operation of the **ANA 9500** is performed using the Handset off the Base Unit. The exceptions are charging the Handset Battery Pack, and terminating a call with AutoStandby. The Base Unit is used to place a call on HOLD, or to Page the Handset. These operations are discussed in the Section: "Using Your **ANA 9500** Base Unit".

ANA 9500 Handset Controls

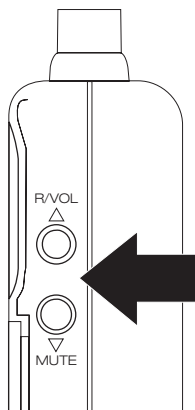

Handset Earpiece Volume (During a Call)	Ringer Select (Standby Mode)	Mute
Press VOL on the side of the Handset to select a loud or soft Earpiece volume level.	Press VOL on the side of the Handset to select from RING HIGH	RING LOW
	Note: You get a vibrator alert instead of a ring tone when you set the Ringer Volume to RING OFF.	

Using the Handset

When you pick up the Handset and press TALK, you will see:



Then you'll see one of the following:

Condition	Indicator	LCD Display
Line OK	TALK LED	
No Connection to Base Unit	Error Tone	NO SERVICE
Channel Busy	Error Tone	SYSTEM BUSY
Line in Use	Error Tone	LINE IN USE

When communication is made between the Base Unit and the Handset, the screen will go to "Standby", and the phone is ready to use.



If the Handset is at the range limit of the **ANA 9500**, you may see:



Take the following action:

	During a Call	In Standby Mode
Condition	Warning Tone	Can't make or answer calls (Phone may ring intermittently)
Action	Move back in range within 20 seconds	Move back within range.

Answering a Call

When you receive a call, the Handset rings and you'll see:



Handset on the Base Unit	Handset off the Base Unit
Pick up the Handset. The AutoTalk feature allows you to answer the call immediately.	Press TALK.
When you finish the call,, place the Handset back on the Base Unit. AutoStandby automatically hangs up the phone. —OR— Press TALK to hang up the phone.	

Making a Call

(If the Handset is on the Base Unit, pick it up.)

Press TALK. The TALK LED will light, and you'll see:



If the Line is all right, enter the number you are calling. (You can also dial from memory. See the section on "Using Memory".)



When you finish the call, place the Handset back on the Base Unit. AutoStandby automatically hangs up the phone.

-OR-

Press TALK to hang up the phone.

Feature Buttons

Note: The exact operation of the Feature Buttons depends on how your PBX system is configured. Contact your PBX Administrator for more information.

Placing a call “on hold”

Press HOLD. You’ll hear a “beep” and see:



HOLD

To resume the call, press HOLD or TALK.

Transferring a Call

Press TRANSFER. You’ll hear a “beep”, and see:



TRANSFER

Dial the target number.



3410

When the receiving party answers, press TALK to complete the transfer.

Connecting a Conference Call

To connect a second party to a call in progress, press CONFERENCE. You’ll hear a “beep”, and see:



CONFERENCE

Dial the second party’s number.



3410

When the other party answers, press CONFERENCE to have a three-way conversation.

Programming the Feature Buttons

The Feature Buttons can be programmed for special use, such as causing a “Hook Flash” followed by a special number or function.

For example — to program the TRANSFER button for “Hook Flash” and 9 for outside transfers only:

Press MEMO.



Press FLASH.



Press 9.



Press MEMO.



Press TRANSFER.



Function Keys

FLASH (F1)

Press once to cause a “Hook Flash” while on a call.

Press once to program a “Hook Flash” in a Feature Button.

The FLASH LED lights momentarily while the Key is pressed.

PAUSE (F2)

Press once to program a Pause while storing a number in Memory.

The PAUSE LED lights momentarily while the Key is pressed.

REDIAL (F3)

To dial the last number called, press TALK, then F3 (REDIAL). The phone will redial the last number called.

The REDIAL LED lights momentarily while the Key is pressed.

SEARCH (F4)

Press to begin Memory Search. (See the following Section for Memory Search.)

The SEARCH LED remains lit during the Search operation.

Using Your ANA 9500 Memory

Use these buttons to operate the **ANA 9500** Memory

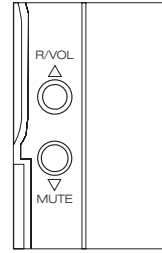

Storing a Number

1. Press MEMO. You will hear a beep, and see the message:
2. Enter the number (up to 16 digits) you want to store.
- a. To program a Pause in the dialing sequence, press.
- b. To program a "Hook Flash" in the dialing sequence, press F1.
3. Press MEMO. You will see the message:
4. Enter the number (01) -(20) for the memory location to store. You'll hear a confirmation beep and see the message:

PHONE#-

8178583300

9P
8178583300

2F5559628

MEMORY#-

STORED

Note: After pressing MEMO the second time, you have 20 seconds to enter the memory location. Otherwise, an error tone sounds and the unit returns to Standby.

5. The **ANA 9500** then returns to Standby mode.

Example: Store 555-1234 in memory location 12:

- a. Press MEMO

PHONE#-

- b. Enter 5551234

5551234

- c. Press MEMO

MEMORY#-

- d. Press 12

The Handset beeps confirmation and you see:

STORED

The phone then returns to Standby.

Erasing a Stored Number

1. Press MEMO

PHONE#-

2. Press MEMO

DELETE#-

3. Enter the memory location number (01) to (20) you want to clear. You will hear a long beep and see:

DELETED

Dialing with a Stored Number

NOTE: The following applies when the phone is in Standby Mode, and you have already established a connection between Handset and Base Unit.

1. Press TALK

2. Press MEMO

PHONE#-

3. Enter the Memory Location (01 - 20)

5551212

The phone automatically dials the number shown.

Memory Search

You can search all 20 Memory Locations to find the number you need. Once you have found the number, you can automatically dial that number.

1. Press SEARCH (F4)
2. Press ▲ (VOL) to move to Memory Location 01.
- (If Memory Location 01 doesn't have a stored number, ▲ will display the first stored number.

MEMORY
SEARCH

01>
5551212

3. a. Press ▲ (VOL) again to move to the next Memory Location.

02>
8178583300

3. b. You can also press ▼ (MUTE) to move to a previous Memory Location.

01>
5551212

3. c. If you press ▼ at Memory Location 01, you'll move directly to location 20.

20>
1234567890

4. Once you have the desired number, press TALK.

ACQUIRING
LINK

The TALK LED lights, and the SEARCH LED goes out.

The phone will then automatically dial the number.

Chain Dialing

You can dial any stored number while you are on a call. This is sometimes needed for Long Distance Access Codes or Account Access Numbers.

- 1. While you are on the call, press SEARCH (F4). The SEARCH LED lights.



- 2. Press ▲ (VOL) or ▼ (MUTE) as needed to locate the number in Memory.

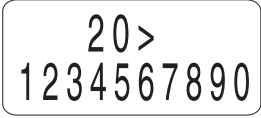

- 3. Once you have the desired number, press TALK.



The SEARCH LED goes out, and the phone dials the number.

Using Your ANA 9500 Base Unit

Although most of the **ANA 9500** operations are performed at the Handset, there are two operations performed at the Base Unit.

The IN USE/HOLD LED lights steadily whenever the Handset is connected to a call.

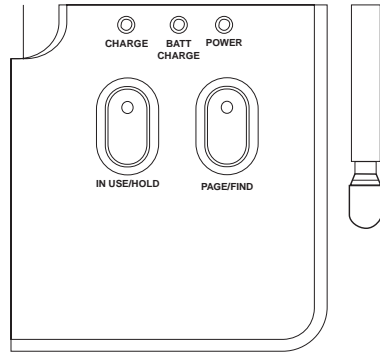

Placing a Call On Hold

1. Press HOLD on the Base Unit.

The IN USE/HOLD LED blinks, and the call is "on Hold".

2. To resume the call, press HOLD on the Base Unit, or press HOLD on the Handset twice.

The IN USE/HOLD LED lights steadily.

Paging the Handset

Press PAGE/FIND on the Base Unit to Page the Handset for a call, or to find the Handset if it is misplaced.

Optional Head Set (EXP9530)

The optional Head Set provides a “Hands-Free” Option for the **ANA 9500**. With the Head Set installed, you can use the Belt Clip to carry the Handset, and conduct a conversation using the Head Set.

To install the optional Head Set, open the cover over the HEAD SET Jack and plug the Head Set in.

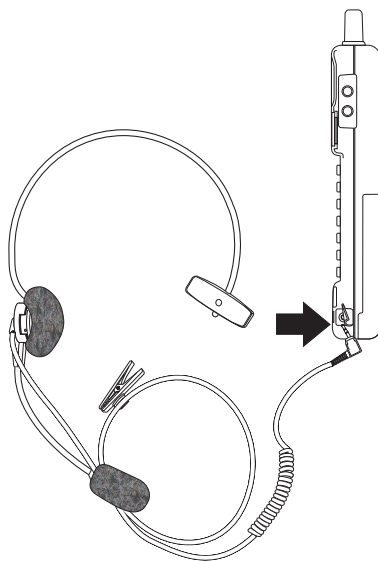

No other settings are needed.

Operation of the **ANA 9500** using the Head Set is exactly the same as using the Handset. However, you will hear through the Head Set earphone, and talk through the Head Set microphone. The Handset earphone and microphone (mouthpiece) are disconnected.

Optional Backup AC Adapter (EXP9505)

The Optional Backup AC Adapter provides protection against losing a call in case of AC Power failure. The Backup Adapter contains a Battery Pack that provides enough power for you to complete the call and hang up.

To install the Backup Adapter:

1. Disconnect the Standard AC Adapter from the Base Unit of the ANA 9500.
2. Plug the AC Adapter into the jack of the EXP9505.
3. Plug the wire from the EXP9505 into the DC IN jack of the Base Unit.

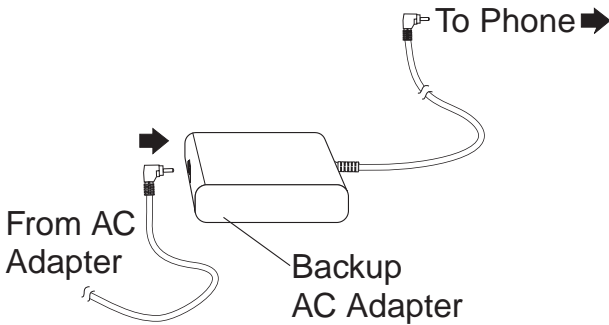

Using an Optional Second 2500-type Analog Telephone.

A standard 2500-type Desk telephone can be used with the **ANA 9500**. Calls can then be answered with the Desk phone and transferred to the **ANA 9500**.

Note: A special Security Feature disconnects the Desk phone whenever the ANA 9500 Handset is in use.

Connecting the Desk Telephone.

Connect a telephone cord from the Desk phone to the LINE OUT jack on the **ANA 9500** Base Unit.

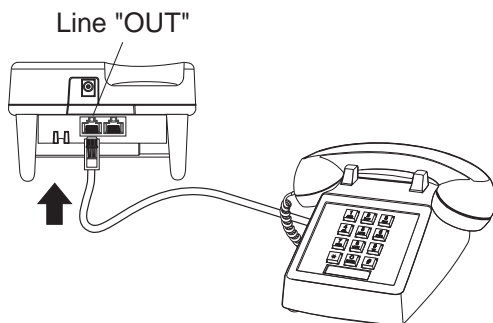

The Desk phone can now be used to answer or place calls in the normal manner.

Transferring a Call to the ANA 9500.

1. Press HOLD on the Base Unit.

The IN USE/HOLD LED blinks, and the call is "on Hold".

2. Pick up the Handset from the Base Unit.

The IN USE/HOLD LED lights steadily.

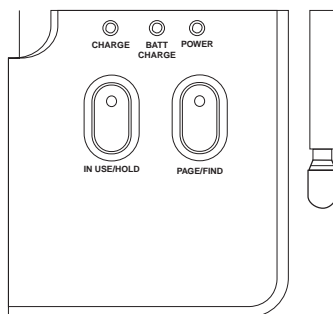

The call is now transferred to the **ANA 9500**, and the Desk phone is disconnected.

Transferring a Call to the Desk Telephone

1. Press HOLD on either the **ANA 9500** Handset or Base Unit.
2. Pick up the Handset of the Desk Phone.

You can now place the **ANA 9500** Handset on the Base Unit.

Typical Applications

You can use the **ANA 9500** together with a standard PBX telephone to give you effective business communications both at your desk and away from it. Contact your PBX Administrator for more information about your System.

You can have your PBX system programmed so the following sequence occurs:

1. Your PBX telephone rings first.
2. If you don't answer the PBX telephone after a set number of rings, the call is automatically transferred to the **ANA 9500**.
3. If you don't answer the call after a set number of rings, it is automatically transferred to your Voice Mail.

Note: It is good practice to keep the number of rings in each case to 2 or 3. This gives you a chance to answer the call, and doesn't keep the other party waiting too long.

Optional Accessories and Replacement Parts

For the following Optional Accessories and Replacement Parts contact your PBX Administrator.

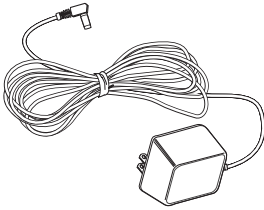

AC Adapter
EXP9504

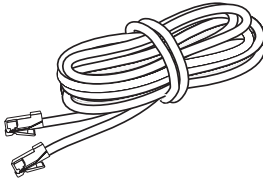

Telephone Cord

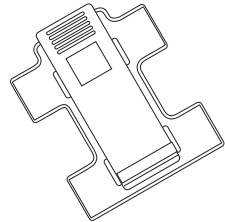

Belt Clip
EXP9502

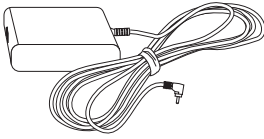

Backup AC Adapter
EXP9505

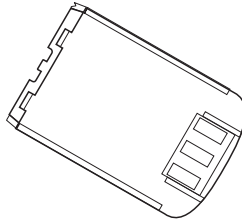

400maH Battery
EXP9580

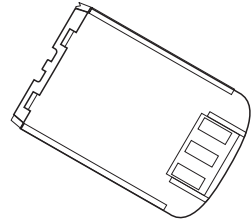

730maH Battery
EXP9586

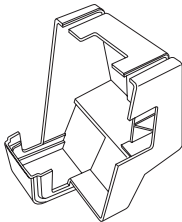

Base Unit Wall Mount
EXP9590



Head Set
EXP9530

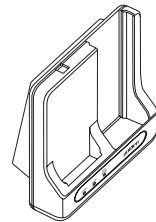

Desktop/Wallmount
Charger
EXP9585

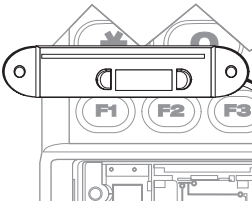

Vibrator
EXP9570

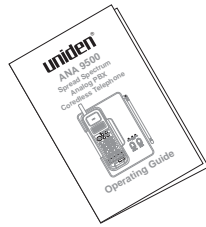

Operating Guide
OMUNIDEXP9500

Trouble Shooting

If your **ANA 9500** Cordless Telephone is not performing to your expectations, please try these simple steps. If you are still unable to resolve the problems, contact your PBX Administrator.

Note: Do not attempt to service this unit yourself. All service must be done by qualified service personnel.

Problem	Suggestion
Charge light won't come on when Handset is placed in Base Unit.	<ul style="list-style-type: none">• Make sure the AC Adapter is plugged into the Base Unit and wall outlet. • Make sure Handset is properly seated in Base Unit.• Make sure the Nickel-Cadmium Battery Pack is properly placed on the Handset.• Make sure that the charging contacts on the Handset and Base Unit are clean.
Conversation interrupted frequently.	<ul style="list-style-type: none">• Make sure that the Base Unit antenna is fully vertical.• Move closer to the Base Unit.• Check for LOW BAT warning.
Warning tone and NO SERVICE message.	<ul style="list-style-type: none">• Move closer to the Base Unit.
Handset doesn't ring.	<ul style="list-style-type: none">• Nickel-Cadmium Battery may be weak. Charge the Battery Pack for 8-10 hours.• Check the Ringer Alert setting. It may be on RING OFF without the optional Vibrator Alert installed.• Make sure the Base Unit antenna is fully vertical.• The Handset may be too far away from the Base Unit.

Specifications

General

Frequency Control	: Phase Lock Loop
Modulation	: MSK
Operating Temperature	: -10 to 50 C

Base Unit

Receive/Transmit Frequency	: 902 MHz to 928 MHz Spread Spectrum
Power Requirements	: 10V DC from supplied AC Adapter
Size	: $7\frac{3}{4}$ in. W x $\frac{7}{8}$ in. D x $3\frac{5}{32}$ in. H
Weight	: Approx. 1 lb., 5 oz.

Handset

Receive/Transmit Frequency	: 902 MHz to 928 MHz Spread Spectrum
Power Requirements	: Rechargeable Ni-Cd Battery Pack
Size	: $2\frac{1}{8}$ in. W x $\frac{7}{8}$ in. D x $6\frac{1}{2}$ in. H with antenna
Weight	: Approx. 8.6 oz. with battery
Battery	: Capacity 400 mAH, 4.8V Talk Mode 3 hours (typical) Standby Mode 42 hours (typical)

Specifications shown are typical and subject to change without notice.

Covered under one or more of the following U.S. patents:

4,511,761

4,523,058

4,595,795,

4,597,104

4,797,916

4,803,491

5,157,686

5,253,268

and other patents pending.

uniden[®]

Free Manuals Download Website

<http://myh66.com>

<http://usermanuals.us>

<http://www.somanuals.com>

<http://www.4manuals.cc>

<http://www.manual-lib.com>

<http://www.404manual.com>

<http://www.luxmanual.com>

<http://aubethermostatmanual.com>

Golf course search by state

<http://golfingnear.com>

Email search by domain

<http://emailbydomain.com>

Auto manuals search

<http://auto.somanuals.com>

TV manuals search

<http://tv.somanuals.com>